



2024  
2025

# MEASURING INSTRUMENTS

CATALOGUE NO. 107



# QUALITY | INNOVATION | SERVICE | VALUE



The products with this mark are **INSIZE PLUS** brand, otherwise the products are **INSIZE** brand.

**INSIZE** is our standard quality

**INSIZE PLUS** is our premium quality



The products with this mark are supplied with manufacturer inspection certificate.

INSIZE		Inspection Certificate					
Product name	Digital Caliper	Traceable to	USA NIST No.821/279484-10				
Code No.	1108-150		Germany DKD No.D-K-15190-01-00				
Measuring range	0-150mm / 0-6"	Inspector	<i>Jose</i>				
Resolution	0.01mm / 0.0005"	Judgement	Passed				
Serial No.	0910120004						
Standard temperature	20°C / 68°F						
			Unit: inch		Unit: mm		
Measuring Length	Permissible Error	Error		Measuring Length	Permissible Error	Error	
		External	Internal			External	Internal
0.4 DIA	+0.0005 -0.0010	/	0.0005	Φ10	+0.01 -0.02	/	0.01
2	±0.0010	-0.0005	/	50	±0.02	-0.01	/
4		-0.0005	/	100		-0.01	/
6		-0.0010	/	150		-0.02	/
8		/	/	200		/	/
10	±0.0015	/	/	250	±0.03	/	/
12		/	/	300		/	/



Please scan QR code to watch the videos of products.



How to search:

1. Search for products according to category in PRODUCT INDEX (next 6 pages)
2. Search for products in CODE NO. INDEX (page 926-932)
3. Search for products in APPLICATION INDEX OF MEASURING TOOLS (page 933-939)

We reserve the right to change or modify the design and specification of products in this catalogue without prior notice.

Copyright © INSIZE CO., LTD. All Rights Reserved.  
INSIZE is the registered trademark of INSIZE CO., LTD.



# PRODUCT INDEX

## 1 DATA OUTPUT AND SOFTWARE

PAGE 1-15

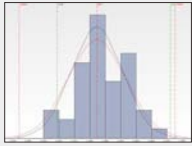

DATA MANAGEMENT SOFTWARES



DATA OUTPUT CABLES

## 3 DEPTH MEASUREMENT

PAGE 67-83

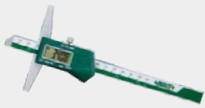

DEPTH GAGES



DEPTH GAGES



DEPTH MICROMETERS

## 4 HEIGHT MEASUREMENT

PAGE 84-92



DIGITAL HEIGHT GAGES



HEIGHT GAGES

## 6 MICROMETERS

PAGE 100-167



HIGH PRECISION DIGITAL MICROMETERS/SNAP GAGES



OUTSIDE MICROMETERS



3-WIRES



MICROMETER HEADS

## 8 ARC RADIUS MEASUREMENT

PAGE 206-213



LARGE DIAMETER GAGES



OUTSIDE DIAMETER VARIATION MEASURING INSTRUMENTS



OUTSIDE DIAMETER MEASURING INSTRUMENTS



DIGITAL RADIUS GAGES



DIGITAL ARC RADIUS CALIPERS



DIGITAL RADIUS CALIPERS

## 2 CALIPERS

PAGE 16-66

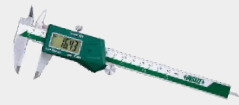

CALIPERS

## 5 COMPARISON INSTRUMENTS

PAGE 93-99



CARBON FIBER COMPARISON GAGES



COMPARISON GAGES



INTERNAL AND EXTERNAL DIAMETER COMPARISON INSTRUMENTS



OUTSIDE DIAMETER MEASURING STANDS

## 7 BORE DIAMETER, CIRCUMFERENCE MEASUREMENT

PAGE 168-205



INSIDE MICROMETERS



INSIDE MICROMETERS



THREE POINTS INTERNAL MICROMETERS



BORE PLUG GAGES



BORE GAGES



CARBON FIBER BORE GAGES



INTERNAL CHAMFER GAGES



TELESCOPING GAGE SETS



CIRCUMFERENCE TAPES

## 9 KEYWAY MEASUREMENT

PAGE 214-216



KEYWAY SYMMETRY GAGES



KEYWAY SYMMETRY DIGITAL CALIPERS



KEYWAY DEPTH GAGES

# PRODUCT INDEX

## 10 CHAMFER MEASUREMENT PAGE 217-220



DIGITAL CHAMFER GAGES



DIGITAL CHAMFER GAGES



CHAMFER HEIGHT GAGES

## 11 INDICATORS, LINEAR GAGES, DIAL INDICATOR STANDS PAGE 221-278



DIAL TEST INDICATORS



INDICATORS



LINEAR GAGES AND DISPLAY UNITS



MAGNETIC STANDS



DIAL INDICATOR STANDS (NON-MAGNETIC)



DIAL INDICATOR STANDS

## 12 INDICATING MEASURING INSTRUMENTS PAGE 279-300



INTERNAL CALIPER GAGES



EXTERNAL CALIPER GAGES



THICKNESS GAGES



RUBBER THICKNESS GAGES



TUBE THICKNESS GAGES



SAW TEETH SETTING GAGES



SNAP GAGES



STEP AND GAP GAGES



MINI DIGITAL HEIGHT GAGES



HEIGHT GAGES



CRANKSHAFT TESTERS

## 13 PETROLEUM PIPE THREAD MEASUREMENT PAGE 301-316



THREAD PITCH MEASURING INSTRUMENTS

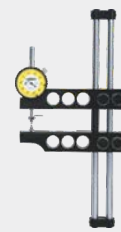

THREAD TAPER MEASURING INSTRUMENTS



THREAD HEIGHT MEASURING INSTRUMENTS



THREAD CREST DIAMETER MEASURING INSTRUMENTS



GROOVE DIAMETER MEASURING INSTRUMENTS



GROOVE WIDTH MEASURING INSTRUMENTS



THREAD GAGES FOR PETROLEUM EQUIPMENT

## 14 STANDARDS AND GAGE BLOCKS PAGE 317-374



GAGE BLOCKS



CMM CHECK MASTERS



ANGLE GAGE BLOCKS



PIN GAGES



CYLINDER GAGES



ADJUSTABLE SNAP GAGES



SETTING RINGS



PLAIN PLUG GAGES



MEASURING BALLS



THREADED HOLE LOCATION GAGES



THREAD DEPTH GAGES



THREAD RING GAGES



THREAD PLUG GAGES



SEMI-AUTOMATIC THREAD INSPECTORS

# PRODUCT INDEX

## 15 ANGLE, STRAIGHTNESS, FLATNESS MEASUREMENT PAGE 375-392



ANGLE METERS

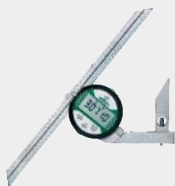

PROTRACTORS



GRANITE SQUARES



PERPENDICULARITY TESTERS



SQUARES



STRAIGHT EDGES



STRAIGHT EDGES



OPTICAL FLATS

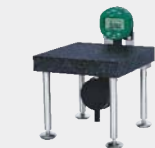

FLATNESS MEASUREMENT STANDS

## 18 SET-UP TOOLS PAGE 448-473



GRANITE SURFACE PLATES



V-BLOCKS

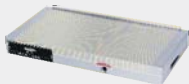

PERMANENT MAGNETIC CHUCKS



PARALLELS



PARALLEL/SQUARE SETS



ANGLE PLATE SETS



ADJUSTABLE ANGLE BLOCKS

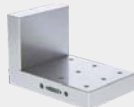

RIGHT ANGLE PLATES



SINE BARS



PRECISION VISES



STAGES

## 16 CONCENTRICITY AND RUNOUT TESTERS PAGE 393-405



CONCENTRICITY GAGES



BENCH CENTERS



SHANK RUNOUT TESTERS

## 17 SIMPLE MEASURING TOOLS PAGE 406-447



FEELER GAGES



PITCH GAGES



RADIUS GAGES



TAPER SLOT GAGES

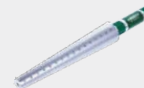

TAPER BORE GAGES



WELDING GAGES



INSIDE/OUTSIDE CALIPERS



LENGTH TAPES



MEASURING TAPES



MEASURING WHEELS



STEEL RULES



COMBINATION SQUARES



T-BEVELS



LOCATORS



SCRIBING CALIPERS



PRECISION SCREWDRIVER SETS



LED FLASHLIGHTS



MEASURING TOOL SETS

# PRODUCT INDEX

## 19 ON-MACHINE MEASUREMENT

PAGE 474-494



VIDEO MEASURING INSTRUMENT FOR MACHINE TOOLS



CENTERING INDICATORS



EDGE FINDERS



EDGE FINDERS FOR EDM



3D TESTERS



TRIGGER-TYPE 3D PROBES



INFRARED TRANSMISSION PROBES FOR CNC MACHINE TOOLS



ZERO SETTERS WITH CABLE



ZERO SETTERS



ZERO SETTERS

## 20 LEVELS

PAGE 495-508



LEVELS



CROSS-LINE LASER LEVELS



SELF-LEVELING ROTARY LASERS

## 21

PAGE 509-529



LINEAR SCALES

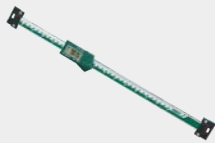

SCALES



AIR GAGES AND DISPLAYS



AIR LEAKAGE TESTERS



LASER SCAN MICROMETERS



SPECTROMETERS



TOOL PRESETTERS

## 22 FLAW DETECTORS

PAGE 530-535



DIGITAL ULTRASONIC FLAW DETECTORS



PORTABLE MAGNETIC POWDER FLAW DETECTORS



UV FLAW DETECTION LIGHTS



PENETRATION STANDARD TEST BLOCKS

## 23 CMM

PAGE 536-557



CMM



MEASURING ARMS



STYLI FOR CMM



GAGE BLOCK STANDS FOR CMM



CERAMIC BALL GAGES

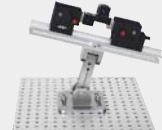

JIG SETS FOR CMM

## 24 PROFILE PROJECTORS, QUICK MEASUREMENT SYSTEMS, VISION MEASURING SYSTEMS

PAGE 558-593



PROFILE PROJECTORS



QUICK MEASUREMENT SYSTEMS



VISION MEASURING SYSTEMS

## 25 MICROSCOPES, MAGNIFIERS

PAGE 594-668



TOOLMAKER MICROSCOPES



DIGITAL MICROSCOPES



MICROSCOPES



MAGNIFIERS



TELESCOPING INSPECTION MIRRORS

# PRODUCT INDEX

## 26 VIDEOSCOPIES PAGE 669-685



VIDEOSCOPIES



RIGID BORESCOPIES

## 27 COATING INSPECTION PAGE 686-702



COATING THICKNESS GAGES



SURFACE PROFILE GAGES



WET FILM GAGES



HOLIDAY DETECTORS



GLOSS METERS



COLORIMETERS



PENCIL HARDNESS TESTERS



CROSS CUT ADHESION TESTERS



DIGITAL ADHESION TESTERS



ROTATIONAL ABRASION TESTERS



PAINT FILM FLEXIBILITY TESTERS



IMPACT TESTERS

## 29 ELECTRONIC TESTING PAGE 737-745



DC RESISTANCE TESTERS



DC POWER SUPPLIES



DIGITAL MULTIMETERS



DIGITAL AC/DC CLAMP METERS



VOLTAGE TESTERS

## 28 PORTABLE INSTRUMENTS PAGE 703-736



ELECTROMAGNETIC ULTRASONIC THICKNESS GAGES



ULTRASONIC THICKNESS GAGES



TACHOMETERS



STROBOSCOPES



VIBRATION METERS



LASER DISTANCE METERS



PORTABLE CONDUCTIVITY/TDS METERS



PORTABLE pH METERS



REFRACTOMETERS



DIGITAL STOPWATCHES



STROKE COUNTERS



DIGITAL MOISTURE METERS



DIFFERENTIAL PRESSURE MANOMETERS



ANEMOMETERS



BOURDON TUBE PRESSURE GAGES



SOUND LEVEL METERS



LIGHT METERS



UV LIGHT METERS



GAS DETECTORS



TESLAMETERS



LASER BELT TENSION METERS



LIGHT TRANSMITTANCE METERS



DIGITAL GLASS THICKNESS METERS

# PRODUCT INDEX

## 30 TEMPERATURE AND HUMIDITY MEASUREMENT PAGE 746-757



INFRARED THERMAL IMAGING CAMERAS



INFRARED THERMOMETERS



THERMOHYGROMETERS

## 31 ROUNDNESS, PROFILE AND ROUGHNESS TESTERS PAGE 758-786



ROUNDNESS MEASURING MACHINES



PRECISION AIR FLOATING ROTARY TABLES



SURFACE PROFILE MEASURING MACHINES



ROUGHNESS TESTERS



SURFACE ROUGHNESS SPECIMENS

## 32 HARDNESS TESTERS PAGE 787-842



HARDNESS TESTERS



CONCRETE STRENGTH TESTERS

## 35 TORQUE TESTERS TORQUE WRENCHES PAGE 879-903



TORQUE TESTERS



TORQUE SCREWDRIVERS



TORQUE WRENCHES



TORQUE ADAPTERS



TORQUE MULTIPLIERS

## 33 METALLOGRAPHY PREPARATION PAGE 843-857



CUTTING MACHINES



GRINDERS AND POLISHERS



MOUNTING PRESSES

## 34 TESTING MACHINES, FORCE GAGES PAGE 858-878

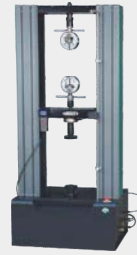

UNIVERSAL TESTING MACHINES



IMPACT TESTING MACHINES



DIGITAL SPRING TESTERS



FORCE GAGES



DIAL TENSION GAGES



SPINDLE TENSION METERS

## 36 SCALES PAGE 904-920



SCALES



WEIGHTS

## 37 SALT SPRAY TESTERS, TEMPERATURE AND HUMIDITY CHAMBERS PAGE 921-925



SALT SPRAY TESTERS



TEMPERATURE AND HUMIDITY CHAMBERS



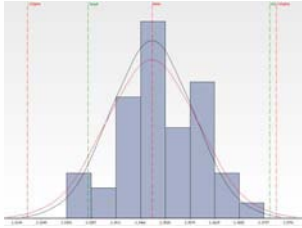

**Data Management Softwares**  
Page 2-3



**Wireless Data Transmission Systems**  
Page 4-7



**Data Output Cables**  
Page 8-15

# MEASUREMENT DATA MANAGEMENT AND ANALYSIS SOFTWARE CODE 7317

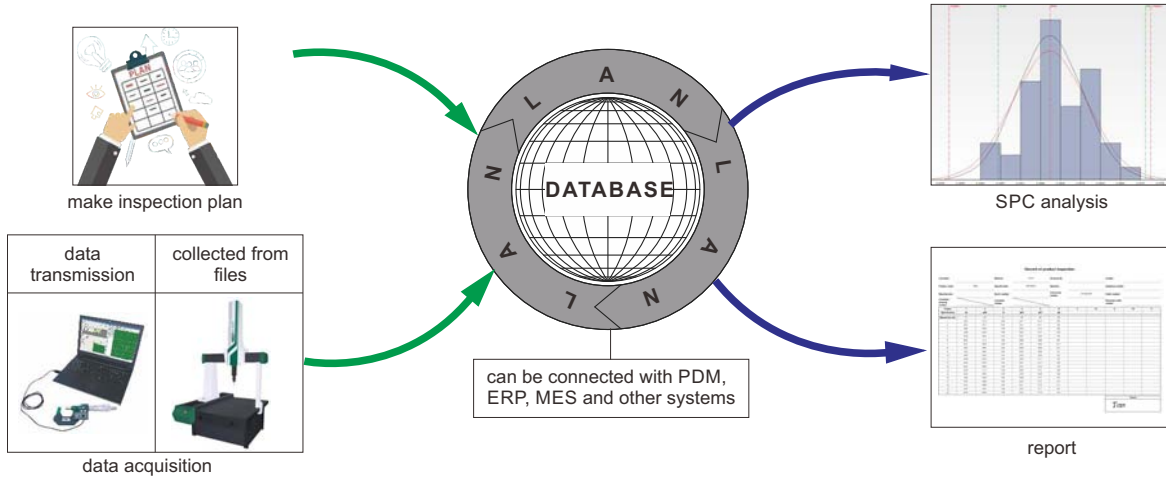

## Make inspection plan

- Define the dimensions, tolerances, control range and other parameters of workpieces

define the drawing of workpieces

Seq	Data Member Code	Data Member Name	Measuring Tool	1	2	3	4	5	6
1	DC04070001	Check type		2022-06-08 11:16:27	2022-06-08 11:16:27	2022-06-08 11:16:27	2022-06-08 11:16:27	2022-06-08 11:16:27	2022-06-08 11:16:27
2	DC04070002	Serial number							
3	DC04070003	Furnace No.							
4	DC02070001	Flatness0.008	CHH						
5	DC02070002	2.39+0.01/-0.03	Vernier caliper						
6	DC02070003	Verticality0.008	CHH						
7	DC02070004	2.335±0.004	Vernier caliper						
8	DC02070005	Outside diameterΦ=45±0.002	Micrometer						
9	DC02070006	Inner diameterΦ=45±0.002	Micrometer						
10	DC02070007	Wall thickness							

define association items of data

define the measured dimension and tolerance

## Data acquisition



manual input

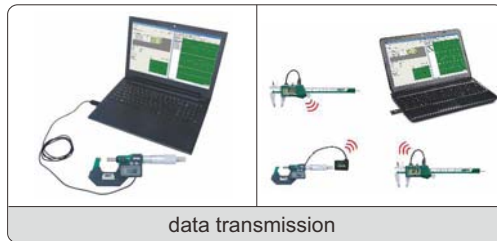

data transmission



collected from files



screen capture

Seq	Data Member Code	Data Member Name	Measuring Tool	1	2	3	4	5	6
1	DC04070001	Check type		2022-06-08 10:58:07	2022-06-08 10:58:07	2022-06-08 10:58:08	2022-06-08 11:05:40	2022-06-08 11:05:40	2022-06-08 11:05:40
2	DC04070002	Serial number		20220608001	20220608001	20220608001	20220608002	20220608002	2022
3	DC04070003	Furnace No.		P00120	P00120	P00120	P00120	P00120	P00120
4	DC02070001	Flatness0.008	CHH	0.0080	0.0080	0.0080	0.0082	0.0082	0.0082
5	DC02070002	2.39+0.01/-0.03	Vernier caliper	2.391	2.391	2.391	2.410	2.410	2.410
6	DC02070003	Verticality0.008	CHH	0.0090	0.0090	0.0090	0.0090	0.0090	0.0090
7	DC02070004	2.335±0.004	Vernier caliper	2.3350	2.3350	2.3350	2.3350	2.3350	2.3350
8	DC02070005	Outside diameterΦ=45±0.002	Micrometer	45.0030	45.0030	45.0030	44.9971	44.9971	44.9971
9	DC02070006	Inner diameterΦ=45±0.002	Micrometer	45.0010	45.0010	45.0010	45.0010	45.0010	45.0010
10	DC02070007	Wall thickness		0.0010	0.0020	0.0010	-0.0033	-0.0033	-0.0033

measurement interface

To be continued

Continued from previous page

### SPC

- Provide variety of quality analysis control charts

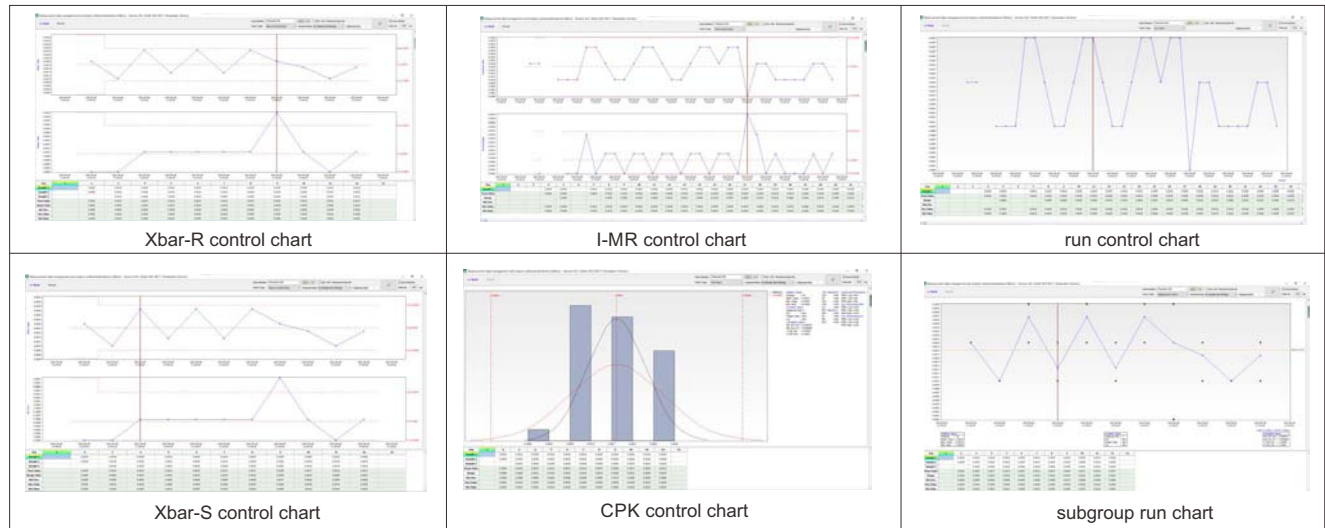

### Report

The figure illustrates the report generation process:

- report template:** A Microsoft Excel spreadsheet with a header section for 'Record of product inspection' containing fields for Customer, Material, Drawing No., and Quantity. Below this is a table with columns for 'Project', 'Specification', and 'Inspection'.
- generate report:** The same report rendered as a PDF document. It includes a signature box at the bottom right with the name 'Tom' and a 'Check' button. A red arrow points from the signature box to the text 'support exporting electronic signature'.

### Management of inspection plan

The figure shows three different ways to manage an inspection plan:

- management by customers:** A table listing inspection items. The 'Structure Tree' on the left shows a hierarchy: INSIZE > TCL > Workpiece A > MIDEA > Workpiece A > Workpiece C > MI.

Seq	Manag...	List Item Code	List Item Name	Creation User	Creation Time
1	Sleeve	001	Drawing A	Administrator	2022-06-07 09:45:24
2	Sleeve	002	Drawing B	Administrator	2022-06-07 14:50:44
3	Sleeve	003	Drawing C	Administrator	2022-06-07 14:50:49
4	Sleeve	004	Drawing A	Administrator	2022-06-07 14:50:52
5	Sleeve	005	Drawing A	Administrator	2022-06-07 14:50:55
6	Sleeve	006	Drawing B	Administrator	2022-06-07 14:51:29
7	Sleeve	007	Drawing B	Administrator	2022-06-07 14:50:29

- management by drawings:** A tree view showing a hierarchy: INSIZE.COM > Drawing > A0103 > A010301, A010302 > A0104 > A0104011, A0104014 > B2467 > B246798.
- management by departments:** A tree view showing a hierarchy: INSIZE.CN > Production department > Production area 1 > Workpiece C > Production area 2 > Workpiece D > Production area 3.

## 1 WIRELESS DATA TRANSMISSION SYSTEM

- Through wireless transmission, the measurement data can be transmitted to computers or mobile phones
- Wireless zigbee protocol, conforming to IEEE802, 2.4GHz band
- Transmission distance is 15 meter (under the condition of no obstruction and no electromagnetic interference)

### Transmitter

- Connecting to digital measuring tools such as calipers, micrometers and indicators
- CR2032 battery

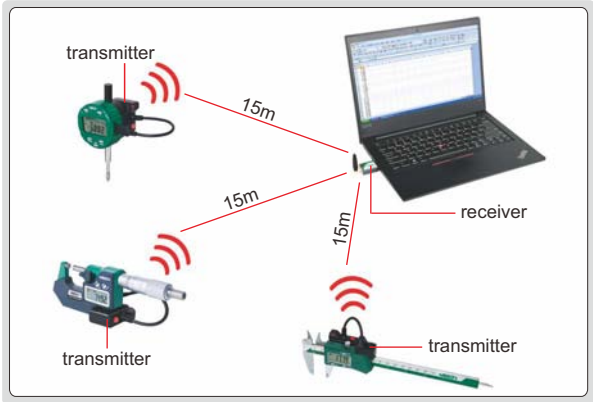

Code	Description	Transmitter	Connecting with measuring tool	Transmit data
7315-21	transmitter for digital calipers			<ul style="list-style-type: none"> <li>Press the transmit button on the plug of cable, can also press the transmit button of the transmitter</li> <li>Data is transmitted once, the signal light of the transmitter flashes once</li> </ul>
7315-22	transmitter for large digital calipers			<ul style="list-style-type: none"> <li>Press the transmit button of the transmitter</li> <li>Data is transmitted once, the signal light of the transmitter flashes once</li> </ul>
7315-30	transmitter for digital micrometers			<ul style="list-style-type: none"> <li>Press the "data" button of digital micrometer, can also press the transmit button of the transmitter</li> <li>Data is transmitted once, the signal light of the transmitter flashes once, at the same time, the signal light on the digital micrometer flashes once</li> </ul>
7315-31	transmitter for digital micrometers			<ul style="list-style-type: none"> <li>Press the "data" button of digital micrometer</li> <li>Data is transmitted once, the signal light on the digital micrometer flashes once</li> </ul>









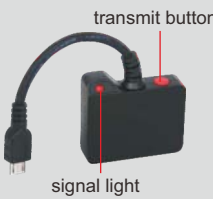

To be continued

Continued from previous page

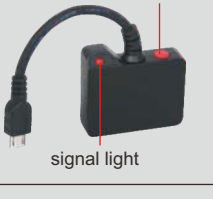
Code	Description	Transmitter	Connecting with measuring tool	Transmit data
7315-50M	transmitter for digital indicators	<p>transmit button</p> <p>signal light</p>	<p>signal light</p> <p>"DATA" button</p> <p>transmit button</p> <p>signal light</p> <p>for 2108, 2138, 2139 series digital indicators</p>	<ul style="list-style-type: none"> <li>Press the "DATA" button of digital indicator, can also press the transmit button of the transmitter</li> <li>Data is transmitted once, the signal light of the transmitter flashes once, at the same time, the signal light on digital indicator flashes once</li> </ul>
			<p>signal light</p> <p>transmit button</p> <p>signal light</p> <p>for other digital indicators</p>	<ul style="list-style-type: none"> <li>Press the transmit button of the transmitter</li> <li>Data is transmitted once, the signal light of the transmitter flashes once</li> </ul>
7315-51	transmitter for digital indicators		<p>"DATA" button</p> <p>signal light</p> <p>for 2108, 2138, 2139 series digital indicators</p> <p>back</p> <p>foot switch (code 7304-7, optional)</p>	<ul style="list-style-type: none"> <li>Press the "DATA" button of digital indicator, can also press the foot switch (code 7304-7, optional)</li> <li>Data is transmitted once, the signal light on digital indicator flashes once</li> </ul>
7315-60	transmitter for high precision digital indicators	<p>transmit button</p> <p>signal light</p>	<p>signal light</p> <p>transmit button</p>	<ul style="list-style-type: none"> <li>Press the transmit button of the transmitter</li> <li>Data is transmitted once, the signal light of the transmitter flashes once</li> </ul>
7315-80	transmitter for digital calipers/micrometers	<p>transmit button</p> <p>signal light</p>	<p>"SET" button</p> <p>transmit button</p>	<ul style="list-style-type: none"> <li>Press the "SET" button of the calipers/micrometers, can also press the transmit button of the transmitter</li> <li>Data is transmitted once, the signal light of the transmitter flashes once</li> </ul>

To be continued

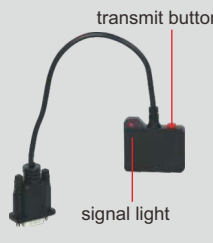
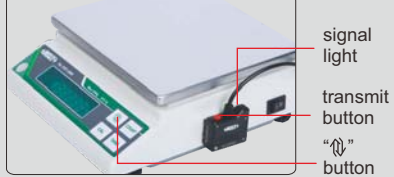
Continued from previous page

Code	Description	Transmitter	Connecting with measuring tool	Transmit data
7315-3350	transmitter for digital micrometers			<ul style="list-style-type: none"> <li>Press the transmit button of the transmitter</li> <li>Data is transmitted once, the signal light of the transmitter flashes once</li> </ul>
7315-1150	transmitter for digital height gages			<ul style="list-style-type: none"> <li>Press the transmit button of the transmitter</li> <li>Data is transmitted once, the signal light of the transmitter flashes once</li> </ul>
7315-1151	transmitter for digital height gages			<ul style="list-style-type: none"> <li>Press the transmit button of the transmitter</li> <li>Data is transmitted once, the signal light of the transmitter flashes once</li> </ul>
7315-2771	transmitter for digital protractor			<ul style="list-style-type: none"> <li>Press the transmit button of the transmitter</li> <li>Data is transmitted once, the signal light of the transmitter flashes once</li> </ul>
7315-8301	transmitter for electronic balances		 	<ul style="list-style-type: none"> <li>Press the “⏏” transmit button of the electronic balances, can also press the transmit button of the transmitter</li> <li>Data is transmitted once, the signal light of the transmitter flashes once</li> </ul>





### Receiver (keyboard signal)

- For computers and mobile phones
- Recognized as HID keyboard device, the transmitted data is recognized by computers or mobile phones as keyboard input data and press enter, such as 12.34.
- No need to install drivers and softwares
- Data can be transmitted to excel, word, txt etc.
- For any softwares which can receive keyboard signal

Code	Product	Description	Remark
7315-3	 USB port	single channel receiver	connected with 1 transmitter only

To be continued

Continued from previous page

Code	Product	Description	Remark
7315-6		multichannel receiver	connected with 6 transmitters, each channel has status indicator
7315-7			
7315-8			
7315-9			

### Receiver (text format, virtual com port)

- For computers with windows system
- Text format virtual com port, converted to keyboard format with supplied software
- Supplied with Excel directional input software
- Measurement data can be transmitted to excel, word, txt etc. and any software which receives keyboard signal

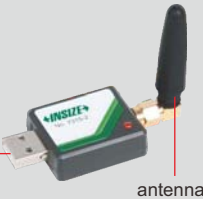
Code	Product	Description	Remark
7315-2		multichannel receiver	connected with maximum 16 transmitters, each of them has unique identification code

### Excel directional input software

- Supplied with 7315-2 receiver
- The measurement data of multiple measuring tools can be transmitted to the designated area of excel, which facilitates data management and improves efficiency

Excel directional input software (included in 7315-2), application example 1

Set the display area of caliper at B4-B9, the readings of caliper are displayed at B4, B5...B9.  
 Set the display area of micrometer at C4-C9, the readings of micrometer are displayed at C4, C5... C9.  
 Set the display area of height gage at D4-D9, the readings of height gage are displayed at D4, D5... D9.

	A	B	C	D
1	Project	Length	Width	Height
2	Dimension and Tolerance	50±0.05	24±0.01	10+0.05/-0.06
3	Measuring tool	Caliper	Micrometer	Height gage
4	1	50.02	24.004	9.98
5	2	50.01	24.010	10.01
6	3	49.99	23.990	10.02
7	4	50.00	23.996	9.99
8	5	50.04	24.000	10.01
9	6	Channel 1	Channel 2	Channel 3

serial of workpieces      the next data display area is indicated in green

Excel directional input software (included in 7315-2), application example 2

Set the display area of micrometer at B4-C9, data input is from the left to the right, the readings of micrometer are displayed at B4, C4, B5, C5... B9, C9.  
 Set the display area of caliper at D4-D9, the readings of caliper are displayed at D4, D5... D9.  
 Set the display area of depth gage at E4-E9, the readings of depth gage are displayed at E4, E5... E9.

	A	B	C	D	E
1	Project	External diameter1	External diameter2	Length	Depth
2	Dimension and Tolerance	Φ23+0.01/-0.02	Φ21+0.01/-0.02	50±0.04	28±0.05
3	Measuring tool	Micrometer	Micrometer	Caliper	Depth gage
4	1	23.010	21.008	49.98	28.01
5	2	23.010	21.000	49.98	27.98
6	3	22.999	21.000	50	28
7	4	23.007	20.998	50	28
8	5	23.000	20.985	50.01	28.01
9	6	23.008	Channel 1	Channel 2	Channel 3

serial of workpieces      the next data display area is indicated in green

# DATA OUTPUT CABLES (TEXT FORMAT, VIRTUAL COM PORT)

## 1) Data output cables with transmit box

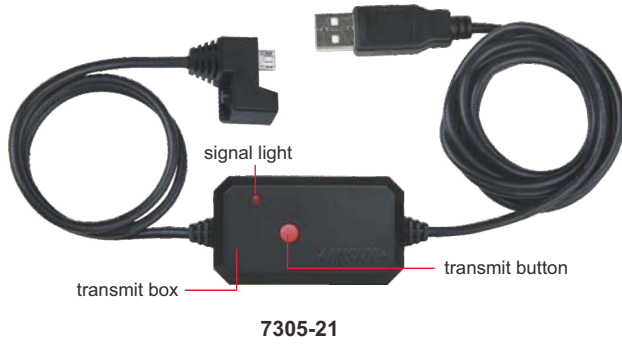

application

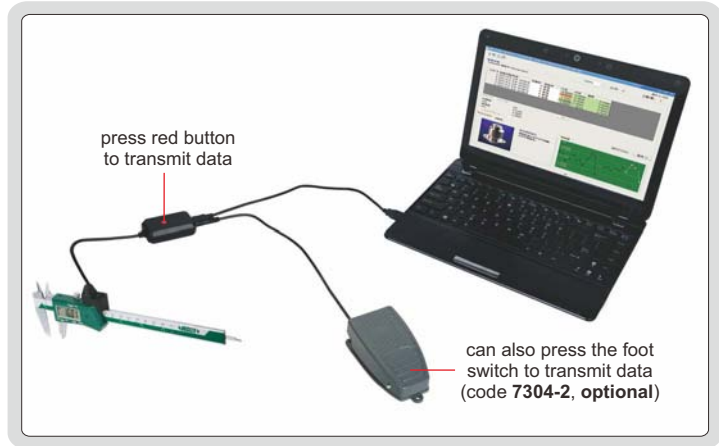









Single transmit (can be switched to continuous transmit)

Code	Description	Plug to measuring tool	Plug to computer	Connecting with measuring tool	Transmit data
7305-21	cable for digital calipers (length 3m)				<ul style="list-style-type: none"> <li>Press the transmit button on the plug of cable, can also press the transmit button of the transmit box, or press the foot switch</li> <li>Data is transmitted once, the signal light of the transmit box flashes once</li> </ul>
7305-R21					
7305-22	cable for large digital calipers (length 2.5m)				<ul style="list-style-type: none"> <li>Press the transmit button of the transmit box, or press the foot switch</li> <li>Data is transmitted once, the signal light of the transmit box flashes once</li> </ul>
7305-R22					
7305-30	cable for digital micrometers (length 2.5m)				<ul style="list-style-type: none"> <li>Press the "data" button of digital micrometer, can also press the transmit button of the transmit box, or press the foot switch</li> <li>Data is transmitted once, the signal light of the transmit box flashes once, at the same time, the signal light on the digital micrometer flashes once</li> </ul>
7305-R30					
7305-31	cable for digital micrometers (length 2.5m)				<ul style="list-style-type: none"> <li>Press the "data" button of digital micrometer, can also press the transmit button of the transmit box, or press the foot switch</li> <li>Data is transmitted once, the signal light of the transmit box flashes once, at the same time, the signal light on the digital micrometer flashes once</li> </ul>
7305-R31					

To be continued





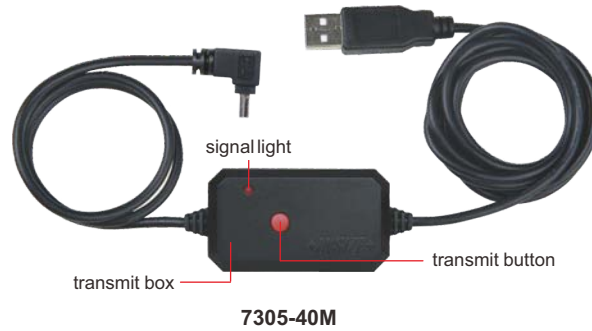

Continued from previous page

Code	Description	Plug to measuring tool	Plug to computer	Connecting with measuring tool	Transmit data
7305-50M	cable for digital gages (length 2.5m)				<ul style="list-style-type: none"> <li>Press the transmit button of the transmit box, or press the foot switch</li> <li>Data is transmitted once, the signal light of the transmit box flashes once</li> </ul>
7305-R50M					
7305-1150	cable for digital height gages (length 2.5m)				<ul style="list-style-type: none"> <li>Press the transmit button of the transmit box, or press the foot switch</li> <li>Data is transmitted once, the signal light of the transmit box flashes once</li> </ul>
7305-R1150					







**Continuous transmit (can be switched to single transmit)**

Code	Description	Plug to measuring tool	Plug to computer	Connecting with measuring tool	Transmit data
7305-40M	cable for digital indicators (length 2.5m)			 <p>for 2108, 2138, 2139 series digital indicators</p>	<p>Continuous transmit is controlled in software</p> <p>Single transmit:</p> <ul style="list-style-type: none"> <li>Press the "DATA" button of digital indicator, can also press the transmit button of the transmit box, or press the foot switch</li> <li>Data is transmitted once, the signal light of the transmit box flashes once, at the same time, the signal light on digital indicator flashes once</li> </ul> <p>Note: long press transmit button to zero the digital indicators; software of data transmit is included</p>
				 <p>for other digital indicators</p>	<p>Continuous transmit is controlled in software</p> <p>Single transmit:</p> <ul style="list-style-type: none"> <li>Press the transmit button of the transmit box, or press the foot switch</li> <li>Data is transmitted once, the signal light of the transmit box flashes once</li> </ul> <p>Note: long press transmit button to zero the digital indicators; software of data transmit is included</p>

To be continued

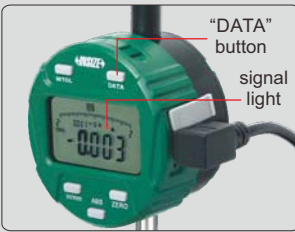
Continued from previous page

Code	Description	Plug to measuring tool	Plug to computer	Connecting with measuring tool	Transmit data
7305-R40M	cable for digital indicators (length 2.5m)			 <p>for 2108, 2138, 2139 series digital indicators</p>	<p>Continuous transmit is controlled in software</p> <p>Single transmit:</p> <ul style="list-style-type: none"> <li>Press the "DATA" button of digital indicator, can also press the transmit button of the transmit box, or press the foot switch</li> <li>Data is transmitted once, the signal light of the transmit box flashes once, at the same time, the signal light on digital indicator flashes once</li> </ul> <p>Note: long press transmit button to zero the digital indicators; software of data transmit is included</p>
				 <p>for other digital indicators</p>	<p>Continuous transmit is controlled in software</p> <p>Single transmit:</p> <ul style="list-style-type: none"> <li>Press the transmit button of the transmit box, or press the foot switch</li> <li>Data is transmitted once, the signal light of the transmit box flashes once</li> </ul> <p>Note: long press transmit button to zero the digital indicators; software of data transmit is included</p>

### Software (included in 7305-40M and 7305-R40M)

- Real-time display
- Tolerance setting, automatic judgment, out-of-tolerance alarm
- Real time statistics: max, min, average, Go/No-Go number
- Can save results as Excel



The screenshot shows the software interface with several key areas highlighted:

- export Excel:** Points to the 'Save' button in the top menu.
- real-time display:** Points to the large digital display showing '12.000 mm'.
- setting zero of digital indicators:** Points to the 'Zero' button below the display.
- measurement results and judgment:** Points to the 'Data collection' table.
- setting tolerance and sampling period:** Points to the 'Parameters' section.

No	Value	Error	Result	Time
000001	11.756	-0.244	OK	2020-10-12 09:28:46
000002	11.730	-0.270	OK	2020-10-12 09:28:47
000003	10.940	-1.060	NG	2020-10-12 09:28:48
000004	10.120	-1.880	NG	2020-10-12 09:28:50
000005	12.000	0.000	OK	2020-10-12 09:28:52
000006	12.000	0.000	OK	2020-10-12 09:28:53
000007	11.490	-0.510	OK	2020-10-12 09:28:54
000008	10.784	-1.216	NG	2020-10-12 09:28:55
000009	10.030	-1.970	NG	2020-10-12 09:28:56
000010	10.600	-1.400	NG	2020-10-12 09:28:58

To be continued

Continued from previous page

communication protocol

- Baud: 9600bps  
Data bit: 8  
Stop bit 1  
Check bit: None  
No flow control

▪ Data output format

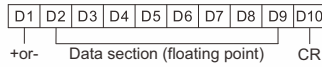

Display	Output
1.234	➔ +0001.234 ✓
-1.234	➔ -0001.234 ✓

▪ Data output format with ID number



Display	Output
1.234	➔ 4109210605 +0001.234 ✓
-1.234	➔ 4109210605 -0001.234 ✓

- The data transmission mode can be switched: single or continuous;  
The data output format can be switched: with ID number or without ID number;  
Data of digital indicators can be transmitted by instruction;  
The digital indicators can be zeroed by instruction

▪ Pin definition of RS232C plug:

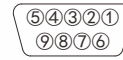

Pin No.	Symbol	Description
2	TXD	Data OUT
3	RXD	Data IN
4	VDD	+5V Power
5	GND	Ground

## 2) Data output cables without transmit box

application



7305-G3350



### Single transmit

Code	Description	Plug to measuring tool	Plug to computer	Connecting with measuring tool	Transmit data
7305-G60	cable for high precision digital indicators (length 3m)				<ul style="list-style-type: none"> <li>▪ Press the "DATA" button of high precision digital indicator</li> </ul>
7305-G3350	cable for digital micrometers (length 3m)				<ul style="list-style-type: none"> <li>▪ Press the "DATA" button of digital micrometer</li> </ul>

communication protocol

- Baud: 9600bps  
Data bit: 8  
Stop bit 1  
Check bit: None  
No flow control

▪ Data output format

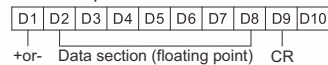

Display	Output
1.234	➔ +0001.234 ✓
-1.234	➔ -0001.234 ✓

- Data of high precision digital indicators can be transmitted by instruction;  
The high precision digital indicators can be zeroed by instruction

## DATA OUTPUT CABLES (KEYBOARD FORMAT)

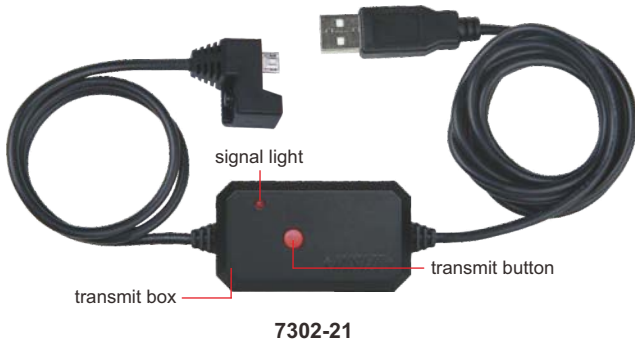

application

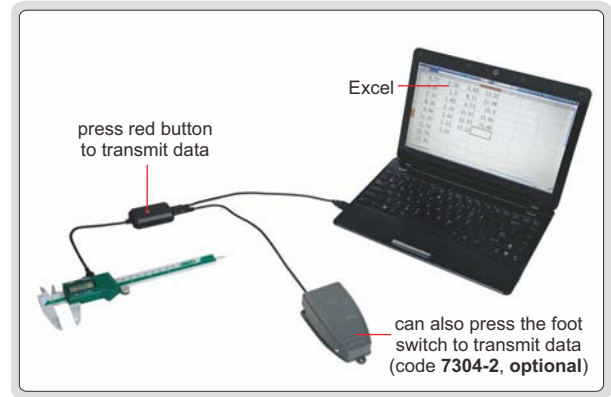













- Recognized as HID keyboard device by computer, no need to install drivers and softwares
- Data can be transmitted to Excel, Word, txt and other files (press transmit button, which is recognized by the computer as keyboard input data and press enter, such as 12.34↵)
- For any softwares which can receive keyboard signal
- Optional accessory: foot switch (code: 7304-2), hub (code: 7324-HUB4, 7324-HUB7), extension cables (code: 7325-ADD5, 7325-ADD10)

Code	Description	Plug	Connecting with measuring tool	Transmit data
7302-21	cable for digital calipers (length 3m)			<ul style="list-style-type: none"> <li>▪ Press the transmit button on the plug of cable, can also press the transmit button of the transmit box, or press the foot switch</li> <li>▪ Data is transmitted once, the signal light of the transmit box flashes once</li> </ul>
7302-22	cable for large digital calipers (length 2.5m)			<ul style="list-style-type: none"> <li>▪ Press the transmit button of the transmit box, or press the foot switch</li> <li>▪ Data is transmitted once, the signal light of the transmit box flashes once</li> </ul>
7302-30	cable for digital micrometers (length 2.5m)			<ul style="list-style-type: none"> <li>▪ Press the "data" button of digital micrometer, can also press the transmit button of the transmit box, or press the foot switch</li> <li>▪ Data is transmitted once, the signal light of the transmit box flashes once, at the same time, the signal light on the digital micrometer flashes once</li> </ul>
7302-31	cable for digital micrometers (length 2.5m)			<ul style="list-style-type: none"> <li>▪ Press the "data" button of digital micrometer, can also press the transmit button of the transmit box, or press the foot switch</li> <li>▪ Data is transmitted once, the signal light of the transmit box flashes once, at the same time, the signal light on the digital micrometer flashes once</li> </ul>









To be continued

Continued from the previous page

Code	Description	Plug	Connecting with measuring tool	Transmit data
7302-50M	cable for digital gages (length 2.5m)			<ul style="list-style-type: none"> <li>Press the transmit button of the transmit box, or press the foot switch</li> <li>Data is transmitted once, the signal light of the transmit box flashes once</li> </ul>
7302-40M	cable for digital indicators (length 2.5m)		 <p>“DATA” button signal light</p> <p>for 2108, 2138, 2139 series digital indicators</p>	<ul style="list-style-type: none"> <li>Press the “DATA” button of digital indicator, can also press the transmit button of the transmit box, or press the foot switch</li> <li>Data is transmitted once, the signal light of the transmit box flashes once, at the same time, the signal light on digital indicator flashes once</li> </ul> <p>Note: long press transmit button to zero the digital indicators</p>
			 <p>for other digital indicators</p>	<ul style="list-style-type: none"> <li>Press the transmit button of the transmit box, or press the foot switch</li> <li>Data is transmitted once, the signal light of the transmit box flashes once</li> </ul> <p>Note: long press transmit button to zero the digital indicators</p>
7302-60	cable for high precision digital indicators (length 2.5m)		 <p>“DATA” button</p>	<ul style="list-style-type: none"> <li>Press the “DATA” button of high precision digital indicator, can also press the transmit button of the transmit box, or press the foot switch</li> <li>Data is transmitted once, the signal light of the transmit box flashes once</li> </ul>
7302-3350	cable for digital micrometers (length 2.5m)		 <p>“DATA” button</p>	<ul style="list-style-type: none"> <li>Press the “DATA” button of digital micrometer, can also press the transmit button of the transmit box, or press the foot switch</li> <li>Data is transmitted once, the signal light of the transmit box flashes once</li> </ul>
7302-1151	cable for digital height gages (length 2.5m)			<ul style="list-style-type: none"> <li>Press the transmit button of the transmit box, or press the foot switch</li> <li>Data is transmitted once, the signal light of the transmit box flashes once</li> </ul>
7302-SPC7	cable for digital height gages (length 2.5m)			<ul style="list-style-type: none"> <li>Press the transmit button of the transmit box, or press the foot switch</li> <li>Data is transmitted once, the signal light of the transmit box flashes once</li> </ul>

To be continued

Continued from the previous page

Code	Description	Plug	Connecting with measuring tool	Transmit data
7302-8001	cable for weighing scales (length 2.5m)		 <p>back</p>  <p>for 8301 and 8305 series electronic balances</p>	<ul style="list-style-type: none"> <li>Press the “” button of electronic balances, can also press the transmit button of the transmit box, or press the foot switch</li> <li>Data is transmitted once, the signal light of the transmit box flashes once</li> </ul>
			 <p>back</p>  <p>for 8001-6D, 8001-15D, 8001-30D series weighing scales and 8501 series platform scales</p>	<ul style="list-style-type: none"> <li>Press the transmit button of the transmit box, or press the foot switch</li> <li>Data is transmitted once, the signal light of the transmit box flashes once</li> </ul>
7302-8304	cable for electronic balances (length 3m)		 <p>back</p> 	<ul style="list-style-type: none"> <li>Press the “” button of electronic balances, can also press the transmit button of the transmit box, or press the foot switch</li> <li>Data is transmitted once, the signal light of the transmit box flashes once</li> </ul>

## DISPLAY UNIT CODE 7106-1A

REFER TO PAGE 261  
FOR DETAILS



connected with digital indicator



## MULTICHANNEL INTERFACE BOXES

REFER TO PAGE 262  
FOR DETAILS



7107-1

connected with digital indicators



HUBS

1

application

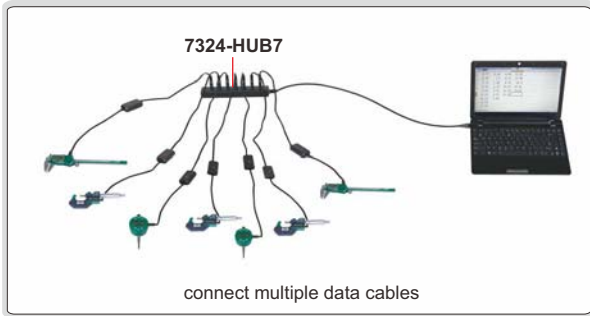

7324-HUB4



7324-HUB7

Code	Description	Applicable products
7324-HUB4	4-channel hub (length 0.2m, USB computer plug)	7302 series data cables
7324-HUB7	7-channel hub (length 1m, USB computer plug)	7305 series data cables (USB plug)

■ For USB plug data cable

EXTENSION CABLES

application



7325-ADD5

Code	Description	Applicable products
7325-ADD5	data extension cable (length 5m, USB plug)	7302 series data cables
7325-ADD10	data extension cable (length 10m, USB plug)	7305 series data cables (USB plug)

application

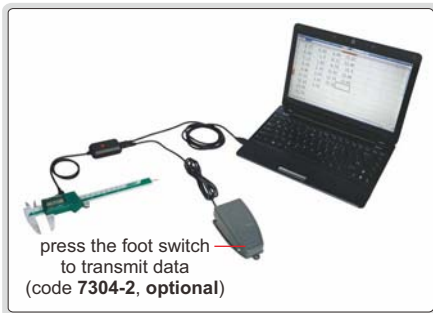

7304-2

FOOT SWITCH

■ For data transmission

Code	Description	Applicable products
7304-2	data transmission foot switch with cable (length 2m)	7302 series data cables 7305 series data cables

OK/NG INPUT SWITCHES



7327-FS



7327-SW

Code	Description
7327-FS	foot switch for OK/NG input
7327-SW	hand switch for OK/NG input

■ Used with 7317 software, output OK or NG  
■ USB plug, length 1.5m

application



# 02

## CALIPERS



Digital Calipers  
Page 17-24



Vernier Calipers  
Page 24-28



Dial Calipers  
Page 28



Large Digital Calipers  
Page 29-31



Large Vernier Calipers  
Page 31-33



Depth Base Attachments  
Page 34



Caliper/Height Gage Checkers  
Page 34



Caliper End Grinding Machines  
Page 34



Accessory Sets For Digital Calipers  
Page 35-36



Special Purpose Calipers  
Page 37-66





DATA  
OUTPUT

IP67  
WATERPROOF

## IP67 WATERPROOF DIGITAL CALIPERS

INSIZE PLUS  
MADE IN EUROPE

- IP67 dust/waterproof
- Resolution: 0.01mm/0.0005"
- Button function: zero, mm/inch, preset, data output
- Battery CR2032
- Automatic power off, move the digital unit to turn on power
- Data output
- Meet DIN862
- Made of stainless steel
- Optional accessory: data output cable (code 7315-80 need receiver page 5, 7302-80)



1195-150

(mm)

Code	Range	Accuracy	L	a	b	c	d	Remark
1195-150*	0-150mm/0-6"	±0.02mm	235	21	16.5	16	40	with depth bar
1195-200*	0-200mm/0-8"	±0.03mm	290	24.5	20	16	50	with depth bar
1195-300*	0-300mm/0-12"	±0.03mm	387	23	18.5	16	64	without depth bar

\* Supplied with manufacturer inspection certificate

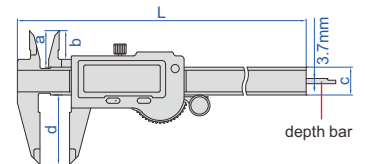

ATTENTION: IT IS NECESSARY TO SET ZERO AFTER POWER ON EACH TIME

ATTENTION: NO DATA OUTPUT

IP67  
WATERPROOF

## IP67 WATERPROOF DIGITAL CALIPERS



- IP67 dust/waterproof
- Resolution: 0.01mm/0.0005"
- Button function: zero, on/off, mm/inch, ABS/REL, hold
- Battery CR2032
- Meet DIN862
- Made of stainless steel



1118-150B



1118-150R

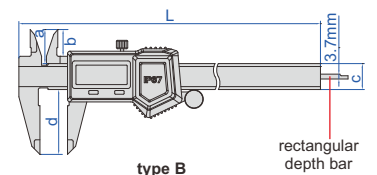

type B

rectangular depth bar

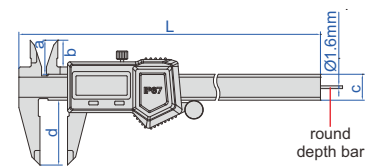

type R

round depth bar

Code	Range	Accuracy	Type	L	a	b	c	d
1118-150B*	0-150mm/0-6"	±0.03mm	B	236mm	21mm	16mm	16mm	40mm
1118-200B*	0-200mm/0-8"	±0.03mm	B	286mm	24mm	19mm	16mm	50mm
1118-300B*	0-300mm/0-12"	±0.03mm	B	400mm	25mm	20.5mm	16mm	60mm
1118-150R*	0-150mm/0-6"	±0.03mm	R	236mm	21mm	16mm	16mm	40mm

\* Supplied with manufacturer inspection certificate

ATTENTION: NO DATA OUTPUT

IP67  
WATERPROOF

## IP67 WATERPROOF DIGITAL CALIPERS



- IP67 dust/waterproof
- Resolution: 0.01mm/0.0005"
- Button function: zero, on/off, mm/inch
- Battery CR2032
- Automatic power off
- Meet DIN862
- Made of stainless steel



1115-150

Code	Range	Accuracy	L	a	b	c	d
1115-150*	0-150mm/0-6"	±0.03mm	235mm	20mm	15mm	16mm	40mm
1115-200*	0-200mm/0-8"	±0.03mm	287mm	24mm	19mm	16mm	50mm
1115-300*	0-300mm/0-12"	±0.03mm	388mm	26mm	21mm	16mm	60mm

\* Supplied with manufacturer inspection certificate

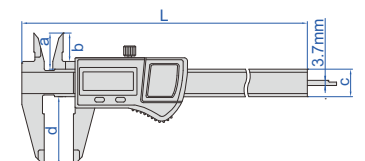

## WIRELESS DIGITAL CALIPERS



ATTENTION: THE WORKING LIFE OF A BATTERY IS ABOUT 3-5 MONTHS

2

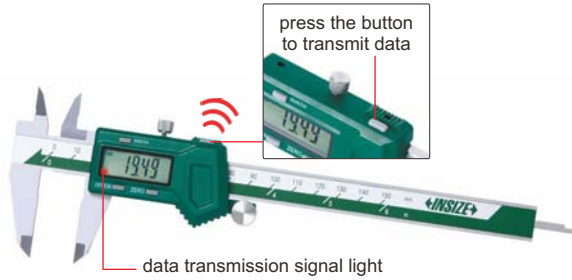

1113-150

- Non waterproof
- Built-in wireless data transmission module, Zigbee signal
- Transmission distance is 10 meter (under the condition of no obstruction and no electromagnetic interference)
- Resolution: 0.01mm/0.0005"
- Buttons: on/off, zero, mm/inch, data transmission
- Automatic power off, move the digital unit to turn on power
- Battery CR2032
- Made of stainless steel
- Optional accessory: receiver (code 7315-2/3/6/7/8/9)

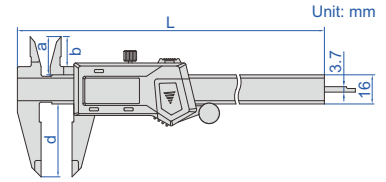

application

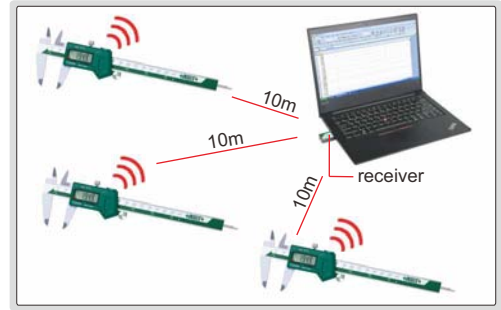

receiver (optional)

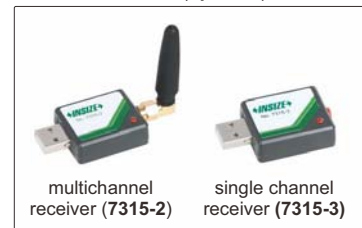

Code	Range	Accuracy	L	a	b	d
1113-150*	0-150mm/0-6"	±0.03mm	236	21	16	40
1113-200*	0-200mm/0-8"	±0.03mm	286	24	19	50
1113-300*	0-300mm/0-12"	±0.03mm	400	25	20.5	60

\*Supplied with manufacturer inspection certificate

## DIGITAL CALIPERS (ABSOLUTE SYSTEM)



1103-150

- Non waterproof
- Absolute system, low power consumption, long battery life
- Resolution: 0.01mm/0.0005"
- Buttons: on/off, mm/inch, ORIGIN, ZERO/ABS
- Automatic power off, move the digital unit to turn on power
- Battery CR2032
- Data output
- Meet DIN862
- Made of stainless steel
- Optional accessory: wireless transmitter, code 7315-22 need receiver page 4, data output cable (keyboard format), code 7302-22 page 12

Code	Range	Accuracy	Type	L	a	b	d
1103-150*	0-150mm/0-6"	±0.03mm	A	236mm	21mm	16.5mm	40mm
1103-200*	0-200mm/0-8"	±0.03mm	A	286mm	24mm	19.5mm	50mm
1103-300*	0-300mm/0-12"	±0.03mm	A	400mm	26mm	21.5mm	60mm
1103-150R*	0-150mm/0-6"	±0.03mm	R	236mm	21mm	16.5mm	40mm

\*Supplied with manufacturer inspection certificate

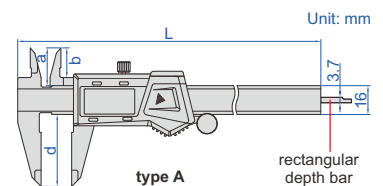

type A

rectangular depth bar

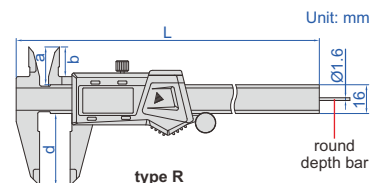

type R

round depth bar

DATA OUTPUT

INSPECTION CERTIFICATE

DIGITAL CALIPERS (FRACTION READING)

- Non waterproof
- Resolution: 1/128", 0.01mm, 0.0005"
- Buttons: unit (inch fraction/mm/inch), on/off, zero
- Automatic power off, move the digital unit to turn on power
- Battery CR2032
- Data output (for mm and inch)
- Meet DIN862
- Made of stainless steel
- Optional accessory: data output cable (code 7315-21 need receiver page 4, 7302-21 page 12)



1102-150

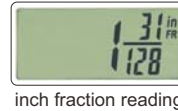

inch fraction reading



mm reading



inch reading

Unit: mm

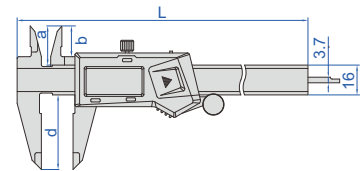

Code	Range	Accuracy	L	a	b	d
1102-150 *	0-150mm/0-6"	±0.02mm	236mm	21mm	16mm	40mm
1102-200 *	0-200mm/0-8"	±0.03mm	286mm	24mm	19mm	50mm
1102-300 *	0-300mm/0-12"	±0.03mm	400mm	25mm	20.5mm	60mm

\* Supplied with manufacturer inspection certificate

ATTENTION: NO DATA OUTPUT

INSPECTION CERTIFICATE

DIGITAL CALIPERS

- Non waterproof
- Zinc alloy housing for digital unit
- Resolution: 0.01mm/0.0005"
- Buttons: zero, on/off, mm/inch
- Automatic power off, move the digital unit to turn on power
- Battery CR2032
- Meet DIN862
- Made of stainless steel



1114-150A

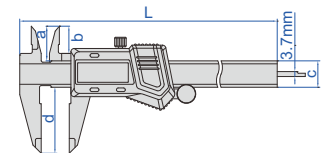

Code	Range	Accuracy	L	a	b	c	d
1114-150A *	0-150mm/0-6"	±0.03mm	236mm	21mm	16mm	16mm	40mm
1114-200A *	0-200mm/0-8"	±0.03mm	286mm	24mm	19mm	16mm	50mm
1114-300A *	0-300mm/0-12"	±0.03mm	400mm	25mm	20.5mm	17mm	60mm

\* Supplied with manufacturer inspection certificate

DATA OUTPUT

INSPECTION CERTIFICATE

POPULAR MODEL

DIGITAL CALIPERS (STANDARD TYPE)

- Non waterproof
- Resolution: 0.01mm/0.0005"
- Buttons: on/off, zero, mm/inch
- Automatic power off, move the digital unit to turn on power
- Battery CR2032
- Data output
- Meet DIN862
- Made of stainless steel
- Optional accessory: data output cable (code 7315-21 need receiver page 4, 7302-21 page 12)



1108-150

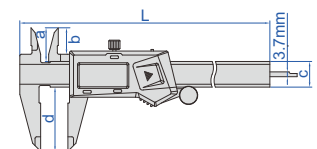

Code	Range	Accuracy	L	a	b	c	d
1108-150 *	0-150mm/0-6"	±0.02mm	236mm	21mm	16mm	16mm	40mm
1108-200 *	0-200mm/0-8"	±0.03mm	286mm	24mm	19mm	16mm	50mm
1108-250 *	0-250mm/0-10"	±0.03mm	350mm	25mm	20.5mm	16mm	60mm
1108-300 *	0-300mm/0-12"	±0.03mm	400mm	25mm	20.5mm	16mm	60mm

\* Supplied with manufacturer inspection certificate

## HEAVY DUTY 300mm DIGITAL CALIPER

DATA OUTPUT

INSPECTION CERTIFICATE

- Non waterproof
- Resolution: 0.01mm/0.0005"
- Buttons: on/off, zero, mm/inch
- Automatic power off, move the digital unit to turn on power
- Battery CR2032
- Data output
- Meet DIN862
- Made of stainless steel
- Optional accessory: data output cable (code 7315-22 need receiver page 4, 7302-22 page 12)



1196-300

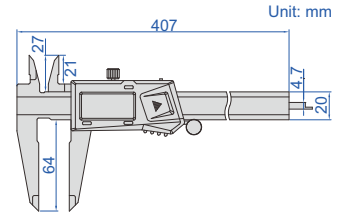

Code	Range	Accuracy
1196-300 *	0-300mm/0-12"	±0.03mm

\*Supplied with manufacturer inspection certificate

## METRIC DIGITAL CALIPERS

INSPECTION CERTIFICATE

LOCK READING WITH "HOLD" BUTTON

DATA OUTPUT

- Non waterproof
- Resolution: 0.01mm
- Buttons: on/off, zero, hold
- Automatic power off, move the digital unit to turn on power
- Battery CR2032
- Data output
- Meet DIN862
- Made of stainless steel
- Optional accessory: data output cable (code 7315-21 need receiver page 4, 7302-21 page 12)



1109-150

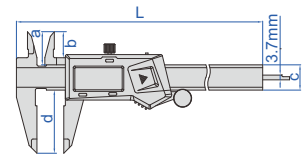

Code	Range	Accuracy	L	a	b	c	d
1109-150 *	0-150mm	±0.03mm	236mm	21mm	16mm	16mm	40mm
1109-200 *	0-200mm	±0.03mm	286mm	24mm	19mm	16mm	50mm
1109-300 *	0-300mm	±0.03mm	400mm	25mm	20.5mm	16mm	60mm

\*Supplied with manufacturer inspection certificate

## DIGITAL CALIPERS WITH ROUND DEPTH BAR

INSPECTION CERTIFICATE

DATA OUTPUT

- Non waterproof
- Resolution: 0.01mm/0.0005"
- Buttons: on/off, zero, mm/inch
- Automatic power off, move the digital unit to turn on power
- Battery CR2032
- Meet DIN862
- Made of stainless steel



1119-150

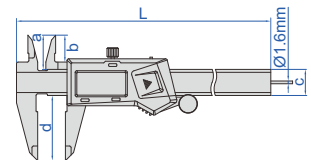

With data interface (data output cable code 7315-21 need receiver page 4, 7302-21 page 12, optional)

Code	Range	Accuracy	L	a	b	c	d
1119-150 *	0-150mm/0-6"	±0.03mm	236mm	21mm	16mm	16mm	40mm



round depth bar Ø1.6mm

Built-in wireless (receiver code 7315-2/3/6/7/8/9 is required)

Code	Range	Accuracy	L	a	b	c	d
1119-150WL *	0-150mm/0-6"	±0.03mm	236mm	21mm	16mm	16mm	40mm

\*Supplied with manufacturer inspection certificate

DATA  
OUTPUT

INSPECTION  
CERTIFICATE

## LEFT HAND DIGITAL CALIPERS

2

- Non waterproof
- Designed for left handed users
- Resolution: 0.01mm/0.0005"
- Buttons: on/off, zero, mm/inch
- Automatic power off, move the digital unit to turn on power
- Battery CR2032
- Data output
- Meet DIN862
- Made of stainless steel
- Optional accessory: data output cable  
(code 7315-22 need receiver page 4, 7302-22 page 12)



1130-150

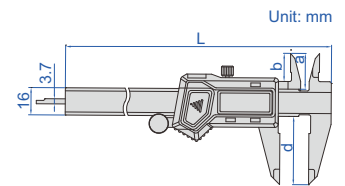

Unit: mm

Code	Range	Accuracy	L	a	b	d
1130-150*	0-150mm/0-6"	±0.03mm	236mm	21mm	16mm	40mm
1130-200*	0-200mm/0-8"	±0.03mm	286mm	24mm	19mm	50mm
1130-300*	0-300mm/0-12"	±0.03mm	400mm	25mm	20.5mm	60mm

\* Supplied with manufacturer inspection certificate

DATA  
OUTPUT

INSPECTION  
CERTIFICATE

## DIGITAL CALIPERS WITH CERAMIC TIPPED JAWS



1193-150

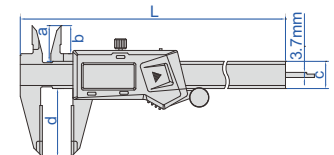

ceramic  
tipped jaws



- Non waterproof
- Ceramic tipped jaws for outside measurement, extremely wear-resistant, non-magnetic and non electric conductive
- Resolution: 0.01mm/0.0005"
- Buttons: on/off, zero, mm/inch
- Automatic power off, move the digital unit to turn on power
- Battery CR2032, made of stainless steel
- Meet DIN862

With data interface (data output cable code 7315-21 need receiver page 4, 7302-21 page 12, optional)

Code	Range	Accuracy	L	a	b	c	d
1193-150*	0-150mm/0-6"	±0.03mm	235mm	21mm	16.5mm	16mm	40mm
1193-200*	0-200mm/0-8"	±0.03mm	287mm	24mm	20mm	16mm	50mm
1193-300*	0-300mm/0-12"	±0.03mm	390mm	26mm	21.5mm	16mm	60mm

Built-in wireless (receiver code 7315-2/3/6/7/8/9 is required)

Code	Range	Accuracy	L	a	b	c	d
1193-150WL*	0-150mm/0-6"	±0.03mm	235mm	21mm	16.5mm	16mm	40mm
1193-200WL*	0-200mm/0-8"	±0.03mm	287mm	24mm	20mm	16mm	50mm
1193-300WL*	0-300mm/0-12"	±0.03mm	390mm	26mm	21.5mm	16mm	60mm

\* Supplied with manufacturer inspection certificate

## DIGITAL CALIPERS WITH CARBIDE TIPPED JAWS



2

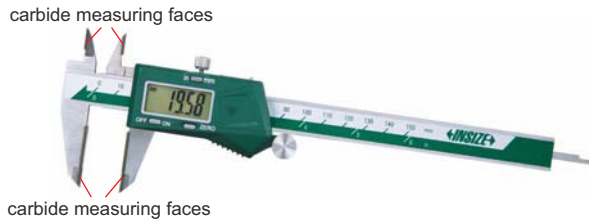

1110-150A



1110-150B

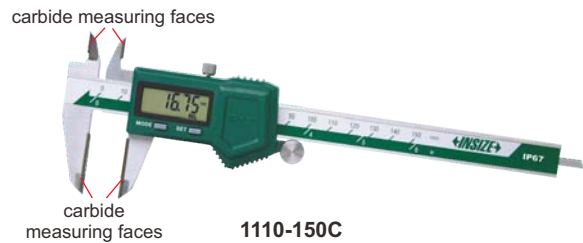

1110-150C

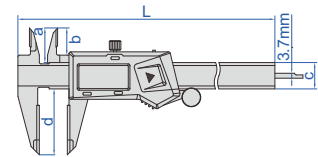

- Resolution: 0.01mm/0.0005"
- Buttons: on/off, zero, mm/inch
- Automatic power off, move the digital unit to turn on power
- Battery CR2032
- Meet DIN862
- Made of stainless steel

### Non waterproof, with data interface (data output cable code 7315-21 need receiver page 4, 7302-21 page 12, optional)

Code	Range	Accuracy	L	a	b	c	d	Remark
1110-150A *	0-150mm/0-6"	±0.03mm	236mm	21mm	16mm	16mm	40mm	carbide tipped upper and lower jaws
1110-200A *	0-200mm/0-8"	±0.03mm	286mm	24mm	19mm	16mm	50mm	carbide tipped upper and lower jaws
1110-300A *	0-300mm/0-12"	±0.03mm	400mm	25mm	20.5mm	16mm	60mm	carbide tipped upper and lower jaws
1110-150B *	0-150mm/0-6"	±0.03mm	236mm	21mm	16mm	16mm	40mm	carbide tipped lower jaws
1110-200B *	0-200mm/0-8"	±0.03mm	286mm	24mm	19mm	16mm	50mm	carbide tipped lower jaws
1110-300B *	0-300mm/0-12"	±0.03mm	400mm	25mm	20.5mm	16mm	60mm	carbide tipped lower jaws

### Non waterproof, built-in wireless (receiver code 7315-2/3/6/7/8/9 is required)

Code	Range	Accuracy	L	a	b	c	d	Remark
1110-150AWL *	0-150mm/0-6"	±0.03mm	236mm	21mm	16mm	16mm	40mm	carbide tipped upper and lower jaws
1110-200AWL *	0-200mm/0-8"	±0.03mm	286mm	24mm	19mm	16mm	50mm	carbide tipped upper and lower jaws
1110-300AWL *	0-300mm/0-12"	±0.03mm	400mm	25mm	20.5mm	16mm	60mm	carbide tipped upper and lower jaws
1110-150BWL *	0-150mm/0-6"	±0.03mm	236mm	21mm	16mm	16mm	40mm	carbide tipped lower jaws
1110-200BWL *	0-200mm/0-8"	±0.03mm	286mm	24mm	19mm	16mm	50mm	carbide tipped lower jaws
1110-300BWL *	0-300mm/0-12"	±0.03mm	400mm	25mm	20.5mm	16mm	60mm	carbide tipped lower jaws

### IP67 dust/waterproof, without data interface

Code	Range	Accuracy	L	a	b	c	d	Remark
1110-150C *	0-150mm/0-6"	±0.03mm	236mm	21mm	16mm	16mm	40mm	carbide tipped upper and lower jaws
1110-150D *	0-150mm/0-6"	±0.03mm	236mm	21mm	16mm	16mm	40mm	carbide tipped lower jaws

\* Supplied with manufacturer inspection certificate

DATA  
OUTPUT

## DIGITAL CALIPERS

2

- Non waterproof
- Resolution: 0.01mm/0.0005"
- Buttons: on/off, zero, mm/inch
- Automatic power off, move the digital unit to turn on power
- Battery CR2032
- Made of stainless steel



1170-300

With data interface  
(data output cable code 7315-21 need receiver page 4, 7302-21 page 12, optional)

Code	Range	Accuracy	a	c	d	e	L
1170-200	0-200mm/0-8"	±0.03mm	12mm	17mm	60mm	10mm	314mm
1170-306	0-300mm/0-12"	±0.04mm	12mm	17mm	60mm	10mm	420mm
1170-300	0-300mm/0-12"	±0.06mm	12mm	17mm	90mm	10mm	420mm

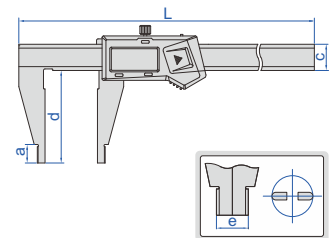

Built-in wireless (receiver code 7315-2/3/6/7/8/9 is required)

Code	Range	Accuracy	a	c	d	e	L
1170-200WL	0-200mm/0-8"	±0.03mm	12mm	17mm	60mm	10mm	314mm
1170-306WL	0-300mm/0-12"	±0.04mm	12mm	17mm	60mm	10mm	420mm
1170-300WL	0-300mm/0-12"	±0.06mm	12mm	17mm	90mm	10mm	420mm

DATA  
OUTPUT

## DIGITAL CALIPERS

- Non waterproof
- Resolution: 0.01mm/0.0005"
- Buttons: on/off, zero, mm/inch
- Automatic power off, move the digital unit to turn on power
- Battery CR2032
- Made of stainless steel



1171-300

With data interface  
(data output cable code 7315-21 need receiver page 4, 7302-21 page 12, optional)

Code	Range	Accuracy	a	b	c	d	e	L
1171-200	0-200mm/0-8"	±0.03mm	12mm	38mm	17mm	60mm	10mm	320mm
1171-250	0-250mm/0-10"	±0.03mm	12mm	38mm	17mm	60mm	10mm	365mm
1171-306	0-300mm/0-12"	±0.04mm	12mm	38mm	17mm	60mm	10mm	420mm
1171-300	0-300mm/0-12"	±0.06mm	12mm	38mm	17mm	90mm	10mm	420mm

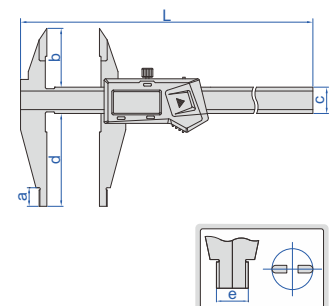

Built-in wireless (receiver code 7315-2/3/6/7/8/9 is required)

Code	Range	Accuracy	a	b	c	d	e	L
1171-200WL	0-200mm/0-8"	±0.03mm	12mm	38mm	17mm	60mm	10mm	320mm
1171-250WL	0-250mm/0-10"	±0.03mm	12mm	38mm	17mm	60mm	10mm	365mm
1171-306WL	0-300mm/0-12"	±0.04mm	12mm	38mm	17mm	60mm	10mm	420mm
1171-300WL	0-300mm/0-12"	±0.06mm	12mm	38mm	17mm	90mm	10mm	420mm

## MINI DIGITAL CALIPERS

ATTENTION:  
NO DATA OUTPUT

2

- Non waterproof
- Resolution: 0.01mm/0.0005"
- Buttons: zero, mm/inch, on/off
- Automatic power off, move the digital unit to turn on power
- Battery LR44
- Meet DIN862
- Made of stainless steel



1111-100A

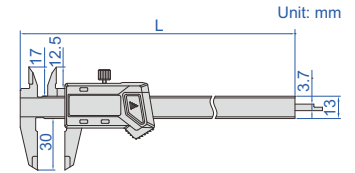

Code	Range	Accuracy	L
1111-75A	0-75mm/0-3"	±0.02mm	144mm
1111-100A	0-100mm/0-4"	±0.02mm	170mm

## PLASTIC DIGITAL CALIPER

ATTENTION:  
NO DATA OUTPUT

- Non waterproof
- Made of hard plastic, non-magnetic and non electric conductive
- Prevent workpieces from scratching by calipers
- Resolution: 0.01mm/0.0005"
- Buttons: on/off, zero, mm/inch
- Battery CR2032, automatic power off



1139-150

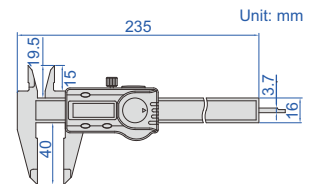

Code	Range	Accuracy
1139-150	0-150mm/0-6"	±0.1mm

## MINI VERNIER CALIPERS

- Meet DIN862
- Made of stainless steel
- Satin chrome plated reading surface

Code	Range	Graduation	Accuracy
1204-70	0-70mm	0.05mm	±0.05mm

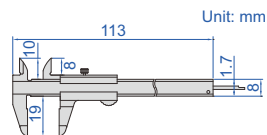

1204-70



Code	Range	Graduation	Accuracy
1203-1003	0-100mm	0.05mm	±0.05mm

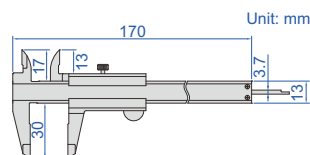

1203-1003



Code	Range	Graduation	Accuracy
1201-1003	0-100mm	0.05mm	±0.05mm

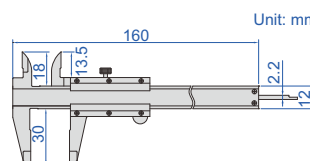

1201-1003





POPULAR MODEL

## VERNIER CALIPERS

2



1205-150S

**Graduation 0.05mm/1/128" (mm)**

Code	Range	Accuracy	L	a	b	c	d
1205-150S	0-150mm/0-6"	±0.05mm	235	20.5	15.5	16	40
1205-200S	0-200mm/0-8"	±0.05mm	290	23.5	19	17	50
1205-250S	0-250mm/0-10"	±0.05mm	364	27.5	22	20	64
1205-300S	0-300mm/0-12"	±0.05mm	414	27.5	22	20	64

**Graduation 0.05mm (mm)**

Code	Range	Accuracy	L	a	b	c	d
1205-1503S	0-150mm	±0.05mm	235	20.5	15.5	16	40
1205-2003S	0-200mm	±0.05mm	290	23.5	19	17	50
1205-2503S	0-250mm	±0.05mm	350	26	21.5	16	60
1205-3003S	0-300mm	±0.05mm	414	27.5	22	20	64

**Graduation 0.02mm/0.001" (mm)**

Code	Range	Accuracy	L	a	b	c	d
1205-1502S	0-150mm/0-6"	±0.03mm	235	20.5	15.5	16	40
1205-2002S	0-200mm/0-8"	±0.03mm	290	23.5	19	17	50
1205-2502S	0-250mm/0-10"	±0.03mm	364	27.5	22	20	64
1205-3002S	0-300mm/0-12"	±0.03mm	414	27.5	22	20	64

**Graduation 0.02mm (mm)**

Code	Range	Accuracy	L	a	b	c	d
1205-1501S	0-150mm	±0.03mm	235	20.5	15.5	16	40
1205-2001S	0-200mm	±0.03mm	290	23.5	19	17	50
1205-2501S	0-250mm	±0.03mm	350	26	21.5	16	60
1205-3001S	0-300mm	±0.03mm	414	27.5	22	20	64

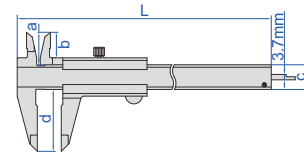

- Meet DIN862
- Made of stainless steel
- Satin chrome plated reading surface

## VERNIER CALIPER WITH ROUND DEPTH BAR



1202-150

- Graduation 0.05mm/1/128"
- Round depth bar
- Meet DIN862
- Made of stainless steel
- Satin chrome plated reading surface

Code	Range	Accuracy
1202-150	0-150mm/0-6"	±0.05mm

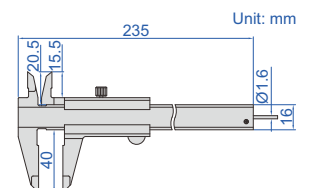

## VERNIER CALIPERS WITH FINE ADJUSTMENT

- Graduation 0.02mm/0.001"
- With fine adjustment
- Meet DIN862
- Made of stainless steel
- Satin chrome plated reading surface



1233-130

Code	Range	Accuracy	L	a	b	c	d	(mm)
1233-130	0-130mm/0-5"	±0.03mm	230	20.5	16.5	16	40	
1233-180	0-180mm/0-7"	±0.03mm	295	23.5	19	16	50	
1233-280	0-280mm/0-11"	±0.03mm	410	26	20	20	60	

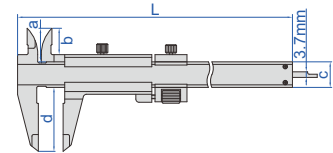

## VERNIER CALIPERS WITH THUMB CLAMP

- Meet DIN862
- With thumb clamp
- Made of stainless steel
- Satin chrome plated reading surface

Graduation 0.05mm/1/128" (mm)

Code	Range	Accuracy	L	a	b	c	d	(mm)
1223-150	0-150mm/0-6"	±0.05mm	230	20.5	16.5	16	40	
1223-200	0-200mm/0-8"	±0.05mm	295	23.5	19	16	50	



1223-150

Graduation 0.02mm/0.001" (mm)

Code	Range	Accuracy	L	a	b	c	d	(mm)
1223-1502	0-150mm/0-6"	±0.03mm	230	20.5	16.5	16	40	
1223-2002	0-200mm/0-8"	±0.03mm	295	23.5	19	16	50	

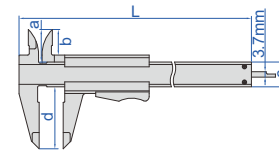

## VERNIER CALIPERS WITH CARBIDE TIPPED JAWS

- Carbide tipped jaws for inside and outside measurements
- Meet DIN862
- Made of stainless steel
- Satin chrome plated reading surface

Graduation 0.05mm/1/128" (mm)

Code	Range	Accuracy	L	a	b	c	d	(mm)
1238-150	0-150mm/0-6"	±0.05mm	230	21	16.5	16	40	
1238-200	0-200mm/0-8"	±0.05mm	295	24	19	16	50	
1238-300	0-300mm/0-12"	±0.05mm	410	25	20	16	60	

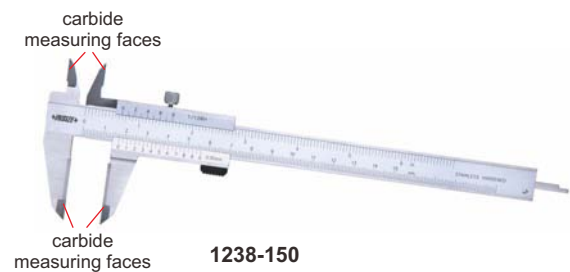

1238-150

Graduation 0.02mm/0.001" (mm)

Code	Range	Accuracy	L	a	b	c	d	(mm)
1238-1502	0-150mm/0-6"	±0.03mm	230	21	16.5	16	40	
1238-2002	0-200mm/0-8"	±0.03mm	295	24	19	16	50	
1238-3002	0-300mm/0-12"	±0.03mm	410	25	20	16	60	

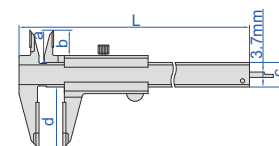

## VERNIER CALIPERS

2



1217-3001

- With fine adjustment
- Made of stainless steel
- Satin chrome plated reading surface

Code	Range	Graduation	Accuracy	L
1217-2503	0-250mm	0.05mm	±0.05mm	360mm
1217-3001	0-300mm	0.02mm	±0.03mm	410mm

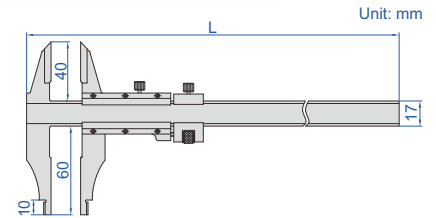
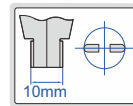

ATTENTION:  
NOT HARDENED

PURE COPPER

## VERNIER CALIPERS (ANTI MAGNETIC)

- Suitable for magnetic parts
- Made of pure copper



1224-150A

Code	Range	Graduation	Accuracy
1224-150A	0-150mm	0.02mm	±0.05mm
1224-1501A	0-150mm	0.05mm	±0.05mm

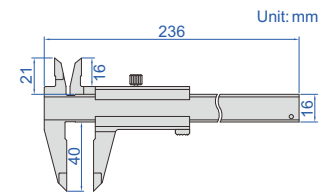

## LEFT HAND VERNIER CALIPERS

- Designed for left handed users
- Made of stainless steel
- Satin chrome plated reading surface



1239-1502

Code	Range	Graduation	Accuracy
1239-150	0-150mm/0-6"	0.05mm/1/128"	±0.05mm
1239-1503	0-150mm	0.05mm	±0.05mm
1239-1502	0-150mm/0-6"	0.02mm/0.001"	±0.03mm
1239-1501	0-150mm	0.02mm	±0.03mm

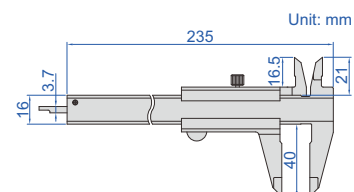

## TEETH VERNIER CALIPER



1226-70

- Used for teeth
- Made of stainless steel

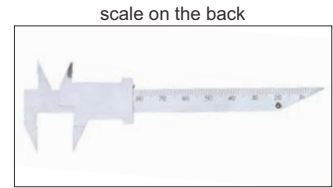

scale on the back

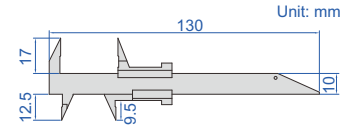

Code	Range	Graduation	Accuracy
1226-70	0-70mm	0.1mm	±0.1mm

## DIAL CALIPERS

SHOCK PROOF

INSPECTION CERTIFICATE

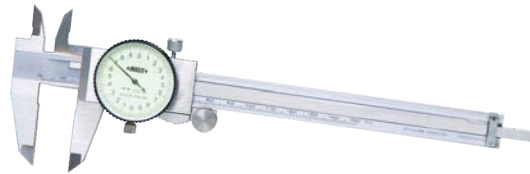

1312-150A

- Shockproof dial indicator
- Made of stainless steel

Dial indicator graduation: 0.02mm

(mm)

Code	Range	Accuracy	Thumb roller	L	a	b	c	d	D	t
1312-150A *	0-150mm	±0.03mm	with	235	21	16.5	16	40	Ø39	6.5
1312-200A *	0-200mm	±0.03mm	with	288	24	19	16	48	Ø39	6.5
1312-300A *	0-300mm	±0.03mm	with	410	28	22	20	62	Ø44.5	7.5
1312-100AW *	0-100mm	±0.02mm	without	165	18	13	13	30	Ø32	6

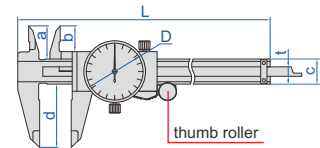

Dial indicator graduation: 0.01mm

(mm)

Code	Range	Accuracy	Thumb roller	L	a	b	c	d	D	t
1311-150A *	0-150mm	±0.03mm	with	235	21	16.5	16	40	Ø39	6.5
1311-200A *	0-200mm	±0.03mm	with	288	24	19	16	48	Ø39	6.5
1311-300A *	0-300mm	±0.03mm	with	410	28	22	20	62	Ø44.5	7.5

\*Supplied with manufacturer inspection certificate

## DIAL CALIPERS

SHOCK PROOF



1316-500

- Shockproof dial indicator
- Dial indicator graduation: 0.02mm
- Made of stainless steel

Code	Range	Accuracy	a	c	d	e	L
1316-500	0-500mm	±0.05mm	18	21	90	20	650
1316-600	0-600mm	±0.05mm	18	21	90	20	750
1316-1000	0-1000mm	±0.07mm	24	28	150	20	1190
1316-1500	0-1500mm	±0.11mm	24	28	150	20	1690

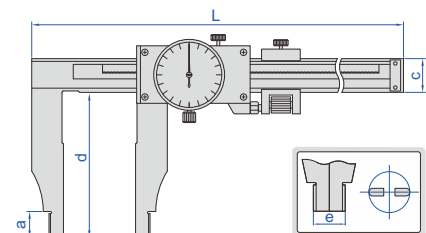

DATA  
OUTPUT

POPULAR  
MODEL

## DIGITAL CALIPERS

2



1106-501

- Non waterproof
- Resolution: 0.01mm/0.0005"
- Button function: on/off, zero, mm/inch, ABS, data preset
- Battery CR2032
- Made of stainless steel

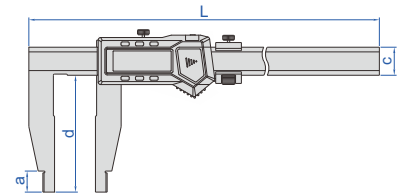
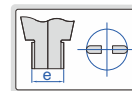

With data interface

(mm)

Code	Range	Accuracy	a	c	d	e	L	Data output cable (optional)
1106-301	0-300mm/0-12"	±0.05mm	18	24	100	20	420	7315-22 need receiver page 4, 7302-22 page 12
1106-302	0-300mm/0-12"	±0.05mm	18	24	150	20	420	7315-22 need receiver page 4, 7302-22 page 12
1106-451	0-450mm/0-18"	±0.05mm	18	24	100	20	625	7315-22 need receiver page 4, 7302-22 page 12
1106-501	0-500mm/0-20"	±0.05mm	18	24	100	20	675	7315-22 need receiver page 4, 7302-22 page 12
1106-502	0-500mm/0-20"	±0.06mm	18	24	150	20	675	7315-22 need receiver page 4, 7302-22 page 12
1106-503	0-500mm/0-20"	±0.06mm	24	31	200	20	675	7315-22 need receiver page 4, 7302-22 page 12
1106-505	0-500mm/0-20"	±0.08mm	24	42	300	20	675	7315-20B need receiver, 7302-SPC1A
1106-601	0-600mm/0-24"	±0.05mm	18	24	100	20	770	7315-22 need receiver page 4, 7302-22 page 12
1106-602	0-600mm/0-24"	±0.06mm	18	24	150	20	770	7315-22 need receiver page 4, 7302-22 page 12
1106-603	0-600mm/0-24"	±0.06mm	24	31	200	20	770	7315-22 need receiver page 4, 7302-22 page 12
1106-802	0-800mm/0-32"	±0.07mm	24	31	150	20	1025	7315-22 need receiver page 4, 7302-22 page 12
1106-1002	0-1000mm/0-40"	±0.08mm	24	31	150	20	1220	7315-22 need receiver page 4, 7302-22 page 12
1106-1003	0-1000mm/0-40"	±0.08mm	24	31	200	20	1220	7315-22 need receiver page 4, 7302-22 page 12
1106-1005	0-1000mm/0-40"	±0.10mm	24	42	300	20	1220	7315-22 need receiver page 4, 7302-22 page 12
1106-1502	0-1500mm/0-60"	±0.11mm	24	42	150	20	1780	7315-20B need receiver, 7302-SPC1A
1106-1503	0-1500mm/0-60"	±0.12mm	24	42	200	20	1780	7315-20B need receiver, 7302-SPC1A
1106-2002	0-2000mm/0-80"	±0.14mm	24	42	150	20	2290	7315-20B need receiver, 7302-SPC1A
1106-2003	0-2000mm/0-80"	±0.14mm	24	42	200	20	2290	7315-20B need receiver, 7302-SPC1A
1106-2502	0-2500mm/0-100"	±0.22mm	24	42	150	20	2800	7315-20B need receiver, 7302-SPC1A
1106-3002	0-3000mm/0-120"	±0.26mm	24	42	150	20	3300	7315-20B need receiver, 7302-SPC1A

Built-in wireless (receiver code 7315-2/3/6/7/8/9 is required)

Code	Range	Accuracy	a	c	d	e	L
1106-301WL	0-300mm/0-12"	±0.05mm	18mm	24mm	100mm	20mm	420mm
1106-302WL	0-300mm/0-12"	±0.05mm	18mm	24mm	150mm	20mm	420mm
1106-451WL	0-450mm/0-18"	±0.05mm	18mm	24mm	100mm	20mm	625mm
1106-501WL	0-500mm/0-20"	±0.05mm	18mm	24mm	100mm	20mm	675mm
1106-502WL	0-500mm/0-20"	±0.06mm	18mm	24mm	150mm	20mm	675mm
1106-601WL	0-600mm/0-24"	±0.05mm	18mm	24mm	100mm	20mm	770mm
1106-602WL	0-600mm/0-24"	±0.06mm	18mm	24mm	150mm	20mm	770mm

## DIGITAL CALIPERS

DATA OUTPUT

2

- Non waterproof
- Resolution: 0.01mm/0.0005"
- Button function: on/off, zero, mm/inch, ABS, data preset
- Battery CR2032
- Made of stainless steel



1117-501

With data interface  
(data output cable code 7315-22 need receiver page 4, 7302-22 page 12, optional)

Code	Range	Accuracy	a	b	c	d	e	L
1117-301	0-300mm/0-12"	±0.05mm	18mm	56mm	24mm	100mm	20mm	420mm
1117-501	0-500mm/0-20"	±0.05mm	18mm	56mm	24mm	100mm	20mm	675mm
1117-502	0-500mm/0-20"	±0.06mm	24mm	56mm	24mm	150mm	20mm	675mm
1117-601	0-600mm/0-24"	±0.05mm	18mm	56mm	24mm	100mm	20mm	770mm
1117-802	0-800mm/0-32"	±0.07mm	24mm	67mm	31mm	150mm	20mm	1025mm
1117-1002	0-1000mm/0-40"	±0.08mm	24mm	67mm	31mm	150mm <td 20mm	1220mm	

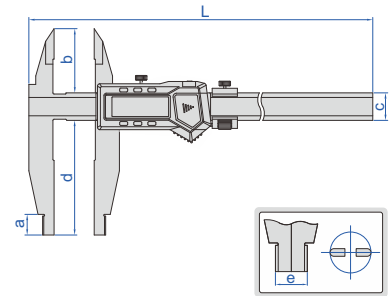

Built-in wireless (receiver code 7315-2/3/6/7/8/9 is required)

Code	Range	Accuracy	a	b	c	d	e	L
1117-301WL	0-300mm/0-12"	±0.05mm	18mm	56mm	24mm	100mm	20mm	420mm
1117-501WL	0-500mm/0-20"	±0.05mm	18mm	56mm	24mm	100mm	20mm	675mm
1117-502WL	0-500mm/0-20"	±0.06mm	24mm	56mm	24mm	150mm	20mm	675mm
1117-601WL	0-600mm/0-24"	±0.05mm	18mm	56mm	24mm	100mm	20mm	770mm

## DIGITAL CALIPERS

DATA OUTPUT

- Non waterproof
- Resolution: 0.01mm/0.0005"
- Button function: on/off, zero, mm/inch, ABS, data preset
- Battery CR2032
- Made of stainless steel



1136-501

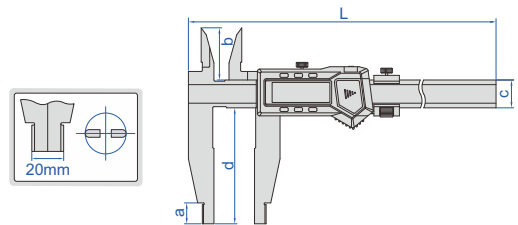

With data interface (data output cable code 7315-22 need receiver page 4, 7302-22 page 12, optional, for calipers with c=24mm or 31mm) (mm)

Code	Range	Accuracy	a	b	c	d	L
1136-301	0-300mm/0-12"	±0.05mm	18	45	24	100	420
1136-451	0-450mm/0-18"	±0.05mm	18	45	24	100	625
1136-501	0-500mm/0-20"	±0.05mm	18	45	24	100	675
1136-502	0-500mm/0-20"	±0.06mm	18	45	24	150	675
1136-503	0-500mm/0-20"	±0.06mm	24	60	31	200	675
1136-601	0-600mm/0-24"	±0.05mm	18	45	24	100	770
1136-1002	0-1000mm/0-40"	±0.08mm	24	60	31	150	1220
1136-1502	0-1500mm/0-60"	±0.11mm	24	60	42	150	1780
1136-2002	0-2000mm/0-80"	±0.14mm	24	60	42	150	2290

Built-in wireless (receiver code 7315-2/3/6/7/8/9 is required) (mm)

Code	Range	Accuracy	a	b	c	d	L
1136-301WL	0-300mm/0-12"	±0.05mm	18	45	24	100	420
1136-451WL	0-450mm/0-18"	±0.05mm	18	45	24	100	625
1136-501WL	0-500mm/0-20"	±0.05mm	18	45	24	100	675
1136-502WL	0-500mm/0-20"	±0.06mm	18	45	24	150	675
1136-601WL	0-600mm/0-24"	±0.05mm	18	45	24	100	770

DATA OUTPUT

DIGITAL CALIPERS

2



1135-601

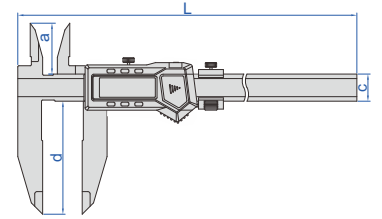

- Non waterproof
- Resolution: 0.01mm/0.0005"
- Button function: on/off, zero, mm/inch, ABS, data preset
- Battery CR2032
- Made of stainless steel

With data interface (data output cable code 7315-22 need receiver page 4, 7302-22 page 12, optional) (mm)

Code	Range	Accuracy	a	c	d	L
1135-451	0-450mm/0-18"	±0.05mm	45	24	100	625
1135-601	0-600mm/0-24"	±0.05mm	45	24	100	770
1135-1002	0-1000mm/0-40"	±0.08mm	60	31	150	1220

Built-in wireless (receiver code 7315-2/3/6/7/8/9 is required) (mm)

Code	Range	Accuracy	a	c	d	L
1135-451WL	0-450mm/0-18"	±0.05mm	45	24	100	625
1135-601WL	0-600mm/0-24"	±0.05mm	45	24	100	770

VERNIER CALIPERS (SOLID TYPE)

- With fine adjustment
- Made of stainless steel
- Satin chrome plated reading surface



1236-521

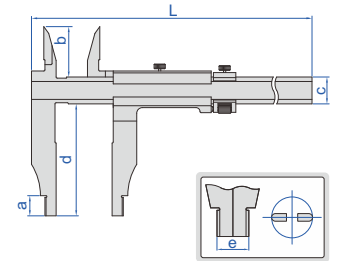

solid type (without screw)



Graduation 0.05mm/1/128" (mm)

Code	Range	Accuracy	a	b	c	d	e	L
1236-394	0-300mm/0-12"	±0.07mm	12	38	20	90	10	450
1236-514	0-500mm/0-20"	±0.07mm	18	45	24	100	20	670
1236-524	0-500mm/0-20"	±0.08mm	18	45	24	150	20	670
1236-614	0-600mm/0-24"	±0.08mm	18	45	24	100	20	770
1236-824	0-800mm/0-32"	±0.09mm	24	60	31	150	20	1030
1236-1024	0-1000mm/0-40"	±0.12mm	24	60	31	150	20	1230

Graduation 0.02mm (mm)

Code	Range	Accuracy	a	b	c	d	e	L
1236-511	0-500mm	±0.05mm	18	45	24	100	20	670
1236-521	0-500mm	±0.06mm	18	45	24	150	20	670
1236-1021	0-1000mm	±0.08mm	24	60	31	150	20	1230

VERNIER CALIPERS (SOLID TYPE)

- Graduation 0.05mm/1/128"
- With fine adjustment
- Made of stainless steel
- Satin chrome plated reading surface



1207-514

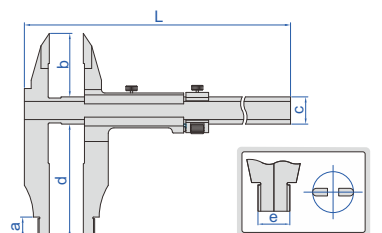

solid type (without screw)



(mm)

Code	Range	Accuracy	a	b	c	d	e	L
1207-394	0-300mm/0-12"	±0.07mm	12	40	20	90	10	440
1207-514	0-500mm/0-20"	±0.07mm	18	56	24	100	20	670
1207-524	0-500mm/0-20"	±0.08mm	18	56	24	150	20	670
1207-824	0-800mm/0-32"	±0.09mm	24	67	31	150	20	930
1207-1024	0-1000mm/0-40"	±0.12mm	24	67	31	150	20	1230

## VERNIER CALIPERS (SOLID TYPE)

- With fine adjustment
- Made of stainless steel
- Satin chrome plated reading surface



1208-511

Graduation 0.05mm/1/128" (mm)

Code	Range	Accuracy	a	c	d	e	L
1208-214	0-200mm/0-8"	±0.06mm	10	20	100	10	330
1208-394	0-300mm/0-12"	±0.07mm	10	20	90	10	410
1208-324	0-300mm/0-12"	±0.07mm	18	24	150	20	410
1208-524	0-500mm/0-20"	±0.08mm	18	24	150	20	670
1208-614	0-600mm/0-24"	±0.08mm	18	24	100	20	770
1208-624	0-600mm/0-24"	±0.09mm	18	24	150	20	770
1208-824	0-800mm/0-32"	±0.09mm	24	31	150	20	1030
1208-1024	0-1000mm/0-40"	±0.12mm	24	31	150	20	1230
1208-1524	0-1500mm/0-60"	±0.16mm	24	42	150	20	1820
1208-2024	0-2000mm/0-80"	±0.20mm	24	42	150	20	2330

solid type  
(without screw)



Graduation 0.02mm (mm)

Code	Range	Accuracy	a	c	d	e	L
1208-511	0-500mm	±0.05mm	18	24	100	20	670
1208-521	0-500mm	±0.06mm	18	24	150	20	670
1208-1021	0-1000mm	±0.08mm	24	31	150	20	1230
1208-1521	0-1500mm	±0.11mm	24	42	150	20	1820

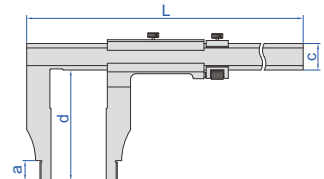
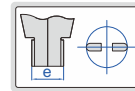

## VERNIER CALIPERS (SOLID TYPE)

- With fine adjustment
- Made of stainless steel
- Satin chrome plated reading surface



1210-611

Graduation 0.05mm/1/128" (mm)

Code	Range	Accuracy	a	c	d	L
1210-614	0-600mm/0-24"	±0.08mm	45	24	100	770
1210-1024	0-1000mm/0-40"	±0.12mm	60	31	150	1230

Graduation 0.02mm (mm)

Code	Range	Accuracy	a	c	d	L
1210-611	0-600mm	±0.05mm	45	24	100	770
1210-1021	0-1000mm	±0.08mm	60	31	150	1230

solid type  
(without screw)

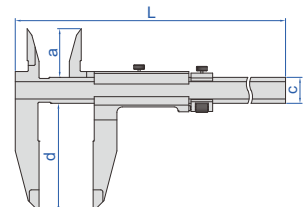



**POPULAR MODEL**

## VERNIER CALIPERS (SEPARATE TYPE)

2

- With fine adjustment
- Made of stainless steel
- Satin chrome plated reading surface



1214-500

Graduation 0.02mm/0.001" (mm)

Code	Range	Accuracy	a	c	d	e	L
1214-300	0-300mm/0-12"	±0.05mm	10	20	75	10	410
1214-450	0-450mm/0-18"	±0.05mm	18	24	100	20	620
1214-500	0-500mm/0-20"	±0.05mm	18	24	100	20	670
1214-600	0-600mm/0-24"	±0.05mm	18	24	100	20	770
1214-1000	0-1000mm/0-40"	±0.08mm	24	32	140	20	1216
1214-1500	0-1500mm/0-60"	±0.12mm	24	42	200	20	1830
1214-2000	0-2000mm/0-80"	±0.14mm	24	42	200	20	2320

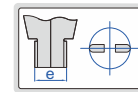
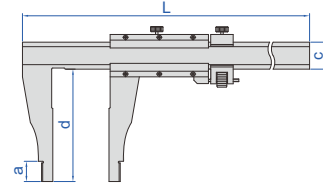

separate type (with screws)

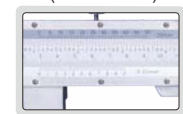

Graduation 0.05mm/1/128" (mm)

Code	Range	Accuracy	a	c	d	e	L
1214-6004	0-600mm/0-24"	±0.08mm	18	24	100	20	770
1214-1004	0-1000mm/0-40"	±0.12mm	24	32	140	20	1216

## LONG JAW VERNIER CALIPERS (SEPARATE TYPE)

- With fine adjustment
- Made of stainless steel
- Satin chrome plated reading surface



1215-1032

Graduation 0.02mm/0.001" (mm)

Code	Range	Accuracy	a	c	d	e	L
1215-392	0-300mm/0-12"	±0.05mm	10	17	90	10	410
1215-322	0-300mm/0-12"	±0.05mm	18	24	150	20	470
1215-522	0-500mm/0-20"	±0.06mm	18	24	150	20	670
1215-532	0-500mm/0-20"	±0.06mm	18	24	200	20	670
1215-622	0-600mm/0-24"	±0.06mm	18	24	150	20	770
1215-642	0-600mm/0-24"	±0.08mm	24	32	250	20	870
1215-822	0-800mm/0-32"	±0.07mm	24	32	150	20	1020
1215-832	0-800mm/0-32"	±0.07mm	24	32	200	20	1020
1215-1032	0-1000mm/0-40"	±0.08mm	24	32	200	20	1220
1215-1052	0-1000mm/0-40"	±0.11mm	24	42	300	20	1330
1215-3052	0-3000mm/0-120"	±0.26mm	24	50	300	20	3360

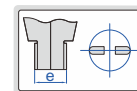
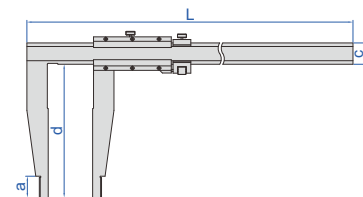

separate type (with screws)

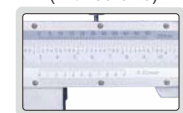

Graduation 0.05mm/1/128" (mm)

Code	Range	Accuracy	a	c	d	e	L
1215-524	0-500mm/0-20"	±0.08mm	18	24	150	20	670
1215-1034	0-1000mm/0-40"	±0.12mm	24	32	200	20	1330

## DEPTH BASE ATTACHMENTS

2

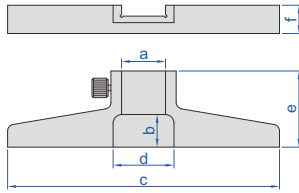

6140



6140-16B

- To increase the stability of depth measurement
- Suitable for digital calipers and dial calipers
- Made of stainless steel

							(mm)	
Code	a	b	c	d	e	f	Type	Application
6140	16.5	9	75	18	30	6	narrow base (f=6)	suitable for calipers with beam width (w) 16mm
6140-300A	20	15	125	22	34	9	narrow base (f=9)	suitable for calipers with beam width (w) 20mm
6140-16B	16	12.5	75	24.5	30	11	wide base (f=11), high stability	suitable for calipers with beam width (w) 16mm
6140-300B	20	15	125	28	35	13	wide base (f=13), high stability	suitable for calipers with beam width (w) 20mm

## CALIPER/HEIGHT GAGE CHECKERS

REFER TO PAGE 332  
FOR DETAILS

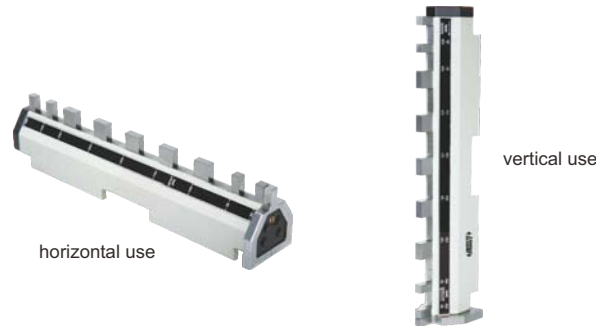

horizontal use

vertical use

6884-300

## CALIPER END GRINDING MACHINE CODE 6309



VIDEO

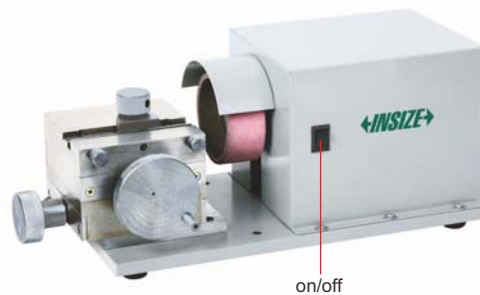

on/off

- Used for grinding the depth measuring surface of the end of calipers

### SPECIFICATION

Power supply	220V, 50/60Hz
Dimension (L×W×H)	370×200×160mm
Weight	15kg

application



REFER TO PAGE 162 FOR DETAILS

### CALIPER/MICROMETER LAPPING MACHINE CODE 6318



lapping measuring surfaces of caliper lower jaws



- For lapping measuring surfaces of caliper lower jaws



### ACCESSORY SET FOR DIGITAL CALIPERS CODE 6144

**6144**

	disk points (stainless steel)	conical points (stainless steel)	spherical/flat points (stainless steel)

- Suitable for 0-150mm/0-6" and 0-200mm/0-8" digital calipers (thickness of lower jaws ≤ 3.7mm)

**Code**  
**6144**

**ACCESSORY SET FOR LARGE DIGITAL CALIPERS  
CODE 6145-500**



6145-500

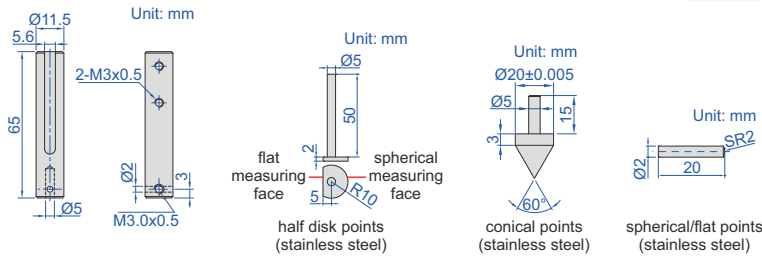

■ Suitable for 0-500mm/0-20" and 0-600mm/0-24" digital calipers (thickness of lower jaws ≤ 5.6mm)

**Code**  
**6145-500**

**ACCESSORY SET FOR LARGE DIGITAL CALIPERS (WITH SIDE POINTS)  
CODE 6146-500B**



6146-500B

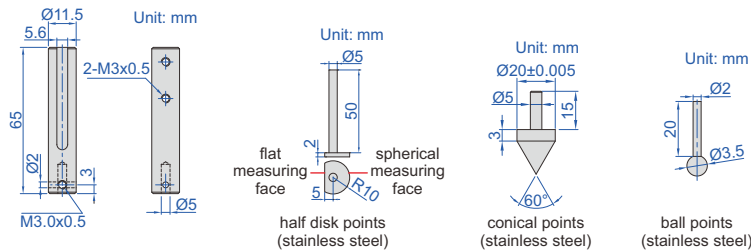

■ Suitable for 0-500mm/0-20" and 0-600mm/0-24" digital calipers (thickness of lower jaws ≤ 5.6mm)

**Code**  
**6146-500B**

# UNIVERSAL CALIPERS



DATA OUTPUT



1125-600

- Non waterproof
- Buttons: on/off, set, mm/inch, ABS, preset (+, -)
- Automatic power off, move the digital unit to turn on power
- Battery CR2032
- Made of stainless steel

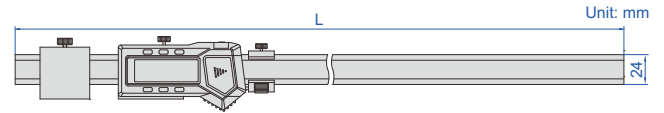

With data interface (data output cable code 7315-22 need receiver page 4, 7302-22 page 12, optional)

Code	Range *	Resolution	Accuracy	L
1125-600	0-600mm/0-24"	0.01mm/0.0005"	±0.05mm	778mm
1125-1000	0-1000mm/0-40"	0.01mm/0.0005"	±0.07mm	1205mm

Built-in wireless (receiver code 7315-2/3/6/7/8/9 is required)

Code	Range *	Resolution	Accuracy	L
1125-600WL	0-600mm/0-24"	0.01mm/0.0005"	±0.05mm	778mm
1125-1000WL	0-1000mm/0-40"	0.01mm/0.0005"	±0.07mm	1205mm

\*The range changes according to different points

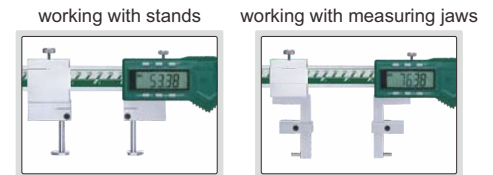

## Half disk points (included)

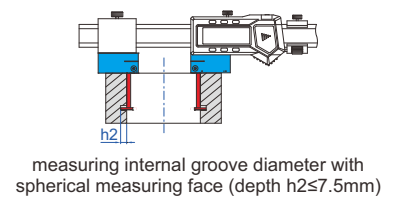
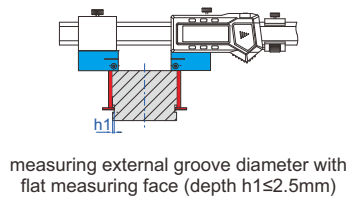
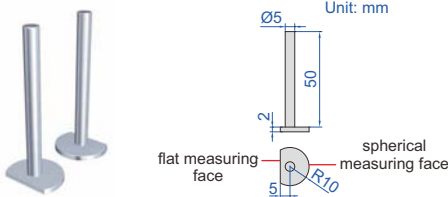

## Conical points (optional)

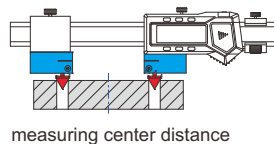
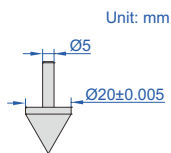

Code  
1125-T101

## Round shoulder points (optional)

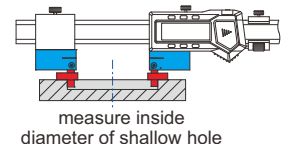
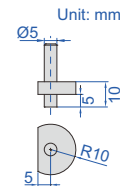

Code  
1125-T102

## Flat shoulder points (optional)

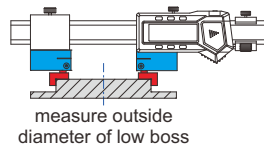
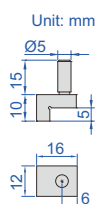

Code  
1125-T103

## Spherical points (included)

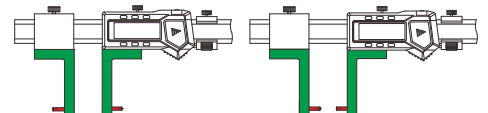
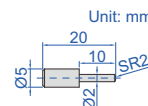

## Point sleeve (optional)

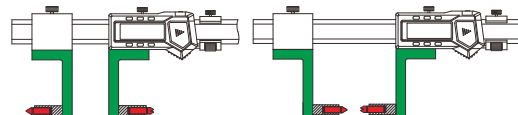

working with multifunctional points, ball points and screw thread points

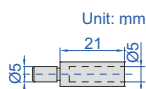

Code  
1125-T104

## Stands (included)

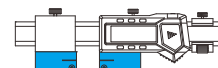
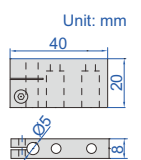

To be continued

Continued from previous page

**Depth stop (included)**

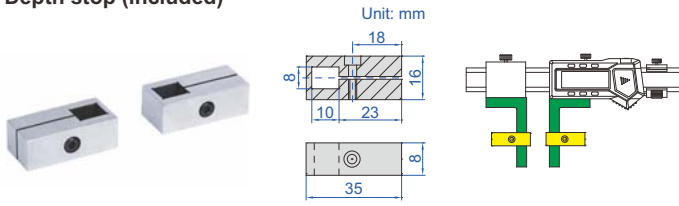

**Measuring jaws (included)**

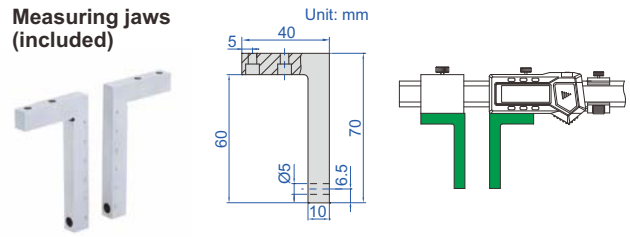

**Multifunctional points 7392\* (optional, page 39)**



\*It is necessary to use point sleeve (code 1125-T104) for these points

**Ball points 7391\* (optional, page 39)**



**Screw thread points 7381\*, 7321\* (optional, page 39)**



## DIGITAL CALIPERS WITH INTERCHANGEABLE POINTS

DATA OUTPUT



1526-200

- Non waterproof
- Supplied with 3 pairs of points and zero setting block for external measurement
- Resolution: 0.01mm/0.0005"
- Buttons: on/off, set, mm/inch, preset (+, -)
- Automatic power off, move the digital unit to turn on power
- Battery CR2032
- Made of stainless steel
- Optional accessory: points

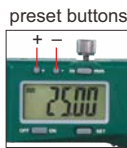

**short spherical points (included)** Unit: mm



**long spherical/flat points (included)** Unit: mm



**spherical blade points (included)** Unit: mm

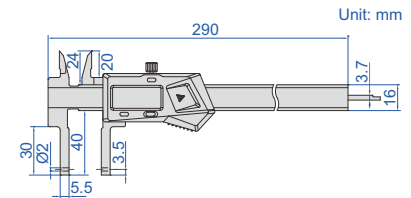

**With data interface**

Code	Data output cable (optional)
1526-200	code 7315-21 need receiver page 4, 7302-21 page 12

Built-in wireless	
Code	Receiver (optional)
1526-200WL	code 7315-2/3/6/7/8/9

Point	Range	Accuracy	Application
short spherical points	12-212mm/0.5-8.5" (internal)	±0.03mm	for grooves inside small hole
long spherical/flat points	24-224mm/1-8.8" (internal) 0-187mm/0-7.5" (external)	±0.03mm	spherical points for grooves inside hole flat points for external grooves
spherical blade points	24-224mm/1-8.8" (internal) 0-187mm/0-7.5" (external)	±0.03mm	for narrow grooves inside hole



zero setting block for external measurement (included)



install points

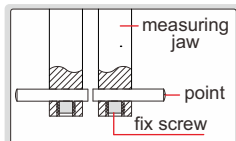

measure internal and external grooves

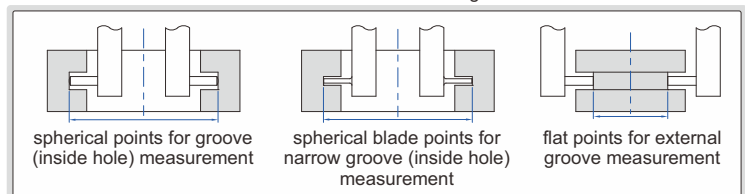

To be continued

Continued from previous page

### Depth stop (optional)

**Code**  
**6143**

Unit: mm

**6143**

for external groove measurement

for internal groove measurement

### Point sleeve (optional)

**1526-T101**

Unit: mm

installation

**Code**  
**1526-T101**

### Ball points (optional)

**7391-T5**

Unit: mm

\* It is necessary to use point sleeve (code **1526-T101**) for these points

\*\* Range of **1526-200** and **1526-200WL** after installing the points and point sleeve

Code	Ball dia. (D)	Range**
<b>7391-T3*</b>	SØ2.0mm	75-275mm/3.0-10.8" (internal) 0-146mm/0-5.7" (external)
<b>7391-T4*</b>	SØ2.5mm	76-276mm/3.0-10.8" (internal) 0-145mm/0-5.7" (external)
<b>7391-T5*</b>	SØ3.0mm	77-277mm/3.0-10.9" (internal) 0-144mm/0-5.6" (external)
<b>7391-T6*</b>	SØ3.5mm	78-278mm/3.1-10.9" (internal) 0-143mm/0-5.6" (external)
<b>7391-T7*</b>	SØ4.0mm	79-279mm/3.1-10.9" (internal) 0-142mm/0-5.6" (external)
<b>7391-T8*</b>	SØ4.5mm	80-280mm/3.2-11.0" (internal) 0-141mm/0-5.5" (external)
<b>7391-T9*</b>	SØ5.0mm	81-281mm/3.2-11.0" (internal) 0-140mm/0-5.5" (external)
<b>7391-T10*</b>	SØ6.0mm	83-283mm/3.3-11.1" (internal) 0-138mm/0-5.4" (external)

### Multifunctional points (optional)

**7392-T1**

Ø6.5

**7392-T4**

Ø12

**7392-T7**

Unit: mm  
Ø0.3  
60°

**7392-T2**

SR5  
Ø6.5

**7392-T5**

0.7

**7392-T8**

0.35  
55°

**7392-T3**

Ø2

**7392-T6**

0.35  
60°

**7392-T9**

Ø0.3  
55°

Code	Type
<b>7392-T1*</b>	flat
<b>7392-T2*</b>	spherical
<b>7392-T3*</b>	spline
<b>7392-T4*</b>	disk
<b>7392-T5*</b>	blade
<b>7392-T6*</b>	knife-edge point
<b>7392-T7*</b>	point
<b>7392-T8*</b>	knife-edge point
<b>7392-T9*</b>	point

\* It is necessary to use point sleeve (code **1526-T101**) for these points

**Range\*\***  
66-266mm/2.6-10.5" (internal), 0-155mm/0-6.1" (external)

\*\* Range of **1526-200** and **1526-200WL** after installing the points and point sleeve

### Screw thread points (optional)

**7321-T16**

Unit: mm  
Ø5  
Ø5  
60°

**7381-T11**

Unit: mm  
Ø5  
Ø5  
60°

#### Internal thread (60° thread angle)

Code	Pitch
<b>7321-T11*</b>	0.4-0.5mm/64-48TPI
<b>7321-T12*</b>	0.6-0.9mm/44-28TPI
<b>7321-T13*</b>	1-1.75mm/24-14TPI
<b>7321-T14*</b>	2-3mm/13-9TPI
<b>7321-T15*</b>	3.5-5mm/8-5TPI
<b>7321-T16*</b>	5.5-7mm/4.5-3.5TPI
<b>7321-T1S*</b>	6 pairs/set, including all above points

#### External thread (60° thread angle)

Code	Pitch
<b>7381-T11*</b>	0.4-0.5mm/64-48TPI
<b>7381-T12*</b>	0.6-0.9mm/44-28TPI
<b>7381-T13*</b>	1-1.75mm/24-14TPI
<b>7381-T14*</b>	2-3mm/13-9TPI
<b>7381-T15*</b>	3.5-5mm/8-5TPI
<b>7381-T16*</b>	5.5-7mm/4.5-3.5TPI
<b>7381-TS*</b>	6 pairs/set, including all above points

**Range\*\***  
66-266mm/2.6-10.5" (internal)  
0-155mm/0-6.1" (external)

\*\* Range of **1526-200** and **1526-200WL** after installing the points and point sleeve

\* It is necessary to use point sleeve (code **1526-T101**) for these points

## DIGITAL CALIPERS WITH INTERCHANGEABLE POINTS

DATA  
OUTPUT



2

short spherical/flat points (included) Unit: mm

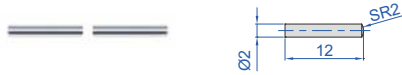

long spherical/flat points (included) Unit: mm



short spherical blade points (included) Unit: mm

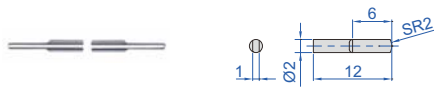

long spherical blade points (included) Unit: mm

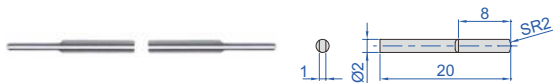

1124-300A

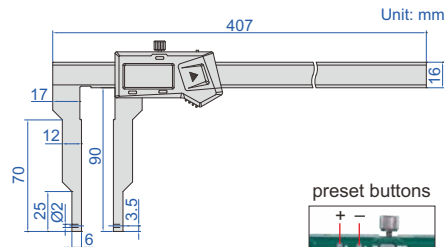

zero setting block for external measurement (included)



preset buttons



measure internal and external grooves

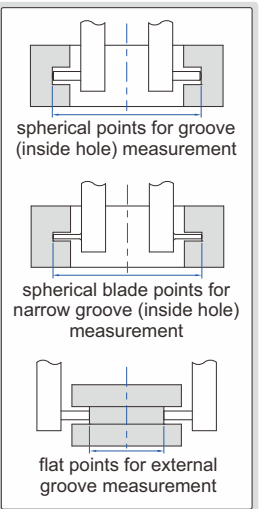

- Non waterproof
- Supplied with 4 pairs of points and zero setting block for external measurement
- Resolution: 0.01mm/0.0005"
- Buttons: on/off, set, mm/inch, preset (+, -)
- Automatic power off, move the digital unit to turn on power
- Battery CR2032
- Made of stainless steel
- Optional accessory: points (code 1526-T101, 7392, 7391, 7381, 7321), depth stop (code 6143)

install points

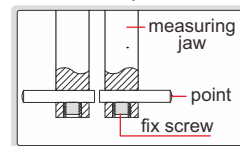

depth stop 6143 (optional)



With data interface

Code	Data output cable (optional)
1124-300A	code 7315-21 need receiver page 4, 7302-21 page 12

Built-in wireless

Code	Receiver (optional)
1124-300AWL	code 7315-2/3/6/7/8/9

Point	Range	Accuracy	Application
short spherical/flat points	24-324mm/1-12.7" (internal) 0-288mm/0-11.3" (external)	±0.04mm	spherical points for grooves inside hole (small hole) flat points for external grooves
long spherical/flat points	40-340mm/1.5-13.3" (internal) 0-272mm/0-10.7" (external)	±0.04mm	spherical points for grooves inside hole (large hole) flat points for external grooves
short spherical blade points	24-324mm/1-12.7" (internal) 0-288mm/0-11.3" (external)	±0.04mm	for narrow grooves inside hole (small hole)
long spherical blade points	40-340mm/1.5-13.3" (internal) 0-272mm/0-10.7" (external)	±0.04mm	for narrow grooves inside hole (large hole)

Multifunctional points 7392\* (optional, page 39)

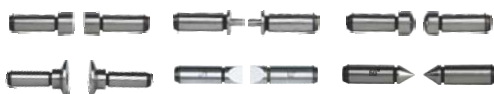

Ball points 7391\* (optional, page 39)



Screw thread points 7381\*, 7321\* (optional, page 39)



\* It is necessary to use point sleeve (code 1526-T101) for these points



DATA OUTPUT

VARIOUS POINTS ARE AVAILABLE (PAGE 250~252)

DIGITAL CALIPERS WITH INTERCHANGEABLE POINTS



preset buttons



1530-300

- Non waterproof
- Supplied with 4 pairs of points and zero setting block for external measurement
- Resolution: 0.01mm/0.0005"
- Buttons: on/off, set, mm/inch, preset (+, -)
- Automatic power off, move the digital unit to turn on power
- Battery CR2032
- Made of stainless steel
- Optional accessory: points (page 250~252), depth stop (code 6143)

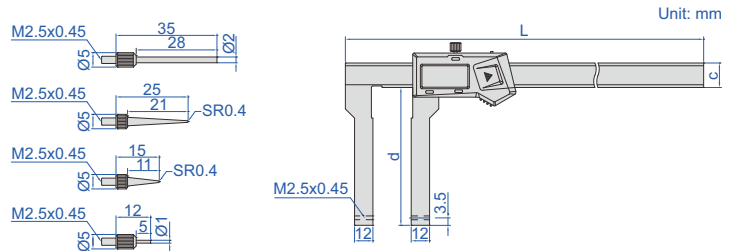

measure internal and external grooves

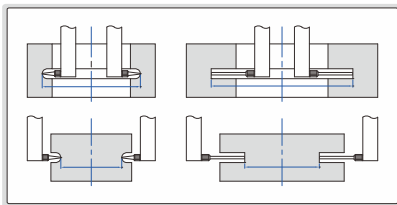

4 pairs of points (included)

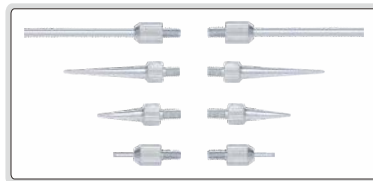

zero setting block for external measurement (included)



depth stop 6143 (optional)



(mm)

Code	Range*	Accuracy	L	d	c	Data output cable (optional)
1530-300	0-300mm/0-12"	±0.06mm	407	90	16	7315-21 need receiver page 4, 7302-21 page 12
1530-500	0-500mm/0-20"	±0.08mm	740	100	24	7315-22 need receiver page 4, 7302-22 page 12

Built-in wireless

(receiver code 7315-2/3/6/7/8/9 is required)

(mm)

Code	Range*	Accuracy	L	d	c
1530-300WL	0-300mm/0-12"	±0.06mm	407	90	16
1530-500WL	0-500mm/0-20"	±0.08mm	740	100	24

\*For different points, the measuring range changes accordingly

## DIGITAL INSIDE GROOVE CALIPERS

2

preset buttons



1520-150



1520-150P

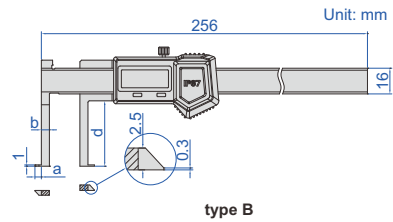
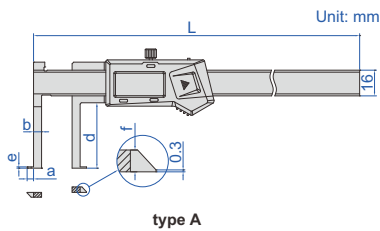

- Measure diameter of grooves inside small bores
- Resolution: 0.01mm/0.0005"
- Buttons type A: on/off, set, mm/inch, preset (+, -), type B: on/off, zero, mm/inch, ABS/REL, hold
- Battery CR2032
- Made of stainless steel
- Optional accessory: depth stop (code **6143**)

depth stop 6143  
(optional)

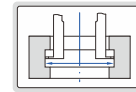

Non waterproof, with data interface (data output cable code 7315-21 need receiver page 4, 7302-21 page 12, optional)

Code	Range	Type	Accuracy	L	a	b	d	e	f
1520-150	11-150mm/0.43-6"	A	±0.04mm	236mm	3.5mm	5mm	41mm	1mm	2.5mm
1520-200	16-200mm/0.63-8"	A	±0.04mm	285mm	5mm	7mm	41mm	1mm	3mm
1520-300	20-300mm/0.79-12"	A	±0.05mm	398mm	7.5mm	9mm	62mm	2mm	4mm

Non waterproof, built-in wireless (receiver code 7315-2/3/6/7/8/9 is required)

Code	Range	Type	Accuracy	L	a	b	d	e	f
1520-150WL	11-150mm/0.43-6"	A	±0.04mm	236mm	3.5mm	5mm	41mm	1mm	2.5mm
1520-200WL	16-200mm/0.63-8"	A	±0.04mm	285mm	5mm	7mm	41mm	1mm	3mm
1520-300WL	20-300mm/0.79-12"	A	±0.05mm	398mm	7.5mm	9mm	62mm	2mm	4mm

IP67 dust/waterproof, no automatic power off, set zero after power on each time, without data interface

Code	Range	Type	Accuracy	a	b	d
1520-150P	14-150mm/0.56-6"	B	±0.04mm	5mm	7mm	30mm
1520-1501P	8-150mm/0.31-6"	B	±0.04mm	2mm	4mm	40mm

DATA  
OUTPUT

## DIGITAL INSIDE POINT CALIPERS

 depth stop 6143  
(optional)

preset buttons

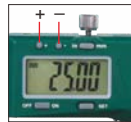
 1121-150A  
type A

 1121-150B  
type B

- Non waterproof
- Measure groove diameter
- Resolution: 0.01mm/0.0005"
- Buttons type A: on/off, set, mm/inch, preset (+, -)  
type B: on/off, zero, mm/inch
- Automatic power off, move the digital unit to turn on power
- Battery CR2032
- Data output
- Made of stainless steel
- Optional accessory: depth stop  
(code 6143, for calipers with c=16mm)

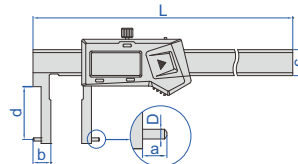
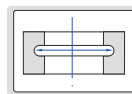

Preset (no need to add the width of the jaws on the reading), with data interface

(mm)

Code	Range	Type	Accuracy	L	a	b	c	d	D	Data output cable (optional)
1121-150A	24-150mm/0.94-6"	A	±0.04mm	250	5	12	16	28	Ø2	7315-21 need receiver page 4, 7302-21 page 12
1121-1501	35-150mm/1.38-6"	A	±0.05mm	250	6	17.5	16	60	Ø2	7315-21 need receiver page 4, 7302-21 page 12
1121-200A	25-200mm/0.98-8"	A	±0.04mm	310	5	12.5	16	37	Ø2	7315-21 need receiver page 4, 7302-21 page 12
1121-2001	40-200mm/1.57-8"	A	±0.05mm	310	7	20	16	70	Ø3	7315-21 need receiver page 4, 7302-21 page 12
1121-300A	30-300mm/1.18-12"	A	±0.07mm	410	5	15	16	50	Ø2	7315-21 need receiver page 4, 7302-21 page 12
1121-3001A	50-300mm/1.97-12"	A	±0.07mm	410	8	25	16	77	Ø3	7315-21 need receiver page 4, 7302-21 page 12
1121-500A	40-500mm/1.57-20"	A	±0.07mm	680	5	20	24	90	Ø3	7315-22 need receiver page 4, 7302-22 page 12
1121-5001	60-500mm/2.36-20"	A	±0.08mm	680	10	30	24	120	Ø3	7315-22 need receiver page 4, 7302-22 page 12
1121-5002	80-500mm/3.15-20"	A	±0.08mm	680	16	40	24	150	Ø3	7315-22 need receiver page 4, 7302-22 page 12

Preset (no need to add the width of the jaws on the reading), built-in wireless (receiver code 7315-2/3/6/7/8/9 is required)

Code	Range	Type	Accuracy	L	a	b	c	d	D
1121-150AWL	24-150mm/0.94-6"	A	±0.04mm	250mm	5mm	12mm	16mm	28mm	Ø2mm
1121-1501WL	35-150mm/1.38-6"	A	±0.05mm	250mm	6mm	17.5mm	16mm	60mm	Ø2mm
1121-200AWL	25-200mm/0.98-8"	A	±0.04mm	310mm	5mm	12.5mm	16mm	37mm	Ø2mm
1121-2001WL	40-200mm/1.57-8"	A	±0.05mm	310mm	7mm	20mm	16mm	70mm	Ø3mm
1121-300AWL	30-300mm/1.18-12"	A	±0.07mm	410mm	5mm	15mm	16mm	50mm	Ø2mm
1121-3001AWL	50-300mm/1.97-12"	A	±0.07mm	410mm	8mm	25mm	16mm	77mm	Ø3mm
1121-500AWL	40-500mm/1.57-20"	A	±0.07mm	680mm	5mm	20mm	24mm	90mm	Ø3mm
1121-5001WL	60-500mm/2.36-20"	A	±0.08mm	680mm	10mm	30mm	24mm	120mm	Ø3mm
1121-5002WL	80-500mm/3.15-20"	A	±0.08mm	680mm	16mm	40mm	24mm	150mm	Ø3mm

No preset (need to add the width of the jaws on the reading)

Code	Range	Type	Accuracy	L	a	b	c	d	D
1121-150B	50-150mm/1.97-6"	B	±0.06mm	270mm	8mm	25mm	20mm	90mm	Ø3mm
1121-200B	60-200mm/2.36-8"	B	±0.06mm	320mm	10mm	30mm	20mm	100mm	Ø3mm
1121-300B	60-300mm/2.36-12"	B	±0.07mm	420mm	10mm	30mm	20mm	110mm	Ø3mm

## DIGITAL INSIDE GROOVE CALIPERS

depth stop 6143  
(optional)



2

- Measure groove diameter
- Resolution: 0.01mm/0.0005"
- Buttons type A: on/off, set, mm/inch, preset (+, -)  
type B: on/off, zero, mm/inch  
type C: on/off, zero, mm/inch, ABS/REL, hold
- Battery CR2032
- Made of stainless steel
- Optional accessory: depth stop  
(code 6143, for calipers with c=16mm)

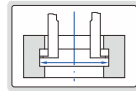
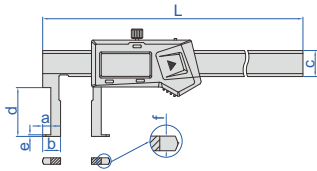

preset buttons



1120-150A  
type A



1120-150B  
type B



1120-150P  
type C

Non waterproof, preset (no need to add the width of the jaws on the reading), with data interface

(mm)

Code	Range	Type	Accuracy	L	a	b	c	d	e	f	Data output cable (optional)
1120-150A	22-150mm/0.87-6"	A	±0.04mm	250	5	11	16	30	1	4	7315-21 need receiver page 4, 7302-21 page 12
1120-1501	35-150mm/1.38-6"	A	±0.06mm	250	6	17.5	16	60	1.5	4	7315-21 need receiver page 4, 7302-21 page 12
1120-200A	25-200mm/0.98-8"	A	±0.04mm	310	5	12.5	16	40	1	4	7315-21 need receiver page 4, 7302-21 page 12
1120-2001	40-200mm/1.57-8"	A	±0.06mm	310	7	20	16	70	2.5	4	7315-21 need receiver page 4, 7302-21 page 12
1120-300A	30-300mm/1.18-12"	A	±0.05mm	410	5	15	16	50	1.5	4	7315-21 need receiver page 4, 7302-21 page 12
1120-3001	50-300mm/1.97-12"	A	±0.07mm	410	8	25	16	80	2.5	4	7315-21 need receiver page 4, 7302-21 page 12
1120-500	40-500mm/1.57-20"	A	±0.07mm	680	5	20	24	90	2.2	5.5	7315-22 need receiver page 4, 7302-22 page 12
1120-5001	60-500mm/2.36-20"	A	±0.08mm	680	10	30	24	120	3.4	5.5	7315-22 need receiver page 4, 7302-22 page 12
1120-5002	80-500mm/3.15-20"	A	±0.08mm	680	16	40	24	150	5.2	5.5	7315-22 need receiver page 4, 7302-22 page 12

Non waterproof, preset (no need to add the width of the jaws on the reading),  
built-in wireless (receiver code 7315-2/3/6/7/8/9 is required)

Code	Range	Type	Accuracy	L	a	b	c	d	e	f
1120-150AWL	22-150mm/0.87-6"	A	±0.04mm	250mm	5mm	11mm	16mm	30mm	1mm	4mm
1120-1501WL	35-150mm/1.38-6"	A	±0.06mm	250mm	6mm	17.5mm	16mm	60mm	1.5mm	4mm
1120-200AWL	25-200mm/0.98-8"	A	±0.04mm	310mm	5mm	12.5mm	16mm	40mm	1mm	4mm
1120-2001WL	40-200mm/1.57-8"	A	±0.06mm	310mm	7mm	20mm	16mm	70mm	2.5mm	4mm
1120-300AWL	30-300mm/1.18-12"	A	±0.05mm	410mm	5mm	15mm	16mm	50mm	1.5mm	4mm
1120-3001WL	50-300mm/1.97-12"	A	±0.07mm	410mm	8mm	25mm	16mm	80mm	2.5mm	4mm
1120-500WL	40-500mm/1.57-20"	A	±0.07mm	680mm	5mm	20mm	24mm	90mm	2.2mm	5.5mm
1120-5001WL	60-500mm/2.36-20"	A	±0.08mm	680mm	10mm	30mm	24mm	120mm	3.4mm	5.5mm
1120-5002WL	80-500mm/3.15-20"	A	±0.08mm	680mm	16mm	40mm	24mm	150mm	5.2mm	5.5mm

Non waterproof, no preset (need to add the width of the jaws on the reading)

Code	Range	Type	Accuracy	L	a	b	c	d	e	f
1120-150B	50-150mm/1.97-6"	B	±0.06mm	270mm	8mm	25mm	20mm	90mm	3.4mm	4mm
1120-200B	60-200mm/2.36-8"	B	±0.06mm	320mm	10mm	30mm	20mm	100mm	3.4mm	4mm
1120-300B	60-300mm/2.36-12"	B	±0.07mm	420mm	10mm	30mm	20mm	110mm	3.4mm	4mm

IP67 dust/waterproof, no automatic power off, set zero after power on each time,  
no preset (need to add the width of the jaws on the reading), without data interface

Code	Range	Type	Accuracy	L	a	b	c	d	e	f
1120-150P	22-150mm/0.87-6"	C	±0.04mm	250mm	5mm	11mm	16mm	30mm	1mm	4mm

## INSIDE GROOVE VERNIER CALIPER

- Measure diameter of grooves inside bores
- Made of stainless steel
- Satin chrome plated reading surface



1262-150A

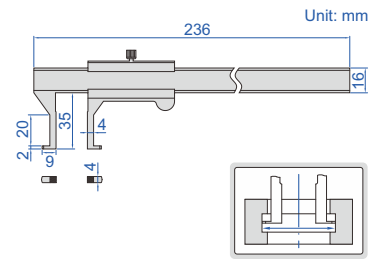

Code	Range	Graduation	Accuracy
1262-150A	18-150mm	0.02mm	±0.04mm

## DIGITAL INSIDE GROOVE CALIPERS

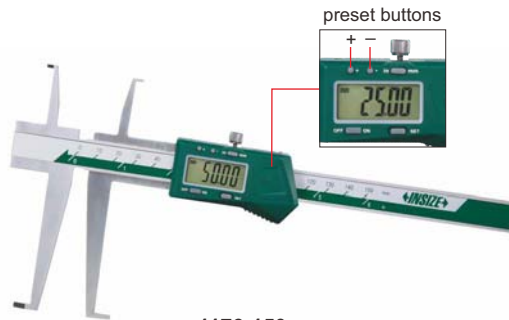

1176-150



1176-150P

depth stop 6143 (optional)

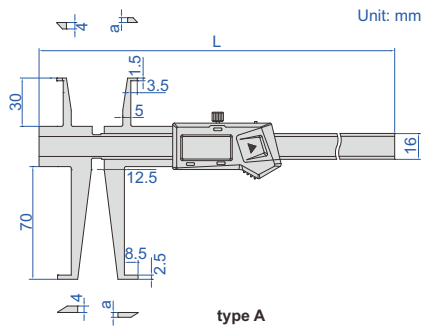

type A

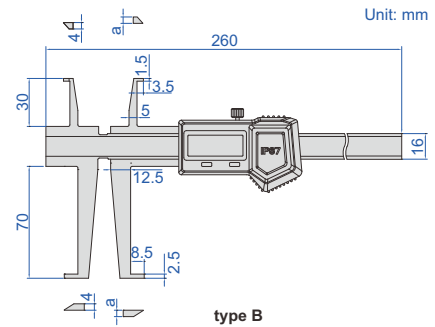

type B

- Measure diameter of grooves inside bores
- Resolution: 0.01mm/0.0005"
- Buttons type A: on/off, set, mm/inch, preset (+, -)  
type B: on/off, zero, mm/inch, ABS/REL, hold
- Battery CR2032
- Made of stainless steel
- Optional accessory: depth stop (code 6143)

sizes to be measured (use upper jaws)

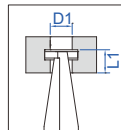

D1	L1
Ø9	<8
Ø10	<15
Ø11~200	<30

sizes to be measured (use lower jaws)

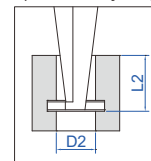

	(mm)	
	D2	L2
	Ø17	<16
	Ø18	<28
	Ø19	<40
	Ø20	<50
	Ø21	<58
	Ø22~200	<70

Non waterproof, with data interface

(data output cable code 7315-21 need receiver page 4, 7302-21 page 12, optional)

Code	Range of upper jaw	Range of lower jaw	Type	Accuracy	L	a
1176-150	9-150mm/0.35-6"	17-150mm/0.70-6"	A	±0.04mm	260mm	3mm
1176-200	9-200mm/0.35-8"	17-200mm/0.70-8"	A	±0.05mm	320mm	3.5mm

Non waterproof, built-in wireless (receiver code 7315-2/3/6/7/8/9 is required)

Code	Range of upper jaw	Range of lower jaw	Type	Accuracy	L	a
1176-150WL	9-150mm/0.35-6"	17-150mm/0.70-6"	A	±0.04mm	260mm	3mm
1176-200WL	9-200mm/0.35-8"	17-200mm/0.70-8"	A	±0.05mm	320mm	3.5mm

IP67 dust/waterproof, without data interface, no automatic power off, set zero after power on each time

Code	Range of upper jaw	Range of lower jaw	Type	Accuracy	a
1176-150P	9-150mm/0.35-6"	17-150mm/0.70-6"	B	±0.04mm	4mm

## INSIDE GROOVE CALIPERS



1199-150

depth stop 6143 (optional)



- Measure diameter of grooves inside bores
- Graduation: 0.02mm
- Made of stainless steel
- Optional accessory: depth stop (code 6143)

Code	Range of upper jaw	Range of lower jaw	Accuracy	L	a	b
1199-150	9-150mm	18-150mm	±0.04mm	248mm	1.6mm	2.5mm
1199-200	9-200mm	18-200mm	±0.05mm	298mm	1.8mm	2.8mm
1199-300	9-300mm	18-300mm	±0.06mm	398mm	2.0mm	3.0mm

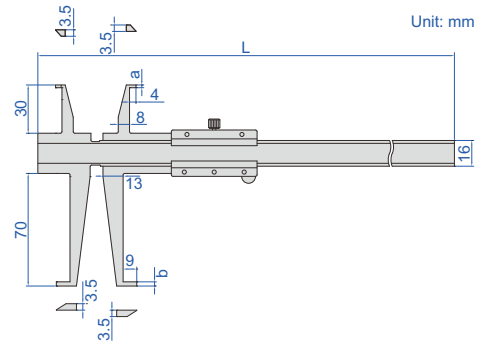

sizes to be measured (use upper jaws)

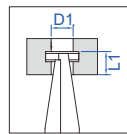

(mm)	
D1	L1
Ø9	<8
Ø10	<12
Ø11	<15
Ø12	<20
Ø13-300	<30

sizes to be measured (use lower jaws)

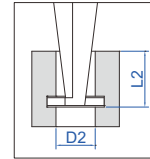

(mm)	
D2	L2
Ø18	<30
Ø19	<40
Ø20	<45
Ø21	<55
Ø22	<60
Ø23-300	<70

## INSIDE GROOVE DIAL CALIPERS

SHOCK PROOF

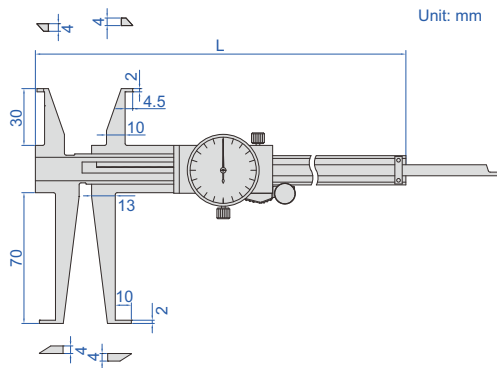

1376-150

- Measure diameter of grooves inside bores
- Shockproof dial indicator
- Dial indicator graduation: 0.02mm
- Made of stainless steel
- Optional accessory: depth stop (code 6143)

Code	Range of upper jaw	Range of lower jaw	Accuracy	L
1376-150	11-150mm	18-150mm	±0.03mm	240mm
1376-200	11-200mm	18-200mm	±0.03mm	290mm
1376-300	11-300mm	18-300mm	±0.04mm	390mm

sizes to be measured (use upper jaws)

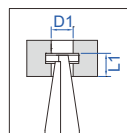

(mm)	
D1	L1
Ø11	<8
Ø12	<10
Ø13	<15
Ø14	<20
Ø15-300	<30

sizes to be measured (use lower jaws)

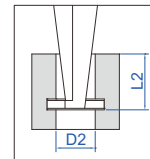

(mm)	
D2	L2
Ø18	<20
Ø19	<28
Ø20	<35
Ø21	<40
Ø22	<50
Ø23-300	<70

DATA  
OUTPUT

## DIGITAL DEEP HOLE INSIDE GROOVE CALIPERS

preset buttons



1129-300

Unit: mm

- Non waterproof
- Measure diameter of grooves inside deep holes
- Resolution: 0.01mm/0.0005"
- Buttons: on/off, set, mm/inch, preset (+, -)
- Automatic power off, move the digital unit to turn on power
- Battery CR2032
- Made of stainless steel
- Optional accessory: depth stop (code 6143)

depth stop 6143 (optional)

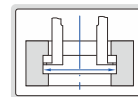
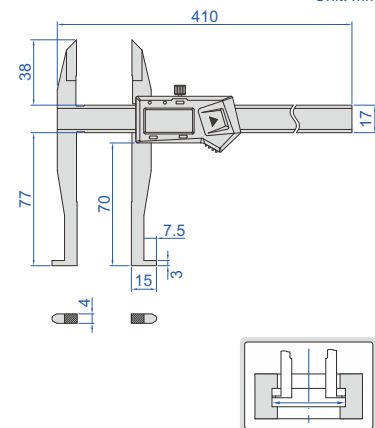

With data interface (data output cable code 7315-21 need receiver page 4, 7302-21 page 12, optional)

Code	Range of upper jaw	Range of lower jaw	Accuracy
1129-300	0-300mm/0-12"	30-300mm/1.2-12"	±0.06mm

Built-in wireless (receiver code 7315-2/3/6/7/8/9 is required)

Code	Range of upper jaw	Range of lower jaw	Accuracy
1129-300WL	0-300mm/0-12"	30-300mm/1.2-12"	±0.06mm

 DATA  
OUTPUT

## DIGITAL INSIDE GROOVE CALIPERS

- Non waterproof
- Measure diameter or distance of grooves
- Resolution: 0.01mm/0.0005"
- Buttons: on/off, set, mm/inch, preset (+, -)
- Automatic power off, move the digital unit to turn on power
- Battery CR2032
- Made of stainless steel



1128-200

Unit: mm

With data interface (data output cable code 7315-21 need receiver page 4, 7302-21 page 12, optional)

Code	Range of upper jaw	Range of lower jaw	Accuracy
1128-200	10-200mm/0.39-8"	3-200mm/0.12-8"	±0.03mm

Built-in wireless (receiver code 7315-2/3/6/7/8/9 is required)

Code	Range of upper jaw	Range of lower jaw	Accuracy
1128-200WL	10-200mm/0.39-8"	3-200mm/0.12-8"	±0.03mm

preset buttons

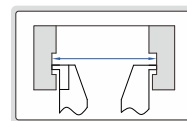
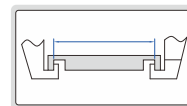
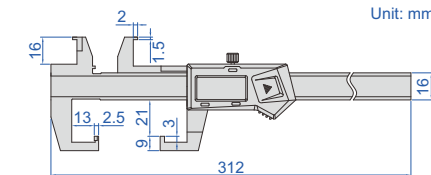
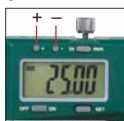

## DIGITAL INSIDE GROOVE CALIPERS

2

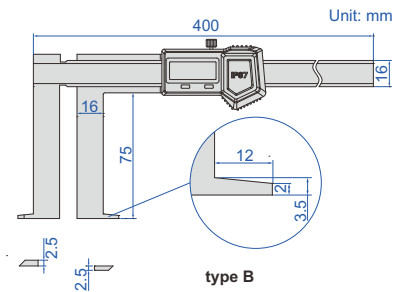
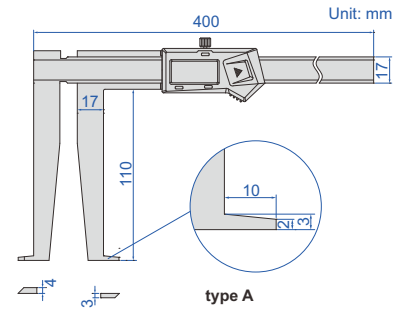
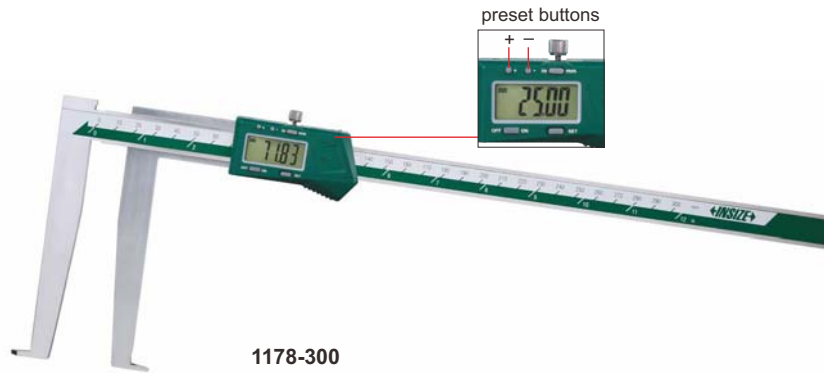

- Measure diameter of grooves inside bores
- Resolution: 0.01mm/0.0005"
- Buttons type A: on/off, set, mm/inch, preset (+, -)  
type B: on/off, zero, mm/inch, ABS/REL, hold
- Battery CR2032
- Made of stainless steel
- Optional accessory: depth stop (code 6143)

depth stop 6143  
(optional)



Non waterproof, built-in wireless  
(receiver code 7315-2/3/6/7/8/9 is required)

Code	Range	Type	Accuracy
1178-300WL	25-300mm/1.18-12"	A	±0.05mm

Non waterproof, with data interface (data output cable  
code 7315-21 need receiver page 4, 7302-21 page 12, optional)

Code	Range	Type	Accuracy
1178-300	25-300mm/1.18-12"	A	±0.05mm

IP67 dust/waterproof, no automatic power off, set zero  
after power on each time, without data interface

Code	Range	Type	Accuracy
1178-300P	33-300mm/1.30-12"	B	±0.05mm



DATA  
OUTPUT

## DIGITAL INSIDE GROOVE CALIPERS



1191-150

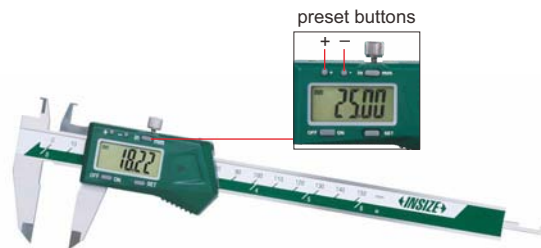

1191-150B

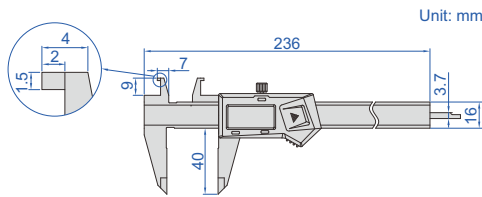

type A

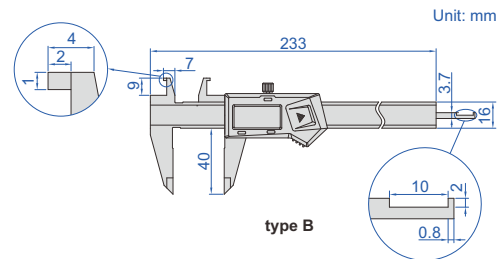

type B

- Non waterproof
- Upper jaws for measuring diameter of grooves
- Resolution: 0.01mm/0.0005"
- Buttons type A: on/off, zero, mm/inch  
type B: on/off, set, mm/inch, preset (+, -)
- Automatic power off, move the digital unit to turn on power
- Battery CR2032
- Made of stainless steel

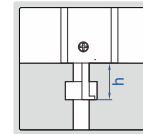
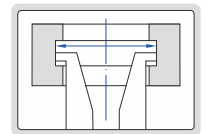
 measure depth of grooves  
(h<10mm, only for type B)

 measure diameter of  
grooves 8-150mm

## With data interface

(data output cable code 7315-21 need receiver page 4, 7302-21 page 12, optional)

Code	Range of upper jaw	Range of lower jaw	Accuracy	Type
1191-150	8-150mm/0.3-6"	0-150mm/0-6"	±0.03mm	A
1191-150B	8-150mm/0.3-6"	0-150mm/0-6"	±0.03mm	B

## Built-in wireless (receiver code 7315-2/3/6/7/8/9 is required)

Code	Range of upper jaw	Range of lower jaw	Accuracy	Type
1191-150WL	8-150mm/0.3-6"	0-150mm/0-6"	±0.03mm	A
1191-150BWL	8-150mm/0.3-6"	0-150mm/0-6"	±0.03mm	B

## INSIDE GROOVE VERNIER CALIPER

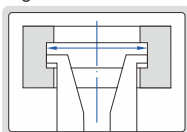
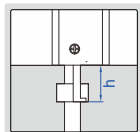
 measure diameter of  
grooves 8-150mm

 measure depth of  
grooves (h<10mm)

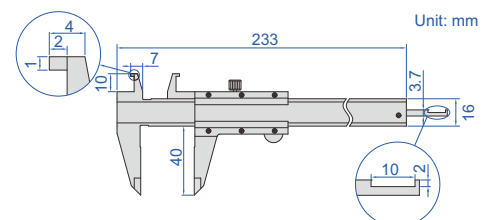
1291-150



- Graduation: 0.02mm
- Made of stainless steel
- Satin chrome plated reading surface

Code	Range of upper jaw	Range of lower jaw	Accuracy
1291-150	8-150mm	0-150mm	±0.03mm

## DIGITAL OUTSIDE NECK CALIPERS

DATA OUTPUT

- Non waterproof
- Measure grooves and recesses
- Resolution: 0.01mm/0.0005"
- Buttons: on/off, zero, mm/inch
- Automatic power off, move the digital unit to turn on power
- Battery CR2032
- Made of stainless steel
- Optional accessory: depth stop (code **6143**, for calipers with e=16mm)



1187-150A

depth stop 6143 (optional)

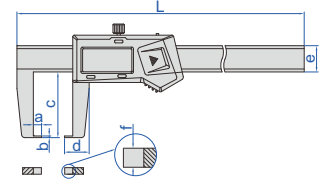
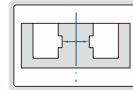

With data interface

(mm)

Code	Range	Accuracy	L	a	b	c	d	e	f	Data output cable (optional)
1187-150A	0-150mm/0-6"	±0.04mm	250	5	1	40	15	16	4	7315-21 need receiver page 4, 7302-21 page 12
1187-200A	0-200mm/0-8"	±0.05mm	310	9	1.5	80	23	16	4	7315-21 need receiver page 4, 7302-21 page 12
1187-300A	0-300mm/0-12"	±0.06mm	490	12	2	150	36	24	4	7315-22 need receiver page 4, 7302-22 page 12
1187-500A	0-500mm/0-20"	±0.07mm	690	12	2	150	36	24	5.5	7315-22 need receiver page 4, 7302-22 page 12

Built-in wireless (receiver code 7315-2/3/6/7/8/9 is required)

Code	Range	Accuracy	L	a	b	c	d	e	f
1187-150AWL	0-150mm/0-6"	±0.04mm	250mm	5mm	1mm	40mm	15mm	16mm	4mm
1187-200AWL	0-200mm/0-8"	±0.05mm	310mm	9mm	1.5mm	80mm	23mm	16mm	4mm
1187-300AWL	0-300mm/0-12"	±0.06mm	490mm	12mm	2mm	150mm	36mm	24mm	4mm
1187-500AWL	0-500mm/0-20"	±0.07mm	690mm	12mm	2mm	150mm	36mm	24mm	5.5mm

## DIGITAL OUTSIDE POINT CALIPERS

DATA OUTPUT

- Non waterproof
- Measure wall thickness inside bores and recesses
- Resolution: 0.01mm/0.0005"
- Buttons: on/off, zero, mm/inch
- Automatic power off, move the digital unit to turn on power
- Battery CR2032
- Made of stainless steel
- Optional accessory: depth stop (code **6143**)



1185-150A

depth stop 6143 (optional)

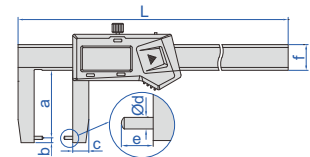
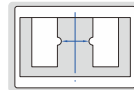

With data interface

(mm)

Code	Range	Accuracy	L	a	b	c	Ød	e	f	Data output cable (optional)
1185-150A	0-150mm/0-6"	±0.04mm	250	40	3	10	2	5	16	7315-21 need receiver page 4, 7302-21 page 12
1185-200A	0-200mm/0-8"	±0.05mm	310	80	3	14	3	9	16	7315-21 need receiver page 4, 7302-21 page 12
1185-300A	0-300mm/0-12"	±0.06mm	490	150	3	20	3	12	24	7315-22 need receiver page 4, 7302-22 page 12

Built-in wireless (receiver code 7315-2/3/6/7/8/9 is required)

(mm)

Code	Range	Accuracy	L	a	b	c	Ød	e	f
1185-150AWL	0-150mm/0-6"	±0.04mm	250	40	3	10	2	5	16
1185-200AWL	0-200mm/0-8"	±0.05mm	310	80	3	14	3	9	16
1185-300AWL	0-300mm/0-12"	±0.06mm	490	150	3	20	3	12	24

**DATA OUTPUT**
**DIGITAL OUTSIDE GROOVE CALIPERS**

- Non waterproof
- Measure grooves and recesses in small spaces
- Resolution: 0.01mm/0.0005"
- Buttons: on/off, zero, mm/inch
- Automatic power off, move the digital unit to turn on power
- Battery CR2032
- Made of stainless steel



**1535-100**

With data interface (data output cable code 7315-21 need receiver page 4, 7302-21 page 12, optional)

Code	Range	Accuracy
1535-100	0-100mm/0-4"	±0.03mm

Built-in wireless (receiver code 7315-2/3/6/7/8/9 is required)

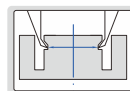
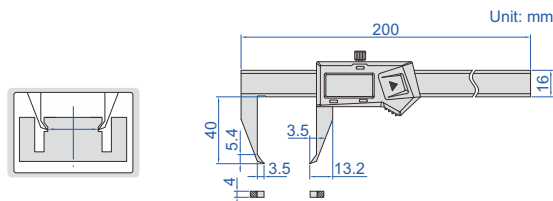
Code	Range	Accuracy
1535-100WL	0-100mm/0-4"	±0.03mm

**DEPTH STOP FOR CALIPERS**

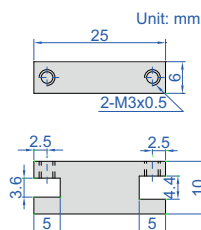
**6143**

- Supplied in pair
- Made of stainless steel
- Suitable for caliper series 1124, 1526, 1530, 1199, 1520, 1176, 1178, 1120, 1121, 1187, 1129, 1185 and 1376

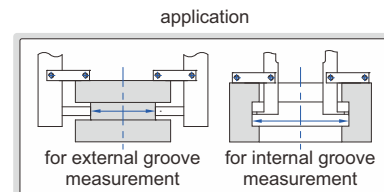
**Code 6143**

**DIGITAL SMALL POINT CALIPERS**

- Non waterproof
- Small pointed jaws fit into small grooves and recesses
- Resolution: 0.01mm/0.0005"
- Buttons: on/off, zero, mm/inch
- Automatic power off, move the digital unit to turn on power
- Battery CR2032
- Made of stainless steel

**DATA OUTPUT**

**1169-150**

With data interface (data output cable code 7315-21 need receiver page 4, 7302-21 page 12, optional)

Code	Range	Accuracy
1169-150	0-150mm/0-6"	±0.03mm

Built-in wireless (receiver code 7315-2/3/6/7/8/9 is required)

Code	Range	Accuracy
1169-150WL	0-150mm/0-6"	±0.03mm

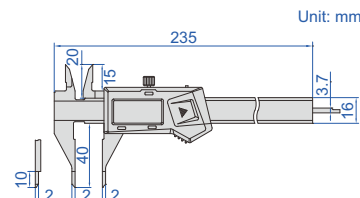
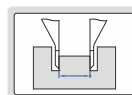

## DIGITAL POINT CALIPERS

DATA  
OUTPUT

2

- Non waterproof
- Pointed jaws fit into small grooves and recesses
- Resolution: 0.01mm/0.0005"
- Buttons: on/off, zero, mm/inch
- Automatic power off, move the digital unit to turn on power
- Battery CR2032
- Made of stainless steel



1183-150A

With data interface  
(data output cable code 7315-21 need receiver page 4, 7302-21 page 12, optional)

Code	Range	Accuracy	L	a	b	c
1183-150A	0-150mm/0-6"	±0.03mm	236mm	40mm	21mm	16.5mm
1183-200A	0-200mm/0-8"	±0.03mm	286mm	50mm	24mm	19.5mm
1183-300A	0-300mm/0-12"	±0.03mm	400mm	60mm	25mm	21.5mm

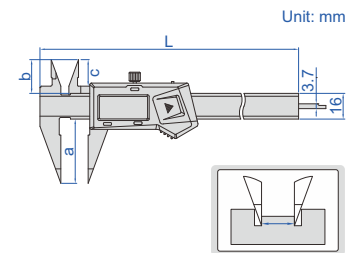

Built-in wireless (receiver code 7315-2/3/6/7/8/9 is required)

Code	Range	Accuracy	L	a	b	c
1183-150AWL	0-150mm/0-6"	±0.03mm	236mm	40mm	21mm	16.5mm
1183-200AWL	0-200mm/0-8"	±0.03mm	286mm	50mm	24mm	19.5mm
1183-300AWL	0-300mm/0-12"	±0.03mm	400mm	60mm	25mm	21.5mm

## DIGITAL BLADE CALIPERS

DATA  
OUTPUT



1188-150A

- Non waterproof
- The blade jaws fit into small grooves
- Resolution: 0.01mm/0.0005"
- Buttons: on/off, zero, mm/inch
- Automatic power off, move the digital unit to turn on power
- Battery CR2032
- Made of stainless steel

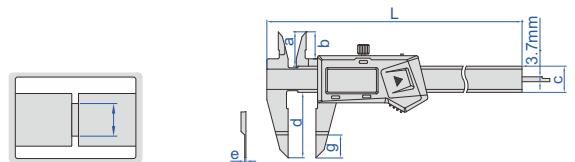

With data interface (data output cable code 7315-21 need receiver page 4, 7302-21 page 12, optional)

Code	Range	Accuracy	L	a	b	c	d	e	g
1188-150A	0-150mm/0-6"	±0.03mm	235mm	21mm	16.5mm	16mm	40mm	0.85mm	17mm
1188-200A	0-200mm/0-8"	±0.03mm	297mm	24mm	20mm	16mm	50mm	0.85mm	17mm
1188-300A	0-300mm/0-12"	±0.04mm	390mm	26mm	21.5mm	16mm	60mm	1.00mm	17mm

Built-in wireless (receiver code 7315-2/3/6/7/8/9 is required)

Code	Range	Accuracy	L	a	b	c	d	e	g
1188-150AWL	0-150mm/0-6"	±0.03mm	235mm	21mm	16.5mm	16mm	40mm	0.85mm	17mm
1188-200AWL	0-200mm/0-8"	±0.03mm	297mm	24mm	20mm	16mm	50mm	0.85mm	17mm
1188-300AWL	0-300mm/0-12"	±0.04mm	390mm	26mm	21.5mm	16mm	60mm	1.00mm	17mm

## DIGITAL CALIPERS WITH POSITIONING SURFACES

- Non waterproof
- Lower jaws with positioning surfaces, for measuring inside diameters quickly
- Resolution: 0.01mm/0.0005"
- Buttons: on/off, set, mm/inch, preset (+, -)
- Automatic power off, move the digital unit to turn on power
- Battery CR2032
- Made of stainless steel

With data interface (data output cable code 7315-21 need receiver page 4, 7302-21 page 12, optional)

Code	Range	Accuracy
1534-200	0-200mm/0-8"	±0.03mm

Built-in wireless (receiver code 7315-2/3/6/7/8/9 is required)

Code	Range	Accuracy
1534-200WL	0-200mm/0-8"	±0.03mm



1534-200

DATA OUTPUT

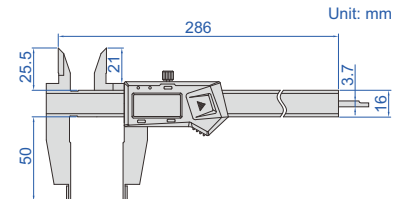
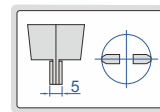
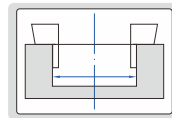

DATA OUTPUT

## DIGITAL INSIDE KNIFE-EDGE CALIPERS

- Non waterproof
- Measure diameter of deep step holes
- Resolution: 0.01mm/0.0005"
- Buttons: on/off, zero, mm/inch
- Automatic power off, move the digital unit to turn on power
- Battery CR2032
- Made of stainless steel



1123-150A

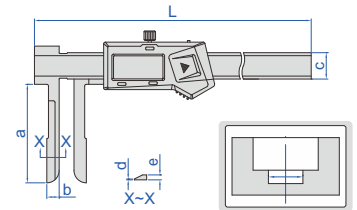

With data interface

(mm)

Code	Range	Accuracy	L	a	b	c	d	e	Data output cable (optional)
1123-150A	15-150mm/0.6-6"	±0.05mm	250	60	12	16	0.3	3.5	7315-21 need receiver page 4, 7302-21 page 12
1123-200A	20-200mm/0.8-8"	±0.06mm	305	100	17	16	0.3	3.5	7315-21 need receiver page 4, 7302-21 page 12
1123-300A	24-300mm/0.9-12"	±0.06mm	500	150	22	24	0.5	3.5	7315-22 need receiver page 4, 7302-22 page 12

Built-in wireless (receiver code 7315-2/3/6/7/8/9 is required)

(mm)

Code	Range	Accuracy	L	a	b	c	d	e
1123-150AWL	15-150mm/0.6-6"	±0.05mm	250	60	12	16	0.3	3.5
1123-200AWL	20-200mm/0.8-8"	±0.06mm	305	100	17	16	0.3	3.5

## DIGITAL CALIPERS WITH KNIFE-EDGE LOWER JAWS

- Non waterproof
- Measure diameter of narrow grooves
- Resolution: 0.01mm/0.0005"
- Buttons: on/off, zero, mm/inch
- Automatic power off, move the digital unit to turn on power
- Battery CR2032
- Made of stainless steel

With data interface (data output cable code 7315-21 need receiver page 4, 7302-21 page 12, optional)

Code	Range	Accuracy
1532-200	0-200mm/0-8"	±0.03mm

Built-in wireless (receiver code 7315-2/3/6/7/8/9 is required)

Code	Range	Accuracy
1532-200WL	0-200mm/0-8"	±0.03mm



1532-200

DATA OUTPUT

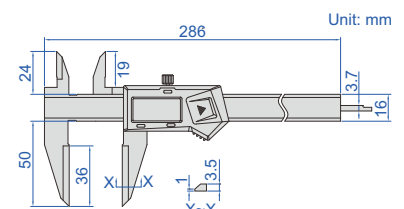
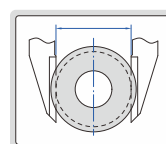

## DIGITAL CALIPERS WITH LONG UPPER JAWS

DATA  
OUTPUT

2

- Non waterproof
- Long upper jaws for measuring diameter of deep holes
- Resolution: 0.01mm/0.0005"
- Buttons: on/off, zero, mm/inch
- Automatic power off, move the digital unit to turn on power
- Battery CR2032
- Made of stainless steel



1138-200

With data interface (data output cable code 7315-21 need receiver page 4, 7302-21 page 12, optional)

Code	Range	Accuracy
1138-200	0-200mm/0-8"	±0.04mm

Built-in wireless (receiver code 7315-2/3/6/7/8/9 is required)

Code	Range	Accuracy
1138-200WL	0-200mm/0-8"	±0.04mm

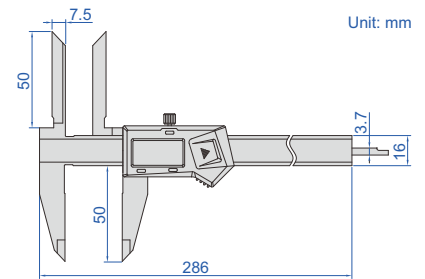
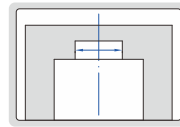

## DIAL CALIPERS WITH LONG UPPER JAWS

SHOCK  
PROOF



1338-300

- Long upper jaws for measuring diameter of deep holes
- Shockproof dial indicator
- Dial indicator graduation: 0.02mm
- Made of stainless steel

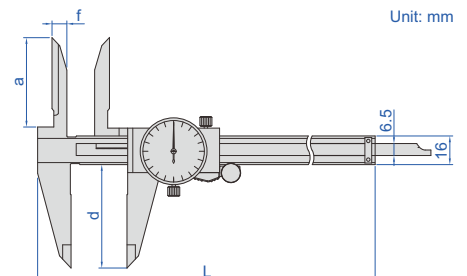
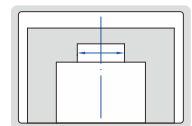

Code	Range	Accuracy	L	a	d	f
1338-150	0-150mm	±0.03mm	236	40	40	6.5
1338-200	0-200mm	±0.03mm	288	45	50	7.5
1338-300	0-300mm	±0.04mm	400	50	60	8



1192-150A

preset buttons

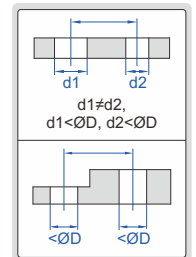
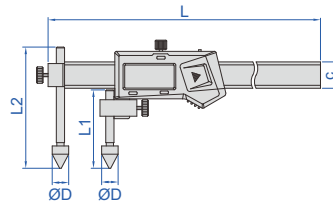

- Non waterproof
- Measure hole center distance in the same or offset planes
- Resolution: 0.01mm/0.0005"
- Buttons: on/off, set, mm/inch, preset (+, -)
- Automatic power off, move the digital unit to turn on power
- Battery CR2032
- Made of stainless steel

With data interface

(mm)

Code	Range	Accuracy	c	ØD	L1	L2	L	Data output cable (optional)
1192-150A	10-150mm/0.4-6"	±0.05mm	16	10	46	79	236	7315-21 need receiver page 4, 7302-21 page 12
1192-200A	10-200mm/0.4-8"	±0.07mm	16	10	46	79	286	7315-21 need receiver page 4, 7302-21 page 12
1192-300A	10-300mm/0.4-12"	±0.09mm	16	10	46	79	396	7315-21 need receiver page 4, 7302-21 page 12
1192-500A	20-500mm/0.8-20"	±0.09mm	24	20	52	112	725	7315-22 need receiver page 4, 7302-22 page 12
1192-1000A	30-1000mm/1.2-40"	±0.12mm	31	30	75	120	1255	7315-22 need receiver page 4, 7302-22 page 12
1192-1500A	30-1500mm/1.2-60"	±0.15mm	31	30	75	120	1760	7315-22 need receiver page 4, 7302-22 page 12

Built-in wireless (receiver code 7315-2/3/6/7/8/9 is required)

(mm)

Code	Range	Accuracy	c	ØD	L1	L2	L
1192-150AWL	10-150mm/0.4-6"	±0.05mm	16	10	46	79	236
1192-200AWL	10-200mm/0.4-8"	±0.07mm	16	10	46	79	286
1192-300AWL	10-300mm/0.4-12"	±0.09mm	16	10	46	79	396
1192-500AWL	20-500mm/0.8-20"	±0.09mm	24	20	52	112	725

## DIGITAL BACK-JAW CENTERLINE CALIPERS

DATA OUTPUT

2

preset buttons



1177-200

back-jaw



- Non waterproof
- Measure hole center distance in the same or offset planes
- Resolution: 0.01mm/0.0005"
- Buttons: on/off, set, mm/inch, preset (+, -)
- Automatic power off, move the digital unit to turn on power
- Battery CR2032
- Made of stainless steel

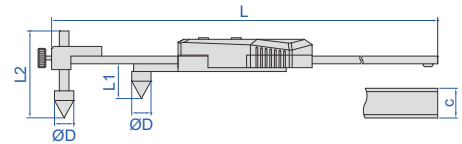
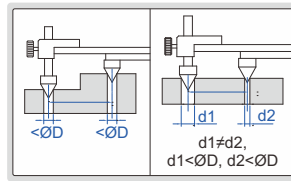

With data interface

(mm)

Code	Range	Accuracy	ØD	c	L1	L2	L	Data output cable (optional)
1177-200	10-200mm/0.4-8"	±0.10mm	10	16	18	45	310	7315-21 need receiver page 4, 7302-21 page 12
1177-300	10-300mm/0.4-12"	±0.10mm	10	16	18	45	410	7315-21 need receiver page 4, 7302-21 page 12
1177-500	20-500mm/0.8-20"	±0.10mm	20	24	26	70	692	7315-22 need receiver page 4, 7302-22 page 12
1177-1000	30-1000mm/1.2-40"	±0.12mm	30	31	39	70	1242	7315-22 need receiver page 4, 7302-22 page 12
1177-1500	30-1500mm/1.2-60"	±0.15mm	30	31	39	70	1745	7315-22 need receiver page 4, 7302-22 page 12

Built-in wireless (receiver code 7315-2/3/6/7/8/9 is required)

(mm)

Code	Range	Accuracy	ØD	c	L1	L2	L
1177-200WL	10-200mm/0.4-8"	±0.10mm	10	16	18	45	310
1177-300WL	10-300mm/0.4-12"	±0.10mm	10	16	18	45	410
1177-500WL	20-500mm/0.8-20"	±0.10mm	20	24	26	70	692

## DIGITAL BACK-JAW EDGE TO CENTER CALIPERS

DATA OUTPUT

- Non waterproof
- Measure edge to hole center distance
- Resolution: 0.01mm/0.0005"
- Buttons: on/off, set, mm/inch, preset (+, -)
- Automatic power off, move the digital unit to turn on power
- Battery CR2032
- Made of stainless steel

With data interface (data output cable code 7315-21 need receiver page 4, 7302-21 page 12, optional)

Code	Range	Accuracy	L
1524-200	5-200mm/0.2-8"	±0.1mm	310mm
1524-300	5-300mm/0.2-12"	±0.1mm	410mm

Built-in wireless

(receiver code 7315-2/3/6/7/8/9 is required)

Code	Range	Accuracy	L
1524-200WL	5-200mm/0.2-8"	±0.1mm	310mm
1524-300WL	5-300mm/0.2-12"	±0.1mm	410mm



1524-200

back-jaw



preset buttons

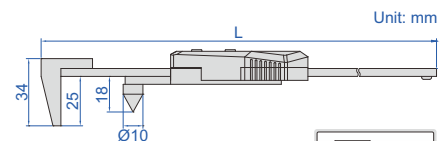

Unit: mm

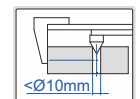





1521-2002

- Non waterproof
- Measure hole center distance in the same or offset planes and edge to hole center distance
- Resolution: 0.01mm/0.0005"
- Buttons: on/off, set, mm/inch, preset (+, -)
- Automatic power off, move the digital unit to turn on power
- Battery CR2032
- Made of stainless steel

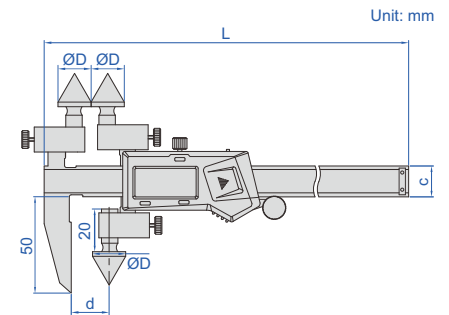

With data interface

(data output cable code 7315-21 need receiver page 4, 7302-21 page 12, optional)

(mm)

Code	Range	Accuracy	ØD	d	L	c
1521-150	5-150mm/0.2-6"	±0.05mm	5	5	236	16
1521-1501	10-150mm/0.4-6"	±0.05mm	10	10	236	16
1521-1502	20-150mm/0.8-6"	±0.05mm	20	20	236	16
1521-200	5-200mm/0.2-8"	±0.05mm	5	5	285	16
1521-2001	10-200mm/0.4-8"	±0.05mm	10	10	285	16
1521-2002	20-200mm/0.8-8"	±0.05mm	20	20	285	16
1521-300	5-300mm/0.2-12"	±0.07mm	5	5	385	17
1521-3001	10-300mm/0.4-12"	±0.07mm	10	10	385	17
1521-3002	20-300mm/0.8-12"	±0.07mm	20	20	385	17

measure hole center distance

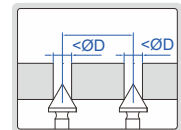

measure edge to hole center distance

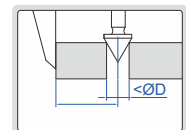

Built-in wireless (receiver code 7315-2/3/6/7/8/9 is required)

(mm)

Code	Range	Accuracy	ØD	d	L	c
1521-150WL	5-150mm/0.2-6"	±0.05mm	5	5	236	16
1521-1501WL	10-150mm/0.4-6"	±0.05mm	10	10	236	16
1521-1502WL	20-150mm/0.8-6"	±0.05mm	20	20	236	16
1521-200WL	5-200mm/0.2-8"	±0.05mm	5	5	285	16
1521-2001WL	10-200mm/0.4-8"	±0.05mm	10	10	285	16
1521-2002WL	20-200mm/0.8-8"	±0.05mm	20	20	285	16
1521-300WL	5-300mm/0.2-12"	±0.07mm	5	5	385	17
1521-3001WL	10-300mm/0.4-12"	±0.07mm	10	10	385	17
1521-3002WL	20-300mm/0.8-12"	±0.07mm	20	20	385	17

## DIGITAL CENTERLINE AND EDGE TO CENTER CALIPERS

DATA OUTPUT

2



1525-300



- Non waterproof
- Measure hole center distance or edge to hole center distance
- Resolution: 0.01mm/0.0005"
- Buttons: on/off, set, mm/inch, preset (+, -)
- Automatic power off, move the digital unit to turn on power
- Battery CR2032
- Made of stainless steel

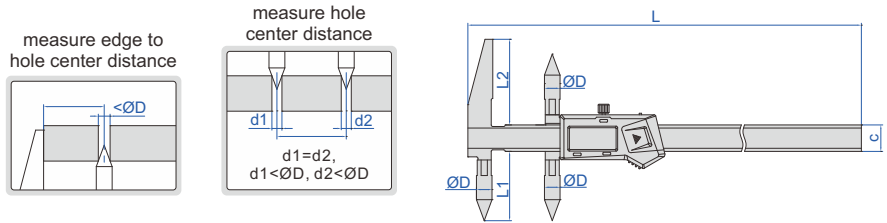

### With data interface

Code	Range of upper jaw (edge to center)	Range of lower jaw (center to center)	Accuracy	ØD	L1	L2	c	L	Data output cable (optional)
1525-300	5-300mm/0.2-12"	10-300mm/0.4-12"	±0.08mm	10	44.5	55	17	410	7315-21 need receiver page 4, 7302-21 page 12
1525-3001	10-300mm/0.4-12"	20-300mm/0.8-12"	±0.08mm	20	48	60	17	410	
1525-500	10-500mm/0.4-20"	20-500mm/0.8-20"	±0.09mm	20	50	60	24	690	7315-22 need receiver page 4, 7302-22 page 12
1525-1000	15-1000mm/0.6-40"	30-1000mm/1.2-40"	±0.12mm	30	70	81	31	1255	
1525-1500	15-1500mm/0.6-60"	30-1500mm/1.2-60"	±0.15mm	30	70	81	31	1760	

### Built-in wireless (receiver code 7315-2/3/6/7/8/9 is required)

Code	Range of upper jaw (edge to center)	Range of lower jaw (center to center)	Accuracy	ØD	L1	L2	c	L
1525-300WL	5-300mm/0.2-12"	10-300mm/0.4-12"	±0.08mm	10	44.5	55	17	410
1525-3001WL	10-300mm/0.4-12"	20-300mm/0.8-12"	±0.08mm	20	48	60	17	410
1525-500WL	10-500mm/0.4-20"	20-500mm/0.8-20"	±0.09mm	20	50	60	24	690

## DIGITAL HOOK CALIPERS

DATA OUTPUT



1122-300

- Non waterproof
- Measure width and distance of grooves inside bores
- Resolution: 0.01mm/0.0005"
- Buttons: on/off, zero, mm/inch
- Automatic power off, move the digital unit to turn on power
- Battery CR2032
- Made of stainless steel

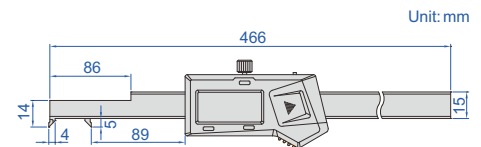

### With data interface (data output cable code 7315-21 need receiver page 4, 7302-21 page 12, optional)

Code	Range	Accuracy
1122-300	4-300mm/0.16-12"	±0.04mm

### Built-in wireless (receiver code 7315-2/3/6/7/8/9 is required)

Code	Range	Accuracy
1122-300WL	4-300mm/0.16-12"	±0.04mm

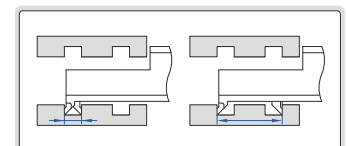

DATA OUTPUT

## DIGITAL CALIPERS WITH ONE DIRECTION UPPER JAWS



1184-200



1184-150A

- Non waterproof
- Resolution: 0.01mm/0.0005"
- Buttons: zero, power on/off, inch/mm
- Automatic power off, move the digital unit to turn on power
- Battery CR2032
- Data output
- Made of stainless steel
- Optional accessory: data output cable (code 7315-21 need receiver page 4, 7302-21 page 12)

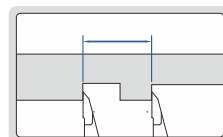
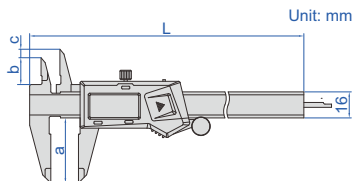

jaws with same height used for measuring the distance in same level

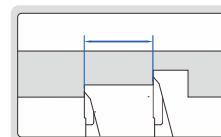

jaws with different height used for measuring the distance in different level

Jaws with same height (mm)

Code	Range	Accuracy	L	a	b	c
1184-150	0-150mm/0-6"	±0.03mm	236	40	17	0
1184-200	0-200mm/0-8"	±0.03mm	286	50	20	0
1184-300	0-300mm/0-12"	±0.03mm	400	60	22	0

Jaws with different height (mm)

Code	Range	Accuracy	L	a	b	c
1184-150A	0-150mm/0-6"	±0.03mm	236	40	17	5
1184-200A	0-200mm/0-8"	±0.03mm	286	50	20	8
1184-300A	0-300mm/0-12"	±0.03mm	400	60	22	10

DATA OUTPUT

## DIGITAL OFFSET CALIPERS



1186-150A

- Non waterproof
- The left jaw can slide up and down to facilitate measurement of stepped sections
- Resolution: 0.01mm/0.0005"
- Buttons: on/off, zero, mm/inch
- Automatic power off, move the digital unit to turn on power
- Battery CR2032
- Made of stainless steel

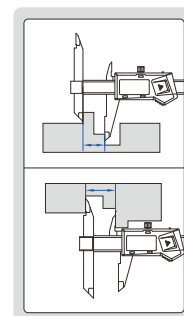
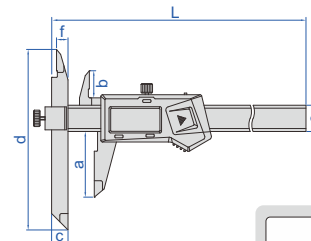

With data interface (data output cable code 7315-21 need receiver page 4, 7302-21 page 12, optional) (mm)

Code	Range	Accuracy	L	a	b	c	d	e	f
1186-150A	0-150mm/0-6"	±0.04mm	249	40	16.5	10	110	17	7
1186-200A	0-200mm/0-8"	±0.04mm	299	50	19.5	10	120	17	7
1186-300A	0-300mm/0-12"	±0.05mm	399	60	20.5	10	130	17	7

Built-in wireless (receiver code 7315-2/3/6/7/8/9 is required) (mm)

Code	Range	Accuracy	L	a	b	c	d	e	f
1186-150AWL	0-150mm/0-6"	±0.04mm	249	40	16.5	10	110	17	7
1186-200AWL	0-200mm/0-8"	±0.04mm	299	50	19.5	10	120	17	7
1186-300AWL	0-300mm/0-12"	±0.05mm	399	60	20.5	10	130	17	7

## DIGITAL TUBE THICKNESS CALIPERS

DATA OUTPUT

2

- Non waterproof
- Measure wall thickness of tubes
- Resolution: 0.01mm/0.0005"
- Buttons: on/off, zero, mm/inch
- Automatic power off, move the digital unit to turn on power
- Battery CR2032
- Made of stainless steel



1161-150A

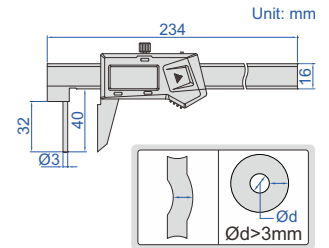

With data interface (data output cable code 7315-21 need receiver page 4, 7302-21 page 12, optional)

Code	Range	Accuracy
1161-150A	0-150mm/0-6"	±0.05mm

Built-in wireless (receiver code 7315-2/3/6/7/8/9 is required)

Code	Range	Accuracy
1161-150AWL	0-150mm/0-6"	±0.05mm

## DIGITAL RTJ RING GROOVE CALIPERS

DATA OUTPUT

- Non waterproof
- Angle of RTJ ring groove: 23°
- Measure ring grooves of flange
- Resolution: 0.01mm/0.0005"
- Button function: on/off, set, zero, mm/inch, data preset
- Battery CR2032
- Made of stainless steel

preset buttons

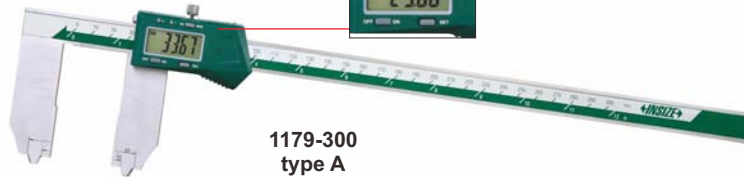

1179-300 type A

applicable for RTJ ring grooves with angle 23°

d and e need to be added on the reading

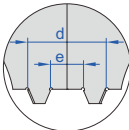
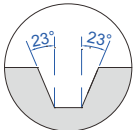

1179-600 type B

measure outside diameter of RTJ ring groove

measure inside diameter of RTJ ring groove

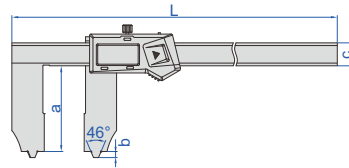
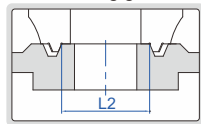
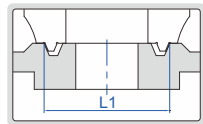

type A

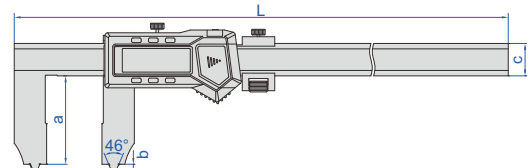

type B

With data interface

(mm)

Code	Range (inside diameter of RTJ ring groove)	Range (outside diameter of RTJ ring groove)	Accuracy	Type	L	a	b	c	d	e	Data output cable (optional)
1179-300	10-300mm/0.4-12"	25-300mm/1-12"	±0.06mm	A	410	63.5	4.5	17	25	10	7315-21 need receiver page 4, 7302-21 page 12
1179-600	10-600mm/0.4-24"	25-600mm/1-24"	±0.07mm	B	770	65.5	4.5	24	25	10	
1179-1000	15-1000mm/0.6-40"	30-1000mm/1.2-40"	±0.09mm	B	1220	90	5	31	30	15	7315-22 need receiver page 4, 7302-22 page 12

Built-in wireless (receiver code 7315-2/3/6/7/8/9 is required)

(mm)

Code	Range (inside diameter of RTJ ring groove)	Range (outside diameter of RTJ ring groove)	Accuracy	Type	L	a	b	c	d	e
1179-300WL	10-300mm/0.4-12"	25-300mm/1-12"	±0.06mm	A	410	63.5	4.5	17	25	10
1179-600WL	10-600mm/0.4-24"	25-600mm/1-24"	±0.07mm	B	770	65.5	4.5	24	25	10

## DIGITAL CALIPERS WITH INTERCHANGEABLE BALL TIPS

DATA OUTPUT

2

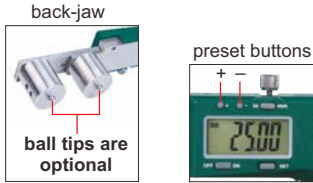

- back-jaw
- ball tips are optional
- preset buttons
- Non waterproof
- Resolution 0.01mm/0.0005"
- Buttons: on/off, set, mm/inch, preset (+, -)
- Automatic power off, move the digital unit to turn on power
- Battery CR2032
- Made of stainless steel
- Optional accessory: ball tips



1527-3001

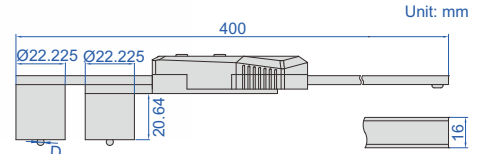

With data interface (data output cable code 7315-21 need receiver page 4, 7302-21 page 12, optional)

Code	Range	Accuracy
1527-3001	(22.22+D)~300mm*	±0.03mm

Built-in wireless (receiver code 7315-2/3/6/7/8/9 is required)

Code	Range	Accuracy
1527-3001WL	(22.22+D)~300mm*	±0.03mm

\*"D" is the diameter of ball tips.

Ball tips (optional, supplied in pair)



Code	Diameter (D)	Accuracy of diameter	Type	Material
1527-T101	1/16" (Ø1.5875mm)	±0.005mm	A	ruby
1527-T102	1/8" (Ø3.175mm)	±0.005mm	B	stainless steel
1527-T103	3/16" (Ø4.7625mm)	±0.005mm	B	stainless steel
1527-T104	1/4" (Ø6.35mm)	±0.005mm	B	stainless steel
1527-T105	3/8" (Ø9.525mm)	±0.005mm	B	stainless steel
1527-T106	1/2" (Ø12.7mm)	±0.005mm	B	stainless steel

DATA OUTPUT

## DIGITAL CALIPERS WITH INTERCHANGEABLE BALL TIPS

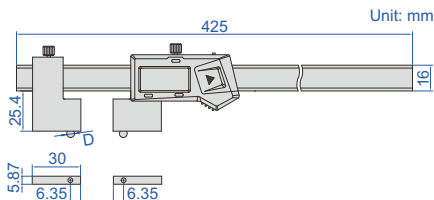

ball tips are optional

1528-3001



- Non waterproof
- Resolution 0.01mm/0.0005"
- Buttons: on/off, set, mm/inch, preset (+, -)
- Automatic power off, move the digital unit to turn on power
- Battery CR2032
- Made of stainless steel
- Optional accessory: ball tips

With data interface (data output cable code 7315-21 need receiver page 4, 7302-21 page 12, optional)

Code	Range	Accuracy
1528-3001	(12.7+D)~300mm*	±0.03mm

Built-in wireless (receiver code 7315-2/3/6/7/8/9 is required)

Code	Range	Accuracy
1528-3001WL	(12.7+D)~300mm*	±0.03mm

\*"D" is the diameter of ball tips.

Ball tips (optional, supplied in pair)



Code	Diameter (D)	Accuracy of diameter	Type	Material
1527-T101	1/16" (Ø1.5875mm)	±0.005mm	A	ruby
1527-T102	1/8" (Ø3.175mm)	±0.005mm	B	stainless steel
1527-T103	3/16" (Ø4.7625mm)	±0.005mm	B	stainless steel
1527-T104	1/4" (Ø6.35mm)	±0.005mm	B	stainless steel
1527-T105	3/8" (Ø9.525mm)	±0.005mm	B	stainless steel
1527-T106	1/2" (Ø12.7mm)	±0.005mm	B	stainless steel

## DIGITAL CRIMP HEIGHT CALIPERS

RELATIVE PRODUCT: CRIMP HEIGHT MICROMETER (CODE 3266-25BA, 3566-25BA)

DATA OUTPUT

- Non waterproof
- Measure crimp height
- Resolution: 0.01mm/0.0005"
- Buttons: on/off, zero, mm/inch
- Automatic power off, move the digital unit to turn on power
- Battery CR2032, meet DIN862
- Made of stainless steel



1165-150A

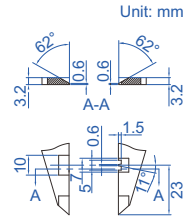

With data interface (data output cable code 7315-21 need receiver page 4, 7302-21 page 12, optional)

Code	Range	Accuracy
1165-150A	0-150mm/0-6"	±0.03mm

Built-in wireless (receiver code 7315-2/3/6/7/8/9 is required)

Code	Range	Accuracy
1165-150AWL	0-150mm/0-6"	±0.03mm

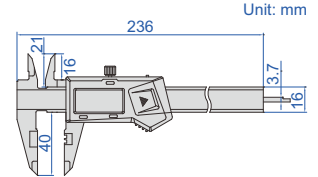

## DIGITAL CALIPERS WITH LARGE MEASURING FACES

DATA OUTPUT

- Non waterproof
- Measure diameter of wire ropes, and thickness of soft materials like rubber, sponge, etc.
- Resolution: 0.01mm/0.0005"
- Buttons: on/off, zero, mm/inch
- Automatic power off, move the digital unit to turn on power
- Battery CR2032
- Made of stainless steel



1172-200

With data interface (data output cable code 7315-21 need receiver page 4, 7302-21 page 12, optional)

Code	Range	Accuracy
1172-200	0-200mm/0-8"	±0.07mm

Built-in wireless (receiver code 7315-2/3/6/7/8/9 is required)

Code	Range	Accuracy
1172-200WL	0-200mm/0-8"	±0.07mm

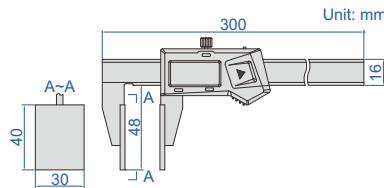

measure diameter of wire ropes

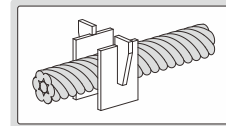

measure thickness of rubber, sponge, etc.

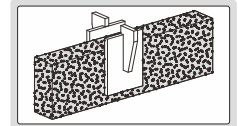

## DIGITAL CALIPERS WITH DISK FACES

DATA OUTPUT

- Non waterproof
- Measure thickness of soft sheets
- Resolution: 0.01mm/0.0005"
- Buttons: on/off, zero, mm/inch
- Automatic power off, move the digital unit to turn on power
- Battery CR2032
- Made of stainless steel



1533-150

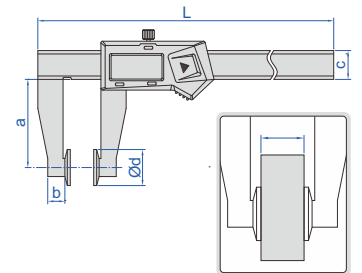

With data interface

Code	Range	Accuracy	L	a	b	c	Ød	Data output cable (optional)
1533-150	0-150mm/0-6"	±0.04mm	245	50	11	16	20	7315-21 need receiver page 4, 7302-21 page 12
1533-200	0-200mm/0-8"	±0.05mm	310	80	11	16	30	7315-21 need receiver page 4, 7302-21 page 12
1533-500	0-500mm/0-20"	±0.07mm	680	150	12.5	24	50	7315-22 need receiver page 4, 7302-22 page 12

Built-in wireless (receiver code 7315-2/3/6/7/8/9 is required) (mm)

Code	Range	Accuracy	L	a	b	c	Ød
1533-150WL	0-150mm/0-6"	±0.04mm	245	50	11	16	20
1533-200WL	0-200mm/0-8"	±0.05mm	310	80	11	16	30
1533-500WL	0-500mm/0-20"	±0.07mm	680	150	12.5	24	50

**DATA OUTPUT**
**DIGITAL WALL THICKNESS CALIPERS**

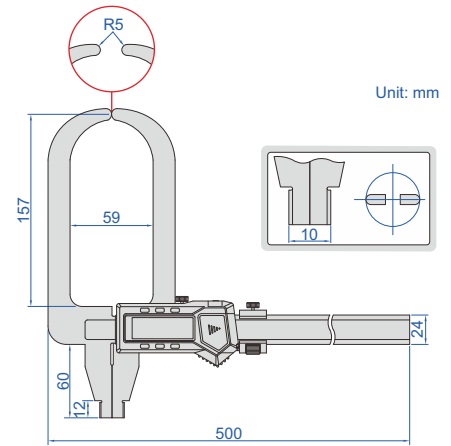
**1536-300**

With data interface (data output cable code 7315-22 need receiver page 4, 7302-22 page 12, optional)

Code	Range	Accuracy
1536-300	0-300mm/0-12"	±0.05mm

Built-in wireless (receiver code 7315-2/3/6/7/8/9 is required)

Code	Range	Accuracy
1536-300WL	0-300mm/0-12"	±0.05mm

- Non waterproof
- Measure wall thickness of helmets, domes and curved pots
- Resolution: 0.01mm/0.0005"
- Buttons: on/off, zero, mm/inch, ABS, data preset
- Automatic power off, move the digital unit to turn on power
- Battery CR2032
- Made of stainless steel

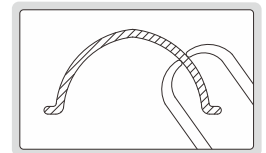
**DIRECT READING, CALCULATION IS NOT REQUIRED**
**DATA OUTPUT**
**DIGITAL V SHAPE CALIPER**

- Non waterproof
- Measure outside diameter of three number of flutes (such as taps, reamers, end mills and gears)
- Resolution: 0.01mm/0.0005"
- Buttons: on/off, zero, mm/inch
- Battery CR2032
- Automatic power off, move the digital unit to turn on power
- Data output
- Made of stainless steel
- Optional accessory: data output cable (code 7315-1529 need receiver, 7302-1529)

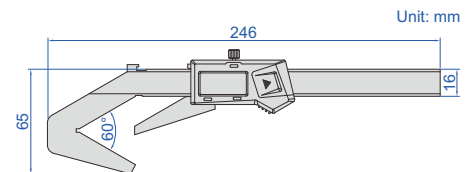
**1539-3**

Code	Range	Accuracy
1539-3	∅4-∅40mm/0.16"-1.58" DIA	±0.03mm

**V SHAPE VERNIER CALIPER**

- Measure outside diameter of three number of flutes (such as taps, reamers, end mills and gears)
- Made of stainless steel
- Satin chrome plated reading surface

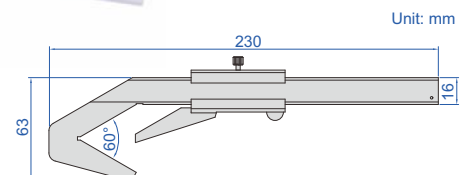
**1273-403**

Code	Range	Graduation	Accuracy
1273-403	∅4-40mm	0.05mm	±0.05mm

## V SHAPE VERNIER CALIPERS

- Measure outside diameter of odd number of flutes (such as taps, reamers, end mills and gears)
- Made of stainless steel
- Satin chrome plated reading surface
- Optional accessory: 4mm pin gage (code 4110-4D00), Ø50mm calibration cylinder (code 6316-50)



1229-3

Code	Range (ØD)	Graduation	Accuracy	Flutes	Angle α	L	c
1229-3	Ø4-60mm	0.02mm	±0.04mm	3	60°	260mm	16mm
1229-35	Ø50-200mm	0.02mm	±0.06mm	3	60°	516mm	20mm
1229-5	Ø4-60mm	0.02mm	±0.04mm	5	108°	210mm	16mm
1229-55	Ø50-200mm	0.02mm	±0.06mm	5	108°	360mm	20mm

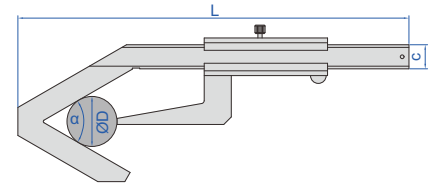

## DIGITAL GEAR TOOTH CALIPERS

ATTENTION:  
NO DATA OUTPUT

- Non waterproof
- Resolution: 0.01mm/0.0005"
- Carbide tips
- Measure the tooth thickness by positioning the tooth height (for tooth height > 1mm)
- Buttons: zero, on/off, mm/inch
- Automatic power off, move the digital unit to turn on power
- Battery CR2032
- Made of stainless steel



1181-M25A

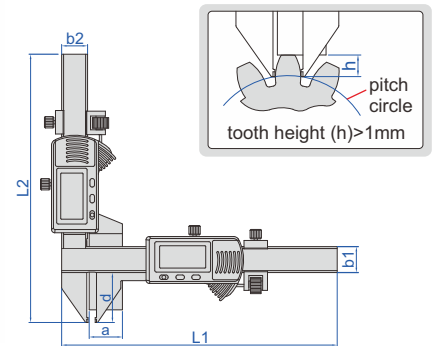

Code	Range	Accuracy of height measurement	Accuracy of thickness measurement	Total accuracy	L1	L2	a	b1	b2	d
1181-M25A	M1-25mm	±0.03mm	±0.03mm	±0.04mm	170mm	165.5mm	21mm	16mm	16mm	30.5mm
1181-M50A	M5-50mm	±0.03mm	±0.03mm	±0.04mm	220mm	190mm	50.5mm	16mm	16mm	55mm

## GEAR TOOTH VERNIER CALIPER

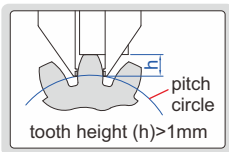

- Carbide tips
- Measure the tooth thickness by positioning the tooth height (for tooth height > 1mm)
- Made of stainless steel
- Satin chrome plated reading surface



1281-M26A

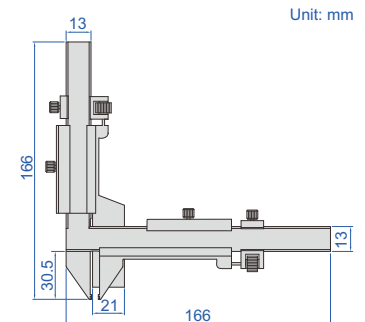

Code	Range	Graduation	Accuracy of height measurement	Accuracy of thickness measurement	Total accuracy
1281-M26A	M1-26mm	0.02mm	±0.03mm	±0.03mm	±0.04mm



REFER TO PAGE 212 FOR DETAILS



## DIGITAL ARC RADIUS CALIPERS

1189-150B

REFER TO PAGE 441 FOR DETAILS



## DIGITAL SCRIBING CALIPERS

1166-150A

## DIGITAL DISK BRAKE CALIPERS

- Non waterproof
- Measure thickness of disk brakes
- Resolution 0.01mm/0.0005"
- Buttons: on/off, zero, mm/inch
- Automatic power off, move the digital unit to turn on power
- Battery CR2032
- Made of stainless steel

RELATIVE PRODUCT: DISK BRAKE MICROMETER (CODE 3288-, 3588-)

DATA OUTPUT



1162-125A

With data interface (data output cable code 7315-21 need receiver page 4, 7302-21 page 12, optional)

Code	Range	Accuracy
1162-125A	0-125mm/0-5"	±0.05mm

Built-in wireless (receiver code 7315-2/3/6/7/8/9 is required)

Code	Range	Accuracy
1162-125AWL	0-125mm/0-5"	±0.05mm

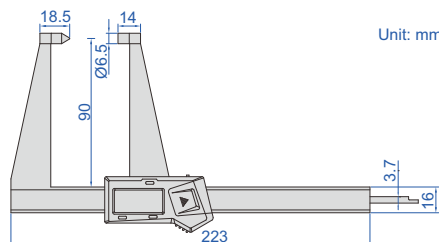

DATA OUTPUT

RELATIVE PRODUCT: DISK BRAKE MICROMETER (CODE 3288-, 3588-)

## DIGITAL DISK BRAKE AND PAD CALIPERS

- Non waterproof
- Measure thickness of disk brakes and pad wear
- Resolution: 0.01mm/0.0005"
- Buttons: on/off, zero, mm/inch
- Automatic power off, move the digital unit to turn on power
- Battery CR2032
- Made of stainless steel



1167-150A

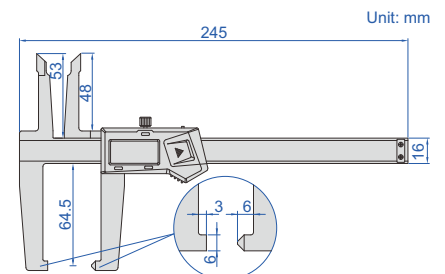

With data interface (data output cable code 7315-21 need receiver page 4, 7302-21 page 12, optional)

Code	Range	Accuracy
1167-150A	0-150mm/0-6"	±0.07mm

Built-in wireless (receiver code 7315-2/3/6/7/8/9 is required)

Code	Range	Accuracy
1167-150AWL	0-150mm/0-6"	±0.07mm



## DIGITAL DRUM BRAKE CALIPERS

RELATIVE PRODUCT: DISK BRAKE MICROMETER (CODE 3288-, 3588-)

DATA OUTPUT



1168-300A

- Non waterproof
- Measure internal and external diameter of drum brakes
- Resolution 0.01mm/0.0005"
- Buttons: on/off, zero, mm/inch
- Automatic power off, move the digital unit to turn on power
- Battery CR2032
- Made of stainless steel

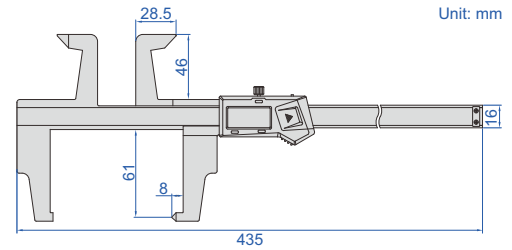

With data interface (data output cable code 7315-21 need receiver page 4, 7302-21 page 12, optional)

Code	Range	Accuracy
1168-300A	0-300mm/0-12"	±0.07mm

Built-in wireless (receiver code 7315-2/3/6/7/8/9 is required)

Code	Range	Accuracy
1168-300AWL	0-300mm/0-12"	±0.07mm



## DIGITAL DRUM BRAKE CALIPER

DATA OUTPUT

calibration block (included)



1538-300

- Non waterproof
- Measure internal diameter of drum brakes
- Resolution: 0.01mm/0.0005"
- Buttons: on/off, zero, mm/inch
- Automatic power off, move the digital unit to turn on power
- Battery CR2032
- Data output
- Made of stainless steel
- Optional accessory: data output cable (code 7315-22 need receiver page 4, 7302-22 page 12)

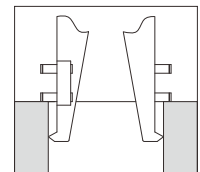
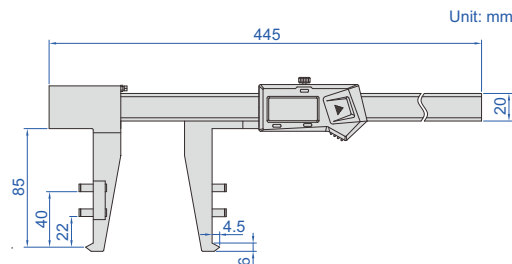

Code	Range	Accuracy
1538-300	30-300mm/1.2-12"	±0.05mm



**Digital Depth Gages**  
Page 68-73



**Dial Depth Gages**  
Page 73



**Vernier Depth Gages**  
Page 74-76



**Extension Bases**  
Page 76



**Mini Depth Gages**  
Page 76-77



**Depth Gages**  
Page 78-81



**Depth Micrometers**  
Page 82-83



**Depth Micrometer Checkers**  
Page 83

## IP67 WATERPROOF DIGITAL DEPTH GAGES

ATTENTION:  
NO DATA OUTPUT

**IP67**  
WATERPROOF

3



1543-150

- IP67 dust/waterproof
- Resolution: 0.01mm/0.0005"
- Button function: zero, on/off, mm/inch
- Battery CR2032
- Automatic power off
- Meet DIN862
- Made of stainless steel

Code	Range	Accuracy	L	a	b	d
1543-150	0-150mm/0-6"	±0.03mm	235mm	5mm	16mm	100mm
1543-200	0-200mm/0-8"	±0.03mm	285mm	5mm	16mm	100mm
1543-300	0-300mm/0-12"	±0.03mm	387mm	5mm	16mm	100mm

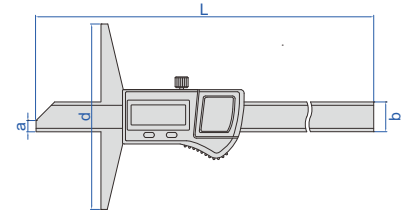

## IP67 WATERPROOF DIGITAL DEPTH GAGES

**IP67**  
WATERPROOF

ATTENTION: NO  
DATA OUTPUT

ATTENTION: IT IS NECESSARY TO SET  
ZERO AFTER POWER ON EACH TIME

- IP67 dust/waterproof
- Resolution: 0.01mm/0.0005"
- Button function: zero, on/off, mm/inch, ABS/REL, hold
- Meet DIN862
- Battery CR2032
- Made of stainless steel



1149-150

Code	Range	Accuracy	L	a	b	d
1149-150	0-150mm/0-6"	±0.03mm	240mm	6mm	16mm	100mm
1149-200	0-200mm/0-8"	±0.03mm	290mm	6mm	16mm	100mm
1149-300	0-300mm/0-12"	±0.03mm	390mm	6mm	16mm	150mm

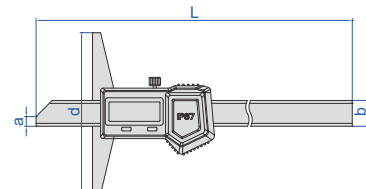

DATA  
OUTPUT

POPULAR  
MODEL

## DIGITAL DEPTH GAGES (STANDARD TYPE)

3



1141-150A

- Non waterproof
- Buttons: on/off, zero, mm/inch
- Automatic power off, move the digital unit to turn on power
- Meet DIN862 (except 0-500mm/0-20", 0-1000mm/0-40", 0-1500mm/0-60")
- Battery CR2032
- Made of stainless steel

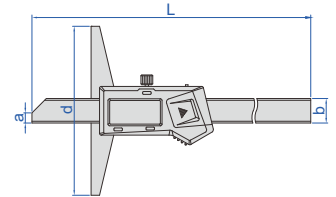

With data interface

(mm)

Code	Range	Resolution	Accuracy	L	a	b	d	Data output cable (optional)
1141-150A	0-150mm/0-6"	0.01mm/0.0005"	±0.03mm	230	6	14.5	100	7315-21 need receiver page 4, 7302-21 page 12
1141-200A	0-200mm/0-8"	0.01mm/0.0005"	±0.03mm	280	6	14.5	100	7315-21 need receiver page 4, 7302-21 page 12
1141-300A	0-300mm/0-12"	0.01mm/0.0005"	±0.03mm	380	6	14.5	150	7315-21 need receiver page 4, 7302-21 page 12
1141-500A	0-500mm/0-20"	0.01mm/0.0005"	±0.05mm	585	7	15	150	7315-22 need receiver page 4, 7302-22 page 12
1141-5001A	0-500mm/0-20"	0.01mm/0.0005"	±0.05mm	585	7	15	200	7315-22 need receiver page 4, 7302-22 page 12
1141-1000A	0-1000mm/0-40"	0.01mm/0.0005"	±0.07mm	1188	7	18	150	7315-22 need receiver page 4, 7302-22 page 12
1141-10001A	0-1000mm/0-40"	0.01mm/0.0005"	±0.07mm	1188	7	18	200	7315-22 need receiver page 4, 7302-22 page 12
1141-10002A	0-1000mm/0-40"	0.01mm/0.0005"	±0.07mm	1188	7	18	250	7315-22 need receiver page 4, 7302-22 page 12
1141-10003A	0-1000mm/0-40"	0.01mm/0.0005"	±0.07mm	1188	7	18	300	7315-22 need receiver page 4, 7302-22 page 12
1141-1500A	0-1500mm/0-60"	0.01mm/0.0005"	±0.11mm	1695	7	18	200	7315-22 need receiver page 4, 7302-22 page 12

Built-in wireless (receiver code 7315-2/3/6/7/8/9 is required)

Code	Range	Resolution	Accuracy	L	a	b	d
1141-150AWL	0-150mm/0-6"	0.01mm/0.0005"	±0.03mm	230mm	6mm	14.5mm	100mm
1141-200AWL	0-200mm/0-8"	0.01mm/0.0005"	±0.03mm	280mm	6mm	14.5mm	100mm
1141-300AWL	0-300mm/0-12"	0.01mm/0.0005"	±0.03mm	380mm	6mm	14.5mm	150mm
1141-500AWL	0-500mm/0-20"	0.01mm/0.0005"	±0.05mm	585mm	7mm	15mm	150mm
1141-5001AWL	0-500mm/0-20"	0.01mm/0.0005"	±0.05mm	585mm	7mm	15mm	200mm

## DIGITAL DEPTH GAGES WITH MOUNTING HOLES FOR EXTENSION BASE

DATA OUTPUT



1147-300

- Non waterproof
- Resolution: 0.01mm/0.0005"
- Buttons: on/off, zero, mm/inch
- Automatic power off, move the digital unit to turn on power
- Meet DIN862
- Battery CR2032
- Made of stainless steel
- Optional accessory: extension base (code 6141)

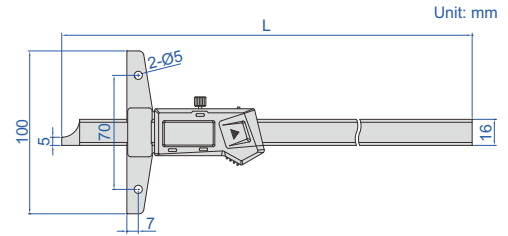

With data interface (data output cable code 7315-21 need receiver page 4, 7302-21 page 12, optional)

Code	Range	Accuracy	L
1147-150	0-150mm/0-6"	±0.03mm	237mm
1147-200	0-200mm/0-8"	±0.03mm	287mm
1147-300	0-300mm/0-12"	±0.03mm	403mm
1147-500	0-500mm/0-20"	±0.05mm	605mm
1147-700	0-700mm/0-28"	±0.06mm	805mm

Built-in wireless (receiver code 7315-2/3/6/7/8/9 is required)

Code	Range	Accuracy	L
1147-150WL	0-150mm/0-6"	±0.03mm	237mm
1147-200WL	0-200mm/0-8"	±0.03mm	287mm
1147-300WL	0-300mm/0-12"	±0.03mm	403mm
1147-500WL	0-500mm/0-20"	±0.05mm	605mm
1147-700WL	0-700mm/0-28"	±0.06mm	805mm

## DIGITAL HOOK DEPTH GAGES

DATA OUTPUT



1142-150A

- Non waterproof
- Resolution: 0.01mm/0.0005"
- Buttons: on/off, zero, mm/inch
- Automatic power off, move the digital unit to turn on power
- Battery CR2032
- Made of stainless steel

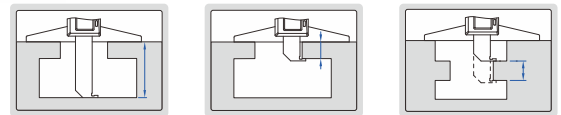
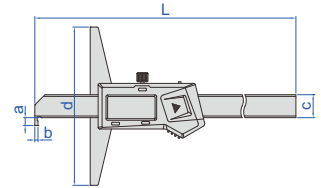

With data interface

Code	Range	Accuracy	L	d	a	b	c	Data output cable (optional)
1142-150A	0-150mm/0-6"	±0.03mm	230	100	5	2	14.5	7315-21 need receiver page 4, 7302-21 page 12
1142-200A	0-200mm/0-8"	±0.03mm	280	100	5	2	14.5	7315-21 need receiver page 4, 7302-21 page 12
1142-300A	0-300mm/0-12"	±0.04mm	380	150	5	2	14.5	7315-21 need receiver page 4, 7302-21 page 12
1142-500A	0-500mm/0-20"	±0.05mm	585	150	8	3	15	7315-22 need receiver page 4, 7302-22 page 12
1142-5001A	0-500mm/0-20"	±0.05mm	585	200	8	3	15	7315-22 need receiver page 4, 7302-22 page 12
1142-1000A	0-1000mm/0-40"	±0.07mm	1188	150	10	4	18	7315-22 need receiver page 4, 7302-22 page 12
1142-10001A	0-1000mm/0-40"	±0.07mm	1188	200	10	4	18	7315-22 need receiver page 4, 7302-22 page 12
1142-10002A	0-1000mm/0-40"	±0.07mm	1188	250	10	4	18	7315-22 need receiver page 4, 7302-22 page 12

Built-in wireless (receiver code 7315-2/3/6/7/8/9 is required)

Code	Range	Accuracy	L	d	a	b	c
1142-150AWL	0-150mm/0-6"	±0.03mm	230mm	100mm	5mm	2mm	14.5mm
1142-200AWL	0-200mm/0-8"	±0.03mm	280mm	100mm	5mm	2mm	14.5mm
1142-300AWL	0-300mm/0-12"	±0.04mm	380mm	150mm	5mm	2mm	14.5mm
1142-500AWL	0-500mm/0-20"	±0.05mm	585mm	150mm	8mm	3mm	15mm
1142-5001AWL	0-500mm/0-20"	±0.05mm	585mm	200mm	8mm	3mm	15mm

DATA  
OUTPUT

## DIGITAL DOUBLE HOOK DEPTH GAGES

- Non waterproof
- Resolution: 0.01mm/0.0005"
- Buttons: on/off, zero, mm/inch
- Automatic power off, move the digital unit to turn on power
- Meet DIN862
- Battery CR2032
- Made of stainless steel



1144-150A

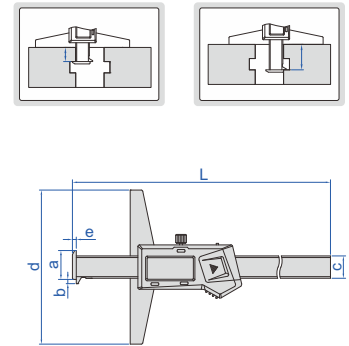

(mm)

With data interface

Code	Range	Accuracy	L	d	a	b	c	e	Data output cable (optional)
1144-150A	0-150mm/0-6"	±0.03mm	233	100	21.5	3.5	14.5	2.5	7315-21 need receiver page 4, 7302-21 page 12
1144-200A	0-200mm/0-8"	±0.03mm	283	100	21.5	3.5	14.5	2.5	7315-21 need receiver page 4, 7302-21 page 12
1144-300A	0-300mm/0-12"	±0.03mm	383	150	21.5	3.5	14.5	2.5	7315-21 need receiver page 4, 7302-21 page 12
1144-500A	0-500mm/0-20"	±0.05mm	585	150	25	5	15	3	7315-22 need receiver page 4, 7302-22 page 12
1144-5001A	0-500mm/0-20"	±0.05mm	585	200	25	5	15	3	7315-22 need receiver page 4, 7302-22 page 12
1144-1000A	0-1000mm/0-40"	±0.07mm	1188	150	32	7	18	4	7315-22 need receiver page 4, 7302-22 page 12
1144-10001A	0-1000mm/0-40"	±0.07mm	1188	200	32	7	18	4	7315-22 need receiver page 4, 7302-22 page 12
1144-10002A	0-1000mm/0-40"	±0.07mm	1188	250	32	7	18	4	7315-22 need receiver page 4, 7302-22 page 12

Built-in wireless (receiver code 7315-2/3/6/7/8/9 is required)

Code	Range	Accuracy	L	d	a	b	c	e
1144-150AWL	0-150mm/0-6"	±0.03mm	233mm	100mm	21.5mm	3.5mm	14.5mm	2.5mm
1144-200AWL	0-200mm/0-8"	±0.03mm	283mm	100mm	21.5mm	3.5mm	14.5mm	2.5mm
1144-300AWL	0-300mm/0-12"	±0.03mm	383mm	150mm	21.5mm	3.5mm	14.5mm	2.5mm
1144-500AWL	0-500mm/0-20"	±0.05mm	585mm	150mm	25mm	5mm	15mm	3mm
1144-5001AWL	0-500mm/0-20"	±0.05mm	585mm	200mm	25mm	5mm	15mm	3mm

DATA  
OUTPUT

## DIGITAL DOUBLE HOOK DEPTH GAGE

- Non waterproof
- Resolution: 0.01mm/0.0005"
- Buttons: on/off, zero, mm/inch, ABS/INC, data hold, TOL, set
- ABS/INC is for absolute and incremental measurement
- TOL is for tolerance measurement
- Made of stainless steel
- LR44 battery, data output
- Supplied with gage block for zero setting
- Optional accessory: extension base, data output cable (code 7302-SPC7 page 13, keyboard format), wireless data transmission (transmitter code 7315-1150 need receiver page 6)

Code	Range	Accuracy
1540-300	0-300mm/0-12"	±0.04mm

Extension base (optional)

Code	L
1540-L300	300mm
1540-L400	400mm
1540-L500	500mm
1540-L600	600mm
1540-L800	800mm

gage block for zero setting (included)



1540-300

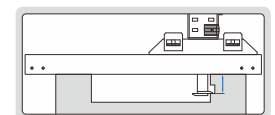
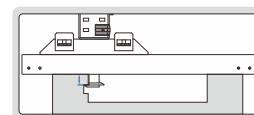
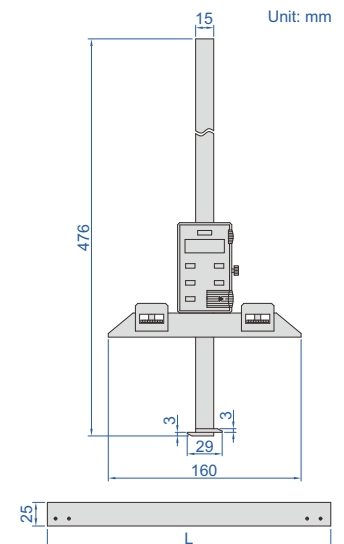

## DIGITAL DEPTH GAGES WITH ROUND DEPTH BAR

MEASURE WIDTH AND DEPTH OF GROOVES INSIDE BORE

MEASURE DEPTH OF SMALL HOLES (>Ø4mm)

DATA OUTPUT

3

- Non waterproof
- Resolution: 0.01mm/0.0005"
- Supplied with three interchangeable points (flat, spherical, disk)
- Buttons: on/off, set, mm/inch, preset (+, -)
- Automatic power off, move the digital unit to turn on power
- Battery CR2032
- Made of stainless steel
- Optional accessory: extension base (code 6141, for 1148-120, 1148-120WL, 1148-200, 1148-200WL, 1148-300 and 1148-300WL)

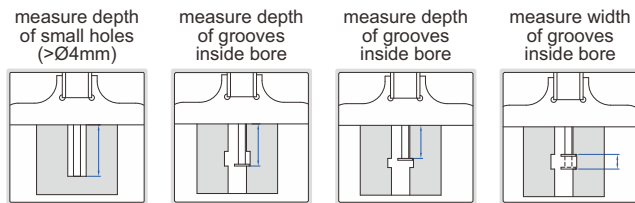
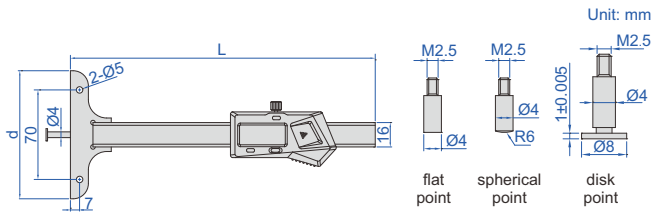

1148-100S



1148-120



1148-200



With data interface (data output cable code 7315-21 need receiver page 4, 7302-21 page 12, optional)

Code	Range *	Accuracy	L	d	Remark
1148-100S	0-100mm/0-4"	±0.02mm	200mm	45mm	
1148-100	0-100mm/0-4"	±0.02mm	200mm	85mm	
1148-120	0-120mm/0-4.7"	±0.03mm	300mm	101mm	one-hand use, with mounting holes for extension base
1148-200	0-200mm/0-8"	±0.03mm	300mm	101mm	with mounting holes for extension base
1148-300	0-300mm/0-12"	±0.04mm	400mm	101mm	with mounting holes for extension base

one-hand use of 1148-120 and 1148-120WL



extension base for 1148-120, 1148-120WL, 1148-200, 1148-200WL, 1148-300 and 1148-300WL (optional)



Built-in wireless (receiver code 7315-2/3/6/7/8/9 is required)

Code	Range *	Accuracy	L	d	Remark
1148-100SWL	0-100mm/0-4"	±0.02mm	200mm	45mm	
1148-100WL	0-100mm/0-4"	±0.02mm	200mm	85mm	
1148-120WL	0-120mm/0-4.7"	±0.03mm	300mm	101mm	one-hand use, with mounting holes for extension base
1148-200WL	0-200mm/0-8"	±0.03mm	300mm	101mm	with mounting holes for extension base
1148-300WL	0-300mm/0-12"	±0.04mm	400mm	101mm	with mounting holes for extension base

\*When disk points are used, the range is reduced by 10mm

### OPTIONAL DISK POINTS

Code	Description	H	Remark
1148-P101	0.5mm disk point	0.5±0.005mm	for narrow grooves
1148-P102	0.7mm disk point	0.7±0.005mm	for narrow grooves
1148-P103	1mm disk point	1±0.005mm	for grooves inside blind hole
1148-P104	0.5mm disk point	0.5±0.005mm	for grooves inside blind hole

1148-P101 (optional)

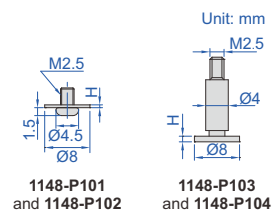



SHOCK PROOF

## DIAL DEPTH GAGES WITH ROUND BAR

3



1341-100

- Shockproof dial indicator
- Dial indicator graduation: 0.02mm
- Made of stainless steel

Code	Range	Accuracy	L
1341-100	0-100mm	±0.02mm	181mm
1341-200	0-200mm	±0.03mm	284mm

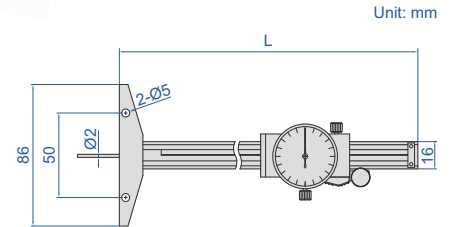

DATA OUTPUT

## DIGITAL POINT DEPTH GAGES

- Non waterproof
- Resolution: 0.01mm/0.0005"
- Buttons: on/off, zero, mm/inch
- Automatic power off, move the digital unit to turn on power
- Meet DIN862
- Battery CR2032
- Made of stainless steel

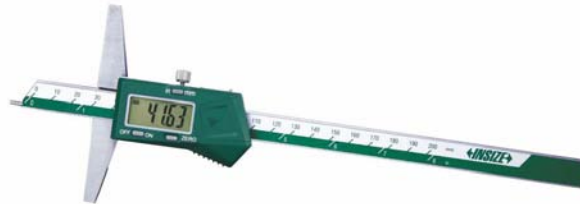

1143-200A

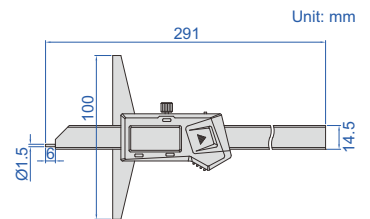

With data interface (data output cable code 7315-21 need receiver page 4, 7302-21 page 12, optional)

Code	Range	Accuracy
1143-200A	0-200mm/0-8"	±0.03mm

Built-in wireless (receiver code 7315-2/3/6/7/8/9 is required)

Code	Range	Accuracy
1143-200AWL	0-200mm/0-8"	±0.03mm

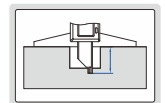

SHOCK PROOF

## DIAL DEPTH GAGES

- Shockproof dial indicator
- Made of stainless steel



1340-150

Code	Range	Graduation	Accuracy	L
1340-150	0-150mm	0.02mm	±0.03mm	232mm
1340-200	0-200mm	0.02mm	±0.03mm	282mm
1340-300	0-300mm	0.02mm	±0.04mm	382mm

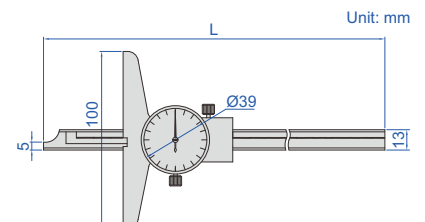

## VERNIER DEPTH GAGES (STANDARD TYPE)

POPULAR MODEL

3

- Made of stainless steel
- Satin chrome plated reading surface



1240-2001

### Graduation 0.05mm

Code	Range	Accuracy	L	d
1240-150	0-150mm	±0.05mm	245mm	100mm
1240-200	0-200mm	±0.05mm	282mm	100mm
1240-300	0-300mm	±0.08mm	382mm	100mm
1240-500	0-500mm	±0.09mm	585mm	150mm

### Graduation 0.02mm

Code	Range	Accuracy	L	d
1240-1501	0-150mm	±0.03mm	245mm	100mm
1240-2001	0-200mm	±0.03mm	282mm	100mm
1240-3001	0-300mm	±0.04mm	382mm <td 100mm	
1240-5001	0-500mm	±0.05mm	585mm	150mm

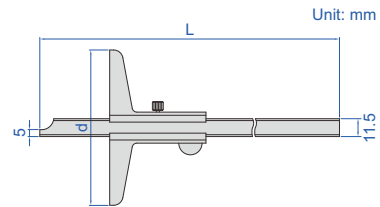

## VERNIER DEPTH GAGES

WITH MOUNTING HOLES FOR EXTENSION BASE



1247-2001

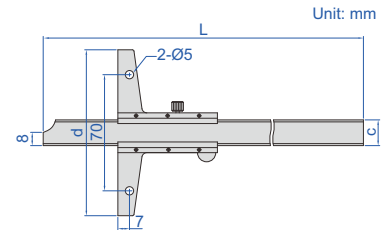

- Made of stainless steel
- Satin chrome plating finish on reading surface
- Optional accessory: extension base (code 6141)

extension base (optional)



6141 series

Range	L	c	d
0-150mm	240mm	16mm	100mm
0-200mm	290mm	16mm	100mm
0-300mm	390mm	16mm	100mm
0-600mm	704mm	16mm	150mm
0-1000mm	1124mm	16mm	200mm

Code	Range	Accuracy	Graduation
1247-150	0-150mm	±0.05mm	0.05mm
1247-200	0-200mm	±0.05mm	0.05mm
1247-300	0-300mm	±0.08mm	0.05mm
1247-600	0-600mm	±0.10mm	0.05mm
1247-1000	0-1000mm	±0.15mm	0.05mm

Code	Range	Accuracy	Graduation
1247-1501	0-150mm	±0.03mm	0.02mm
1247-2001	0-200mm	±0.03mm	0.02mm
1247-3001	0-300mm	±0.04mm	0.02mm
1247-6001	0-600mm	±0.05mm	0.02mm
1247-1001	0-1000mm	±0.07mm	0.02mm

WITH MOUNTING HOLES FOR EXTENSION BASE

## VERNIER DEPTH GAGES WITH FINE ADJUSTMENT



1249-1501

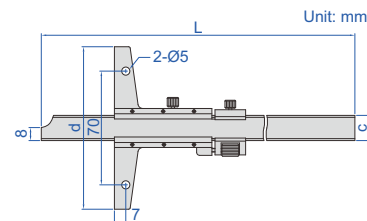

- With fine adjustment
- Made of stainless steel
- Satin chrome plating finish on reading surface
- Optional accessory: extension base (code 6141)

extension base (optional)

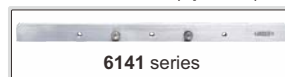

6141 series

### Graduation 0.02mm

Code	Range	Accuracy
1249-1501	0-150mm	±0.03mm
1249-2001	0-200mm	±0.03mm
1249-3001	0-300mm	±0.04mm

### Graduation 0.05mm

Code	Range	Accuracy
1249-150	0-150mm	±0.05mm
1249-200	0-200mm	±0.05mm
1249-300	0-300mm	±0.08mm

Range	L	c	d
0-150mm	256mm	16mm	100mm
0-200mm	306mm	16mm	100mm
0-300mm	406mm	16mm	100mm

WITH MOUNTING HOLES FOR EXTENSION BASE

## VERNIER HOOK DEPTH GAGES

extension base (optional)



6141 series



1248-1501

- Made of stainless steel
- Satin chrome plating finish on reading surface
- Optional accessory: extension base (code 6141)

### Graduation 0.05mm

Code	Range	Accuracy	L
1248-150	0-150mm	±0.05mm	266mm
1248-200	0-200mm	±0.05mm	316mm
1248-300	0-300mm	±0.08mm	416mm

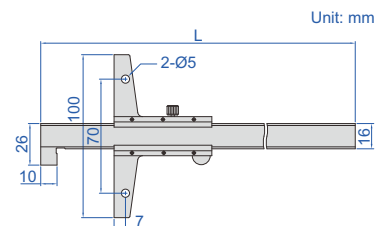

### Graduation 0.02mm

Code	Range	Accuracy	L
1248-1501	0-150mm	±0.03mm	266mm
1248-2001	0-200mm	±0.03mm	316mm
1248-3001	0-300mm	±0.04mm	416mm

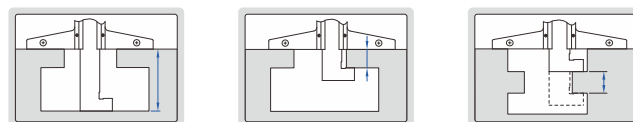

## VERNIER HOOK DEPTH GAGE

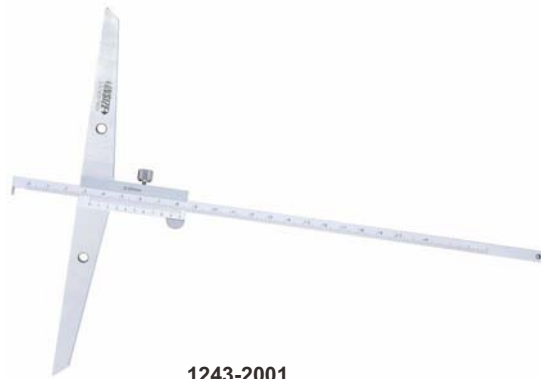

1243-2001

- Graduation 0.02mm
- Made of stainless steel
- Satin chrome plating finish on reading surface

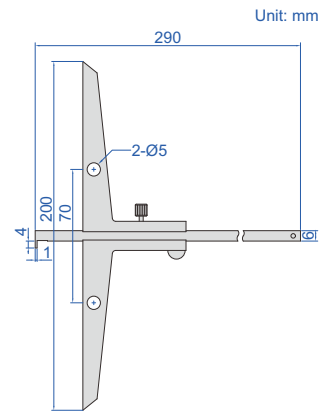

Unit: mm

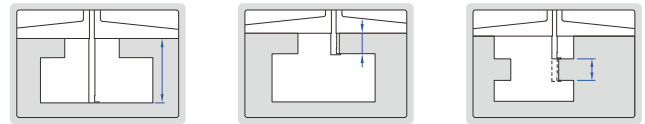

Code	Range	Accuracy
1243-2001	0-200mm	±0.04mm

## EXTENSION BASES



6141-260

- Supplied with two screws
- Made of stainless steel
- Suitable for depth gages series 1147, 1148, 1247, 1248 and 1249

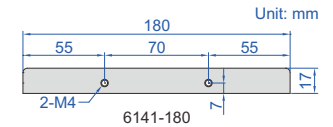
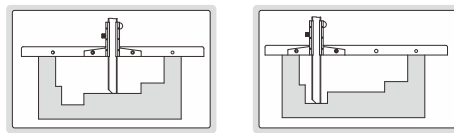

Unit: mm

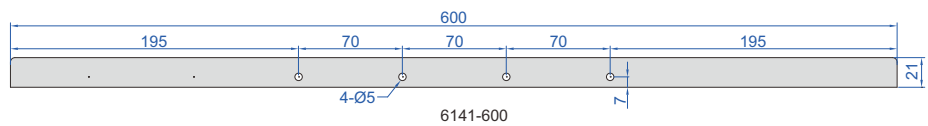
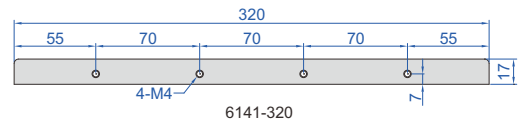
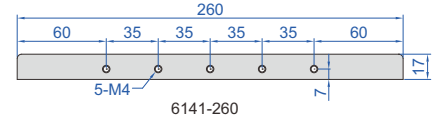

Code	Length
6141-180	180mm
6141-260	260mm
6141-320	320mm
6141-600	600mm

## MINI VERNIER DEPTH GAGE

- Graduation: 0.1mm
- Made of stainless steel



1244-30

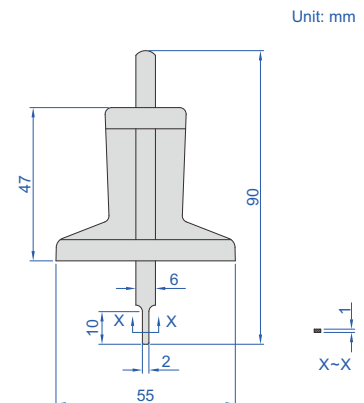

Unit: mm

Code	Range	Accuracy
1244-30	0-30mm	±0.10mm

DATA OUTPUT

### MINI DIGITAL DEPTH GAGES WITH ROUND BAR



- Non waterproof
- Measure depth of small groove and hole
- Resolution: 0.01mm/0.0005"
- Buttons: on/off, set, mm/inch, preset (+,-)
- Automatic power off, move the digital unit to turn on power
- Battery CR2032
- Made of stainless steel

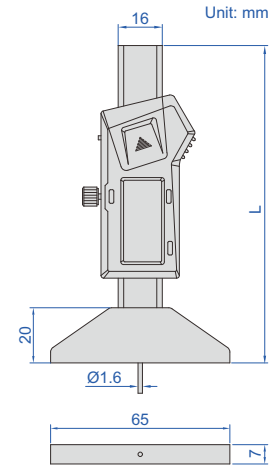

1140-25

With data interface (data output cable code 7315-21 need receiver page 4, 7302-21 page 12, optional)

Code	Range	Accuracy	L
1140-25	0-25mm/0-1"	±0.02mm	114mm
1140-50	0-50mm/0-2"	±0.02mm	140mm
1140-100	0-100mm/0-4"	±0.02mm	190mm
1140-150	0-150mm/0-6"	±0.03mm	236mm

Built-in wireless (receiver code 7315-2/3/6/7/8/9 is required)

Code	Range	Accuracy	L
1140-25WL	0-25mm/0-1"	±0.02mm	114mm
1140-50WL	0-50mm/0-2"	±0.02mm	140mm
1140-100WL	0-100mm/0-4"	±0.02mm	190mm
1140-150WL	0-150mm/0-6"	±0.03mm	236mm

### MINI DIGITAL DEPTH GAGES

DATA OUTPUT



- Non waterproof
- Measure depth of small groove and hole, also measure depth of tire tread
- Resolution: 0.01mm/0.0005"
- Buttons: on/off, zero, mm/inch
- Supplied with zero set surface
- Automatic power off, move the digital unit to turn on power
- Battery CR2032
- Made of stainless steel

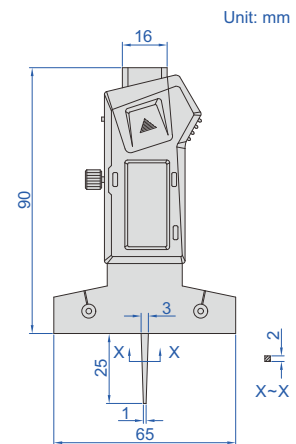

1145-25A

With data interface (data output cable code 7315-21 need receiver page 4, 7302-21 page 12, optional)

Code	Range	Accuracy
1145-25A	0-25mm/0-1"	±0.03mm

Built-in wireless (receiver code 7315-2/3/6/7/8/9 is required)

Code	Range	Accuracy
1145-25AWL	0-25mm/0-1"	±0.03mm

## DIAL DEPTH GAGES

3

- Accuracy:  $\pm 0.017\text{mm}$
- Stainless steel base
- Pointed tip



2343-102

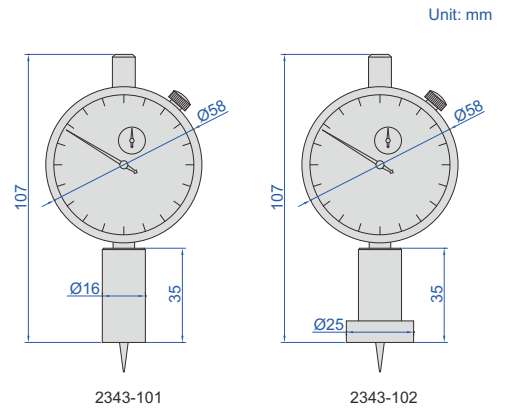

2343-101

2343-102

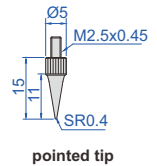

pointed tip

Code	Range	Dial indicator stroke	Dial indicator graduation	Base
2343-101	0-10mm	10mm	0.01mm	Ø16mm
2343-102	0-10mm	10mm	0.01mm	Ø25mm

## DIGITAL DEPTH GAGES

DATA OUTPUT

- Button function: on/off, zero, mm/inch, ABS, data preset, change measuring direction (time is adjustable)
- CR2032 battery, automatic power off
- Data output
- Stainless steel base
- Pointed tip
- Optional accessory: data output cable (code **7315-50M** need receiver page 5, **7302-40M** page 13)



2142-102

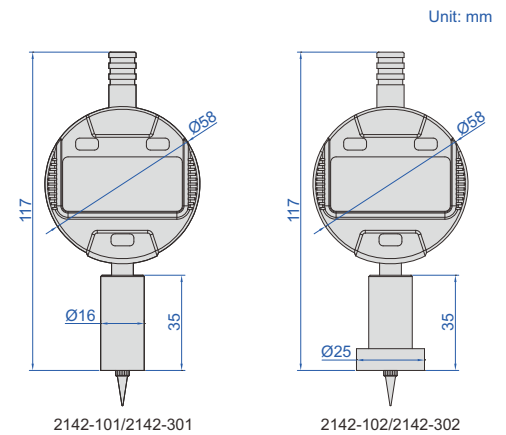

2142-101/2142-301

2142-102/2142-302

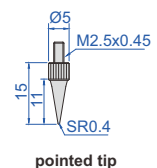

pointed tip

Code	Range	Digital indicator stroke	Digital indicator resolution	Accuracy	Base
2142-101	0-12.7mm/0-0.5"	12.7mm/0.5"	0.01mm/0.0005"	$\pm 20\mu\text{m}$	Ø16mm
2142-102	0-12.7mm/0-0.5"	12.7mm/0.5"	0.01mm/0.0005"	$\pm 20\mu\text{m}$	Ø25mm
2142-301	0-12.7mm/0-0.5"	12.7mm/0.5"	0.001mm/0.00005"	$\pm 5\mu\text{m}$	Ø16mm
2142-302	0-12.7mm/0-0.5"	12.7mm/0.5"	0.001mm/0.00005"	$\pm 5\mu\text{m}$	Ø25mm

## DIAL DEPTH GAGE

Unit: mm



2341-101A

- Accuracy:  $\pm 0.017\text{mm}$
- Stainless steel base
- Supplied with pointed tip and ball tip

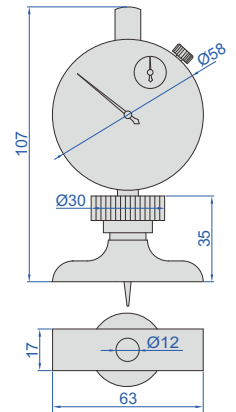
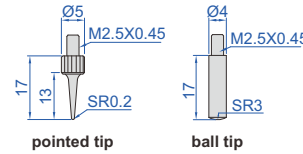

Code	Range	Dial indicator stroke	Dial indicator graduation
2341-101A	0-10mm	10mm	0.01mm

## DIAL DEPTH GAGES

Unit: mm



2342-202



2141-10 (optional),  
can be customized  
according to workpieces

- Dial indicator graduation: 0.01mm
- Accuracy:  $\pm 0.03\text{mm}$
- Stainless steel base
- Extension rods: 25mm (1 pc), 50mm (1 pc), 75mm (1 pc), 100mm (2 pcs)
- Supplied with pointed tip and ball tip
- Optional accessory:  
granite extension holder (code 2141-10)

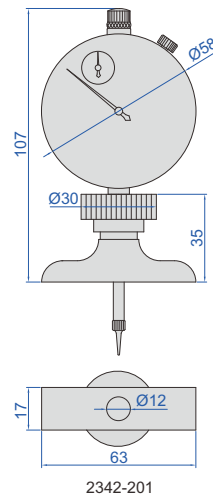
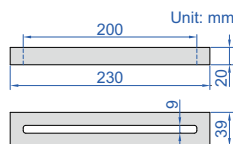

2342-201

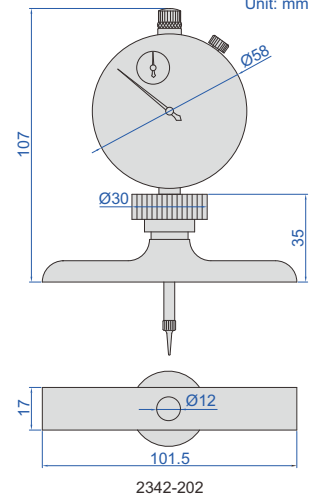

2342-202

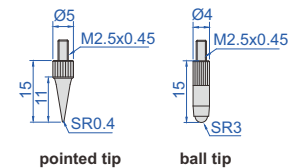

pointed tip

ball tip

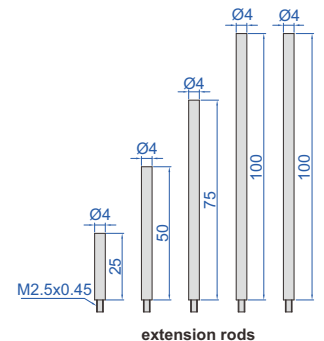
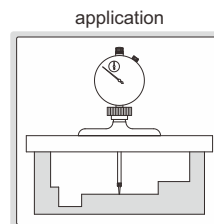

extension rods

Code	Range	Dial indicator stroke	Base
2342-201	0-300mm	30mm	63x17mm
2342-202	0-300mm	30mm	101.5x17mm

## DIGITAL DEPTH GAGES

DATA  
OUTPUT

3



2141-202A

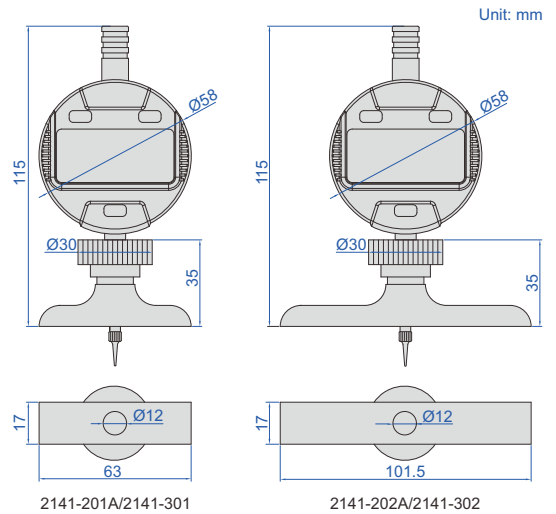

2141-201A/2141-301

2141-202A/2141-302

- Button function: on/off, zero, mm/inch, ABS, data preset, change measuring direction
- CR2032 battery, automatic power off (time is adjustable)
- Data output
- Stainless steel base
- Extension rods: 12.5mm (1 pc), 25mm (1 pc), 50mm (1 pc), 75mm (1 pc), 100mm (2 pcs)
- Supplied with pointed tip and ball tip
- Optional accessory: data output cable (code 7315-50M need receiver page 5, 7302-40M page 13), granite extension holder (code 2141-10)

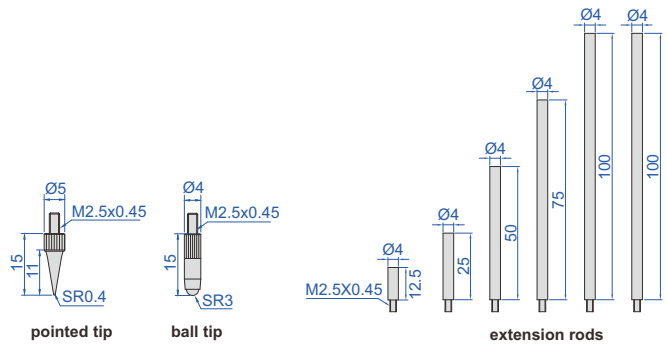

2141-10 (optional),  
can be customized  
according to workpieces

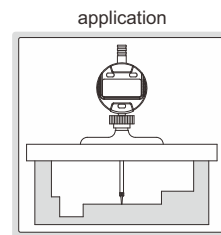
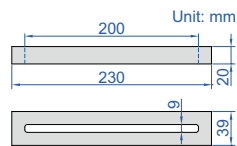

Code	Range	Digital indicator stroke	Digital indicator resolution	Accuracy	Base
2141-201A	0-300mm/0-12"	12.7mm/0.5"	0.01mm/0.0005"	±20µm	63x17mm
2141-202A	0-300mm/0-12"	12.7mm/0.5"	0.01mm/0.0005"	±20µm	101.5x17mm
2141-301	0-300mm/0-12"	12.7mm/0.5"	0.001mm/0.00005"	±5µm	63x17mm
2141-302	0-300mm/0-12"	12.7mm/0.5"	0.001mm/0.00005"	±5µm	101.5x17mm



DATA  
OUTPUT

## DIGITAL GROOVE GAGES



2145-202

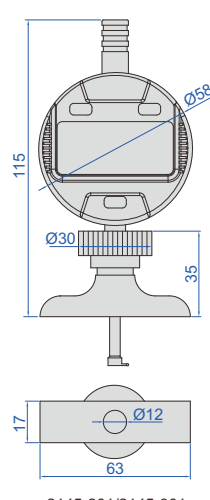

2145-201/2145-301

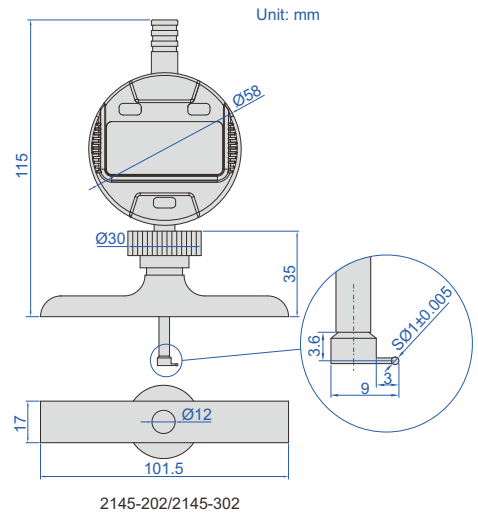

2145-202/2145-302

- Button function: on/off, zero, mm/inch, absolute/incremental measurement, data preset, change measuring direction
- CR2032 battery, automatic power off (time is adjustable)
- Data output
- Stainless steel base
- Supplied with extension rods: 12.5mm (1 pc), 25mm (1 pc), 50mm (1 pc)
- Supplied with groove point
- Optional accessory: data output cable (code 7315-50M need receiver page 5, 7302-40M page 13)

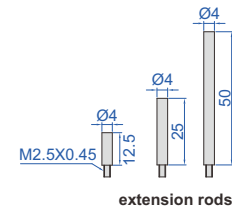

extension rods

measure width (b) and depth (a) of groove

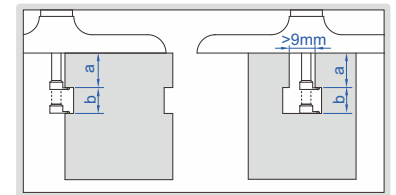

Code	Range (a)	Digital indicator stroke (b)	Digital indicator resolution	Accuracy	Base
2145-201	0-85mm/0-3.35"	12.7mm/0.5"	0.01mm/0.0005"	±20µm	63x17mm
2145-202	0-85mm/0-3.35"	12.7mm/0.5"	0.01mm/0.0005"	±20µm	101.5x17mm
2145-301	0-85mm/0-3.35"	12.7mm/0.5"	0.001mm/0.00005"	±5µm	63x17mm
2145-302	0-85mm/0-3.35"	12.7mm/0.5"	0.001mm/0.00005"	±5µm	101.5x17mm

DATA  
OUTPUT

## DIGITAL DEPTH GAGE (60° KNIFE EDGE BASE)

- Button function: on/off, zero, inch/mm, ABS, data preset, change measuring direction
- CR2032 battery, automatic power off (time is adjustable)
- Data output
- Stainless steel base with 60° knife edge
- Optional accessory: data output cable (code 7315-50M need receiver page 5, 7302-40M page 13)



front view

side view

2143-101

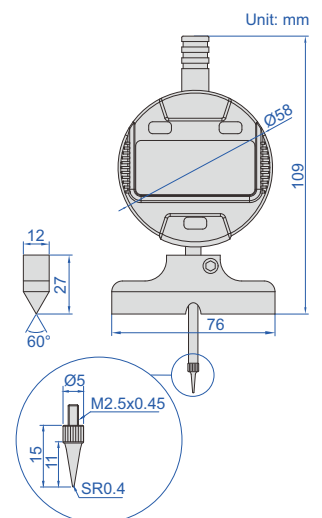

Code	Range	Digital indicator stroke	Digital indicator resolution	Accuracy
2143-101	0-12.7mm/0-0.5"	12.7mm/0.5"	0.01mm/0.0005"	±20µm

## DIGITAL DEPTH MICROMETERS

**IP65**  
WATERPROOF

**DATA**  
OUTPUT

3

- Resolution: 0.001mm/0.00005"
- Micrometer head accuracy: +/-3µm
- Rod accuracy: +/--(2+L/75)µm, L is the measuring range in mm
- Button function: on/off, set, mm/inch, data transmit
- IP65 dust/waterproof
- Data output
- Automatic power off
- Rods with flat end
- Ratchet stop
- Optional accessory: data output cable (code 7315-31 need receiver page 4, 7302-31 page 12)

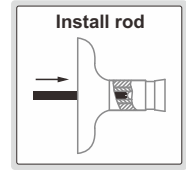

3540-50

Code	Range	Rods	L
3540-25	0-25mm/0-1"	1 pc	101.5mm
3540-50	0-50mm/0-2"	2 pcs	101.5mm
3540-100	0-100mm/0-4"	4 pcs	101.5mm
3540-150	0-150mm/0-6"	6 pcs	101.5mm
3540-300	0-300mm/0-12"	12 pcs	101.5mm
3540-B25	0-25mm/0-1"	1 pc	63mm
3540-B50	0-50mm/0-2"	2 pcs	63mm
3540-B100	0-100mm/0-4"	4 pcs	63mm
3540-B150	0-150mm/0-6"	6 pcs	63mm
3540-B300	0-300mm/0-12"	12 pcs	63mm

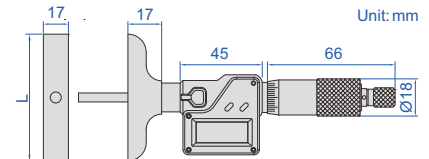
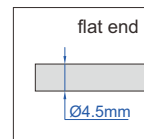

## DEPTH MICROMETERS

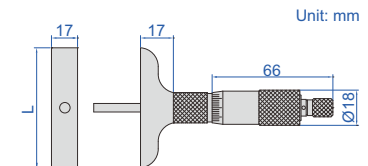
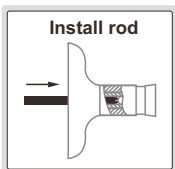

- Meet DIN863-2
- Graduation: 0.01mm
- Micrometer head accuracy: +/-3µm
- Rod accuracy: +/--(2+L/75)µm, L is the measuring range in mm
- Rods with flat or spherical end
- Ratchet stop

3240-100

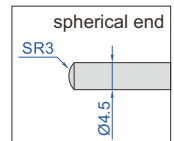
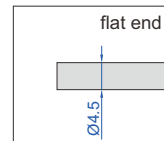

### Flat end

Code	Range	Rods	L
3240-25	0-25mm	1 pc	101.5mm
3240-50	0-50mm	2 pcs	101.5mm
3240-75	0-75mm	3 pcs	101.5mm
3240-100	0-100mm	4 pcs	101.5mm
3240-150	0-150mm	6 pcs	101.5mm
3240-200	0-200mm	8 pcs	101.5mm
3240-300	0-300mm	12 pcs	101.5mm
3240-B25	0-25mm	1 pc	63mm
3240-B50	0-50mm	2 pcs	63mm
3240-B100	0-100mm	4 pcs	63mm
3240-B150	0-150mm	6 pcs	63mm
3240-B300	0-300mm	12 pcs	63mm

### Spherical end

Code	Range	Rods	L
3240-25S	0-25mm	1 pc	101.5mm
3240-50S	0-50mm	2 pcs	101.5mm
3240-100S	0-100mm	4 pcs	101.5mm
3240-150S	0-150mm	6 pcs	101.5mm
3240-300S	0-300mm	12 pcs	101.5mm
3240-B25S	0-25mm	1 pc	63mm
3240-B50S	0-50mm	2 pcs	63mm
3240-B100S	0-100mm	4 pcs	63mm
3240-B150S	0-150mm	6 pcs	63mm
3240-B300S	0-300mm	12 pcs	63mm

- Meet DIN863-2
- Graduation: 0.01mm
- Micrometer head accuracy:  $\pm 3\mu\text{m}$
- Rod accuracy:  $\pm (2+L/75)\mu\text{m}$ , L is the measuring range in mm
- Rods with flat end
- Ratchet stop

## DEPTH MICROMETERS

Code	Range	Rods	L
3241-25	0-25mm	1 pc	101.5mm
3241-50	0-50mm	2 pcs	101.5mm
3241-75	0-75mm	3 pcs	101.5mm
3241-100	0-100mm	4 pcs	101.5mm
3241-150	0-150mm	6 pcs	101.5mm
3241-200	0-200mm	8 pcs	101.5mm
3241-300	0-300mm	12 pcs	101.5mm
3241-B25	0-25mm	1 pc	63mm
3241-B50	0-50mm	2 pcs	63mm
3241-B100	0-100mm	4 pcs	63mm
3241-B150	0-150mm	6 pcs	63mm
3241-B300	0-300mm	12 pcs	63mm



3241-100

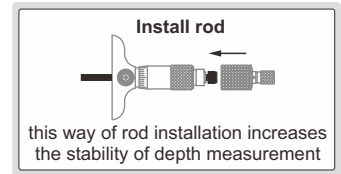
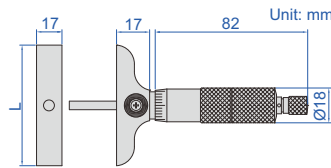

## CYLINDER GAGE BLOCKS FOR DEPTH MICROMETERS

Code	Length (L)
4179-25 *	25mm
4179-50 *	50mm
4179-75 *	75mm
4179-100 *	100mm
4179-125 *	125mm
4179-150 *	150mm
4179-175 *	175mm
4179-200 *	200mm
4179-225 *	225mm
4179-250 *	250mm
4179-275 *	275mm

\* Supplied with manufacturer inspection certificate



4179-25

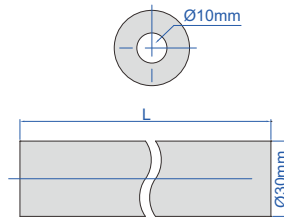

- Made of special alloy steel, hardness HRC64, high stability, wear resistance and easy combination
- Meet ISO3650 grade 1



application



## DEPTH MICROMETER CHECKERS

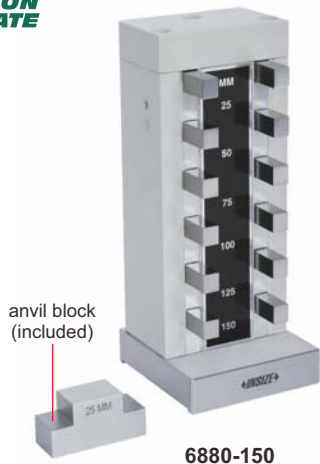

6880-150

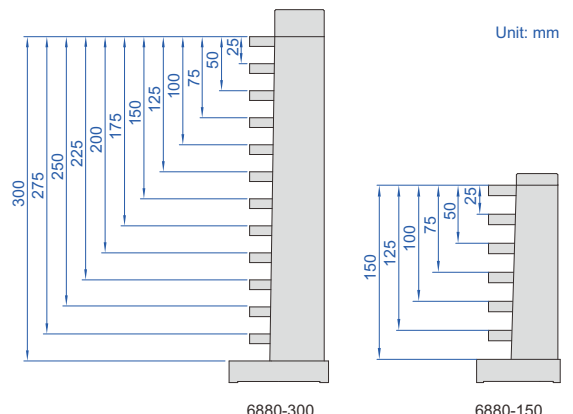

6880-300

6880-150

Code	Size	Range (mm)	Accuracy
6880-150 *	0-150mm	25, 50, 75, 100, 125, 150	$\pm 2\mu\text{m}$
6880-300 *	0-300mm	25, 50, 75, 100, 125, 150, 175, 200, 225, 250, 275, 300	$\pm 3\mu\text{m}$

\* Supplied with manufacturer inspection certificate

- To check depth micrometers and set zero
- Constructed with steel gage blocks
- Supplied with anvil block



Digital Height Gages  
Page 85-87



Dial Indicator Stands  
Page 87



Height Gages  
Page 88-92



Height Gage Checkers  
Page 92



DATA OUTPUT

# HIGH PRECISION DIGITAL HEIGHT GAGES

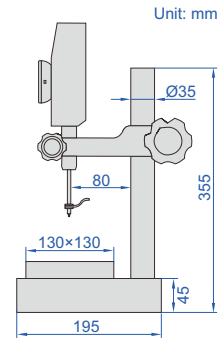

1155-505

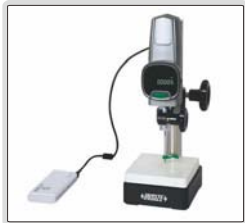

power supplied by charge pal

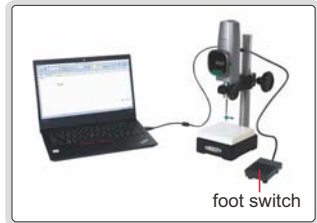

data transmitted to Excel without software; short press the foot switch to transmit data, long press to zero

measuring tips (included)

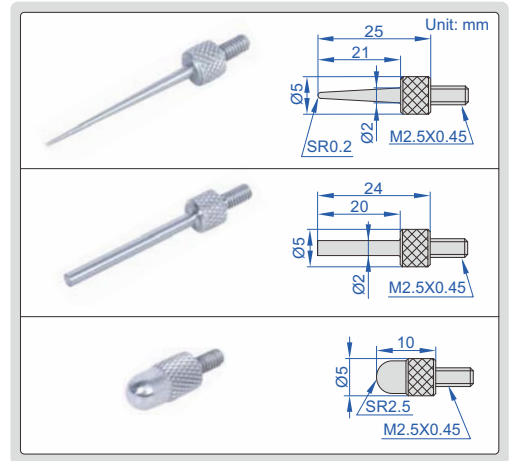

- High stability, high precision, high response speed (5000mm/s)
- High brightness LED display
- Ceramic base flatness: 1µm

Code	Range	Resolution	Accuracy (20°C)	Measuring force	Output	Power supply
1155-505	0~50mm	0.5µm/0.00002" (can switch to: 1µm/0.00005")	1.5µm	0.8~1.2N	USB	5V/1A (adapter or charge pal)
1155-510	0~50mm	0.1µm/0.000005" (can switch to: 1µm/0.00005")	1µm	0.8~1.2N	USB	5V/1A (adapter or charge pal)

STANDARD DELIVERY

Main unit	1 pc
-----------	------

OPTIONAL ACCESSORY

Contact point	code 6282
Charge pal	1155-5-POB
Data output cable (including foot switch)	1155-5-FOS

## DIGITAL HEIGHT GAGES

DATA  
OUTPUT



4



1157-501

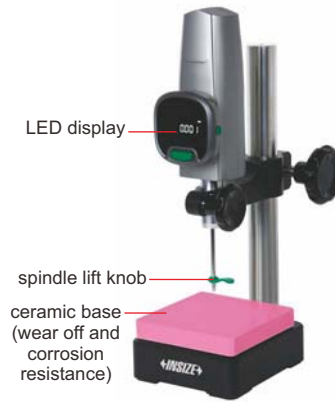
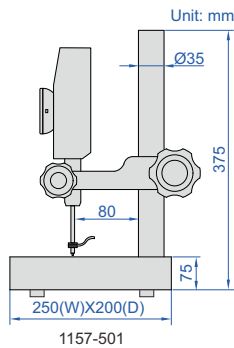

1157-502

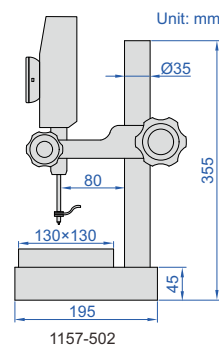

- Buttons: on/off, zero, mm/inch, mix/min/mix-min
- High response speed (5000mm/s)
- High brightness LED display

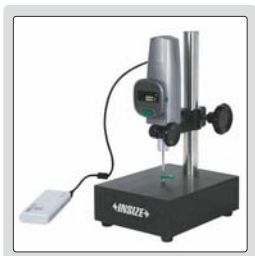

power supplied by charge pal

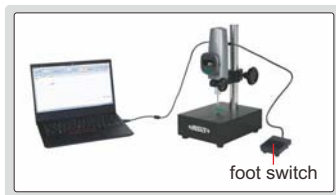

data transmitted to Excel without software; short press the foot switch to transmit data, long press to zero

measuring tips (included)

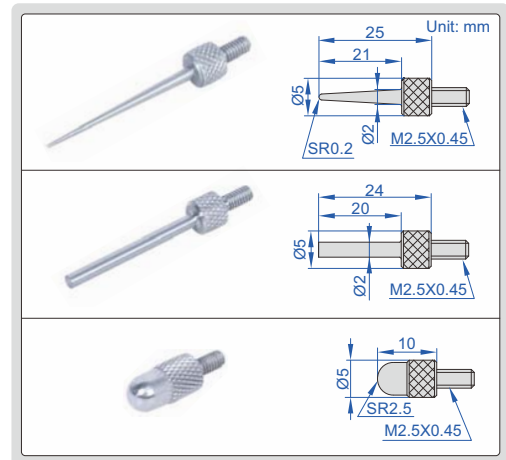

Code	Range	Resolution	Accuracy (20°C)	Measuring force	Output	Power supply	Base
1157-501	0~50mm	1µm/0.00005"	3µm	0.8~1.2N	USB	5V/1A (adapter or charge pal)	granite (flatness: 2µm)
1157-502	0~50mm	1µm/0.00005"	3µm	0.8~1.2N	USB	5V/1A (adapter or charge pal)	ceramic (flatness: 1µm)

### OPTIONAL ACCESSORY

Contact point	code 6282
Charge pal	1155-5-POB
Data output cable (including foot switch)	1155-5-FOS

### STANDARD DELIVERY

Main unit	1 pc
-----------	------

DATA  
OUTPUT

## LARGE RANGE DIGITAL HEIGHT GAGE

- High stability, high precision, high response speed (5000mm/s)
- High brightness LED display
- Granite base flatness: 3µm

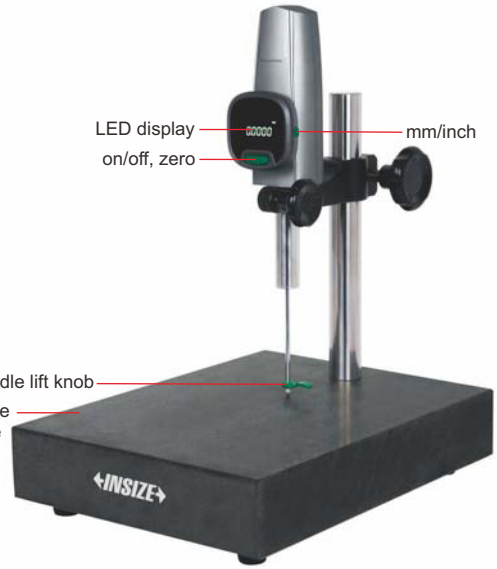
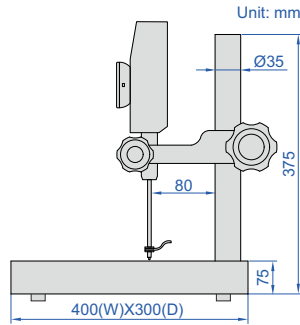

1158-100

measuring tips (included)

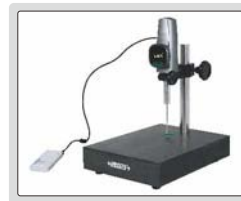
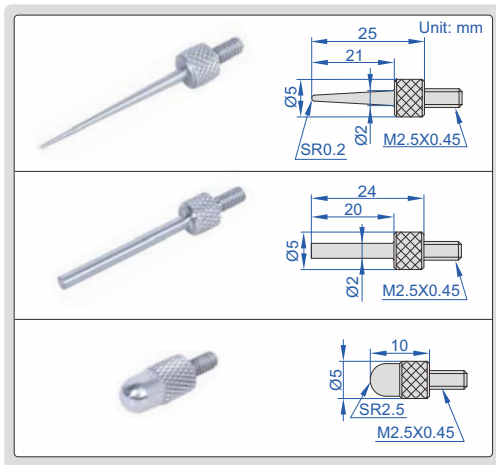

power supplied by charge pal



data transmitted to Excel without software; short press the foot switch to transmit data, long press to zero

Code	Range	Resolution	Accuracy (20°C)	Measuring force	Output	Power supply
1158-100	0~100mm	0.1µm/0.000005" (can switch to: 1µm/0.00005")	3µm	0.8~1.2N	USB	5V/1A (adapter or charge pal)

### STANDARD DELIVERY

Main unit	1 pc
-----------	------

### OPTIONAL ACCESSORY

Contact point	code 6282
Charge pal	1155-5-POB
Data output cable (including foot switch)	1155-5-FOS

## DIAL INDICATOR STANDS

REFER TO PAGE  
273-275 FOR DETAILS



6862-1001



6864-250T



6867-250

## DIGITAL HEIGHT GAGES

DATA  
OUTPUT

4

- Non waterproof
- Resolution: 0.01mm/0.0005"
- Buttons: on/off, zero, mm/inch, ABS/INC, data hold, TOL, set
- ABS/INC is for absolute and incremental measurement
- TOL is for tolerance measurement
- Carbide tipped scriber
- Made of stainless steel (except the base)
- LR44 battery, data output
- Supplied with dial test indicator holder
- Supplied with dust cover (except 1150-1500/2000)
- Optional accessory: data output cable (code 7302-SPC7 page 13, keyboard format), wireless data transmission (transmitter code 7315-1150 need receiver page 6), clamp for protractors (code 2372-CLAMP, for 1150-300)

scriber (included)

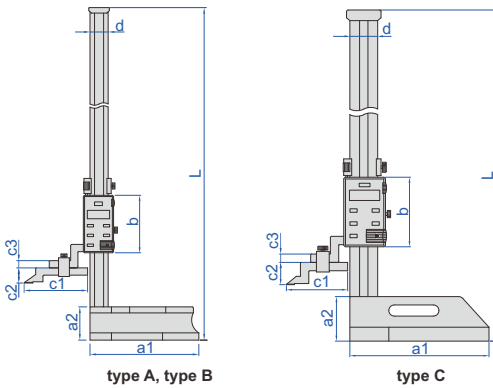
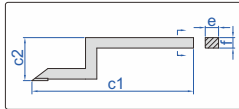

1150-1000

1150-500

1150-300

clamp for protractors (optional)  
for 1150-300

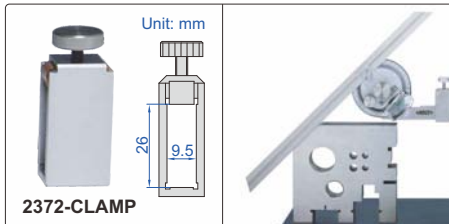

dial test indicator holder (included)

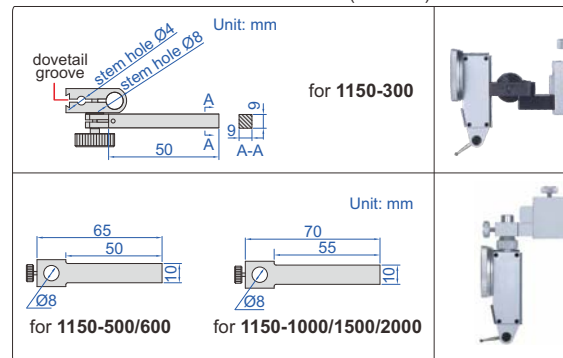

Code	Range	Type	Accuracy	L	a1	a2	b	c1	c2	c3	d	e	f
1150-300	0-300mm/0-12"	A	±0.04mm	485mm	138mm	45mm	95mm	80mm	30mm	10mm	28mm	9mm	9mm
1150-500	0-500mm/0-20"	B	±0.06mm	720mm	180mm	55mm	95mm	103mm	25mm	12mm	30mm	10mm	12mm
1150-600	0-600mm/0-24"	B	±0.06mm	820mm	180mm	55mm	95mm	103mm	25mm	12mm	30mm	10mm	12mm
1150-1000	0-1000mm/0-40"	C	±0.08mm	1275mm	250mm	80mm	125mm	110mm	39mm	15mm	50mm	10mm	15mm
1150-1500	0-1500mm/0-60"	C	±0.12mm	1790mm	280mm	80mm	125mm	110mm	39mm	15mm	50mm	10mm	15mm
1150-2000	0-2000mm/0-80"	C	±0.16mm	2290mm	280mm	80mm	125mm	110mm	39mm	15mm	50mm	10mm	15mm





DIGITAL HEIGHT GAGES WITH DRIVING WHEEL

DATA OUTPUT

- Non waterproof
- Resolution: 0.01mm/0.0005"
- Buttons: on/off, zero, mm/inch, preset +, preset -, ABS/INC
- Automatic power off, move the digital unit to turn on power
- Carbide tipped scriber
- Made of stainless steel
- Battery CR2032
- Data output
- Supplied with dust cover
- With dial test indicator holder
- Optional accessory: data output cable (code 7302-22 page 12), wireless data transmission (transmitter code 7315-22 need receiver page 4), clamp for protractors (code 2372-CLAMP)

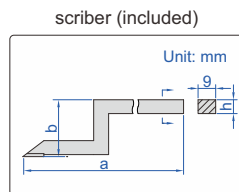
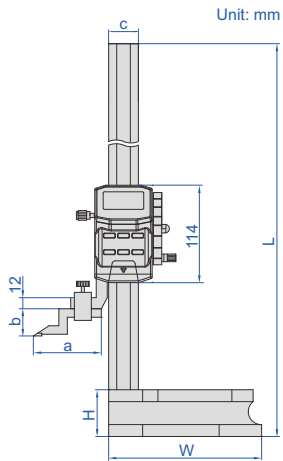

dial test indicator holder (included)

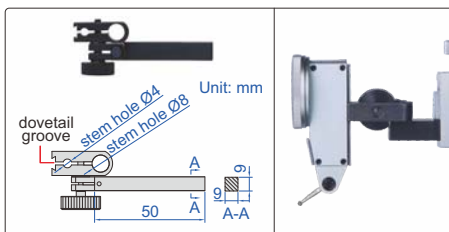

clamp for protractors (optional)

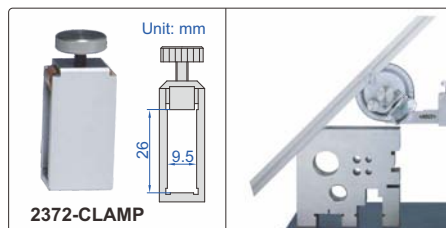

Code	Range	Accuracy	L	W	H	a	b	c	h
1156-300*	0-300mm/0-12"	±0.03mm	515mm	180mm	55mm	80mm	30mm	35mm	9mm
1156-600*	0-600mm/0-24"	±0.05mm	815mm	180mm	55mm	80mm	30mm	35mm	9mm
1156-1000*	0-1000mm/0-40"	±0.07mm	1220mm	265mm	70mm	92mm	48mm	40mm	12mm

\* Supplied with manufacturer inspection certificate

## DIGITAL HEIGHT GAGES

dial test indicator holder (included)

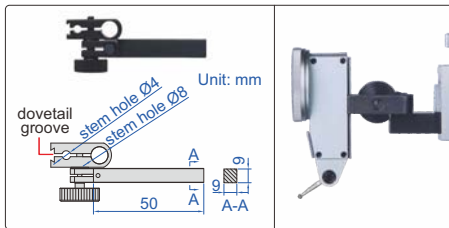

1151-300A

scraper (included)

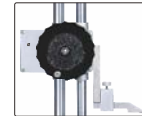
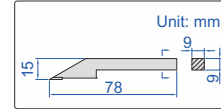

driving wheel on the back

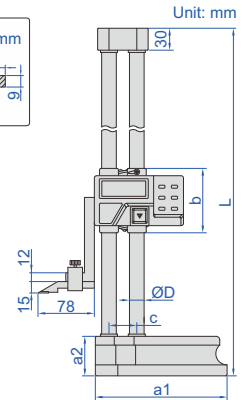

- Non waterproof
- Resolution: 0.01mm/0.0005"
- Buttons: on/off, zero, mm/inch, data hold, ABS/INC, preset
- ABS/INC is for absolute and incremental measurement
- Automatic power off, move the digital unit to turn on power
- Carbide tipped scriber
- Made of stainless steel
- Battery CR2032, data output
- With driving wheel
- With dial test indicator holder
- Supplied with dust cover
- Optional accessory: data output cable (code 7302-1151 page 13, keyboard format), wireless data transmission (transmitter code 7315-1151 need receiver page 6), clamp for protractors (code 2372-CLAMP)

clamp for protractors (optional)

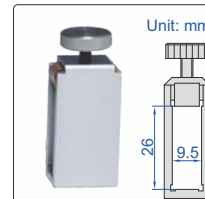

2372-CLAMP



Code	Range	Accuracy	L	a1	a2	b	c	ØD
1151-300A	0-300mm/0-12"	±0.04mm	475	135	43	84	33	15
1151-450A	0-450mm/0-18"	±0.05mm	660	180	54	88	38	20
1151-600A	0-600mm/0-24"	±0.05mm	810	180	54	88	38	20

## DIAL HEIGHT GAGES

dial test indicator holder (included)

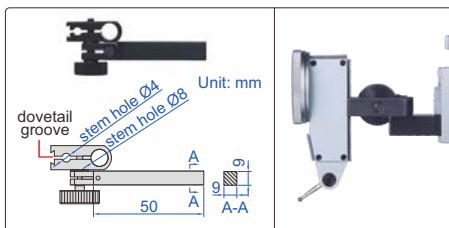

1351-300

scraper (included)

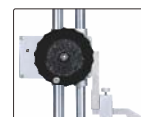
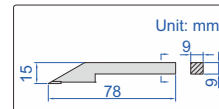

driving wheel on the back

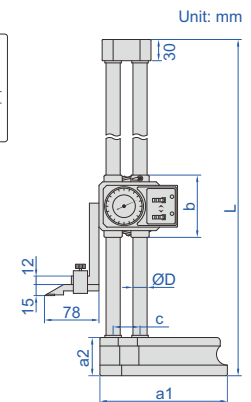

- Dial indicator graduation: 0.01mm
- One counter reads in the plus direction and another in the minus direction, so incremental measurement can be made in either direction
- Carbide tipped scriber
- Made of stainless steel (except the base)
- With driving wheel
- With dial test indicator holder
- Supplied with dust cover
- Optional accessory: clamp for protractors (code 2372-CLAMP)

clamp for protractors (optional)

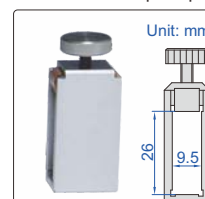

2372-CLAMP



Code	Range	Accuracy	L	a1	a2	b	c	ØD
1351-300	0-300mm	±0.04mm	475	135	43	84	33	15
1351-450	0-450mm	±0.05mm	660	180	54	88	38	20
1351-600	0-600mm	±0.05mm	810	180	54	88	38	20

DATA OUTPUT

- Non waterproof
- Resolution: 0.01mm/0.0005"
- Buttons: on/off, zero, mm/inch
- Automatic power off, move the digital unit to turn on power
- Carbide tipped scriber
- With fine adjustment
- Made of stainless steel
- Battery CR2032
- Optional accessory: dial test indicator holder (code 7151-CL1)

With data interface (data output cable code 7315-21 need receiver page 4, 7302-21 page 12, optional)

Code	Range	Accuracy
1154-150	0-150mm/0-6"	±0.03mm

Built-in wireless (receiver code 7315-2/3/6/7/8/9 is required)

Code	Range	Accuracy
1154-150WL	0-150mm/0-6"	±0.03mm

1154-150

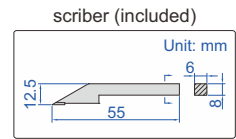
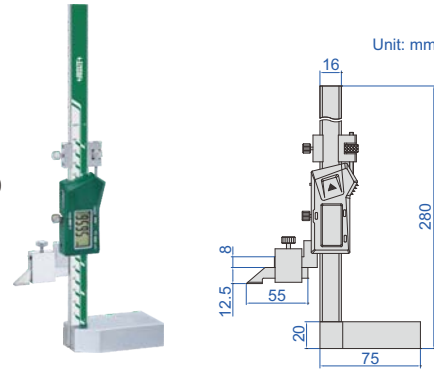

dial test indicator holder (optional)

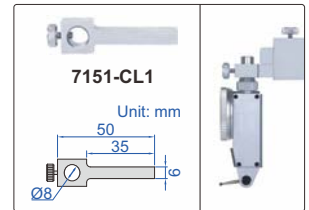

MINI DIGITAL HEIGHT GAGES

MINI VERNIER HEIGHT GAGES

- Graduation: 0.02mm/0.001"
- Carbide tipped scriber
- Made of stainless steel (except the base)
- Satin chrome plated scale
- Optional accessory: dial test indicator holder (code 7151-CL1)

dial test indicator holder (optional)

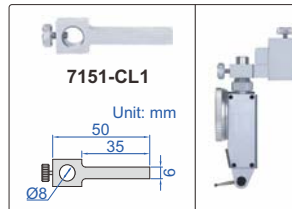

scriber (included)

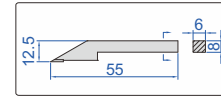

Unit: mm

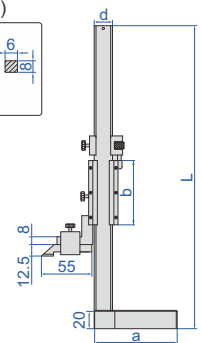

1253-200

Code	Range	Accuracy	L	a	b	d
1253-150	0-150mm/0-6"	±0.03mm	265	75	57	16
1253-200	0-200mm/0-8"	±0.03mm	325	90	70	20

VERNIER HEIGHT GAGES

- Graduation: 0.02mm/0.001"
- Adjustable main scale to set zero
- Carbide tipped scriber
- Made of stainless steel (except the base)
- Satin chrome plated scale
- Supplied with magnifier
- With fine adjustment
- Supplied with dust cover
- Optional accessory: dial test indicator holder (code 6293-6), clamp for protractors (code 2372-CLAMP)

scriber (included)

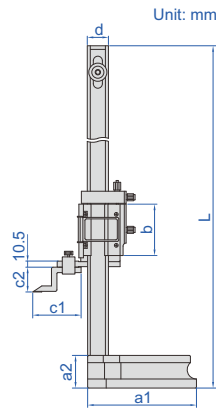
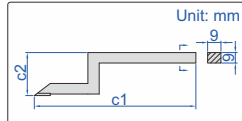

1250-300

clamp for protractors (optional)

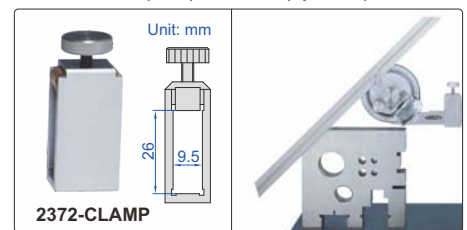

dial test indicator holder (optional)

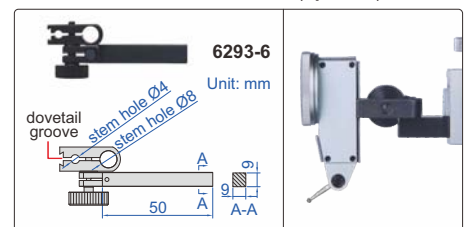

Code	Range	Accuracy	L	a1	a2	b	c1	c2	d
1250-300	0-300mm/0-12"	±0.04mm	545	135	43	75	80	30	28
1250-450	0-450mm/0-18"	±0.05mm	720	180	54	85	80	41	35
1250-600	0-600mm/0-24"	±0.05mm	870	180	54	85	80	41	35

## VERNIER HEIGHT GAGES (BASIC TYPE)

- Graduation: 0.02mm/0.001"
- Carbide tipped scriber
- Made of stainless steel (except the base)
- Satin chrome plated scale
- With dial test indicator holder
- Supplied with dust cover

POPULAR MODEL

dial test indicator holder (included)

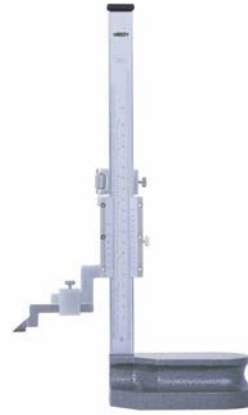
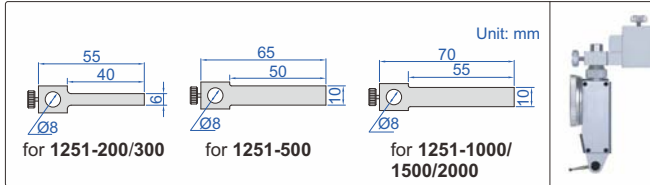

1251-200

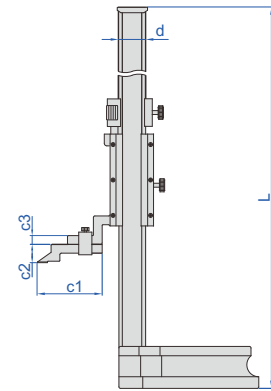

scriber (included)

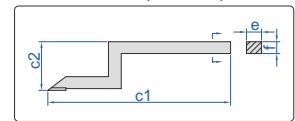

Code	Range	Accuracy	L	c1	c2	c3	d	e	f
1251-200	0-200mm/0-8"	±0.03mm	370	76	25	10	23	6	8
1251-300	0-300mm/0-12"	±0.04mm	470	76	25	10	23	6	8
1251-500	0-500mm/0-20"	±0.05mm	720	105	25	12	30	10	12
1251-1000	0-1000mm/0-40"	±0.07mm	1275	110	39	15	50	10	15
1251-1500	0-1500mm/0-60"	±0.11mm	1790	110	39	15	50	10	15
1251-2000	0-2000mm/0-80"	±0.14mm	2290	110	39	15	50	10	15

## SCRIBERS FOR HEIGHT GAGES

- Carbide tipped



7150-SC3

Code	For height gages	Type	c1	c2	D	E
7150-SC2	1150-500, 1150-600	A	103mm	25mm	10mm	12mm
7150-SC3	1150-1000, 1150-1500, 1150-2000	A	110mm	39mm	10mm	15mm
7150-SC4	1351-300, 1351-450, 1351-600, 1151-300A, 1151-450A, 1151-600A	B	78mm	15mm	9mm	9mm
7150-SC6	1250-300, 1156-300, 1156-600, 1150-300	A	80mm	30mm	9mm	9mm
7150-SC7	1250-450, 1250-600	A	80mm	41mm	9mm	9mm
7150-SC9	1253-150, 1253-200, 1154-150	B	55mm	12.5mm	6mm	8mm
7150-SC10	1156-1000	A	92mm	48mm	9mm	12mm

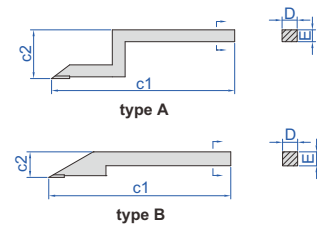

## CALIPER/HEIGHT GAGE CHECKERS

REFER TO PAGE 332 FOR DETAILS

horizontal use



vertical use



6884-300



Carbon Fiber Comparison Gages  
Page 94



Comparison Gages  
Page 95-96



Internal And External Diameter  
Comparison Instruments  
Page 97-98



Outside Diameter Measuring Stands  
Page 99

## CARBON FIBER COMPARISON GAGES

CARBON FIBER RODS, LIGHT WEIGHT, NOT EASY TO DEFORM, NO TEMPERATURE EXPAND, SUITABLE FOR THIN-WALL WORKPIECES AND LARGE-SIZE WORKPIECES

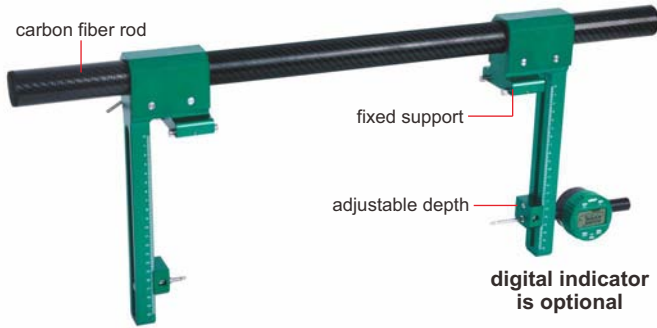

measure outer diameter



measure inside diameter, minimum diameter is 220mm

2931-D1000B



- Measure outer diameter, inside diameter, holes distance and cylindrical workpiece length
- Carbon fiber rods, light weight, not easy to deform, no temperature expand
- Optional accessory: cylinder gage blocks (code 4001), digital indicators (code 2138-25SP/2139-25SP/2103-25SP/2104-25SP)

Code	Maximum measuring range (L)	Measuring depth (H)	Repeatability	Weight
2931-D1000A	1000mm	0-100mm	5µm	2.0kg
2931-D1000B	1000mm	0-200mm	10µm	2.3kg
2931-D1000C	1000mm	0-300mm	25µm	2.6kg
2931-D1500A	1500mm	0-100mm	8µm	2.3kg
2931-D1500B	1500mm	0-200mm	15µm	2.6kg
2931-D1500C	1500mm	0-300mm	30µm	2.9kg
2931-D2000A	2000mm	0-100mm	10µm	2.6kg
2931-D2000B	2000mm	0-200mm	20µm	2.9kg
2931-D2000C	2000mm	0-300mm	35µm	3.2kg
2931-D2500A	2500mm	0-100mm	12µm	2.9kg
2931-D2500B	2500mm	0-200mm	25µm	3.2kg
2931-D2500C	2500mm	0-300mm	50µm	3.5kg
2931-D3000A	3000mm	0-100mm	14µm	3.2kg
2931-D3000B	3000mm	0-200mm	30µm	3.5kg
2931-D3000C	3000mm	0-300mm	60µm	3.8kg
2931-D4000A	4000mm	0-100mm	16µm	3.8kg
2931-D4000B	4000mm	0-200mm	35µm	4.1kg
2931-D4000C	4000mm	0-300mm	65µm	4.4kg
2931-D5000A	5000mm	0-100mm	25µm	4.4kg
2931-D5000B	5000mm	0-200mm	40µm	4.7kg
2931-D5000C	5000mm	0-300mm	70µm	5.0kg
2931-D6000A	6000mm	0-100mm	28µm	8.4kg
2931-D6000B	6000mm	0-200mm	50µm	8.8kg
2931-D6000C	6000mm	0-300mm	80µm	9.2kg
2931-D7000A	7000mm	0-100mm	30µm	9.2kg
2931-D7000B	7000mm	0-200mm	55µm	9.6kg
2931-D7000C	7000mm	0-300mm	100µm	10kg
2931-D8000A	8000mm	0-100mm	32µm	10kg
2931-D8000B	8000mm	0-200mm	60µm	10.4kg
2931-D8000C	8000mm	0-300mm	110µm	10.8kg
2931-D9000A	9000mm	0-100mm	35µm	10.7kg
2931-D9000B	9000mm	0-200mm	70µm	11.1kg
2931-D9000C	9000mm	0-300mm	120µm	11.5kg

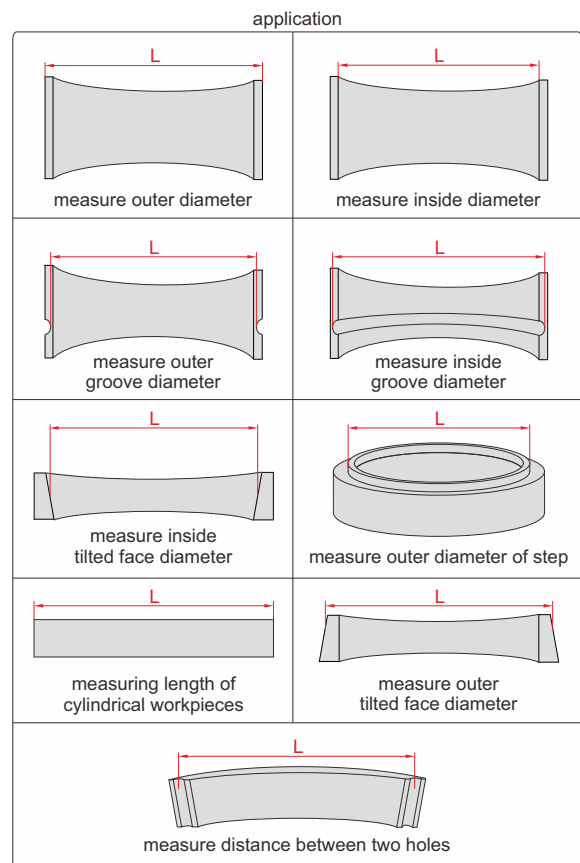
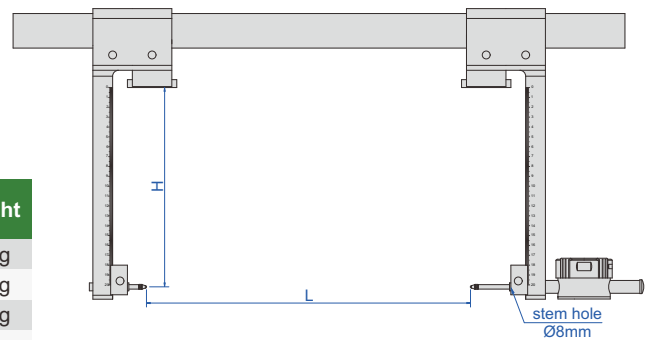

**CUSTOMIZABLE MEASURING JAWS AND POINTS**

**COMPARISON GAGES**



digital indicator is optional

measure external diameter  
2252-110



digital indicator is optional

measure internal diameter  
2252-220

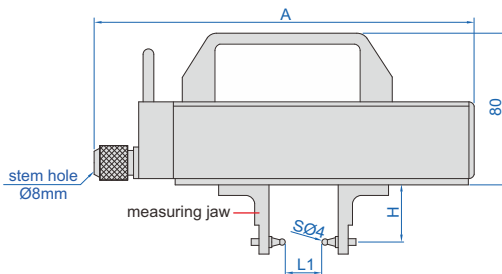

2252-101, 2252-102, 2252-110 and 2252-120

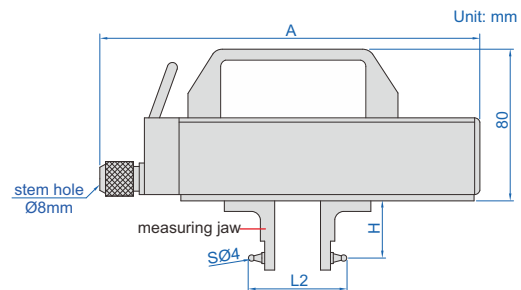

2252-201, 2252-202, 2252-210 and 2252-220

- Measure external diameter, internal diameter and over-pin diameter of gears
- Total range of movable point: 8mm, effective range of movable point:  $\pm 2$ mm
- Optional accessory: digital indicator (code **2138-10F**), gage block grade 1 (**4101-B** series)

**Measure external diameter**

Code	Range of external diameter (L1)	Accuracy*	Repeatability	A	H
2252-101	0-100mm/0-4"	$\pm 5\mu\text{m}$	1 $\mu\text{m}$	245mm	40mm
2252-102	0-170mm/0-6.6"	$\pm 5\mu\text{m}$	1 $\mu\text{m}$	315mm	40mm
2252-110	0-100mm/0-4"	$\pm 5\mu\text{m}$	2 $\mu\text{m}$	245mm	60mm
2252-120	0-170mm/0-6.6"	$\pm 5\mu\text{m}$	2 $\mu\text{m}$	315mm	60mm

**Measure internal diameter**

Code	Range of external diameter (L2)	Accuracy*	Repeatability	A	H
2252-201	20-130mm/0.8-5.1"	$\pm 5\mu\text{m}$	1 $\mu\text{m}$	195mm	40mm
2252-202	20-200mm/0.8-7.8"	$\pm 5\mu\text{m}$	1 $\mu\text{m}$	265mm	40mm
2252-210	20-130mm/0.8-5.1"	$\pm 5\mu\text{m}$	2 $\mu\text{m}$	195mm	60mm
2252-220	20-200mm/0.8-7.8"	$\pm 5\mu\text{m}$	2 $\mu\text{m}$	265mm	60mm

\*Within  $\pm 2$ mm effective range



external diameter measurement application

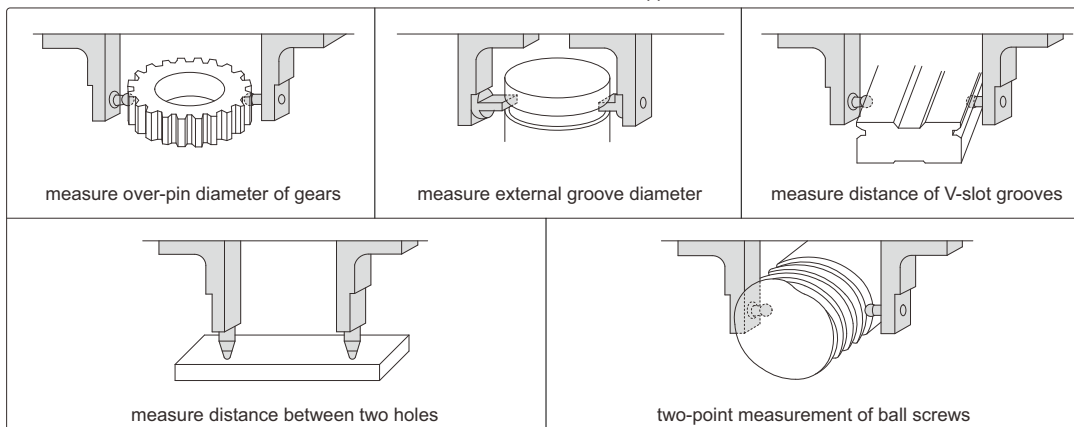

To be continued

Continued from previous page

internal diameter measurement application

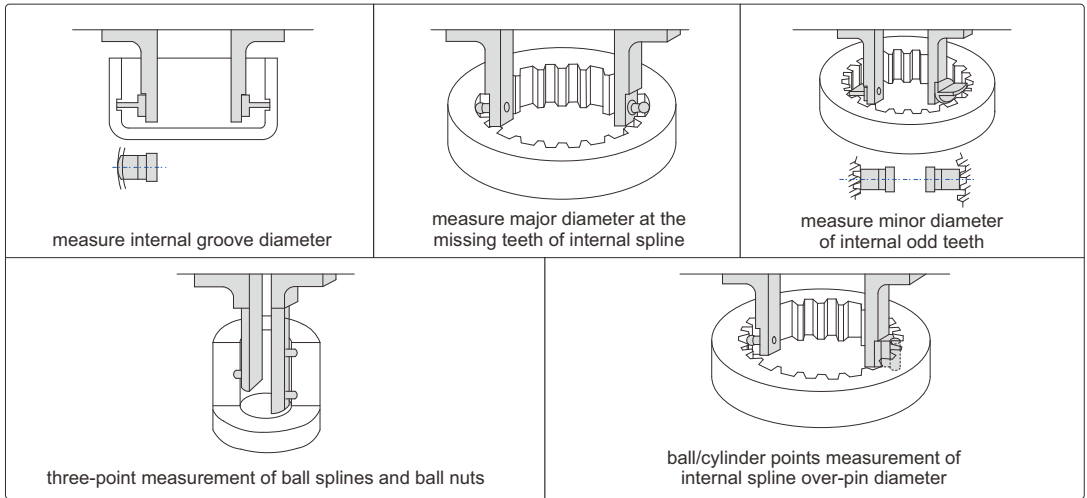

customizable points

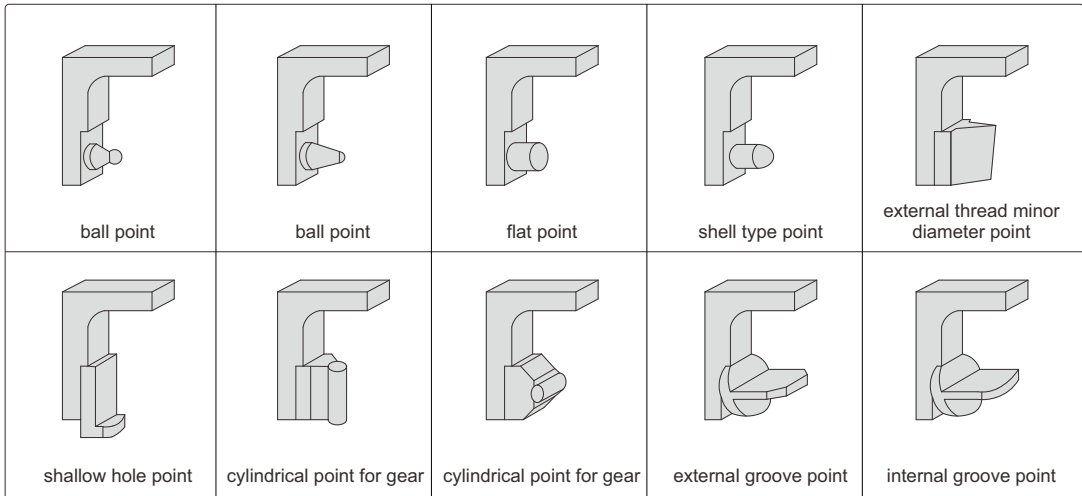

customizable measuring jaws

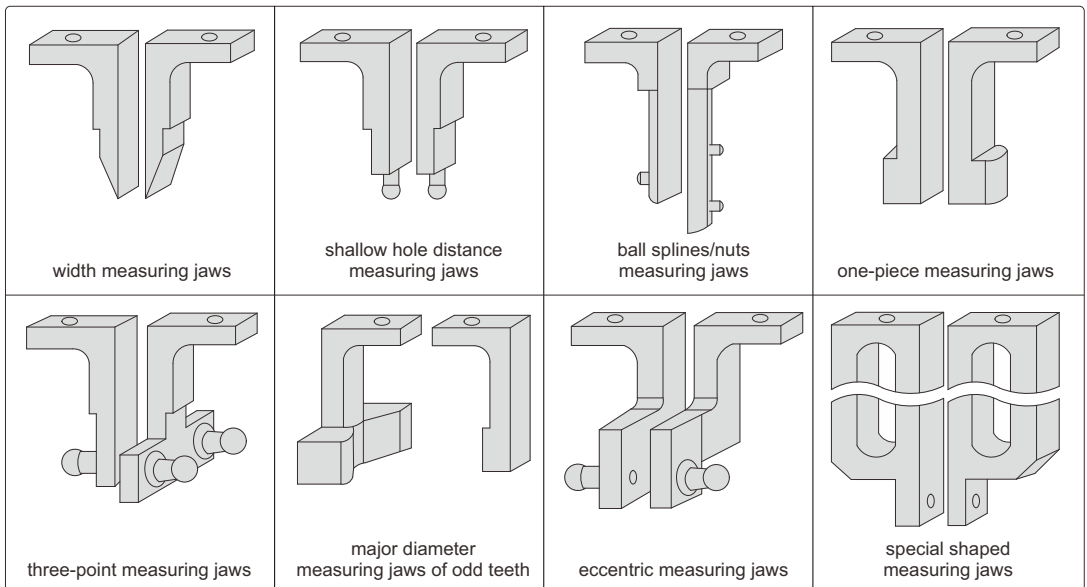





# INTERNAL AND EXTERNAL DIAMETER COMPARISON INSTRUMENT



digital/dial indicator is optional

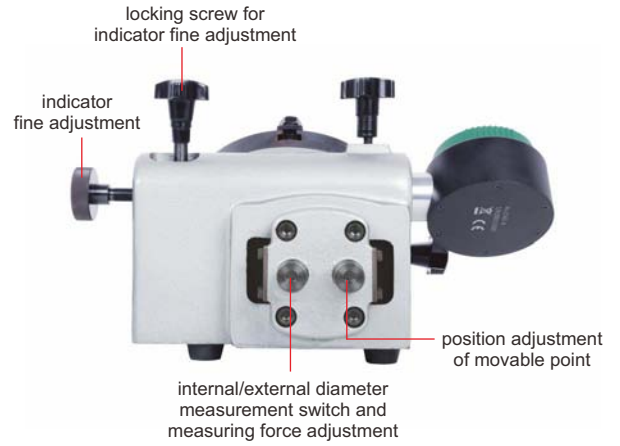

- Measure internal/external diameter, variation and taper
- Total range of movable point: 2mm, effective range of movable point:  $\pm 0.1\text{mm}$
- Groove probes and disc probes are included
- Optional accessory:  $\text{\O}28\text{mm}/\text{\O}8\text{mm}$  bush (code 6843-B8), cross table, 0.001mm digital/dial indicators, high precision digital indicators (code 2140-6, 2140-6WL)

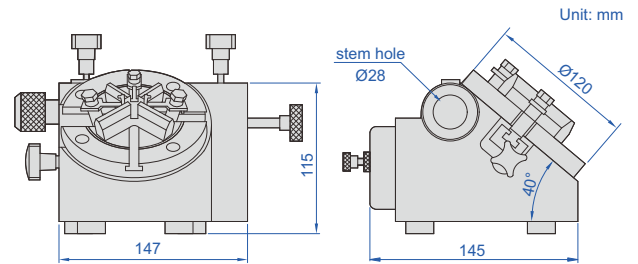

Code	Applicable holding stem	Range of internal diameter	Range of external diameter	Accuracy	Repeatability
6844-100	$\text{\O}28\text{mm}$	20-100mm/0.8-3.9"	15-80mm/0.6-3.1"	$\pm 0.001\text{mm}$	0.001mm

cross table (working with groove probes)

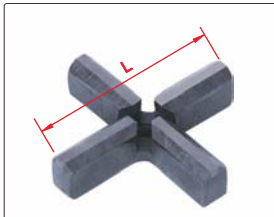

disc probes (included)



groove probes to measure small internal diameter and internal groove diameter

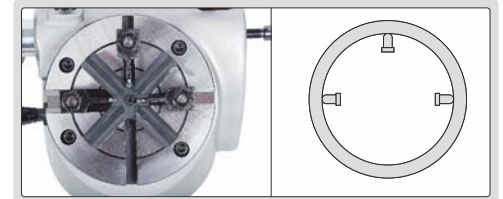

Cross table

Code	L	Remark
6844-T40	40mm	included
6844-T80	80mm	optional
6844-T100	100mm	optional

groove probe (included)



disc probes to measure large internal diameter

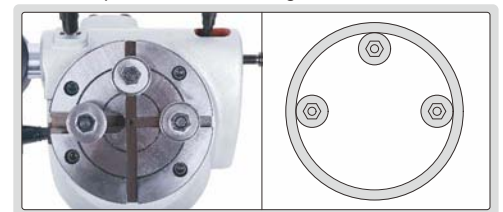

$\text{\O}28\text{mm}/\text{\O}8\text{mm}$  bush (optional)



Code  
6843-B8

application



disc probes to measure external diameter

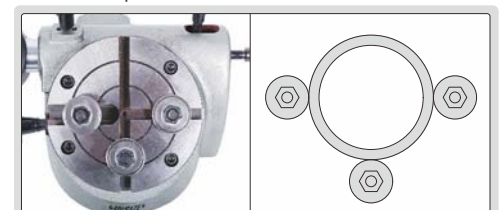

INTERNAL AND EXTERNAL DIAMETER COMPARISON INSTRUMENT



5

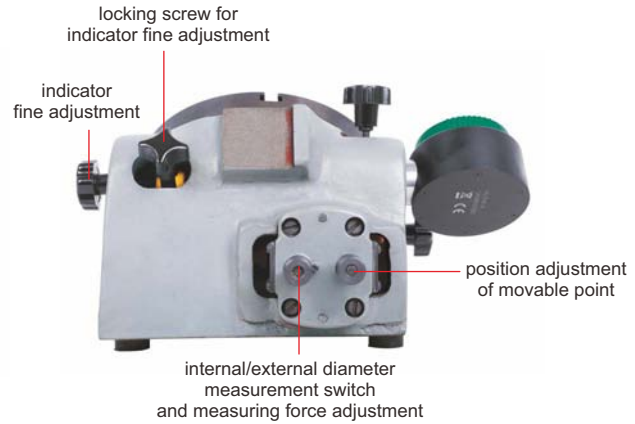
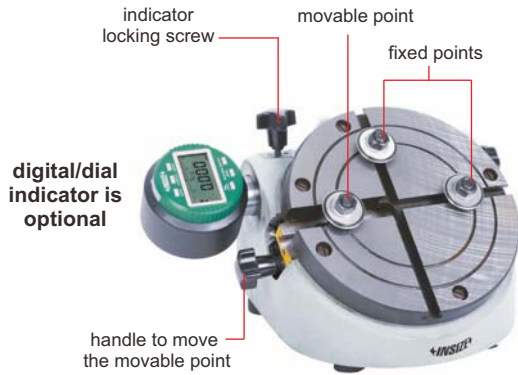

- Measure internal/external diameter, variation and taper
- Total range of movable point: 2mm, effective range of movable point: ±0.1mm
- Optional accessory: Ø28mm/Ø8mm bush (code 6843-B8), 0.001mm digital/dial indicators, high precision digital indicators (code 2140-6, 2140-6WL)

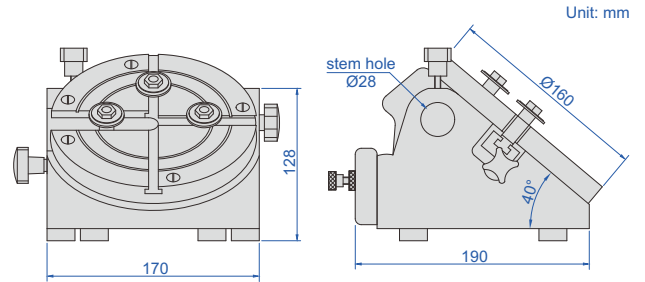

internal diameter measurement

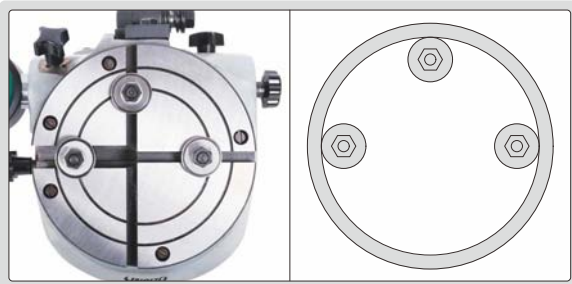

external diameter measurement

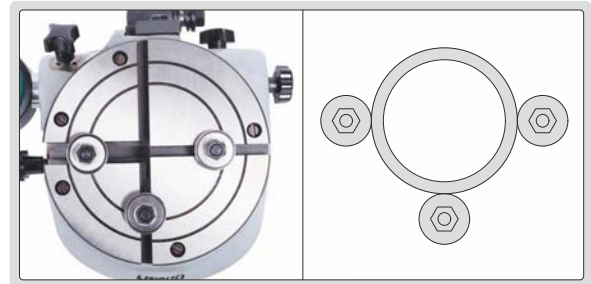

Code	Applicable holding stem	Range of internal diameter	Range of external diameter	Accuracy	Repeatability
6843-140	Ø28mm	50-140mm/2-5.5"	30-120mm/1.2-4.7"	±0.001mm	0.001mm

Ø28mm/Ø8mm bush (optional)



Code

6843-B8

application





## OUTSIDE DIAMETER MEASURING STAND

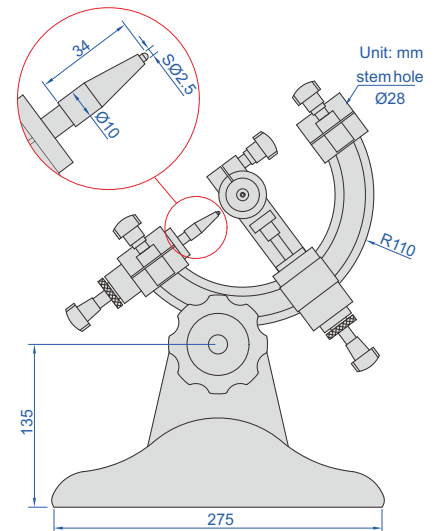

5

- To measure diameter and roundness of cylinders and steel balls
- Supplied with measuring base (code 6847-A100)
- Optional accessory: Ø28mm/Ø8mm bush (code 6843-B8), 0.001mm digital/dial indicators, high precision digital indicators (code 2140-6, 2140-6WL), gage blocks (4101 series, for zero setting of cylinders), custom plug gages (for zero setting of cylinders), ceramic standard balls (4190 series, for zero setting of steel balls)

### Measuring base

Code	Diameter	Remark
6847-A10	10mm	optional
6847-A20	20mm	optional
6847-A30	30mm	optional
6847-A40	40mm	optional
6847-A50	50mm	optional
6847-A60	60mm	optional
6847-A70	70mm	optional
6847-A75	75mm	optional
6847-A80	80mm	optional
6847-A90	90mm	optional
6847-A100	100mm	included

Code	Range of outside diameter	Accuracy	Repeatability
6847-50	1.5-50mm/0.06-2"	±0.001mm	0.0005mm

### Ø28mm/Ø8mm bush (optional)



Code  
6843-B8

### application





**Digital Micrometers/Snap Gages**  
Page 102-105



**Digital Micrometers**  
Page 106-111



**Outside Micrometers**  
Page 112-117

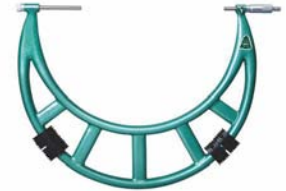

**Large Outside Micrometers**  
Page 117-121



**Limit Micrometers**  
Page 121



**Indicating Micrometers**  
Page 122



**Micrometers With Dial Indicator**  
Page 123-125



**Groove Micrometers**  
Page 125



**3-Wires**  
Page 126



**Screw Thread Micrometers**  
Page 127-130



**Gear Tooth Micrometers**  
Page 131-133



**Point Micrometers**  
Page 134-135



**Gear Root Diameter Micrometers**  
Page 136



**Blade Micrometers**  
Page 137-139



**Crimp Height Micrometers**  
Page 140



**Spline Micrometers**  
Page 140-142



**Tube Micrometers**  
Page 143-145



**Disk Brake Micrometers**  
Page 146



**Sheet Metal Micrometers**  
Page 146-147



**Interchangeable Anvil Micrometers**  
Page 147-148



Large Anvil Micrometers  
Page 148



V-Anvil Micrometers  
Page 149



Universal Micrometers  
Page 150



Caliper Type Micrometers  
Page 151



Jaw Type Micrometers  
Page 152



Disk Micrometers  
Page 153-156



Sheet Metal Micrometers  
Page 157



Micrometers For Hot Plate  
Page 157



Hub Micrometers  
Page 157



Wire Micrometers  
Page 158



Can Seam Micrometers  
Page 158



Optical Parallels  
Page 158



Parallelism Inspect Devices  
For Outside Micrometers  
Page 159



Micrometer Measuring  
Force Detectors  
Page 159



Micrometer Inspection  
Gage Block Sets  
Page 159



Micrometer Stands  
Page 159-160



Micrometer Setting  
Standards  
Page 161



Micrometer Lapping  
Machines  
Page 162-163



Micrometer Heads  
Page 163-167

## DIGITAL MICROMETERS/SNAP GAGES

ONE TURN OF SLEEVE MAKES 10MM SPINDLE FEED, PRESS THE FORK, THE SPINDLE RETRACTS 3MM

MEASUREMENT ACCURACY IS NOT AFFECTED BY THE USE OF SLEEVE

**IP65**  
WATERPROOF

DATA  
OUTPUT

ABSOLUTE ENCODER, THE ORIGINAL  
DATA REMAINS AFTER POWER OFF

ATTENTION: RECHARGEABLE BATTERY,  
FOR 24 HOURS CONTINUOUS WORKING

NON-ROTATING  
SPINDLE



POPULAR  
MODEL



Unit: mm



3358-25

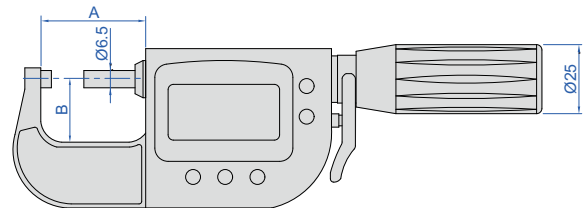

- Absolute encoder, the original data remains after power off
- Resolution: 0.001mm/0.00005"
- One turn of sleeve makes 10mm spindle feed
- Measurement accuracy is not affected by the use of sleeve
- Press the fork, the spindle retracts 3mm
- Carbide spindle and anvil
- Measuring force 5-10N
- Button function: data output, tolerance, data preset, data hold, measuring direction change, max./min./TIR, power off time, on/off, zero, mm/inch
- Supplied with gage blocks for zero setting (except 0-25mm/0-1")
- Power: rechargeable battery, for 24 hours continuous working

alarm when  
over tolerance

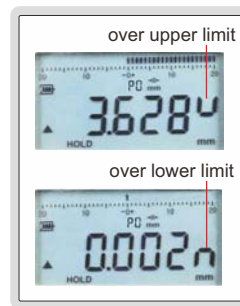

wireless receiver  
2134-R1, 2134-R2 (optional)



### With data interface

Optional accessory:

wireless transmitter, code **7315-3350** need receiver page 6

data output cable (keyboard format), code **7302-3350** page 13

Code	Range	Accuracy	Repeatability	Measuring faces		A	B
				flatness	parallelism		
3358-25 *	0-25mm/0-1"	2µm	1µm	0.5µm	1.2µm	38mm	24mm
3358-50 *	25-50mm/1-2"	2µm	1µm	0.5µm	1.2µm	64mm	32.5mm
3358-75 *	50-75mm/2-3"	3µm	1µm	0.5µm	1.8µm	89mm	46mm
3358-100 *	75-100mm/3-4"	3µm	1µm	0.5µm	1.8µm	114mm	60mm

### Built-in wireless

Optional accessory:

wireless receiver (keyboard format, connect up to 15 digital indicators), code **2134-R1**

wireless receiver (serial port format, connect up to 15 digital indicators), code **2134-R2**

Code	Range	Accuracy	Repeatability	Measuring faces		A	B
				flatness	parallelism		
3358-25WL *	0-25mm/0-1"	2µm	1µm	0.5µm	1.2µm	38mm	24mm
3358-50WL *	25-50mm/1-2"	2µm	1µm	0.5µm	1.2µm	64mm	32.5mm
3358-75WL *	50-75mm/2-3"	3µm	1µm	0.5µm	1.8µm	89mm	46mm
3358-100WL *	75-100mm/3-4"	3µm	1µm	0.5µm	1.8µm	114mm	60mm

\* Supplied with manufacturer inspection certificate

## HIGH PRECISION DIGITAL MICROMETERS/SNAP GAGES

ONE TURN OF SLEEVE MAKES 10MM SPINDLE FEED, PRESS THE FORK, THE SPINDLE RETRACTS 3MM

MEASUREMENT ACCURACY IS NOT AFFECTED BY THE USE OF SLEEVE

IP65 WATERPROOF

DATA OUTPUT

ABSOLUTE ENCODER, THE ORIGINAL DATA REMAINS AFTER POWER OFF

ATTENTION: RECHARGEABLE BATTERY, FOR 24 HOURS CONTINUOUS WORKING

NON-ROTATING SPINDLE



alarm when over tolerance

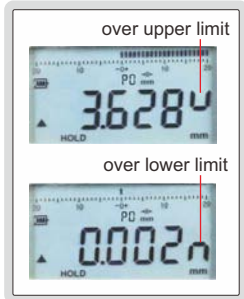

3359-25

wireless receiver 2134-R1, 2134-R2 (optional)

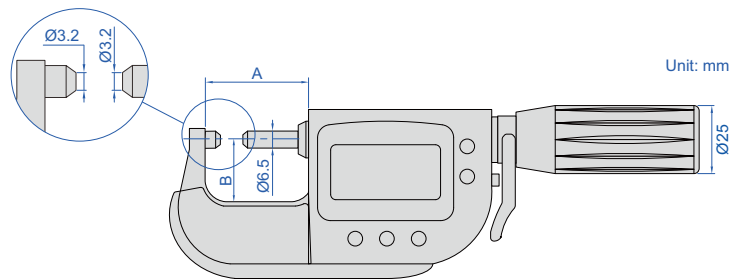

- Absolute encoder, the original data remains after power off
- Resolution: 0.0001mm/0.00001"
- One turn of sleeve makes 10mm spindle feed
- Measurement accuracy is not affected by the use of sleeve
- Press the fork, the spindle retracts 3mm
- Carbide spindle and anvil
- Measuring force 5-10N
- Button function: data output, tolerance, data preset, data hold, measuring direction change, max./min./TIR, power off time, on/off, zero, mm/inch
- Power: rechargeable battery, for 24 hours continuous working

### With data interface

Optional accessory:

wireless transmitter, code 7315-3350 need receiver page 6

data output cable (keyboard format), code 7302-3350 page 13

Code	Range	Accuracy	Repeatability	Measuring faces		A	B
				flatness	parallelism		
3359-25*	0-25mm/0-1"	±0.5µm	0.3µm	0.3µm	0.6µm	38mm	24mm

### Built-in wireless

Optional accessory:

wireless receiver (keyboard format, connect up to 15 digital indicators), code 2134-R1

wireless receiver (serial port format, connect up to 15 digital indicators), code 2134-R2

Code	Range	Accuracy	Repeatability	Measuring faces		A	B
				flatness	parallelism		
3359-25WL*	0-25mm/0-1"	±0.5µm	0.3µm	0.3µm	0.6µm	38mm	24mm

\* Supplied with manufacturer inspection certificate

## HIGH PRECISION DIGITAL MICROMETERS/SNAP GAGES (ADVANCED TYPE)

ONE TURN OF SLEEVE MAKES 5MM SPINDLE FEED, PRESS THE FORK, THE SPINDLE RETRACTS 3MM

MEASUREMENT ACCURACY IS NOT AFFECTED BY THE USE OF SLEEVE

IP65 WATERPROOF

DATA OUTPUT

ATTENTION: RECHARGEABLE BATTERY, FOR 24 HOURS CONTINUOUS WORKING

NON-ROTATING SPINDLE

ABSOLUTE ENCODER, THE ORIGINAL DATA REMAINS AFTER POWER OFF



6

- Absolute encoder, the original data remains after power off
- Adjustable resolution: 0.0002mm/0.00001" 0.001mm/0.00005" 0.01mm/0.0005"
- One turn of sleeve makes 5mm spindle feed
- Measurement accuracy is not affected by the use of sleeve
- Press the fork, the spindle retracts 3mm
- Linear ball bearings for ten million times use
- Carbide spindle and anvil
- Measuring force 7-10N  
Customizable measuring force range 2-12N  
Attention: small measuring force will reduce the dustproof and waterproof level
- Button function: data output, tolerance, data preset, data hold, measuring direction change, max./min./TIR, power off time, on/off, zero, mm/inch, adjust resolution
- Supplied with gage blocks for zero setting (except 0-25mm/0-1")
- Power: rechargeable battery, for 24 hours continuous working



3350-25

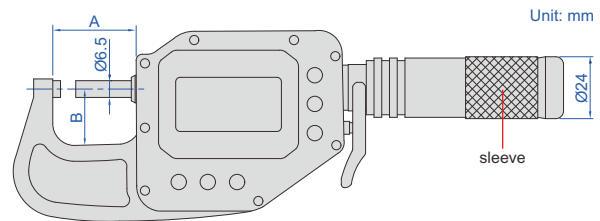

### With data interface

Optional accessory:  
wireless transmitter, code **7315-3350** need receiver page 6  
data output cable (keyboard format), code **7302-3350** page 13

Code	Range	Accuracy	Repeatability	Measuring faces		A	B
				flatness	parallelism		
3350-25*	0-25mm/0-1"	1.4µm	0.6µm	0.5µm	1µm	38mm	24mm
3350-50*	25-50mm/1-2"	1.6µm	1µm	0.5µm	1µm	63mm	28mm
3350-75*	50-75mm/2-3"	1.8µm	1µm	0.5µm	1µm	88mm	45mm
3350-100*	75-100mm/3-3.95"	2µm	1µm	0.5µm	1µm	113mm	57mm

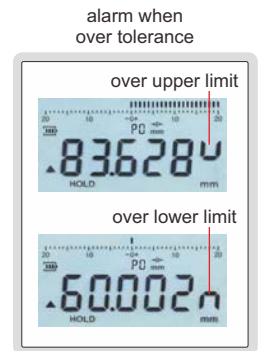

### Built-in wireless

Optional accessory:  
wireless receiver (keyboard format, connect up to 15 digital indicators), code **2134-R1**  
wireless receiver (serial port format, connect up to 15 digital indicators), code **2134-R2**

Code	Range	Accuracy	Repeatability	Measuring faces		A	B
				flatness	parallelism		
3350-25WL*	0-25mm/0-1"	1.4µm	0.6µm	0.5µm	1µm	38mm	24mm
3350-50WL*	25-50mm/1-2"	1.6µm	1µm	0.5µm	1µm	63mm	28mm
3350-75WL*	50-75mm/2-3"	1.8µm	1µm	0.5µm	1µm	88mm	45mm
3350-100WL*	75-100mm/3-3.95"	2µm	1µm	0.5µm	1µm	113mm	57mm

wireless receiver 2134-R1, 2134-R2 (optional)



\*Supplied with manufacturer inspection certificate



**IP65**  
WATERPROOF

ABSOLUTE ENCODER, THE ORIGINAL  
DATA REMAINS AFTER POWER OFF

ONE TURN OF SLEEVE MAKES 5MM SPINDLE FEED,  
PRESS THE FORK, THE SPINDLE RETRACTS 3MM

ATTENTION: RECHARGEABLE BATTERY,  
FOR 24 HOURS CONTINUOUS WORKING

NON-ROTATING  
SPINDLE

DATA  
OUTPUT

MEASUREMENT ACCURACY IS NOT  
AFFECTED BY THE USE OF SLEEVE

**INSPECTION  
CERTIFICATE**

## HIGH PRECISION DIGITAL MICROMETERS/SNAP GAGES



3351-275

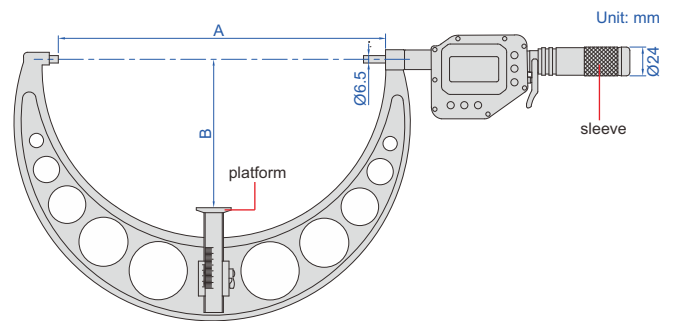

Unit: mm

sleeve

- Absolute encoder, the original data remains after power off
- Adjustable resolution: 0.0002mm/0.00001" (when the reading exceeds 100mm, the resolution is automatically switched to 0.001mm) 0.001mm/0.00005" 0.01mm/0.0005"
- One turn of sleeve makes 5mm spindle feed
- Measurement accuracy is not affected by the use of sleeve
- Press the fork, the spindle retracts 3mm
- Linear ball bearings for ten million times use
- Carbide spindle and anvil
- Measuring force 5-8N  
Customizable measuring force range 2-12N  
Attention: small measuring force will reduce the dustproof and waterproof level
- Button function: data output, tolerance, data preset, data hold, measuring direction change, max./min./TIR, power off time, on/off, zero, mm/inch, adjust resolution
- Supplied with gage blocks for zero setting
- Power: rechargeable battery, for 24 hours continuous working

### With data interface

Optional accessory:  
wireless transmitter, code **7315-3350** need receiver page 6  
data output cable (keyboard format), code **7302-3350** page 13



gage blocks for zero setting (included)



Code	Range	Accuracy	Repeatability	Measuring faces		A	B
				flatness	parallelism		
3351-125 *	100-125mm/4-5"	3µm	1µm	0.5µm	2µm	128mm	62.5mm
3351-150 *	125-150mm/5-6"	3µm	1µm	0.5µm	2µm	153mm	75mm
3351-175 *	150-175mm/6-7"	4µm	1µm	0.5µm	2.5µm	178mm	87.5mm
3351-200 *	175-200mm/7-8"	4µm	1µm	0.5µm	2.5µm	203mm	100mm
3351-225 *	200-225mm/8-9"	5µm	1µm	0.5µm	3µm	228mm	112.5mm
3351-250 *	225-250mm/9-10"	5µm	1µm	0.5µm	3µm	253mm	125mm
3351-275 *	250-275mm/10-11"	6µm	1µm	0.5µm	3.5µm	278mm	137.5mm
3351-300 *	275-300mm/11-12"	6µm	1µm	0.5µm	3.5µm	303mm	150mm

### Built-in wireless

Optional accessory:  
wireless receiver (keyboard format, connect up to 15 digital indicators), code **2134-R1**  
wireless receiver (serial port format, connect up to 15 digital indicators), code **2134-R2**

Code	Range	Accuracy	Repeatability	Measuring faces		A	B
				flatness	parallelism		
3351-125WL *	100-125mm/4-5"	3µm	1µm	0.5µm	2µm	128mm	62.5mm
3351-150WL *	125-150mm/5-6"	3µm	1µm	0.5µm	2µm	153mm	75mm
3351-175WL *	150-175mm/6-7"	4µm	1µm	0.5µm	2.5µm	178mm	87.5mm
3351-200WL *	175-200mm/7-8"	4µm	1µm	0.5µm	2.5µm	203mm	100mm
3351-225WL *	200-225mm/8-9"	5µm	1µm	0.5µm	3µm	228mm	112.5mm
3351-250WL *	225-250mm/9-10"	5µm	1µm	0.5µm	3µm	253mm	125mm
3351-275WL *	250-275mm/10-11"	6µm	1µm	0.5µm	3.5µm	278mm	137.5mm
3351-300WL *	275-300mm/11-12"	6µm	1µm	0.5µm	3.5µm	303mm	150mm

alarm when  
over tolerance

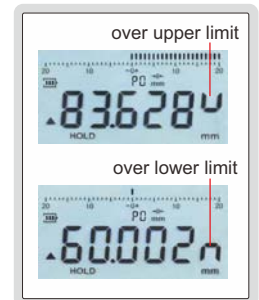

wireless receiver  
2134-R1, 2134-R2 (optional)



\* Supplied with manufacturer inspection certificate

## NON-ROTATING SPINDLE DIGITAL MICROMETERS

**INSIZE PLUS**  
MADE IN EUROPE

**INSPECTION CERTIFICATE**

QUICK MEASUREMENT  
ONE TURN OF SLEEVE OR RATCHET  
STOP MAKES 2mm SPINDLE FEED

LEVER FORCE MEASURING DEVICE  
SUITABLE FOR MASS MEASUREMENT

**IP65**  
WATERPROOF

NON-ROTATING  
SPINDLE

DATA  
OUTPUT

6



3632-80A

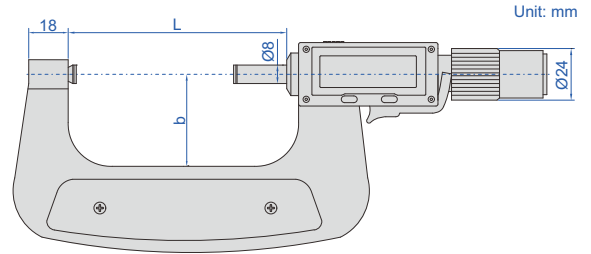

Unit: mm

- Adjustable resolution: 0.01mm/0.0005", 0.001mm/0.00005", 0.0005mm/0.00002"
- Repeatability: 1µm
- Measuring force: 5-10N
- Lever force measuring device, suitable for mass measurement
- No-rotating spindle, suitable for measuring cylindrical workpiece
- Quick measurement: one turn of sleeve or ratchet stop makes 2mm spindle feed
- Carbide measuring faces
- Data output
- Button function: mm/inch, max./min. value tracking, preset value, hold, on/off, zero
- Ratchet sets force measurement
- CR2032 battery, automatic power off
- Supplied with setting standards (except 0-30mm/0-1.18")
- Optional accessory: data output cable (code 7315-80 need receiver page 5, 7302-80)

lever force measuring device

press the lever force measuring device, the spindle retracted 1.5mm (MAX). release the force measuring device, the spindle extends, contacts the measured workpiece, and the measured force is constant

spindle retraction  
1.5mm (MAX)



push down

(mm)

Code	Range	Accuracy		L	b
		stroke≤25mm	stroke>25mm		
3632-30A *	0-30mm/0-1.18"	±2µm	±3µm	38	24
3632-55A *	25-55mm/0.98-2.17"	±2µm	±3µm	63	30.5
3632-80A *	50-80mm/1.97-3.15"	±3µm	±4µm	88	44
3632-105A *	75-105mm/2.95-4.13"	±3µm	±4µm	113	57
3632-130A *	100-130mm/3.94-5.12"	±3µm	±5µm	138	70
3632-155A *	125-155mm/4.92-6.1"	±3µm	±5µm	163	83
3632-180A *	150-180mm/5.91-7.09"	±4µm	±6µm	188	96
3632-205A *	175-205mm/6.89-8.07"	±4µm	±6µm	213	109
3632-230A *	200-230mm/7.87-9.06"	±4µm	±6µm	238	122
3632-255A *	225-255mm/8.86-10.04"	±4µm	±6µm	268	135
3632-280A *	250-280mm/9.84-11.02"	±5µm	±7µm	293	147.5
3632-305A *	275-305mm/10.83-12.01"	±5µm	±7µm	318	160

\* Supplied with manufacturer inspection certificate

## HIGH PRECISION NON-ROTATING SPINDLE DIGITAL MICROMETERS

**INSIZE PLUS**  
MADE IN EUROPE

**QUICK MEASUREMENT**  
ONE TURN OF SLEEVE OR RATCHET  
STOP MAKES 2MM SPINDLE FEED

**ATTENTION: SETTING**  
STANDARDS ARE NOT INCLUDED

**IP65**  
WATERPROOF

**NON-ROTATING**  
SPINDLE

**DATA**  
OUTPUT

**STROKE**  
30mm



3661-30

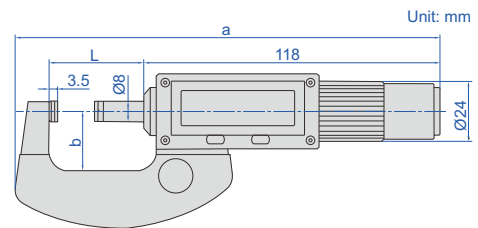

- Adjustable resolution: 0.01mm/0.0005", 0.001mm/0.00005", 0.0005mm/0.00002"
- Repeatability: 0.5µm
- Measuring force: 5-10N
- Flatness of measuring faces: 0.3µm
- Parallelism of measuring faces: 0.5µm
- Ratchet stop
- Non-rotating spindle, suitable for cylinders
- Quick measurement: one turn of sleeve or ratchet stop makes 2mm spindle feed
- Carbide measuring faces
- Data output
- Button function: mm/inch, max./min. value tracking, preset value, hold, on/off, zero
- CR2032 battery
- Automatic power off, turn the sleeve to turn on
- Optional accessory: setting standards (code **7386**), data output cable (code **7315-80 need receiver** page 5, **7302-80**)

(mm)

Code	Range	Accuracy		L	a	b
		stroke ≤25mm	stroke >25mm			
3661-30	0-30mm/0-1.18"	±2µm	±3µm	38	169	24
3661-55	25-55mm/0.98-2.17"	±2µm	±3µm	63	195	30.5
3661-80	50-80mm/1.97-3.15"	±3µm	±4µm	88	228	44
3661-105	75-105mm/2.95-4.13"	±3µm	±4µm	113	257	57
3661-130	100-130mm/3.94-5.12"	±3µm	±5µm	138	289	70
3661-155	125-155mm/4.92-6.1"	±3µm	±5µm	163	315	83
3661-180	150-180mm/5.91-7.09"	±4µm	±6µm	188	340	96
3661-205	175-205mm/6.89-8.07"	±4µm	±6µm	213	363	109
3661-230	200-230mm/7.87-9.06"	±4µm	±6µm	238	388	122
3661-255	225-255mm/8.86-10.04"	±4µm	±6µm	268	429	135
3661-280	250-280mm/9.84-11.02"	±5µm	±7µm	293	454	147.5
3661-305	275-305mm/10.83-12.01"	±5µm	±7µm	318	479	160

## WATERPROOF DIGITAL OUTSIDE MICROMETERS (WITH DATA OUTPUT)

POPULAR MODEL

DATA OUTPUT

IP65 WATERPROOF

INSPECTION CERTIFICATE

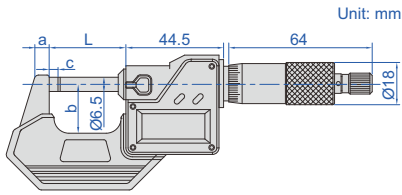

data output interface on the back

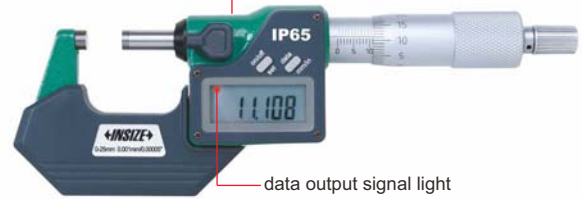

data output signal light

3101-25A

- IP65 dust/waterproof
- Button function: on/off, set, mm/inch, data transmit
- Automatic power off
- Carbide measuring faces
- Supplied with spherical anvil
- Setting standards are included (except 0-25mm/0-1")
- Optional accessory: data output cable (code 7315-31 need receiver page 4, 7302-31 page 12)

### Metric/Inch type (ratchet stop)

(mm)

Code	Range	Resolution	Accuracy	L	a	b	c
3101-25A*	0-25mm/0-1"	0.001mm/0.00005"	±2µm	34.5	6	25	3
3101-50A*	25-50mm/1-2"	0.001mm/0.00005"	±2µm	59.5	8	32	3
3101-75A*	50-75mm/2-3"	0.001mm/0.00005"	±3µm	84.5	8	44.5	3
3101-100A*	75-100mm/3-4"	0.001mm/0.00005"	±3µm	109.5	8	57	3
3101-125A	100-125mm/4-5"	0.001mm/0.00005"	±3µm	135	10	70	3
3101-150A	125-150mm/5-6"	0.001mm/0.00005"	±3µm	160.5	10	82	3
3101-175A	150-175mm/6-7"	0.001mm/0.00005"	±4µm	186	12	94.5	5.5
3101-200A	175-200mm/7-8"	0.001mm/0.00005"	±4µm	211.5	12	107	5.5
3101-225A	200-225mm/8-9"	0.001mm/0.00005"	±4µm	236	23	129.5	5.5
3101-250A	225-250mm/9-10"	0.001mm/0.00005"	±4µm	261.5	23	142.5	5.5
3101-275A	250-275mm/10-11"	0.001mm/0.0001"	±5µm	287	23	155	5.5
3101-300A	275-300mm/11-12"	0.001mm/0.0001"	±5µm	312.5	23	167.5	5.5



### Metric/Inch type (friction thimble)

(mm)

Code	Range	Resolution	Accuracy	L	a	b	c
3101-25FA*	0-25mm/0-1"	0.001mm/0.00005"	±2µm	34.5	6	25	3

### Metric type (ratchet stop)

(mm)

Code	Range	Resolution	Accuracy	L	a	b	c
3101-25AJ*	0-25mm	0.001mm	±2µm	34.5	6	25	3
3101-50AJ*	25-50mm	0.001mm	±2µm	59.5	8	32	3
3101-75AJ*	50-75mm	0.001mm	±3µm	84.5	8	44.5	3
3101-100AJ*	75-100mm	0.001mm	±3µm	109.5	8	57	3

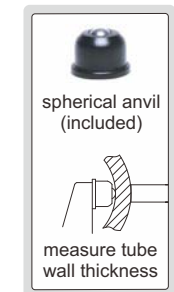

### Set (ratchet stop type)

Code	Range	Micrometers included	Packaging
3101-753A*	0-75mm/0-3"	3101-25A, 3101-50A, 3101-75A	blow mould case
3101-1004A*	0-100mm/0-4"	3101-25A, 3101-50A, 3101-75A, 3101-100A	blow mould case
3101-1506A	0-150mm/0-6"	3101-25A, 3101-50A, 3101-75A, 3101-100A, 3101-125A, 3101-150A	aluminum box
3101-3006A	150-300mm/6-12"	3101-175A, 3101-200A, 3101-225A, 3101-250A, 3101-275A, 3101-300A	aluminum box

\*Supplied with manufacturer inspection certificate



3101-753A



3101-1506A

## WATERPROOF DIGITAL OUTSIDE MICROMETERS (WITHOUT DATA OUTPUT)

**IP65**  
WATERPROOF

**ATTENTION: NO DATA OUTPUT**

**INSPECTION CERTIFICATE**



**3108-25A**

- Resolution 0.001mm/0.00005"
- IP65 dust/waterproof
- Button function: on/off, set, mm/inch, ABS/INC
- No data output
- Automatic power off
- Carbide measuring faces
- Supplied with spherical anvil
- Setting standards are included (except 0-25mm/0-1")

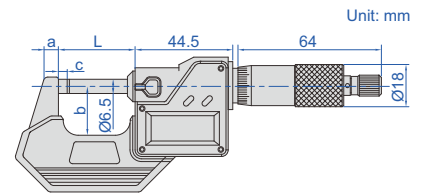

**Ratchet stop type (mm)**

Code	Range	Accuracy	L	a	b	c
<b>3108-25A*</b>	0-25mm/0-1"	±2µm	34.5	6	25	3
<b>3108-50A*</b>	25-50mm/1-2"	±2µm	59.5	8	32	3
<b>3108-75A*</b>	50-75mm/2-3"	±3µm	84.5	8	44.5	3
<b>3108-100A*</b>	75-100mm/3-4"	±3µm	109.5	8	57	3
<b>3108-125A</b>	100-125mm/4-5"	±3µm	135	10	70	3
<b>3108-150A</b>	125-150mm/5-6"	±3µm	160.5	10	82	3
<b>3108-175A</b>	150-175mm/6-7"	±4µm	186	12	94.5	5.5
<b>3108-200A</b>	175-200mm/7-8"	±4µm	211.5	12	107	5.5



**Friction thimble type (mm)**

Code	Range	Accuracy	L	a	b	c
<b>3108-25FA*</b>	0-25mm/0-1"	±2µm	34.5	6	25	3



**3108-753A**



**3108-1506A**

**Set**

Code	Range	Micrometers included	Packaging
<b>3108-753A*</b>	0-75mm/0-3"	3108-25A, 3108-50A, 3108-75A	blow mould case
<b>3108-1004A*</b>	0-100mm/0-4"	3108-25A, 3108-50A, 3108-75A, 3108-100A	blow mould case
<b>3108-1506A</b>	0-150mm/0-6"	3108-25A, 3108-50A, 3108-75A, 3108-100A, 3108-125A, 3108-150A	aluminum box

\*Supplied with manufacturer inspection certificate

## DIGITAL OUTSIDE MICROMETERS (BASIC TYPE, WITH DATA OUTPUT)



DATA OUTPUT



3102-25

- Resolution 0.001mm/0.00005"
- Button function: on/off, set, mm/inch, data transmit
- Automatic power off
- Carbide measuring faces
- Friction thimble
- Supplied with spherical anvil
- Setting standards are included (except 0-25mm/0-1")
- Optional accessory: data output cable (code 7315-30 need receiver page 4, 7302-30 page 12)

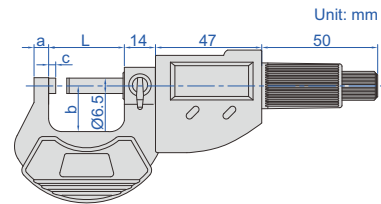

Individual Code	Range	Accuracy	L	a	b	c	(mm)
3102-25 *	0-25mm/0-1"	±2µm	32	6	24	3	
3102-50 *	25-50mm/1-2"	±2µm	57	8	32	3	
3102-75 *	50-75mm/2-3"	±3µm	82	8	45	3	
3102-100 *	75-100mm/3-4"	±3µm	107	10	57	3	
3102-125	100-125mm/4-5"	±3µm	133	10	70	3	
3102-150	125-150mm/5-6"	±3µm	158	10	82	3	
3102-175	150-175mm/6-7"	±4µm	183	12	95	5.5	
3102-200	175-200mm/7-8"	±4µm	209	12	107	5.5	

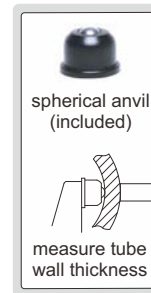

3102-753A



3102-1506A

### Set

Code	Range	Micrometers included	Packaging
3102-753A *	0-75mm/0-3"	3102-25, 3102-50, 3102-75	blow mould case
3102-1004A *	0-100mm/0-4"	3102-25, 3102-50, 3102-75, 3102-100	blow mould case
3102-1506A	0-150mm/0-6"	3102-25, 3102-50, 3102-75, 3102-100, 3102-125, 3102-150	aluminum box

\* Supplied with manufacturer inspection certificate

POPULAR MODEL

## DIGITAL OUTSIDE MICROMETERS (BASIC TYPE, WITHOUT DATA OUTPUT)

INSPECTION CERTIFICATE

ATTENTION: NO DATA OUTPUT

- Resolution 0.001mm/0.00005"
- Button function: on/off, set, mm/inch, ABS/INC
- No data output
- Automatic power off
- Carbide measuring faces
- Friction thimble
- Supplied with spherical anvil
- Setting standards are included (except 0-25mm/0-1")



3109-25A

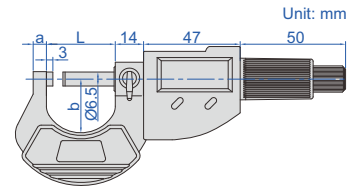

### Individual

Code	Range	Accuracy	L	a	b
3109-25A*	0-25mm/0-1"	±2µm	32mm	6mm	28mm
3109-50A*	25-50mm/1-2"	±2µm	57mm	8mm	37mm
3109-75A*	50-75mm/2-3"	±3µm	82mm	8mm	50mm
3109-100A*	75-100mm/3-4"	±3µm	107mm	10mm	61mm
3109-125A	100-125mm/4-5"	±3µm	132mm	10mm	73mm
3109-150A	125-150mm/5-6"	±3µm	157mm	10mm	85mm
3109-175A	150-175mm/6-7"	±4µm	182mm	20mm	104mm
3109-200A	175-200mm/7-8"	±4µm	207mm	20mm	117mm
3109-225A	200-225mm/8-9"	±4µm	234mm	20mm	130mm
3109-250A	225-250mm/9-10"	±4µm	260mm	20mm	143mm
3109-275A	250-275mm/10-11"	±5µm	285mm	20mm	155mm
3109-300A	275-300mm/11-12"	±5µm	310mm	20mm	168mm

### Set

Code	Range	Micrometers included	Packaging
3109-753A*	0-75mm/0-3"	3109-25A, 3109-50A, 3109-75A	blow mould case
3109-1004A*	0-100mm/0-4"	3109-25A, 3109-50A, 3109-75A, 3109-100A	blow mould case
3109-1506A	0-150mm/0-6"	3109-25A, 3109-50A, 3109-75A, 3109-100A, 3109-125A, 3109-150A	aluminum box
3109-3006A	150-300mm/6-12"	3109-175A, 3109-200A, 3109-225A, 3109-250A, 3109-275A, 3109-300A	aluminum box

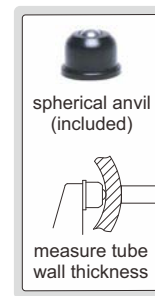

3109-753A



3109-1506A

\*Supplied with manufacturer inspection certificate

DATA OUTPUT

IP65 WATERPROOF

INSPECTION CERTIFICATE

## DIGITAL VERTICAL MICROMETERS

- Measure the thickness of plates for easy reading
- Resolution 0.001mm/0.00005"
- IP65 dust/waterproof
- Button function: on/off, set, mm/inch, ABS/INC
- Data output
- Automatic power off
- Carbide spindle tip
- Ratchet stop
- Supplied with setting standards (except 0-25mm/0-1")
- Optional accessory: data output cable (code 7315-30 need receiver page 4, 7302-30 page 12)



3565-25A

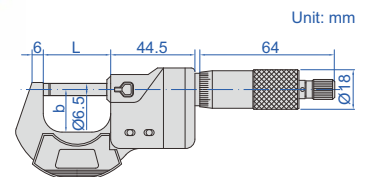

Code	Range	Type	Accuracy	L	b
3565-25A*	0-25mm/0-1"	A	±2µm	34.5mm	25mm
3565-50A*	25-50mm/1-2"	A	±2µm	59.5mm	32mm
3565-25BA*	0-25mm/0-1"	B	±2µm	34.5mm	25mm
3565-50BA*	25-50mm/1-2"	B	±2µm	59.5mm	32mm

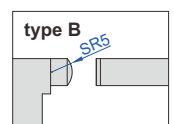
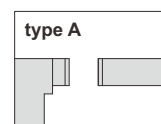

\*Supplied with manufacturer inspection certificate

## OUTSIDE MICROMETERS

**INSIZE PLUS**  
MADE IN EUROPE

- Carbide measuring faces
- Graduation: 0.01mm
- Meet DIN863-1
- Friction thimble
- Optional accessory: setting standards (code 7386)

Code	Range	Accuracy	L	b
3701-25A *	0-25mm	4µm	37mm	24mm
3701-50A *	25-50mm	4µm	62mm	34mm
3701-75A *	50-75mm	5µm	87mm	46mm
3701-100A *	75-100mm	5µm	112mm	60mm
3701-125A *	100-125mm	6µm	139mm	72mm
3701-150A *	125-150mm	6µm	164mm	85mm
3701-175A *	150-175mm	7µm	190mm	97mm
3701-200A *	175-200mm	7µm	215mm	110mm
3701-225A *	200-225mm	8µm	240mm	122mm
3701-250A *	225-250mm	8µm	264mm	135mm
3701-275A *	250-275mm	9µm	290mm	148mm
3701-300A *	275-300mm	9µm	315mm	160mm

\* Supplied with manufacturer inspection certificate

ATTENTION: SETTING  
STANDARDS ARE NOT INCLUDED

INSPECTION  
CERTIFICATE



3701-25A

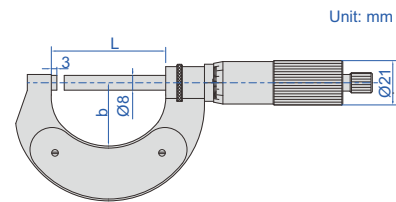

## OUTSIDE MICROMETERS WITH 50mm RANGE

**INSIZE PLUS**  
MADE IN EUROPE

- Graduation 0.01mm
- Ratchet stop
- One turn of sleeve makes 1mm spindle feed
- Carbide measuring faces
- Optional accessory: setting standards (code 7386)

ATTENTION: SETTING  
STANDARDS ARE NOT INCLUDED

LIGHT  
WEIGHT



3682-50

(mm)

Code	Range	Type	Accuracy	L	b	Weight
3682-50	0-50mm	A	4µm	62	34	0.46kg
3682-100	50-100mm	A	5µm	112	60	0.62kg
3682-150	100-150mm	A	6µm	164	85	0.78kg
3682-200	150-200mm	A	7µm	215	110	1.03kg
3682-250	200-250mm	A	8µm	264	135	1.25kg
3682-300	250-300mm	A	9µm	315	160	1.45kg
3682-350	300-350mm	B	10µm	370	190	1.50kg
3682-400	350-400mm	B	11µm	430	220	1.80kg
3682-450	400-450mm	B	12µm	475	250	2.15kg
3682-500	450-500mm	B	13µm	530	273	2.30kg
3682-550	500-550mm	B	14µm	570	291	2.40kg
3682-600	550-600mm	B	14µm	630	323	3.00kg
3682-650	600-650mm	B	16µm	675	351	3.30kg
3682-700	650-700mm	B	16µm	730	378	3.70kg
3682-750	700-750mm	B	18µm	785	401	3.90kg
3682-800	750-800mm	B	18µm	830	423	4.10kg
3682-850	800-850mm	B	20µm	885	440	4.30kg
3682-900	850-900mm	B	20µm	930	473	4.90kg
3682-950	900-950mm	B	22µm	980	503	5.80kg
3682-1000	950-1000mm	B	22µm	1030	520	6.10kg

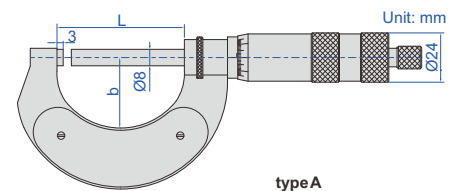

type A

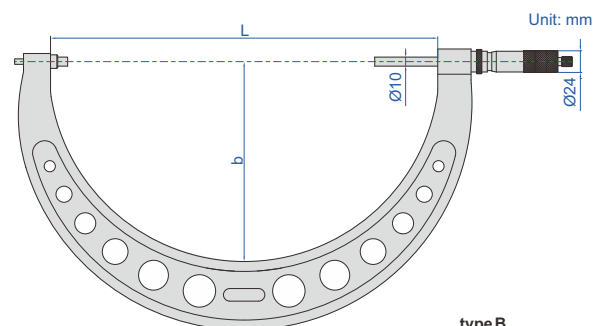

type B



ATTENTION: SETTING STANDARDS ARE NOT INCLUDED

## OUTSIDE MICROMETERS (GRADUATION 0.005mm)

**INSIZE PLUS**  
MADE IN EUROPE

- Graduation 0.005mm
- Friction thimble
- One turn of sleeve makes 0.5mm spindle feed
- Carbide measuring faces
- Optional accessory: setting standards (code 7386)



3681-25

Code	Range	Accuracy	L	b	(mm)
3681-25	0-25mm	4μm	37	24	
3681-50	25-50mm	4μm	62	34	
3681-75	50-75mm	5μm	87	46	
3681-100	75-100mm	5μm	112	60	
3681-125	100-125mm	6μm	139	72	
3681-150	125-150mm	6μm	164	85	
3681-175	150-175mm	7μm	190	97	
3681-200	175-200mm	7μm	215	110	
3681-225	200-225mm	8μm	240	122	
3681-250	225-250mm	8μm	264	135	
3681-275	250-275mm	9μm	290	148	
3681-300	275-300mm	9μm	315	160	

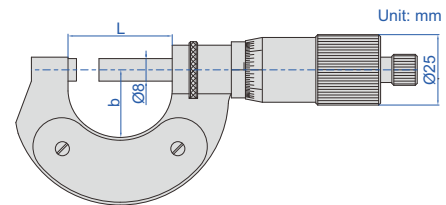

### INSPECTION CERTIFICATE

- Graduation 0.01mm
- Carbide measuring faces
- Meet DIN863-1
- Supplied with setting standards (except 0-25mm)

#### Individual

Code	Range	Accuracy	L	a	b
3202-25A *	0-25mm	4μm	32mm	6mm	24mm
3202-50A *	25-50mm	4μm	57mm	8mm	32mm
3202-75A *	50-75mm	5μm	82mm	8mm	45mm
3202-100A *	75-100mm	5μm	107mm	8mm	57mm
3202-125A	100-125mm	6μm	133mm	8mm	70mm
3202-150A	125-150mm	6μm	125mm	8mm	82mm
3202-175A	150-175mm	7μm	183mm	8mm	95mm
3202-200A	175-200mm	7μm	209mm	8mm	107mm

#### Set

Code	Range	Micrometers included
3202-753A *	0-75mm	3202-25A, 3202-50A, 3202-75A
3202-1004A *	0-100mm	3202-25A, 3202-50A, 3202-75A, 3202-100A
3202-1506A	0-150mm	3202-25A, 3202-50A, 3202-75A, 3202-100A, 3202-125A, 3202-150A

\* Supplied with manufacturer inspection certificate

## OUTSIDE MICROMETERS



3202-25A

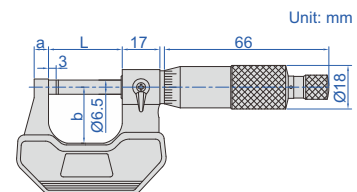

## OUTSIDE MICROMETERS

POPULAR MODEL

INSPECTION CERTIFICATE



3203-25A



3203-50A



3203-1004A



3203-3006A

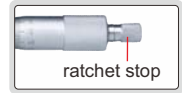

6

- Graduation: metric 0.01mm  
inch 0.0001"
- Carbide measuring faces
- Meet DIN863-1
- Supplied with setting standards (except 0-25mm and 0-1")

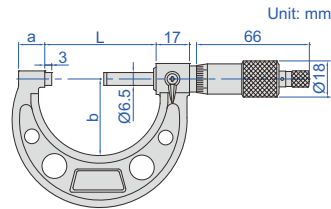

### Metric (ratchet stop type)

Code	Range	Accuracy	L	a	b
3203-25A*	0-25mm	±2µm	32mm	9mm	28mm
3203-50A*	25-50mm	±2µm	57mm	14mm	38mm
3203-75A*	50-75mm	±2µm	82mm	15mm	49mm
3203-100A*	75-100mm	±3µm	107mm	15mm	60mm
3203-125A	100-125mm	±3µm	133mm	16.5mm	73mm
3203-150A	125-150mm	±3µm	158mm	16.5mm	85mm
3203-175A	150-175mm	±4µm	183mm	19.4mm	104mm
3203-200A	175-200mm	±4µm	209mm	19.4mm	117mm
3203-225A	200-225mm	±4µm	234mm	19.4mm	130mm
3203-250A	225-250mm	±5µm	260mm	19.4mm	142mm
3203-275A	250-275mm	±5µm	285mm	19.4mm	155mm
3203-300A	275-300mm	±5µm	310mm	19.4mm	168mm

### Inch (ratchet stop type)

Code	Range	Accuracy	L	a	b
3203-1A*	0-1"	±0.0001"	1.260"	0.354"	1.102"
3203-2A*	1-2"	±0.0001"	2.244"	0.551"	1.496"
3203-3A*	2-3"	±0.0001"	3.228"	0.591"	1.929"
3203-4A*	3-4"	±0.00015"	4.213"	0.591"	2.362"
3203-5A*	4-5"	±0.00015"	5.236"	0.650"	2.874"
3203-6A*	5-6"	±0.00015"	6.220"	0.650"	3.346"
3203-7A	6-7"	±0.0002"	7.205"	0.764"	4.094"
3203-8A	7-8"	±0.0002"	8.228"	0.764"	4.606"
3203-9A	8-9"	±0.0002"	9.213"	0.764"	5.118"
3203-10A	9-10"	±0.00025"	10.236"	0.764"	5.591"
3203-11A	10-11"	±0.00025"	11.220"	0.764"	6.102"
3203-12A	11-12"	±0.00025"	12.205"	0.764"	6.614"

### Metric micrometer set (ratchet stop type)

Code	Range	Micrometers included	Packaging
3203-753A*	0-75mm	3203-25A, 3203-50A, 3203-75A	blow mould case
3203-1004A*	0-100mm	3203-25A, 3203-50A, 3203-75A, 3203-100A	blow mould case
3203-1506A	0-150mm	3203-25A, 3203-50A, 3203-75A, 3203-100A, 3203-125A, 3203-150A	blow mould case
3203-3006A	150-300mm	3203-175A, 3203-200A, 3203-225A, 3203-250A, 3203-275A, 3203-300A	aluminum box
3203-3012A	0-300mm	3203-25A, 3203-50A, 3203-75A, 3203-100A, 3203-125A, 3203-150A, 3203-175A, 3203-200A, 3203-225A, 3203-250A, 3203-275A, 3203-300A	aluminum box

### Inch micrometer set (ratchet stop type)

Code	Range	Micrometers included	Packaging
3203-33A*	0-3"	3203-1A, 3203-2A, 3203-3A	blow mould case
3203-44A*	0-4"	3203-1A, 3203-2A, 3203-3A, 3203-4A	blow mould case
3203-66A*	0-6"	3203-1A, 3203-2A, 3203-3A, 3203-4A, 3203-5A, 3203-6A	blow mould case
3203-126A	6-12"	3203-7A, 3203-8A, 3203-9A, 3203-10A, 3203-11A, 3203-12A	aluminum box
3203-1212A	0-12"	3203-1A, 3203-2A, 3203-3A, 3203-4A, 3203-5A, 3203-6A, 3203-7A, 3203-8A, 3203-9A, 3203-10A, 3203-11A, 3203-12A	aluminum box

### Inch (friction thimble type)

Code	Range	Accuracy	L	a	b
3203-1FA*	0-1"	±0.0001"	1.260"	0.354"	1.102"
3203-2FA*	1-2"	±0.0001"	2.244"	0.551"	1.496"
3203-3FA*	2-3"	±0.0001"	2.244"	0.591"	1.929"

\*Supplied with manufacturer inspection certificate



## 1µm GRADUATION OUTSIDE MICROMETERS

- Graduation 0.001mm
- Carbide measuring faces
- Meet DIN863-1
- Supplied with setting standards (except 0-25mm)



3210-25A

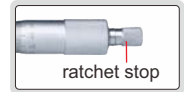

### Ratchet stop type (mm)

Code	Range	Accuracy	L	a	b
3210-25A *	0-25mm	4µm	32	9	28
3210-50A *	25-50mm	4µm	57	14	38
3210-75A *	50-75mm	5µm	82	15	49
3210-100A *	75-100mm	5µm	107	15	60
3210-125A	100-125mm	6µm	133	16.5	73
3210-150A	125-150mm	6µm	158	16.5	85
3210-175A	150-175mm	7µm	183	19.4	104
3210-200A	175-200mm	7µm	209	19.4	117

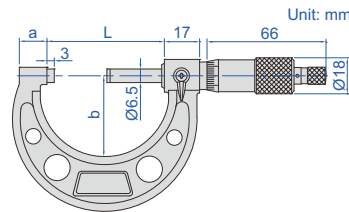

### Friction thimble type (mm)

Code	Range	Accuracy	L	a	b
3210-25FA *	0-25mm	4µm	32	9	28
3210-50FA *	25-50mm	4µm	57	14	38

### Micrometer set (ratchet stop type)

Code	Range	Micrometers included
3210-753A *	0-75mm	3210-25A, 3210-50A, 3210-75A
3210-1004A *	0-100mm	3210-25A, 3210-50A, 3210-75A, 3210-100A
3210-1506A	0-150mm	3210-25A, 3210-50A, 3210-75A, 3210-100A, 3210-125A, 3210-150A

\* Supplied with manufacturer inspection certificate



## OUTSIDE MICROMETERS WITH COUNTER

- Counter resolution: 0.01mm
- Thimble graduation: 0.01mm
- Carbide measuring faces
- Meet DIN863-1
- Ratchet stop
- Supplied with setting standards (except 0-25mm)



3400-25

Code	Range	Accuracy	L	a	b
3400-25 *	0-25mm	4µm	32mm	6mm	26mm
3400-50 *	25-50mm	4µm	57mm	8mm	32mm
3400-75 *	50-75mm	5µm	82mm	8mm	44.5mm
3400-100 *	75-100mm	5µm	107mm	8mm	57mm
3400-125 *	100-125mm	6µm	132.4mm	17mm	71.8mm
3400-150 *	125-150mm	6µm	157.8mm	17mm	84mm
3400-175 *	150-175mm	7µm	185mm	20mm	98.5mm
3400-200 *	175-200mm	7µm	210.4mm	20mm	111mm
3400-225 *	200-225mm	8µm	236mm	20mm	124mm
3400-250 *	225-250mm	8µm	261mm	20mm	136.5mm
3400-275 *	250-275mm	9µm	287mm	20mm	149mm
3400-300 *	275-300mm	9µm	312mm	20mm	162mm

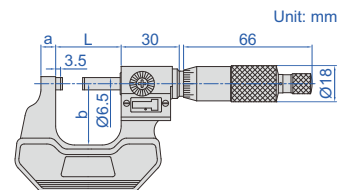

\* Supplied with manufacturer inspection certificate

## QUICK FEEDING OUTSIDE MICROMETERS

- Graduation 0.01mm
- 1mm feeding of each turn
- Friction thimble
- Carbide measuring faces
- Meet DIN863-1
- Supplied with setting standards (except 0-25mm)



3208-25B

Code	Range	Accuracy	L	a	b
3208-25B	0-25mm	4μm	32mm	6mm	24mm
3208-50B	25-50mm	4μm	57mm	8mm	32mm
3208-75B	50-75mm	5μm	82mm	8mm	45mm
3208-100B	75-100mm	5μm	107mm	8mm	57mm
3208-125B	100-125mm	6μm	133mm	8mm	70mm
3208-150B	125-150mm	6μm	158mm	8mm	82mm
3208-175B	150-175mm	7μm	183mm	8mm	95mm
3208-200B	175-200mm	7μm	209mm	8mm	107mm

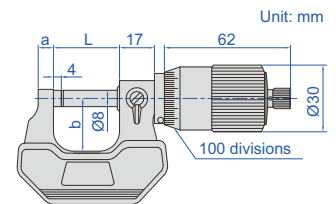

## LONG SPINDLE OUTSIDE MICROMETERS

- Graduation 0.01mm
- Carbide measuring faces
- Meet DIN863-1
- Ratchet stop
- Supplied with setting standards (except 0-25mm)



3209-25

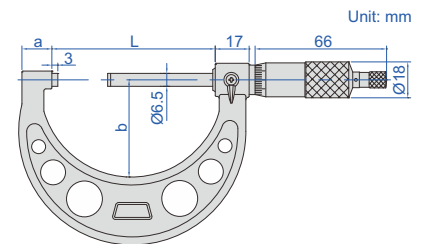

Code	Range	Accuracy	L	a	b
3209-25	0-25mm	4μm	57mm	14mm	38mm
3209-50	25-50mm	4μm	82mm	15mm	49mm
3209-75	50-75mm	5μm	107mm	15mm	60mm
3209-100	75-100mm	5μm	133mm	16.5mm	73mm

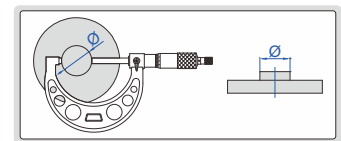
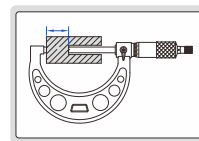

## NON MAGNETIC MICROMETERS

- Suitable for magnetic materials
- Graduation: 0.01mm
- Non magnetic carbide measuring faces
- Ratchet stop



3231-25A

Code	Range	Accuracy	L	b
3231-25A	0-25mm	4μm	32mm	24mm
3231-50A	25-50mm	4μm	57mm	32mm
3231-75A	50-75mm	5μm	82mm	45mm
3231-100A	75-100mm	5μm	105mm	57mm

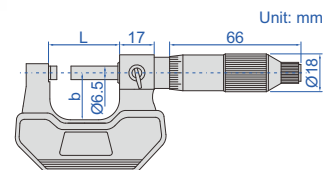

## OUTSIDE MICROMETERS FOR LEFT OR RIGHT HANDERS

- Graduation 0.01mm
- Graduations on two sides
- Ratchet stop
- Carbide measuring faces
- Meet DIN863-1
- Supplied with setting standards (except 0-25mm)

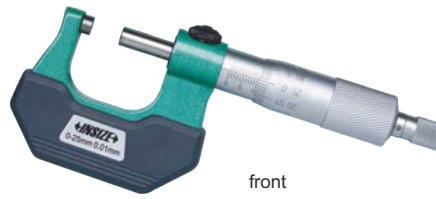

3236-25B

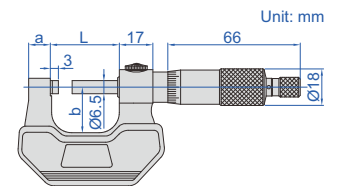

(mm)					
Code	Range	Accuracy	L	a	b
3236-25B	0-25mm	4μm	32	6	24
3236-50B	25-50mm	4μm	57	8	32
3236-75B	50-75mm	5μm	82	8	45
3236-100B	75-100mm	5μm	107	8	57
3236-125B	100-125mm	6μm	133	8	70
3236-150B	125-150mm	6μm	158	8	82
3236-175B	150-175mm	7μm	183	8	95
3236-200B	175-200mm	7μm	209	8	107

## OUTSIDE MICROMETERS

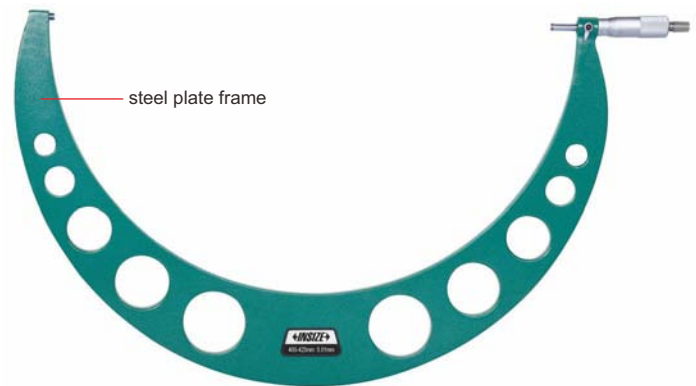
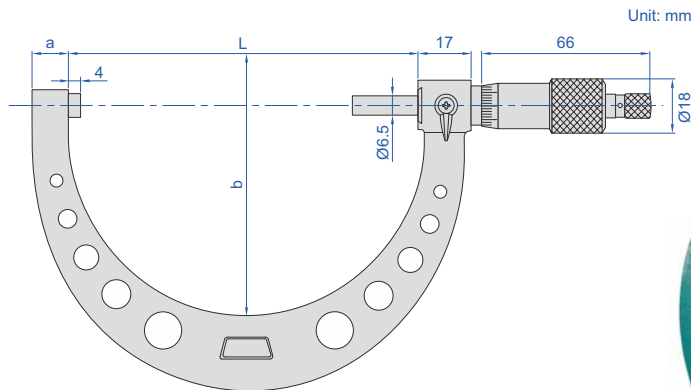

3216-425

- Graduation: 0.01mm
- Carbide measuring faces
- Meet DIN863-1
- Ratchet stop
- Supplied with setting standards

(mm)					
Code	Range	Accuracy	L	a	b
3216-325	300-325mm	10μm	338	20	176
3216-350	325-350mm	10μm	364	20	192
3216-375	350-375mm	11μm	389	20	202
3216-400	375-400mm	11μm	414	20	217
3216-425	400-425mm	12μm	440	20	226
3216-450	425-450mm	12μm	465	20	241
3216-475	450-475mm	13μm	491	20	255
3216-500	475-500mm	13μm	516	20	268



setting standard (included)

## OUTSIDE MICROMETERS WITH INTERCHANGEABLE ANVILS

cast iron frame



3206-150A

steel tube frame

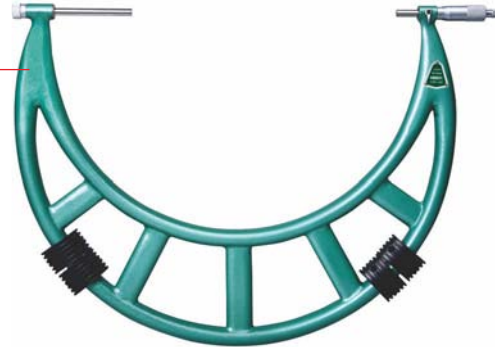

3206-400

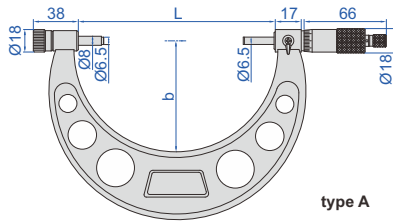

type A

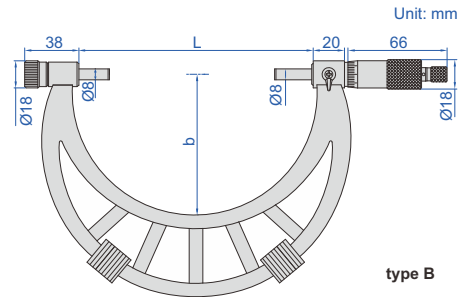

type B

Unit: mm

- Graduation 0.01mm
- Ratchet stop
- Meet DIN863-3
- Carbide measuring faces
- Supplied with setting standards

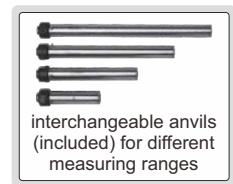
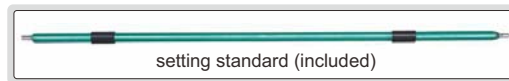

Code	Range	Type	Accuracy	L	b	Setting standard (included)
3206-50A	0-50mm	A	4 $\mu$ m	58	35	25
3206-100A	0-100mm	A	5 $\mu$ m	108	57	25, 50, 75
3206-150A	0-150mm	A	6 $\mu$ m	158	82	25, 50, 75, 100, 125
3206-151A	50-150mm	A	6 $\mu$ m	158	82	50, 75, 100, 125
3206-200A	100-200mm	A	7 $\mu$ m	208	114	100, 125, 150, 175
3206-300A	150-300mm	A	9 $\mu$ m	308	165	150, 175, 200, 225, 250, 275
3206-301A	200-300mm	A	9 $\mu$ m	308	165	200, 225, 250, 275
3206-400	300-400mm	B	11 $\mu$ m	409	224	325, 375
3206-500	400-500mm	B	13 $\mu$ m	509	275	425, 475
3206-600	500-600mm	B	14 $\mu$ m	609	321	525, 575
3206-700	600-700mm	B	16 $\mu$ m	709	371	625, 675
3206-800	700-800mm	B	18 $\mu$ m	809	426	725, 775
3206-900	800-900mm	B	20 $\mu$ m	909	476	825, 875
3206-1000	900-1000mm	B	22 $\mu$ m	1009	576	925, 975

(mm)

**IP65**  
WATERPROOF

**DATA**  
OUTPUT

## DIGITAL OUTSIDE MICROMETERS WITH INTERCHANGEABLE ANVILS



**3506-100A**

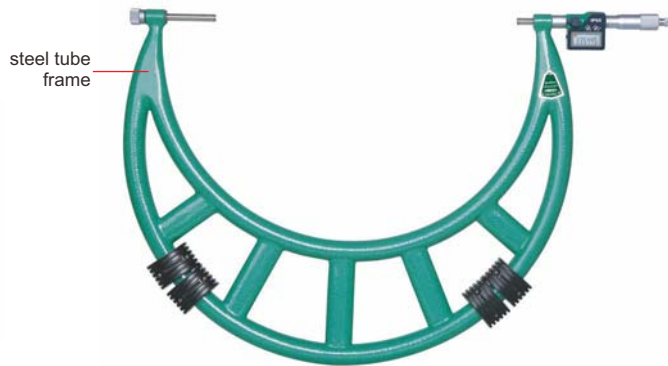

**3506-400A**

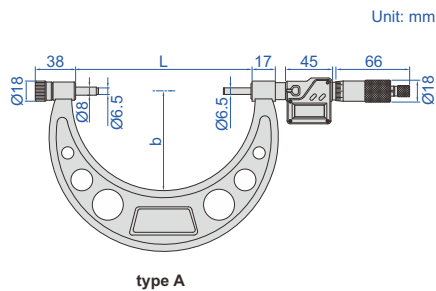

type A

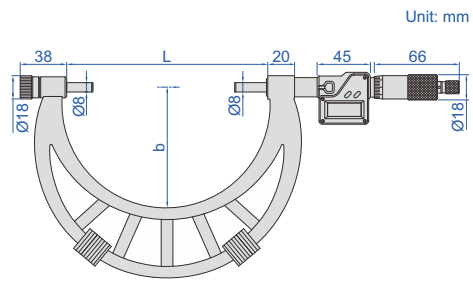

type B

- Resolution 0.001mm/0.0001" (resolution of **3506-100A** and **3506-150A** is 0.001mm/0.00005")
- IP65 dust/waterproof
- Button function: on/off, set, mm/inch, data transmit
- Data output
- Automatic power off
- Ratchet stop
- Carbide measuring faces
- Supplied with setting standards
- Optional accessory: data output cable (code **7315-31** need receiver page 4, **7302-31** page 12)

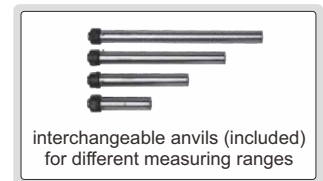

(mm)

Code	Range	Type	Accuracy	L	b	Setting standard (included)
<b>3506-100A</b>	0-100mm/0-4"	A	±5µm	105	57	25, 50, 75
<b>3506-150A</b>	0-150mm/0-6"	A	±6µm	155	82	25, 50, 75, 100, 125
<b>3506-300A</b>	150-300mm/6-12"	A	±8µm	305	165	150, 175, 200, 225, 250, 275
<b>3506-301A</b>	200-300mm/8-12"	A	±8µm	305	165	200, 225, 250, 275
<b>3506-400A</b>	300-400mm/12-16"	B	±9µm	405	224	325, 375
<b>3506-500A</b>	400-500mm/16-20"	B	±11µm	505	275	425, 475
<b>3506-600A</b>	500-600mm/20-24"	B	±12µm	605	321	525, 575
<b>3506-700A</b>	600-700mm/24-28"	B	±13µm	705	371	625, 675
<b>3506-800A</b>	700-800mm/28-32"	B	±15µm	805	426	725, 775
<b>3506-900A</b>	800-900mm/32-36"	B	±16µm	905	476	825, 875
<b>3506-1000A</b>	900-1000mm/36-40"	B	±17µm	1005	576	925, 975

## OUTSIDE MICROMETERS WITH INTERCHANGEABLE ANVILS

**INSIZE PLUS**  
MADE IN EUROPE

ATTENTION: SETTING  
STANDARDS ARE NOT INCLUDED

LIGHT  
WEIGHT

QUICK MEASUREMENT  
ONE TURN OF SLEEVE OR RATCHET  
STOP MAKES 1MM SPINDLE FEED



3675-300

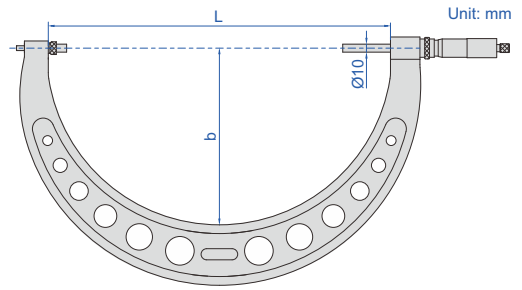

6

- Graduation 0.01mm
- Ratchet stop
- Meet DIN863-3
- Carbide measuring faces
- Light weight
- Optional accessory: setting standards (code 7386)

interchangeable anvil (included)  
for different measuring ranges



Code	Range	Accuracy	L	b	Weight
3675-200	100-200mm	6µm	240	122	1.2kg
3675-300	200-300mm	6µm	325	165	1.5kg
3675-400	300-400mm	7µm	430	220	1.9kg
3675-500	400-500mm	8µm	530	273	2.4kg
3675-600	500-600mm	9µm	630	323	3.1kg
3675-700	600-700mm	9µm	730	378	3.8kg
3675-800	700-800mm	9µm	830	423	4.2kg
3675-900	800-900mm	10µm	930	473	5kg
3675-1000	900-1000mm	10µm	1030	520	6.2kg
3675-1100	1000-1100mm	11µm	1135	585	7.6kg
3675-1200	1100-1200mm	11µm	1230	635	8.6kg
3675-1300	1200-1300mm	12µm	1335	685	9.7kg
3675-1400	1300-1400mm	12µm	1430	735	11.3kg
3675-1500	1400-1500mm	13µm	1530	780	12.5kg
3675-1600	1500-1600mm	18µm	1660	840	13.6kg
3675-1700	1600-1700mm	19µm	1765	890	14.9kg
3675-1800	1700-1800mm	20µm	1870	940	16.2kg
3675-1900	1800-1900mm	21µm	1970	1000	17.5kg
3675-2000	1900-2000mm	22µm	2075	1055	18.8kg



## OUTSIDE MICROMETERS WITH EXTENSION ANVIL COLLAR

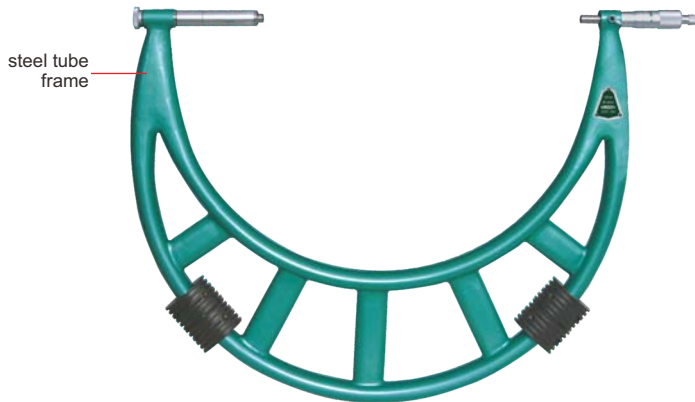

3205-400



- Graduation 0.01mm
- Adjust collars for different measuring ranges
- Ratchet stop
- Carbide measuring faces
- Supplied with setting standards

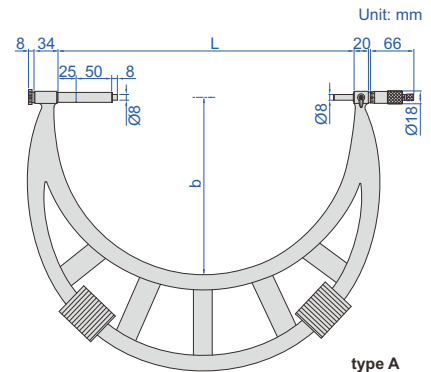

type A

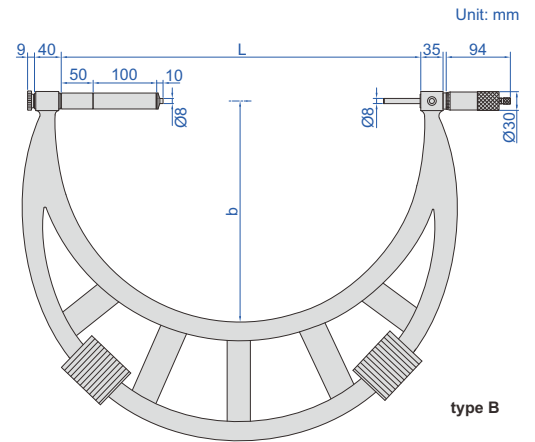

type B

(mm)

Code	Range	Type	Accuracy	L	b	Setting standard (included)
3205-400	300-400mm	A	11µm	410	250	325, 375
3205-500	400-500mm	A	13µm	510	295	425, 475
3205-600	500-600mm	A	14µm	610	345	525, 575
3205-700	600-700mm	A	16µm	710	395	625, 675
3205-800	700-800mm	A	18µm	810	445	725, 775,
3205-900	800-900mm	A	20µm	910	495	825, 875
3205-1000	900-1000mm	A	22µm	1010	545	925, 975
3205-1200	1000-1200mm	B	22µm	1210	645	1050, 1150
3205-1400	1200-1400mm	B	24µm	1410	745	1250, 1350
3205-1600	1400-1600mm	B	28µm	1610	845	1450, 1550
3205-1800	1600-1800mm	B	31µm	1810	945	1650, 1750
3205-2000	1800-2000mm	B	34µm	2010	1045	1850, 1950



adjust collars for different measuring ranges

## LIMIT MICROMETERS

- Used as Go/No-Go gage by setting upper and lower limits
- Graduation 0.002mm
- Carbide measuring faces
- Supplied with setting standard (except 0-25mm)

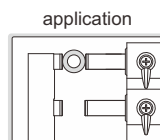

3235-25A

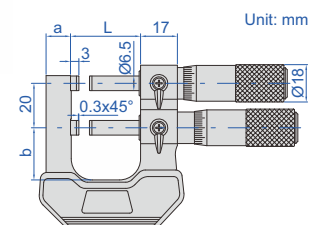

Code	Range	Accuracy	L	a	b
3235-25A	0-25mm	4µm	32mm	12mm	24mm
3235-50A	25-50mm	4µm	57mm	15mm	32mm

## INDICATING MICROMETERS

**INSIZE PLUS**  
MADE IN EUROPE

INSPECTION  
CERTIFICATE

ATTENTION: SETTING  
STANDARDS ARE NOT INCLUDED

- Meet DIN863-3
- Carbide measuring faces
- Measuring force 5-10N
- Dial can be adjusted
- Optional accessory: gage blocks grade 0 (4101-A series), for zero setting



3333-25

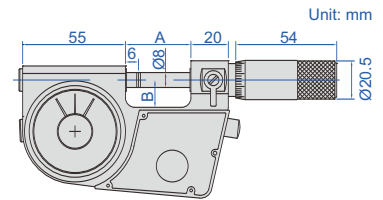

(mm)

Code	Micrometer head			Dial indicator			A	B
	range	graduation	accuracy	range	graduation	accuracy		
3333-25*	0-25mm	0.01mm	4µm	±0.07mm	1µm	±1µm	35.5	15
3333-252*	0-25mm	0.01mm	4µm	±0.14mm	2µm	±2µm	35.5	15
3333-50*	25-50mm	0.01mm	4µm	±0.07mm	1µm	±1µm	60.5	25
3333-502*	25-50mm	0.01mm	4µm	±0.14mm	2µm	±2µm	60.5	25
3333-75*	50-75mm	0.01mm	4µm	±0.07mm	1µm	±1µm	88	37.5
3333-752*	50-75mm	0.01mm	4µm	±0.14mm	2µm	±2µm	88	37.5
3333-100*	75-100mm	0.01mm	4µm	±0.07mm	1µm	±1µm	111	50
3333-1002*	75-100mm	0.01mm	4µm	±0.14mm	2µm	±2µm	111	50
3333-125*	100-125mm	0.01mm	4µm	±0.07mm	1µm	±1µm	136	62.5
3333-1252*	100-125mm	0.01mm	4µm	±0.14mm	2µm	±2µm	136	62.5
3333-150*	125-150mm	0.01mm	4µm	±0.07mm	1µm	±1µm	161	75
3333-1502*	125-150mm	0.01mm	4µm	±0.14mm	2µm	±2µm	161	75
3333-175*	150-175mm	0.01mm	4µm	±0.14mm	2µm	±2µm	186	88
3333-200*	175-200mm	0.01mm	4µm	±0.14mm	2µm	±2µm	211	101
3333-225*	200-225mm	0.01mm	4µm	±0.14mm	2µm	±2µm	236	113
3333-250*	225-250mm	0.01mm	4µm	±0.14mm	2µm	±2µm	261	126
3333-275*	250-275mm	0.01mm	4µm	±0.14mm	2µm	±2µm	286	138
3333-300*	275-300mm	0.01mm	4µm	±0.14mm	2µm	±2µm	311	151

\*Supplied with manufacturer inspection certificate



## INDICATING MICROMETERS

ATTENTION: SETTING  
STANDARDS ARE NOT INCLUDED

- Meet DIN863-3
- Micrometer head graduation: 0.002mm
- Dial indicator: range ±0.04mm, graduation 0.001mm, accuracy 0.001mm
- Carbide measuring faces
- Optional accessory: gage blocks grade 0 (4101-A series), for zero setting



3332-25



3332-25B

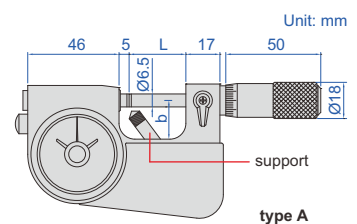

type A

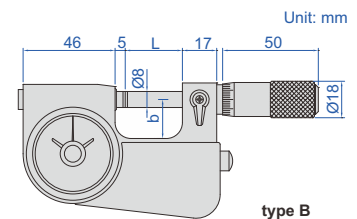

type B

(mm)

Code	Micrometer head range	Micrometer head accuracy	Type	L	b	Remark
3332-25	0-25mm	4µm	A	28.5	19	with support
3332-50	25-50mm	4µm	A	53.5	30	with support
3332-75	50-75mm	5µm	A	78.5	45	without support
3332-100	75-100mm	5µm	A	103.5	57	without support
3332-25B	0-25mm	4µm	B	28.5	19	without support

ATTENTION: SETTING STANDARDS ARE NOT INCLUDED

LIGHT WEIGHT

## MICROMETERS WITH DIAL INDICATOR

**INSIZE PLUS**  
MADE IN EUROPE

digital indicator is optional



spindle retract fork

3685-300

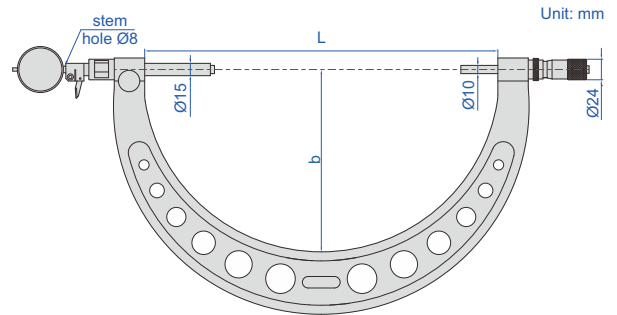

Unit: mm

- Graduation 0.01mm
- Anvil with vernier graduation, convenient adjustment for different measuring ranges
- Meet DIN863-3
- Carbide measuring faces
- Anvil retracting range: 2.5mm
- Optional accessory: dial/digital indicators, setting standards (code **7386**)

anvil with vernier graduation, can be adjusted for different measuring ranges



### Range 100mm

(mm)

Code	Range	Micrometer head accuracy	L	b	Weight
3685-300	200-300mm	6µm	320	165	1.7kg
3685-400	300-400mm	7µm	430	220	2.1kg
3685-500	400-500mm	8µm	530	273	2.6kg
3685-600	500-600mm	9µm	630	323	3.3kg
3685-700	600-700mm	9µm	730	378	4.0kg
3685-800	700-800mm	9µm	830	423	4.4kg
3685-900	800-900mm	10µm	930	473	5.2kg
3685-1000	900-1000mm	10µm	1030	520	6.4kg

### Range 200mm

(mm)

Code	Range	Micrometer head accuracy	L	b	Weight
3685-402	200-400mm	7µm	430	220	2.2kg
3685-602	400-600mm	9µm	630	323	3.4kg
3685-802	600-800mm	9µm	830	423	4.5kg
3685-1002	800-1000mm	10µm	1030	520	6.5kg
3685-1202	1000-1200mm	11µm	1230	635	8.9kg
3685-1402	1200-1400mm	12µm	1430	735	11.6kg
3685-1602	1400-1600mm	18µm	1660	840	13.9kg
3685-1802	1600-1800mm	20µm	1870	940	16.5kg
3685-2002	1800-2000mm	22µm	2075	1055	19.1kg

## MICROMETERS WITH DIAL INDICATOR

**INSIZE PLUS**  
MADE IN EUROPE

ATTENTION: SETTING  
STANDARDS ARE NOT INCLUDED

INSPECTION  
CERTIFICATE

digital indicator  
is optional



3346-25

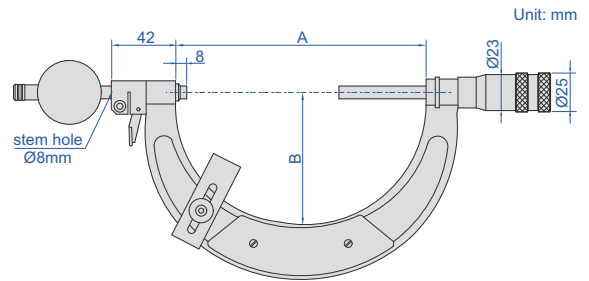

6

(mm)

Code	Micrometer head range	Micrometer head graduation	Micrometer head accuracy	A	B
3346-25 *	0-25mm	5µm	4µm	37	24
3346-50 *	25-50mm	5µm	4µm	62	34
3346-75 *	50-75mm	5µm	5µm	87	46
3346-100 *	75-100mm	5µm	5µm	112	60
3346-150 *	100-150mm	5µm	6µm	164	85
3346-200 *	150-200mm	5µm	7µm	215	110
3346-250 *	200-250mm	5µm	8µm	264	135
3346-300 *	250-300mm	5µm	9µm	315	160

- Anvil retracting range: 2.5mm
- Carbide measuring faces
- Parallelism of measuring faces: 1µm
- Optional accessory: dial indicator (code 2890-1F), digital indicator, gage blocks grade 1 (4101-B series), for zero setting

\* Supplied with manufacturer inspection certificate

## MICROMETERS WITH DIAL INDICATOR

ATTENTION: NOT SUITABLE  
FOR 0.001MM DIAL INDICATORS

- Meet DIN863-3
- Micrometer head graduation 0.01mm
- Anvil retracting range: 8mm
- Carbide measuring faces
- Supplied with setting standards (except 0-25mm)
- Optional accessory: dial indicators (graduation 0.01mm), digital indicators (resolution 0.01mm/0.0005")



3331-25A

Code	Micrometer head range	Micrometer head accuracy	L	b
3331-25A	0-25mm	4µm	67mm	38mm
3331-50A	25-50mm	4µm	92.4mm	50mm
3331-75A	50-75mm	5µm	117.6mm	62mm
3331-100A	75-100mm	5µm	143mm	70mm
3331-125A	100-125mm	6µm	168.2mm	82mm
3331-150A	125-150mm	6µm	192mm	94.5mm
3331-175A	150-175mm	7µm	217mm	107mm

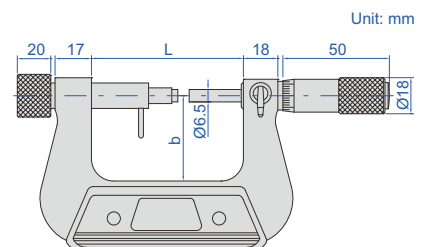

ATTENTION: NOT SUITABLE FOR 0.001MM DIAL INDICATORS



3296-100A

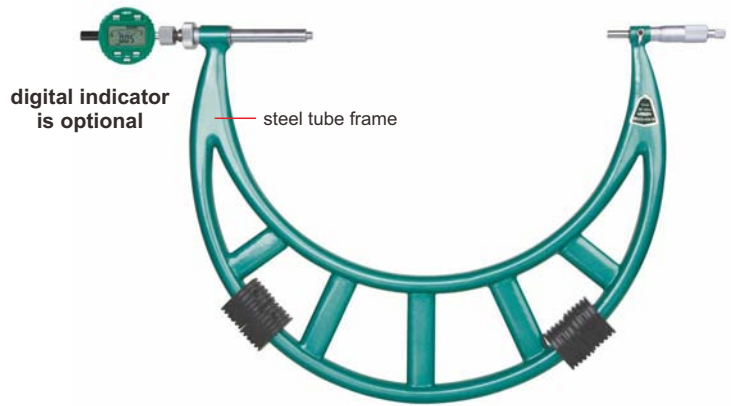
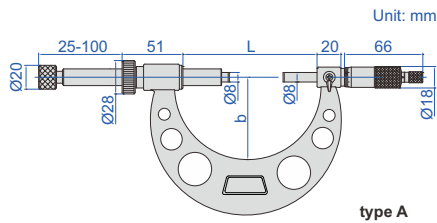

3296-400A

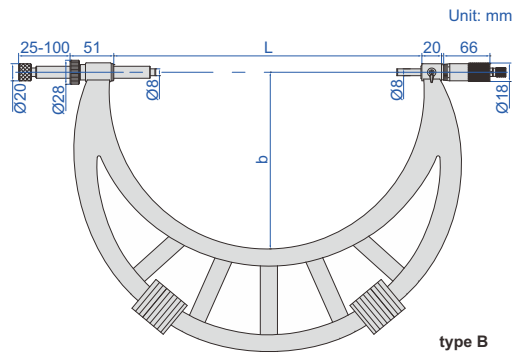

Code	Range	Type	Accuracy	L	b
3296-100A	0-100mm	A	6µm	115	68
3296-200A	100-200mm	A	7µm	215	120
3296-300A	200-300mm	A	8µm	315	170
3296-400A	300-400mm	B	9µm	415	225
3296-500A	400-500mm	B	10µm	515	275
3296-600A	500-600mm	B	11µm	615	325
3296-700A	600-700mm	B	12µm	715	375
3296-800A	700-800mm	B	13µm	815	430
3296-900A	800-900mm	B	14µm	915	480
3296-1000A	900-1000mm	B	15µm	1015	530

- Meet DIN863-3
- Graduation 0.01mm
- Ratchet stop
- Carbide measuring faces
- Supplied with setting standards
- Optional accessory: dial indicators (graduation 0.01mm) digital indicators (resolution 0.01mm/0.0005")

## GROOVE MICROMETERS



3287-50B

- Measure width of grooves inside bores
- Graduation 0.01mm
- Two graduations for inside and outside measurements
- Non-rotating spindle
- Two-directional ratchet stop

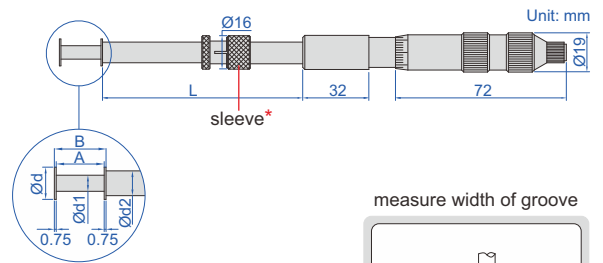

measure width of groove

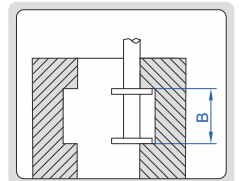

measure width of keyway

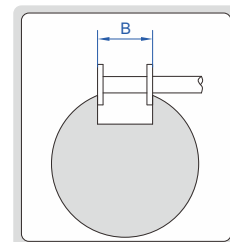

measure position of groove

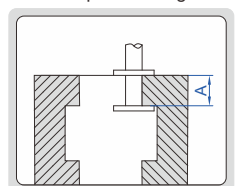

Code	Range (outside A)	Range (inside B)	Accuracy	L	Ød	Ød1	Ød2
3287-25B	0-25mm	1.6-26.5mm	10µm	120	13	6.5	10
3287-50B	25-50mm	26.5-51.5mm	10µm	120	13	6.5	10
3287-75B	50-75mm	51.5-76.5mm	10µm	120	13	6.5	10
3287-100B	75-100mm	76.5-101.5mm	10µm	120	13	6.5	10
3287-125B	100-125mm	101.5-126.5mm	15µm	120	13	6.5	10
3287-150B	125-150mm	126.5-151.5mm	15µm	120	13	6.5	10
3287-251B*	0-25mm	1.6-26.5mm	10µm	90	6.5	3	5

\*3287-251B does not have sleeve

## 3-WIRES



- Used with standard outside micrometers to measure pitch diameter of screw threads
- Diameter accuracy:  $\pm 0.5\mu\text{m}$
- Cylindricity:  $1\mu\text{m}$
- Hardness: HRC60
- Supplied with manufacturer inspection certificate



7382-19

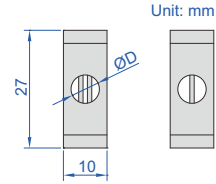

application



### For outside micrometers with spindle $\text{Ø}6.35\text{mm}$ ( $\text{ØD}$ )

Code	Pin gage diameter	Applicable pitch
7382-11	$\text{Ø}0.170\text{mm}$	0.2mm, 0.25mm, 0.3mm
7382-12	$\text{Ø}0.195\text{mm}$	0.35mm
7382-13	$\text{Ø}0.220\text{mm}$	0.4mm
7382-14	$\text{Ø}0.250\text{mm}$	0.45mm
7382-15	$\text{Ø}0.290\text{mm}$	0.5mm
7382-16	$\text{Ø}0.335\text{mm}$	0.6mm
7382-17	$\text{Ø}0.390\text{mm}$	0.7mm
7382-18	$\text{Ø}0.455\text{mm}$	0.75mm, 0.8mm
7382-19	$\text{Ø}0.530\text{mm}$	0.9mm
7382-110	$\text{Ø}0.620\text{mm}$	1.0mm
7382-111	$\text{Ø}0.725\text{mm}$	1.25mm
7382-112	$\text{Ø}0.895\text{mm}$	1.5mm
7382-113	$\text{Ø}1.100\text{mm}$	1.75mm, 2.0mm
7382-114	$\text{Ø}1.350\text{mm}$	2.5mm
7382-115	$\text{Ø}1.650\text{mm}$	3.0mm
7382-116	$\text{Ø}2.050\text{mm}$	3.5mm
7382-117	$\text{Ø}2.550\text{mm}$	4mm, 4.5mm
7382-118	$\text{Ø}3.200\text{mm}$	5mm, 5.5mm, 6mm
7382-1S	18 pairs/set, including all above 3-wires	

### For outside micrometers with spindle $\text{Ø}6.50\text{mm}$ ( $\text{ØD}$ )

Code	Pin gage diameter	Applicable pitch
7382-21	$\text{Ø}0.170\text{mm}$	0.2mm, 0.25mm, 0.3mm
7382-22	$\text{Ø}0.195\text{mm}$	0.35mm
7382-23	$\text{Ø}0.220\text{mm}$	0.4mm
7382-24	$\text{Ø}0.250\text{mm}$	0.45mm
7382-25	$\text{Ø}0.290\text{mm}$	0.5mm
7382-26	$\text{Ø}0.335\text{mm}$	0.6mm
7382-27	$\text{Ø}0.390\text{mm}$	0.7mm
7382-28	$\text{Ø}0.455\text{mm}$	0.75mm, 0.8mm
7382-29	$\text{Ø}0.530\text{mm}$	0.9mm
7382-210	$\text{Ø}0.620\text{mm}$	1.0mm
7382-211	$\text{Ø}0.725\text{mm}$	1.25mm
7382-212	$\text{Ø}0.895\text{mm}$	1.5mm
7382-213	$\text{Ø}1.100\text{mm}$	1.75mm, 2.0mm
7382-214	$\text{Ø}1.350\text{mm}$	2.5mm
7382-215	$\text{Ø}1.650\text{mm}$	3.0mm
7382-216	$\text{Ø}2.050\text{mm}$	3.5mm
7382-217	$\text{Ø}2.550\text{mm}$	4mm, 4.5mm
7382-218	$\text{Ø}3.200\text{mm}$	5mm, 5.5mm, 6mm
7382-2S	18 pairs/set, including all above 3-wires	

6

## 3-WIRES



CUSTOMIZABLE DIAMETER  $\text{Ød}$

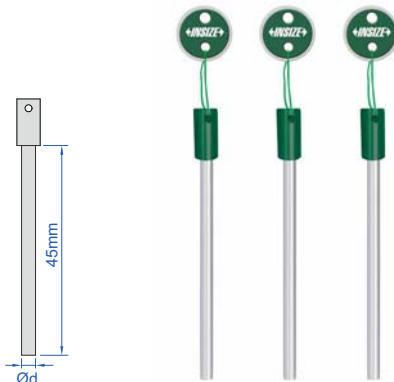

7394-75A

- $\text{Ød} \leq 0.3\text{mm}$ , made of alloy steel, hardness HRC60;
- $\text{Ød} > 0.3\text{mm}$ , made of carbide, hardness HRA90
- Diameter accuracy:  $\pm 0.5\mu\text{m}$
- Cylindricity:  $\pm 0.5\mu\text{m}$
- Supplied with manufacturer inspection certificate

Code	Diameter ( $\text{Ød}$ )	Applicable pitch
7394-60A*	0.170mm	0.2mm, 0.25mm, 0.3mm
7394-61A*	0.195mm	0.35mm
7394-62A*	0.220mm	0.4mm
7394-63A*	0.250mm	0.45mm
7394-64A*	0.290mm	0.5mm
7394-65A	0.335mm	0.6mm
7394-66A	0.390mm	0.7mm
7394-67A	0.455mm	0.75mm, 0.8mm
7394-68A	0.530mm	0.9mm
7394-69A	0.620mm	1.0mm
7394-70A	0.725mm	1.25mm
7394-71A	0.895mm	1.5mm
7394-72A	1.100mm	1.75mm, 2.0mm
7394-73A	1.350mm	2.5mm
7394-74A	1.650mm	3.0mm
7394-75A	2.050mm	3.5mm
7394-76A	2.550mm	4mm, 4.5mm
7394-77A	3.200mm	5mm, 5.5mm, 6mm

\* Made of alloy steel

## EXTERNAL SCREW THREAD MICROMETERS



tips are optional

3680-50

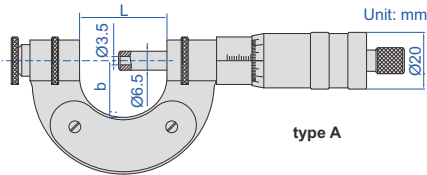

type A

- Measure pitch diameter of screw threads
- Graduation 0.01mm
- Optional accessory: setting standards (code 7384), external tread tips (code 7390), dial/digital indicators (only for type B)

### Type A (ratchet stop)

(mm)

Code	Range	Accuracy	L	b
3680-25 *	0-25mm	4µm	37	24
3680-50 *	25-50mm	4µm	62	34
3680-75 *	50-75mm	4µm	87	46
3680-100 *	75-100mm	4µm	112	60
3680-125 *	100-125mm	5µm	139	72
3680-150 *	125-150mm	5µm	164	85
3680-200 *	150-200mm	7µm	215	110
3680-250 *	200-250mm	7µm	264	135
3680-300 *	250-300mm	7µm	315	160

### Type B (without ratchet stop)

(mm)

Code	Range	Left anvil retracting stroke	Micrometer head accuracy	L	b
3680-3001 *	200-300mm	2.5mm	6µm	320	165
3680-4001 *	300-400mm	2.5mm	7µm	430	220
3680-5001 *	400-500mm	2.5mm	8µm	530	273
3680-6001 *	500-600mm	2.5mm	9µm	630	323
3680-7001 *	600-700mm	2.5mm	9µm	730	378
3680-8001 *	700-800mm	2.5mm	9µm	830	423
3680-9001 *	800-900mm	2.5mm	10µm	930	473
3680-10001 *	900-1000mm	2.5mm	10µm	1030	520
3680-4002 *	200-400mm	2.5mm	7µm	430	220
3680-6002 *	400-600mm	2.5mm	9µm	630	323
3680-8002 *	600-800mm	2.5mm	9µm	830	423
3680-10002 *	800-1000mm	2.5mm	10µm	1030	520
3680-12002 *	1000-1200mm	2.5mm	11µm	1230	635
3680-14002 *	1200-1400mm	2.5mm	12µm	1430	735
3680-16002 *	1400-1600mm	2.5mm	18µm	1660	840
3680-18002 *	1600-1800mm	2.5mm	20µm	1870	940
3680-20002 *	1800-2000mm	2.5mm	22µm	2075	1055

\* Supplied with manufacturer inspection certificate



digital indicator is optional

tips are optional

3680-4001

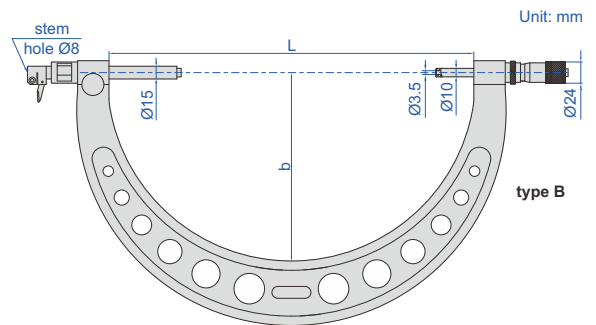

type B

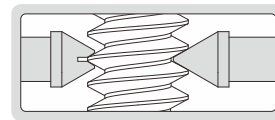

## MEASURING TIPS FOR EXTERNAL SCREW THREAD MICROMETERS

**INSIZE PLUS**  
MADE IN EUROPE

- Supplied in pair
- Made of hardened steel
- Suitable for 3680 series micrometers

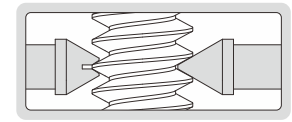
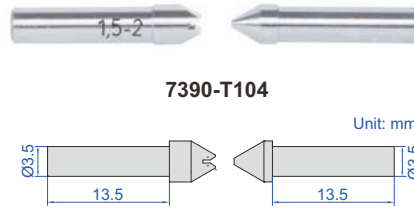

### 60° thread angle

Code	Pitch
7390-T101	0.35-0.5mm/ 72-48TPI
7390-T102	0.6-0.8mm/ 44-32TPI
7390-T103	0.9-1.25mm/ 28-18TPI
7390-T104	1.5-2mm/ 16-11TPI
7390-T105	2.5-3.5mm/ 10-7TPI
7390-T106	4-6mm/ 6-4TPI

### 55° thread angle

Code	Pitch
7390-T201	60-48TPI
7390-T202	40-32TPI
7390-T203	28-22TPI
7390-T204	20-16TPI
7390-T205	14-11TPI
7390-T206	10-7TPI
7390-T207	6-4TPI

### 30° thread angle

Code	Pitch
7390-T301	1.5mm
7390-T302	2mm
7390-T303	3mm
7390-T304	4mm
7390-T305	5-6mm
7390-T306	7-8mm
7390-T307	9-10mm
7390-T308	12-14mm

6

## SETTING STANDARDS FOR EXTERNAL SCREW THREAD MICROMETERS

**INSIZE PLUS**  
MADE IN EUROPE

ATTENTION: WHEN PITCH <0.4MM OR >63.5 TPI, SETTING STANDARDS CANNOT BE USED TO SET ZERO, A CALIBRATED WORK PIECE CAN BE USED INSTEAD

TIPS FOR TRAPEZOIDAL, ACME THREAD ARE ALSO AVAILABLE



7384-A100

- Made of hardened steel
- Deviation (difference between the ordered size and the size marked on the setting standard when supplied):  $\pm 20\mu\text{m}$   
For example, the ordered size is 25mm, the size marked on the setting standard when supplied may be 25.015mm

### 60° thread angle

Code	L	Ød	Accuracy (mm)
7384-A25	25	7.8	$\pm 2.5\mu\text{m}$
7384-A50	50	7.8	$\pm 3\mu\text{m}$
7384-A75	75	7.8	$\pm 3.5\mu\text{m}$
7384-A100	100	7.8	$\pm 4\mu\text{m}$
7384-A125	125	7.8	$\pm 4.5\mu\text{m}$
7384-A150	150	7.8	$\pm 5\mu\text{m}$
7384-A175	175	7.8	$\pm 5.5\mu\text{m}$
7384-A200	200	7.8	$\pm 6\mu\text{m}$
7384-A225	225	10	$\pm 6.5\mu\text{m}$
7384-A250	250	10	$\pm 7\mu\text{m}$
7384-A275	275	10	$\pm 7.5\mu\text{m}$
7384-A300	300	10	$\pm 8\mu\text{m}$

### 55° thread angle

Code	L	Ød	Accuracy (mm)
7384-B25	25	7.8	$\pm 2.5\mu\text{m}$
7384-B50	50	7.8	$\pm 3\mu\text{m}$
7384-B75	75	7.8	$\pm 3.5\mu\text{m}$
7384-B100	100	7.8	$\pm 4\mu\text{m}$
7384-B125	125	7.8	$\pm 4.5\mu\text{m}$
7384-B150	150	7.8	$\pm 5\mu\text{m}$
7384-B175	175	7.8	$\pm 5.5\mu\text{m}$
7384-B200	200	7.8	$\pm 6\mu\text{m}$
7384-B225	225	10	$\pm 6.5\mu\text{m}$
7384-B250	250	10	$\pm 7\mu\text{m}$
7384-B275	275	10	$\pm 7.5\mu\text{m}$
7384-B300	300	10	$\pm 8\mu\text{m}$



NON-ROTATING SPINDLE

## SCREW THREAD MICROMETERS



**3281-25A**  
(measuring tips are optional)



**3281-S25**  
(measuring tips are included)



- Measure pitch diameter of screw threads
- Graduation 0.01mm
- Non-rotating spindle
- Ratchet stop
- Supplied with 60° setting standards (except 0-25mm)
- Optional accessory: 55° setting standards

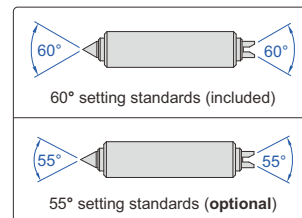
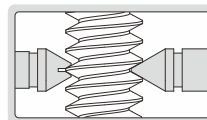

Measuring tips are optional (mm)

Code	Range	L	b	55° setting standard (optional)
3281-25A	0-25mm	42	26	-
3281-50A	25-50mm	67	38	3281-SP1
3281-75A	50-75mm	92	50	3281-SP2
3281-100A	75-100mm	117.6	62	3281-SP3
3281-125A	100-125mm	143	70	3281-SP4
3281-150A	125-150mm	168.2	82	3281-SP5
3281-175A	150-175mm	192	94.5	3281-SP6
3281-200A	175-200mm	217	107	3281-SP7
3281-225A	200-225mm	242	130	3281-SP8
3281-250A	225-250mm	267	142	3281-SP9
3281-275A	250-275mm	291	155	3281-SP10
3281-300A	275-300mm	317	167	3281-SP11

Measuring tips are included (mm)

Code	Range	L	b	Measuring tips (included)	55° setting standard (optional)
3281-S25	0-25mm	42	26	6 pairs of measuring tips: metric and unified thread (60° thread angle) 0.4-0.5mm/64-48TPI, 0.6-0.9mm/44-28TPI, 1-1.75mm/24-14TPI, 2-3mm/13-9TPI, 3.5-5mm/8-5TPI, 5.5-7mm/4.5-3.5TPI	-
3281-S50	25-50mm	67	38		3281-SP1
3281-S75	50-75mm	92	50		3281-SP2
3281-S100	75-100mm	117.6	62		3281-SP3
3281-S125	100-125mm	143	70		3281-SP4
3281-S150	125-150mm	168.2	82		3281-SP5
3281-S175	150-175mm	192	94.5		3281-SP6
3281-S200	175-200mm	217	107		3281-SP7
3281-S225	200-225mm	242	130		3281-SP8
3281-S250	225-250mm	267	142		3281-SP9
3281-S275	250-275mm	291	155		3281-SP10
3281-S300	275-300mm	317	167	3281-SP11	

accuracy of micrometers with tips (mm)

Pitch	Range							
	0-25	25-50	50-75	75-100	100-125	125-200	200-225	225-300
0.4~0.5	±0.01	-	-	-	-	-	-	-
0.6~0.8	±0.01	±0.013	-	-	-	-	-	-
1~1.25	±0.012	±0.015	±0.017	±0.017	-	-	-	-
1.5~2.0	±0.014	±0.017	±0.019	±0.019	±0.020	±0.023	±0.025	±0.028
2.5~3.5	±0.016	±0.019	±0.021	±0.021	±0.023	±0.025	±0.028	±0.031
4.0~7.0	-	±0.021	±0.023	±0.023	±0.025	±0.028	±0.031	±0.033

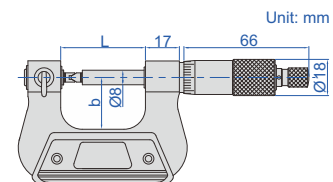

# DIGITAL SCREW THREAD MICROMETERS

DATA  
OUTPUT

NON-ROTATING  
SPINDLE



**3581-25A**  
(measuring tips are optional)



**3581-S25**  
(measuring tips are included)

6

Measuring tips are optional (mm)

Code	Range	L	b	55° setting standard (optional)
3581-25A	0-25mm/0-1"	42	26	-
3581-50A	25-50mm/1-2"	67	38	3281-SP1
3581-75A	50-75mm/2-3"	92	50	3281-SP2
3581-100A	75-100mm/3-4"	117.6	62	3281-SP3
3581-125A	100-125mm/4-5"	143	70	3281-SP4
3581-150A	125-150mm/5-6"	168.2	82	3281-SP5
3581-175A	150-175mm/6-7"	192	94.5	3281-SP6
3581-200A	175-200mm/7-8"	217	107	3281-SP7
3581-225A	200-225mm/8-9"	242	130	3281-SP8
3581-250A	225-250mm/9-10"	267	142	3281-SP9
3581-275A	250-275mm/10-11"	291	155	3281-SP10
3581-300A	275-300mm/11-12"	317	167	3281-SP11

- Measure pitch diameter of screw threads
- Resolution 0.001mm/0.00005"
- Button function: on/off, set, mm/inch, data transmit
- Data output
- Automatic power off
- Non-rotating spindle
- Ratchet stop
- Supplied with 60° setting standards (except 0-25mm/0-1")
- Optional accessory: 55° setting standards, data output cable (code 7315-31 need receiver page 4, 7302-31 page 12)

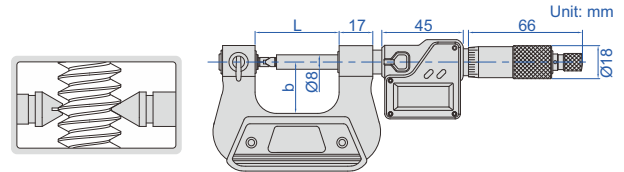

Measuring tips are included (mm)

Code	Range	L	b	Measuring tips (included)	55° setting standard (optional)
3581-S25	0-25mm/0-1"	42	26	6 pairs of measuring tips: metric and unified thread (60° thread angle) 0.4-0.5mm/64-48TPI, 0.6-0.9mm/44-28TPI, 1-1.75mm/24-14TPI, 2-3mm/13-9TPI, 3.5-5mm/8-5TPI, 5.5-7mm/4.5-3.5TPI	-
3581-S50	25-50mm/1-2"	67	38		3281-SP1
3581-S75	50-75mm/2-3"	92	50		3281-SP2
3581-S100	75-100mm/3-4"	117.6	62		3281-SP3
3581-S125	100-125mm/4-5"	143	70		3281-SP4
3581-S150	125-150mm/5-6"	168.2	82		3281-SP5
3581-S175	150-175mm/6-7"	192	94.5		3281-SP6
3581-S200	175-200mm/7-8"	217	107		3281-SP7
3581-S225	200-225mm/8-9"	242	130		3281-SP8
3581-S250	225-250mm/9-10"	267	142		3281-SP9
3581-S275	250-275mm/10-11"	291	155		3281-SP10
3581-S300	275-300mm/11-12"	317	167	3281-SP11	

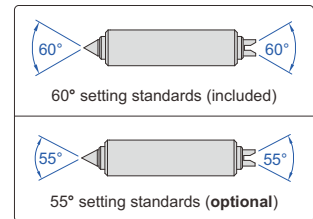

accuracy of micrometers with tips (mm)

Pitch	Range							
	0-25	25-50	50-75	75-100	100-125	125-200	200-225	225-300
0.4~0.5	±0.01	-	-	-	-	-	-	-
0.6~0.8	±0.01	±0.013	-	-	-	-	-	-
1~1.25	±0.012	±0.015	±0.017	±0.017	-	-	-	-
1.5~2.0	±0.014	±0.017	±0.019	±0.019	±0.020	±0.023	±0.025	±0.028
2.5~3.5	±0.016	±0.019	±0.021	±0.021	±0.023	±0.025	±0.028	±0.031
4.0~7.0	-	±0.021	±0.023	±0.023	±0.025	±0.028	±0.031	±0.033

## MEASURING TIPS FOR SCREW THREAD MICROMETERS

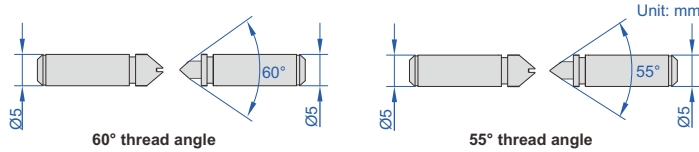

7381-T13

- Supplied in pair
- Suitable for **3281**, **3581** series micrometers

### Metric and unified thread (60° thread angle)

Code	Pitch
7381-T11	0.4-0.5mm/ 64-48TPI
7381-T12	0.6-0.9mm/ 44-28TPI
7381-T13	1-1.75mm/ 24-14TPI
7381-T14	2-3mm/ 13-9TPI
7381-T15	3.5-5mm/ 8-5TPI
7381-T16	5.5-7mm/ 4.5-3.5TPI
7381-TS	6 pairs/set, including all above tips

### Whitworth thread (55° thread angle)

Code	Pitch
7381-T21	60-48TPI
7381-T22	48-40TPI
7381-T23	40-32TPI
7381-T24	32-24TPI
7381-T25	24-18TPI
7381-T26	18-14TPI
7381-T27	14-10TPI
7381-T28	10-7TPI
7381-T29	7-4.5TPI
7381-T210	4.5-3.5TPI
7381-T2S	10 pairs/set, including all above tips



ATTENTION: SETTING STANDARDS ARE NOT INCLUDED

## EXTERNAL GEAR TOOTH MICROMETERS

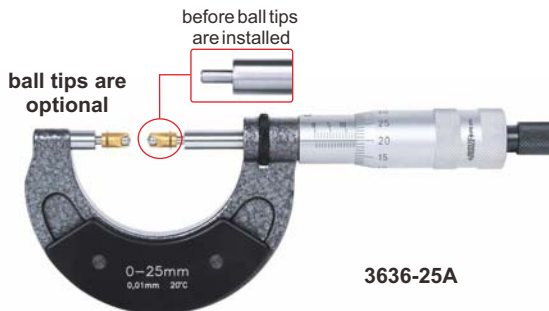

3636-25A

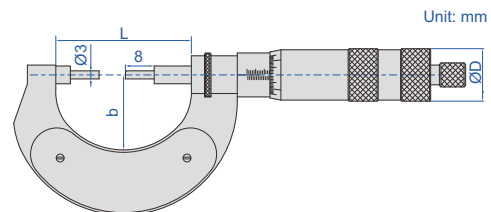

- Meet DIN863-3
- Measure over-pin diameter of gears
- Graduation 0.01mm
- Ratchet stop
- Optional accessory: ball tips (code **7389**), cylindrical tips (code **7393**), setting standards (code **7386**)

cylindrical tips (optional)

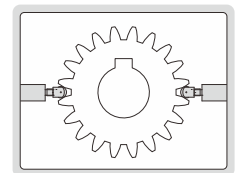

Code	Range	Accuracy	L	b	ØD
3636-25A*	0-25mm	3µm	62	34	20
3636-50A*	25-50mm	3µm	87	46	20
3636-75A*	50-75mm	4µm	112	60	20
3636-100A*	75-100mm	4µm	139	72	20
3636-125A*	100-125mm	5µm	164	85	20
3636-150A*	125-150mm	5µm	190	97	20
3636-175A*	150-175mm	5µm	215	110	20
3636-200A*	175-200mm	5µm	240	122	20

\* Supplied with manufacturer inspection certificate

Code	Range	Accuracy	L	b	ØD
3636-225A*	200-225mm	6µm	264	135	20
3636-250A*	225-250mm	6µm	290	148	20
3636-300A*	250-300mm	6µm	325	165	24
3636-350A*	300-350mm	7µm	370	190	24
3636-400A*	350-400mm	7µm	430	220	24
3636-450A*	400-450mm	8µm	475	250	24
3636-500A*	450-500mm	8µm	530	273	24
3636-550A*	500-550mm	9µm	570	291	24
3636-600A*	550-600mm	9µm	630	323	24

## CYLINDRICAL TIPS FOR GEAR TOOTH MICROMETERS

**INSIZE PLUS**  
MADE IN EUROPE

CYLINDRICAL DIAMETER  
ØD CAN BE CUSTOMIZED

- Supplied in pair
- Made of hardened steel
- Self-positioning
- Suitable for 3636, 3638, 3678, series micrometers



7393-T5

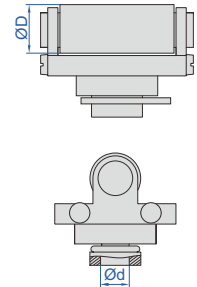

Code	Diameter of shaft (ØD)	Ød	Accuracy
7393-T1	1mm	3mm	±1µm
7393-T2	2mm	3mm	±1µm
7393-T3	3mm	3mm	±1µm
7393-T3D5	3.5mm	3mm	±1µm
7393-T4	4mm	3mm	±1µm
7393-T5	5mm	3mm	±1µm
7393-T6	6mm	3mm	±1µm
7393-T7	7mm	3mm	±1µm
7393-T8	8mm	3mm	±1µm

6

## BALL TIPS FOR GEAR TOOTH MICROMETERS

**INSIZE PLUS**  
MADE IN EUROPE

BALL TIPS DIAMETER  
SØD CAN BE CUSTOMIZED

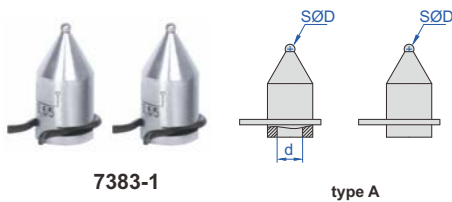

7383-1

type A

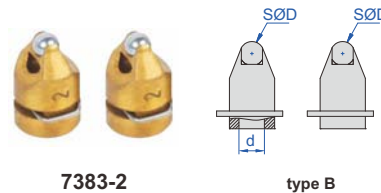

7383-2

type B

- Supplied in pair
- Made of hardened steel
- Suitable for 3636, 3638, 3678 series micrometers

Code	Ball dia. (SØD)	d	Accuracy	Type
7383-1	SØ1mm	Ø3mm	±1µm	A
7383-1D5	SØ1.5mm	Ø3mm	±1µm	B
7383-1D75	SØ1.75mm	Ø3mm	±1µm	B
7383-2	SØ2mm	Ø3mm	±1µm	B
7383-2D25	SØ2.25mm	Ø3mm	±1µm	B
7383-2D5	SØ2.5mm	Ø3mm	±1µm	B
7383-3	SØ3mm	Ø3mm	±1µm	B
7383-3D5	SØ3.5mm	Ø3mm	±1µm	B
7383-4	SØ4mm	Ø3mm	±1µm	B
7383-4D5	SØ4.5mm	Ø3mm	±1µm	B
7383-5	SØ5mm	Ø3mm	±1µm	B
7383-5D5	SØ5.5mm	Ø3mm	±1µm	B
7383-6	SØ6mm	Ø3mm	±1µm	B

Code	Ball dia. (SØD)	d	Accuracy	Type
7383-6D5	SØ6.5mm	Ø3mm	±1µm	B
7383-7	SØ7mm	Ø3mm	±1µm	B
7383-7D5	SØ7.5mm	Ø3mm	±1µm	B
7383-8	SØ8mm	Ø3mm	±1µm	B
7383-9	SØ9mm	Ø3mm	±1µm	B
7383-10	SØ10mm	Ø3mm	±1µm	B
7383-10D5	SØ10.5mm	Ø3mm	±1.5µm	B
7383-11	SØ11mm	Ø3mm	±1.5µm	B
7383-12	SØ12mm	Ø3mm	±1.5µm	B
7383-13	SØ13mm	Ø3mm	±1.5µm	B
7383-14	SØ14mm	Ø3mm	±1.5µm	B
7383-15	SØ15mm	Ø3mm	±1.5µm	B
7383-16	SØ16mm	Ø3mm	±1.5µm	B

## GEAR TOOTH MICROMETERS

- Meet DIN863-3
- Measure over-pin diameter of gears
- Graduation 0.01mm
- Ratchet stop
- Supplied with setting standards (except 0-25mm)
- Optional accessory: ball tips (code 7391)

Code	Range	Accuracy	L	b
3291-25	0-25mm	4μm	67	38
3291-50	25-50mm	4μm	92.4	50
3291-75	50-75mm	5μm	117.6	62
3291-100	75-100mm	5μm	143	70
3291-125	100-125mm	6μm	168.2	82
3291-150	125-150mm	6μm	192	94.5
3291-175	150-175mm	7μm	217	107
3291-200	175-200mm	7μm	242	130
3291-225	200-225mm	8μm	267	142.5
3291-250	225-250mm	8μm	292	155
3291-275	250-275mm	9μm	317	167.5



3291-25

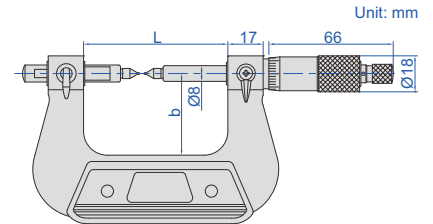
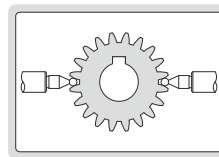

**IP65**  
WATERPROOF

**DATA**  
OUTPUT

## DIGITAL GEAR TOOTH MICROMETERS

- Measure over-pin diameter of gears
- Resolution 0.001mm/0.00005"
- IP65 dust/waterproof
- Button function: on/off, set, mm/inch, data transmit
- Data output
- Automatic power off
- Ratchet stop
- Supplied with setting standards (except 0-25mm/0-1")
- Optional accessory: ball tips (code 7391), data output cable (code 7315-31 need receiver page 4, 7302-31 page 12)

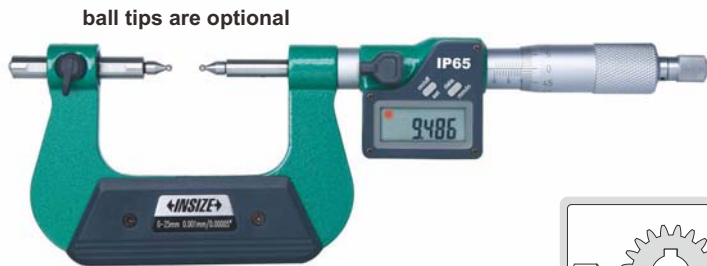

3591-25A

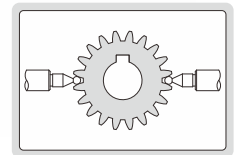

Code	Range	Accuracy	L	b
3591-25A	0-25mm/0-1"	±4μm	67	38
3591-50A	25-50mm/1-2"	±4μm	92.4	50
3591-75A	50-75mm/2-3"	±5μm	117.6	62
3591-100A	75-100mm/3-4"	±5μm	143	70
3591-125A	100-125mm/4-5"	±6μm	168.2	82
3591-150A	125-150mm/5-6"	±6μm	192	94.5
3591-175A	150-175mm/6-7"	±7μm	217	107

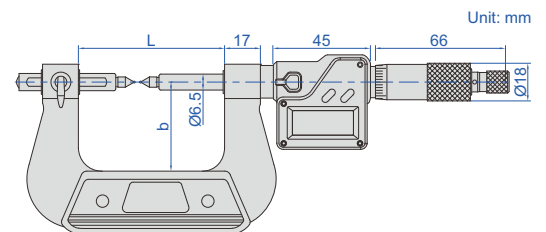

**BALL TIPS DIAMETER SØD CAN BE CUSTOMIZED WITH SIZES BETWEEN 1.50-6.00MM**

## BALL TIPS FOR GEAR TOOTH MICROMETERS

- Supplied in pair
- Suitable for 3291, 3591 series micrometers

Code	Ball dia. (D)
7391-T2	SØ1.5mm
7391-T3	SØ2.0mm
7391-T4	SØ2.5mm
7391-T5	SØ3.0mm

Code	Ball dia. (D)
7391-T6	SØ3.5mm
7391-T7	SØ4.0mm
7391-T8	SØ4.5mm
7391-T9	SØ5.0mm
7391-T10	SØ6.0mm



7391-T5



## POINT MICROMETERS

**INSIZE PLUS**  
MADE IN EUROPE

ATTENTION: SETTING STANDARDS ARE NOT INCLUDED

INSPECTION CERTIFICATE

Code	Range	Accuracy	L	b
3659-25A*	0-25mm	4µm	62	34
3659-50A*	25-50mm	4µm	87	46
3659-75A*	50-75mm	5µm	112	60
3659-100A*	75-100mm	5µm	139	72
3659-125A*	100-125mm	6µm	164	85
3659-150A*	125-150mm	6µm	190	97
3659-175A*	150-175mm	7µm	215	110
3659-200A*	175-200mm	7µm	240	122
3659-225A*	200-225mm	8µm	264	135
3659-250A*	225-250mm	8µm	290	148

\*Supplied with manufacturer inspection certificate



3659-25A

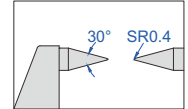
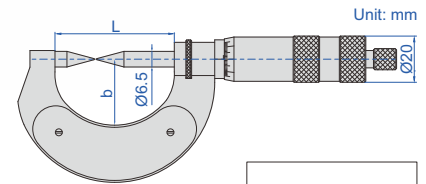

- Measure the web thickness of drills, small grooves and keyways
- Graduation: 0.01mm
- Ratchet stop
- Carbide tips
- Optional accessory: setting standards (code 7386)

## POINT MICROMETERS

- Measure the web thickness of drills, small grooves and keyways
- Graduation 0.01mm
- Ratchet stop
- Carbide tips
- Supplied with setting standards (except 0-25mm)

Code	Range	Type	Accuracy	L	b
3230-25A	0-25mm	A	4µm	57	32
3230-50A	25-50mm	A	4µm	82	44.5
3230-75A	50-75mm	A	5µm	107	57
3230-100A	75-100mm	A	5µm	132.6	69.5
3230-25BA	0-25mm	B	4µm	57	32
3230-50BA	25-50mm	B	4µm	82	44.5
3230-75BA	50-75mm	B	5µm	107	57
3230-100BA	75-100mm	B	5µm	132.6	69.5



3230-25A

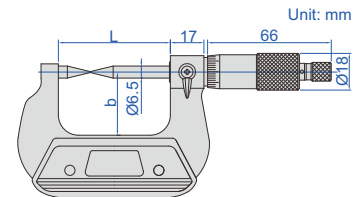

## DIGITAL POINT MICROMETERS

- Measure the web thickness of drills, small grooves and keyways
- Resolution 0.001mm/0.00005"
- IP65 dust/waterproof
- Button function: on/off, set, mm/inch, data transmit
- Data output
- Automatic power off
- Ratchet stop
- Carbide tips
- Supplied with setting standards (except 0-25mm/0-1")
- Optional accessory: data output cable (code 7315-31 need receiver page 4, 7302-31 page 12)

DATA OUTPUT

IP65 WATERPROOF



3530-25A

Code	Range	Type	Accuracy	L	b
3530-25A	0-25mm/0-1"	A	±4µm	57	32
3530-50A	25-50mm/1-2"	A	±4µm	82	44.5
3530-75A	50-75mm/2-3"	A	±5µm	107	57
3530-100A	75-100mm/3-4"	A	±5µm	132.6	69.5
3530-25BA	0-25mm/0-1"	B	±4µm	57	32
3530-50BA	25-50mm/1-2"	B	±4µm	82	44.5
3530-75BA	50-75mm/2-3"	B	±5µm	107	57
3530-100BA	75-100mm/3-4"	B	±5µm	132.6	69.5

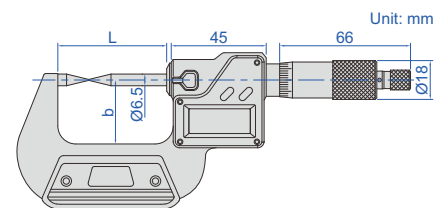
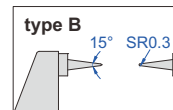
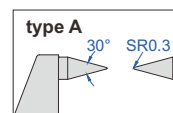

## HIGH PRECISION DIGITAL POINT MICROMETERS/SNAP GAGES

ONE TURN OF SLEEVE MAKES 5MM SPINDLE FEED, PRESS THE FORK, THE SPINDLE RETRACTS 3MM

ABSOLUTE ENCODER, THE ORIGINAL DATA REMAINS AFTER POWER OFF

MEASUREMENT ACCURACY IS NOT AFFECTED BY THE USE OF SLEEVE

NON-ROTATING SPINDLE

DATA OUTPUT

ATTENTION: RECHARGEABLE BATTERY, FOR 24 HOURS CONTINUOUS WORKING

IP65 WATERPROOF

INSPECTION CERTIFICATE



VIDEO



3354-25

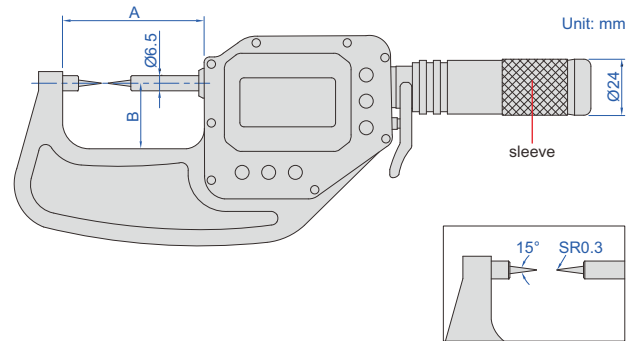

Unit: mm

sleeve

15° SR0.3

- Measure the web thickness of drills, small grooves and keyways
- Absolute encoder, the original data remains after power off
- Adjustable resolution: 0.0002mm/0.00001"  
0.001mm/0.00005"  
0.01mm/0.0005"
- One turn of sleeve makes 5mm spindle feed
- Measurement accuracy is not affected by the use of sleeve
- Press the fork, the spindle retracts 3mm
- Linear ball bearings for ten million times use
- Carbide spindle and anvil
- Measuring force 7-10N  
Customizable measuring force range 2-12N  
Attention: small measuring force will reduce the dustproof and waterproof level
- Button function: data output, tolerance, data preset, data hold, measuring direction change, max./min./TIR, power off time, on/off, zero, mm/inch, adjust resolution
- Supplied with gage blocks for zero setting (except 0-25mm/0-1")
- Power: rechargeable battery, for 24 hours continuous working

alarm when over tolerance

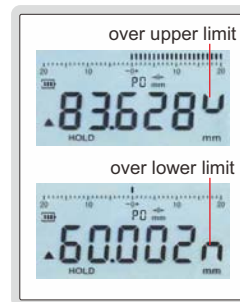

wireless receiver 2134-R1, 2134-R2 (optional)



### With data interface

Optional accessory:

wireless transmitter, code 7315-3350 need receiver page 6

data output cable (keyboard format), code 7302-3350 page 13

Code	Range	Accuracy	Repeatability	A	B
3354-25 *	0-25mm/0-1"	2µm	1µm	63mm	25mm
3354-50 *	25-50mm/1-2"	2µm	1µm	88mm	42mm
3354-75 *	50-75mm/2-3"	2µm	1µm	113mm	56mm

### Built-in wireless

Optional accessory:

wireless receiver (keyboard format, connect up to 15 digital indicators), code 2134-R1

wireless receiver (serial port format, connect up to 15 digital indicators), code 2134-R2

Code	Range	Accuracy	Repeatability	A	B
3354-25WL *	0-25mm/0-1"	2µm	1µm	63mm	25mm
3354-50WL *	25-50mm/1-2"	2µm	1µm	88mm	42mm
3354-75WL *	50-75mm/2-3"	2µm	1µm	113mm	56mm

\* Supplied with manufacturer inspection certificate

## GEAR ROOT DIAMETER MICROMETERS

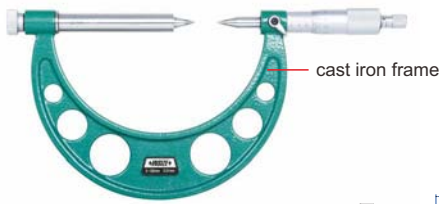

3297-100

- Measure diameter of gear root circle
- Graduation 0.01mm
- Ratchet stop
- Meet DIN863-3
- Carbide measuring faces
- Supplied with setting standards

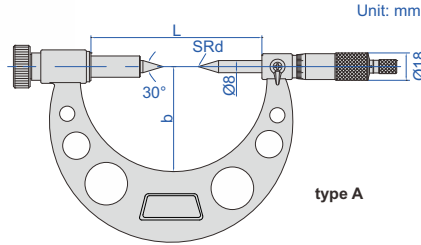

type A

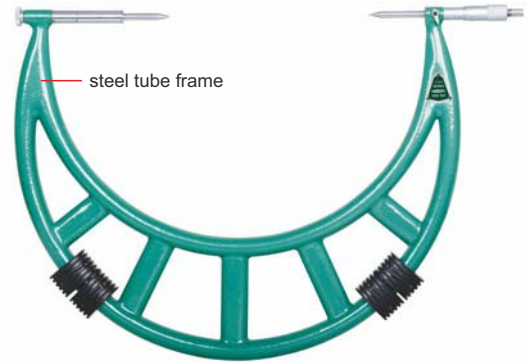

steel tube frame

3297-300

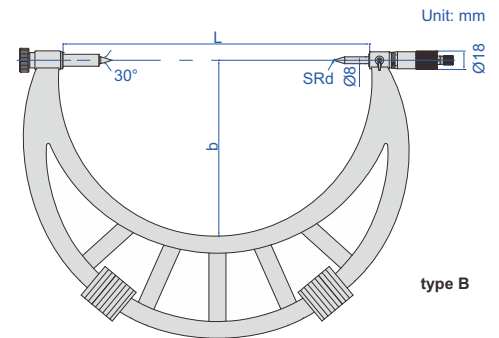

type B

Code	Range	Type	Accuracy	L	b	SRd
3297-100	5-100mm	A	5μm	137	72	0.4
3297-200	100-200mm	A	7μm	237	129	0.5
3297-300	200-300mm	B	9μm	414	225	0.7
3297-400	300-400mm	B	11μm	514	275	0.7
3297-500	400-500mm	B	13μm	614	325	0.7
3297-600	500-600mm	B	15μm	714	375	0.7
3297-700	600-700mm	B	16μm	814	425	0.7
3297-800	700-800mm	B	18μm	914	475	0.7
3297-900	800-900mm	B	20μm	1014	525	0.7

## DIGITAL GEAR ROOT DIAMETER MICROMETERS

IP65  
WATERPROOF

DATA  
OUTPUT

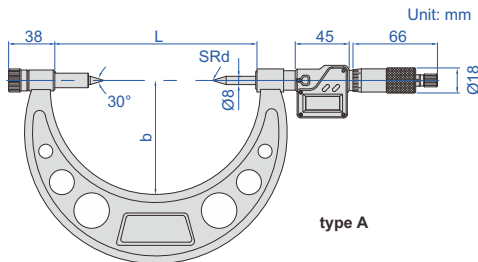

type A

- Measure diameter of gear root circle
- Resolution 0.001mm/0.0001" (resolution of 3597-100 and 3597-200 is 0.001mm/0.00005")
- IP65 dust/waterproof
- Button function: on/off, set, mm/inch, data transmit
- Data output
- Automatic power off
- Ratchet stop
- Carbide measuring faces
- Supplied with setting standards
- Optional accessory: data output cable (code 7315-31 need receiver page 4, 7302-31 page 12)

Code	Range	Type	Accuracy	L	b	SRd
3597-100	5-100mm	A	3μm	137	72	0.4
3597-200	100-200mm	A	4μm	237	129	0.5
3597-300	200-300mm	B	5μm	414	225	0.7
3597-400	300-400mm	B	6μm	514	275	0.7
3597-500	400-500mm	B	7μm	614	325	0.7
3597-600	500-600mm	B	8μm	714	375	0.7
3597-700	600-700mm	B	8μm	814	425	0.7
3597-800	700-800mm	B	9μm	914	475	0.7
3597-900	800-900mm	B	10μm	1014	525	0.7



cast iron frame

3597-100



steel tube frame

3597-300

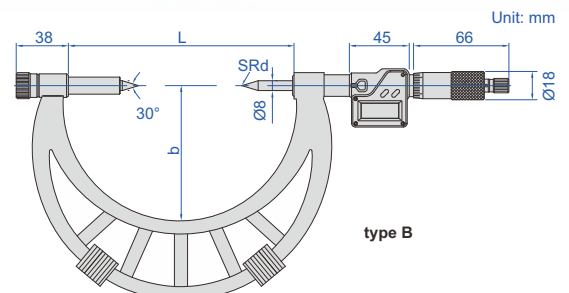

type B





3650-25A

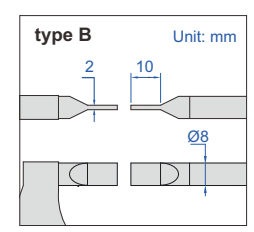
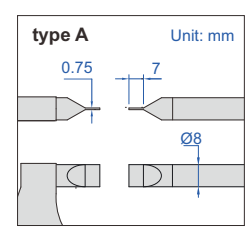
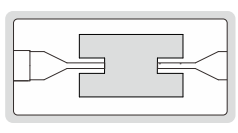
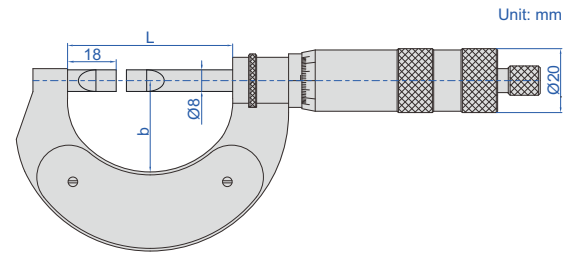

- Meet DIN863-3
- Graduation 0.01mm
- Force: 5-10N
- Optional accessory: setting standards (code 7386)

(mm)

Code	Range	Type	Accuracy	L	b
3650-25A*	0-25mm	A	4µm	62	34
3650-50A*	25-50mm	A	4µm	87	46
3650-75A*	50-75mm	B	5µm	112	60
3650-100A*	75-100mm	B	5µm	139	72
3650-125A*	100-125mm	B	6µm	164	85
3650-150A*	125-150mm	B	6µm	190	97
3650-175A*	150-175mm	B	7µm	215	110
3650-200A*	175-200mm	B	7µm	240	122
3650-225A*	200-225mm	B	8µm	264	135
3650-250A*	225-250mm	B	8µm	290	148
3650-275A*	250-275mm	B	9µm	315	160
3650-300A*	275-300mm	B	9µm	340	174

\* Supplied with manufacturer inspection certificate

## BLADE MICROMETERS

NON-ROTATING SPINDLE

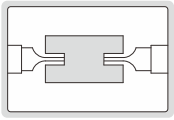

- Meet DIN863-3
- Measure the groove diameter of shafts and keyways
- Graduation 0.01mm
- Non-rotating spindle
- Ratchet stop
- Supplied with setting standards (except 0-25mm)



3232-25A

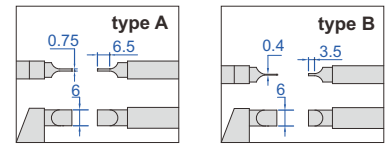
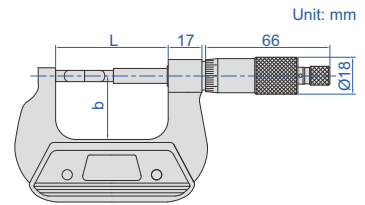

6

Type A (mm)

Code	Range	Accuracy	L	b
3232-25A	0-25mm	4µm	57	32
3232-50A	25-50mm	4µm	82	44.5
3232-75A	50-75mm	5µm	107	57
3232-100A	75-100mm	5µm	132.6	69.5
3232-125A	100-125mm	6µm	158	82
3232-150A	125-150mm	6µm	183.4	94.5
3232-175A	150-175mm	7µm	208.8	107
3232-200A	175-200mm	7µm	234.2	129.6
3232-225A	200-225mm	8µm	259.6	142.3
3232-250A	225-250mm	8µm	285	155
3232-275A	250-275mm	9µm	310.4	167.7
3232-300A	275-300mm	9µm	336.5	177.8

Type B (mm)

Code	Range	Accuracy	L	b
3232-25BA	0-25mm	4µm	57	32
3232-50BA	25-50mm	4µm	82	44.5
3232-75BA	50-75mm	5µm	107	57
3232-100BA	75-100mm	5µm	132.6	69.5
3232-125BA	100-125mm	6µm	158	82
3232-150BA	125-150mm	6µm	183.4	94.5
3232-175BA	150-175mm	7µm	208.8	107
3232-200BA	175-200mm	7µm	234.2	129.6
3232-225BA	200-225mm	8µm	259.6	142.3
3232-250BA	225-250mm	8µm	285	155
3232-275BA	250-275mm	9µm	310.4	167.7
3232-300BA	275-300mm	9µm	336.5	177.8

## DIGITAL BLADE MICROMETERS

DATA OUTPUT

NON-ROTATING SPINDLE

- Measure the groove diameter of shafts and keyways
- Resolution 0.001mm/0.00005"
- Non-rotating spindle
- Button function: on/off, set, mm/inch, data transmit
- Data output
- Automatic power off
- Ratchet stop
- Supplied with setting standards (except 0-25mm/0-1")
- Optional accessory: data output cable (code 7315-31 need receiver page 4, 7302-31 page 12)



3532-25A

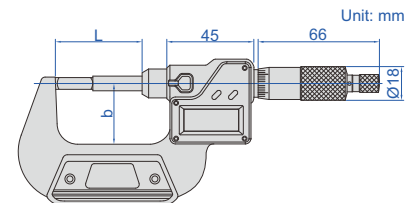

(mm)

Code	Range	Type	Accuracy	L	b
3532-25A	0-25mm/0-1"	A	±4µm	57	32
3532-50A	25-50mm/1-2"	A	±4µm	82	44.5
3532-75A	50-75mm/2-3"	A	±5µm	107	57
3532-100A	75-100mm/3-4"	A	±5µm	132.6	69.5
3532-125A	100-125mm/4-5"	A	±6µm	158	82
3532-150A	125-150mm/5-6"	A	±6µm	183.4	94.5
3532-175A	150-175mm/6-7"	A	±7µm	208.8	107
3532-25BA	0-25mm/0-1"	B	±4µm	57	32
3532-50BA	25-50mm/1-2"	B	±4µm	82	44.5
3532-75BA	50-75mm/2-3"	B	±5µm	107	57
3532-100BA	75-100mm/3-4"	B	±5µm	132.6	69.5
3532-125BA	100-125mm/4-5"	B	±6µm	158	82
3532-150BA	125-150mm/5-6"	B	±6µm	183.4	94.5
3532-175BA	150-175mm/6-7"	B	±7µm	208.8	107

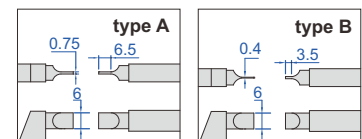
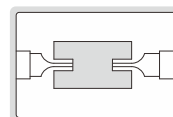

**ATTENTION: RECHARGEABLE BATTERY, FOR 24 HOURS CONTINUOUS WORKING**

## HIGH PRECISION DIGITAL BLADE MICROMETERS/SNAP GAGES

MEASUREMENT ACCURACY IS NOT AFFECTED BY THE USE OF SLEEVE

**IP65**  
WATERPROOF

DATA  
OUTPUT

ABSOLUTE ENCODER, THE ORIGINAL DATA REMAINS AFTER POWER OFF

NON-ROTATING  
SPINDLE

ONE TURN OF SLEEVE MAKES 5MM SPINDLE FEED, PRESS THE FORK, THE SPINDLE RETRACTS 3MM



**INSPECTION  
CERTIFICATE**



3352-25A

- Measure the groove diameter of shafts and keyways
- Absolute encoder, the original data remains after power off
- Adjustable resolution: 0.0002mm/0.00001"  
0.001mm/0.00005"  
0.01mm/0.0005"
- One turn of sleeve makes 5mm spindle feed
- Measurement accuracy is not affected by the use of sleeve
- Press the fork, the spindle retracts 3mm
- Linear ball bearings for ten million times use
- Carbide spindle and anvil
- Measuring force 7-10N  
Customizable measuring force range 2-12N  
Attention: small measuring force will reduce the dustproof and waterproof level
- Button function: data output, tolerance, data preset, data hold, measuring direction change, max./min./TIR, power off time, on/off, zero, mm/inch, adjust resolution
- Supplied with gage blocks for zero setting (except 0-25mm/0-1")
- Power: rechargeable battery, for 24 hours continuous working

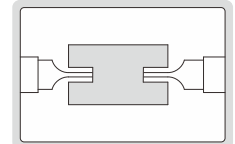
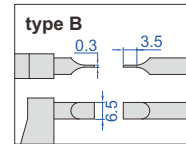
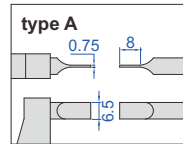
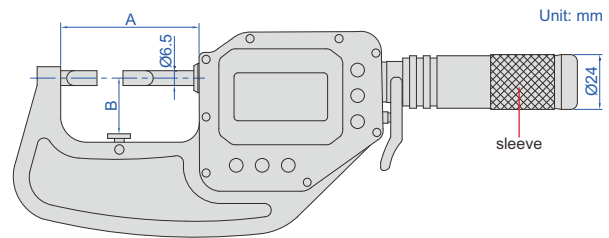

### With data interface

Optional accessory:  
wireless transmitter, code **7315-3350** need receiver page 6  
data output cable (keyboard format), code **7302-3350** page 13

Code	Range	Type	Accuracy	Repeatability	A	B
3352-25A*	0-25mm/0-1"	A	2µm	1µm	63mm	25mm
3352-50A*	25-50mm/1-2"	A	2µm	1µm	88mm	42mm
3352-75A*	50-75mm/2-3"	A	2µm	1µm	113mm	56mm
3352-25B*	0-25mm/0-1"	B	2µm	1µm	63mm	25mm
3352-50B*	25-50mm/1-2"	B	2µm	1µm	88mm	42mm
3352-75B*	50-75mm/2-3"	B	2µm	1µm	113mm	56mm

### Built-in wireless

Optional accessory:  
wireless receiver (keyboard format, connect up to 15 digital indicators), code **2134-R1**  
wireless receiver (serial port format, connect up to 15 digital indicators), code **2134-R2**

Code	Range	Type	Accuracy	Repeatability	A	B
3352-25AWL*	0-25mm/0-1"	A	2µm	1µm	63mm	25mm
3352-50AWL*	25-50mm/1-2"	A	2µm	1µm	88mm	42mm
3352-75AWL*	50-75mm/2-3"	A	2µm	1µm	113mm	56mm
3352-25BWL*	0-25mm/0-1"	B	2µm	1µm	63mm	25mm
3352-50BWL*	25-50mm/1-2"	B	2µm	1µm	88mm	42mm
3352-75BWL*	50-75mm/2-3"	B	2µm	1µm	113mm	56mm

alarm when  
over tolerance

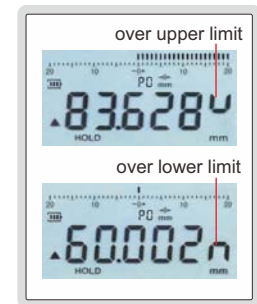

wireless receiver  
2134-R1, 2134-R2 (optional)



\* Supplied with manufacturer inspection certificate

## CRIMP HEIGHT MICROMETERS

- Measure the height of crimp contact
- Graduation 0.01mm
- Ratchet stop
- Supplied with setting standards (except 0-25mm)

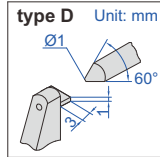
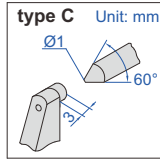
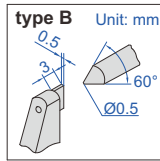

RELATIVE PRODUCT: DIGITAL CRIMP HEIGHT CALIPER (CODE 1165-150A)



3266-25BA

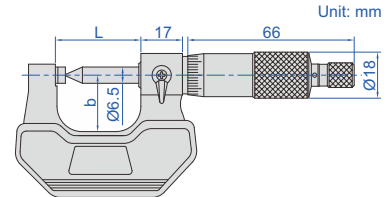

Code	Range	Type	Accuracy	L	b
3266-25BA	0-25mm	B	4µm	34	24
3266-25CA	0-25mm	C	4µm	34	24
3266-50CA	25-50mm	C	4µm	59	32
3266-75CA	50-75mm	C	5µm	85	45
3266-100CA	75-100mm	C	5µm	110	57
3266-25DA	0-25mm	D	4µm	34	24

6

## DIGITAL CRIMP HEIGHT MICROMETERS

RELATIVE PRODUCT: DIGITAL CRIMP HEIGHT CALIPER (CODE 1165-150A)

DATA OUTPUT IP65 WATERPROOF

- Measure the height of crimp contact
- Resolution 0.001mm/0.00005"
- IP65 dust/waterproof
- Button function: on/off, set, mm/inch, data transmit
- Data output
- Automatic power off
- Ratchet stop
- Supplied with setting standards (except 0-25mm/0-1")
- Optional accessory: data output cable (code 7315-31 need receiver page 4, 7302-31 page 12)



3566-25BA

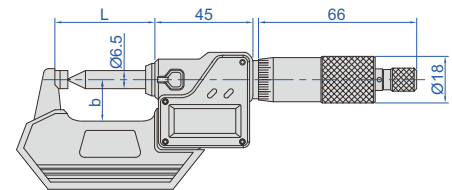

Code	Range	Type	Accuracy	L	b
3566-25BA	0-25mm/0-1"	B	±4µm	34.5	25
3566-25CA	0-25mm/0-1"	C	±4µm	34.5	25
3566-50CA	25-50mm/0-1"	C	±4µm	59.5	32
3566-75CA	50-75mm/0-1"	C	±5µm	84.5	44.5
3566-100CA	75-100mm/0-1"	C	±5µm	109.5	57
3566-25DA	0-25mm/0-1"	D	±4µm	34.5	25

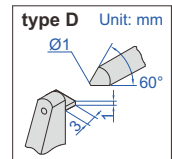
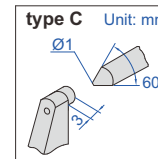
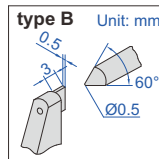

## SPLINE MICROMETERS

INSIZE PLUS MADE IN EUROPE

INSPECTION CERTIFICATE

Code	Range	Accuracy	L	b
3658-25 *	0-25mm	4µm	62	34
3658-50 *	25-50mm	4µm	87	46
3658-75 *	50-75mm	5µm	112	60
3658-100 *	75-100mm	5µm	139	72
3658-125 *	100-125mm	6µm	164	85
3658-150 *	125-150mm	6µm	190	97
3658-175 *	150-175mm	7µm	215	110
3658-200 *	175-200mm	7µm	240	122
3658-225 *	200-225mm	8µm	264	135
3658-250 *	225-250mm	8µm	290	148

\* Supplied with manufacturer inspection certificate



3658-25

ATTENTION: SETTING STANDARDS ARE NOT INCLUDED

- Meet DIN863-3
- Measure splined shafts, slots and keyways
- Graduation 0.01mm
- Ratchet stop
- Carbide measuring faces
- Optional accessory: setting standards (code 7386)

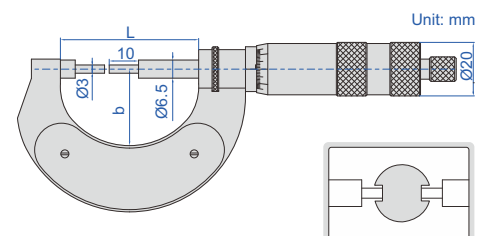

## SPLINE MICROMETERS

- Meet DIN863-3
- Measure splined shafts, slots and keyways
- Graduation 0.01mm
- Ratchet stop
- Carbide measuring faces
- Supplied with setting standards (except 0-25mm)

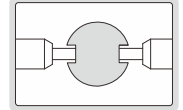

(mm)

3233-25BA

Code	Range	Type	Accuracy	L	b
3233-25A	0-25mm	A	4μm	57	32
3233-50A	25-50mm	A	4μm	82	44.5
3233-75A	50-75mm	A	5μm	107	57
3233-100A	75-100mm	A	5μm	132.6	69.5
3233-125A	100-125mm	A	6μm	158	82
3233-150A	125-150mm	A	6μm	183.4	94.5
3233-175A	150-175mm	A	7μm	208.8	107
3233-25BA	0-25mm	B	4μm	57	32
3233-50BA	25-50mm	B	4μm	82	44.5
3233-75BA	50-75mm	B	5μm	107	57
3233-100BA	75-100mm	B	5μm	132.6	69.5
3233-125BA	100-125mm	B	6μm	158	82
3233-150BA	125-150mm	B	6μm	183.4	94.5
3233-175BA	150-175mm	B	7μm	208.8	107

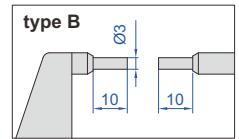
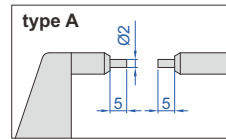
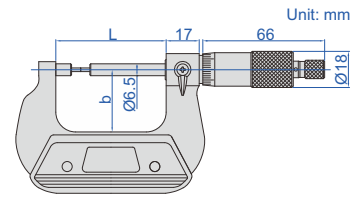

6

**IP65**  
WATERPROOF

**DATA**  
OUTPUT

## DIGITAL SPLINE MICROMETERS

- Measure splined shafts, slots and keyways
- Resolution 0.001mm/0.00005"
- IP65 dust/waterproof
- Button function: on/off, set, mm/inch, data transmit
- Data output
- Automatic power off
- Ratchet stop
- Carbide measuring faces
- Supplied with setting standards (except 0-25mm/0-1")
- Optional accessory: data output cable (code 7315-31 need receiver page 4, 7302-31 page 12)

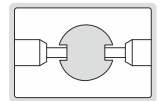

(mm)

3533-25BA

Code	Range	Type	Accuracy	L	b
3533-25A	0-25mm/0-1"	A	±4μm	57	32
3533-50A	25-50mm/1-2"	A	±4μm	82	44.5
3533-75A	50-75mm/2-3"	A	±5μm	107	57
3533-100A	75-100mm/3-4"	A	±5μm	132.6	69.5
3533-125A	100-125mm/4-5"	A	±6μm	158	82
3533-150A	125-150mm/5-6"	A	±6μm	183.4	94.5
3533-175A	150-175mm/6-7"	A	±7μm	208.8	107
3533-25BA	0-25mm/0-1"	B	±4μm	57	32
3533-50BA	25-50mm/1-2"	B	±4μm	82	44.5
3533-75BA	50-75mm/2-3"	B	±5μm	107	57
3533-100BA	75-100mm/3-4"	B	±5μm	132.6	69.5
3533-125BA	100-125mm/4-5"	B	±6μm	158	82
3533-150BA	125-150mm/5-6"	B	±6μm	183.4	94.5
3533-175BA	150-175mm/6-7"	B	±7μm	208.8	107

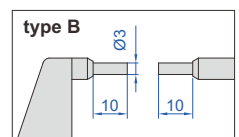
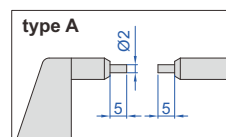
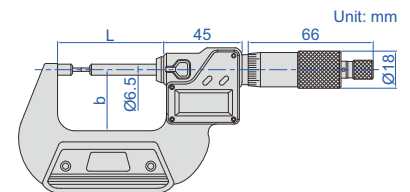

## HIGH PRECISION DIGITAL SPLINE MICROMETERS/SNAP GAGES

ONE TURN OF SLEEVE MAKES 5MM SPINDLE FEED, PRESS THE FORK, THE SPINDLE RETRACTS 3MM

MEASUREMENT ACCURACY IS NOT AFFECTED BY THE USE OF SLEEVE

NON-ROTATING SPINDLE

ABSOLUTE ENCODER, THE ORIGINAL DATA REMAINS AFTER POWER OFF

IP65 WATERPROOF

ATTENTION: RECHARGEABLE BATTERY, FOR 24 HOURS CONTINUOUS WORKING

DATA OUTPUT

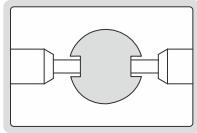

3356-25

- Measure splined shafts, slots and keyways
- Absolute encoder, the original data remains after power off
- Adjustable resolution: 0.0002mm/0.00001"
  - 0.001mm/0.00005"
  - 0.01mm/0.0005"
- One turn of sleeve makes 5mm spindle feed
- Measurement accuracy is not affected by the use of sleeve
- Press the fork, the spindle retracts 3mm
- Linear ball bearings for ten million times use
- Carbide spindle and anvil
- Measuring force 7-10N
  - Customizable measuring force range 2-12N
  - Attention: small measuring force will reduce the dustproof and waterproof level
- Button function: data output, tolerance, data preset, data hold, measuring direction change, max./min./TIR, power off time, on/off, zero, mm/inch, adjust resolution
- Supplied with gage blocks for zero setting (except 0-25mm/0-1")
- Power: rechargeable battery, for 24 hours continuous working

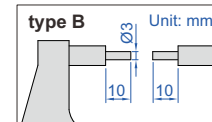
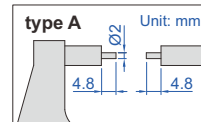
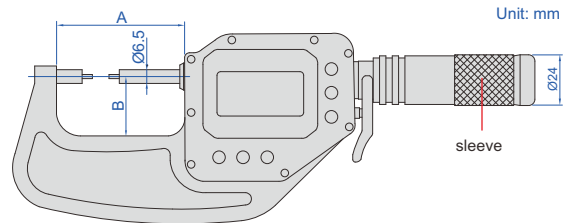

### With data interface

Optional accessory:  
 wireless transmitter, code **7315-3350** need receiver page 6  
 data output cable (keyboard format), code **7302-3350** page 13

Code	Range	Accuracy	Type	Repeatability	A	B
3356-25 *	0-25mm/0-1"	2µm	A	1µm	63mm	25mm
3356-50 *	25-50mm/1-2"	2µm	A	1µm	88mm	42mm
3356-75 *	50-75mm/2-3"	2µm	A	1µm	113mm	56mm
3356-25B *	0-25mm/0-1"	2µm	B	1µm	63mm	25mm
3356-50B *	25-50mm/1-2"	2µm	B	1µm	88mm	42mm
3356-75B *	50-75mm/2-3"	2µm	B	1µm	113mm	56mm

### Built-in wireless

Optional accessory:  
 wireless receiver (keyboard format, connect up to 15 digital indicators), code **2134-R1**  
 wireless receiver (serial port format, connect up to 15 digital indicators), code **2134-R2**

Code	Range	Accuracy	Type	Repeatability	A	B
3356-25WL *	0-25mm/0-1"	2µm	A	1µm	63mm	25mm
3356-50WL *	25-50mm/1-2"	2µm	A	1µm	88mm	42mm
3356-75WL *	50-75mm/2-3"	2µm	A	1µm	113mm	56mm
3356-25BWL *	0-25mm/0-1"	2µm	B	1µm	63mm	25mm
3356-50BWL *	25-50mm/1-2"	2µm	B	1µm	88mm	42mm
3356-75BWL *	50-75mm/2-3"	2µm	B	1µm	113mm	56mm

\* Supplied with manufacturer inspection certificate

alarm when over tolerance

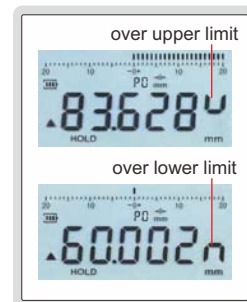

wireless receiver  
2134-R1, 2134-R2 (optional)



## CYLINDRICAL ANVIL TUBE MICROMETERS

- Measure wall thickness of tubes
- Graduation 0.01mm
- Ratchet stop
- Carbide spindle tip
- Supplied with setting standards (except 0-25mm)



3261-25A

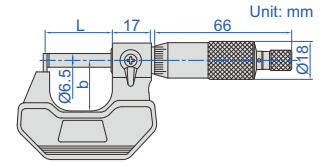
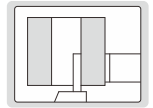

(mm)

Code	Range	Type	Accuracy	L	b
3261-25A	0-25mm	A	6µm	36	25
3261-50A	25-50mm	A	6µm	61	32
3261-25BA	0-25mm	B	6µm	36	25
3261-50BA	25-50mm	B	6µm	61	32
3261-25CA	0-25mm	C	6µm	36	25
3261-50CA	25-50mm	C	6µm	61	32
3261-25DA	0-25mm	D	6µm	36	25
3261-50DA	25-50mm	D	6µm	61	32
3261-25EA	0-25mm	E	6µm	36	25
3261-50EA	25-50mm	E	6µm	61	32
3261-25FA	0-25mm	F	6µm	36	25
3261-50FA	25-50mm	F	6µm	61	32

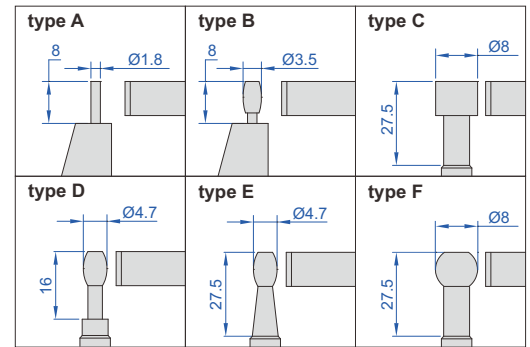

**IP65**  
WATERPROOF

**DATA**  
OUTPUT

## DIGITAL CYLINDRICAL ANVIL TUBE MICROMETERS

- Measure wall thickness of tubes
- Resolution 0.001mm/0.00005"
- IP65 dust/waterproof
- Button function: on/off, set, mm/inch, data transmit
- Data output
- Automatic power off
- Ratchet stop
- Carbide spindle tip
- Supplied with setting standards (except 0-25mm/0-1")
- Optional accessory: data output cable (code 7315-31 need receiver page 4, 7302-31 page 12)



3561-25A

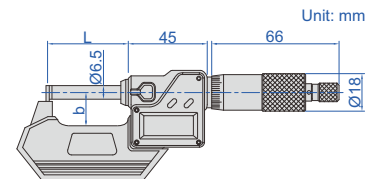
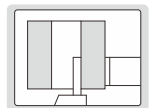

(mm)

Code	Range	Type	Accuracy	L	b
3561-25A	0-25mm/0-1"	A	±6µm	36	25
3561-50A	25-50mm/1-2"	A	±6µm	61	32
3561-25BA	0-25mm/0-1"	B	±6µm	36	25
3561-50BA	25-50mm/1-2"	B	±6µm	61	32
3561-25CA	0-25mm/0-1"	C	±6µm	36	25
3561-50CA	25-50mm/1-2"	C	±6µm	61	32
3561-25DA	0-25mm/0-1"	D	±6µm	36	25
3561-50DA	25-50mm/1-2"	D	±6µm	61	32
3561-25EA	0-25mm/0-1"	E	±6µm	36	25
3561-50EA	25-50mm/1-2"	E	±6µm	61	32
3561-25FA	0-25mm/0-1"	F	±6µm	36	25
3561-50FA	25-50mm/1-2"	F	±6µm	61	32

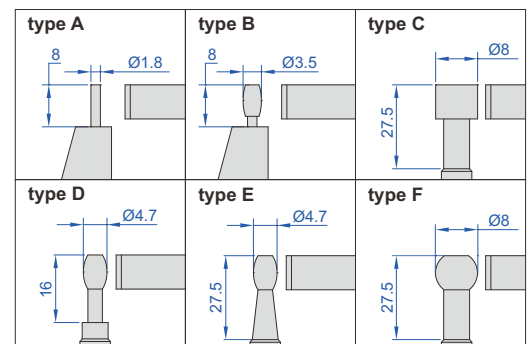

## SPHERICAL ANVIL TUBE MICROMETERS

- Meet DIN863-3
- Measure wall thickness of tubes
- Graduation 0.01mm
- Ratchet stop
- Carbide measuring faces
- Supplied with setting standards (except 0-25mm)



3260-25A

Code	Range	Type	Accuracy	L	b
3260-25A	0-25mm	A	4μm	32	24
3260-50A	25-50mm	A	4μm	57	32
3260-75A	50-75mm	A	5μm	82	44.5
3260-100A	75-100mm	A	5μm	107	57
3260-25SA	0-25mm	B	4μm	32	24
3260-50SA	25-50mm	B	4μm	57	32
3260-75SA	50-75mm	B	5μm	82	44.5
3260-100SA	75-100mm	B	5μm	107	57

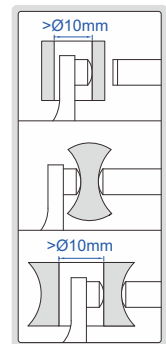
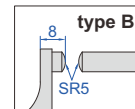
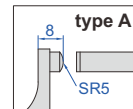
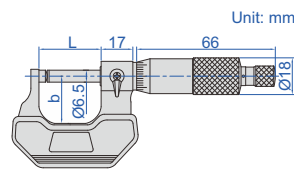

6

## DIGITAL SPHERICAL ANVIL TUBE MICROMETERS

**IP65**  
WATERPROOF

**DATA**  
OUTPUT

- Measure wall thickness of tubes
- Resolution 0.001mm/0.00005"
- IP65 dust/waterproof
- Button function: on/off, set, mm/inch, data transmit
- Data output
- Automatic power off
- Ratchet stop
- Carbide measuring faces
- Supplied with setting standards (except 0-25mm/0-1")
- Optional accessory: data output cable (code 7315-31 need receiver page 4, 7302-31 page 12)

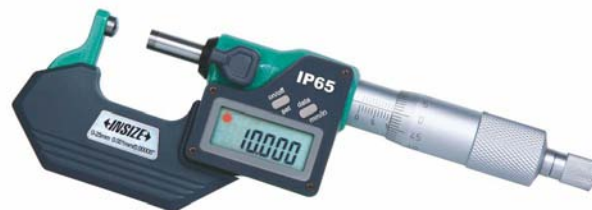

3560-25A

Code	Range	Type	Accuracy	L	b
3560-25A	0-25mm/0-1"	A	±4μm	32	24
3560-50A	25-50mm/1-2"	A	±4μm	57	32
3560-75A	50-75mm/2-3"	A	±5μm	82	44.5
3560-100A	75-100mm/3-4"	A	±5μm	107	57
3560-25SA	0-25mm/0-1"	B	±4μm	32	24
3560-50SA	25-50mm/1-2"	B	±4μm	57	32
3560-75SA	50-75mm/2-3"	B	±5μm	82	44.5
3560-100SA	75-100mm/3-4"	B	±5μm	107	57

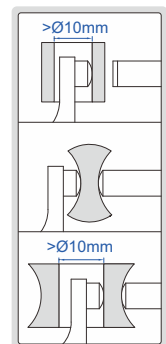
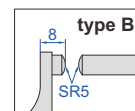
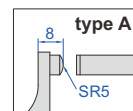
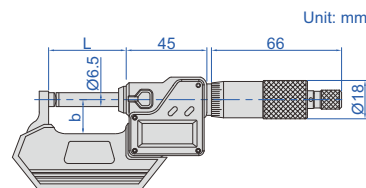



# HIGH PRECISION DIGITAL SPHERICAL ANVIL TUBE MICROMETERS/SNAP GAGES

**IP65**  
WATERPROOF

**NON-ROTATING**  
SPINDLE

**ABSOLUTE ENCODER, THE ORIGINAL**  
DATA REMAINS AFTER POWER OFF

**ONE TURN OF SLEEVE MAKES 5MM SPINDLE FEED,**  
PRESS THE FORK, THE SPINDLE RETRACTS 3MM

**MEASUREMENT ACCURACY IS NOT**  
AFFECTED BY THE USE OF SLEEVE

**INSPECTION**  
**CERTIFICATE**

**ATTENTION: RECHARGEABLE BATTERY,**  
FOR 24 HOURS CONTINUOUS WORKING

**DATA**  
**OUTPUT**

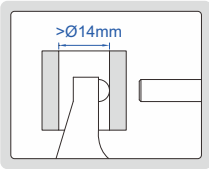

**3355-25**

- Measure wall thickness of tubes
- Absolute encoder, the original data remains after power off
- Adjustable resolution: 0.0002mm/0.00001"  
0.001mm/0.00005"  
0.01mm/0.0005"
- One turn of sleeve makes 5mm spindle feed
- Measurement accuracy is not affected by the use of sleeve
- Press the fork, the spindle retracts 3mm
- Linear ball bearings for ten million times use
- Carbide spindle and anvil
- Measuring force 7-10N  
Customizable measuring force range 2-12N  
Attention: small measuring force will reduce the dustproof and waterproof level
- Button function: data output, tolerance, data preset, data hold, measuring direction change, max./min./TIR, power off time, on/off, zero, mm/inch, adjust resolution
- Supplied with gage blocks for zero setting (except 0-25mm/0-1")
- Power: rechargeable battery, for 24 hours continuous working

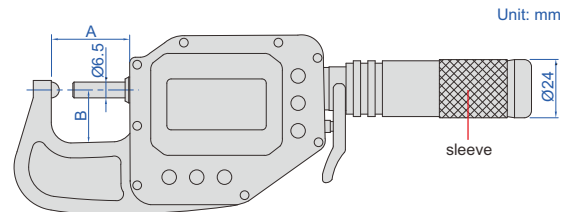

Unit: mm

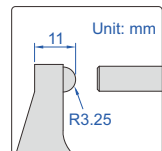

Unit: mm

**With data interface**

Optional accessory:  
wireless transmitter, code **7315-3350** need receiver page 6  
data output cable (keyboard format), code **7302-3350** page 13

Code	Range	Accuracy	Repeatability	A	B
<b>3355-25 *</b>	0-25mm/0-1"	2µm	1µm	38mm	24mm
<b>3355-50 *</b>	25-50mm/1-2"	2µm	1µm	63mm	25mm
<b>3355-75 *</b>	50-75mm/2-3"	2µm	1µm	88mm	42mm
<b>3355-100 *</b>	75-100mm/3-3.95"	2µm	1µm	113mm	56mm

**Built-in wireless**

Optional accessory:  
wireless receiver (keyboard format, connect up to 15 digital indicators), code **2134-R1**  
wireless receiver (serial port format, connect up to 15 digital indicators), code **2134-R2**

Code	Range	Accuracy	Repeatability	A	B
<b>3355-25WL *</b>	0-25mm/0-1"	2µm	1µm	38mm	24mm
<b>3355-50WL *</b>	25-50mm/1-2"	2µm	1µm	63mm	25mm
<b>3355-75WL *</b>	50-75mm/2-3"	2µm	1µm	88mm	42mm
<b>3355-100WL *</b>	75-100mm/3-3.95"	2µm	1µm	113mm	56mm

\* Supplied with manufacturer inspection certificate

alarm when  
over tolerance

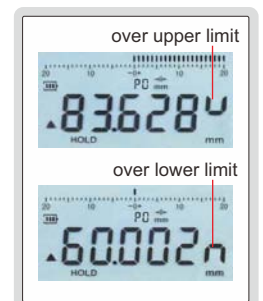

wireless receiver  
**2134-R1, 2134-R2 (optional)**



## DISK BRAKE MICROMETERS

RELATIVE PRODUCT: DIGITAL DISK BRAKE AND PAD CALIPER  
DIGITAL DRUM BRAKE CALIPER (CODE 1162-125A, 1167-150A, 1168-300A)

- Measure thickness of disk brakes
- Graduation 0.01mm
- Ratchet stop
- Carbide measuring faces
- Supplied with setting standards

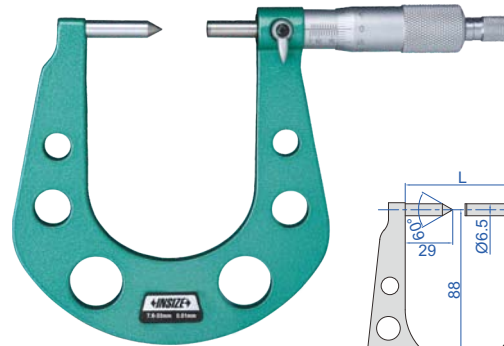

3288-33A

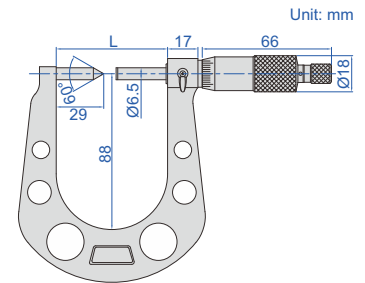

Code	Range	Accuracy	L
3288-33A	7.6-33mm	5µm	64.5mm
3288-50A	25-50mm	5µm	82mm

6

## DIGITAL DISK BRAKE MICROMETERS

RELATIVE PRODUCT: DIGITAL DISK BRAKE AND PAD CALIPER  
DIGITAL DRUM BRAKE CALIPER (CODE 1162-125A, 1167-150A, 1168-300A)

- Measure thickness of disk brakes
- Resolution 0.001mm/0.00005"
- IP65 dust/waterproof
- Button function: on/off, set, mm/inch, data transmit
- Data output
- Automatic power off
- Ratchet stop
- Carbide measuring faces
- Supplied with setting standards
- Optional accessory: data output cable (code 7315-31 need receiver page 4, 7302-31 page 12)



3588-33A

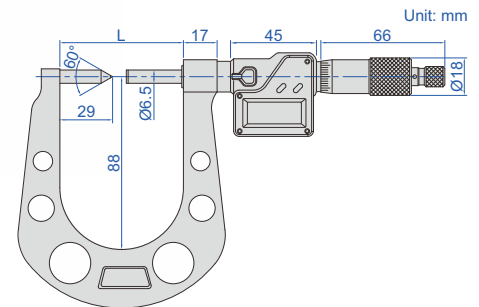

IP65  
WATERPROOF

DATA  
OUTPUT

Code	Range	Accuracy	L
3588-33A	7.6-33mm/0.3-1.3"	±5µm	64.5mm
3588-50A	25-50mm/1-2"	±5µm	82mm

## SHEET METAL MICROMETERS

**INSIZE PLUS**  
MADE IN EUROPE

- Deep frame suitable for sheet metal, paper and plastic
- Graduation 0.01mm
- Ratchet stop
- Carbide measuring faces
- Optional accessory: setting standards (code 7386)

ATTENTION: SETTING  
STANDARDS ARE NOT INCLUDED



3653-252A

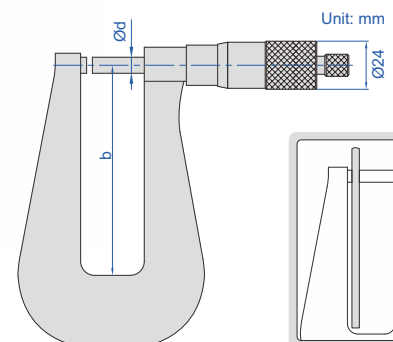

Code	Range	Accuracy	(mm)	
			b	Ød
3653-251A	0-25mm	4µm	50	6.5
3653-252A	0-25mm	5µm	100	8
3653-253A	0-25mm	6µm	150	6.5
3653-254A	0-25mm	8µm	250	6.5
3653-501A	25-50mm	4µm	50	8
3653-502A	0-50mm	4µm	50	8
3653-503A	0-50mm	5µm	100	8
3653-100A	50-100mm	5µm	100	8

## SHEET METAL MICROMETERS

- Deep frame suitable for sheet metal, paper and plastic
- Graduation 0.01mm
- Ratchet stop
- Carbide measuring faces

Code	Range	Type	Accuracy	b
3239-253	0-25mm	A	7µm	155mm
3239-253F	0-25mm	B	7µm	155mm
3239-254F	0-25mm	B	10µm	310mm
3239-253S	0-25mm	C	7µm	155mm



3239-253

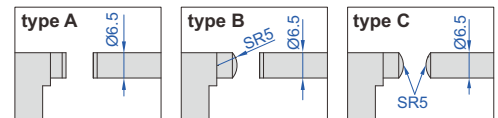
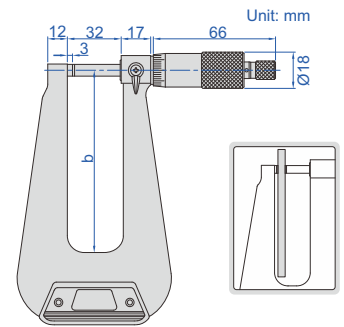

DATA  
OUTPUT

IP65  
WATERPROOF

## DIGITAL SHEET METAL MICROMETERS

- Deep frame suitable for sheet metal, paper and plastic
- Resolution 0.001mm/0.00005"
- IP65 dust/waterproof
- Button function: on/off, set, mm/inch, data transmit
- Data output
- Automatic power off
- Ratchet stop
- Carbide measuring faces
- Optional accessory: data output cable (code 7315-31 need receiver page 4, 7302-31 page 12)

Code	Range	Type	Accuracy	b
3539-253A	0-25mm/0-1"	A	±7µm	155mm
3539-253FA	0-25mm/0-1"	B	±7µm	155mm
3539-254FA	0-25mm/0-1"	B	±10µm	310mm
3539-253SA	0-25mm/0-1"	C	±7µm	155mm



3539-253A

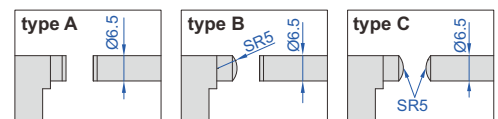
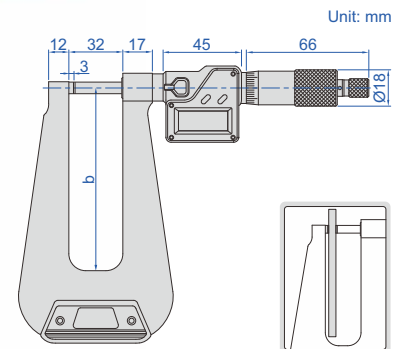

## INTERCHANGEABLE ANVIL MICROMETERS

- Measure tube thickness, shoulder edge distance, rivet head height, etc.
- Supplied with flat anvil and rod anvil
- Graduation 0.01mm
- Ratchet stop
- Carbide spindle tip
- Setting standards are included (except 0-25mm)



3262-25A

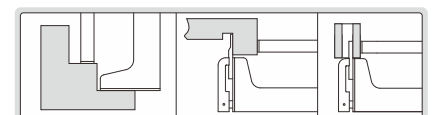
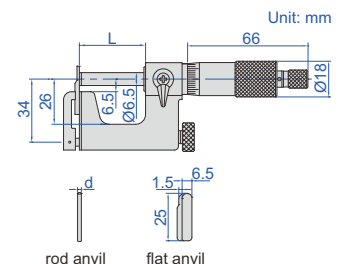

Code	Range	Accuracy	L	d
3262-25A	0-25mm	4µm	28.5mm	Ø3mm
3262-50A	25-50mm	4µm	53.5mm	Ø5mm

## DIGITAL INTERCHANGEABLE ANVIL MICROMETERS

**IP65**  
WATERPROOF

**DATA**  
OUTPUT

- Measure tube thickness, shoulder edge distance, rivet head height, etc.
- Supplied with flat anvil and rod anvil
- Resolution 0.001mm/0.00005"
- IP65 dust/waterproof
- Button function: on/off, set, mm/inch, data transmit
- Data output
- Automatic power off
- Ratchet stop
- Carbide spindle tip
- Setting standards are included (except 0-25mm/0-1")
- Optional accessory: data output cable (code 7315-31 need receiver page 4, 7302-31 page 12)



3562-25A

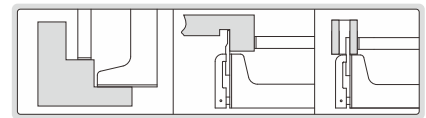
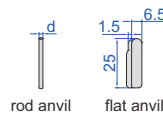
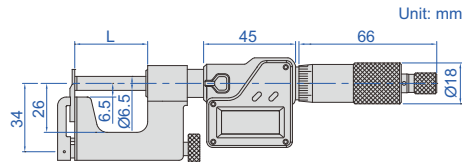

6

Code	Range	Accuracy	L	d
3562-25A	0-25mm/0-1"	±4µm	28.5mm	Ø3mm
3562-50A	25-50mm/1-2"	±4µm	53.5mm	Ø5mm

## LARGE ANVIL MICROMETERS

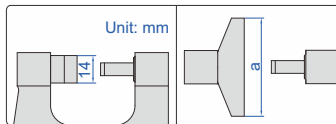

3234-25A

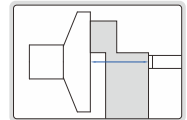

- Graduation 0.01mm
- Ratchet stop
- Supplied with setting standards (except 0-25mm)

Code	Range	Accuracy	L	a	b
3234-25A	0-25mm	4µm	42mm	50mm	26mm
3234-50A	25-50mm	4µm	67mm	60mm	38mm

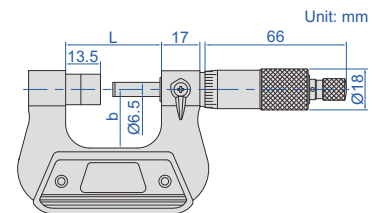

## DIGITAL LARGE ANVIL MICROMETERS

**DATA**  
OUTPUT

**IP65**  
WATERPROOF

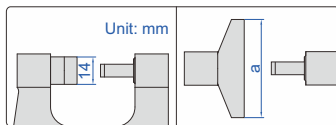

3534-25A

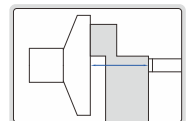

- Resolution 0.001mm/0.00005"
- IP65 dust/waterproof
- Button function: on/off, set, mm/inch, data transmit
- Data output
- Automatic power off
- Ratchet stop
- Supplied with setting standards (except 0-25mm/0-1")
- Optional accessory: data output cable (code 7315-31 need receiver page 4, 7302-31 page 12)

Code	Range	Accuracy	L	a	b
3534-25A	0-25mm/0-1"	±4µm	42mm	50mm	26mm
3534-50A	25-50mm/1-2"	±4µm	67mm	60mm	38mm

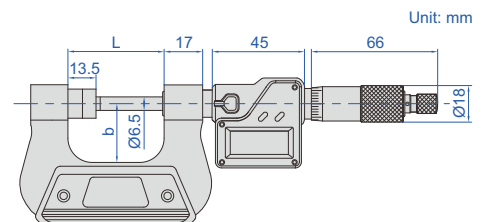

## V-ANVIL MICROMETERS



3290-153A

- Measure the diameter of parts or cutting tools with odd grooves, such as taps, reamers and end mills
- Graduation 0.01mm
- Ratchet stop
- Carbide measuring faces
- Supplied with setting standards

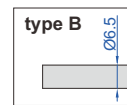
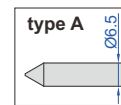
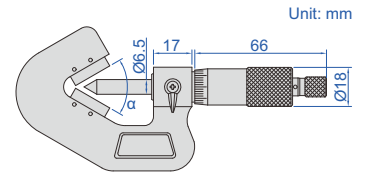

Code	Range	Flutes	Accuracy	α	Type
3290-153A	1-15mm	3	4μm	60°	A
3290-203A	5-20mm	3	4μm	60°	B
3290-353A	20-35mm	3	5μm	60°	B
3290-503A	35-50mm	3	5μm	60°	B
3290-653A	50-65mm	3	6μm	60°	B
3290-803A	65-80mm	3	6μm	60°	B
3290-953A	80-95mm	3	7μm	60°	B
3290-255A	5-25mm	5	4μm	108°	B

Code	Range	Flutes	Accuracy	α	Type
3290-455A	25-45mm	5	5μm	108°	B
3290-655A	45-65mm	5	6μm	108°	B
3290-855A	65-85mm	5	7μm	108°	B
3290-1055A	85-105mm	5	8μm	108°	B
3290-257A	5-25mm	7	4μm	128°34'17"	B
3290-457A	25-45mm	7	5μm	128°34'17"	B
3290-657A	45-65mm	7	6μm	128°34'17"	B
3290-857A	65-85mm	7	7μm	128°34'17"	B

**IP65**  
WATERPROOF

**DATA**  
OUTPUT

## DIGITAL V-ANVIL MICROMETERS



3590-153A

- Measure the diameter of parts or cutting tools with odd grooves, such as taps, reamers and end mills
- Resolution 0.001mm/0.00005"
- IP65 dust/waterproof
- Button function: on/off, set, mm/inch, data transmit
- Data output
- Automatic power off
- Ratchet stop
- Carbide measuring faces
- Supplied with setting standards
- Optional accessory: data output cable (code 7315-31 need receiver page 4, 7302-31 page 12)

Unit: mm

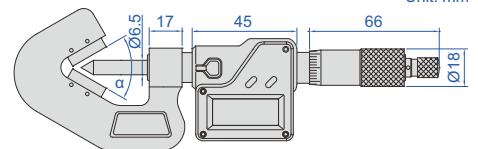
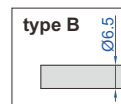
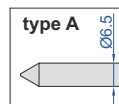

Code	Range	Flutes	Accuracy	α	Type
3590-153A	1-15mm/0.04-0.6"	3	±4μm	60°	A
3590-203A	5-20mm/0.2-0.8"	3	±4μm	60°	B
3590-353A	20-35mm/0.8-1.4"	3	±5μm	60°	B
3590-503A	35-50mm/1.4-2.0"	3	±5μm	60°	B
3590-653A	50-65mm/2.0-2.6"	3	±6μm	60°	B
3590-803A	65-80mm/2.6-3.2"	3	±6μm	60°	B
3590-953A	80-95mm/3.2-3.6"	3	±6μm	60°	B
3590-255A	5-25mm/0.2-1.0"	5	±4μm	108°	B

Code	Range	Flutes	Accuracy	α	Type
3590-455A	25-45mm/1.0-1.8"	5	±5μm	108°	B
3590-655A	45-65mm/1.8-2.6"	5	±6μm	108°	B
3590-855A	65-85mm/2.6-3.4"	5	±6μm	108°	B
3590-1055A	85-105mm/3.4-4.2"	5	±6μm	108°	B
3590-257A	5-25mm/0.2-1.0"	7	±4μm	128°34'17"	B
3590-457A	25-45mm/1.0-1.8"	7	±4μm	128°34'17"	B
3590-657A	45-65mm/1.8-2.6"	7	±5μm	128°34'17"	B
3590-857A	65-85mm/2.6-3.4"	7	±5μm	128°34'17"	B

## NON-ROTATING SPINDLE UNIVERSAL MICROMETERS

NON-ROTATING SPINDLE



3280-25A

- Meet DIN863-3
- Graduation 0.01mm
- Non-rotating spindle
- Ratchet stop
- Supplied with 7 pairs of anvil/spindle tip
- Setting standards are included (except 0-25mm)
- Optional accessory: 55° anvil/spindle tip (code **3280-SP1** and **3280-SP2**)

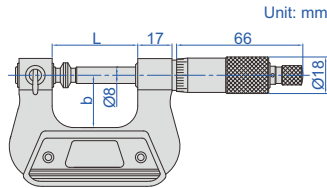

Code	Range	Accuracy	L	b
<b>3280-25A</b>	0-25mm	4µm	42mm	26mm
<b>3280-50A</b>	25-50mm	4µm	67mm	38mm
<b>3280-75A</b>	50-75mm	5µm	92mm	50mm
<b>3280-100A</b>	75-100mm	5µm	118mm	62mm
<b>3280-125A</b>	100-125mm	6µm	143mm	70mm
<b>3280-150A</b>	125-150mm	6µm	168mm	82mm
<b>3280-175A</b>	150-175mm	7µm	192mm	95mm
<b>3280-200A</b>	175-200mm	7µm	217mm	107mm

Anvil/spindle tip (included)

Unit: mm

Flat		
Spherical		
Spline		
Disk		
Blade		
Knife-edge		
Point		

55° anvil/spindle tip (optional)

Unit: mm

Code <b>3280-SP1</b> Knife-edge		
Code <b>3280-SP2</b> Point		

## DIGITAL UNIVERSAL MICROMETERS

DATA OUTPUT

NON-ROTATING SPINDLE



3580-25A

- Resolution 0.001mm/0.00005"
- Non-rotating spindle
- Button function: on/off, set, mm/inch, data transmit
- Data output
- Automatic power off
- Ratchet stop
- Supplied with 7 pairs of anvil/spindle tip
- Setting standards are included (except 0-25mm/0-1")
- Optional accessory: 55° anvil/spindle tip code **3280-SP1** and **3280-SP2**, data output cable (code **7315-31** need receiver page 4, **7302-31** page 12)

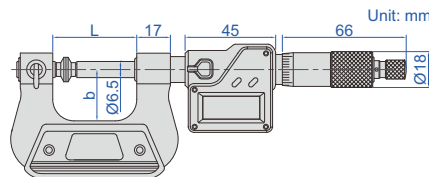

Code	Range	Accuracy	L	b
<b>3580-25A</b>	0-25mm/0-1"	±4µm	42	26
<b>3580-50A</b>	25-50mm/1-2"	±4µm	67	38
<b>3580-75A</b>	50-75mm/2-3"	±5µm	92	50
<b>3580-100A</b>	75-100mm/3-4"	±5µm	118	62
<b>3580-125A</b>	100-125mm/4-5"	±6µm	143	70
<b>3580-150A</b>	125-150mm/5-6"	±6µm	168	82
<b>3580-175A</b>	150-175mm/6-7"	±7µm	192	95
<b>3580-200A</b>	175-200mm/7-8"	±7µm	217	107

Anvil/spindle tip (included)

Unit: mm

Flat		
Spherical		
Spline		
Disk		
Blade		
Knife-edge		
Point		

55° anvil/spindle tip (optional)

Unit: mm

Code <b>3280-SP1</b> Knife-edge		
Code <b>3280-SP2</b> Point		

## CALIPER TYPE MICROMETERS

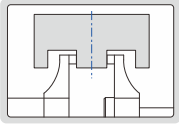

3238-25

- Graduation 0.01mm
- Non-rotating spindle
- Ratchet stop
- Carbide measuring faces
- Supplied with setting standards (except 0-25mm)

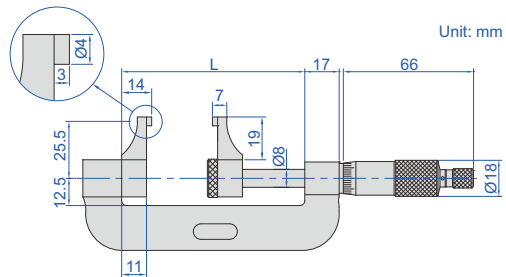

Code	Range	Accuracy	L
3238-25	0-25mm	10 $\mu$ m	56mm
3238-50	25-50mm	10 $\mu$ m	81mm
3238-75	50-75mm	11 $\mu$ m	106mm
3238-100	75-100mm	11 $\mu$ m	131mm

## DIGITAL CALIPER TYPE MICROMETERS

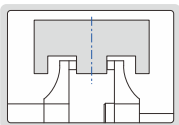

3538-25

- Resolution: 0.001mm/0.00005"
- Non-rotating spindle
- Buttons: on/off, data set, mm/in, ABS/INC
- Data output
- Automatic power off
- Ratchet friction thimble
- Carbide measuring faces
- Supplied with setting standards (except 0-25mm/0-1")

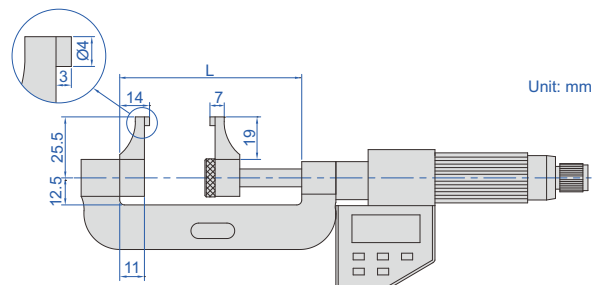

Code	Range	Accuracy	L
3538-25	0-25mm/0-1"	$\pm$ 10 $\mu$ m	56mm
3538-50	25-50mm/1-2"	$\pm$ 10 $\mu$ m	81mm
3538-75	50-75mm/2-3"	$\pm$ 11 $\mu$ m	106mm
3538-100	75-100mm/3-4"	$\pm$ 11 $\mu$ m	131mm

## JAW TYPE MICROMETERS

NON-ROTATING SPINDLE

- Graduation 0.01mm
- Non-rotating spindle
- Ratchet stop
- Supplied with setting standards (except 0-25mm)



3283-25A

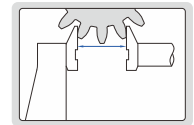
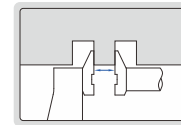
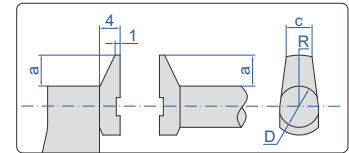
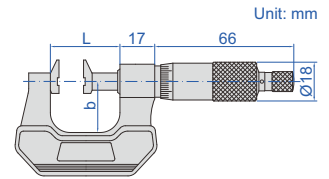

Code	Range	Accuracy	L	a	b	c	R	D
3283-25A	0-25mm	4µm	34	6	24	5	10	8
3283-50A	25-50mm	4µm	59	6	32	5	10	8
3283-75A	50-75mm	5µm	85	6	45	5	10	8
3283-100A	75-100mm	5µm	110	6	57	5	10	8
3283-125A	100-125mm	6µm	138	9	70	8	15	12
3283-150A	125-150mm	6µm	163	9	82	8	15	12
3283-175A	150-175mm	7µm	188	9	95	8	15	12
3283-200A	175-200mm	7µm	214	9	107	8	15	12

6

## DIGITAL JAW TYPE MICROMETERS

DATA OUTPUT

NON-ROTATING SPINDLE



3583-25A

- Resolution 0.001mm/0.00005"
- Non-rotating spindle
- Button function: on/off, set, mm/inch, data transmit
- Data output
- Automatic power off
- Ratchet stop
- Supplied with setting standards (except 0-25mm/0-1")
- Optional accessory: data output cable (code 7315-31 need receiver page 4, 7302-31 page 12)

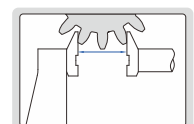
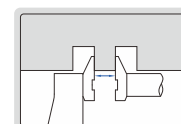
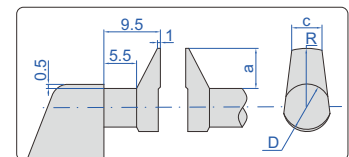
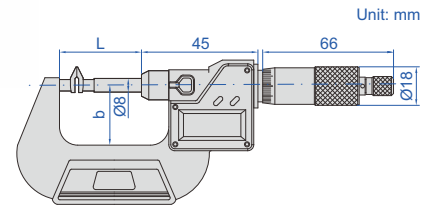

Code	Range	Accuracy	L	a	b	c	R	D
3583-25A	0-25mm/0-1"	±4µm	43	6.5	32	5	10	8
3583-50A	25-50mm/1-2"	±4µm	85	6.5	44.5	5	10	8
3583-75A	50-75mm/2-3"	±5µm	110	6.5	57	5	10	8
3583-100A	75-100mm/3-4"	±5µm	135	6.5	70	5	10	8
3583-125A	100-125mm/4-5"	±6µm	160	11.5	86	8	15	12
3583-150A	125-150mm/5-6"	±6µm	186	11.5	94.5	8	15	12
3583-175A	150-175mm/6-7"	±7µm	211	11.5	107	8	15	12
3583-200A	175-200mm/7-8"	±7µm	236	11.5	120	8	15	12





ATTENTION: SETTING  
STANDARDS ARE NOT INCLUDED

## DISK INDICATING MICROMETERS

**INSIZE PLUS**  
MADE IN EUROPE



3338-20

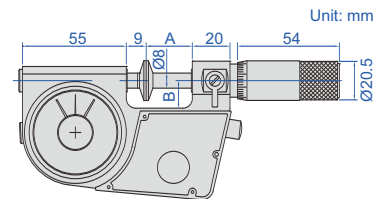

- Meet DIN863-3
- Suitable for measuring the common normal length of spur and helical gears
- Carbide measuring faces
- Measuring force 5-10N
- Optional accessory: gage blocks grade 0 (4101-A series), for zero setting

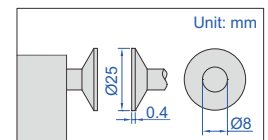

(mm)

Code	Micrometer head			Dial indicator			A	B
	range	graduation	accuracy	range	graduation	accuracy		
3338-201*	0-20mm	0.01mm	4µm	±0.07mm	1µm	2µm	26	15
3338-20*	0-20mm	0.01mm	4µm	±0.14mm	2µm	4µm	26	15
3338-451*	20-45mm	0.01mm	4µm	±0.07mm	1µm	2µm	51.5	25
3338-45*	20-45mm	0.01mm	4µm	±0.14mm	2µm	4µm	51.5	25
3338-701*	45-70mm	0.01mm	4µm	±0.07mm	1µm	2µm	76.5	37
3338-70*	45-70mm	0.01mm	4µm	±0.14mm	2µm	4µm	76.5	37
3338-951*	70-95mm	0.01mm	4µm	±0.07mm	1µm	2µm	101.5	52.5
3338-95*	70-95mm	0.01mm	4µm	±0.14mm	2µm	4µm	101.5	52.5
3338-120*	95-120mm	0.01mm	4µm	±0.14mm	2µm	2µm	126.5	65
3338-145*	120-145mm	0.01mm	4µm	±0.14mm	2µm	4µm	126.5	77.5

\* Supplied with manufacturer inspection certificate

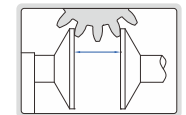

ATTENTION: SETTING  
STANDARDS ARE NOT INCLUDED

## DISK MICROMETERS

**INSIZE PLUS**  
MADE IN EUROPE

- Graduation: 0.01mm
- Ratchet stop
- One turn of sleeve makes 0.5mm spindle feed
- Optional accessory: setting standards (code 7386)



3676-25

(mm)

Code	Range	Accuracy	L	b
3676-25	0-25mm	4µm	37	24
3676-50	25-50mm	4µm	62	34
3676-75	50-75mm	5µm	87	46
3676-100	75-100mm	5µm	112	60
3676-125	100-125mm	6µm	139	72
3676-150	125-150mm	6µm	164	85
3676-175	150-175mm	7µm	190	97
3676-200	175-200mm	7µm	215	110
3676-225	200-225mm	8µm	240	122
3676-250	225-250mm	8µm	264	135
3676-275	250-275mm	9µm	290	148
3676-300	275-300mm	9µm	315	160

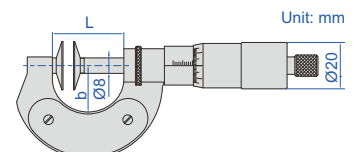
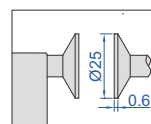
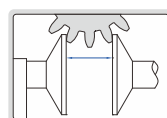

## LARGE RANGE DISK MICROMETERS

**INSIZE PLUS**  
MADE IN EUROPE

ATTENTION: SETTING  
STANDARDS ARE NOT INCLUDED

LIGHT  
WEIGHT

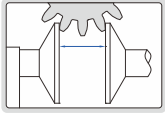

- Graduation: 0.01mm
- Ratchet stop
- Quick measurement, one turn of sleeve makes 1mm spindle feed
- Light weight
- Optional accessory: setting standards (code 7386)



3677-350

6

(mm)

Code	Range	Accuracy	L	b	Weight
3677-350	300-350mm	8μm	370	190	1.65kg
3677-400	350-400mm	8μm	430	220	1.95kg
3677-450	400-450mm	9μm	475	250	2.30kg
3677-500	450-500mm	9μm	530	273	2.45kg
3677-550	500-550mm	10μm	570	291	2.55kg
3677-600	550-600mm	10μm	630	323	3.15kg
3677-650	600-650mm	10μm	675	351	3.45kg
3677-700	650-700mm	10μm	730	378	3.85kg
3677-750	700-750mm	10μm	785	401	4.05kg
3677-800	750-800mm	10μm	830	423	4.25kg
3677-850	800-850mm	11μm	885	440	4.45kg
3677-900	850-900mm	11μm	930	473	5.05kg
3677-950	900-950mm	11μm	980	503	5.95kg
3677-1000	950-1000mm	11μm	1030	520	6.25kg

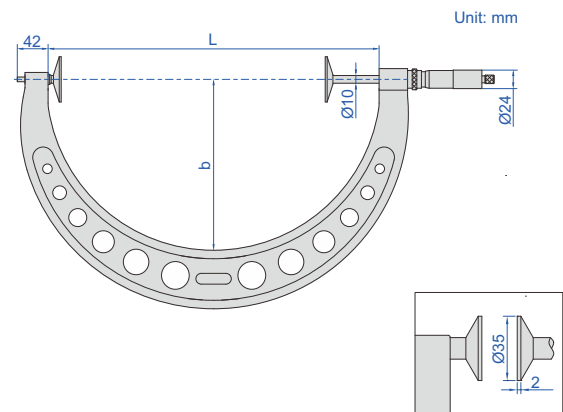

## DISK MICROMETERS

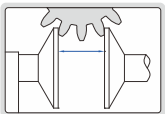

- Measure root tangent length of gear
- Graduation 0.01mm
- Ratchet stop
- Supplied with setting standards



3282-25

(mm)

Code	Range	Accuracy	Parallelism	L	b	c
3282-25	0-25mm	4μm	5μm	34	24	3.3
3282-50	25-50mm	4μm	5μm	59	32	3.3
3282-75	50-75mm	5μm	5μm	85	45	3.3
3282-100	75-100mm	5μm	5μm	110	57	3.3

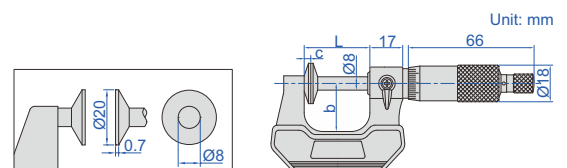

**NON-ROTATING SPINDLE**

**NON-ROTATING SPINDLE DISK MICROMETERS**

- Measure root tangent length of gear
- Graduation 0.01mm
- Non-rotating spindle
- Ratchet stop
- Supplied with setting standards

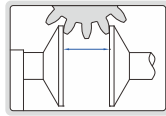

3294-25

Code	Range	Accuracy	Parallelism	L	b
3294-25	0-25mm	4μm	5μm	34	24
3294-50	25-50mm	4μm	5μm	59	32
3294-75	50-75mm	5μm	5μm	85	45
3294-100	75-100mm	5μm	5μm	110	57

(mm)

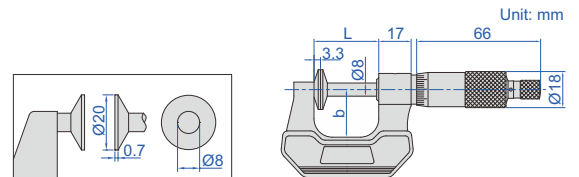

**DATA OUTPUT**

**NON-ROTATING SPINDLE**

**DIGITAL NON-ROTATING SPINDLE DISK MICROMETERS**

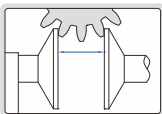

3594-25A

- Measure root tangent length of gear
- Resolution 0.001mm/0.00005"
- Non-rotating spindle
- Button function: on/off, set, mm/inch, data transmit
- Data output
- Automatic power off
- Ratchet stop
- Supplied with setting standards
- Optional accessory: data output cable (code 7315-31 need receiver page 4, 7302-31 page 12)

Code	Range	Accuracy	Parallelism	L	b
3594-25A	0-25mm/0-1"	±4μm	5μm	43mm	32mm
3594-50A	25-50mm/1-2"	±4μm	5μm	68mm	44.5mm
3594-75A	50-75mm/2-3"	±5μm	5μm	93mm	57mm
3594-100A	75-100mm/3-4"	±5μm	5μm	118.5mm	70mm

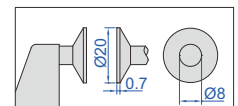
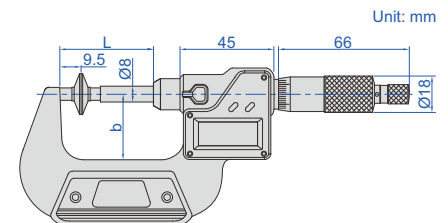

# HIGH PRECISION DIGITAL DISK MICROMETERS/SNAP GAGES

- DATA OUTPUT**
- NON-ROTATING SPINDLE**
- ONE TURN OF SLEEVE MAKES 5MM SPINDLE FEED, PRESS THE FORK, THE SPINDLE RETRACTS 3MM**
- ABSOLUTE ENCODER, THE ORIGINAL DATA REMAINS AFTER POWER OFF**
- MEASUREMENT ACCURACY IS NOT AFFECTED BY THE USE OF SLEEVE**

ATTENTION: RECHARGEABLE BATTERY, FOR 24 HOURS CONTINUOUS WORKING

**IP65**  
WATERPROOF

**INSPECTION**  
CERTIFICATE



3353-25

- Measure root tangent length of gear
- Absolute encoder, the original data remains after power off
- Adjustable resolution: 0.0002mm/0.00001"  
0.001mm/0.00005"  
0.01mm/0.0005"
- One turn of sleeve makes 5mm spindle feed
- Measurement accuracy is not affected by the use of sleeve
- Press the fork, the spindle retracts 3mm
- Linear ball bearings for ten million times use
- Carbide spindle and anvil
- Measuring force 7-10N  
Customizable measuring force range 2-12N  
Attention: small measuring force will reduce the dustproof and waterproof level
- Button function: data output, tolerance, data preset, data hold, measuring direction change, max./min./TIR, power off time, on/off, zero, mm/inch, adjust resolution
- Supplied with gage blocks for zero setting
- Power: rechargeable battery, for 24 hours continuous working

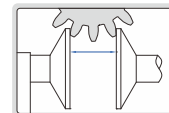
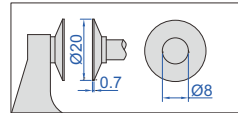
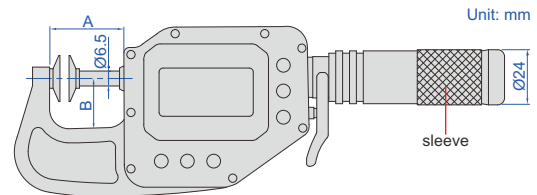

### With data interface

Optional accessory:

wireless transmitter, code **7315-3350** need receiver page 6

data output cable (keyboard format), code **7302-3350** page 13

Code	Range	Accuracy	Repeatability	Parallelism	A	B
3353-25 *	0-25mm/0-1"	4µm	1µm	4µm	38mm	24mm
3353-50 *	25-50mm/1-2"	4µm	1µm	4µm	63mm	25mm
3353-75 *	50-75mm/2-3"	5µm	1µm	5µm	88mm	42mm
3353-100 *	75-100mm/3-3.95"	5µm	1µm	5µm	113mm	56mm
3353-125 *	100-125mm/4-5"	6µm	2µm	6µm	128mm	62.5mm
3353-150 *	125-150mm/5-6"	6µm	2µm	6µm	153mm	75mm

### Built-in wireless

Optional accessory:

wireless receiver (keyboard format, connect up to 15 digital indicators), code **2134-R1**

wireless receiver (serial port format, connect up to 15 digital indicators), code **2134-R2**

Code	Range	Accuracy	Repeatability	Parallelism	A	B
3353-25WL *	0-25mm/0-1"	4µm	1µm	4µm	38mm	24mm
3353-50WL *	25-50mm/1-2"	4µm	1µm	4µm	63mm	25mm
3353-75WL *	50-75mm/2-3"	5µm	1µm	5µm	88mm	42mm
3353-100WL *	75-100mm/3-3.95"	5µm	1µm	5µm	113mm	56mm
3353-125WL *	100-125mm/4-5"	6µm	2µm	6µm	128mm	62.5mm
3353-150WL *	125-150mm/5-6"	6µm	2µm	6µm	153mm	75mm

alarm when over tolerance

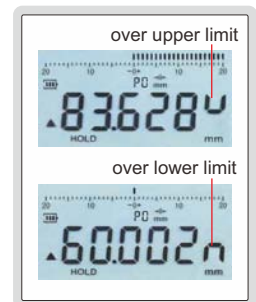

wireless receiver  
2134-R1, 2134-R2 (optional)



\* Supplied with manufacturer inspection certificate

## SHEET METAL MICROMETERS

- Meet DIN863-3
- Measure thickness of sheet metal, paper, plastic and rubber parts
- Graduation 0.01mm
- Ratchet stop
- Carbide measuring faces



3263-25A

(mm)

Code	Range	Type	Accuracy	L	a	b
3263-15A	0-15mm	A	4μm	22	8	50
3263-25A	0-25mm	A	4μm	32	8	50
3263-50A	0-50mm	A	5μm	57	12	100
3263-15B	0-15mm	B	4μm	22	8	50
3263-25B	0-25mm	B	4μm	32	8	50
3263-50B	0-50mm	B	5μm	57	12	100

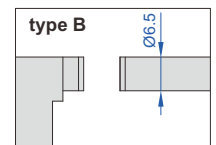
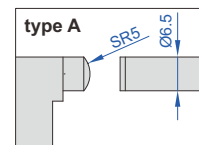
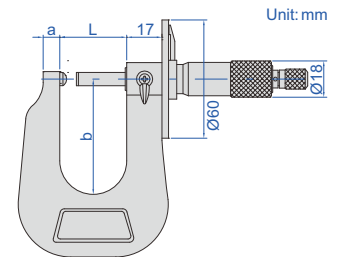
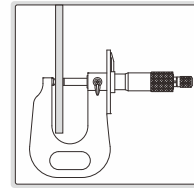

## MICROMETERS FOR HOT PLATE

- Measure thickness of hot rolling sheet metal
- Carbide measuring faces
- Supplied with setting standard (except 0-15mm)



3264-15

Unit: mm

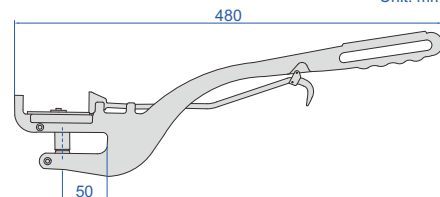

Code	Range	Graduation	Accuracy
3264-15	0-15mm	0.05mm	0.05mm
3264-30	15-30mm	0.05mm	0.05mm
3264-45	30-45mm	0.05mm	0.05mm
3264-60	45-60mm	0.05mm	0.05mm
3264-75	60-75mm	0.05mm	0.05mm
3264-90	75-90mm	0.05mm	0.05mm
3264-105	90-105mm	0.05mm	0.05mm

## HUB MICROMETERS

- Meet DIN863-3
- Measure hub thickness and shoulder inside a bore
- Graduation 0.01mm
- Ratchet stop
- Carbide measuring faces
- Supplied with setting standards (except 0-25mm)



3292-25

(mm)

Code	Range	Accuracy	h1	h2	H
3292-25	0-25mm	4μm	6	9	18.7
3292-50	25-50mm	4μm	6.5	11	21.2
3292-75	50-75mm	5μm	6.5	11	21.2
3292-100	75-100mm	5μm	6.5	11	21.2

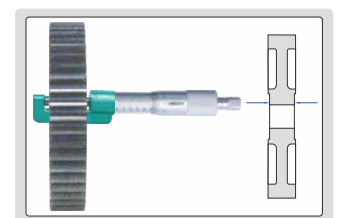
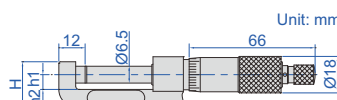

## WIRE MICROMETER

- Meet DIN863-3
- Measure diameter of wires and small balls
- Graduation 0.01mm
- Ratchet stop
- Carbide measuring faces

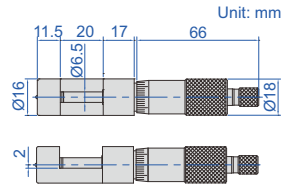

3285-10

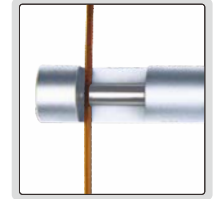

Code	Range	Accuracy
3285-10	0-10mm	4µm

## 6

## CAN SEAM MICROMETERS



3293-131



3293-132



3293-133

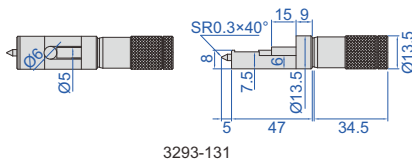

3293-131

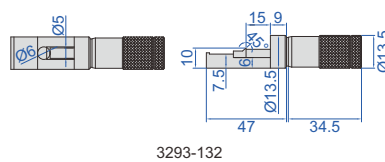

3293-132

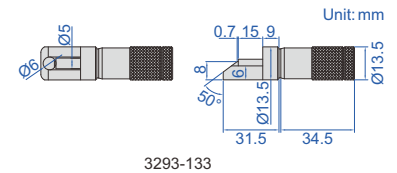

3293-133

- Measure the width, height and depth of can seams
- Graduation 0.01mm

Code	Range	Accuracy
3293-131	0-13mm	4µm
3293-132	0-13mm	4µm
3293-133	0-13mm	4µm

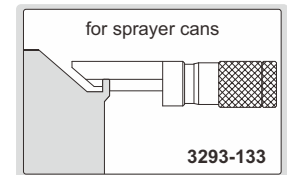
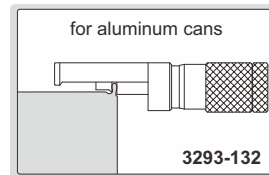
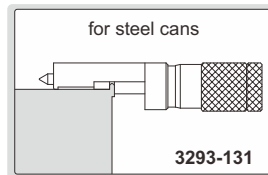

## OPTICAL PARALLELS

- Check the flatness and parallelism of measuring faces of micrometer
- Flatness of A and B: 0.1µm
- Parallelism between A and B: 0.6µm



4184-41A

Code	Parallels included (b)	ØD	Applicable micrometer
4184-41A	15.62mm, 15.75mm, 15.87mm, 16.00mm	30mm	0-25mm
4184-42A	40.62mm, 40.75mm, 40.87mm, 41.00mm	30mm	25-50mm
4184-43B	65.62mm, 65.75mm, 65.87mm, 66.00mm	40mm	50-75mm
4184-44B	90.62mm, 90.75mm, 90.87mm, 91.00mm	50mm	75-100mm

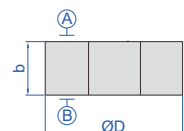

MEASURING TIPS DIAMETER  
ØD CAN BE CUSTOMIZED

## PARALLELISM INSPECT DEVICES FOR OUTSIDE MICROMETERS

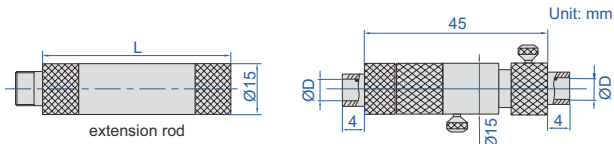

4199-1000



- Check parallelism of outside micrometers
- Simple structure, wide measuring range, high reliability
- Stainless steel measuring tips and extension rod
- Supplied with two kinds of measuring tips

Code	Range	Measuring tips dia. (ØD)	Extension rod (L)
4199-1000	50-1000mm	6.5mm, 8mm	15mm, 25mm, 50mm, 100mm (3 pcs), 150mm, 200mm (2 pcs)
4199-2000	50-2000mm	6.5mm, 8mm	15mm, 25mm, 50mm, 100mm (3 pcs), 150mm, 200mm (7 pcs)

## MICROMETER MEASURING FORCE DETECTOR

- For outside micrometers  
0-25mm/0-1", 25-50mm/1-2",  
50-75mm/2-3" and 75-100mm/3-4"



Code	Measuring force
6315	5-12N

6315

REFER TO PAGE  
326-327 FOR DETAILS

## MICROMETER INSPECTION GAGE BLOCK SETS



4107-10



4160-10

## MICROMETER STAND

- Suitable for outside micrometers  
up to 100mm



6300

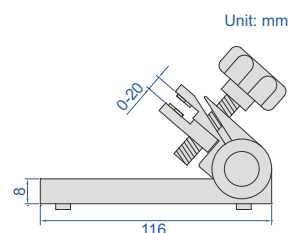

**MICROMETER STAND**



**6302**

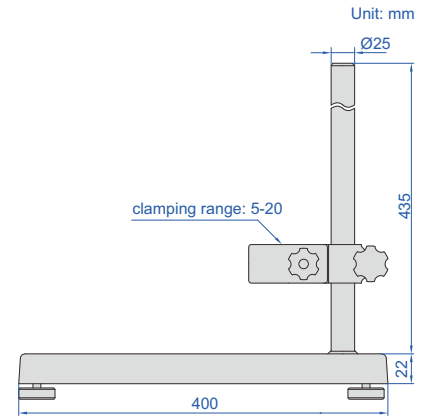

**Code**  
**6302**

- Suitable for 100-300mm outside micrometers (except 3675 series)

**6**

**MICROMETER STAND**

- Suitable for outside micrometers up to 100mm

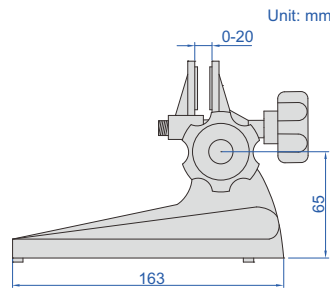

**Code**  
**6301**

**6301**



- Suitable for inside micrometers

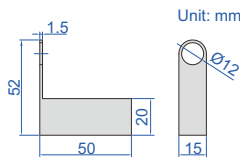

**Code**

**Description**

**Applicable products**

**6301-1**

clamp for inside micrometers

all sizes of **3220** series

**6301-1**



- Suitable for three points internal micrometers

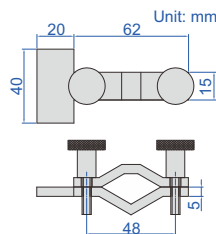

**Code**

**Description**

**Applicable products**

**6301-2**

clamp for three points internal micrometers

up to 100mm of **3127** and **3227** series

**6301-2**







## MICROMETER SETTING STANDARDS

**INSIZE PLUS**  
MADE IN EUROPE



7386-100

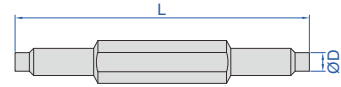

- Suitable for outside micrometers

Code	Length (L)	Accuracy	ØD
7386-25	25mm	±1.25µm	6.5mm
7386-50	50mm	± 1.25µm	6.5mm
7386-75	75mm	± 1.5µm	6.5mm
7386-100	100mm	± 2µm	6.5mm
7386-125	125mm	± 2.5µm	6.5mm
7386-150	150mm	± 2.5µm	6.5mm
7386-175	175mm	± 2.5µm	6.5mm
7386-200	200mm	± 3µm	6.5mm
7386-225	225mm	± 3µm	6.5mm
7386-250	250mm	± 3µm	6.5mm
7386-275	275mm	±3µm	6.5mm
7386-300	300mm	±3µm	10mm
7386-325	325mm	±3.5µm	10mm
7386-350	350mm	±3.5µm	10mm
7386-375	375mm	±3.5µm	10mm
7386-400	400mm	±3.5µm	10mm

Code	Length (L)	Accuracy	ØD
7386-425	425mm	±3.5µm	10mm
7386-450	450mm	±3.5µm	10mm
7386-475	475mm	±3.5µm	10mm
7386-500	500mm	±3.5µm	10mm
7386-525	525mm	±3.5µm	10mm
7386-550	550mm	±3.5µm	10mm
7386-575	575mm	±3.5µm	10mm
7386-600	600mm	±3.5µm	10mm
7386-625	625mm	±4µm	10mm
7386-650	650mm	±4µm	10mm
7386-675	675mm	±4µm	10mm
7386-700	700mm	±4µm	10mm
7386-725	725mm	±4µm	10mm
7386-750	750mm	±4µm	10mm
7386-775	775mm	±4µm	10mm
7386-800	800mm	±4µm	10mm
7386-825	825mm	±4µm	10mm

Code	Length (L)	Accuracy	ØD
7386-850	850mm	±4µm	10mm
7386-875	875mm	±4µm	10mm
7386-900	900mm	±5µm	10mm
7386-925	925mm	±5µm	10mm
7386-950	950mm	±5µm	10mm
7386-975	975mm	±5µm	10mm
7386-1000	1000mm	±5µm	10mm
7386-1050	1050mm	±5µm	10mm
7386-1150	1150mm	±6µm	10mm
7386-1250	1250mm	±7µm	10mm
7386-1350	1350mm	±7µm	10mm
7386-1450	1450mm	±7µm	10mm
7386-1550	1550mm	±9µm	10mm
7386-1650	1650mm	±10µm	10mm
7386-1750	1750mm	±10µm	10mm
7386-1850	1850mm	±11µm	10mm
7386-1950	1950mm	±12µm	10mm

6

## MICROMETER SETTING STANDARDS

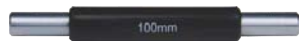

6310-100

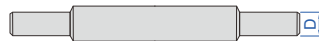

type A



6310-300

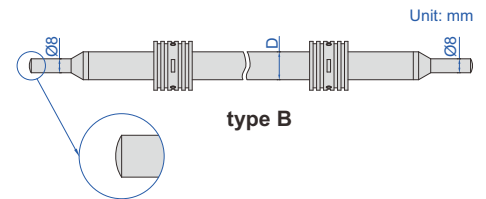

type B

Code	Length	Type	Accuracy	D
6310-25	25	A	±1.5µm	Ø7
6310-50	50	A	±2µm	Ø7
6310-75	75	A	±2.5µm	Ø7
6310-100	100	A	±3µm	Ø8
6310-125	125	A	±3.5µm	Ø8
6310-150	150	A	±4µm	Ø8
6310-175	175	A	±4.5µm	Ø8
6310-200	200	A	±5µm	Ø8
6310-225	225	A	±5.5µm	Ø8
6310-250	250	A	±6µm	Ø8
6310-275	275	A	±6.5µm	Ø8
6310-300	300	B	±7µm	Ø16
6310-325	325	B	±7.5µm	Ø16
6310-350	350	B	±8µm	Ø16
6310-375	375	B	±8.5µm	Ø16

Code	Length	Type	Accuracy	D
6310-400	400	B	±9µm	Ø16
6310-425	425	B	±9.5µm	Ø16
6310-450	450	B	±10µm	Ø16
6310-475	475	B	±10.5µm	Ø16
6310-500	500	B	±11µm	Ø16
6310-525	525	B	±11.5µm	Ø16
6310-575	575	B	±12.5µm	Ø16
6310-625	625	B	±13.5µm	Ø16
6310-675	675	B	±14.5µm	Ø16
6310-725	725	B	±15.5µm	Ø16
6310-775	775	B	±16.5µm	Ø16
6310-825	825	B	±17.5µm	Ø16
6310-875	875	B	±18.5µm	Ø16
6310-925	925	B	±19.5µm	Ø16
6310-975	975	B	±20.5µm	Ø16

Code	Length	Type	Accuracy	D
6310-1050	1050	B	±22µm	Ø23
6310-1150	1150	B	±24µm	Ø23
6310-1250	1250	B	±26µm	Ø23
6310-1350	1350	B	±28µm	Ø23
6310-1450	1450	B	±30µm	Ø23
6310-1550	1550	B	±32µm	Ø23
6310-1650	1650	B	±34µm	Ø23
6310-1750	1750	B	±36µm	Ø23
6310-1850	1850	B	±38µm	Ø23
6310-1950	1950	B	±40µm	Ø23

# CALIPER/MICROMETER LAPPING MACHINE CODE 6318



6

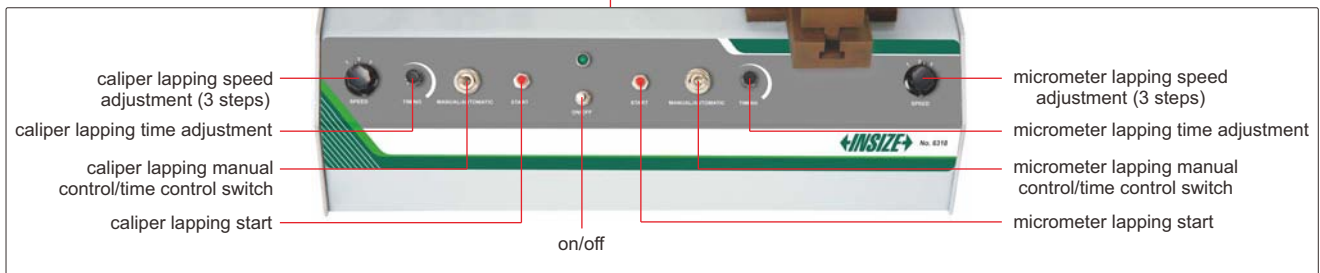

lapping measuring surfaces of caliper lower jaws



lapping measuring surfaces of outside micrometer

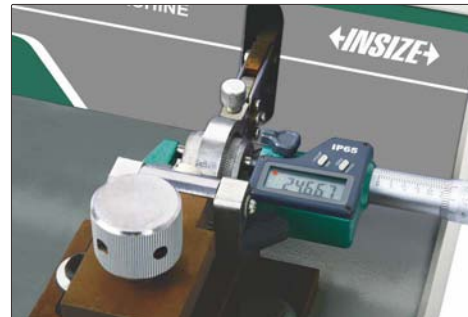

- For lapping measuring surfaces of caliper lower jaws and outside micrometers
- Suitable for 0-300mm range calipers and 0-100mm range outside micrometers
- Supplied with lapping block and diamond paste for calipers
- Lapping blocks for micrometers are optional, diamond paste is included
- Optional accessory: micrometer lapping blocks

caliper lapping block (included)



micrometer lapping blocks (code: 6307-1, optional)



### SPECIFICATION

Power supply	220V, 50/60Hz
Dimension (L×W×H)	430×400×210mm
Weight	28kg

### MICROMETER LAPPING BLOCKS (optional)

Code	For micrometer	Remark
6307-1	0~25mm	includes 4 lapping blocks
6307-2	25~50mm	includes 4 lapping blocks
6307-3	50~75mm	includes 4 lapping blocks
6307-4	75~100mm	includes 4 lapping blocks



## MICROMETER LAPPING MACHINE CODE 6307

- Used for lapping micrometer measuring surfaces
- Suitable for 0~100mm outside micrometers
- Supplied with diamond paste
- Optional accessory: micrometer lapping blocks

### SPECIFICATION

Power supply	220V, 50/60HZ
Dimension (L×W×H)	360×230×210mm
Weight	15kg

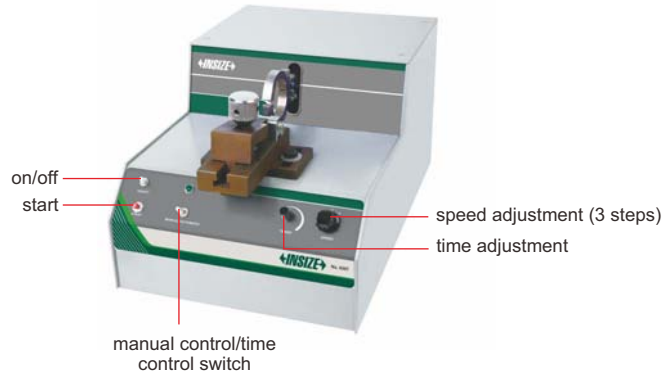

### MICROMETER LAPPING BLOCKS (optional)

Code	For micrometer	Remark
6307-1	0~25mm	includes 4 lapping blocks
6307-2	25~50mm	includes 4 lapping blocks
6307-3	50~75mm	includes 4 lapping blocks
6307-4	75~100mm	includes 4 lapping blocks

micrometer lapping blocks (code: 6307-1, optional)



**IP65**  
WATERPROOF

**DATA**  
OUTPUT

## DIGITAL MICROMETER HEADS

- Resolution: 0.001mm/0.00005"
- IP65 dust/waterproof
- Button function: on/off, set, mm/inch, data transmit
- Data output, automatic power off
- Ratchet stop
- Optional accessory: data output cable (code 7315-31 need receiver page 4, 7302-31 page 12)



6353-25W

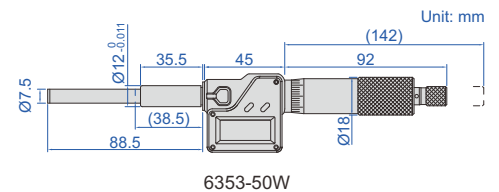
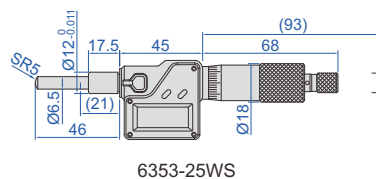
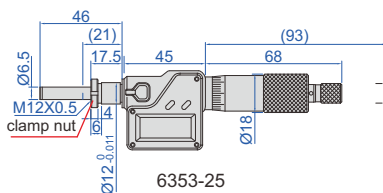

### Rotating spindle

Code	Range	Stem	Spindle tip	Accuracy
6353-25	0-25mm/0-1"	with clamp nut	flat (carbide)	±2μm
6353-25W	0-25mm/0-1"	plain	flat (carbide)	±2μm
6353-25S	0-25mm/0-1"	with clamp nut	spherical (SR5)	±2μm
6353-25WS	0-25mm/0-1"	plain	spherical (SR5)	±2μm
6353-50W	0-50mm/0-2"	plain	flat (carbide)	±4μm

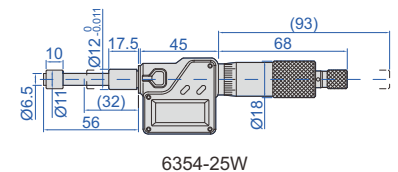

### Non-rotating spindle

Code	Range	Stem	Spindle tip	Accuracy
6354-25W	0-25mm/0-1"	plain	flat	±2μm

## SMALL MICROMETER HEAD

- Graduation: 0.02mm



6372-5WS

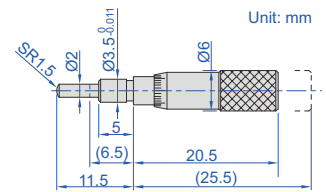

Code	Range	Stem	Spindle tip	Accuracy
6372-5WS	0-5mm	plain	spherical (SR1.5)	5µm

## SMALL MICROMETER HEADS



6385-65W

- Range: 0-6.5mm
- Graduation: 0.01mm
- Accuracy: 5µm

Code	Stem	Spindle tip
6385-65	with clamp nut	flat
6385-65W	plain	flat
6385-65S	with clamp nut	spherical (SR3)
6385-65WS	plain	spherical (SR3)

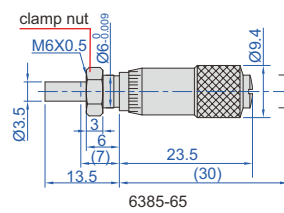

6385-65

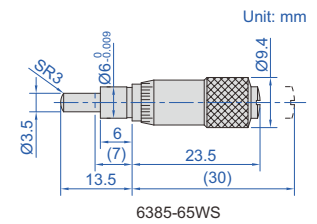

6385-65WS

## LARGE THIMBLE MICROMETER HEADS



6373-65

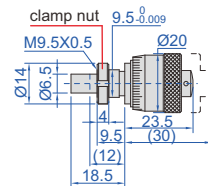

6373-65

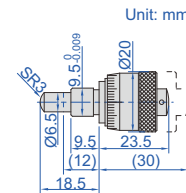

6373-65WS



6373-13

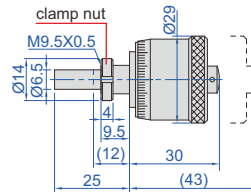

6373-13

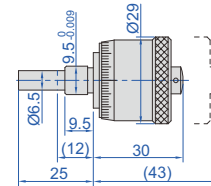

6373-13W

Code	Range	Stem	Spindle tip
6373-65	0-6.5mm	with clamp nut	flat
6373-65W	0-6.5mm	plain	flat
6373-65S	0-6.5mm	with clamp nut	spherical (SR3)
6373-65WS	0-6.5mm	plain	spherical (SR3)
6373-13	0-13mm	with clamp nut	flat
6373-13W	0-13mm	plain	flat

- Meet DIN863-2
- Large thimble diameter for easy reading
- Graduation: 0.01mm
- Accuracy: 3µm

## MICROMETER HEADS WITH ZERO ADJUSTABLE THIMBLE

- Meet DIN863-2
- Range: 0-13mm
- Graduation: 0.01mm
- Accuracy: 3µm
- The thimble can be set to zero at any position



6384-13W

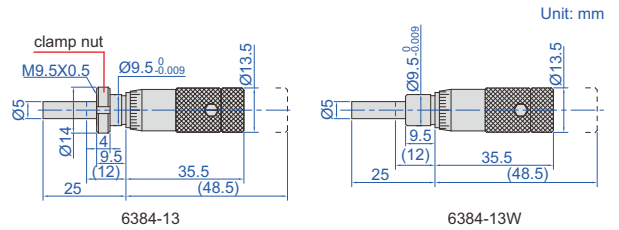

Code	Stem	Spindle tip
6384-13	with clamp nut	flat
6384-13W	plain	flat

## MICROMETER HEADS

6

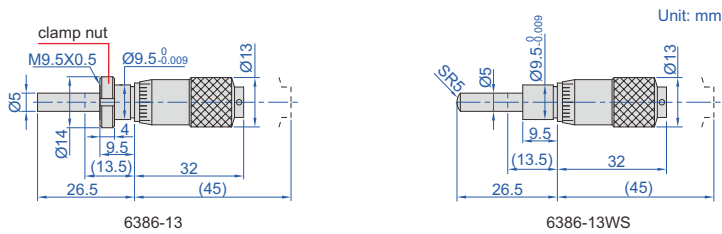

6386-13W

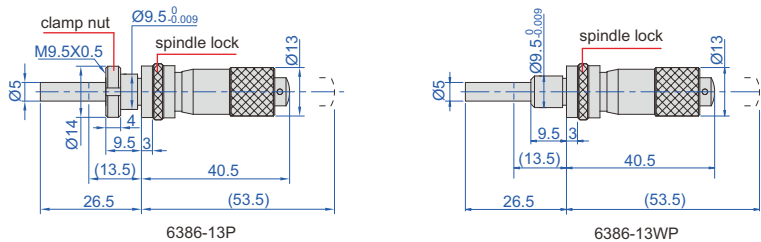

6386-13P

Code	Range	Stem	Spindle tip	Remark	Accuracy
6386-13	0-13mm	with clamp nut	flat		3µm
6386-13W	0-13mm	plain	flat		3µm
6386-13S	0-13mm	with clamp nut	spherical (SR5)		3µm
6386-13WS	0-13mm	plain	spherical (SR5)		3µm
6386-13P	0-13mm	with clamp nut	flat	with spindle lock	3µm
6386-13WP	0-13mm	plain	flat	with spindle lock	3µm

- Meet DIN863-2
- Graduation: 0.01mm

## MICROMETER HEADS

- Meet DIN863-2
- Graduation: 0.01mm
- Accuracy: 3µm



6387-15WS

Code	Range	Stem	Spindle tip
6387-15	0-15mm	with clamp nut	flat
6387-15W	0-15mm	plain	flat
6387-15S	0-15mm	with clamp nut	spherical (SR5)
6387-15WS	0-15mm	plain	spherical (SR5)

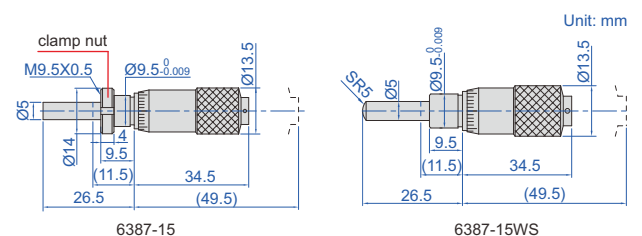

## MICROMETER HEADS



6381-25

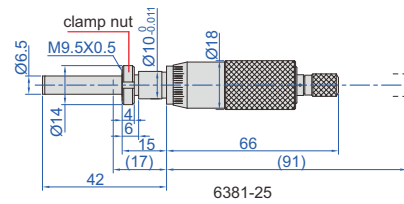

6381-25

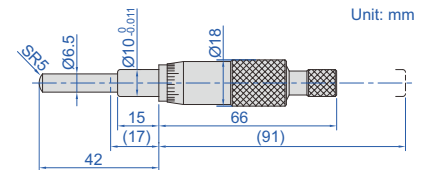

6381-25WS



6381-25P

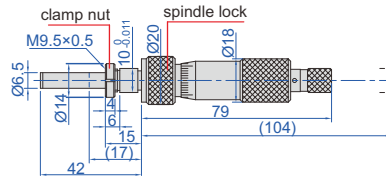

6381-25P

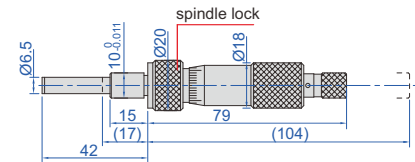

6381-25WP

6

- Meet DIN863-2
- Graduation: 0.01mm
- Ratchet stop

Code	Range	Stem	Spindle tip	Remark	Accuracy
6381-25	0-25mm	with clamp nut	flat (carbide)		3µm
6381-25W	0-25mm	plain	flat (carbide)		3µm
6381-25S	0-25mm	with clamp nut	spherical (SR5)		3µm
6381-25WS	0-25mm	plain	spherical (SR5)		3µm
6381-25P	0-25mm	with clamp nut	flat (carbide)	with spindle lock	3µm
6381-25WP	0-25mm	plain	flat (carbide)	with spindle lock	3µm

## MICROMETER HEADS

NON-ROTATING SPINDLE

- Non-rotating spindle
- One turn of sleeve makes 0.05mm spindle feed
- Carbide measuring faces



6389-1A

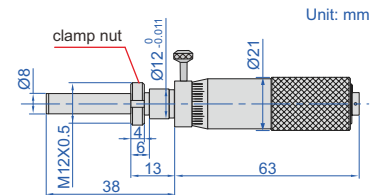

Code	Range	Graduation	Accuracy	
			full range	within 0.05mm
6389-1A	0-2.5mm	0.001mm	5µm	1.5µm
6389-2A	0-2.5mm	0.001mm	7µm	3µm

## NON-ROTATING SPINDLE MICROMETER HEAD

- Meet DIN863-2
- Graduation: 0.01mm
- Ratchet stop
- Non-rotating spindle



6377-25W

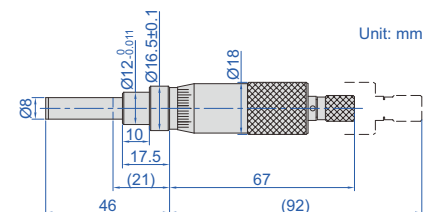

Code	Range	Stem	Spindle tip	Accuracy
6377-25W	0-25mm	plain	flat (carbide)	3µm

## LARGE MICROMETER HEADS



6388-50AW

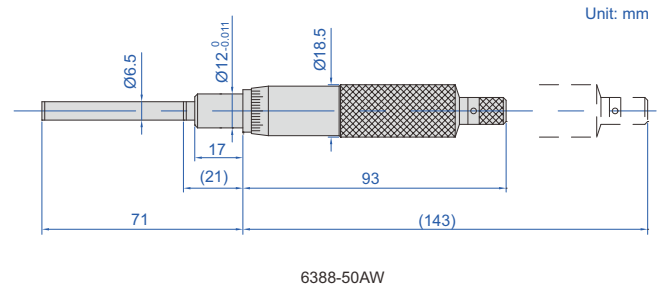
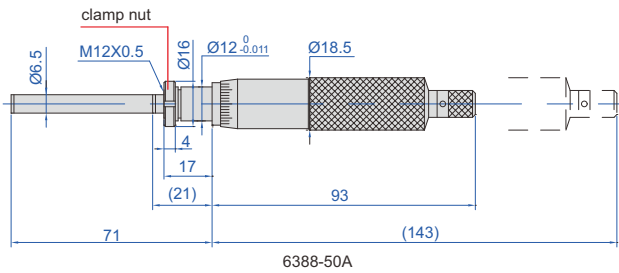

- Graduation: 0.01mm
- Ratchet stop

Code	Range	Stem	Spindle tip	Accuracy
6388-50A	0-50mm	with clamp nut	flat (carbide)	5µm
6388-50AW	0-50mm	plain	flat (carbide)	5µm

## QUICK SPINDLE FEEDING MICROMETER HEADS



6375-15W



6375-25W

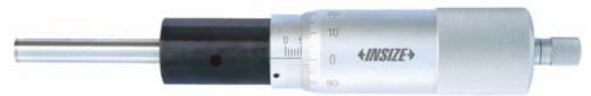

6375-50W

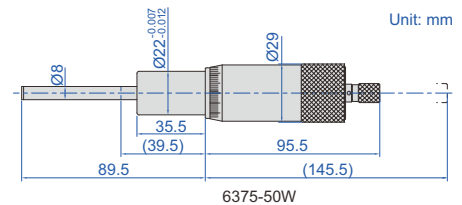
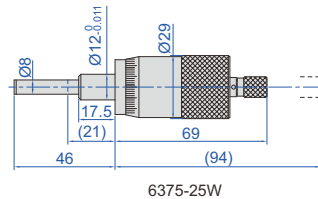
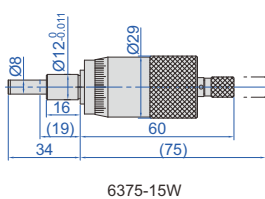

- Micrometers up to 25mm meet DIN863-2
- Graduation: 0.01mm
- Quick spindle feed of 1mm/rev.
- Ratchet stop

Code	Range	Stem	Spindle tip	Accuracy
6375-15W	0-15mm	plain	flat (carbide)	3µm
6375-25W	0-25mm	plain	flat (carbide)	3µm
6375-50W	0-50mm	plain	flat (carbide)	5µm

# 07

# BORE DIAMETER, CIRCUMFERENCE MEASUREMENT



Inside Micrometers  
Page 169-170



Inside Micrometers  
Page 170-177



Three Points Internal  
Micrometers  
Page 178-181



Pistol Grip Three Points  
Bore Gages  
Page 182



Bore Plug Gages  
Page 183-184



Split Type Dial Bore Gages  
Page 185-186



Bore Gages  
Page 187-195/197



Gear Bore Gages  
Page 196



Bore Gage Setters  
Page 198



Carbon Fiber Bore Gages  
Page 199



Internal Chamfer Gages  
Page 200



Telescoping Gage Sets  
Page 200-201



Tape Bore Gages  
Page 201-202



Circumference Tapes  
Page 203-204

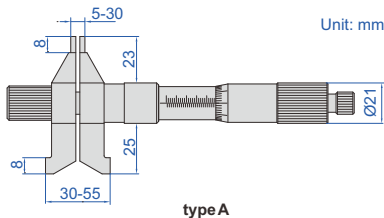

**3679-55**

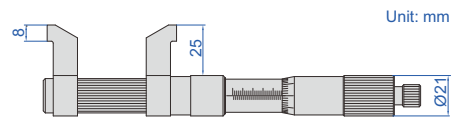
**type A**

**3679-75**

**type B**

for type A, the upper jaws and lower jaws can be set zero separately



- Graduation: 0.01mm
- Carbide measuring faces
- Ratchet stop
- Optional accessory: setting ring (code **6312**), caliper/height gage checker (code **6884**)

Code	Range	Type	Accuracy
<b>3679-55 *</b>	5-55mm	A	4µm
<b>3679-75 *</b>	50-75mm	B	5µm
<b>3679-100 *</b>	75-100mm	B	6µm
<b>3679-125 *</b>	100-125mm	B	7µm
<b>3679-150 *</b>	125-150mm	B	8µm
<b>3679-175 *</b>	150-175mm	B	9µm
<b>3679-200 *</b>	175-200mm	B	9µm
<b>3679-225 *</b>	200-225mm	B	10µm
<b>3679-250 *</b>	225-250mm	B	10µm
<b>3679-275 *</b>	250-275mm	B	12µm
<b>3679-300 *</b>	275-300mm	B	12µm

\* Supplied with manufacturer inspection certificate

Code	Range	Type	Accuracy
<b>3679-325 *</b>	300-325mm	B	15µm
<b>3679-350 *</b>	325-350mm	B	15µm
<b>3679-375 *</b>	350-375mm	B	16µm
<b>3679-400 *</b>	375-400mm	B	16µm
<b>3679-425 *</b>	400-425mm	B	17µm
<b>3679-450 *</b>	425-450mm	B	17µm
<b>3679-475 *</b>	450-475mm	B	18µm
<b>3679-500 *</b>	475-500mm	B	18µm
<b>3679-525 *</b>	500-525mm	B	19µm
<b>3679-550 *</b>	525-550mm	B	19µm
<b>3679-575 *</b>	550-575mm	B	20µm
<b>3679-600 *</b>	575-600mm	B	20µm

**ATTENTION: LOW PARALLELISM OF TWO MEASURING FACES**

micrometer stand with clamp (optional)



- Graduation 0.01mm
- Ratchet stop
- Carbide measuring faces
- Optional accessory: setting ring (code **6312**), micrometer stand and clamp (code **6301** and **6301-1**)

Code	Range	Type	Setting ring	Accuracy
<b>3220-30</b>	5-30mm	A	5mm (included)	7µm
<b>3220-50</b>	25-50mm	B	25mm (included)	8µm
<b>3220-75</b>	50-75mm	B	50mm (optional)	9µm
<b>3220-100</b>	75-100mm	C	75mm (optional)	10µm

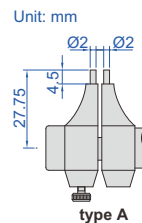
**INSIDE MICROMETERS (ECONOMIC TYPE)**

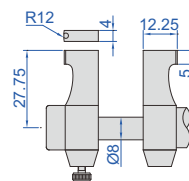
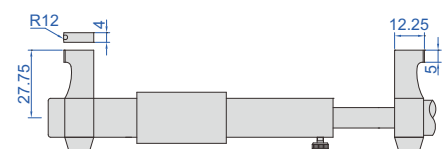
**type A**

**3220-50**

**type B**

**type C**

## DIGITAL INSIDE MICROMETERS (ECONOMIC TYPE)

DATA  
OUTPUT

ATTENTION: LOW PARALLELISM  
OF TWO MEASURING FACES

- Resolution 0.001mm/0.00005"
- Button function: on/off, set, mm/inch, data transmit
- Data output
- Automatic power off
- Ratchet stop
- Carbide measuring faces
- Optional accessory: data output cable (code 7315-31 need receiver page 4, 7302-31 page 12), setting ring (code 6312)



3520-30

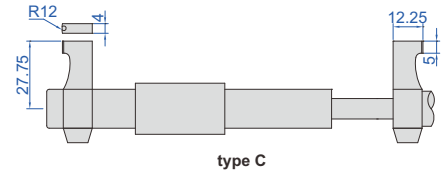
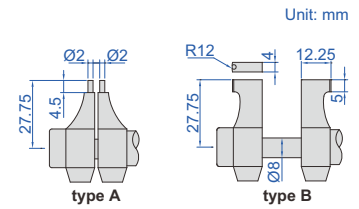

Code	Range	Type	Setting ring	Accuracy
3520-30	5-30mm/0.2-1.2"	A	5mm (included)	$\pm 5\mu\text{m}$
3520-50	25-50mm/1-2"	B	25mm (included)	$\pm 6\mu\text{m}$
3520-75	50-75mm/2-3"	B	50mm (optional)	$\pm 7\mu\text{m}$
3520-100	75-100mm/3-4"	C	75mm (optional)	$\pm 8\mu\text{m}$

## 7 INTERNAL GEAR TOOTH MICROMETERS

**INSIZE PLUS**  
MADE IN EUROPE

INSPECTION  
CERTIFICATE

- Measure over-pin diameter of gears
- Graduation: 0.01mm
- Ratchet stop
- Optional accessory: ball tips (code 7383), cylindrical tips (code 7393, only for micrometers with L=8mm)

before ball tips  
are installed



ball tips are optional



3678-50

cylindrical tips (optional)  
(only for micrometers  
with L=8mm)



Code	Range	Accuracy	L
3678-50*	25-50mm	4 $\mu\text{m}$	6mm
3678-75*	50-75mm	5 $\mu\text{m}$	8mm

\*Supplied with manufacturer inspection certificate

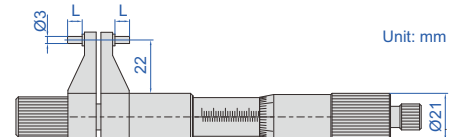
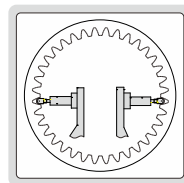

## TUBULAR INSIDE MICROMETERS

- Graduation 0.01mm
- Accuracy:  $(6+L/50)\mu\text{m}$   
L=maximum measuring length (mm)
- Optional accessory: setting ring (code 6312), gage block accessory (code 6881), cylinder gage block (code 4001), caliper/height gage checker (code 6884)



3221-200

Code	Range	Travel of micrometer head	Extension rods
3221-32	25-32mm	7mm	—
3221-50	25-50mm	7mm	2 pcs
3221-63	50-63mm	13mm	—
3221-200	50-200mm	13mm	6 pcs
3221-300	50-300mm	13mm	10 pcs
3221-225	200-225mm	25mm	—
3221-500	200-500mm	25mm	3 pcs
3221-1000	200-1000mm	25mm	8 pcs

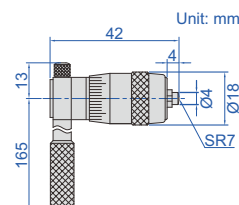

application

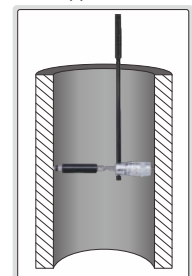

## TUBULAR INSIDE MICROMETERS

- Micrometers up to 500mm meet DIN863-4
- Graduation 0.01mm
- Carbide measuring faces
- Optional accessory: gage block accessory (code **6881**), cylinder gage block (code **4001**), caliper/height gage checker (code **6884**)



**3229-225**

Code	Range	Type	Accuracy
3229-75	50-75mm	A	5μm
3229-100	75-100mm	B	5μm
3229-125	100-125mm	C	6μm
3229-150	125-150mm	C	6μm
3229-175	150-175mm	C	7μm
3229-200	175-200mm	C	7μm
3229-225	200-225mm	C	8μm
3229-250	225-250mm	C	8μm
3229-275	250-275mm	C	9μm
3229-300	275-300mm	C	9μm
3229-325	300-325mm	C	9μm
3229-350	325-350mm	C	9μm
3229-375	350-375mm	C	10μm
3229-400	375-400mm	C	10μm
3229-425	400-425mm	C	10μm
3229-450	425-450mm	C	10μm
3229-475	450-475mm	C	11μm
3229-500	475-500mm	C	11μm
3229-525	500-525mm	C	11μm
3229-550	525-550mm	C	11μm
3229-575	550-575mm	C	11μm
3229-600	575-600mm	C	12μm
3229-625	600-625mm	C	12μm
3229-650	625-650mm	C	12μm
3229-675	650-675mm	C	13μm
3229-700	675-700mm	C	13μm

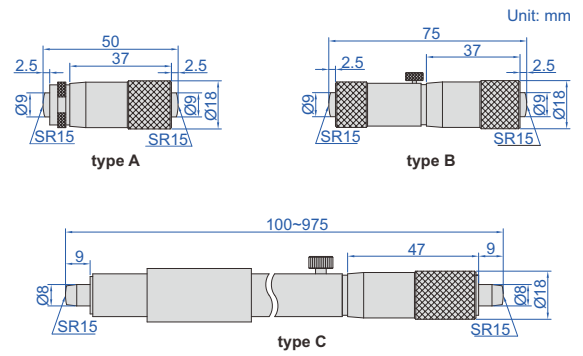

Code	Range	Type	Accuracy
3229-725	700-725mm	C	13μm
3229-750	725-750mm	C	14μm
3229-775	750-775mm	C	14μm
3229-800	775-800mm	C	14μm
3229-825	800-825mm	C	15μm
3229-850	825-850mm	C	15μm
3229-875	850-875mm	C	15μm
3229-900	875-900mm	C	16μm
3229-925	900-925mm	C	16μm
3229-950	925-950mm	C	16μm
3229-975	950-975mm	C	17μm
3229-1000	975-1000mm	C	17μm

## TUBULAR INSIDE MICROMETERS



**3224-2000**

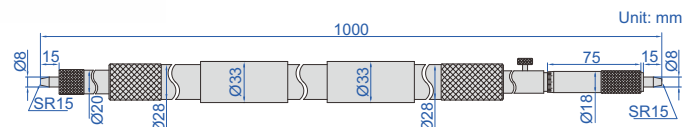

Code	Range	Extension rods
3224-2000	1000-2000mm	50mm, 100mm (2 pcs), 200mm, 500mm
3224-3000	1000-3000mm	50mm, 100mm (2 pcs), 200mm, 500mm, 1000mm
3224-4000	1000-4000mm	50mm, 100mm (2 pcs), 200mm, 500mm, 1000mm (2 pcs)
3224-5000	1000-5000mm	50mm, 100mm (2 pcs), 200mm, 500mm, 1000mm (3 pcs)

- Micrometer head: 1000-1050mm
- Graduation 0.01mm
- Accuracy:  $(7+n+L/50)\mu\text{m}$   
n=number of rods  
L=maximum measuring length (mm)
- Travel of micrometer head 50mm
- Carbide measuring faces

## TUBULAR INSIDE MICROMETERS

- Micrometer head: 50-63mm
- Graduation 0.01mm
- Accuracy:  $(3+n+L/50)\mu\text{m}$   
n=number of rods  
L=maximum measuring length (mm)
- Supplied with setting standards
- Carbide measuring faces



**3222-150**

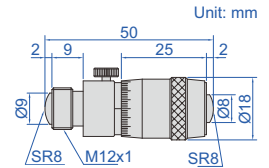

Code	Range	Travel of micrometer head	Extension rods
3222-63	50-63mm	13mm	—
3222-150	50-150mm	13mm	13mm, 25mm, 50mm
3222-300	50-300mm	13mm	13mm, 25mm, 50mm (2 pcs), 100mm
3222-500	50-500mm	13mm	13mm, 25mm, 50mm (2 pcs), 100mm, 200mm
3222-600	50-600mm	13mm	13mm, 25mm, 50mm, 100mm, 150mm, 200mm
3222-1000	50-1000mm	13mm	13mm, 25mm, 50mm (2 pcs), 100mm, 200mm (2 pcs), 300mm
3222-1500	50-1500mm	13mm	13mm, 25mm, 50mm (2 pcs), 100mm, 200mm (3 pcs), 300mm (2 pcs)

## TUBULAR INSIDE MICROMETERS

**INSIZE PLUS**  
MADE IN EUROPE



**3684-100**

- Micrometer head: 50-75mm
- Graduation: 0.01mm
- Carbide measuring faces

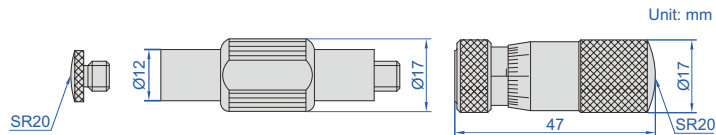

Code	Range	Accuracy	Travel of micrometer head	Extension rods
3684-75	50-75mm	5 $\mu\text{m}$	25mm	—
3684-100	50-100mm	5 $\mu\text{m}$	25mm	25mm
3684-150	50-150mm	6 $\mu\text{m}$	25mm	25mm, 50mm
3684-250	50-250mm	8 $\mu\text{m}$	25mm	25mm, 50mm, 100mm
3684-300	50-300mm	9 $\mu\text{m}$	25mm	25mm, 50mm (2 pcs), 100mm
3684-350	50-350mm	10 $\mu\text{m}$	25mm	25mm, 50mm, 100mm (2 pcs)
3684-450	50-450mm	10 $\mu\text{m}$	25mm	25mm, 50mm, 100mm, 200mm
3684-650	50-650mm	12 $\mu\text{m}$	25mm	25mm, 50mm, 100mm, 200mm (2 pcs)
3684-850	50-850mm	15 $\mu\text{m}$	25mm	25mm, 50mm, 100mm, 200mm, 400mm
3684-1250	50-1250mm	20 $\mu\text{m}$	25mm	25mm, 50mm, 100mm, 200mm, 400mm (2 pcs)
3684-1450	50-1450mm	22 $\mu\text{m}$	25mm	25mm, 50mm, 100mm, 200mm, 400mm, 600mm

## TUBULAR INSIDE MICROMETERS

**INSIZE PLUS**  
MADE IN EUROPE



3683-200

- Micrometer head: 100-150mm
- Graduation: 0.01mm
- Carbide measuring faces
- Heat insulation extension rods

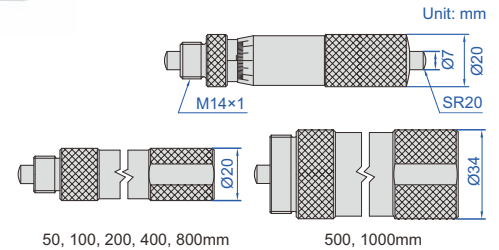

Code	Range	Accuracy	Travel of micrometer head	Heat insulation extension rods
3683-150	100-150mm	6μm	50mm	—
3683-200	100-200mm	7μm	50mm	50mm
3683-300	100-300mm	9μm	50mm	50mm, 100mm
3683-500	100-500mm	13μm	50mm	50mm, 100mm, 200mm
3683-900	100-900mm	16μm	50mm	50mm, 100mm, 200mm, 400mm
3683-1300	100-1300mm	22μm	50mm	50mm, 100mm, 200mm, 400mm (2 pcs)
3683-1700	100-1700mm	27μm	50mm	50mm, 100mm, 200mm, 400mm, 800mm
3683-2000	100-2000mm	32μm	50mm	50mm, 100mm, 200mm (2 pcs), 500mm, 1000mm
3683-2100	100-2100mm	32μm	50mm	50mm, 100mm, 200mm, 400mm (2 pcs), 800mm
3683-2500	100-2500mm	40μm	50mm	50mm, 100mm, 200mm, 400mm, 800mm (2 pcs)
3683-3000	100-3000mm	50μm	50mm	50mm, 100mm, 200mm (2 pcs), 500mm, 1000mm (2 pcs)
3683-4000	100-4000mm	60μm	50mm	50mm, 100mm, 200mm (2 pcs), 500mm, 1000mm (3 pcs)
3683-5000	100-5000mm	72μm	50mm	50mm, 100mm, 200mm (2 pcs), 500mm, 1000mm (4 pcs)
3683-6000	100-6000mm	90μm	50mm	50mm, 100mm, 200mm (2 pcs), 500mm, 1000mm (5 pcs)

## TUBULAR INSIDE MICROMETERS

- Micrometer head: 100-125mm
- Graduation 0.01mm
- Accuracy:  $(3+n+L/50)\mu\text{m}$   
n=number of rods  
L=maximum measuring length (mm)
- Travel of micrometer head 25mm
- Supplied with setting standards
- Carbide measuring faces



3225-500

Code	Range	Extension rods
3225-125	100-125mm	—
3225-500	100-500mm	25mm, 50mm, 100mm, 200mm
3225-900	100-900mm	25mm, 50mm, 100mm, 200mm, 400mm
3225-1300	100-1300mm	25mm, 50mm, 100mm, 200mm, 400mm (2 pcs)
3225-1700	100-1700mm	25mm, 50mm, 100mm, 200mm, 400mm (3 pcs)
3225-2100	100-2100mm	25mm, 50mm, 100mm, 200mm, 400mm (4 pcs)

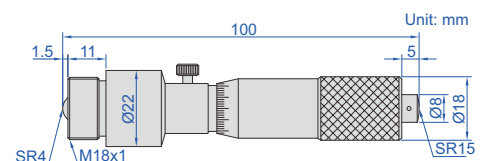

## DIGITAL TUBULAR INSIDE MICROMETERS

**IP65**  
WATERPROOF

**DATA**  
OUTPUT

- Micrometer head: 150-175mm
- Resolution: 0.001mm/0.00005"
- Accuracy:  $(3+n+L/50)\mu\text{m}$   
n=number of rods  
L=maximum measuring length (mm)
- Carbide measuring faces
- The diameter of extension rods is 22mm
- IP65 dust/waterproof
- Button function: on/off, set, mm/inch, data transmit
- Data output
- Automatic power off
- Supplied with setting standards
- Optional accessory: data output cable (code 7315-31 need receiver page 4, 7302-31 page 12)

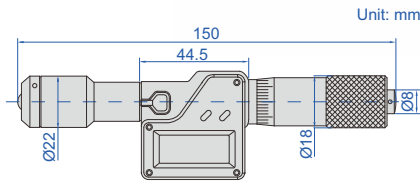

3521-1000

Code	Range	Travel of micrometer head	Extension rods
3521-175	150-175mm	25mm	—
3521-1000	150-1000mm	25mm	25mm, 50mm (2 pcs), 100mm, 200mm, 400mm
3521-1500	150-1500mm	25mm	25mm, 50mm (2 pcs), 100mm (2 pcs), 200mm, 400mm (2 pcs)
3521-2000	150-2000mm	25mm	25mm, 50mm (2 pcs), 100mm, 200mm (2 pcs), 400mm (3 pcs)

## TUBULAR INSIDE MICROMETERS

**INSIZE PLUS**  
MADE IN EUROPE

- Carbide measuring faces for micrometer head and extension rods
- Points of extension rods are spring loaded
- Optional accessory:  
gage block accessory (code 6881),  
cylinder gage block (code 4001),  
caliper/height gage checker (code 6884)



3634-1300

### Micrometer head

Range	Graduation	Accuracy	Weight
100-125mm	0.01mm	$\pm 4\mu\text{m}$	154g

### Extension rods

Length (L)	Accuracy	Weight	Material
25mm	$\pm 1.25\mu\text{m}$	37g	steel
50mm	$\pm 1.25\mu\text{m}$	65g	steel
100mm	$\pm 2\mu\text{m}$	113g	steel
200mm	$\pm 3.5\mu\text{m}$	208g	steel
400mm	$\pm 4.5\mu\text{m}$	402g	steel
1000mm	$\pm 7.5\mu\text{m}$	909g	carbon fiber

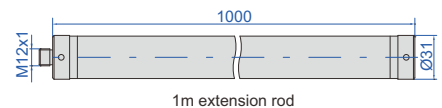
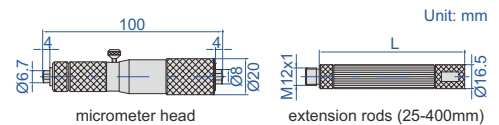

Code	Range	Extension rods
3634-350	100-350mm	25mm, 200mm
3634-500	100-500mm	25mm, 50mm, 100mm, 200mm
3634-1300	100-1300mm	25mm, 50mm, 100mm, 200mm, 400mm (2 pcs)
3634-1500	100-1500mm	25mm, 50mm, 100mm, 200mm (2 pcs), 400mm (2 pcs)
3634-2100	100-2100mm	25mm, 50mm, 100mm, 200mm, 400mm (4 pcs)
3634-3100	100-3100mm	25mm, 50mm, 100mm, 200mm (2 pcs), 400mm, 1000mm (2 pcs)
3634-4100	100-4100mm	25mm, 50mm, 100mm, 200mm (2 pcs), 400mm, 1000mm (3 pcs)
3634-5100	100-5100mm	25mm, 50mm, 100mm, 200mm (2 pcs), 400mm, 1000mm (4 pcs)
3634-6100	100-6100mm	25mm, 50mm, 100mm, 200mm (2 pcs), 400mm, 1000mm (5 pcs)

1m carbon fiber extension rod,  
light weight, no deform

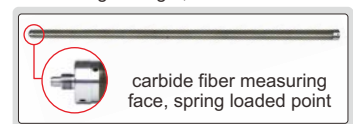



DATA  
OUTPUT

SPRING LOADED  
MEASURING POINT

## DIGITAL NON-ROTATING SPINDLE TUBULAR INSIDE MICROMETERS

**INSIZE PLUS**  
MADE IN EUROPE

NON-ROTATING  
SPINDLE

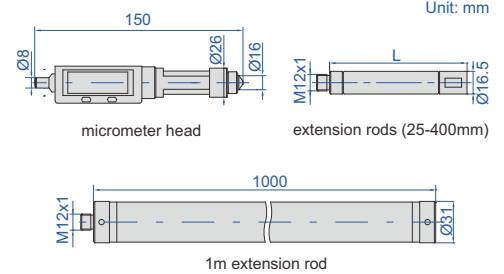

- Carbide measuring faces for micrometer head and extension rods
- Points of extension rods are spring loaded
- Data output
- Button function: mm/inch, max./min. value tracking, preset value, hold, on/off, zero
- CR2032 battery, automatic power off, turn the sleeve to turn on
- Optional accessory: data output cable (code **7315-80** need receiver page 5, **7302-80**), gage block accessory (code **6881**), cylinder gage block (code **4001**), caliper/height gage checker (code **6884**)

1m carbon fiber extension rod,  
light weight, no deform

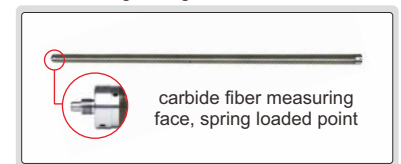

non-rotating spindle, spring loaded point  
and max./min. value tracking make it  
easy to find the right measuring position

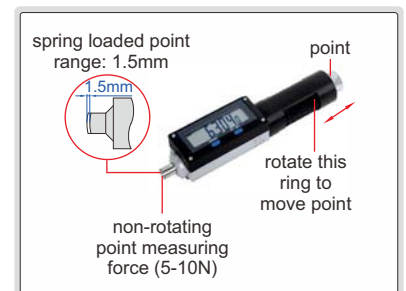

### Extension rods

Length (L)	Accuracy	Weight	Material
25mm	±1.25µm	37g	steel
50mm	±1.25µm	65g	steel
100mm	±2µm	113g	steel
200mm	±3.5µm	208g	steel
400mm	±4.5µm	402g	steel
1000mm	±7.5µm	909g	carbon fiber

### Micrometer head

Range	Resolution	Accuracy	Repeatability	Measuring force	Weight
150-180mm	0.001mm/0.00005" 0.01mm/0.0005" 0.0005mm/0.00002" (switchable)	±4µm	1µm	5-10N	275g

Code	Range	Extension rods
3635-350	150-350mm	25mm, 50mm, 100mm
3635-550	150-550mm	25mm, 50mm, 100mm, 200mm
3635-950	150-950mm	25mm, 50mm, 100mm, 200mm, 400mm
3635-1550	150-1550mm	25mm, 50mm, 100mm, 200mm (2 pcs), 400mm (2 pcs)
3635-2150	150-2150mm	25mm, 50mm, 100mm, 200mm, 400mm (4 pcs)
3635-3150	150-3150mm	25mm, 50mm, 100mm, 200mm (2 pcs), 400mm, 1000mm (2 pcs)
3635-4150	150-4150mm	25mm, 50mm, 100mm, 200mm (2 pcs), 400mm, 1000mm (3 pcs)
3635-5150	150-5150mm	25mm, 50mm, 100mm, 200mm (2 pcs), 400mm, 1000mm (4 pcs)
3635-6150	150-6150mm	25mm, 50mm, 100mm, 200mm (2 pcs), 400mm, 1000mm (5 pcs)

## INTERNAL GEAR TOOTH MICROMETERS

**INSIZE PLUS**  
MADE IN EUROPE



3638-200

- Measure over-pin diameter of gears
- Points of extension rods are spring loaded
- Optional accessory: ball tips (code 7383)

### Micrometer head

Range	Graduation	Accuracy
100-115mm	0.01mm	±4µm
150-175mm	0.01mm	±4µm

### Extension rod

Length (L)	Accuracy
15mm	±1µm
25mm	±1.25µm
30mm	±1.25µm
50mm	±1.25µm
100mm	±2µm
200mm	±3.5µm
400mm	±4.5µm

Code	Range	Micrometer head	Extension rod (L)
3638-200	100-205mm	100-115mm	15mm, 25mm, 50mm
3638-500	100-505mm	100-115mm	15mm, 25mm, 50mm, 100mm, 200mm
3638-900	100-905mm	100-115mm	15mm, 25mm, 50mm, 100mm, 200mm, 400mm
3638-1100	150-1150mm	150-175mm	25mm, 50mm, 100mm, 200mm, 200mm, 400mm

7

## INTERNAL SCREW THREAD MICROMETERS

**INSIZE PLUS**  
MADE IN EUROPE



3641-200

- Measure pitch diameter of screw thread
- Points of extension rods are spring loaded
- Optional accessory: measuring tips for internal screw thread micrometer (code 7385, L=13.5mm)

### Micrometer head

Range	Graduation	Accuracy
100-115mm	0.01mm	±4µm
150-175mm	0.01mm	±4µm

### Extension rod

Length (A)	Accuracy
15mm	±1µm
25mm	±1.25µm
50mm	±1.25µm
100mm	±2µm
200mm	±3.5µm
400mm	±4.5µm

Code	Range	Micrometer head	Extension rod (A)	Applicable tips
3641-200	100-205mm	100-115mm	15mm, 25mm, 50mm	stem length L=13.5mm
3641-500	100-505mm	100-115mm	15mm, 25mm, 50mm, 100mm, 200mm	stem length L=13.5mm
3641-900	100-905mm	100-115mm	15mm, 25mm, 50mm, 100mm, 200mm, 400mm	stem length L=13.5mm
3641-1100	150-1150mm	150-175mm	25mm, 50mm, 100mm, 200mm, 200mm, 400mm	stem length L=13.5mm



TIPS FOR TRAPEZOIDAL, ACME  
THREAD ARE ALSO AVAILABLE

## MEASURING TIPS FOR INTERNAL SCREW THREAD MICROMETERS

**INSIZE PLUS**  
MADE IN EUROPE

- Supplied in pair
- Made of hardened steel
- Suitable for 3641 series micrometers



7385-T106A

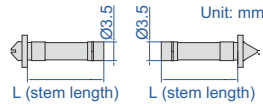

7385-T106B

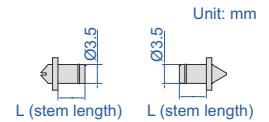

### 60° thread angle

Code		Applicable pitch (mm)
L=13.5mm	L=5mm	
7385-T101A	7385-T101B	0.35
7385-T102A	7385-T102B	0.4/0.45
7385-T103A	7385-T103B	0.5/0.6
7385-T104A	7385-T104B	0.7/0.75/0.8
7385-T105A	7385-T105B	1/1.25
7385-T106A	7385-T106B	1.5/1.75
7385-T107A	7385-T107B	2.0/2.5
7385-T108A	7385-T108B	3.0/3.5
7385-T109A	7385-T109B	4.0/4.5/5.0
7385-T110A	7385-T110B	5.5/6.0

### 55° thread angle

Code		Applicable pitch (TPI)
L=13.5mm	L=5mm	
7385-T201A	7385-T201B	60/48
7385-T202A	7385-T202B	40/32
7385-T203A	7385-T203B	28/26/24/22
7385-T204A	7385-T204B	20/19/18/16
7385-T205A	7385-T205B	14/12/11
7385-T206A	7385-T206B	10/9/8
7385-T207A	7385-T207B	7/6
7385-T208A	7385-T208B	5/4.5/4
7385-T209A	7385-T209B	3.5/3.25/3/2.875/2.75
7385-T210A	7385-T210B	2.625/2.5/2

## INTERNAL SCREW THREAD MICROMETERS

- Graduation: 0.01mm
- Optional accessory: measuring tips for internal screw thread micrometer (code 7321)

Code	Range	Code	Range
3226-1001	75-100mm	3226-2251	200-225mm
3226-1251	100-125mm	3226-2501	225-250mm
3226-1501	125-150mm	3226-2751	250-275mm
3226-1751	150-175mm	3226-3001	275-300mm
3226-2001	175-200mm		



3226-1001

measuring tips for internal screw thread micrometer (optional)



## MEASURING TIPS FOR INTERNAL SCREW THREAD MICROMETERS

- Supplied in pair
- Suitable for 3226 series micrometers

### Metric and unified screw (60° thread angle)

Code	Pitch
7321-T11	0.4-0.5mm/64-48TPI
7321-T12	0.6-0.9mm/44-28TPI
7321-T13	1-1.75mm/24-14TPI
7321-T14	2-3mm/13-9TPI
7321-T15	3.5-5mm/8-5TPI
7321-T16	5.5-7mm/4.5-3.5TPI
7321-T1S	6 pairs/set, including all above tips



7321-T1S

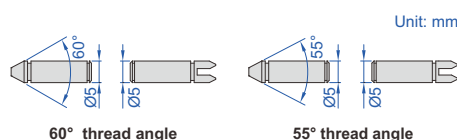

60° thread angle

55° thread angle

### Whitworth screw (55° thread angle)

Code	Pitch
7321-T21	60-48TPI
7321-T22	48-40TPI
7321-T23	40-32TPI
7321-T24	32-24TPI
7321-T25	24-18TPI
7321-T26	18-14TPI
7321-T27	14-10TPI
7321-T28	10-7TPI
7321-T29	7-4.5TPI
7321-T210	4.5-3.5TPI
7321-T2S	10 pairs/set, including all above tips

## TWO POINTS/THREE POINTS INTERNAL MICROMETERS

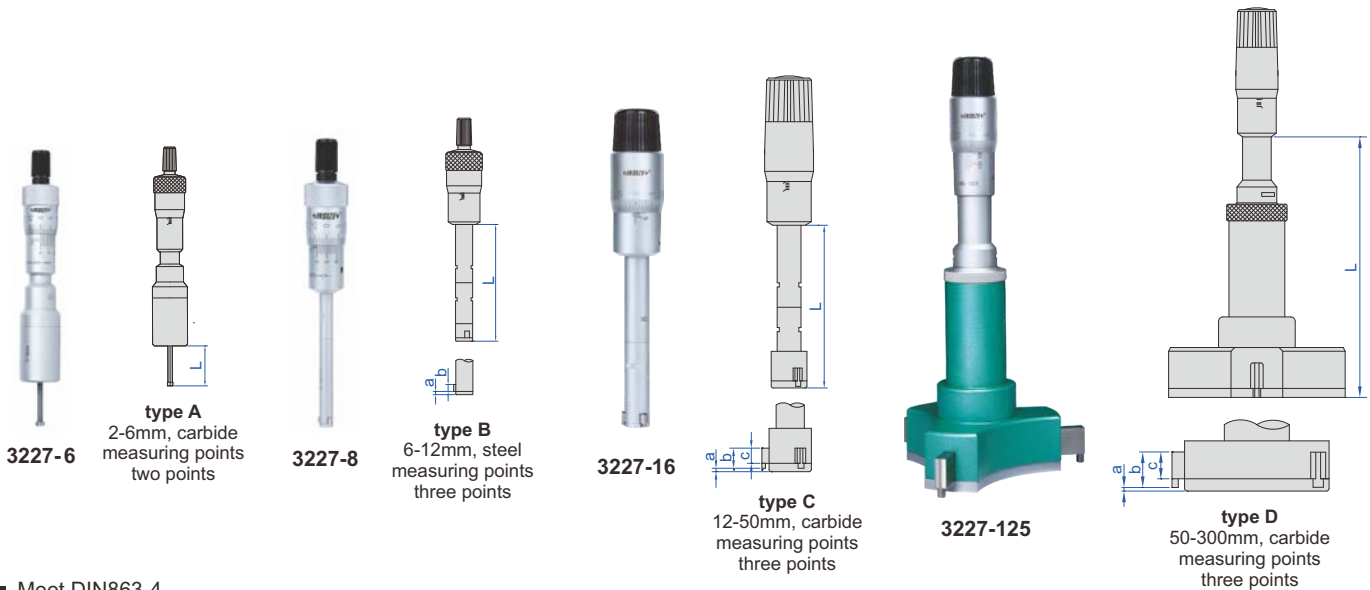

- Meet DIN863-4
- 2-12mm: graduation 0.001mm  
12-300mm: graduation 0.005mm
- Ratchet stop
- Optional accessory: setting rings (code **6312**), micrometer stand and clamp (code **6301** and **6301-2**)

### Individual

(mm)

Code	Range	Type	Accuracy	Setting ring	Extension rod (included)	L	a	b	c
<b>3227-2 *</b>	2-2.5mm	A (two points)	6µm	Ø2.5 (included)	—	12	—	—	—
<b>3227-3 *</b>	2.5-3mm	A (two points)	6µm	Ø2.5 (included)	—	12	—	—	—
<b>3227-4 *</b>	3-4mm	A (two points)	6µm	Ø4 (included)	—	22	—	—	—
<b>3227-5 *</b>	4-5mm	A (two points)	6µm	Ø5 (included)	—	22	—	—	—
<b>3227-6 *</b>	5-6mm	A (two points)	6µm	Ø6 (included)	—	22	—	—	—
<b>3227-8 *</b>	6-8mm	B (three points)	4µm	Ø6 (included)	100	54.5	1.5	2.5	—
<b>3227-10 *</b>	8-10mm	B (three points)	4µm	Ø8 (included)	100	54.5	1.5	2.5	—
<b>3227-12 *</b>	10-12mm	B (three points)	4µm	Ø10 (included)	100	54.5	1.5	2.5	—
<b>3227-16 *</b>	12-16mm	C (three points)	4µm	Ø16 (included)	150	80	0.5	6	4.5
<b>3227-20 *</b>	16-20mm	C (three points)	4µm	Ø16 (included)	150	80	0.5	6	4.5
<b>3227-25 *</b>	20-25mm	C (three points)	4µm	Ø25 (included)	150	90	0.5	8	6
<b>3227-30 *</b>	25-30mm	C (three points)	4µm	Ø25 (included)	150	90	0.5	8	6
<b>3227-40 *</b>	30-40mm	C (three points)	4µm	Ø40 (included)	150	97	0.5	14	12
<b>3227-50 *</b>	40-50mm	C (three points)	5µm	Ø40 (included)	150	97	0.5	14	12
<b>3227-63 *</b>	50-63mm	D (three points)	5µm	Ø62 (included)	150	114	0.5	17.5	14.5
<b>3227-75 *</b>	62-75mm	D (three points)	5µm	Ø62 (included)	150	114	0.5	17.5	14.5
<b>3227-88 *</b>	75-88mm	D (three points)	5µm	Ø87 (included)	150	114	0.5	17.5	14.5
<b>3227-100 *</b>	87-100mm	D (three points)	5µm	Ø87 (included)	150	114	0.5	17.5	14.5
<b>3227-125 *</b>	100-125mm	D (three points)	6µm	<b>optional</b>	150	140	0.9	29	25
<b>3227-150 *</b>	125-150mm	D (three points)	6µm	<b>optional</b>	150	140	0.9	29	25
<b>3227-175 *</b>	150-175mm	D (three points)	7µm	<b>optional</b>	150	140	0.9	29	25
<b>3227-200 *</b>	175-200mm	D (three points)	7µm	<b>optional</b>	150	140	0.9	29	25
<b>3227-225</b>	200-225mm	D (three points)	8µm	<b>optional</b>	150	140	0.9	29	25
<b>3227-250</b>	225-250mm	D (three points)	8µm	<b>optional</b>	150	140	0.9	29	25
<b>3227-275</b>	250-275mm	D (three points)	9µm	<b>optional</b>	150	140	0.9	29	25
<b>3227-300</b>	275-300mm	D (three points)	9µm	<b>optional</b>	150	140	0.9	29	25

To be continued

Continued from previous page



micrometer stand with clamp (optional)



setting ring

2-100mm: included  
100-300mm: optional

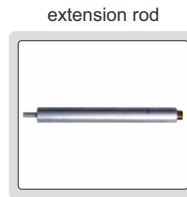

extension rod

included



3227-504

Set

Code	Range	Micrometers included	Setting ring (included)	Extension rod (included)
3227-232 *	2-3mm	2-2.5mm, 2.5-3mm	Ø2.5mm	—
3227-363 *	3-6mm	3-4mm, 4-5mm, 5-6mm	Ø4mm, Ø5mm, Ø6mm	—
3227-123 *	6-12mm	6-8mm, 8-10mm, 10-12mm	Ø6mm, Ø8mm, Ø10mm	100mm
3227-202 *	12-20mm	12-16mm, 16-20mm	Ø16mm	150mm
3227-504 *	20-50mm	20-25mm, 25-30mm, 30-40mm, 40-50mm	Ø25mm, Ø40mm	150mm
3227-1004 *	50-100mm	50-63mm, 62-75mm, 75-88mm, 87-100mm	Ø62mm, Ø87mm	150mm

\* Supplied with manufacturer inspection certificate

IP65  
WATERPROOF

DATA  
OUTPUT

DIGITAL TWO POINTS/THREE POINTS INTERNAL MICROMETERS

INSPECTION  
CERTIFICATE



3127-5

**type A**  
2-6mm, carbide  
measuring points  
two points



3127-12

**type B**  
6-12mm, steel  
measuring points  
three points



3127-40

**type C**  
12-50mm, carbide  
measuring points  
three points



3127-125

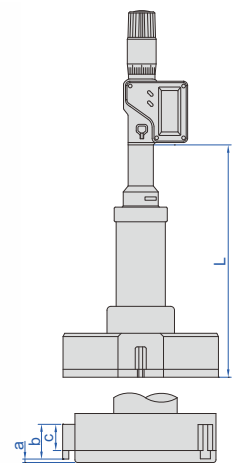

**type D**  
50-300mm, carbide  
measuring points  
three points

- Resolution 0.001mm/0.00005" (resolution of 3127-275 and 3127-300 is 0.001mm/0.0001")
- IP65 dust/waterproof
- Buttons: on/off, set, mm/inch, data transmit
- Data output
- Automatic power off
- Ratchet stop
- Optional accessory: data output cable (code 7315-31 need receiver page 4, 7302-31 page 12), setting ring (code 6312), micrometer stand and clamp (code 6301 and 6301-2)

To be continued

Continued from previous page

micrometer stand with clamp (optional)



setting ring



2-100mm: included  
100-300mm: optional

extension rod

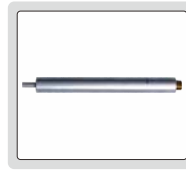

included



3127-202

7

Individual

(mm)

Code	Range	Type	Accuracy	Setting ring	Extension rod (included)	L	a	b	c
3127-2*	2-2.5mm/0.08-0.10"	A (two points)	6µm	Ø2.5 (included)	—	12	—	—	—
3127-3*	2.5-3mm/0.10-0.12"	A (two points)	6µm	Ø2.5 (included)	—	12	—	—	—
3127-4*	3-4mm/0.12-0.16"	A (two points)	6µm	Ø4 (included)	—	22	—	—	—
3127-5*	4-5mm/0.16-0.20"	A (two points)	6µm	Ø5 (included)	—	22	—	—	—
3127-6*	5-6mm/0.20-0.24"	A (two points)	6µm	Ø6 (included)	—	22	—	—	—
3127-8*	6-8mm/0.24-0.31"	B (three points)	4µm	Ø6 (included)	100	57	1.5	2.5	—
3127-10*	8-10mm/0.31-0.39"	B (three points)	4µm	Ø8 (included)	100	57	1.5	2.5	—
3127-12*	10-12mm/0.39-0.47"	B (three points)	4µm	Ø10 (included)	100	57	1.5	2.5	—
3127-16*	12-16mm/0.47-0.63"	C (three points)	4µm	Ø16 (included)	150	99	0.5	6	4.5
3127-20*	16-20mm/0.63-0.79"	C (three points)	4µm	Ø16 (included)	150	99	0.5	6	4.5
3127-25*	20-25mm/0.79-0.98"	C (three points)	4µm	Ø25 (included)	150	105	0.5	8	6
3127-30*	25-30mm/0.98-1.18"	C (three points)	4µm	Ø25 (included)	150	105	0.5	8	6
3127-40*	30-40mm/1.18-1.57"	C (three points)	4µm	Ø40 (included)	150	110	0.5	14	12
3127-50*	40-50mm/1.57-1.97"	C (three points)	5µm	Ø40 (included)	150	110	0.5	14	12
3127-63*	50-63mm/1.97-2.48"	D (three points)	5µm	Ø62 (included)	150	127	0.5	17.5	14.5
3127-75*	62-75mm/2.44-2.95"	D (three points)	5µm	Ø62 (included)	150	127	0.5	17.5	14.5
3127-88*	75-88mm/2.95-3.46"	D (three points)	5µm	Ø87 (included)	150	127	0.5	17.5	14.5
3127-100*	87-100mm/3.43-3.94"	D (three points)	5µm	Ø87 (included)	150	127	0.5	17.5	14.5
3127-125*	100-125mm/3.94-4.92"	D (three points)	6µm	optional	150	175	0.9	29	25
3127-150*	125-150mm/4.92-5.91"	D (three points)	6µm	optional	150	175	0.9	29	25
3127-175*	150-175mm/5.91-6.89"	D (three points)	7µm	optional	150	175	0.9	29	25
3127-200*	175-200mm/6.89-7.87"	D (three points)	7µm	optional	150	175	0.9	29	25
3127-225	200-225mm/7.87-8.86"	D (three points)	8µm	optional	150	175	0.9	29	25
3127-250	225-250mm/8.86-9.84"	D (three points)	8µm	optional	150	175	0.9	29	25
3127-275	250-275mm/9.84-10.83"	D (three points)	9µm	optional	150	175	0.9	29	25
3127-300	275-300mm/10.83-11.81"	D (three points)	9µm	optional	150	175	0.9	29	25

Set

Code	Range	Micrometers included	Setting ring (included)	Extension rod (included)
3127-232*	2-3mm/0.08-0.12"	2-2.5mm, 2.5-3mm	Ø2.5mm	—
3127-363*	3-6mm/0.12-0.24"	3-4mm, 4-5mm, 5-6mm	Ø4mm, Ø5mm, Ø6mm	—
3127-123*	6-12mm/0.24-0.47"	6-8mm, 8-10mm, 10-12mm	Ø6mm, Ø8mm, Ø10mm	100mm
3127-202*	12-20mm/0.47-0.79"	12-16mm, 16-20mm	Ø16mm	150mm
3127-504*	20-50mm/0.79-1.97"	20-25mm, 25-30mm, 30-40mm, 40-50mm	Ø25mm, Ø40mm	150mm
3127-1004*	50-100mm/1.97-3.94"	50-63mm, 62-75mm, 75-88mm, 87-100mm	Ø62mm, Ø87mm	150mm

\*Supplied with manufacturer inspection certificate



## WIDE RANGE THREE POINTS INTERNAL MICROMETERS

- Meet DIN863-4
- Graduation 0.001mm
- Carbide measuring faces
- Ratchet stop
- Setting rings are included (except 200-300mm)

Code	Range	Accuracy	Setting ring
<b>3228-70*</b>	50-70mm	5µm	Ø50mm (included)
<b>3228-100*</b>	70-100mm	5µm	Ø70mm (included)
<b>3228-150*</b>	100-150mm	6µm	Ø100mm (included)
<b>3228-250*</b>	150-250mm	8µm	Ø150mm (included)
<b>3228-300*</b>	200-300mm	9µm	Ø200mm (optional)

\*Supplied with manufacturer inspection certificate



3228-70

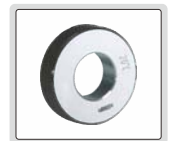
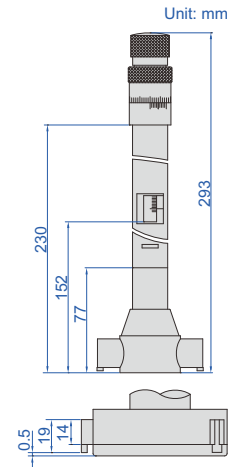

setting ring



## DIGITAL WIDE RANGE THREE POINTS INTERNAL MICROMETERS



- Meet DIN863-4
- Resolution 0.001mm/0.00005" (resolution of **3128-300** is 0.001mm/0.0001")
- IP54 dust/waterproof
- Buttons: on/off, set, mm/inch
- Data output
- Automatic power off
- Carbide measuring faces
- Ratchet stop
- Supplied with extension rods
- Setting rings are included (except 200-300mm)
- Optional accessory: data output cable (code **7315-30** need receiver page 4, **7302-30** page 12)



3128-150

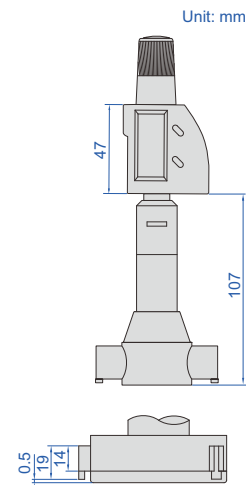

Code	Range	Accuracy	Setting ring	Extension rod (included)
<b>3128-70*</b>	50-70mm/1.97-2.76"	5µm	Ø50mm (included)	150mm
<b>3128-100*</b>	70-100mm/2.76-3.94"	5µm	Ø70mm (included)	150mm
<b>3128-150*</b>	100-150mm/3.94-5.91"	6µm	Ø100mm (included)	150mm
<b>3128-250*</b>	150-250mm/5.91-9.84"	8µm	Ø150mm (included)	150mm
<b>3128-300*</b>	200-300mm/7.87-11.81"	9µm	Ø200mm (optional)	150mm

\*Supplied with manufacturer inspection certificate



setting ring



extension rod (included)

## PISTOL GRIP THREE POINTS BORE GAGES

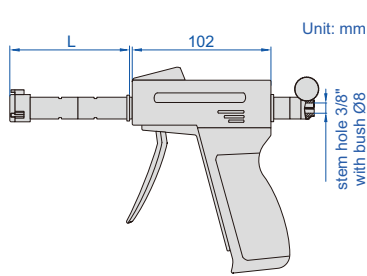

- Optional accessory: digital indicators (code **2108-101F**, resolution 0.001mm/0.00005"), setting rings (code **6312**)

setting ring



6-100mm: included  
100-300mm: **optional**

extension rod



included

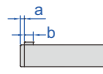

**type A**  
6-12mm, steel measuring points



2124-8

digital indicator is optional

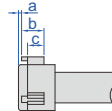

**type B**  
12-50mm, carbide measuring points



2124-25

digital indicator is optional

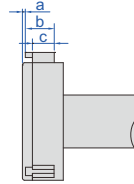

**type C**  
50-300mm, carbide measuring points



2124-125

digital indicator is optional

### Individual

Code	Range	Type	Accuracy (without digital indicator)	Setting ring	Extension rod (included)	L	a	b	c
2124-8 *	6-8mm	A	4µm	Ø6mm (included)	100mm	50	1.5	2.5	—
2124-10 *	8-10mm	A	4µm	Ø8mm (included)	100mm	50	1.5	2.5	—
2124-12 *	10-12mm	A	4µm	Ø10mm (included)	100mm	50	1.5	2.5	—
2124-16 *	12-16mm	B	4µm	Ø16mm (included)	150mm	65	0.5	6	4.5
2124-20 *	16-20mm	B	4µm	Ø16mm (included)	150mm	65	0.5	6	4.5
2124-25 *	20-25mm	B	4µm	Ø25mm (included)	150mm	91	0.5	8	6
2124-30 *	25-30mm	B	4µm	Ø25mm (included)	150mm	91	0.5	8	6
2124-40 *	30-40mm	B	4µm	Ø40mm (included)	150mm	97	0.5	14	12
2124-50 *	40-50mm	B	5µm	Ø40mm (included)	150mm	97	0.5	14	12
2124-63 *	50-63mm	C	5µm	Ø62mm (included)	150mm	112	0.5	17.5	14.5
2124-75 *	62-75mm	C	5µm	Ø62mm (included)	150mm	112	0.5	17.5	14.5
2124-88 *	75-88mm	C	5µm	Ø87mm (included)	150mm	112	0.5	17.5	14.5
2124-100 *	87-100mm	C	5µm	Ø87mm (included)	150mm	112	0.5	17.5	14.5
2124-125 *	100-125mm	C	6µm	<b>optional</b>	150mm	140	0.9	29	25
2124-150 *	125-150mm	C	6µm	<b>optional</b>	150mm	140	0.9	29	25
2124-175 *	150-175mm	C	7µm	<b>optional</b>	150mm	140	0.9	29	25
2124-200 *	175-200mm	C	7µm	<b>optional</b>	150mm	140	0.9	29	25
2124-225	200-225mm	C	8µm	<b>optional</b>	150mm	140	0.9	29	25
2124-250	225-250mm	C	8µm	<b>optional</b>	150mm	140	0.9	29	25
2124-275	250-275mm	C	9µm	<b>optional</b>	150mm	140	0.9	29	25
2124-300	275-300mm	C	9µm	<b>optional</b>	150mm	140	0.9	29	25

### Set

Code	Range	Probes included	Setting ring (included)	Extension rod (included)
2124-S123 *	6-12mm	6-8mm, 8-10mm, 10-12mm	Ø6mm, Ø8mm, Ø10mm	100mm
2124-S202 *	12-20mm	12-16mm, 16-20mm	Ø16mm	150mm
2124-S504 *	20-50mm	20-25mm, 25-30mm, 30-40mm, 40-50mm	Ø25mm, Ø40mm	150mm
2124-S1004 *	50-100mm	50-63mm, 62-75mm, 75-88mm, 87-100mm	Ø62mm, Ø87mm	150mm



2124-S504

\* Supplied with manufacturer inspection certificate

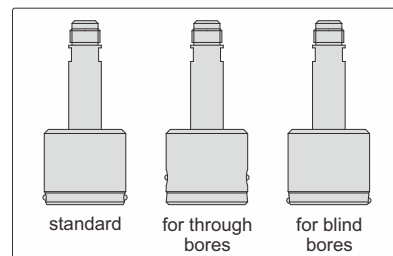
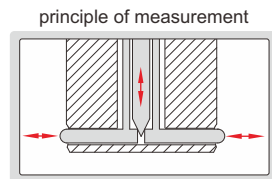
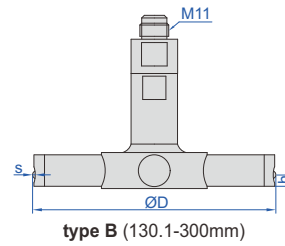
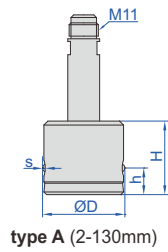
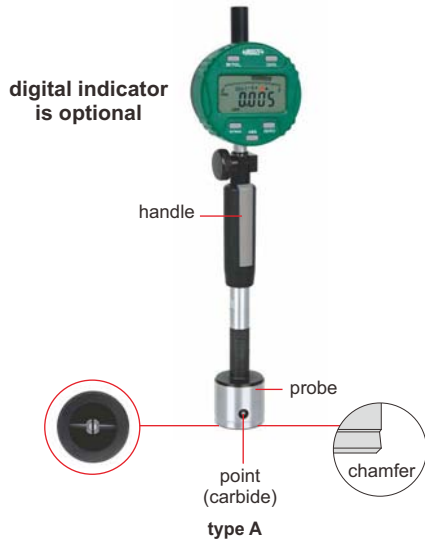

**SPECIFICATION OF PROBE**

(mm)

Range (ØD)	2-3	3.1-4	4.1-6	6.1-9	9.1-12	12.1-20	20.1-40	40.1-60	60.1-130	130.1-300
Type	A	A	A	A	A	A	A	A	A	B
Travel of point (s)	0.15	0.15	0.15	0.2	0.2	0.2	0.2	0.2	0.2	0.2
Height of point (h)	standard	1	1.5	1.5	2.5	2.5	2.5	3.5	3.5	6
	for through bores	—	6	6	6	10	10	10	10	—
	for blind bores	0.7	1	1	1	1	1	1.2	1.2	3
Height of probe (H)	17.5	26	10	15	15	15	20	28	33	—
Repeatability	0.001	0.001	0.001	0.0005	0.0005	0.0005	0.0005	0.0005	0.001	0.002

To be continued

Continued from previous page



### PROBE

Code	Type
4653-A□□□□□	standard
4653-B□□□□□	for through bores
4653-C□□□□□	for blind bores

### SETTING RING

Code
6312-□□□□□

Ordering examples:

Code	Type	Range
4653-A30D6H7	standard	30.6H7

Attention: "D" stands for "."



### HANDLE

Code	Length (L)	Diameter (ØD)	Retraction
4653-150	45mm	12mm	without
4653-1105	105mm	12mm	without
4653-1235	235mm	12mm	without
4653-2145	145mm	18mm *	without
4653-2235	235mm	18mm *	without
4653-H70	70mm	12mm	with

\* When measuring range is larger than 60mm, we suggest to use the 18mm handle

7



4653-G



4653-J



set measuring depth

### DEPTH STOP

Code	Applicable for probe
4653-G□□□□□	3.0~60mm
4653-J□□□□□	30~130mm

Ordering examples:

Code	Applicable for probe
4653-G22H7	22H7



set measuring depth



### HANDLE FOR INDUCTIVE PROBE

Code
4653-F110



application

### BASE

Code	Applicable holding stem
4663-STAND	Ø12mm
4663-STAND1	Ø18mm



### EXTENSION ROD FOR HANDLE

Code	Length (H)
4653-R50	50mm
4653-R100	100mm
4653-R250	250mm
4653-R500	500mm

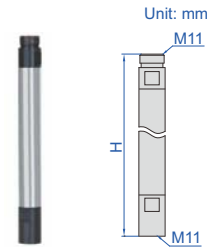

### 90° ADAPTER

Code
4653-K1

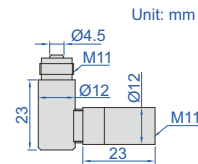

application



### FLOATING CLAMP HANDLE

Code
4653-M30

Suitable for automatic measurement

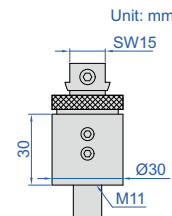

application



## SPLIT TYPE DIAL BORE GAGES

**INSIZE PLUS**  
MADE IN EUROPE

digital indicator  
is optional

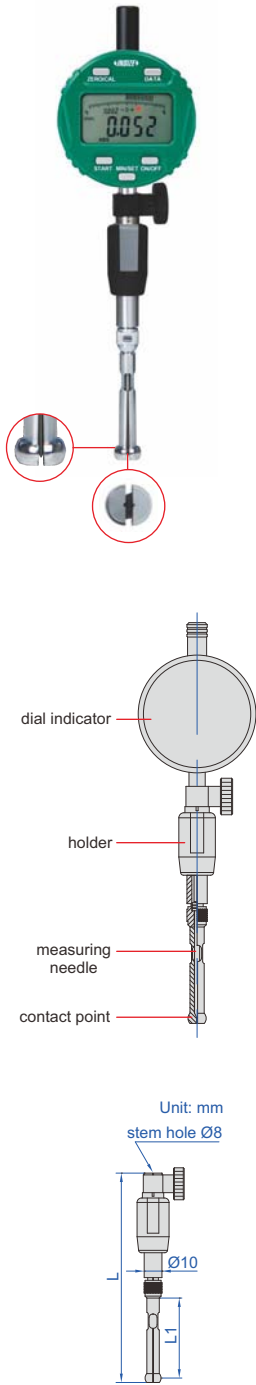

- Split type contact points
- Accuracy (without indicator):  
3µm (measuring range 0.95~10mm),  
4µm (measuring range 10~20.6mm)
- Repeatability (without indicator): 1µm
- Optional accessory:  
digital/dial indicators or dial comparator

principle of measurement

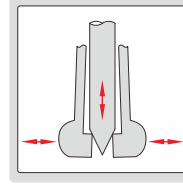

(mm)

Contact point					Measuring needle	Setting ring	
code	measuring range	measuring depth (L1)	total length (L)	material of points	code	code	diameter
2426-1	0.95-1.15	13	89	carbide	2426-N1D4	6312-1	1
2426-1D1	1.07-1.25	13	89	carbide		6312-1D1	1.1
2426-1D2	1.17-1.35	13	89	carbide		6312-1D2	1.2
2426-1D3	1.27-1.45	13	89	carbide		6312-1D3	1.3
2426-1D4	1.37-1.55	13	89	carbide	2426-N2D25	6312-1D4	1.4
2426-1D75	1.5-1.9	17	93	carbide		6312-1D75	1.75
2426-2	1.8-2.2	17	93	carbide		6312-2	2
2426-2D25	2.05-2.45	17	93	carbide		6312-2D25	2.25
2426-2D5	2.3-2.7	25	101	carbide	2426-N4	6312-2D5	2.5
2426-2D75	2.55-2.95	25	101	carbide		6312-2D75	2.75
2426-3	2.8-3.2	25	101	carbide		6312-3	3
2426-3D25	3.05-3.45	25	101	carbide		6312-3D25	3.25
2426-3D5	3.3-3.7	25	101	carbide	2426-N9	6312-3D5	3.5
2426-3D75	3.55-3.95	25	101	carbide		6312-3D75	3.75
2426-4	3.8-4.2	25	101	carbide		6312-4	4
2426-4D5	4.15-4.8	41	118	DLC coating		6312-4D5	4.5
2426-5	4.7-5.3	41	118	DLC coating	2426-N9	6312-5	5
2426-5D5	5.2-5.8	41	118	DLC coating		6312-5D5	5.5
2426-6	5.7-6.3	41	118	DLC coating		6312-6	6
2426-6D5	6.2-6.8	41	118	DLC coating		6312-6D5	6.5
2426-7	6.7-7.3	41	118	DLC coating	2426-N20	6312-7	7
2426-7D5	7.2-7.8	45	118	DLC coating		6312-7D5	7.5
2426-8	7.7-8.3	45	118	DLC coating		6312-8	8
2426-8D5	8.2-8.8	45	118	DLC coating		6312-8D5	8.5
2426-9	8.7-9.3	45	118	DLC coating	2426-N20	6312-9	9
2426-10	9.2-10.5	45	118	DLC coating		6312-10	10
2426-11	10.2-11.5	45	118	DLC coating		6312-11	11
2426-12	11.2-12.5	45	118	DLC coating		6312-12	12
2426-13	12.2-13.5	45	118	DLC coating	2426-N20	6312-13	13
2426-14	13.4-14.6	45	118	DLC coating		6312-14	14
2426-15	14.4-15.6	45	118	DLC coating		6312-15	15
2426-16	15.4-16.6	45	118	DLC coating		6312-16	16
2426-17	16.4-17.6	45	118	DLC coating	2426-N20	6312-17	17
2426-18	17.4-18.6	45	118	DLC coating		6312-18	18
2426-19	18.4-19.6	45	118	DLC coating		6312-19	19
2426-20	19.4-20.6	45	118	DLC coating		6312-20	20



2426-HOLDER1



2426-HOLDER2

### HOLDER

Code	Retraction	Applicable points
2426-HOLDER1	without	all
2426-HOLDER2	with	all

## SPLIT TYPE DIAL BORE GAGE SETS

**INSIZE PLUS**  
MADE IN EUROPE

- Split type contact points
- Accuracy (without indicator): 3µm (measuring range 0.95~10mm), 4µm (measuring range 10~20.6mm)
- Repeatability (without indicator): 1µm
- Setting rings and dial indicators are optional



2421-121 (mm)

Code	Range	Quantity of points	Measuring range of point	Measuring depth (L1)	Total length (L)	Material of points	Type of point	Setting ring (optional)	
								code	diameter
2421-1D4	0.95-1.55	5	0.95-1.15	13	89	carbide	A	6312-1	1
			1.07-1.25	13	89	carbide	A	6312-1D1	1.1
			1.17-1.35	13	89	carbide	A	6312-1D2	1.2
			1.27-1.45	13	89	carbide	A	6312-1D3	1.3
			1.37-1.55	13	89	carbide	A	6312-1D4	1.4
2421-4	1.5-4.2	10	1.5-1.9	17	93	carbide	A	6312-1D75	1.75
			1.8-2.2	17	93	carbide	A	6312-2	2
			2.05-2.45	17	93	carbide	A	6312-2D25	2.25
			2.3-2.7	25	101	carbide	A	6312-2D5	2.5
			2.55-2.95	25	101	carbide	A	6312-2D75	2.75
			2.8-3.2	25	101	carbide	A	6312-3	3
			3.05-3.45	25	101	carbide	A	6312-3D25	3.25
			3.3-3.7	25	101	carbide	A	6312-3D5	3.5
			3.55-3.95	25	101	carbide	A	6312-3D75	3.75
			3.8-4.2	25	101	carbide	A	6312-4	4
2421-7D5	4.15-7.8	7	4.15-4.8	41	118	hard chromed	B	6312-4D5	4.5
			4.7-5.3	41	118	hard chromed	B	6312-5	5
			5.2-5.8	41	118	hard chromed	B	6312-5D5	5.5
			5.7-6.3	41	118	hard chromed	B	6312-6	6
			6.2-6.8	41	118	hard chromed	B	6312-6D5	6.5
			6.7-7.3	41	118	hard chromed	B	6312-7	7
			7.2-7.8	45	118	hard chromed	C	6312-7D5	7.5
2421-12	7.7-12.5	6	7.7-8.3	45	118	hard chromed	C	6312-8	8
			8.2-8.8	45	118	hard chromed	C	6312-8D5	8.5
			8.7-9.3	45	118	hard chromed	C	6312-9	9
			9.2-10.5	45	118	hard chromed	C	6312-10	10
			10.2-11.5	45	118	hard chromed	C	6312-11	11
			11.2-12.5	45	118	hard chromed	C	6312-12	12
2421-20	12.2-20.6	8	12.2-13.5	45	118	hard chromed	C	6312-13	13
			13.4-14.6	45	118	hard chromed	C	6312-14	14
			14.4-15.6	45	118	hard chromed	C	6312-15	15
			15.4-16.6	45	118	hard chromed	C	6312-16	16
			16.4-17.6	45	118	hard chromed	C	6312-17	17
			17.4-18.6	45	118	hard chromed	C	6312-18	18
			18.4-19.6	45	118	hard chromed	C	6312-19	19
			19.4-20.6	45	118	hard chromed	C	6312-20	20
2421-121	4.15-12.5	13	4.15-4.8	41	118	hard chromed	B	6312-4D5	4.5
			4.7-5.3	41	118	hard chromed	B	6312-5	5
			5.2-5.8	41	118	hard chromed	B	6312-5D5	5.5
			5.7-6.3	41	118	hard chromed	B	6312-6	6
			6.2-6.8	41	118	hard chromed	B	6312-6D5	6.5
			6.7-7.3	41	118	hard chromed	B	6312-7	7
			7.2-7.8	45	118	hard chromed	C	6312-7D5	7.5
			7.7-8.3	45	118	hard chromed	C	6312-8	8
			8.2-8.8	45	118	hard chromed	C	6312-8D5	8.5
			8.7-9.3	45	118	hard chromed	C	6312-9	9
			9.2-10.5	45	118	hard chromed	C	6312-10	10
			10.2-11.5	45	118	hard chromed	C	6312-11	11
			11.2-12.5	45	118	hard chromed	C	6312-12	12

principle of measurement

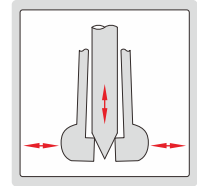

digital indicator is optional

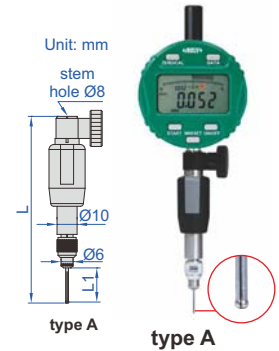

digital indicator is optional

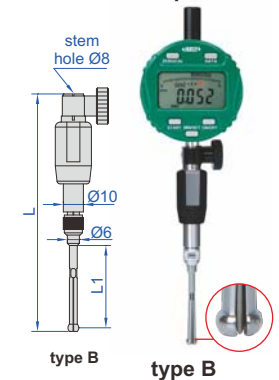

digital indicator is optional

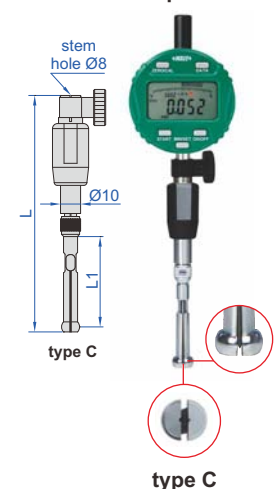

**BORE GAGES FOR SMALL HOLES**

**INSIZE PLUS**  
MADE IN EUROPE

- Applicable for 0.01mm or 0.001mm, graduation dial indicators
- Carbide contact point and anvil
- Optional accessory: dial indicator or dial comparator, setting ring (code 6312)

Code	Range	Accuracy (without dial comparator)	Repeatability (without dial comparator)	L1	L2	ØR	ØD	h
2425-6	4.5-6mm	2µm	0.5µm	80	147	4	4	2
2425-8	6-8mm	2µm	0.5µm	100	165	5	5.2	2.6
2425-12	8-12mm	2µm	0.5µm	100	166	5	6.5	3.25
2425-20	12-20mm	2µm	0.5µm	110	204	8	9	4.5

digital indicator is optional



2425-6

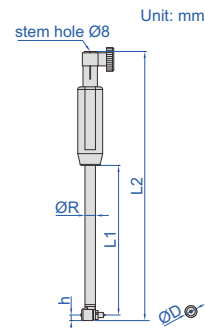

**BORE GAGES**

**INSIZE PLUS**  
MADE IN EUROPE

digital indicator is optional



- Applicable for 0.01mm or 0.001mm graduation dial indicators
- Optional accessory:
  - Dial indicator or dial comparator
  - Setting ring (code 6312)
  - Long handle (code 7352)
  - Bore gage setter



2422-150

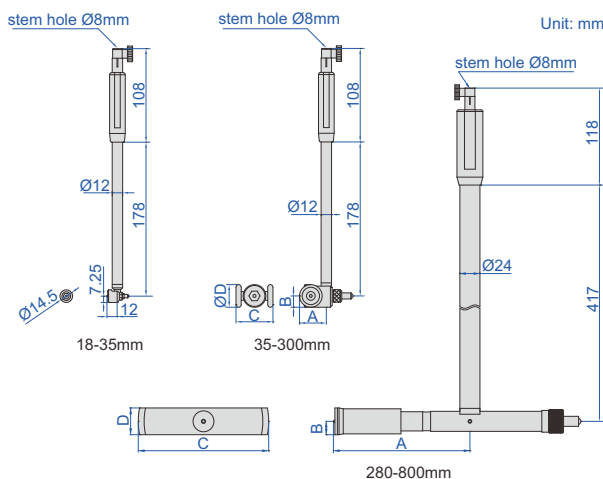

Code	Range	Accuracy (without dial comparator)	Repeatability (without dial comparator)
2422-35	18-35mm	4µm	2µm
2422-60	35-60mm	4µm	2µm
2422-150	50-150mm	4µm	2µm
2422-300	150-300mm	4µm	2µm
2422-510	280-510mm	3µm	1.5µm
2422-800	400-800mm	3µm	1.5µm

Code	A	B	C	D
2422-60	19.5mm	10.5mm	28mm	21mm
2422-150	30.8mm	13mm	42.5mm	26mm
2422-300	30.8mm	13mm	76.5mm	26mm
2422-510	164mm	16mm	156mm	32mm
2422-800	305mm	18mm	300mm	36mm

## PRECISION BORE GAGES FOR SMALL HOLES (WITH DIAL INDICATOR)

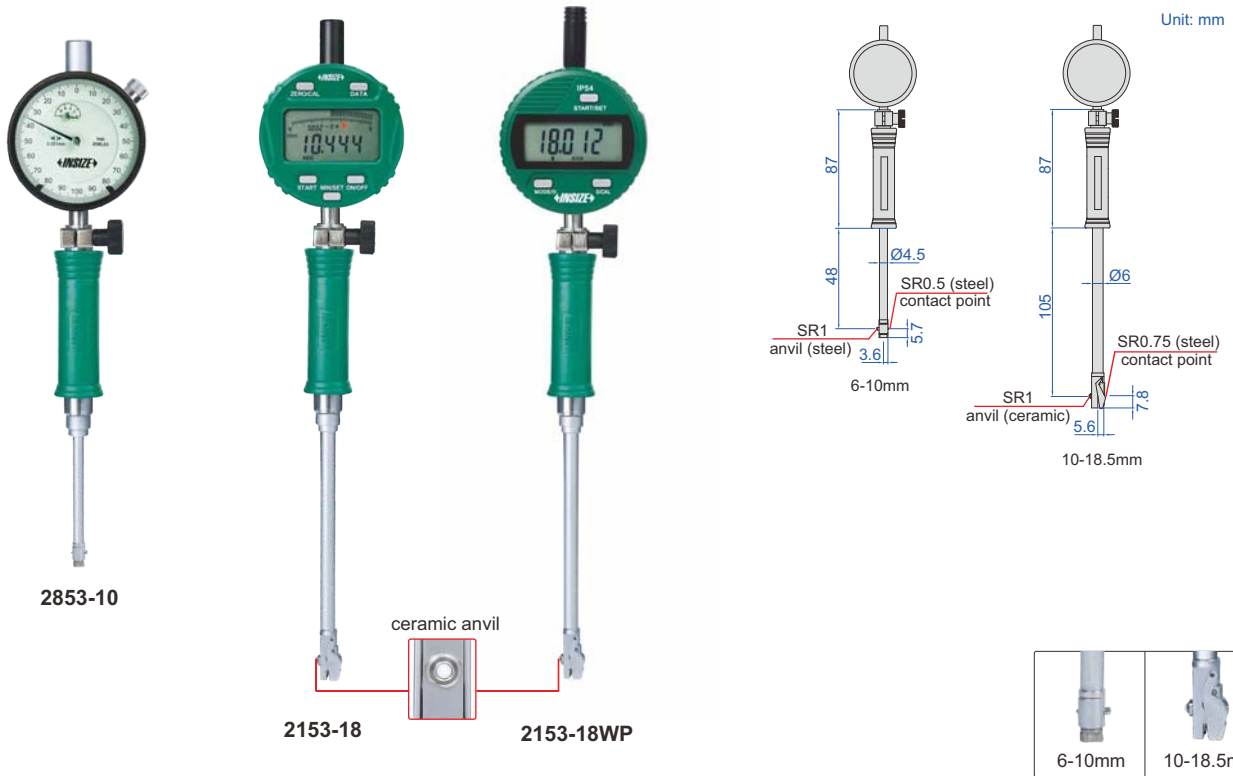

7

- Optional accessory: setting ring (code 6312), bore gage setter

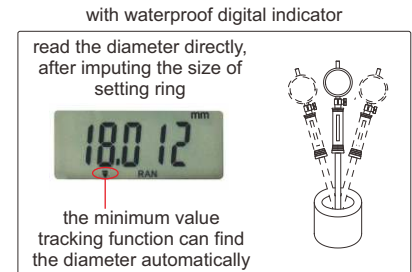
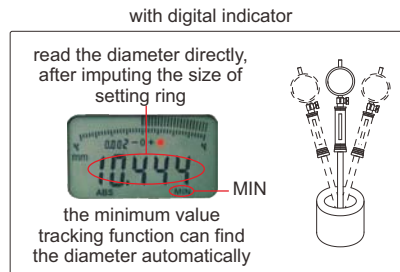

### With dial indicator

Code	Range	Indicator	Accuracy	Repeatability
2853-10	6-10mm	dial indicator, range 1mm, graduation 0.001mm (code 2313-1FA)	±0.007mm	0.0015mm
2853-18	10-18.5mm		±0.007mm	0.0015mm

### With digital indicator

(data output cable code 7315-50M need receiver page 5, 7302-40M page 13, optional)

Code	Range	Indicator	Accuracy	Repeatability
2153-10	6-10mm	digital indicator, code 2108-101F, range 12.7mm/0.5", resolution 0.001mm/0.00005"	±0.007mm	0.002mm
2153-18	10-18.5mm		±0.007mm	0.002mm

### With waterproof digital indicator

(data output cable code 7315-50M need receiver page 5, 7302-40M page 13, optional)

Code	Range	Indicator	Accuracy	Repeatability
2153-10WP	6-10mm	waterproof digital indicator, code 2137-101F, range 12.7mm/0.5", dust/waterproof IP54, resolution 0.001mm/0.00005"	±0.007mm	0.002mm
2153-18WP	10-18.5mm		±0.007mm	0.002mm

ATTENTION: NOT SUITABLE FOR 0.001MM DIAL INDICATORS

## BORE GAGES FOR SMALL HOLES (WITH DIAL INDICATOR)



2852-10



2152-18

2152-18WP

ceramic anvil

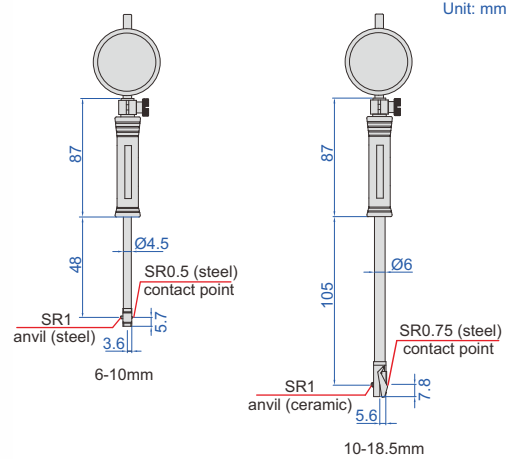

6-10mm

10-18.5mm

- Optional accessory: setting ring (code 6312), bore gage setter

with digital indicator

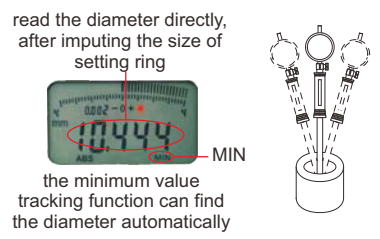

with waterproof digital indicator

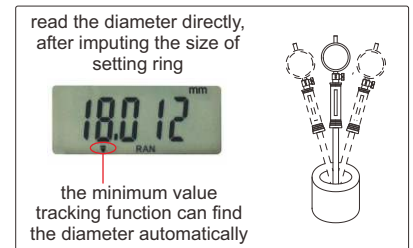

### With dial indicator

Code	Range	Indicator	Accuracy	Repeatability
2852-10	6-10mm	dial indicator, range 3mm, graduation 0.01mm (code 2311-3F)	±0.012mm	0.003mm
2852-18	10-18.5mm		±0.012mm	0.003mm

### With digital indicator

(data output cable code 7315-50M need receiver page 5, 7302-40M page 13, optional)

Code	Range	Indicator	Accuracy	Repeatability
2152-10	6-10mm	digital indicator, code 2108-10F, range 12.7mm/0.5", resolution 0.002mm/0.0001" (can switch to 0.01mm/0.0005")	±0.012mm	0.003mm
2152-18	10-18.5mm		±0.012mm	0.003mm

### With waterproof digital indicator

(data output cable code 7315-50M need receiver page 5, 7302-40M page 13, optional)

Code	Range	Indicator	Accuracy	Repeatability
2152-10WP	6-10mm	waterproof digital indicator, code 2137-10F, range 12.7mm/0.5", dust/waterproof IP54, resolution 0.002mm/0.0001" (can switch to 0.01mm/0.0005")	±0.012mm	0.003mm
2152-18WP	10-18.5mm		±0.012mm	0.003mm

## PRECISION BORE GAGES (WITH DIAL INDICATOR)

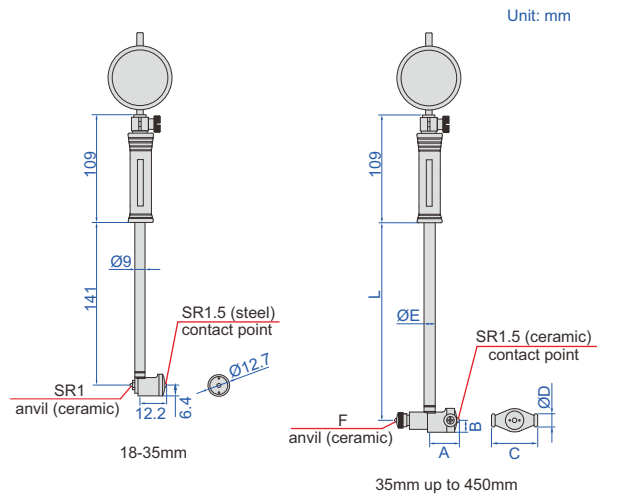

- Optional accessory: setting ring (code 6312), bore gage setter

Range	A	B	C	ØD	ØE	F	L
35-60mm	22	9	27	13	12.8	SR2	141
50-100mm	26	9	35	13	12.8	SR2	141
50-160mm	26	9	35	13	12.8	SR2	141
100-160mm	26	9	35	13	12.8	SR2	141
160-250mm	56.5	13	74.5	15	12.8	SR2	241
250-450mm	86.5	15	101.5	15	14.5	SR2.5	241

### With dial indicator

Code	Range	Indicator	Accuracy	Repeatability
2825-35	18-35mm	dial indicator, range 1mm, graduation 0.001mm (code 2313-1FA)	±0.007mm	0.0015mm
2825-60	35-60mm		±0.007mm	0.0015mm
2825-100	50-100mm		±0.007mm	0.0015mm
2825-160	50-160mm		±0.007mm	0.0015mm
2825-161	100-160mm		±0.007mm	0.0015mm
2825-250	160-250mm		±0.007mm	0.0015mm
2825-450	250-450mm		±0.007mm	0.0015mm

### With digital indicator (data output cable code 7315-50M need receiver page 5, 7302-40M page 13, optional)

Code	Range	Indicator	Accuracy	Repeatability
2126-35	18-35mm	digital indicator, code 2108-101F, range 12.7mm/0.5", resolution 0.001mm/0.00005"	±0.007mm	0.002mm
2126-60	35-60mm		±0.007mm	0.002mm
2126-100	50-100mm		±0.007mm	0.002mm
2126-160	50-160mm		±0.007mm	0.002mm
2126-161	100-160mm		±0.007mm	0.002mm
2126-250	160-250mm		±0.007mm	0.002mm
2126-450	250-450mm		±0.007mm	0.002mm

### With waterproof digital indicator (data output cable code 7315-50M need receiver page 5, 7302-40M page 13, optional)

Code	Range	Indicator	Accuracy	Repeatability
2126-35WP	18-35mm	waterproof digital indicator, code 2137-101F, range 12.7mm/0.5", dust/waterproof IP54, resolution 0.001mm/0.00005"	±0.007mm	0.002mm
2126-60WP	35-60mm		±0.007mm	0.002mm
2126-100WP	50-100mm		±0.007mm	0.002mm
2126-160WP	50-160mm		±0.007mm	0.002mm
2126-161WP	100-160mm		±0.007mm	0.002mm
2126-250WP	160-250mm		±0.007mm	0.002mm
2126-450WP	250-450mm		±0.007mm	0.002mm

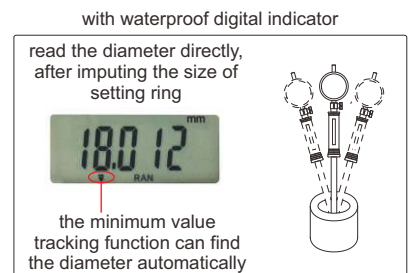
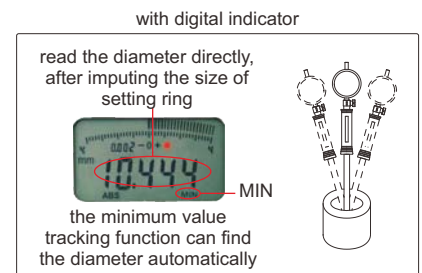
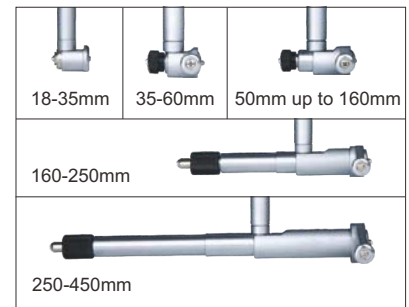
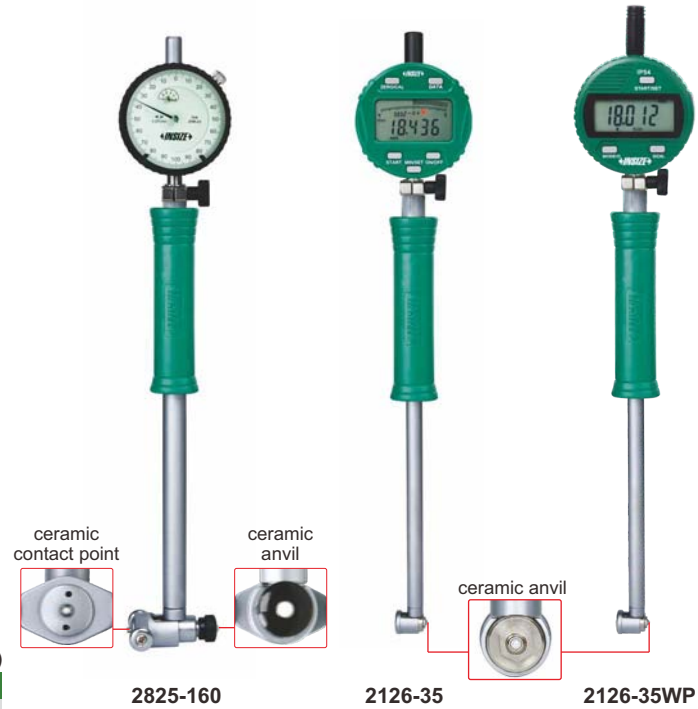

ATTENTION: NOT SUITABLE FOR 0.001MM DIAL INDICATORS

POPULAR MODEL

## BORE GAGES (WITH DIAL INDICATOR)

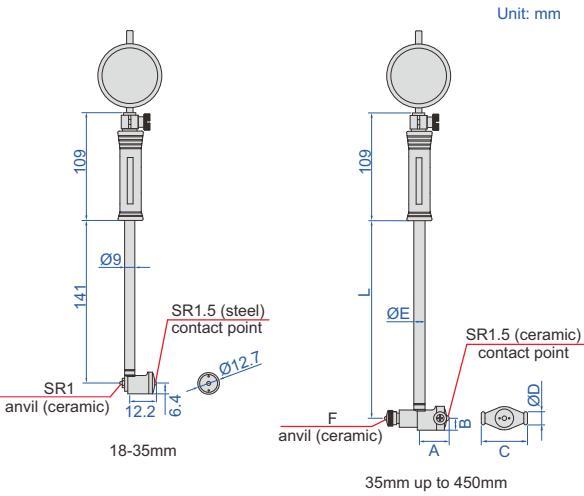

- Optional accessory: setting ring (code **6312**), long handle (code **7351**), bore gage setter

Range	A	B	C	ØD	ØE	F	L
35-60mm	22	9	27	13	12.8	SR2	141
50-100mm	26	9	35	13	12.8	SR2	141
50-160mm	26	9	35	13	12.8	SR2	141
100-160mm	26	9	35	13	12.8	SR2	141
160-250mm	56.5	13	74.5	15	12.8	SR2	241
250-450mm	86.5	15	101.5	15	14.5	SR2.5	241

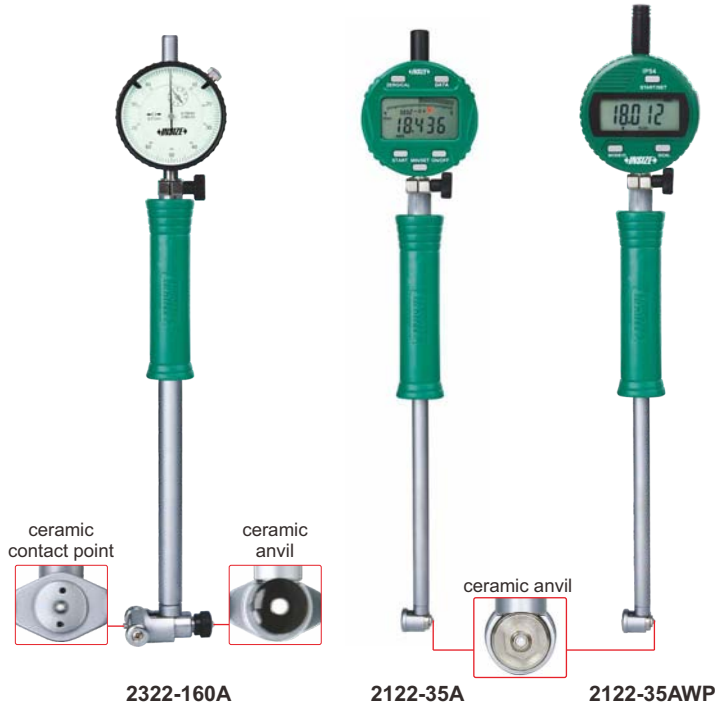

### With dial indicator

Code	Range	Indicator	Accuracy	Repeatability
2322-35A	18-35mm	dial indicator, range 10mm, graduation 0.01mm (code <b>2308-10FA</b> )	±0.015mm	0.003mm
2322-60A	35-60mm		±0.018mm	0.003mm
2322-100A	50-100mm		±0.018mm	0.003mm
2322-160A	50-160mm		±0.018mm	0.003mm
2322-161A	100-160mm		±0.018mm	0.003mm
2322-250A	160-250mm		±0.018mm	0.003mm
2322-450A	250-450mm		±0.018mm	0.003mm

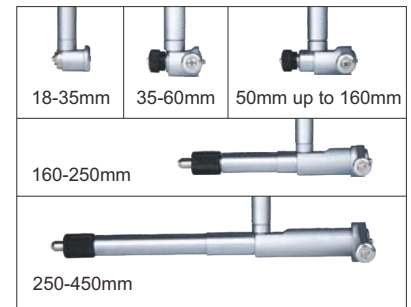

### With digital indicator

(data output cable code **7315-50M** need receiver page 5, **7302-40M** page 13, optional)

Code	Range	Indicator	Accuracy	Repeatability
2122-35A	18-35mm	digital indicator, code <b>2108-10F</b> , range 12.7mm/0.5", resolution 0.002mm/0.0001" (can switch to 0.01mm/0.0005")	±0.015mm	0.003mm
2122-60A	35-60mm		±0.018mm	0.003mm
2122-100A	50-100mm		±0.018mm	0.003mm
2122-160A	50-160mm		±0.018mm	0.003mm
2122-161A	100-160mm		±0.018mm	0.003mm
2122-250A	160-250mm		±0.018mm	0.003mm
2122-450A	250-450mm		±0.018mm	0.003mm

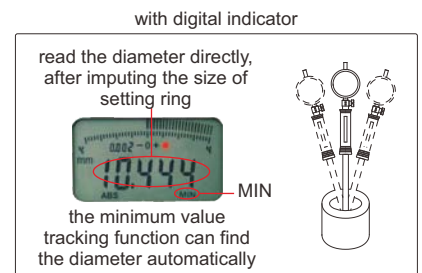

### With waterproof digital indicator

(data output cable code **7315-50M** need receiver page 5, **7302-40M** page 13, optional)

Code	Range	Indicator	Accuracy	Repeatability
2122-35AWP	18-35mm	waterproof digital indicator, code <b>2137-10F</b> , range 12.7mm/0.5", dust/waterproof IP54, resolution 0.002mm/0.0001" (can switch to 0.01mm/0.0005")	±0.015mm	0.003mm
2122-60AWP	35-60mm		±0.018mm	0.003mm
2122-100AWP	50-100mm		±0.018mm	0.003mm
2122-160AWP	50-160mm		±0.018mm	0.003mm
2122-161AWP	100-160mm		±0.018mm	0.003mm
2122-250AWP	160-250mm		±0.018mm	0.003mm
2122-450AWP	250-450mm		±0.018mm	0.003mm

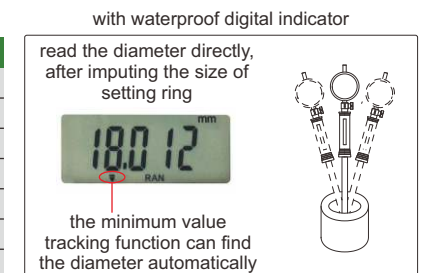

**BORE GAGES  
(WITH DIAL INDICATOR)**

ATTENTION: NOT SUITABLE FOR 0.001MM DIAL INDICATORS

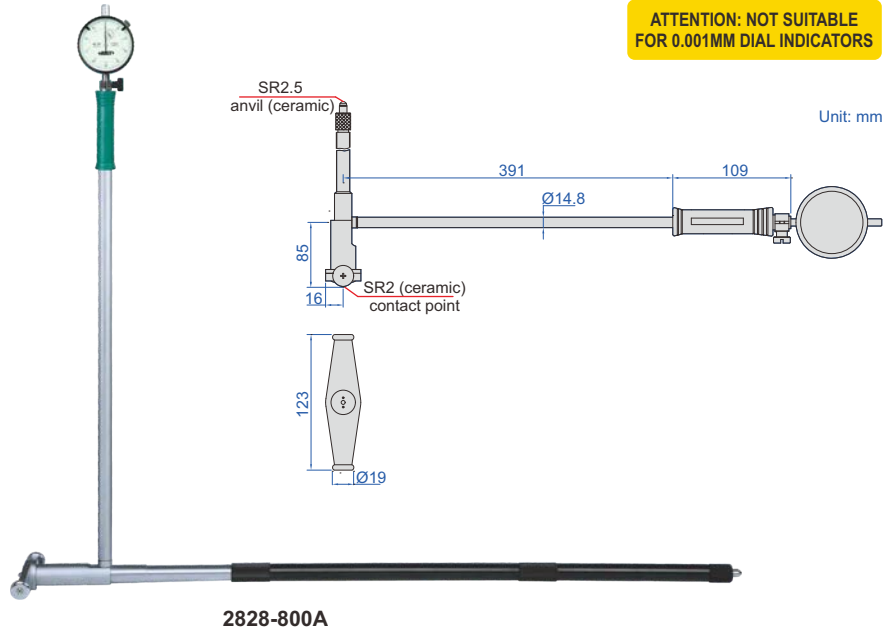

7

With dial indicator

Code	Range	Indicator	Accuracy	Repeatability
2828-800A	400-800mm	dial indicator, code 2308-10FA, range 10mm, graduation 0.01mm	±0.025mm	0.003mm

With digital indicator (data output cable code 7315-50M need receiver page 5, 7302-40M page 13, optional)

Code	Range	Indicator	Accuracy	Repeatability
2128-800A	400-800mm	digital indicator, code 2108-10F, range 12.7mm/0.5", resolution 0.002mm/0.0001" (can switch to 0.01mm/0.0005")	±0.025mm	0.003mm

With waterproof digital indicator (data output cable code 7315-50M need receiver page 5, 7302-40M page 13, optional)

Code	Range	Indicator	Accuracy	Repeatability
2128-800AWP	400-800mm	waterproof digital indicator, code 2137-10F, range 12.7mm/0.5", dust/waterproof IP54, resolution 0.002mm/0.0001" (can switch to 0.01mm/0.0005")	±0.025mm	0.003mm

**BORE GAGE SET**

**INSIZE PLUS**  
MADE IN EUROPE

digital indicator is optional



2423-S2

- Includes bore gages 18-50mm and 50-150mm
- Optional accessory:
  - 0.01mm or 0.001mm graduation
  - dial indicator or dial comparator
  - Setting ring (code 6312)
  - Long handle (code 7352)
  - Bore gage setter

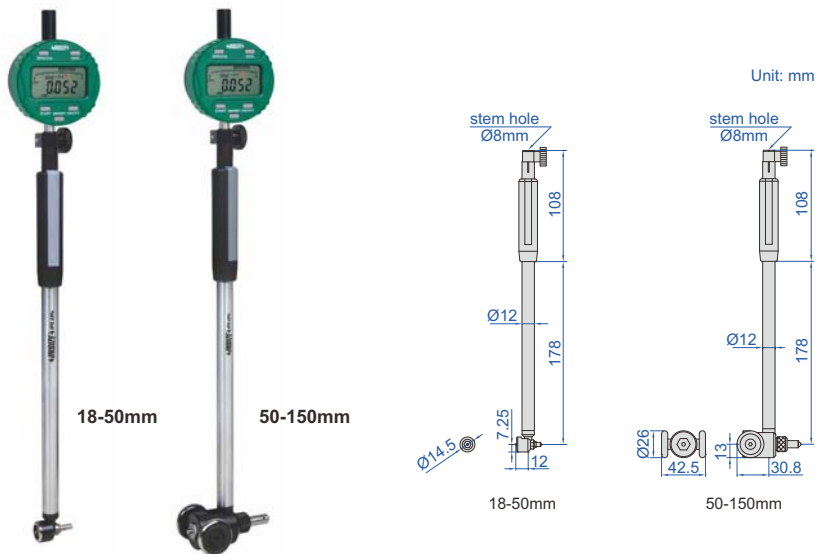

Code	Range	Accuracy (without dial comparator)	Repeatability (without dial comparator)
2423-S2	18-150mm	4µm	2µm



ATTENTION: NOT SUITABLE FOR 0.001MM DIAL INDICATORS

## BORE GAGE SETS (WITH DIAL INDICATOR)



2824-S160



2724-S3



2724-S3WP

- Optional accessory: setting ring (code 6312), long handle (code 7351), bore gage setter

with digital indicator

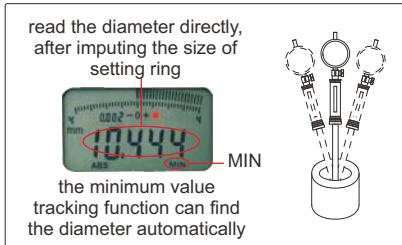

with waterproof digital indicator

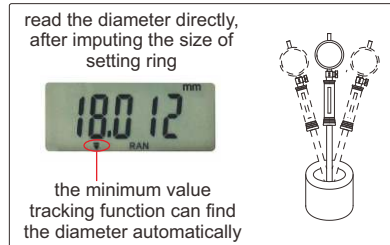

packaging (code 2824-S3)



### With dial indicator

Code	Range	Indicator	Bore gages included	Accuracy	Repeatability
2824-S160	35-160mm	dial indicator, code 2308-10FA, range 10mm, graduation 0.01mm	① 35-50mm (dial indicator and handle are not included) ② 50-160mm	35-50mm ±0.018mm 50-160mm ±0.018mm	0.003mm
2824-S3	18-160mm	dial indicator, code 2308-10FA, range 10mm, graduation 0.01mm	① 18-35mm ② 35-60mm (dial indicator is not included) ③ 50-160mm (dial indicator is not included)	18-35mm ±0.015mm 35-60mm ±0.018mm 50-160mm ±0.018mm	0.003mm

### With digital indicator (data output cable code 7315-50M need receiver page 5, 7302-40M page 13, optional)

Code	Range	Indicator	Bore gages included	Accuracy	Repeatability
2724-S160	35-160mm	digital indicator, code 2108-10F range 12.7mm/0.5", resolution 0.002mm/0.0001" (can switch to: 0.01mm/0.0005")	① 35-50mm (digital indicator and handle are not included) ② 50-160mm	35-50mm ±0.018mm 50-160mm ±0.018mm	0.003mm
2724-S3	18-160mm	digital indicator, code 2108-10F range 12.7mm/0.5", resolution 0.002mm/0.0001" (can switch to: 0.01mm/0.0005")	① 18-35mm ② 35-60mm (digital indicator is not included) ③ 50-160mm (digital indicator is not included)	18-35mm ±0.015mm 35-60mm ±0.018mm 50-160mm ±0.018mm	0.003mm

To be continued

Continued from previous page

With waterproof digital indicator (data output cable code 7315-50M need receiver page 5, 7302-40M page 13, optional)

Code	Range	Indicator	Bore gages included	Accuracy	Repeatability
2724-S160WP	35-160mm	waterproof digital indicator, code <b>2137-10F</b> , range 12.7mm/0.5", dust/waterproof IP54, resolution 0.002mm/0.0001" (can switch to 0.01mm/0.0005")	① 35-50mm (digital indicator and handle are not included) ② 50-160mm	35-50mm ±0.018mm 50-160mm ±0.018mm	0.003mm
2724-S3WP	18-160mm	waterproof digital indicator, code <b>2137-10F</b> , range 12.7mm/0.5", dust/waterproof IP54, resolution 0.002mm/0.0001" (can switch to 0.01mm/0.0005")	① 18-35mm ② 35-60mm (digital indicator is not included) ③ 50-160mm (digital indicator is not included)	18-35mm ±0.015mm 35-60mm ±0.018mm 50-160mm ±0.018mm	0.003mm

## BORE GAGES FOR BLIND HOLES

**INSIZE PLUS**  
MADE IN EUROPE

7

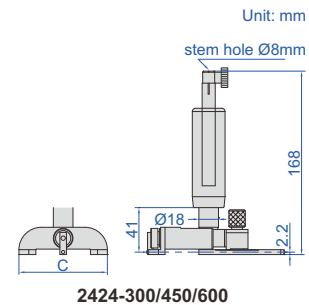
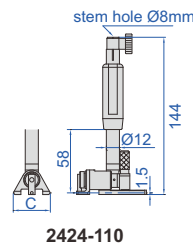
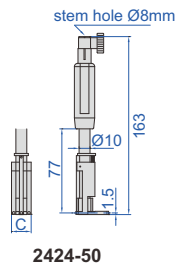

- To measure diameter of shallow and blind holes
- Optional accessory:
  - 0.01mm or 0.001mm graduation dial indicators
  - Setting ring (code **6312**)
  - Long handle (code **7352**)
  - Bore gage setter



Code	Range	Accuracy (without dial indicator)	Repeatability (without dial indicator)	C
2424-50	20-50mm	4µm	1µm	18mm
2424-110	50-110mm	4µm	1µm	34mm
2424-300	110-300mm	4µm	1µm	81mm
2424-450	200-450mm	4µm	1µm	81mm
2424-600	300-600mm	4µm	1µm	140mm

ATTENTION: NOT SUITABLE FOR 0.001MM DIAL INDICATORS

## BORE GAGES (WITH DIAL INDICATOR)

- Optional accessory:  
setting ring (code 6312),  
long handle (code 7351),  
bore gage setter

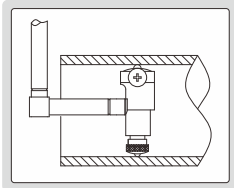

2827-160A

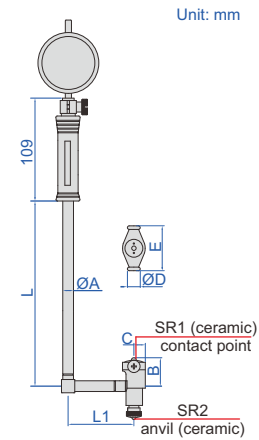

2308-10FA

2108-10F

2137-10F

with digital indicator

read the diameter directly, after inputting the size of setting ring



the minimum value tracking function can find the diameter automatically

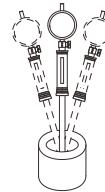

with waterproof digital indicator

read the diameter directly, after inputting the size of setting ring



the minimum value tracking function can find the diameter automatically

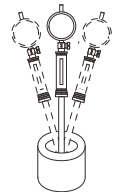

(mm)

Range	ØA	B	C	ØD	E	L	L1
35-60mm	12.8	22	9	13	27	141	75
50-160mm	12.8	28.5	9.2	13	35	141	76.2
160-250mm	14.5	62.0	12.7	15	74.5	391	100
250-450mm	14.5	91.5	15.0	15	101.5	391	100

### With dial indicator

Code	Range	Indicator	Accuracy	Repeatability
2827-60A	35-60mm	dial indicator, code 2308-10FA, range 10mm, graduation 0.01mm	±0.018mm	0.003mm
2827-160A	50-160mm		±0.018mm	0.003mm
2827-250A	160-250mm		±0.018mm	0.003mm
2827-450A	250-450mm		±0.018mm	0.003mm

### With digital indicator

(data output cable code 7315-50M need receiver page 5, 7302-40M page 13, optional)

Code	Range	Indicator	Accuracy	Repeatability
2127-60	35-60mm	digital indicator, code 2108-10F, range 12.7mm/0.5", resolution 0.002mm/0.0001" (can switch to: 0.01mm/0.0005")	±0.018mm	0.003mm
2127-160	50-160mm		±0.018mm	0.003mm
2127-250	160-250mm		±0.018mm	0.003mm
2127-450	250-450mm		±0.018mm	0.003mm

### With waterproof digital indicator

(data output cable code 7315-50M need receiver page 5, 7302-40M page 13, optional)

Code	Range	Indicator	Accuracy	Repeatability
2127-60WP	35-60mm	waterproof digital indicator, code 2137-10F, range 12.7mm/0.5", dust/waterproof IP54, resolution 0.002mm/0.0001" (can switch to 0.01mm/0.0005")	±0.018mm	0.003mm
2127-160WP	50-160mm		±0.018mm	0.003mm
2127-250WP	160-250mm		±0.018mm	0.003mm
2127-450WP	250-450mm		±0.018mm	0.003mm

# GEAR BORE GAGES

**INSIZE PLUS**  
MADE IN EUROPE

RELATIVE PRODUCT: INTERNAL GEAR TOOTH MICROMETER (CODE 3638)



- Tungsten carbide ball points, diameter accuracy 2µm
- Optional accessory:
  - Dial indicator or dial comparator
  - Ball points
  - Thread adaptor
  - Long handle (code 7352)

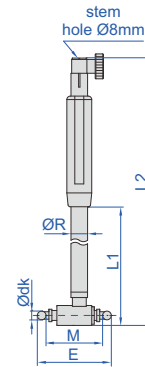

7

(mm)

Code	Range (E)	Accuracy (without dial comparator)	Repeatability (without dial comparator)	ØR	L1	L2	Thread for ball points
2428-12	8-12mm	2µm	0.5µm	5	100	165	M1.6
2428-22	12-22mm	2µm	0.5µm	5	102	168	M1.6
2428-55	22-55mm	2µm	0.5µm	8	110	204	M2.5
2428-250	55-250mm	2µm	0.5µm	12	177	290	M4
2428-510	100-510mm	2µm	0.5µm	18	235	363	M4

extension rod for points (included)



### Ball points (optional)

Ball point diameter Ødk	2428-12	2428-22	2428-55	2428-250	2428-510
	point thread M1.6	point thread M1.6	point thread M2.5	point thread M4	point thread M4
	point code	point code	point code	point code	point code
1mm	2428-A1	2428-E1	2428-B1	2428-C1	2428-C1
1.5mm	2428-A1D5	2428-E1D5	2428-B1D5	2428-C1D5	2428-C1D5
2mm	2428-A2	2428-E2	2428-B2	2428-C2	2428-C2
2.5mm	—	2428-E2D5	2428-B2D5	2428-C2D5	2428-C2D5
3mm	—	2428-E3	2428-B3	2428-C3	2428-C3
3.5mm	—	2428-E3D5	2428-B3D5	2428-C3D5	2428-C3D5
4mm	—	2428-E4	2428-B4	2428-C4	2428-C4
4.5mm	—	—	2428-B4D5	2428-C4D5	2428-C4D5
5mm	—	—	2428-B5	2428-C5	2428-C5
5.5mm	—	—	2428-B5D5	2428-C5D5	2428-C5D5
6mm	—	—	2428-B6	2428-C6	2428-C6
6.5mm	—	—	2428-B6D5	2428-C6D5	2428-C6D5
7mm	—	—	2428-B7	2428-C7	2428-C7
7.5mm	—	—	2428-B7D5	2428-C7D5	2428-C7D5
8mm	—	—	2428-B8	2428-C8	2428-C8
8.5mm	—	—	2428-B8D5	2428-C8D5	2428-C8D5
9mm	—	—	2428-B9	2428-C9	2428-C9
9.5mm	—	—	2428-B9D5	2428-C9D5	2428-C9D5
10mm	—	—	2428-B10	2428-C10	2428-C10

method of measurement

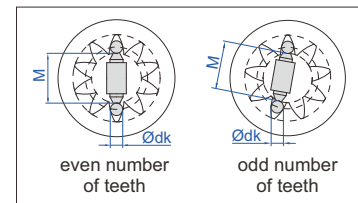

ball points (optional), in pair



### Thread adaptor (optional)

Code	Thread	Remark
2428-D1	M1.6/M2.5	For example, use 2428-E1 with 2428-D1 to replace 2428-B1
2428-D2	M2.5/M4	For example, use 2428-B1 with 2428-D2 to replace 2428-C1

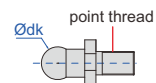

ATTENTION: NOT SUITABLE FOR 0.001MM DIAL INDICATORS

MEASURE DIAMETER OF BORES WITH BARRIER INSIDE

## BORE GAGE FOR BARRIER INSIDE BORE

digital indicator is optional

application



- Measure diameter of bores with barrier inside
- Optional accessory:
  - 0.01mm graduation dial indicators
  - Setting ring (code 6312)



2348-210

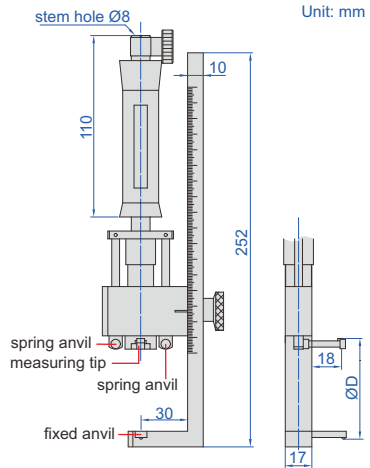

Code	Range $\varnothing D$	Diameter of barrier $\varnothing d$	Travel of measuring tip	Accuracy (without dial indicator)	Measuring force
2348-210	40-210mm	<D-14 (less than 50mm)*	1.6	0.018	2N

\*For example:

When measuring size  $\varnothing D$  is 40mm, D-14=26mm, so the diameter of barrier should be less than 26mm.  
 When measuring size  $\varnothing D$  is 70mm, D-14=56mm, however it should be less than 50mm, so the diameter of barrier should be less than 50mm.

## LONG HANDLES

method of use (replace the original handle with long handle)

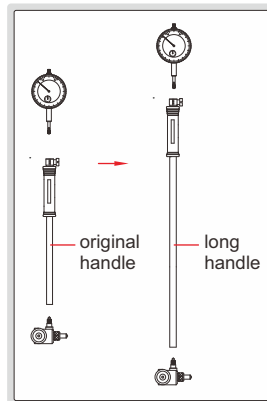

- To assist deep-hole measurement
- Can be used for bore gages 2122, 2322, 2824, 2724, 2127 and 2827

Code	Applicable bore gages	A	$\varnothing D$	Type
7351-EX11	35-60mm, 50-100mm, 50-160mm, 100-160mm	475mm	13mm	B
7351-EX12		980mm	13mm	
7351-EX13	160-250mm, 250-450mm	1480mm	14.5mm	A
7351-EX14		1980mm	14.5mm	
7351-EX21	160-250mm, 250-450mm	480mm	14.5mm	B
7351-EX22		980mm	14.5mm	
7351-EX23		1480mm	14.5mm	A
7351-EX24		1980mm	14.5mm	

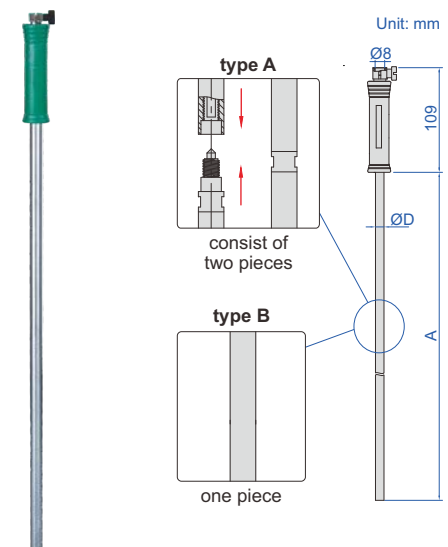

7351-EX11

## ANVILS FOR BORE GAGES



7350-160

- For bore gages 2852, 2152, 2322, 2122, 2127, 2724, 2825, 2126, 2824, 2853, 2153 and 2827

Code	Applicable bore gages	Material of measuring face	Quantity per set	Measuring range of anvil (mm)
7350-10	6-10mm	steel	9 pcs	6, 6.5, 7, 7.5, 8, 8.5, 9, 9.5, 10
7350-18	10-18.5mm	ceramic	9 pcs	10, 11, 12, 13, 14, 15, 16, 17, 18
7350-35	18-35mm	ceramic	9 pcs	18, 20, 22, 24, 26, 28, 30, 32, 34
7350-60	35-60mm	ceramic	6 pcs	35, 40, 45, 50, 55, 60
7350-100	50-100mm	ceramic	11 pcs	50, 55, 60, 65, 70, 75, 80, 85, 90, 95, 100
7350-160	50-160mm	ceramic	12 pcs	50, 55, 60, 65, 70, 75, 80, 85, 90, 95, 100, 105
7350-161	100-160mm	ceramic	12 pcs	50, 55, 60, 65, 70, 75, 80, 85, 90, 95, 100, 105
7350-250	160-250mm	ceramic	5 pcs	160, 170, 180, 190, 200
7350-450	250-450mm	ceramic	5 pcs	250, 260, 270, 280, 290

7

## BORE GAGE SETTERS

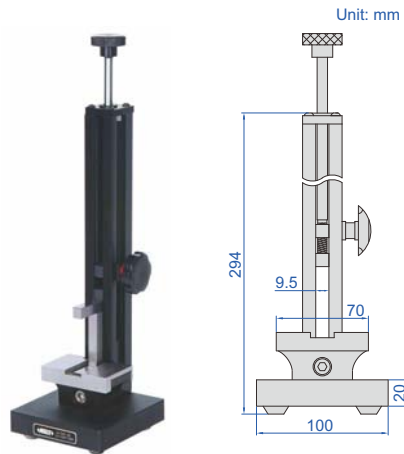
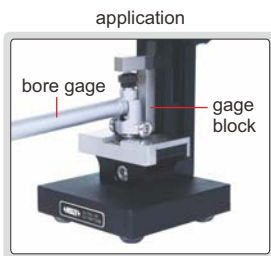

7353-160



- Vertical and horizontal use
- To be used with gage blocks

Gage block set for 7353-160

Blocks per set	Size (mm)	Step (mm)	Quantity	Remark
33	1.005	0.01	1 pc	grade 2 (ISO3650)
	1.01-1.09		9 pcs	
	1.1-1.9		9 pcs	
	1-9	1	9 pcs	
	10-30	10	3 pcs	
	50	1 pc		
	100	1 pc		

Code	Range	Repeatability	Remark
7353-160	0-160mm	1.2µm	with gage block set
7353-160W	0-160mm	1.2µm	without gage block set

## BORE GAGE SETTER



- Used together with gage blocks to set bore gages

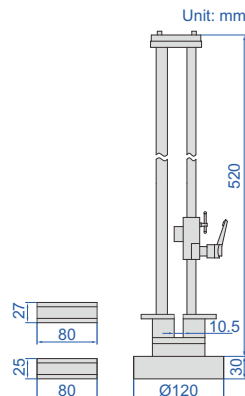

2395-400

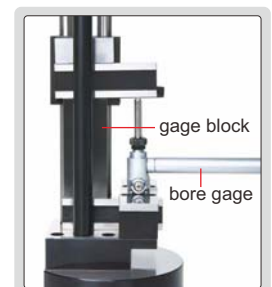

Code	Setting range
2395-400	18-400mm



SPRING LOADED MEASURING POINT

CARBON FIBER EXTENSION RODS, LIGHT WEIGHT, NOT EASY TO DEFORM, LOW THERMAL EXPANSION

DATA OUTPUT

## CARBON FIBER BORE GAGES

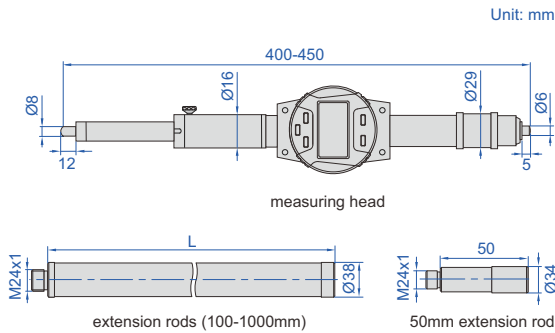

3522-1500

7

- Carbon fiber extension rods, light weight, not easy to deform, low thermal expansion
- Carbide measuring faces
- Data output
- Button function: on/off, zero, tolerance Go and No-Go display, data preset, measuring direction change, max./min./TIR measurement, inch/metric conversion, absolute/incremental measurement
- Supplied with 400mm setting standard
- Optional accessory: data output cable (code **7302-40M** page 13), wireless data transmission (transmitter code **7315-51** need receiver page 5)

setting standard (included), used to set the measuring head

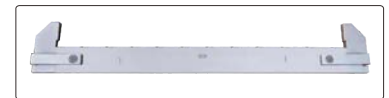

### Measuring head

Range	Resolution	Accuracy	Repeatability	Weight
400-450mm	0.001mm/0.00005"	±6µm	±3µm	1kg

### Extension rods

Length (L)	Accuracy	Weight	Material
50mm	±2µm	230g	steel
100mm	±3µm	300g	carbon fiber
200mm	±4.5µm	390g	carbon fiber
300mm	±6µm	470g	carbon fiber
600mm	±9µm	730g	carbon fiber
1000mm	±11µm	1000g	carbon fiber

spring loaded point, and max./min. value tracking make it easy to find the right measuring position



Code	Range	Weight	Extension rods
<b>3522-1000</b>	400-1000mm	3.8kg	50mm, 100mm, 200mm, 300mm
<b>3522-1500</b>	400-1500mm	4.5kg	50mm, 100mm, 200mm, 300mm, 600mm
<b>3522-2000</b>	400-2000mm	5.3kg	50mm, 100mm, 200mm, 300mm, 600mm (2 pcs)
<b>3522-2400</b>	400-2400mm	6.0kg	50mm, 100mm, 200mm, 300mm, 600mm (3 pcs)
<b>3522-3400</b>	400-3400mm	6.7kg	50mm, 100mm, 200mm, 300mm, 600mm (4 pcs)
<b>3522-6400</b>	400-6400mm	9.5kg	50mm, 100mm, 200mm, 300mm, 600mm, 1000mm (5 pcs)

## INTERNAL CHAMFER GAGES

**INSIZE PLUS**  
MADE IN EUROPE

- Measure end diameter of chamfer or taper holes
- With limit pointers
- 2941-20** and **2941-203** are supplied with 5mm setting ring

5mm setting ring for 2941-20 and 2941-203



2941-20

Unit: mm

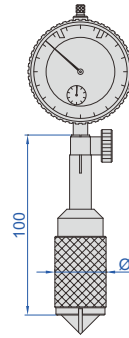

**INSPECTION CERTIFICATE**

measurement principle

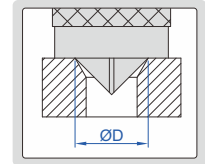

measure end diameter of chamfer or taper holes

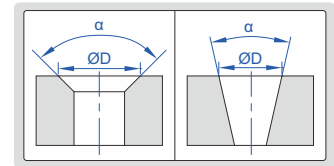

VIDEO

Code	Range ØD	Applicable angle α	Graduation	Accuracy	Ød
2941-20*	0.5-20.1mm	0-90°	0.01mm	±0.02mm	28.3mm
2941-40*	20-40mm	0-90°	0.01mm	±0.02mm	50mm
2941-203*	0.5-20.1mm	90-127°	0.02mm	±0.04mm	28.3mm
2941-403*	20-40mm	90-127°	0.02mm	±0.04mm	50mm

\*Supplied with manufacturer inspection certificate

## DIGITAL INTERNAL CHAMFER GAGES

**INSIZE PLUS**  
MADE IN EUROPE

- Measure end diameter of chamfer or taper holes
- 2942-20** and **2942-203** are supplied with 5mm setting ring
- Resolution: 0.01mm/0.0005"
- Optional accessory: data output cable (code **7315-50M** need receiver page 5, **7302-40M** page 13)

5mm setting ring for 2942-20 and 2942-203



2942-20

Unit: mm

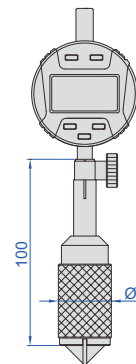

**INSPECTION CERTIFICATE**

DATA OUTPUT

measurement principle

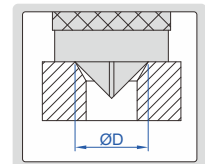

measure end diameter of chamfer or taper holes

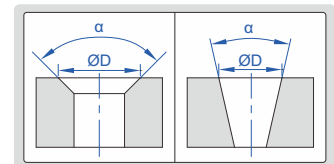

VIDEO

Code	Range ØD	Applicable angle α	Accuracy	Ød
2942-20*	0.5-20.1mm	0-90°	±0.02mm	28.3mm
2942-40*	20-40mm	0-90°	±0.02mm	50mm
2942-203*	0.5-20.1mm	90-127°	±0.04mm	28.3mm
2942-403*	20-40mm	90-127°	±0.04mm	50mm

\*Supplied with manufacturer inspection certificate

## SMALL HOLE GAGE SET

- 4 gages per set
- For small holes, slots and grooves, etc.
- Satin chrome finish



4208-1

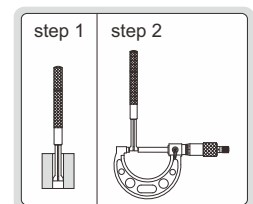

Range	L	a	b	ØD
3-5mm	76	24	52	5
5-7.5mm	79	27	52	5
7.5-10mm	88	30	58	6
10-13mm	91	34	58	6

Code	Total range	Gages included
4208-1	3-13mm	3-5mm, 5-7.5mm, 7.5-10mm, 10-13mm

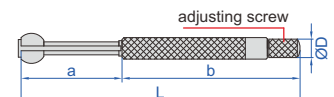



## LONG HANDLE TELESCOPING GAGES

- For quick measurement of inside diameter of deep holes and width of slots
- Satin chrome finish

Code	Range	L	$\varnothing a$	$\varnothing b$	$\varnothing c$
4209-1	8-12.7mm	300	3.9	2.9	6.2
4209-2	12.7-19mm	300	5.3	3.8	6.2
4209-3	19-32mm	300	5.3	3.8	6.2
4209-4	32-54mm	300	7.6	6.1	7.2
4209-5	54-90mm	300	7.6	6.1	7.2
4209-6	90-150mm	300	7.6	6.1	7.2

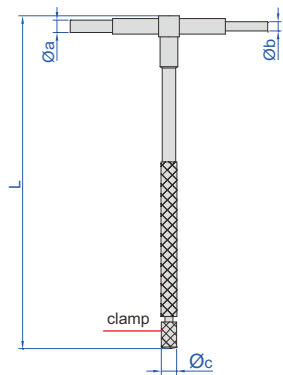
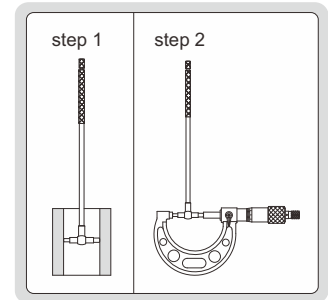
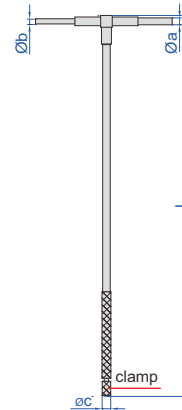
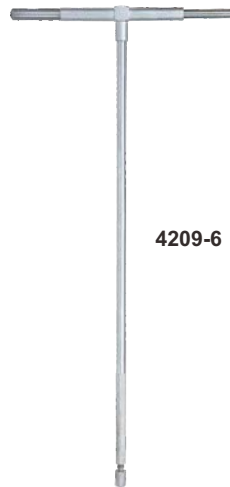

4206-1

- 6 gages per set
- For quick measurement of inside diameter of holes and width of slots
- Satin chrome finish

Code	Total range	Gages included
4206-1	8-150mm	8-12.7mm, 12.7-19mm, 19-32mm, 32-54mm, 54-90mm, 90-150mm

## TELESCOPING GAGE SET

7

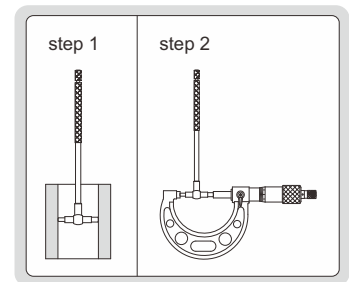

Range	L	$\varnothing a$	$\varnothing b$	$\varnothing c$
8-12.7mm	115	3.9	2.9	6.2
12.7-19mm	115	5.3	3.8	6.2
19-32mm	115	5.3	3.8	6.2
32-54mm	137	7.6	6.1	7.2
54-90mm	137	7.6	6.1	7.2
90-150mm	137	7.6	6.1	7.2

## FLEXIBLE INNER DIAMETER TAPES



7137-60



Code	Diameter range	Graduation	Accuracy
7137-30	$\varnothing 10-30$ mm	0.05mm	$\pm 0.10$ mm
7137-60	$\varnothing 30-60$ mm	0.05mm	$\pm 0.10$ mm
7137-100	$\varnothing 50-100$ mm	0.05mm	$\pm 0.10$ mm
7137-200	$\varnothing 100-200$ mm	0.05mm	$\pm 0.10$ mm
7137-350	$\varnothing 200-350$ mm	0.05mm	$\pm 0.15$ mm

- Measure average inner diameter of flexible materials
- Made of PET



## TAPE BORE GAGES

**INSIZE PLUS**  
MADE IN EUROPE



- Measure internal diameter and circumference of soft materials like tubes, belts, etc.
- Graduation: 0.1mm
- Accuracy: 0.2mm

Code	Range ØD	Ød	ØA	Measuring depth (mm)
2430-24	14-24mm	13.5	13	15-60
2430-40	22-40mm	21.5	21	15-60
2430-60	35-60mm	34.5	30.5	15-96
2430-100	55-100mm	54.5	30.5	15-106
2430-180	95-180mm	94.5	30.5	15-106
2430-255	170-255mm	94.5	30.5	15-106
2430-330	245-330mm	94.5	30.5	15-106

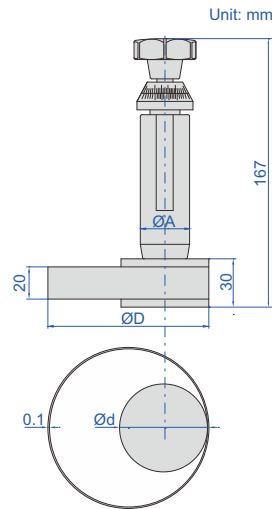

7

## DIAMETER TAPES

CAN BE CUSTOM-MADE



7135-525

- Measure diameter of pipes, trees, tires, etc.
- Made of stainless steel

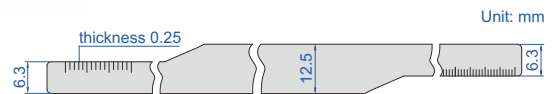

Code	Diameter range	Graduation	Accuracy
7135-35*	Ø20-35mm	0.05mm	±0.05mm
7135-55*	Ø30-55mm	0.05mm	±0.05mm
7135-125	Ø50-125mm	0.01mm	±0.05mm
7135-225	Ø100-225mm	0.01mm	±0.05mm
7135-375	Ø200-375mm	0.01mm	±0.05mm
7135-525	Ø350-525mm	0.01mm	±0.05mm
7135-725	Ø500-725mm	0.01mm	±0.06mm
7135-925	Ø700-925mm	0.01mm	±0.06mm
7135-1125	Ø900-1125mm	0.02mm	±0.06mm
7135-1325	Ø1100-1325mm	0.02mm	±0.08mm
7135-1525	Ø1300-1525mm	0.02mm	±0.08mm
7135-1725	Ø1500-1725mm	0.02mm	±0.08mm
7135-1925	Ø1700-1925mm	0.02mm	±0.08mm
7135-2125	Ø1900-2125mm	0.02mm	±0.08mm
7135-2325	Ø2100-2325mm	0.02mm	±0.10mm
7135-2525	Ø2300-2525mm	0.02mm	±0.10mm
7135-2750	Ø2500-2750mm	0.02mm	±0.10mm
7135-3000	Ø2750-3000mm	0.02mm	±0.10mm
7135-3250	Ø3000-3250mm	0.02mm	±0.15mm
7135-3500	Ø3250-3500mm	0.02mm	±0.15mm

Code	Diameter range	Graduation	Accuracy
7135-3750	Ø3500-3750mm	0.02mm	±0.15mm
7135-4000	Ø3750-4000mm	0.02mm	±0.20mm
7135-4250	Ø4000-4250mm	0.02mm	±0.20mm
7135-4500	Ø4250-4500mm	0.02mm	±0.20mm
7135-4750	Ø4500-4750mm	0.02mm	±0.20mm
7135-5000	Ø4750-5000mm	0.02mm	±0.20mm
7135-5250	Ø5000-5250mm	0.02mm	±0.005%L**
7135-5500	Ø5250-5500mm	0.02mm	±0.005%L**
7135-5750	Ø5500-5750mm	0.02mm	±0.005%L**
7135-6000	Ø5750-6000mm	0.02mm	±0.005%L**
7135-6250	Ø6000-6250mm	0.02mm	±0.005%L**
7135-6500	Ø6250-6500mm	0.02mm	±0.005%L**
7135-6750	Ø6500-6750mm	0.02mm	±0.005%L**
7135-7000	Ø6750-7000mm	0.02mm	±0.005%L**
7135-7250	Ø7000-7250mm	0.02mm	±0.005%L**
7135-7500	Ø7250-7500mm	0.02mm	±0.005%L**
7135-7750	Ø7500-7750mm	0.02mm	±0.005%L**
7135-8000	Ø7750-8000mm	0.02mm	±0.005%L**
7135-8250	Ø8000-8250mm	0.02mm	±0.005%L**

\*\* L is the actual measured value (unit: mm)

\* The thickness of code 7135-35 and 7135-55 is 0.10mm, while the thickness of other codes is 0.25mm

CAN BE CUSTOM-MADE

## CIRCUMFERENCE TAPES

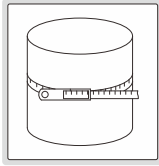

7136-1880

- Measure diameter and circumference of pipes, trees, tires, etc.
- Made of stainless steel

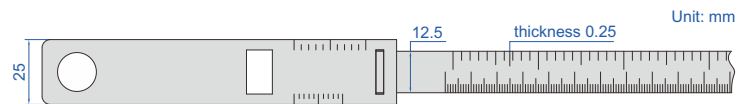

Unit: mm

Code	Circumference range	Diameter range	Graduation	Accuracy	
				circumference	diameter
7136-940	160-940mm	Ø50-300mm	0.1mm	±0.30mm	±0.10mm
7136-1880	940-1880mm	Ø300-600mm	0.1mm	±0.30mm	±0.10mm
7136-2830	1880-2830mm	Ø600-900mm	0.1mm	±0.30mm	±0.10mm
7136-3770	2830-3770mm	Ø900-1200mm	0.1mm	±0.30mm	±0.10mm
7136-4710	3770-4710mm	Ø1200-1500mm	0.1mm	±0.30mm	±0.10mm
7136-5650	4710-5650mm	Ø1500-1800mm	0.1mm	±0.30mm	±0.10mm
7136-6600	5650-6600mm	Ø1800-2100mm	0.1mm	±0.30mm	±0.10mm
7136-7540	6600-7540mm	Ø2100-2400mm	0.1mm	±0.30mm	±0.10mm
7136-8480	7540-8480mm	Ø2400-2700mm	0.1mm	±0.30mm	±0.10mm
7136-9430	8480-9430mm	Ø2700-3000mm	0.1mm	±0.30mm	±0.10mm

## CIRCUMFERENCE TAPES (ECONOMIC TYPE)

- Measure diameter and circumference of soft materials like pipes, trees, tires, etc.
- Graduation: 0.1mm
- Laser engraved scale
- Made of stainless steel



7114-950

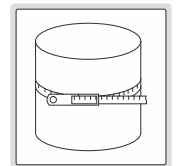

Code	Circumference range	Diameter range	Accuracy	
			circumference	diameter
7114-950	150-950mm	Ø50-300mm	±3mm	±1mm
7114-2200	940-2200mm	Ø300-700mm	±3mm	±1mm
7114-3460	2190-3460mm	Ø700-1100mm	±3mm	±1mm

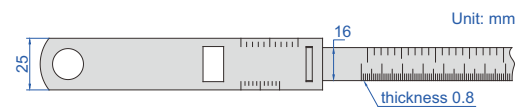

Unit: mm

## CIRCUMFERENCE TAPES

**INSIZE PLUS**  
MADE IN EUROPE

CAN SUPPLY TAPE WIDTH  
6MM, 35MM, 60MM

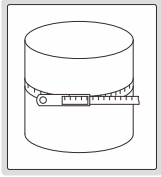

7115-3460

- Measure diameter and circumference of pipes, trees, tires, etc.
- Graduation: 0.1mm
- Laser engraved scale
- Made of stainless steel

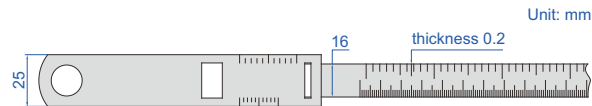

Unit: mm

7

Code	Circumference range	Diameter range	Accuracy	
			circumference	diameter
7115-950 *	150-950mm	Ø50-300mm	±0.60mm	±0.20mm
7115-2200	940-2200mm	Ø300-700mm	±0.60mm	±0.20mm
7115-3460	2190-3460mm	Ø700-1100mm	±0.60mm	±0.20mm
7115-4720	3450-4720mm	Ø1100-1500mm	±0.90mm	±0.30mm
7115-5980	4710-5980mm	Ø1500-1900mm	±0.90mm	±0.30mm
7115-7230	5970-7230mm	Ø1900-2300mm	±1.05mm	±0.35mm
7115-8500	7220-8500mm	Ø2300-2700mm	±1.20mm	±0.40mm
7115-9760	8490-9760mm	Ø2700-3100mm	±1.35mm	±0.45mm
7115-11010	9730-11010mm	Ø3100-3500mm	±1.50mm	±0.50mm

\*When diameter range is Ø50-100mm, the accuracy of circumference is ±0.90mm, diameter is ±0.30mm

## CIRCUMFERENCE TAPES

**INSIZE PLUS**  
MADE IN EUROPE

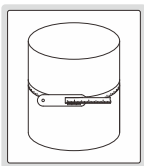

7116-115

- Measure diameter of cables, thin plastic pipes, etc., which may deform
- Laser engraved scale
- Made of stainless steel

Code	Diameter range	Graduation	Accuracy
7116-115	Ø20-115mm	0.05mm	±0.10mm
7116-230	Ø100-230mm	0.05mm	±0.10mm
7116-330	Ø200-330mm	0.05mm	±0.15mm
7116-620	Ø300-620mm	0.05mm	±0.20mm

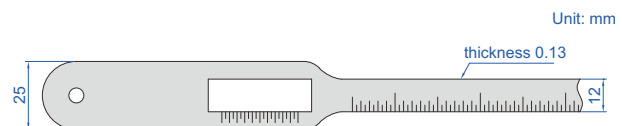

Unit: mm

REFER TO PAGE 420  
FOR DETAILS

### TAPER GAGES

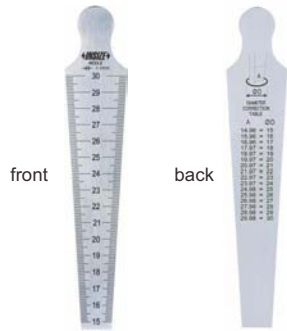

4833-2



front back

TAPER GAGE SET  
4837-1

REFER TO PAGE 421  
FOR DETAILS

### TAPER BORE GAGES



4852-15

REFER TO PAGE 421  
FOR DETAILS

### SMALL TAPER BORE GAGE



4855-5

REFER TO PAGE 429  
FOR DETAILS

### INSIDE SPRING CALIPERS



7261-150

# 08

## ARC RADIUS MEASUREMENT



Large Diameter Gages  
Page 207



Outside Diameter Variation Measuring  
Instruments  
Page 208



Outside Diameter Measuring  
Instruments  
Page 209



Digital Radius Gages  
Page 210



Digital Radius Gages  
Page 211-212



Digital Arc Radius Calipers  
Page 212



Digital Radius Calipers  
Page 213



Radius Gages  
Page 213

DATA  
OUTPUT



## LARGE DIAMETER GAGE CODE ISQ-RA600

**INSIZE PLUS**  
MADE IN EUROPE



- To measure large external or internal diameters
- Automatic judgment and display external or internal diameter
- Backlight LCD display, can rotate 180° for easy reading
- Memory of 12 readings and average calculation
- With minimum and maximum measurement mode
- Angle can be displayed



software flash disk  
(included)

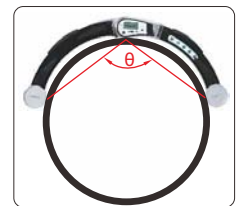

display of angle



external diameter measurement



internal diameter measurement



software (included),  
data output, save and print

### SPECIFICATION

Range	external	Ø500~6000mm/19.69~236.22"
	internal	Ø1100~6000mm/43.31~236.22"
Resolution		0.01mm/0.001"
Accuracy		$\pm(0.01+D^2/30)$ mm (D is the diameter to be measured, in meter)
Power supply		rechargeable battery (for 8 hours working)
Weight		3.8kg

### STANDARD DELIVERY

Main unit	1 pc
AC/DC adapter	1 pc
Software and USB cable	1 pc

### Accuracy sample by diameters

Diameter	Accuracy
500mm	±0.018mm
1000mm	±0.043mm
1500mm	±0.085mm
2000mm	±0.143mm
2500mm	±0.218mm
3000mm	±0.310mm
4000mm	±0.543mm
5000mm	±0.843mm
6000mm	±1.210mm

## OUTSIDE DIAMETER VARIATION MEASURING INSTRUMENTS

CAN BE  
CUSTOM-MADE

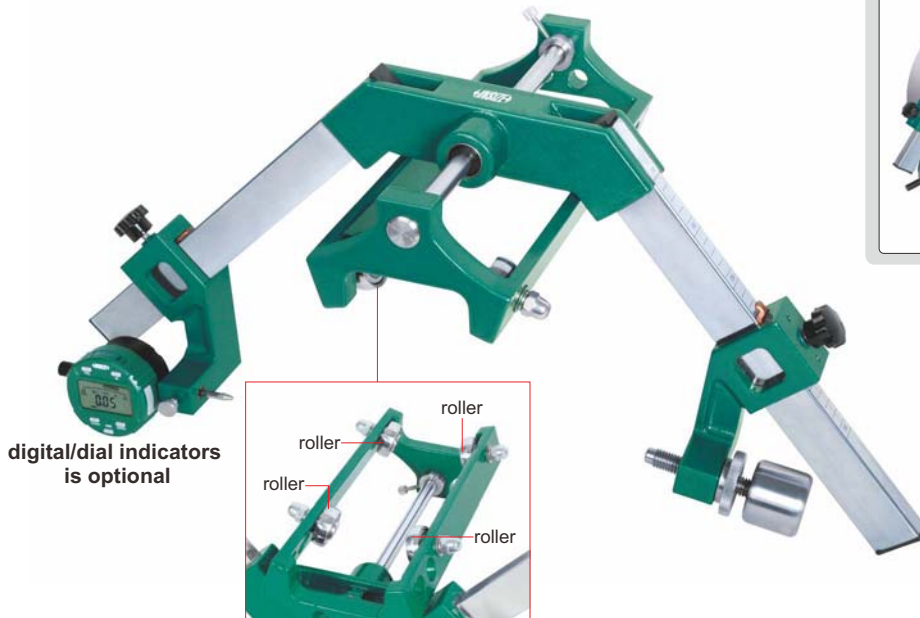

application



2715-350

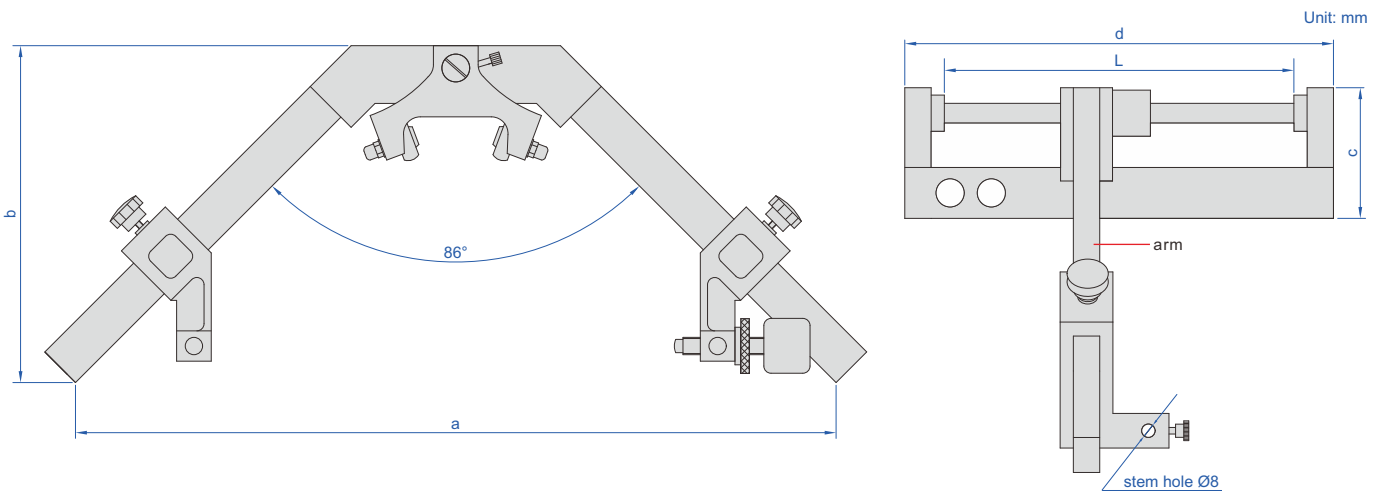

- Measurement of diameter variation, convexity, concavity, taper and other parameters
- Continuous measurement in the axis direction
- Four rollers are included
- Optional accessory: 0.01mm or 0.001mm graduation digital/dial indicators

(mm)									
Code	Range (diameter)	Accuracy	Repeatability	Arm moving range (L)	a	b	c	d	Weight
2715-350	100-350mm/4-14"	0.01mm	3µm	200mm	500	230	80	260	4kg
2715-500	200-500mm/8-20"	0.01mm	3µm	151mm	630	260	95	260	5kg
2715-700	300-700mm/12-28"	0.01mm	3µm	197mm	910	372	112	320	6.5kg
2715-1000	500-1000mm/20-40"	0.01mm	3µm	190mm	1170	460	120	320	8kg
2715-1600	800-1600mm/32-64"	0.02mm	6µm	202mm	1860	690	180	320	12.5kg
2715-2000	1400-2000mm/56-80"	0.02mm	6µm	232mm	2156	860	210	350	18.5kg





## OUTSIDE DIAMETER MEASURING INSTRUMENTS

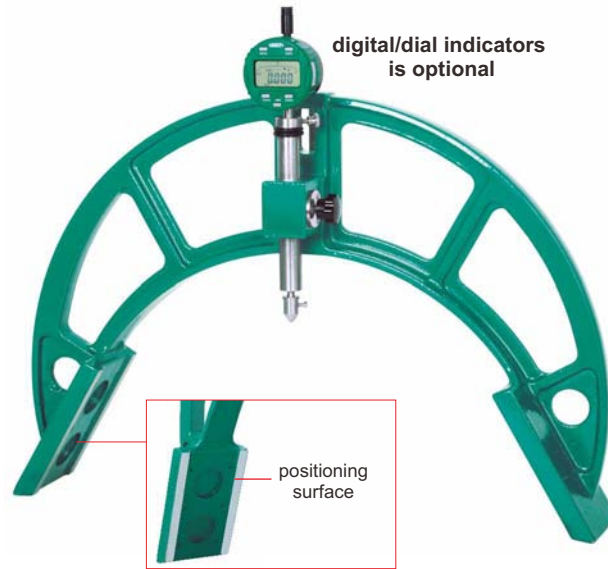

2716-500

- Need standard workpieces to set zero
- The frame is made of aluminum magnesium alloy with light weight and high strength
- Optional accessory: 0.01mm or 0.001mm digital/dial indicators

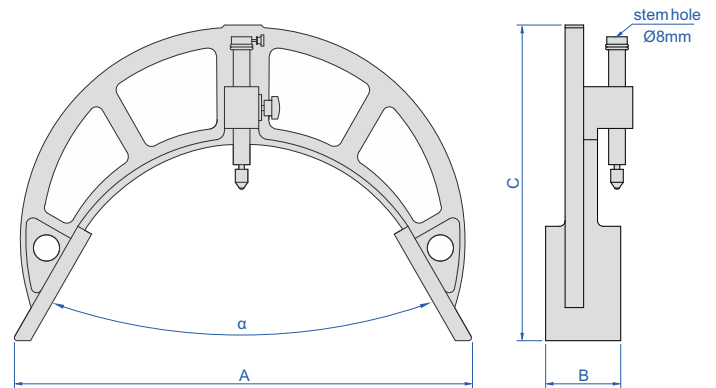

(mm)

Code	Range (diameter)	Repeatability	$\alpha$	A	B	C	Weight
2716-60	18-60	0.01mm	60°	140	60	160	1kg
2716-120	60-120	0.01mm	60°	166	65	162	1.5kg
2716-200	120-200	0.01mm	60°	225	70	228	2kg
2716-300	200-300	0.01mm	60°	330	80	262	2.5kg
2716-400	300-400	0.01mm	60°	405	80	303	4kg
2716-500	400-500	0.01mm	60°	494	80	340	5kg
2716-600	500-600	0.01mm	60°	594	80	398	6kg
2716-700	600-700	0.01mm	60°	685	80	446	7.5kg
2716-800	700-800	0.01mm	60°	772	80	479	9kg
2716-900	800-900	0.01mm	60°	860	80	520	10kg
2716-1000	900-1000	0.01mm	60°	950	80	560	11.5kg
2716-1100	1000-1100	0.01mm	60°	1035	90	575	13kg
2716-1200	1000-1200	0.01mm	83.62°	960	100	460	12kg
2716-1300	1100-1300	0.01mm	83.62°	1000	100	485	13.5kg
2716-1400	1200-1400	0.01mm	83.62°	1100	100	512	15kg
2716-1600	1400-1600	0.01mm	83.62°	1260	100	540	17kg
2716-1800	1600-1800	0.01mm	83.62°	1460	100	570	19kg
2716-2000	1800-2000	0.01mm	83.62°	1645	100	605	21kg

## DIGITAL RADIUS GAGES

DATA  
OUTPUT



2188-55



2188-233



2188-143



2188-323

8

- Measure radius of external arc, arc angle of measured surface should be larger than 60°
- Display radius value, no need to calculate
- Button function: on/off, zero, data preset, inch/mm
- Keep preset data in memory after restart
- CR2032 battery, automatic power off (time is adjustable)
- Data output
- Stainless steel base
- Optional accessory: setting standards, data output cable (code 7315-50M need receiver page 5, 7302-40M page 13)

application

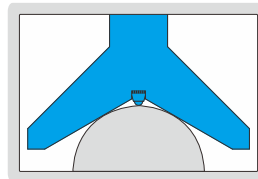

Unit: mm

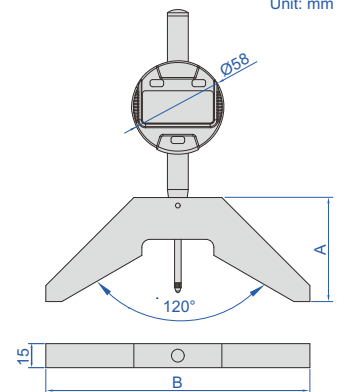

Code	Range (radius)	Resolution	Accuracy	A	B
2188-55	4-53mm/0.16-2.09"	0.01mm/0.0005"	±0.02mm	40mm	65mm
2188-143	48-143mm/1.89-5.63"	0.01mm/0.0005"	±0.03mm	65mm	165mm
2188-233	138-233mm/5.43-9.17"	0.01mm/0.0005"	±0.03mm	85mm	255mm
2188-323	228-323mm/8.98-12.72"	0.01mm/0.0005"	±0.04mm	95mm	345mm

### Setting standards

Code	Setting standards	Remark
4110-10D00	setting standard for 2188-55	included
2188-P143	setting standard for 2188-143	optional
2188-P233	setting standard for 2188-233	optional
2188-P323	setting standard for 2188-323	optional



2188-P143

setting standard application



## DIGITAL RADIUS GAGE (LOW ACCURACY)



DATA OUTPUT

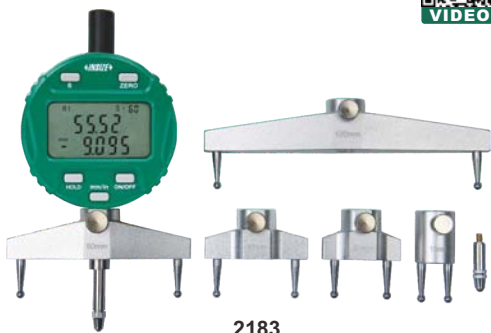

2183

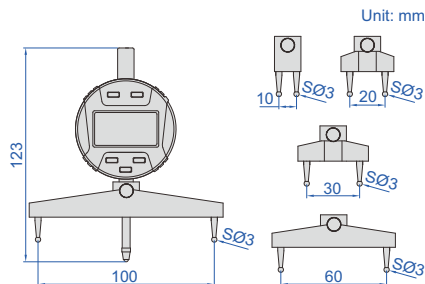

calibration standard application



- Resolution: 0.01mm/0.001"
- Buttons: on/off, hold, mm/inch, s (select jaws), zero
- Measure radius of internal or external arcs
- Display can be rotated by 320°
- Supplied with 5 jaws for different sizes of arc
- Data output
- Battery CR2032
- Automatic power off (time is adjustable)
- Optional accessory: calibration standard (code **2183-BLOCK**), data output cable (code **7315-2183 need receiver, 7302-2183**)

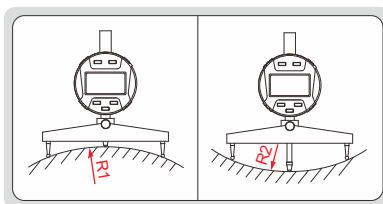

2183-BLOCK

Calibration standard (optional)

Code	Range of external radius (R1)	Range of internal radius (R2)	Accuracy (mm)
2183	5-910mm/0.2-35.83"	7-910mm/0.3-35.83"	±0.01R *

Code	Remark
2183-BLOCK	includes 5 standard blocks

\*R is the radius to be measured. For example, radius is 100mm, the accuracy is ±0.01x100=±1mm

DATA OUTPUT



## DIGITAL RADIUS GAGE

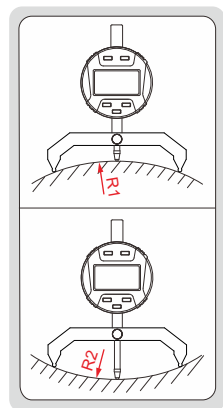

2511

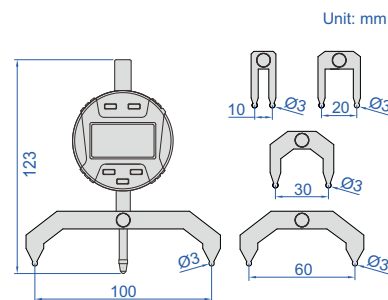

2183-BLOCK

Calibration standard (optional)

- Resolution: 0.01mm/0.001"
- Buttons: on/off, hold, mm/inch, s (select jaws), zero
- Measure radius of internal or external arcs
- Cylindrical measuring jaws, self-positioning
- Display can be rotated by 320°
- Supplied with 5 jaws for different sizes of arc
- Data output
- Battery CR2032
- Automatic power off (time is adjustable)
- Optional accessory: calibration standard (code **2183-BLOCK**), data output cable (code **7315-2183 need receiver, 7302-2183**)



Code	Range of external radius (R1)	Range of internal radius (R2)	Accuracy (mm)
2511	5-910mm/0.2-35.83"	7-910mm/0.3-35.83"	±0.005R *

Code	Remark
2183-BLOCK	includes 5 standard blocks

\*R is the radius to be measured. For example, radius is 100mm, the accuracy is ±0.005x100=±0.5mm

## LARGE RANGE DIGITAL RADIUS GAGE

DATA OUTPUT

Unit: mm



2197

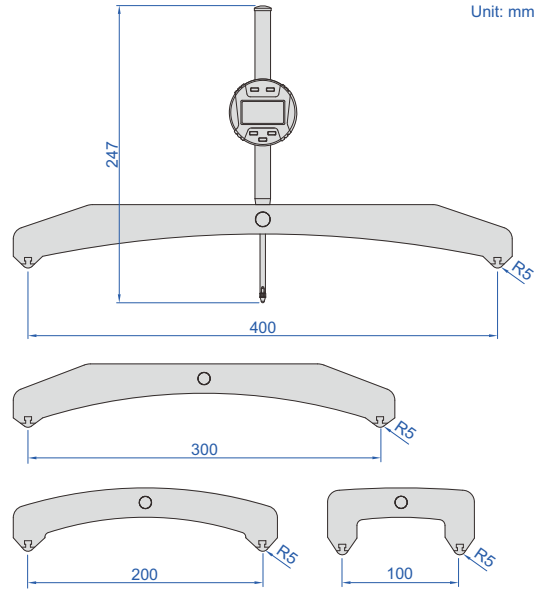

- Measure radius of internal or external arcs
- Resolution: 0.01mm/0.001"
- Buttons: on/off, hold, mm/inch, s (select jaws), zero
- Display can be rotated by 320°
- Supplied with 4 jaws for different sizes of arc
- Battery CR2032, automatic power off (time is adjustable)
- Data output
- Optional accessory: data output cable (code 7315-2183 need receiver, 7302-2183)

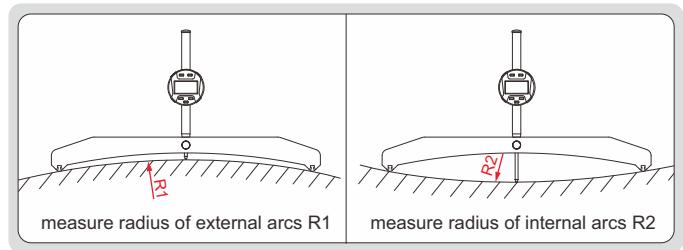

Code	Range of external radius (R1)	Range of internal radius (R2)	Accuracy (mm)
2197	100-15000mm/4-590"	100-15000mm/4-590"	±0.005R*

\*R is the radius to be measured. For example, radius is 100mm, the accuracy is ±0.005x100=±0.5mm



## DIGITAL ARC RADIUS CALIPERS

DATA OUTPUT

- Non waterproof
- Measure the radius of arc less than half round
- Resolution: 0.01mm/0.0005"
- Buttons: on/off, zero, mm/inch
- Automatic power off, move the digital unit to turn on power
- Battery CR2032
- Data output
- Made of stainless steel



1189-200B

With data interface (data output cable code 7315-21 need receiver page 4, 7302-21 page 12, optional)

Code	Range (R)	Accuracy	L	c	d
1189-150B	5-150mm/0.2-6"	±0.05mm	263mm	16mm	65mm
1189-200B	5-200mm/0.2-8"	±0.07mm	313mm	16mm	85mm

Built-in wireless (receiver code 7315-2/3/6/7/8/9 is required)

Code	Range (R)	Accuracy	L	c	d
1189-150BWL	5-150mm/0.2-6"	±0.05mm	263mm	16mm	65mm
1189-200BWL	5-200mm/0.2-8"	±0.07mm	313mm	16mm	85mm

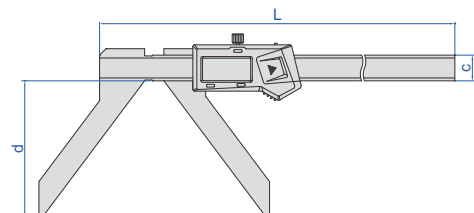
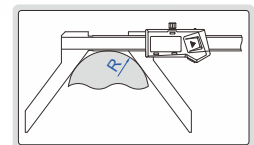

DATA  
OUTPUT

DIRECT READING,  
CALCULATION IS NOT REQUIRED

## DIGITAL RADIUS CALIPERS



1501-25



1501-10

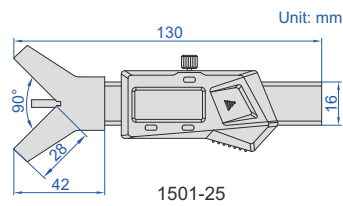

1501-25

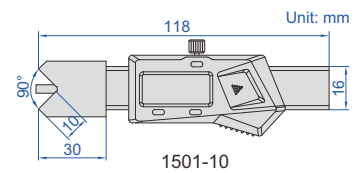

1501-10

- Non waterproof
- Measure radius of external arc, arc angle of measured surface should be larger than 90°
- Resolution: 0.01mm/0.0005"
- Buttons: on/off, zero, mm/inch
- Automatic power off, move the digital unit to turn on power
- Battery CR2032
- Data output
- Made of stainless steel
- Supplied with pin gage for zero setting
- Optional accessory: data output cable (code 7315-1529 need receiver, 7302-1529)

1501-10 can measure small workpieces or workpieces with steps

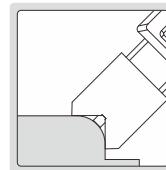

application

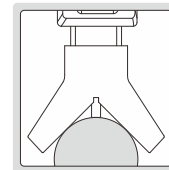

pin gage (included)



Code	Range (radius)	Accuracy
1501-25	2-25mm/0.079-1"	±0.05mm
1501-10	2-10mm/0.079-0.394"	±0.05mm

REFER TO PAGE 416  
FOR DETAILS

## RADIUS GAGES



4801-17



4802-31



RADIUS GAGE SET  
4804-26



Keyway Symmetry Gages  
Page 215



Keyway Symmetry Digital Calipers  
Page 215



Digital Keyway Depth Gages  
Page 216

application

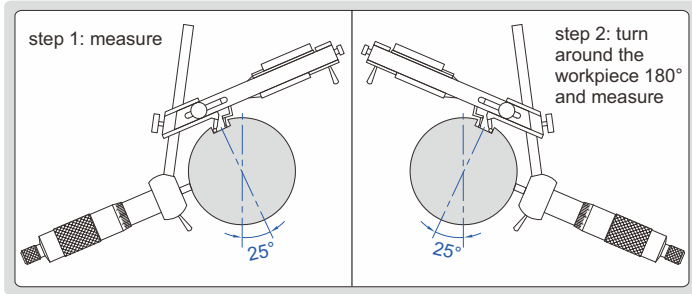

Unit: mm

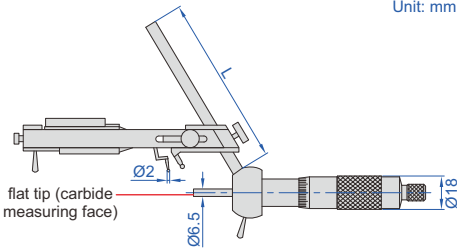

- Used to measure the symmetry of shaft keyways

KEYWAY SYMMETRY GAGE



4865-14

Code	Range		Graduation	Accuracy	L
	diameter of shaft	width of keyway			
4865-14	14-110mm	5-28mm	0.01mm	0.02mm	100mm

KEYWAY SYMMETRY DIGITAL CALIPERS

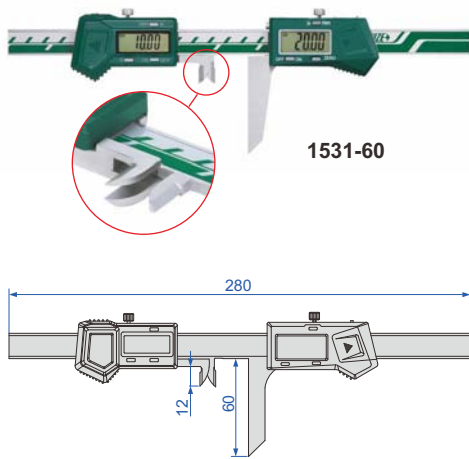

1531-60

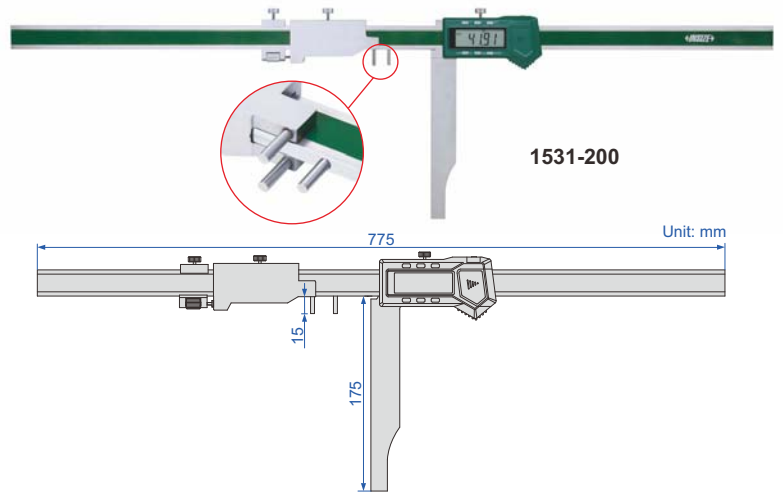

1531-200

Unit: mm

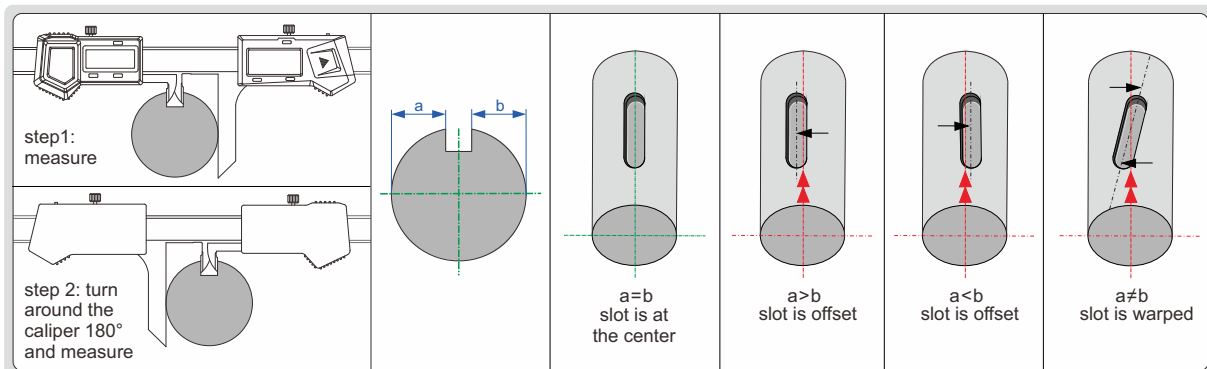

DATA OUTPUT

- Non waterproof
- Used to measure the symmetry of shaft keyways
- Resolution: 0.01mm/0.0005"
- Buttons: on/off, zero, mm/inch
- Automatic power off, move the digital unit to turn on power
- Battery CR2032, data output
- Made of stainless steel
- Optional accessory: data output cable (code 7315-22 need receiver page 4, 7302-22 page 12)

Code	Width of keyway	Diameter of shaft	Accuracy	Remark
1531-60	6-45mm	Ø10-120mm	±0.05mm	can measure keyway width
1531-200	3-250mm	Ø6-350mm	±0.05mm	cannot measure keyway width

## DIGITAL KEYWAY DEPTH GAGE

DATA  
OUTPUT

measure depth of keyway

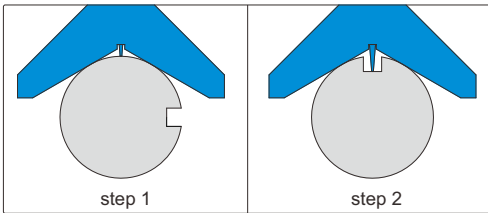
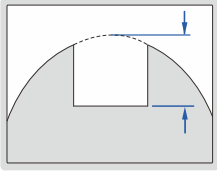

- Measure keyway depth of cylindrical workpieces with diameter  $\varnothing 10-100\text{mm}$
- Button function: on/off, zero, inch/metric conversion, absolute/incremental measurement, data preset, measuring direction change
- CR2032 battery, automatic power off (time is adjustable)
- Data output
- Stainless steel base
- Pointed tip
- Optional accessory: data output cable (code 7315-50M need receiver page 5, 7302-40M page 13)



2182-25

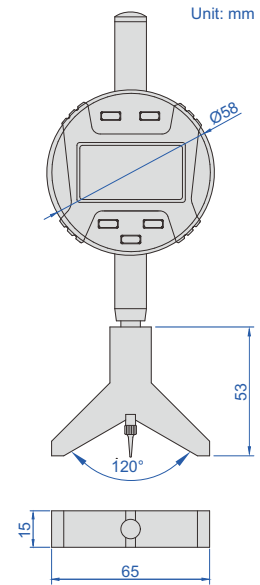

Code	Range	Resolution	Accuracy
2182-25	0-25.4mm/0-1"	0.01mm/0.0005"	$\pm 0.02\text{mm}$

## DIAL KEYWAY DEPTH GAGE

measure depth of keyway

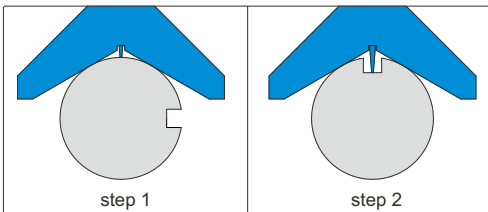
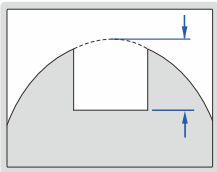

- Measure keyway depth of cylindrical workpieces with diameter  $\varnothing 10-100\text{mm}$
- Stainless steel base
- Pointed tip



2189-30

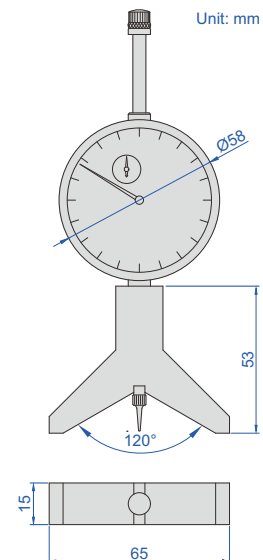

Code	Range	Graduation	Accuracy
2189-30	0-30mm	0.01mm	$\pm 0.03\text{mm}$





Digital Chamfer Gages  
Page 218



Chamfer Gages  
Page 219



Digital Chamfer Gages  
Page 219



Chamfer Height Gages  
Page 220

## CHAMFER GAGES



1267-6

- Measure 30°/45°/60° chamfer dimension
- Graduation: 0.02mm
- Made of stainless steel
- Satin chrome plated reading surface

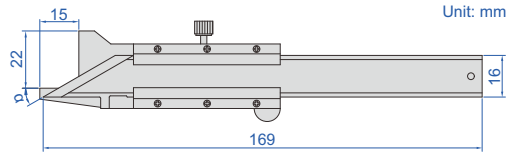

Code	Range	Accuracy	Chamfer ( $\alpha$ )	$\varnothing D$
1267-6	0-10mm	$\pm 0.06\text{mm}$	45°	7mm
1267-63	0-10mm	$\pm 0.06\text{mm}$	30°	8mm
1267-66	0-10mm	$\pm 0.06\text{mm}$	60°	7mm

for internal chamfer measurement, diameter should be larger than  $\varnothing D$

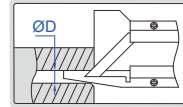

measure chamfer dimension

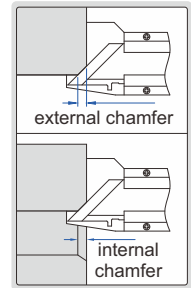

## DIGITAL CHAMFER GAGES

DATA OUTPUT



1180-6

- Non waterproof
- Measure 15°/20°/30°/45°/60° chamfer dimension
- Resolution: 0.01mm/0.0005"
- Buttons: on/off, zero, mm/inch
- Automatic power off, move the digital unit to turn on power
- Battery CR2032
- Data output
- Made of stainless steel

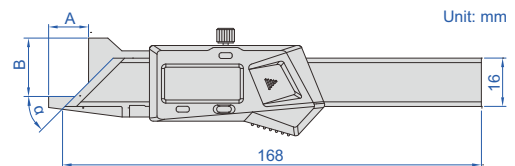

for internal chamfer measurement, diameter should be larger than  $\varnothing D$

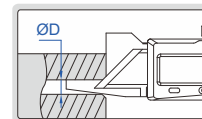

With data interface  
(data output cable code 7315-21 need receiver page 4, 7302-21 page 12, optional)

Code	Range	Accuracy	Chamfer ( $\alpha$ )	A	B	$\varnothing D$
1180-6	0-10mm/0-0.39"	$\pm 0.06\text{mm}$	45°	15mm	22mm	7mm
1180-61	0-10mm/0-0.39"	$\pm 0.06\text{mm}$	15°	33mm	20mm	11mm
1180-62	0-10mm/0-0.39"	$\pm 0.06\text{mm}$	20°	33mm	20mm	11mm
1180-63	0-10mm/0-0.39"	$\pm 0.06\text{mm}$	30°	15mm	22mm	8mm
1180-66	0-10mm/0-0.39"	$\pm 0.06\text{mm}$	60°	14mm	21mm	7mm

Built-in wireless (receiver code 7315-2/3/6/7/8/9 is required)

Code	Range	Accuracy	Chamfer ( $\alpha$ )	A	B	$\varnothing D$
1180-6WL	0-10mm/0-0.39"	$\pm 0.06\text{mm}$	45°	15mm	22mm	7mm
1180-61WL	0-10mm/0-0.39"	$\pm 0.06\text{mm}$	15°	33mm	20mm	11mm
1180-62WL	0-10mm/0-0.39"	$\pm 0.06\text{mm}$	20°	33mm	20mm	11mm
1180-63WL	0-10mm/0-0.39"	$\pm 0.06\text{mm}$	30°	15mm	22mm	8mm
1180-66WL	0-10mm/0-0.39"	$\pm 0.06\text{mm}$	60°	14mm	21mm	7mm

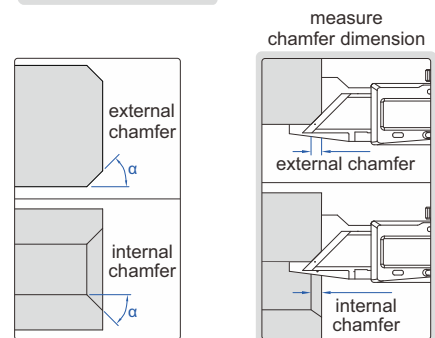

## CHAMFER GAGE

for internal chamfer measurement, diameter should be larger than  $\varnothing D$

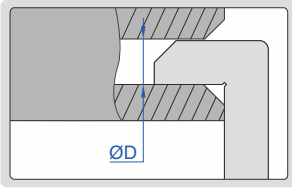

4844-1

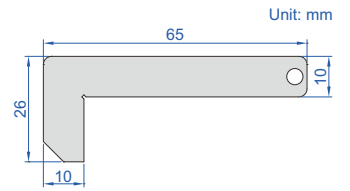

- To measure internal and external chamfers
- Made of stainless steel

Code	Graduation	Accuracy	$\varnothing D$
4844-1	0.5mm	$\pm 0.25\text{mm}$	11mm

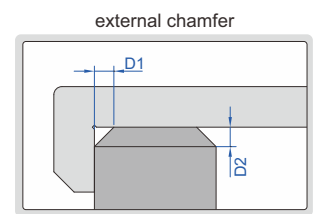
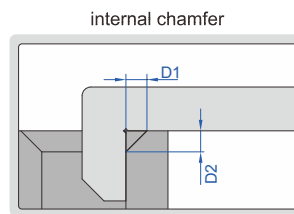

ATTENTION: CHAMFER OF HOLES CANNOT BE MEASURED

DATA OUTPUT

DIRECT READING, CALCULATION IS NOT REQUIRED

## DIGITAL CHAMFER GAGES



1537-20

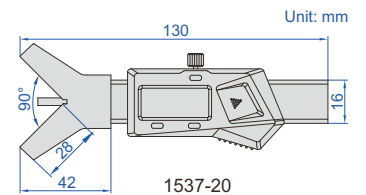

1537-8

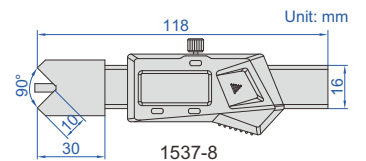

- Non waterproof
- Measure 45° chamfer length
- Resolution: 0.01mm/0.0005"
- Buttons: on/off, zero, mm/inch
- Automatic power off, move the digital unit to turn on power
- Battery CR2032
- Data output
- Made of stainless steel
- Supplied with pin gage for zero setting
- Optional accessory: data output cable (code 7315-1529 need receiver, 7302-1529)

Code	Range	Accuracy
1537-20	0-20mm/0-0.787"	$\pm 0.05\text{mm}$
1537-8	0-8mm/0-0.315"	$\pm 0.05\text{mm}$

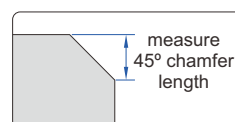

pin gage (included)



1537-8 can measure small workpieces or workpieces with steps

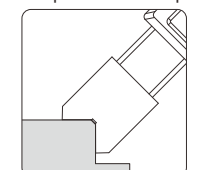

## CHAMFER HEIGHT GAGE

**INSIZE PLUS**  
MADE IN EUROPE

principle of measurement

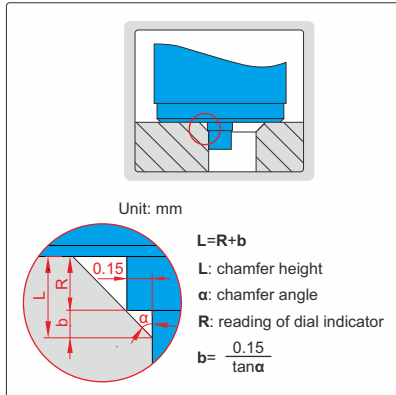

- Measure outside or inside chamfer height
- Suitable for diameter of bores  $\geq 6\text{mm}$ , chamfer angle  $\alpha \geq 30^\circ$
- Setting gage is included

Code	Range (L)	Graduation	Accuracy
2943-1	0.2-5mm	0.01mm	$\pm 0.02\text{mm}$



2943-1

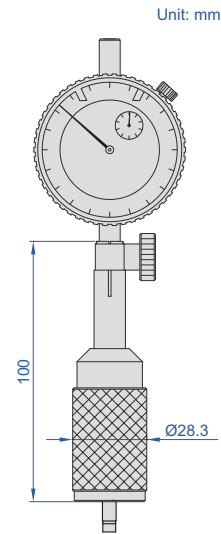

setting gage (included)



## DIGITAL CHAMFER HEIGHT GAGE

**INSIZE PLUS**  
MADE IN EUROPE

principle of measurement

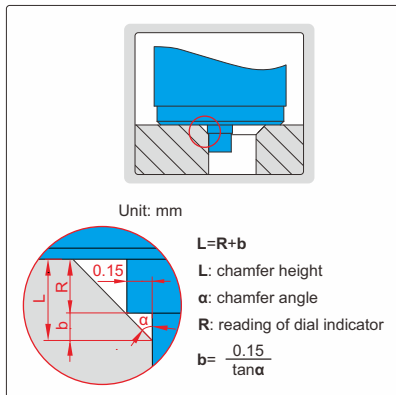

- Measure outside or inside chamfer height
- Suitable for diameter of bores  $\geq 6\text{mm}$ , chamfer angle  $\alpha \geq 30^\circ$
- Resolution: 0.01mm/0.0005"
- Setting gage is included
- Optional accessory: data output cable (code 7315-50M need receiver page 5, 7302-40M page 13)

Code	Range (L)	Accuracy
2944-1	0.2-5mm/0.008-0.197"	$\pm 0.02\text{mm}$



2944-1

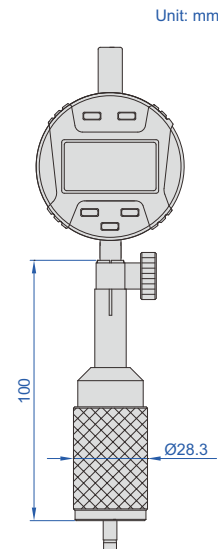

setting gage (included)



# INDICATORS, LINEAR GAGES, DIAL INDICATOR STANDS

# 11



Dial Test Indicators  
Page 222-226



Styli For Dial Test Indicators  
Page 226



Digital Indicators  
Page 227-239



Zeroing Foot Switches  
Page 236



High Precision Digital  
Indicators  
Page 240



Dial Comparators  
Page 240



Dial Indicators  
Page 241-250



Points  
Page 250-252



Spindle Lift Knobs  
Page 253



Shaft Sleeves  
Page 253



Backs  
Page 253-254



Dial Indicator Testers  
Page 255



Optical Grating Linear  
Gages And Display Units  
Page 256-259



Capacitance Type Linear  
Gages And Display Units  
Page 260-262



Dial Test Indicator Holders  
Page 263-264



Magnetic Stands  
Page 265-270



Dial Indicator Stands  
(non-magnetic)  
Page 270-271



Dial Indicator Stands  
Page 272-278

## PRECISION DIAL TEST INDICATOR

**INSIZE PLUS**  
MADE IN EUROPE

**INSPECTION CERTIFICATE**

ANTI MAGNETIC  
CARBIDE CONTACT POINT

- Meet DIN2270
- Ceramic bearing
- Anti magnetic carbide contact point
- Two measuring directions
- Supplied with one clamp: diameter Ø8mm
- Optional accessory: styli (page 226)



2897-02

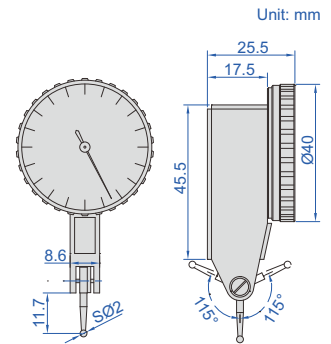
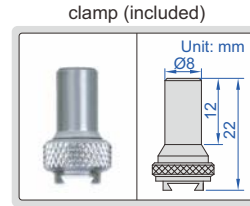

Code	Range	Graduation	Accuracy	Hysteresis	Dial reading
2897-02 *	0.2mm	0.001mm	4µm	2µm	0-100-0

\* Supplied with manufacturer inspection certificate

## PRECISION DIAL TEST INDICATORS

**INSIZE PLUS**  
MADE IN EUROPE

**INSPECTION CERTIFICATE**

- Meet DIN2270
- Ceramic bearing
- Two measuring directions
- Supplied with one clamp: diameter Ø8mm
- Optional accessory: styli (page 226)



2880-02

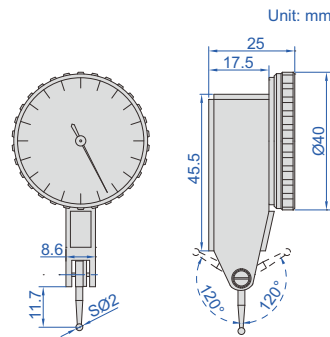

ruby contact  
point of 2880-02R



clamp (included)

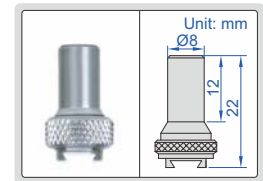

Code	Range	Graduation	Accuracy	Hysteresis	Dial reading	Remark
2880-02 *	0.2mm	0.002mm	4µm	2µm	0-100-0	anti magnetic carbide contact point
2880-02R *	0.2mm	0.002mm	4µm	2µm	0-100-0	ruby contact point

\* Supplied with manufacturer inspection certificate

## DIAL TEST INDICATORS

JEWELLED  
BEARING

**INSPECTION CERTIFICATE**

POPULAR  
MODEL

- Meet DIN2270 (except 2380-02, 2381-02, 2381-021)
- Jeweled bearing
- Carbide contact point
- Two measuring directions
- Anti magnetic body
- Supplied with two clamps: diameter Ø4mm and Ø8mm
- Optional accessory: styli (page 226)

clamp (included)

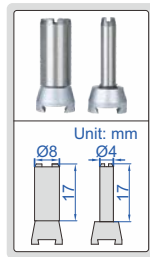

2380-08

(mm)

Code	Range	Graduation	Accuracy	Hysteresis	Dial reading	A	L
2380-08 *	0.8mm	0.01mm	13µm	3µm	0-40-0	Ø30	13.5
2381-08 *	0.8mm	0.01mm	13µm	3µm	0-40-0	Ø37	13.5
2380-02 *	0.2mm	0.002mm	6µm	2µm	0-100-0	Ø30	12.5
2381-02 *	0.2mm	0.002mm	6µm	2µm	0-100-0	Ø37	12.5
2381-021 *	0.2mm	0.001mm	6µm	2µm	0-100-0	Ø37	12.5

\* Supplied with manufacturer inspection certificate

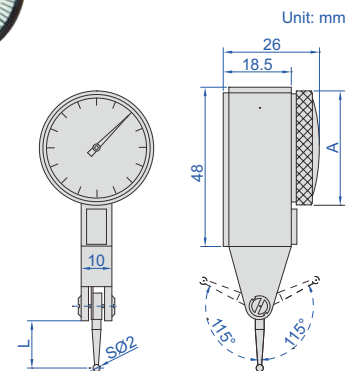

JEWELLED BEARING

**INSPECTION CERTIFICATE**

**INCH DIAL TEST INDICATORS**

- Jeweled bearing
- Carbide contact point
- Two measuring directions
- Anti magnetic body
- Supplied with two clamps: 5/32" DIA and 3/8" DIA



2380-31

Code	Range	Graduation	Accuracy	Dial reading	A	L
2380-31 *	0.03"	0.001"	±0.001"	0-15-0	1.181" DIA	0.50"
2380-35 *	0.03"	0.0005"	±0.0005"	0-15-0	1.181" DIA	0.50"
2380-301*	0.008"	0.0001"	±0.0001"	0-40-0	1.181" DIA	0.563"
2381-31 *	0.03"	0.001"	±0.001"	0-15-0	1.457" DIA	0.50"
2381-35 *	0.03"	0.0005"	±0.0005"	0-15-0	1.457" DIA	0.50"
2381-301*	0.008"	0.0001"	±0.0001"	0-40-0	1.457" DIA	0.563"

\*Supplied with manufacturer inspection certificate

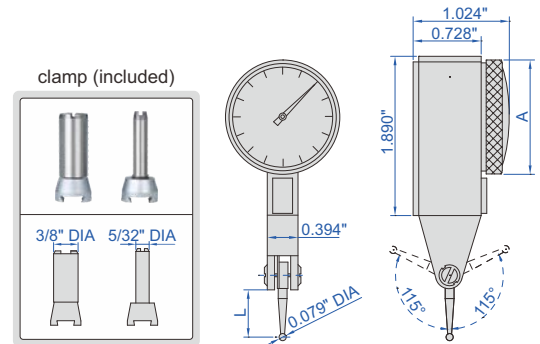

ANTI MAGNETIC CARBIDE CONTACT POINT

**INSPECTION CERTIFICATE**

**DIAL TEST INDICATOR**

**INSIZE PLUS**  
MADE IN EUROPE

- Meet DIN2270
- Ceramic bearing
- Anti magnetic carbide contact point
- Two measuring directions
- Supplied with one clamp: diameter Ø8mm
- Optional accessory: styli (page 226)



2895-08

Code	Range	Graduation	Accuracy	Hysteresis	Dial reading
2895-08 *	0.8mm	0.01mm	13µm	3µm	0-40-0

\*Supplied with manufacturer inspection certificate

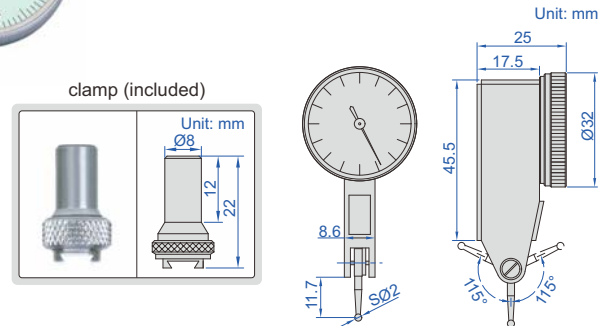

ANTI MAGNETIC CARBIDE CONTACT POINT

**INSPECTION CERTIFICATE**

**LONG STYLUS DIAL TEST INDICATOR**

**INSIZE PLUS**  
MADE IN EUROPE

- Meet DIN2270
- Ceramic bearing
- Anti magnetic carbide contact point
- Two measuring directions
- Supplied with one clamp: diameter Ø8mm
- Optional accessory: styli (page 226)



2896-05

Code	Range	Graduation	Accuracy	Hysteresis	Dial reading
2896-05 *	0.5mm	0.01mm	13µm	3µm	0-25-0

\*Supplied with manufacturer inspection certificate

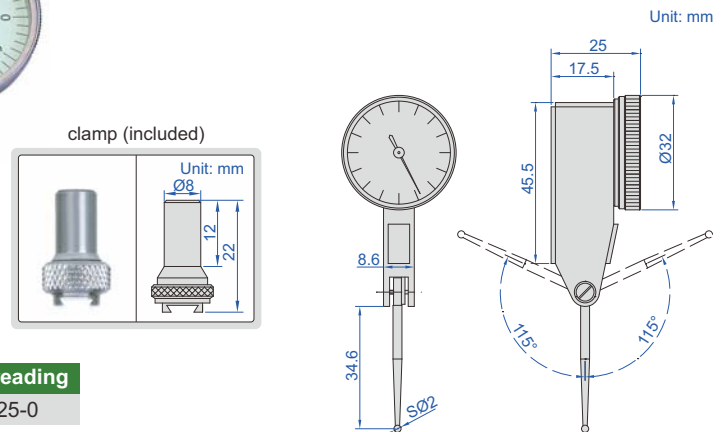

## LONG STYLUS DIAL TEST INDICATOR

- Meet DIN2270
- Jeweled bearing
- Carbide contact point
- Two measuring directions
- Anti magnetic body
- Supplied with two clamps: diameter Ø4mm and Ø8mm
- Optional accessory: styli (page 226)



2383-08A

Code	Range	Graduation	Accuracy	Hysteresis	Dial reading
2383-08A*	0.8mm	0.01mm	13µm	3µm	0-40-0

\*Supplied with manufacturer inspection certificate

JEWELLED BEARING

INSPECTION CERTIFICATE

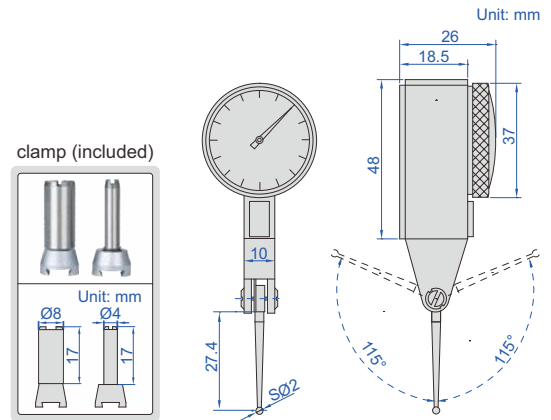

## VERTICAL TYPE LONG STYLUS DIAL TEST INDICATOR

**INSIZE PLUS**  
MADE IN EUROPE

ANTI MAGNETIC CARBIDE CONTACT POINT

INSPECTION CERTIFICATE

- Meet DIN2270
- Ceramic bearing
- Anti magnetic carbide contact point
- Two measuring directions
- Supplied with one clamp: diameter Ø8mm
- Optional accessory: styli (page 226)

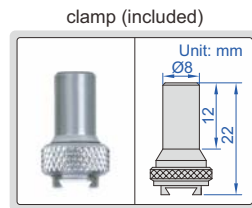

2899-05

Code	Range	Graduation	Accuracy	Hysteresis	Dial reading
2899-05*	0.5mm	0.01mm	13µm	3µm	0-25-0

\*Supplied with manufacturer inspection certificate

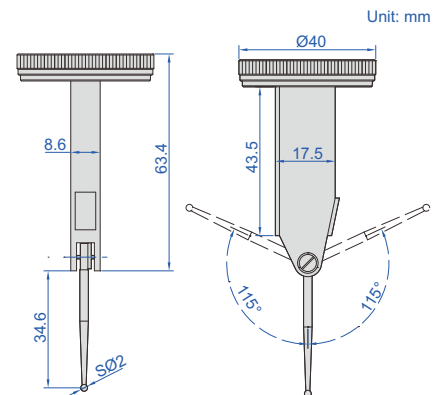

## VERTICAL TYPE DIAL TEST INDICATOR

- Meet DIN2270
- Jeweled bearing
- Carbide contact point
- Two measuring directions
- Anti magnetic body
- Supplied with two clamps: diameter Ø4mm and Ø8mm
- Optional accessory: styli (page 226)

clamp (included)

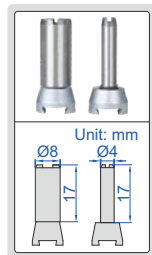

2398-08

Code	Range	Graduation	Accuracy	Hysteresis	Dial reading
2398-08*	0.8mm	0.01mm	13µm	3µm	0-40-0

\*Supplied with manufacturer inspection certificate

JEWELLED BEARING

INSPECTION CERTIFICATE

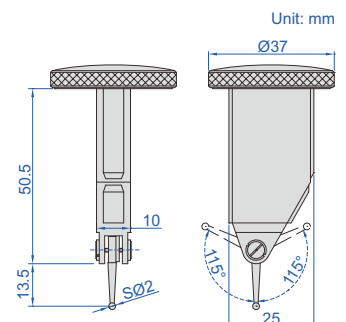



ANTI MAGNETIC  
CARBIDE CONTACT POINT

INSPECTION  
CERTIFICATE

## SIDE TYPE DIAL TEST INDICATOR

INSIZE PLUS  
MADE IN EUROPE

- Meet DIN2270
- Ceramic bearing
- Anti magnetic carbide contact point
- Two measuring directions
- Supplied with one clamp:  
diameter Ø8mm
- Optional accessory: styli (page 226)



2898-08

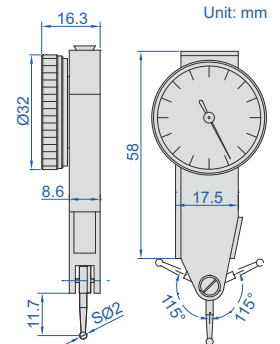
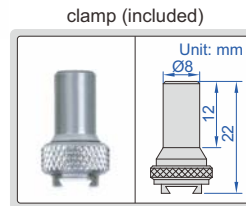

Code	Range	Graduation	Accuracy	Hysteresis	Dial reading
2898-08*	0.8mm	0.01mm	13µm	3µm	0-40-0

\*Supplied with manufacturer inspection certificate

INSPECTION  
CERTIFICATE

JEWELLED  
BEARING

## TILTED FACE TYPE DIAL TEST INDICATOR

- Meet DIN2270
- Jeweled bearing
- Carbide contact point
- Two measuring directions
- Anti magnetic body
- Supplied with two clamps:  
diameter Ø4mm and Ø8mm
- Optional accessory: styli (page 226)



2399-08

clamp (included)

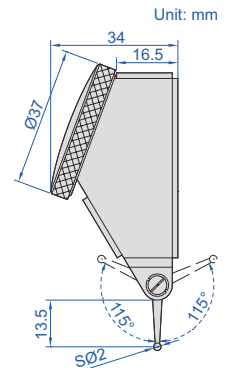
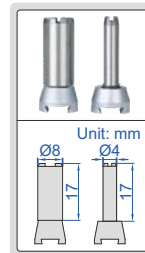

Code	Range	Graduation	Accuracy	Hysteresis	Dial reading
2399-08*	0.8mm	0.01mm	13µm	3µm	0-40-0

\*Supplied with manufacturer inspection certificate

INSPECTION  
CERTIFICATE

JEWELLED  
BEARING

## LARGE RANGE DIAL TEST INDICATOR

- Dial reading: 0-40-0
- Jeweled bearing
- Carbide contact point
- Two measuring directions
- Anti magnetic body
- Supplied with two clamps:  
diameter Ø4mm and Ø8mm
- Optional accessory: styli (page 226)



2386-16A

clamp (included)

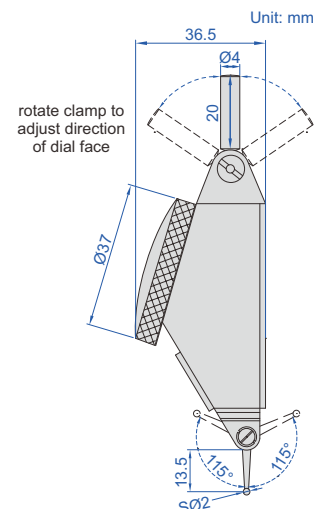
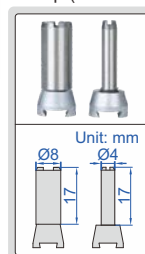

Code	Range	Graduation	Accuracy	Hysteresis
2386-16A*	1.6mm	0.01mm	25µm	8µm

\*Supplied with manufacturer inspection certificate

## LARGE RANGE VERTICAL TYPE DIAL TEST INDICATOR

JEWELLED BEARING

INSPECTION CERTIFICATE

- Dial Reading: 0-40-0
- Jeweled bearing
- Carbide contact point
- Two measuring directions
- Anti magnetic body
- Supplied with two clamps: diameter Ø4mm and Ø8mm
- Optional accessory: styli (page 226)

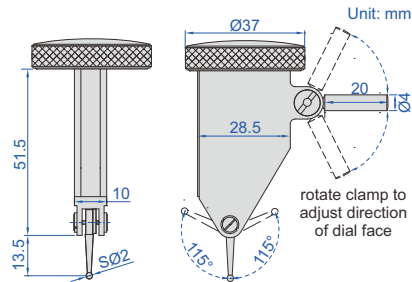

2480-16

clamp (included)

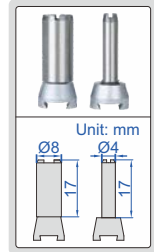

Code	Range	Graduation	Accuracy	Hysteresis
2480-16*	1.6mm	0.01mm	18µm	3µm

\* Supplied with manufacturer inspection certificate

## CLAMPS FOR DIAL TEST INDICATORS



6298-1



6298-2



Code	ØD
6298-1	Ø4mm
6298-2	Ø8mm

11

## STYLI FOR DIAL TEST INDICATORS

Code	For dial test indicator	Material of contact point	L	D
6284-1	2380-08	steel	13.5mm	SØ1mm
6284-31		ruby	13.5mm	SØ1mm
6284-3	2381-08	carbide	13.5mm	SØ2mm
6284-4		ruby	13.5mm	SØ2mm
6284-8	2399-08	carbide	13.5mm	SØ3mm
6284-21		steel	12.5mm	SØ1mm
6284-22	2380-02	carbide	12.5mm	SØ2mm
6284-24		ruby	12.5mm	SØ2mm
6284-23	2381-021	carbide	12.5mm	SØ3mm
6284-61	2386-16A 2480-16	steel	13.5mm	SØ1mm
6284-62		carbide	13.5mm	SØ2mm
6284-63		ruby	13.5mm	SØ2mm
6284-64		carbide	13.5mm	SØ3mm
6284-81	2383-08A	steel	27.4mm	SØ1mm
6284-82		carbide	27.4mm	SØ2mm
6284-83		ruby	27.4mm	SØ2mm
6284-84		carbide	27.4mm	SØ3mm



6284-3

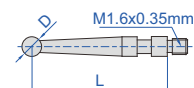

DATA  
OUTPUT

INSPECTION  
CERTIFICATE

## DIGITAL INDICATORS (STANDARD TYPE)

POPULAR  
MODEL

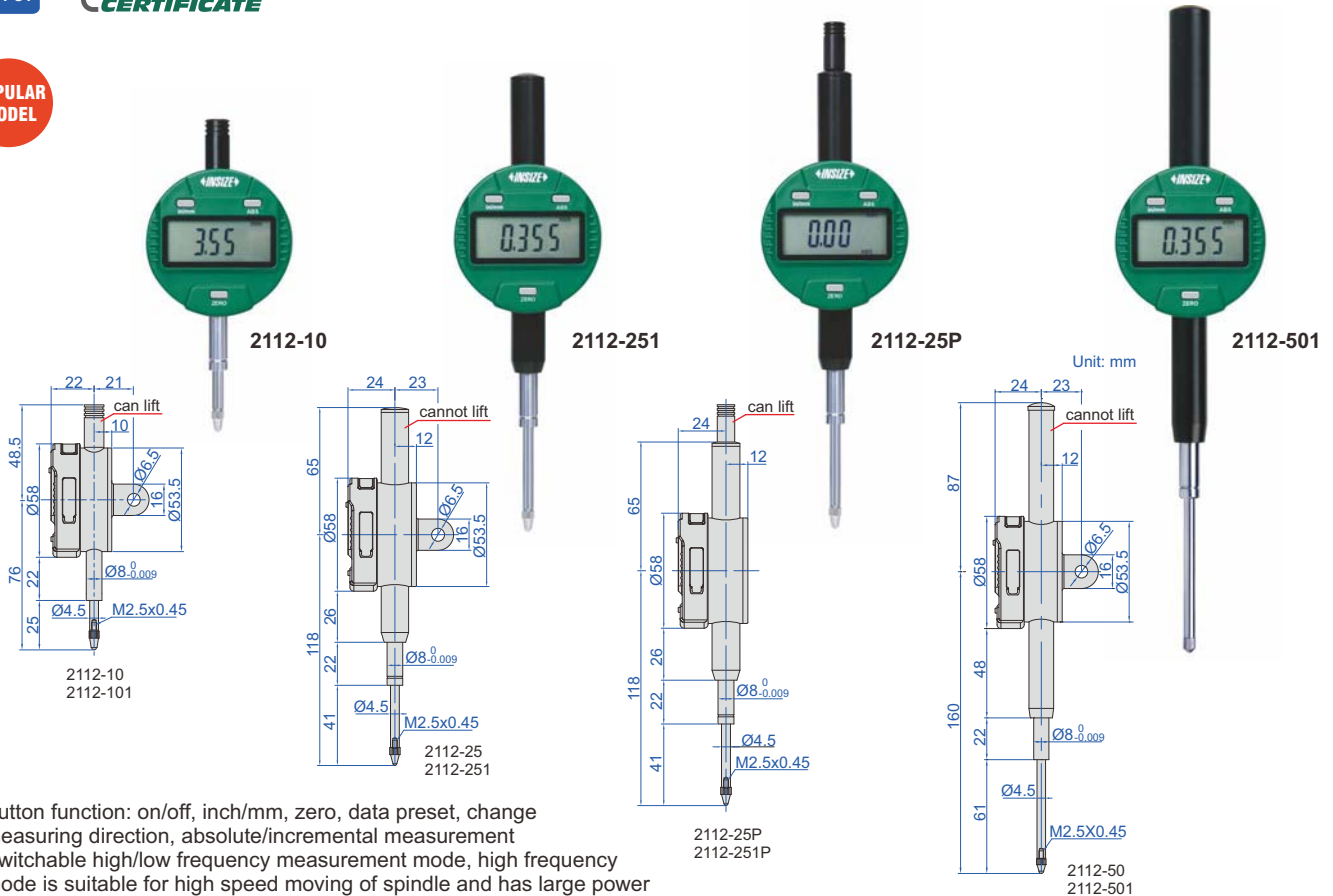

- Button function: on/off, inch/mm, zero, data preset, change measuring direction, absolute/incremental measurement
- Switchable high/low frequency measurement mode, high frequency mode is suitable for high speed moving of spindle and has large power consumption, low power consumption in low frequency mode
- Keep preset data in memory after restart
- CR2032 battery, automatic power off (time is adjustable)
- Data output
- Optional accessory: data output cable (code **7315-50M** need receiver page 5, **7302-40M** page 13, **7305-40M** page 9), backs (page 253~254), contact points (page 250~252)

### Resolution 0.001mm/0.00005"

Code	Range	Accuracy	Hysteresis	Maximum measuring force	Remark
<b>2112-101F*</b>	12.7mm/0.5"	5µm	2µm	1.5N	flat back
<b>2112-251F*</b>	25.4mm/1"	5µm	3µm	2.2N	flat back
<b>2112-501F*</b>	50.8mm/2"	6µm	3µm	2.5N	flat back
<b>2112-101*</b>	12.7mm/0.5"	5µm	2µm	1.5N	lug back
<b>2112-251*</b>	25.4mm/1"	5µm	3µm	2.2N	lug back
<b>2112-501*</b>	50.8mm/2"	6µm	3µm	2.5N	lug back
<b>2112-251P*</b>	25.4mm/1"	5µm	3µm	2.2N	flat back, with lift cap
<b>2112-501P*</b>	50.8mm/2"	6µm	3µm	2.5N	flat back, with lift cap

### Resolution 0.01mm/0.0005"

Code	Range	Accuracy	Hysteresis	Maximum measuring force	Remark
<b>2112-10F*</b>	12.7mm/0.5"	20µm	10µm	1.5N	flat back
<b>2112-25F*</b>	25.4mm/1"	20µm	10µm	2.2N	flat back
<b>2112-50F*</b>	50.8mm/2"	30µm	10µm	2.5N	flat back
<b>2112-10*</b>	12.7mm/0.5"	20µm	10µm	1.5N	lug back
<b>2112-25*</b>	25.4mm/1"	20µm	10µm	2.2N	lug back
<b>2112-50*</b>	50.8mm/2"	30µm	10µm	2.5N	lug back
<b>2112-25P*</b>	25.4mm/1"	20µm	10µm	2.2N	flat back, with lift cap
<b>2112-50P*</b>	50.8mm/2"	30µm	10µm	2.5N	flat back, with lift cap

\* Supplied with manufacturer inspection certificate

### 2112-251P/501P/25P/50P



spindle lift knob is included



## METRIC DIGITAL INDICATORS

DATA OUTPUT

INSPECTION CERTIFICATE



2116-10

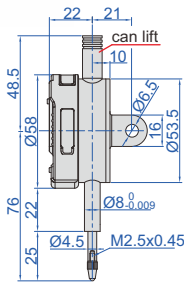

2116-10  
2116-101



2116-251

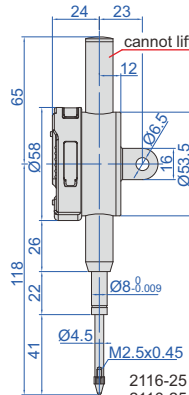

2116-25  
2116-251



2116-251P

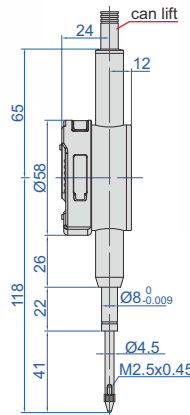

2116-25P  
2116-251P



2116-501

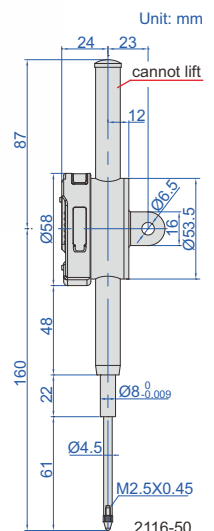

Unit: mm

2116-50  
2116-501

- Button function: on/off, zero, data preset, change measuring direction, absolute/incremental measurement
- Switchable high/low frequency measurement mode, high frequency mode is suitable for high speed moving of spindle and has large power consumption, low power consumption in low frequency mode
- Keep preset data in memory after restart
- CR2032 battery, automatic power off (time is adjustable)
- Data output
- Optional accessory: data output cable (code **7315-50M** need receiver page 5, **7302-40M** page 13, **7305-40M** page 9), backs (page 253~254), contact points (page 250~252)

### Resolution 0.001mm

Code	Range	Accuracy	Hysteresis	Maximum measuring force	Remark
2116-101F*	12.7mm	5µm	2µm	1.5N	flat back
2116-251F*	25.4mm	5µm	3µm	2.2N	flat back
2116-501F*	50.8mm	6µm	3µm	2.5N	flat back
2116-101*	12.7mm	5µm	2µm	1.5N	lug back
2116-251*	25.4mm	5µm	3µm	2.2N	lug back
2116-501*	50.8mm	6µm	3µm	2.5N	lug back
2116-251P*	25.4mm	5µm	3µm	2.2N	flat back, with lift cap
2116-501P*	50.8mm	6µm	3µm	2.5N	flat back, with lift cap

### Resolution 0.01mm

Code	Range	Accuracy	Hysteresis	Maximum measuring force	Remark
2116-10F*	12.7mm	20µm	10µm	1.5N	flat back
2116-25F*	25.4mm	20µm	10µm	2.2N	flat back
2116-50F*	50.8mm	30µm	10µm	2.5N	flat back
2116-10*	12.7mm	20µm	10µm	1.5N	lug back
2116-25*	25.4mm	20µm	10µm	2.2N	lug back
2116-50*	50.8mm	30µm	10µm	2.5N	lug back
2116-25P*	25.4mm	20µm	10µm	2.2N	flat back, with lift cap
2116-50P*	50.8mm	30µm	10µm	2.5N	flat back, with lift cap

\*Supplied with manufacturer inspection certificate

### 2116-251P/501P/25P/50P



spindle lift knob is included





DIGITAL INDICATORS (ADVANCED TYPE)

DATA OUTPUT



2103-10



2104-25



2104-25P



2103-50

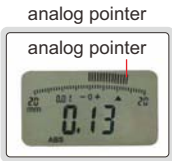

analog pointer

analog pointer



spindle lift knob is included

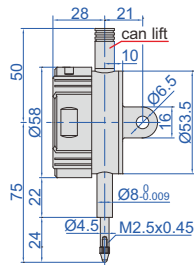

2103-10  
2104-10

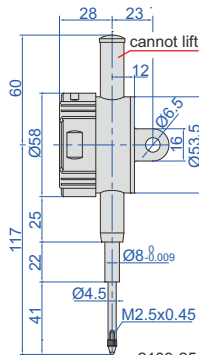

2103-25  
2104-25

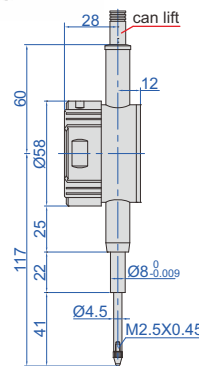

2103-25P  
2104-25P

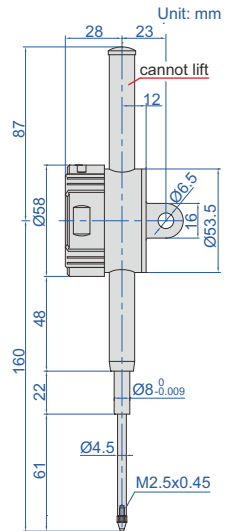

2103-50  
2104-50

- Reading in digital and analog
- Display can be rotated by 320°
- Button function: tolerance Go and No-Go display, data preset, measuring direction change, max./min./TIR measurement, inch/metric conversion, absolute/incremental measurement
- Keep preset data and tolerance data in memory after restart
- CR2032 battery, automatic power off (time is adjustable), data output
- Optional accessory: data output cable (code **7315-50M** need receiver page 5, **7302-40M** page 13, **7305-40M** page 9), backs (page 253-254), contact points (page 250-252)

max./min./TIR

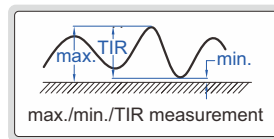

Resolution 0.001mm/0.0005"

Code	Range	Accuracy	Hysteresis	Maximum measuring force	Remark
2103-10F*	12.7mm/0.5"	5µm	2µm	1.5N	flat back
2103-25F*	25.4mm/1"	5µm	3µm	2.2N	flat back
2103-50F*	50.8mm/2"	6µm	3µm	2.5N	flat back
2103-10*	12.7mm/0.5"	5µm	2µm	1.5N	lug back
2103-25*	25.4mm/1"	5µm	3µm	2.2N	lug back
2103-50*	50.8mm/2"	6µm	3µm	2.5N	lug back
2103-25P*	25.4mm/1"	5µm	3µm	2.2N	flat back, with lift cap
2103-50P*	50.8mm/2"	6µm	3µm	2.5N	flat back, with lift cap

alarm when over tolerance

blink when over lower limit    blink when over upper limit



Resolution 0.01mm/0.0005"

Code	Range	Accuracy	Hysteresis	Maximum measuring force	Remark
2104-10F*	12.7mm/0.5"	20µm	10µm	1.5N	flat back
2104-25F*	25.4mm/1"	20µm	10µm	2.2N	flat back
2104-50F*	50.8mm/2"	30µm	10µm	2.5N	flat back
2104-10*	12.7mm/0.5"	20µm	10µm	1.5N	lug back
2104-25*	25.4mm/1"	20µm	10µm	2.2N	lug back
2104-50*	50.8mm/2"	30µm	10µm	2.5N	lug back
2104-25P*	25.4mm/1"	20µm	10µm	2.2N	flat back, with lift cap
2104-50P*	50.8mm/2"	30µm	10µm	2.5N	flat back, with lift cap

2103-25P/50P  
2104-25P/50P



display can be rotated by 320°



pull lift cap to lift point

\* Supplied with manufacturer inspection certificate

## DIGITAL INDICATORS (WITH TRANSMISSION BUTTON AND SIGNAL LIGHT)



DATA OUTPUT



2138-10

press the button to transmit data  
data transmission signal light



2139-25

press the button to transmit data  
data transmission signal light



2139-25P

press the button to transmit data  
data transmission signal light



2138-50

press the button to transmit data  
data transmission signal light

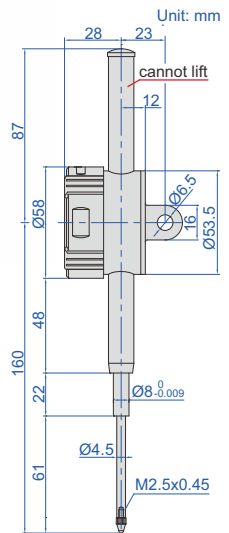
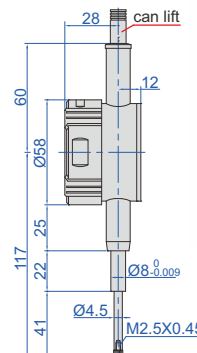
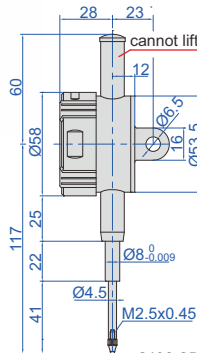
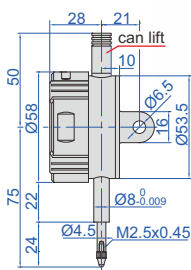

- Reading in digital and analog
- Display can be rotated by 320°
- Button function: on/off, zero, tolerance Go and No-Go display, data preset, measuring direction change, max./min./TIR measurement, inch/metric conversion, absolute/incremental measurement, data output
- Keep preset data and tolerance data in memory after restart
- CR2032 battery, automatic power off (time is adjustable)
- Data output
- Optional accessory: data output cable (flat back: code **7315-51** need receiver page 5, **7302-40M** page 13, **7305-40M** page 9; lug back: code **7315-50M** need receiver page 5, **7302-40M** page 13, **7305-40M** page 9), backs (page 253~254), contact points (page 250~252)

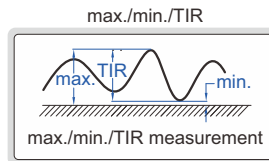

### Resolution 0.001mm/0.0005"

Code	Range	Accuracy	Hysteresis	Maximum measuring force	Remark
2138-10F*	12.7mm/0.5"	5µm	2µm	1.5N	flat back
2138-25F*	25.4mm/1"	5µm	3µm	2.2N	flat back
2138-50F*	50.8mm/2"	6µm	3µm	2.5N	flat back
2138-10*	12.7mm/0.5"	5µm	2µm	1.5N	lug back
2138-25*	25.4mm/1"	5µm	3µm	2.2N	lug back
2138-50*	50.8mm/2"	6µm	3µm	2.5N	lug back
2138-25P*	25.4mm/1"	5µm	3µm	2.2N	flat back, with lift cap
2138-50P*	50.8mm/2"	6µm	3µm	2.5N	flat back, with lift cap

### Resolution 0.01mm/0.0005"

Code	Range	Accuracy	Hysteresis	Maximum measuring force	Remark
2139-10F*	12.7mm/0.5"	20µm	10µm	1.5N	flat back
2139-25F*	25.4mm/1"	20µm	10µm	2.2N	flat back
2139-50F*	50.8mm/2"	30µm	10µm	2.5N	flat back
2139-10*	12.7mm/0.5"	20µm	10µm	1.5N	lug back
2139-25*	25.4mm/1"	20µm	10µm	2.2N	lug back
2139-50*	50.8mm/2"	30µm	10µm	2.5N	lug back
2139-25P*	25.4mm/1"	20µm	10µm	2.2N	flat back, with lift cap
2139-50P*	50.8mm/2"	30µm	10µm	2.5N	flat back, with lift cap

\*Supplied with manufacturer inspection certificate

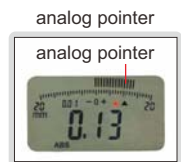

alarm when over tolerance

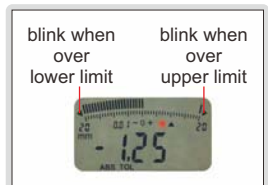

WATERPROOF

DATA OUTPUT

## WATERPROOF DIGITAL INDICATORS

**INSPECTION CERTIFICATE**

alarm when over tolerance



spindle lift knob is included (except 2115-101/101F, 2115-10/10F)



max./min./TIR

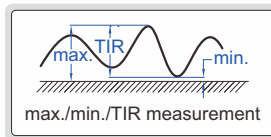

2115-10



2115-25



2115-50

- Dust/waterproof
- Button function: on/off, zero, mm/inch, data preset, tolerance, change measuring direction, max./min./TIR measurement, absolute/incremental measurement
- Keep preset data and tolerance data in memory after restart
- CR2032 battery, automatic power off
- Data output
- Optional accessory: data output cable (code 7315-50M need receiver page 5, 7302-40M page 13, 7305-40M page 9), backs (page 253~254), contact points (page 250~252)

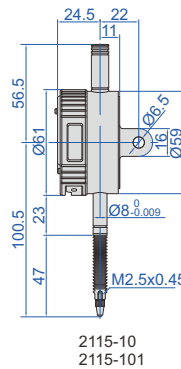

2115-10  
2115-101

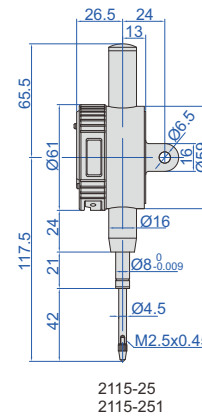

2115-25  
2115-251

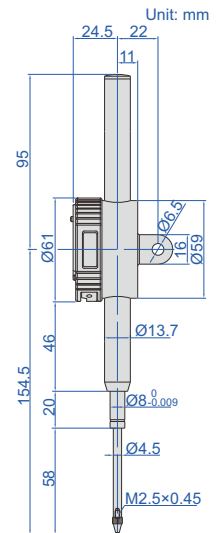

2115-50  
2115-501

### Resolution 0.001mm/0.00005"

Code	Range	Dust/waterproof	Accuracy	Hysteresis	Remark
2115-101 *	12.7mm/0.5"	IP65	5µm	2µm	lug back
2115-251 *	25.4mm/1"	IP54	5µm	3µm	lug back
2115-501 *	50.8mm/2"	IP54	6µm	3µm	lug back
2115-101F *	12.7mm/0.5"	IP65	5µm	2µm	flat back
2115-251F *	25.4mm/1"	IP54	5µm	3µm	flat back
2115-501F *	50.8mm/2"	IP54	6µm	3µm	flat back

### Resolution 0.01mm/0.0005"

Code	Range	Dust/waterproof	Accuracy	Hysteresis	Remark
2115-10 *	12.7mm/0.5"	IP65	20µm	10µm	lug back
2115-25 *	25.4mm/1"	IP54	20µm	10µm	lug back
2115-50 *	50.8mm/2"	IP54	30µm	10µm	lug back
2115-10F *	12.7mm/0.5"	IP65	20µm	10µm	flat back
2115-25F *	25.4mm/1"	IP54	20µm	10µm	flat back
2115-50F *	50.8mm/2"	IP54	30µm	10µm	flat back

\* Supplied with manufacturer inspection certificate

## ADJUSTABLE COEFFICIENT DIGITAL INDICATORS



DATA  
OUTPUT

INSPECTION  
CERTIFICATE



2501-10



2501-25



2501-25P



2501-50

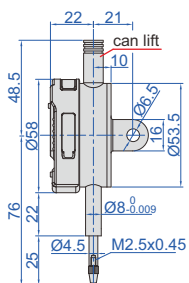

2501-10

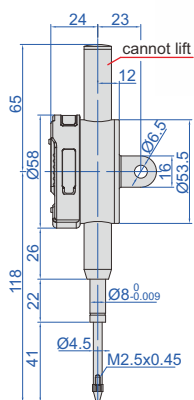

2501-25

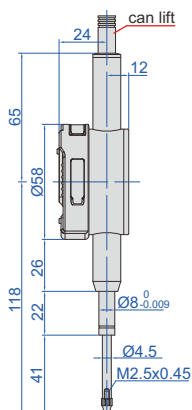

2501-25P

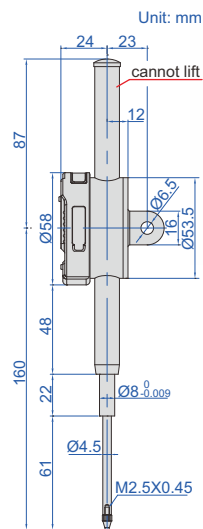

2501-50

11

■ DISPLAY READING = COEFFICIENT X SPINDLE MOVEMENT.

The coefficient can be adjusted from 0 to 9.9999.

For example, coefficient is 4.5562, spindle moves 3.60mm, display reading is 4.5562 x 3.60=16.40mm

- Button function: on/off, zero, data preset, inch/mm, coefficient set, measuring direction change
- Switchable high/low frequency measurement mode, high frequency mode is suitable for high speed moving of spindle and has large power consumption, low power consumption in low frequency mode
- Keep preset data in memory after restart
- CR2032 battery, automatic power off (time is adjustable)
- Data output
- Optional accessory: data output cable (code **7315-50M** need receiver page 5, **7302-40M** page 13, **7305-40M** page 9), backs (page 253~254), contact points (page 250~252)

**2501-25P/50P**



spindle lift knob is included



Resolution 0.01mm/0.0005"

Code	Range	Accuracy	Hysteresis	Maximum measuring force	Remark
2501-10*	12.7mm/0.5"	20µm	10µm	1.5N	lug back
2501-25*	25.4mm/1"	20µm	10µm	2.2N	lug back
2501-50*	50.8mm/2"	30µm	10µm	2.5N	lug back
2501-10F*	12.7mm/0.5"	20µm	10µm	1.5N	flat back
2501-25F*	25.4mm/1"	20µm	10µm	2.2N	flat back
2501-50F*	50.8mm/2"	30µm	10µm	2.5N	flat back
2501-25P*	25.4mm/1"	20µm	10µm	2.2N	flat back, with lift cap
2501-50P*	50.8mm/2"	30µm	10µm	2.5N	flat back, with lift cap

\* Supplied with manufacturer inspection certificate





THE ORIGINAL DATA  
REMAINS AFTER POWER OFF

## DIGITAL INDICATORS FOR BORE GAGES (WITH TRANSMISSION BUTTON AND SIGNAL LIGHT)



DATA  
OUTPUT

VIDEO

- Specially designed for bore gages
- The minimum value tracking function can find the diameter automatically
- Read the diameter directly, after inputting the size of setting ring
- Reading in digital and analog
- Display can be rotated by 320°
- Button function: on/off, minimum value tracking, calibration, data preset, inch/metric conversion
- Data remains after power off, no need to recalibrate after power on
- CR2032 battery, automatic power off (time is adjustable)
- Data output
- Optional accessory: data output cable (code **7315-51 need receiver** page 5, **7302-40M** page 13, **7305-40M** page 9), backs (page 253~254), contact points (page 250~252), spindle lift knob (code **7332**)



2108-10F

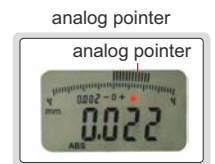
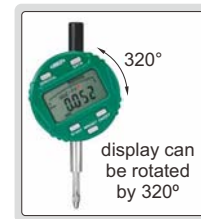
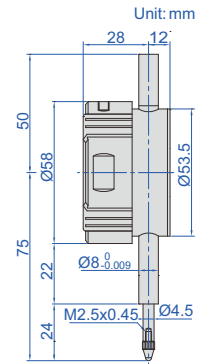

read the diameter directly, after inputting the size of setting ring.



the minimum value tracking function can find the diameter automatically.

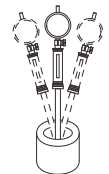

Code	Range	Resolution	Accuracy	Hysteresis	Remark
2108-10F *	12.7mm/0.5"	0.002mm/0.0001" (can switch to: 0.01mm/0.0005")	20µm	10µm	flat back
2108-101F *	12.7mm/0.5"	0.001mm/0.00005"	5µm	2µm	flat back

\* Supplied with manufacturer inspection certificate

IP54  
WATERPROOF

DATA  
OUTPUT



## WATERPROOF DIGITAL INDICATORS FOR BORE GAGES

THE ORIGINAL DATA  
REMAINS AFTER POWER OFF

- Specially designed for bore gages
- The minimum value tracking function can find the diameter automatically
- Read the diameter directly, after inputting the size of setting ring
- Button function: on/off, minimum value tracking, calibration, data preset, inch/metric conversion
- Data remains after power off, no need to recalibrate after power on
- CR2032 battery, automatic power off (time is adjustable)
- Data output
- Optional accessory: data output cable (code **7315-50M need receiver** page 5, **7302-40M** page 13, **7305-40M** page 9), backs (page 253~254), contact points (page 250~252), spindle lift knob (code **7332**)



2137-10F

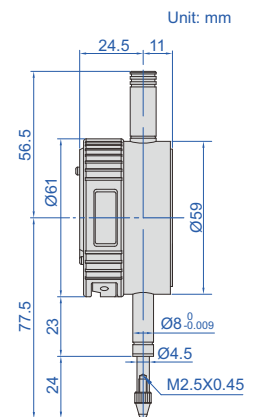

read the diameter directly, after inputting the size of setting ring.



the minimum value tracking function can find the diameter automatically.

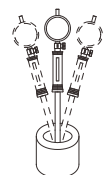

Code	Range	Resolution	Accuracy	Hysteresis	Remark
2137-10F *	12.7mm/0.5"	0.002mm/0.0001" (can switch to: 0.01mm/0.0005")	20µm	10µm	flat back
2137-101F *	12.7mm/0.5"	0.001mm/0.00005"	5µm	2µm	flat back

\* Supplied with manufacturer inspection certificate

## DIGITAL INDICATORS WITH LIFTING LEVER

DATA  
OUTPUT

INSIZE  
INSPECTION  
CERTIFICATE



2109-10

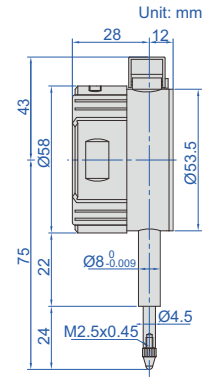

- Reading in digital and analog
- Display can be rotated by 320°
- Button function: tolerance Go and No-Go display, data preset, measuring direction change, max./min./TIR measurement, inch/metric conversion, absolute/incremental measurement
- Keep preset data and tolerance data in memory after restart
- CR2032 battery, automatic power off (time is adjustable)
- Data output
- Optional accessory: data output cable (code 7315-50M need receiver page 5, 7302-40M page 13, 7305-40M page 9), backs (page 253~254), contact points (page 250~252)

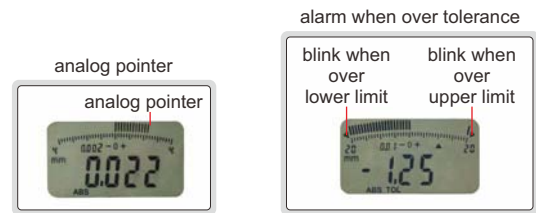

Code	Range	Resolution	Accuracy	Hysteresis	Remark
2109-10*	10mm/0.4"	0.01mm/0.0005"	20µm	10µm	flat back
2109-101*	10mm/0.4"	0.001mm/0.00005"	5µm	2µm	flat back

\*Supplied with manufacturer inspection certificate

## COMPACT DIGITAL INDICATORS

DATA  
OUTPUT

INSIZE  
INSPECTION  
CERTIFICATE

- Button function:
  - in/mm: short press for inch/metric conversion, long press to change measuring direction
  - ABS: short press for absolute/incremental measurement, long press to preset data
  - 0/ON: short press to turn on when power is off, short press to set zero when power is on, long press to turn off
- Keep preset data in memory after restart
- CR1632 battery, automatic power off
- Data output
- Optional accessory: data output cable (code 7315-50M need receiver page 5, 7302-40M page 13, 7305-40M page 9), contact points (page 250~252)



2114-51F

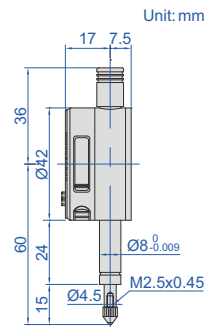

Code	Range	Resolution	Accuracy	Hysteresis	Remark
2114-5F*	5mm/0.2"	0.01mm/0.0005"	20µm	10µm	flat back
2114-51F*	5mm/0.2"	0.001mm/0.00005"	5µm	2µm	flat back

\*Supplied with manufacturer inspection certificate

## BACK PLUNGER TYPE DIGITAL INDICATORS



2118-10

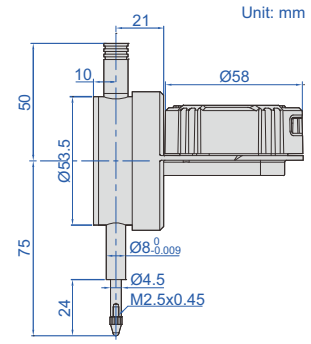

- Display can rotate 320°, and display direction is changeable
- Reading in digital and analog
- Button function: tolerance Go and No-Go display, data preset, measuring direction change, max./min./TIR measurement, inch/metric conversion, absolute/incremental measurement
- Keep preset data and tolerance data in memory after restart
- CR2032 battery, automatic power off (time is adjustable)
- Data output
- Optional accessory: data output cable (code **7315-50M** need receiver page 5, **7302-40M** page 13, **7305-40M** page 9), backs (page 253~254), contact points (page 250~252)

spindle lift knob is included



max./min./TIR

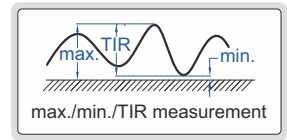

alarm when over tolerance

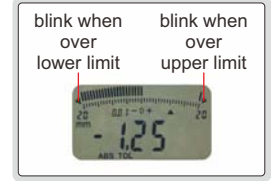

analog pointer

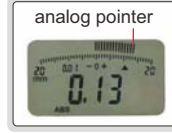

display direction is changeable

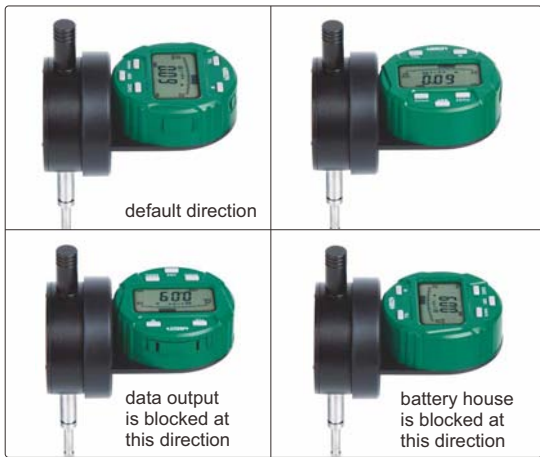

display can rotate 320°



remark: to change above direction, 4 fixing screws on the back of display need to be removed first.

Code	Range	Resolution	Accuracy	Hysteresis	Remark
2118-10 *	12.7mm/0.5"	0.01mm/0.0005"	20µm	10µm	flat back
2118-101 *	12.7mm/0.5"	0.001mm/0.00005"	5µm	2µm	flat back

\* Supplied with manufacturer inspection certificate

## LARGE STROKE DIGITAL INDICATORS

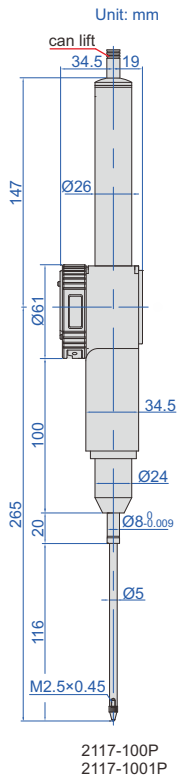
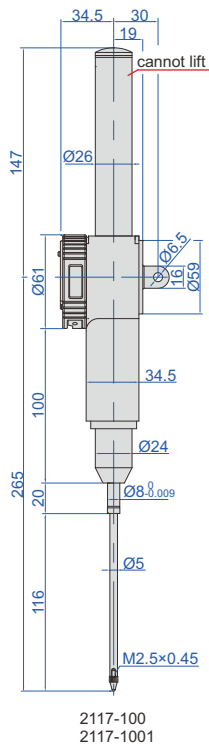

DATA OUTPUT

- Button function: on/off, zero, mm/inch, data preset, tolerance, change measuring direction, max./min./TIR measurement, absolute/incremental measurement
- Keep preset data and tolerance data in memory after restart
- CR2032 battery, automatic power off
- Maximum measuring force: 3.2N
- Data output
- Optional accessory: data output cable (code **7315-50M** need receiver page 5, **7302-40M** page 13, **7305-40M** page 9), backs (page 253~254), contact points (page 250~252)

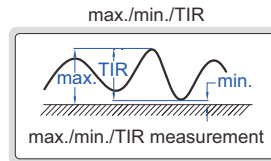

spindle lift knob is included



alarm when over tolerance



2117-100P/1001P



Resolution 0.01mm/0.0005"

Code	Range	Accuracy	Hysteresis	Remark
2117-100	100mm/4"	30µm	10µm	lug back
2117-100P	100mm/4"	30µm	10µm	flat back, with lift cap

Resolution 0.001mm/0.00005"

Code	Range	Accuracy	Hysteresis	Remark
2117-1001	100mm/4"	9µm	3µm	lug back
2117-1001P	100mm/4"	9µm	3µm	flat back, with lift cap

## ZEROING FOOT SWITCH

- For zeroing of digital indicators



7360-1M

application

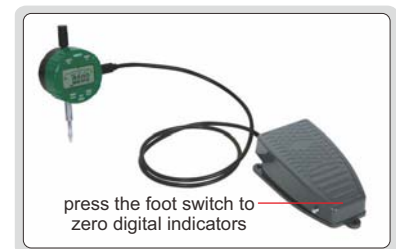

Code	Description	Interface of digital indicators	Applicable products
7360-1M	zeroing foot switch with cable (length 2.5m)		for digital indicators

## INDUCTIVE DIGITAL COMPARATOR (HIGH ACCURACY)

ATTENTION: RECHARGEABLE BATTERY,  
FOR 12 HOURS CONTINUOUS WORKING

**IP54**  
WATERPROOF

DATA  
OUTPUT



2149-2

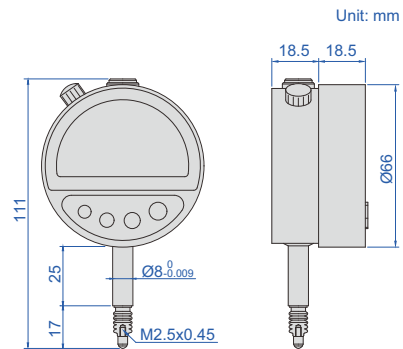

data interface  
(with protective cover)



touch sensor  
to transmit data  
signal light

max./min./TIR

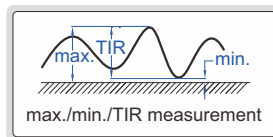

wireless receiver (optional)



printer (optional)



- Built-in wireless transmission
- IP54 dust/waterproof
- Reading in digital and analog
- Display can be rotated by 320°
- Can store 10 set parameters, and the parameter can be searched and recalled
- 999 groups value can be stored
- Touch sensor: use the sensor to transmit data, avoiding press the button to cause deformation of the dial indicator stand and affect the zero position
- Button function: on/off, zero, data hold, measuring direction change, inch/metric conversion, data preset, absolute/incremental measurement, max./min./TIR measurement, tolerance Go and No-Go display, data output, analog pointer resolution and range change, print data
- Power: rechargeable battery, for 12 hours continuous working
- Ruby probe
- Data output
- Optional accessory:  
wireless receiver (code **2149-RE**, transmission distance is 2 meters),  
printer (code **ISF-DF-PRINTER**)

Code	Range	Resolution	Accuracy	Hysteresis	Repeatability	Measuring force
2149-2	2mm/0.08"	0.1µm/0.000005"	0.5µm	0.2µm	0.3µm	0.8-1N

## WIRELESS HIGH PRECISION DIGITAL INDICATORS



ABSOLUTE ENCODER, THE ORIGINAL DATA REMAINS AFTER POWER OFF

ATTENTION: RECHARGEABLE BATTERY, FOR 24 HOURS CONTINUOUS WORKING

CONTINUOUS DATA COLLECTION CAN BE CUSTOMIZED (PRESS "DATA" BUTTON TO START CONTINUOUS COLLECTION, PRESS AGAIN TO STOP; COLLECTION FREQUENCY CAN BE CUSTOMIZED, THE FASTEST DATA COLLECTION IS 10PCS PER SECOND)

LINEAR BALL BEARINGS FOR TEN MILLION TIMES USE

alarm when over tolerance

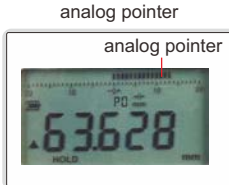
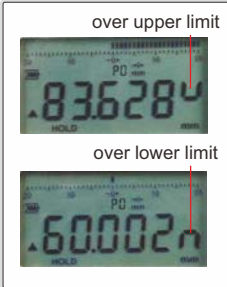

transmit data

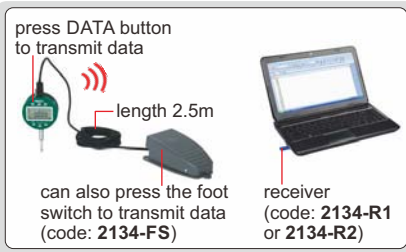

2134-10

2134-25

2134-50

- Built-in wireless transmission, Zigbee single
- Linear ball bearings for ten million times use
- Absolute encoder, the original data remains after power off
- Reading in digital and analog
- Button function: data output, tolerance, data preset, data hold, measuring direction change, max./min./TIR, power off time, on/off, mm/inch, adjust resolution
- Power: rechargeable battery, for 24 hours continuous working
- Optional accessory: contact points (page 250~252), foot switch, code: **2134-FS**  
wireless receiver, code: **2134-R1** (keyboard format) **2134-R2** (serial port format)

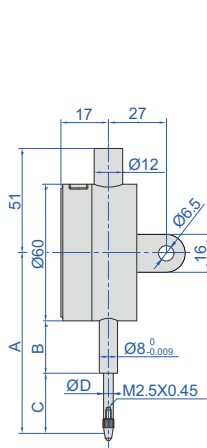

2134-10L  
2134-101L

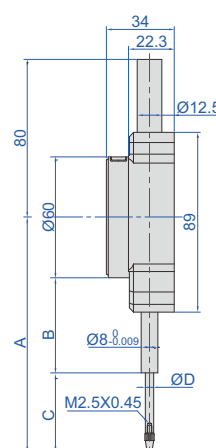

2134-25  
2134-251

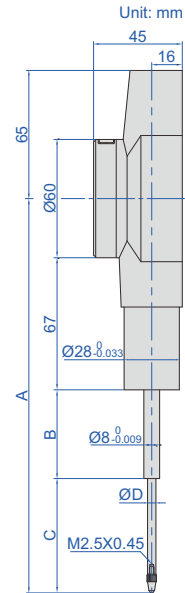

2134-50

### Standard precision

Carbide probe

Adjustable resolution: 0.0005mm/0.00002"  
0.001mm/0.00005"  
0.01mm/0.0005"

Code	Range	Accuracy	Hysteresis	A	B	C	ØD	Remark
2134-10*	12.7mm/0.5"	3µm	1.5µm	75.4mm	20.6mm	24.8mm	5mm	flat back
2134-10L*	12.7mm/0.5"	3µm	1.5µm	75.4mm	20.6mm	24.8mm	5mm	lug back
2134-25*	25.4mm/1"	3µm	1.5µm	109.5mm	38.5mm	41mm	5mm	flat back
2134-50*	50.8mm/2"	3µm	1.5µm	201mm	32mm	72mm	4.5mm	flat back

### High precision

Ruby probe

Adjustable resolution: 0.0002mm/0.00001"  
0.001mm/0.00005"  
0.01mm/0.0005"

Code	Range	Accuracy	Hysteresis	A	B	C	ØD	Remark
2134-101*	12.7mm/0.5"	1.5µm	1µm	77.4	26	21.4	4	flat back
2134-101L*	12.7mm/0.5"	1.5µm	1µm	77.4	26	21.4	4	lug back
2134-251*	25.4mm/1"	1.8µm	1µm	116.1	42.5	44	4	flat back

(mm)

\* Supplied with manufacturer inspection certificate

spindle lift knob is included



max./min./TIR

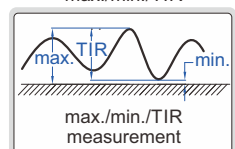



LINEAR BALL BEARINGS  
FOR TEN MILLION TIMES USE

ABSOLUTE ENCODER, THE ORIGINAL  
DATA REMAINS AFTER POWER OFF

DATA  
OUTPUT

ATTENTION: RECHARGEABLE BATTERY,  
FOR 24 HOURS CONTINUOUS WORKING



## HIGH PRECISION DIGITAL INDICATORS

alarm when over tolerance

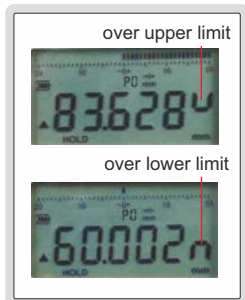

analog pointer

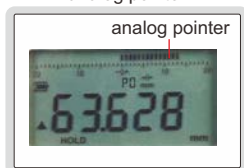

- Linear ball bearings for ten million times use
- Absolute encoder, the original data remains after power off
- Reading in digital and analog
- Data output
- Button function: data output, tolerance, data preset, data hold, measuring direction change, max./min./TIR, power off time, on/off, mm/inch, adjust resolution
- Power: rechargeable battery, for 24 hours continuous working
- Optional accessory: contact points (page 250~252), wireless transmitter, code **7315-60** need receiver page 5 data output cable (keyboard format), code **7302-60** page 13 data output cable (serial port format), code **7305-G60** page 11 (cable length 3m, optional cable length maximum 15m; RS232 protocol, optional RS485 protocol)

### Standard precision

Carbide probe

Adjustable resolution: 0.0005mm/0.00002"  
0.001mm/0.00005"  
0.01mm/0.0005"

Code	Range	Accuracy	Hysteresis	A	B	C	ØD	Remark
<b>2133-10*</b>	12.7mm/0.5"	3µm	1.5µm	75.4mm	20.6mm	24.8mm	5mm	flat back
<b>2133-10L*</b>	12.7mm/0.5"	3µm	1.5µm	75.4mm	20.6mm	24.8mm	5mm	lug back
<b>2133-25*</b>	25.4mm/1"	3µm	1.5µm	109.5mm	38.5mm	41mm	5mm	flat back
<b>2133-50*</b>	50.8mm/2"	3µm	1.5µm	201mm	32mm	72mm	4.5mm	flat back

### High precision

Ruby probe

Adjustable resolution: 0.0002mm/0.00001"  
0.001mm/0.00005"  
0.01mm/0.0005"

Code	Range	Accuracy	Hysteresis	A	B	C	ØD	Remark
<b>2133-101*</b>	12.7mm/0.5"	1.5µm	1µm	77.4mm	26mm	21.4mm	4mm	flat back
<b>2133-101L*</b>	12.7mm/0.5"	1.5µm	1µm	77.4mm	26mm	21.4mm	4mm	lug back
<b>2133-251*</b>	25.4mm/1"	1.8µm	1µm	116.1mm	42.5mm	44mm	4mm	flat back

\*Supplied with manufacturer inspection certificate

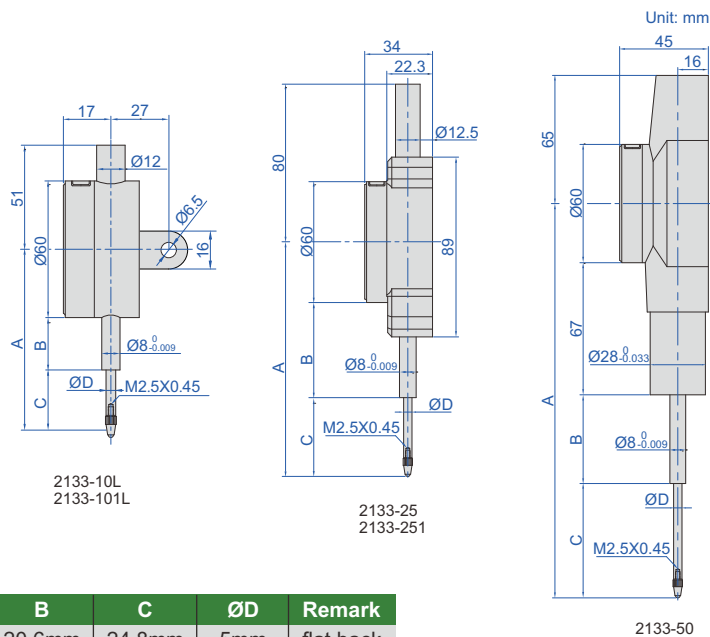

Unit: mm

spindle lift knob is included



max./min./TIR

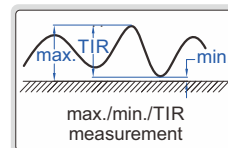

## HIGH PRECISION DIGITAL INDICATORS

DATA OUTPUT

Ø28MM STEM SUITABLE FOR REINFORCED CLAMPING

ABSOLUTE ENCODER, THE ORIGINAL DATA REMAINS AFTER POWER OFF

LINEAR BALL BEARINGS FOR TEN MILLION TIMES USE

ATTENTION: RECHARGEABLE BATTERY, FOR 24 HOURS CONTINUOUS WORKING

- Linear ball bearings for ten million times use
- Ø28mm stem suitable for reinforced clamping
- Absolute encoder, the original data remains after power off
- Adjustable resolution: 0.0002mm/0.00001"  
0.001mm/0.00005"  
0.01mm/0.0005"
- Reading in digital and analog
- Button function: data output, tolerance, data preset, data hold, measuring direction change, max./min./TIR, power off time, on/off, mm/inch, adjust resolution
- Power: rechargeable battery, for 24 hours continuous working
- Ruby probe

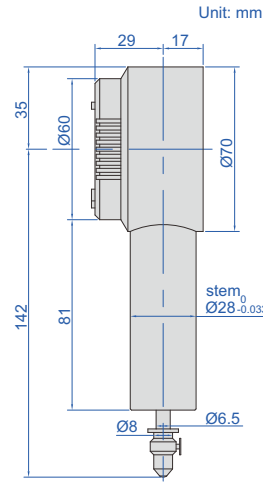

alarm when over tolerance

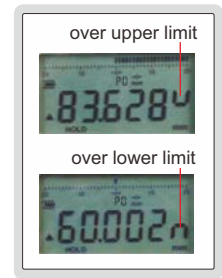

analog pointer

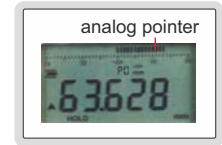

### With data interface

Optional accessory:  
wireless transmitter, code **7315-60** need receiver page 5  
data output cable (keyboard format), code **7302-60** page 13  
data output cable (serial port format), code **7305-G60** page 11  
(cable length 3m, optional cable length maximum 15m; RS232 protocol, optional RS485 protocol)

Code	Range	Accuracy	Hysteresis	Remark
2140-6	0-6mm/0-0.24"	1.6µm	0.8µm	flat back

2140-6

max./min./TIR

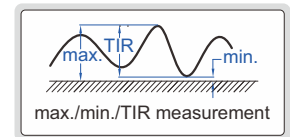

### Built-in wireless

Optional accessory:  
wireless receiver (keyboard format, connect up to 15 digital indicators), code **2134-R1**  
wireless receiver (serial port format, connect up to 15 digital indicators), code **2134-R2**

Code	Range	Accuracy	Hysteresis	Remark
2140-6WL*	0-6mm/0-0.24"	1.6µm	0.8µm	flat back

\*Continuous data collection can be customized (press "DATA" button to start continuous collection, press again to stop; collection frequency can be customized, the fastest data collection is 10 pcs per second)

wireless receiver

2134-R1, 2134-R2 (optional)



## DIAL COMPARATOR

INSIZE PLUS  
MADE IN EUROPE

- Meet DIN879-1
- Shockproof
- Jeweled bearing
- Overtravel: 3mm
- Shadow free dial face cover
- Supplied with limit pointers
- Initial measuring force 1.2N
- Optional accessory:  
lifting lever (code **6289-150**)

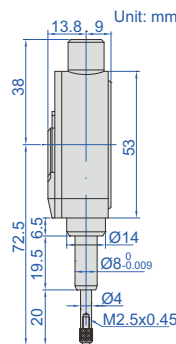

2881-01

Code	Range	Graduation	Accuracy	Hysteresis	Dial reading	Remark
2881-01*	0.1mm	0.001mm	1.2µm	0.5µm	50-0-50	flat back

\*Supplied with manufacturer inspection certificate

JEWELLED BEARING

SHOCK PROOF

INSPECTION CERTIFICATE

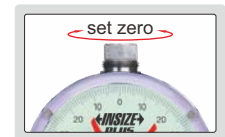

lifting lever (optional)

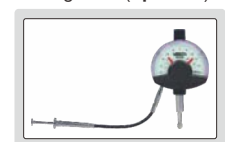





SHOCK PROOF

JEWELLED BEARING

## PRECISION DIAL INDICATORS

INSIZE PLUS  
MADE IN EUROPE

- Shockproof
- Jeweled bearing
- With limit pointers
- Optional accessory: backs (page 253~254), contact points (page 250~252)



2830-1

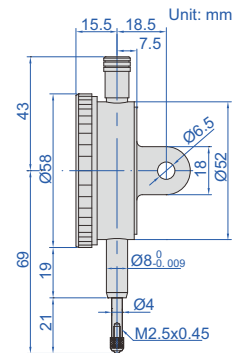

Code	Range	Graduation	Accuracy	Hysteresis	Range/rev	Dial reading	Remark
2830-1*	1mm	0.001mm	5µm	2µm	0.2mm	0-100-0	lug back
2830-1F*	1mm	0.001mm	5µm	2µm	0.2mm	0-100-0	flat back

\*Supplied with manufacturer inspection certificate



SHOCK PROOF

## HIGH PRECISION DIAL INDICATORS

INSIZE PLUS  
MADE IN EUROPE

- Shockproof
- Jeweled bearing
- With limit pointers
- Optional accessory: backs (page 253~254), contact points (page 250~252), lifting lever (code 6289-150)

lifting lever (optional)

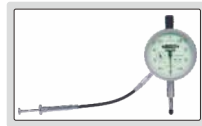

2891-1

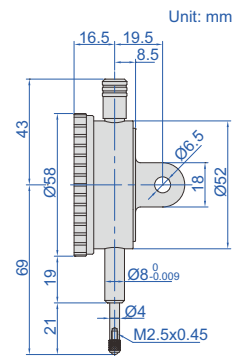

Code	Range	Graduation	Accuracy	Hysteresis	Range/rev	Dial reading	Remark
2891-1*	1mm	0.001mm	3µm	1.5µm	0.1mm	0-100	lug back
2891-1F*	1mm	0.001mm	3µm	1.5µm	0.1mm	0-100	flat back

\*Supplied with manufacturer inspection certificate



SHOCK PROOF

## HIGH PRECISION COMPACT DIAL INDICATORS

INSIZE PLUS  
MADE IN EUROPE

- Shockproof
- Jeweled bearing
- With limit pointers
- Optional accessory: backs (page 253~254), contact points (page 250~252), lifting lever (code 6289-150)

lifting lever (optional)



2890-1

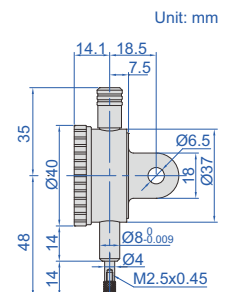

Code	Range	Graduation	Accuracy	Hysteresis	Range/rev	Dial reading	Remark
2890-1*	1mm	0.001mm	3µm	1.5µm	0.1mm	0-100	lug back
2890-1F*	1mm	0.001mm	3µm	1.5µm	0.1mm	0-100	flat back

\*Supplied with manufacturer inspection certificate

## PRECISION DIAL INDICATORS

JEWELLED BEARING

INSPECTION CERTIFICATE



2313-1A

- Graduation: 0.001mm
- Jeweled bearing
- Supplied with limit pointers and bezel clamp
- Optional accessory: backs (page 253~254), contact points (page 250~252)

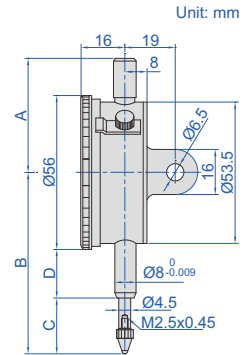

Code	Range	Accuracy	Hysteresis	Range/rev	Dial reading	Remark	A	B	C	D
2313-1FA *	1mm	5µm	2µm	0.2mm	0-100-0	flat back	45	62.5	19.5	15
2313-2FA *	2mm	6µm	2.5µm	0.2mm	0-100-0	flat back	45	62.5	19.5	15
2313-1A *	1mm	5µm	2µm	0.2mm	0-100-0	lug back	45	62.5	19.5	15
2313-2A *	2mm	6µm	2.5µm	0.2mm	0-100-0	lug back	45	62.5	19.5	15

\*Supplied with manufacturer inspection certificate

## COMPACT DIAL INDICATOR

INSIZE PLUS  
MADE IN EUROPE

INSPECTION CERTIFICATE



2886-3F

- Meet DIN878
- With limit pointers
- Optional accessory: backs (page 253~254), contact points (page 250~252)

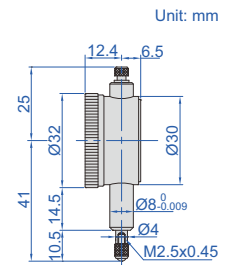

Code	Range	Graduation	Accuracy	Hysteresis	Range/rev	Dial reading	Remark
2886-3F *	3mm	0.01mm	12µm	3µm	0.5mm	0-50	flat back

\*Supplied with manufacturer inspection certificate

## COMPACT DIAL INDICATORS

INSIZE PLUS  
MADE IN EUROPE

INSPECTION CERTIFICATE



2887-5

- Meet DIN878
- With limit pointers
- Optional accessory: backs (page 253~254), contact points (page 250~252)

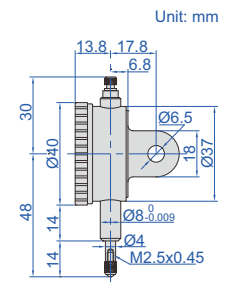

Code	Range	Graduation	Accuracy	Hysteresis	Range/rev	Dial reading	Remark
2887-5 *	5mm	0.01mm	14µm	3µm	0.5mm	0-50	lug back
2887-5F *	5mm	0.01mm	14µm	3µm	0.5mm	0-50	flat back

\*Supplied with manufacturer inspection certificate

JEWELLED BEARING

INSPECTION CERTIFICATE

## COMPACT DIAL INDICATORS

- Meet DIN878
- Jeweled bearing
- Supplied with limit pointers and bezel clamp
- Optional accessory: backs (page 253~254), contact points (page 250~252)



2311-5

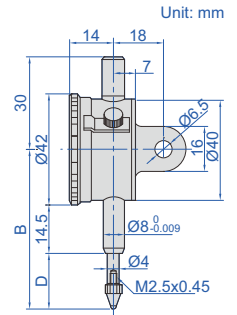

(mm)

Code	Range	Graduation	Accuracy	Hysteresis	Range/rev	Dial reading	Remark	B	D
2311-3F *	3mm	0.01mm	12μm	3μm	0.5mm	0-50	flat back	46	10.5
2311-5F *	5mm	0.01mm	14μm	3μm	0.5mm	0-50	flat back	48	12.5
2311-3 *	3mm	0.01mm	12μm	3μm	0.5mm	0-50	lug back	46	10.5
2311-5 *	5mm	0.01mm	14μm	3μm	0.5mm	0-50	lug back	48	12.5

\* Supplied with manufacturer inspection certificate

INSPECTION CERTIFICATE

## DIAL INDICATORS

INSIZE PLUS  
MADE IN EUROPE

- Meet DIN878
- With limit pointers
- Optional accessory: backs (page 253~254), contact points (page 250~252)



2892-10

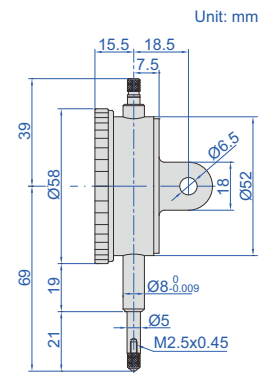

Code	Range	Graduation	Accuracy	Hysteresis	Range/rev	Dial reading	Remark
2892-10 *	10mm	0.01mm	17μm	3μm	1mm	0-100	lug back
2892-10F *	10mm	0.01mm	17μm	3μm	1mm	0-100	flat back

\* Supplied with manufacturer inspection certificate

JEWELLED BEARING

INSPECTION CERTIFICATE

## DIAL INDICATORS (STANDARD TYPE)

- Meet DIN878
- Jeweled bearing
- Supplied with limit pointers and bezel clamp
- Optional accessory: backs (page 253~254), contact points (page 250~252)



2308-10A

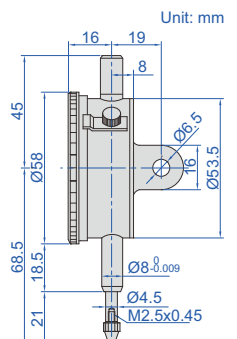

Code	Range	Graduation	Accuracy	Hysteresis	Range/rev	Dial reading	Remark
2308-3FA *	3mm	0.01mm	12μm	3μm	1mm	0-100	flat back
2308-5FA *	5mm	0.01mm	14μm	3μm	1mm	0-100	flat back
2308-10FA *	10mm	0.01mm	17μm	3μm	1mm	0-100	flat back
2308-3A *	3mm	0.01mm	12μm	3μm	1mm	0-100	lug back
2308-5A *	5mm	0.01mm	14μm	3μm	1mm	0-100	lug back
2308-10A *	10mm	0.01mm	17μm	3μm	1mm	0-100	lug back

\* Supplied with manufacturer inspection certificate

## DIAL INDICATORS (BASIC TYPE)

- Meet DIN878
- Jeweled bearing
- Supplied with limit hands and bezel clamp
- Packed in carton box
- Optional accessory: backs (page 253~254), contact points (page 250~252)



2301-10

INSPECTION CERTIFICATE

JEWELLED BEARING

POPULAR MODEL

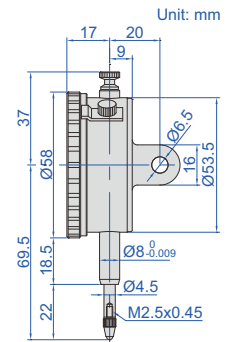

Code	Range	Graduation	Accuracy	Hysteresis	Range/rev	Dial reading	Remark
2301-10F *	10mm	0.01mm	17µm	3µm	1mm	0-100	flat back
2301-10 *	10mm	0.01mm	17µm	3µm	1mm	0-100	lug back with spare flat back

\*Supplied with manufacturer inspection certificate

## REVERSE READING DIAL INDICATORS

- Meet DIN878
- Suitable for depth and step measurements
- Jeweled bearing
- Supplied with limit pointers and bezel clamp
- Optional accessory: backs (page 253~254), contact points (page 250~252)



2801-10

INSPECTION CERTIFICATE

JEWELLED BEARING

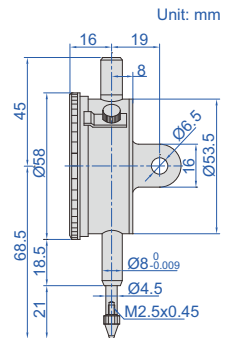

Code	Range	Graduation	Accuracy	Hysteresis	Range/rev	Dial reading	Remark
2801-10F *	10mm	0.01mm	17µm	3µm	1mm	100-0	flat back
2801-10 *	10mm	0.01mm	17µm	3µm	1mm	100-0	lug back

\*Supplied with manufacturer inspection certificate

## LARGE DIAL FACE DIAL INDICATOR

INSIZE PLUS  
MADE IN EUROPE

INSPECTION CERTIFICATE

- Large, easy-to-read dial face
- With limit pointers
- Optional accessory: backs (page 253~254), contact points (page 250~252)



2888-10

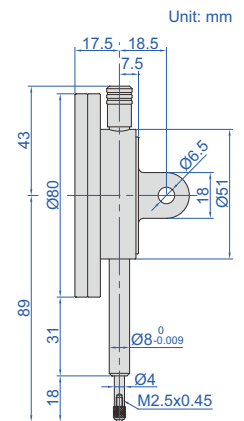

Code	Range	Graduation	Accuracy	Hysteresis	Range/rev	Dial reading	Remark
2888-10 *	10mm	0.01mm	17µm	5µm	1mm	0-100	flat back, with spare lug back

\*Supplied with manufacturer inspection certificate



## SHOCKPROOF DIAL INDICATORS

- Meet DIN878
- Shockproof
- Jeweled bearing
- Supplied with limit pointers and bezel clamp
- Optional accessory: backs (page 253~254), contact points (page 250~252)



2314-10A

Code	Range	Graduation	Accuracy	Hysteresis	Range/rev	Dial reading	Remark
2314-3FA *	3mm	0.01mm	12µm	3µm	1mm	0-100	flat back
2314-5FA *	5mm	0.01mm	14µm	3µm	1mm	0-100	flat back
2314-10FA *	10mm	0.01mm	17µm	3µm	1mm	0-100	flat back
2314-3A *	3mm	0.01mm	12µm	3µm	1mm	0-100	lug back
2314-5A *	5mm	0.01mm	14µm	3µm	1mm	0-100	lug back
2314-10A *	10mm	0.01mm	17µm	3µm	1mm	0-100	lug back

\*Supplied with manufacturer inspection certificate

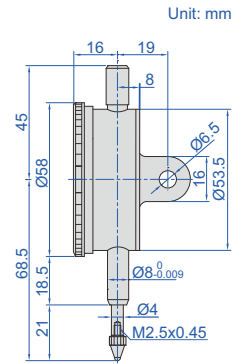

## BACK PLUNGER DIAL INDICATOR



- With limit pointers
- Optional accessory: contact points (page 250~252)



2893-3

Code	Range	Graduation	Accuracy	Hysteresis	Range/rev	Dial reading
2893-3 *	3mm	0.01mm	15µm	5µm	1mm	0-100

\*Supplied with manufacturer inspection certificate

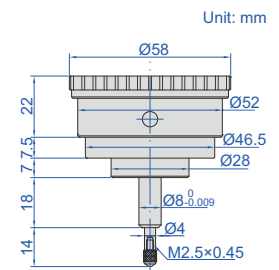

## WATERPROOF DIAL INDICATOR



- Meet DIN878
- Shockproof
- IP67 dust/waterproof
- With limit pointers
- Optional accessory: contact points (page 250~252)



2894-10F

Code	Range	Graduation	Accuracy	Hysteresis	Range/rev	Dial reading	Remark
2894-10F *	10mm	0.01mm	17µm	3µm	1mm	0-100	flat back

\*Supplied with manufacturer inspection certificate

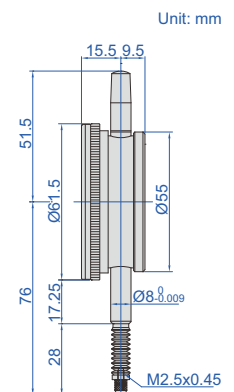

## WATERPROOF DIAL INDICATORS

**IP54**  
WATERPROOF

**INSPECTION**  
**CERTIFICATE**

- Meet DIN878
- IP54 dust/waterproof
- With limit pointers
- Optional accessory: backs (page 253~254), contact points (page 250~252)



2324-10A

Code	Range	Graduation	Accuracy	Hysteresis	Range/rev	Dial reading	Remark
2324-10FA *	10mm	0.01mm	17µm	3µm	1mm	0-100	flat back
2324-10A *	10mm	0.01mm	17µm	3µm	1mm	0-100	lug back

\* Supplied with manufacturer inspection certificate

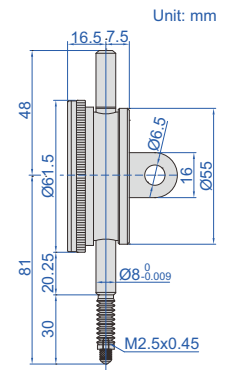

## DIAL INDICATORS (LONG STROKE)

**INSIZE PLUS**  
MADE IN EUROPE

**INSPECTION**  
**CERTIFICATE**

- With limit pointers
- Optional accessory: backs (page 253~254), contact points (page 250~252)



2889-30

Code	Range	Graduation	Accuracy	Hysteresis	Range/rev	Dial reading	Remark
2889-30 *	30mm	0.01mm	35µm	7µm	1mm	0-100	lug back
2889-30F *	30mm	0.01mm	35µm	7µm	1mm	0-100	flat back

\* Supplied with manufacturer inspection certificate

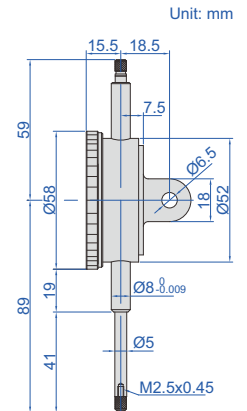

## DIAL INDICATORS (LONG STROKE)

**INSPECTION**  
**CERTIFICATE**

- Supplied with limit pointers and bezel clamp
- Optional accessory: backs (page 253~254), contact points (page 250~252)



2310-30A

Code	Range	Graduation	Accuracy	Hysteresis	Range/rev	Dial reading	Remark	(mm)	
2310-20FA *	20mm	0.01mm	25µm	5µm	1mm	0-100	flat back	B	D
2310-30FA *	30mm	0.01mm	35µm	7µm	1mm	0-100	flat back	88	40
2310-20A *	20mm	0.01mm	25µm	5µm	1mm	0-100	lug back	83	35
2310-30A *	30mm	0.01mm	35µm	7µm	1mm	0-100	lug back	88	40

\* Supplied with manufacturer inspection certificate

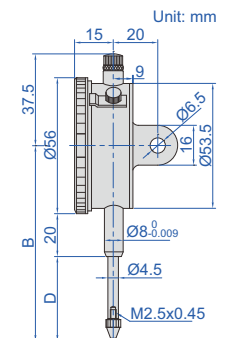

**INSPECTION  
CERTIFICATE**

**POPULAR  
MODEL**

## DIAL INDICATORS (LONG STROKE, BASIC TYPE)

- Supplied with limit pointers and bezel clamp
- Packed in carton box
- Optional accessory: backs (page 253~254), contact points (page 250~252)



2302-25

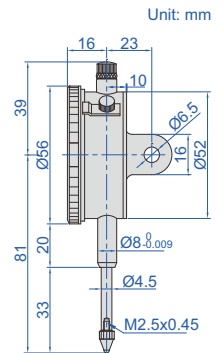

Code	Range	Graduation	Accuracy	Hysteresis	Range/rev	Dial reading	Remark
2302-25F *	25mm	0.01mm	35µm	7µm	1mm	0-100	flat back
2302-25 *	25mm	0.01mm	35µm	7µm	1mm	0-100	lug back with spare flat back

\* Supplied with manufacturer inspection certificate

**JWELED  
BEARING**

**INSPECTION  
CERTIFICATE**

## DOUBLE FACE DIAL INDICATOR

- Meet DIN878
- Read from both sides
- Jeweled bearing
- Supplied with limit pointers
- Optional accessory: contact points (page 250~252)



front



back

2328-10

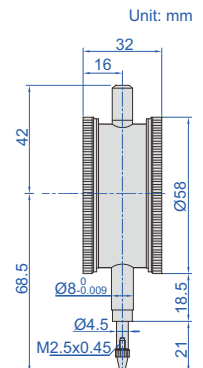

Code	Range	Graduation	Accuracy	Hysteresis	Range/rev	Dial reading
2328-10 *	10mm	0.01mm	17µm	3µm	1mm	0-100

\* Supplied with manufacturer inspection certificate

## DIAL INDICATORS (GRADUATION 0.1mm)

- Supplied with limit pointers and bezel clamp
- Optional accessory: backs (page 253~254), contact points (page 250~252)



2318-30

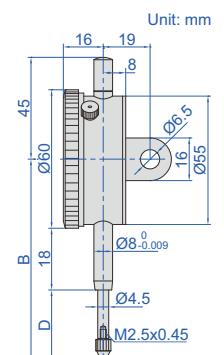

Code	Range	Graduation	Accuracy	Hysteresis	Range/rev	Dial reading	Remark	B	D
2318-10F	10mm	0.1mm	40µm	20µm	10mm	0-10	flat back	70	20
2318-20F	20mm	0.1mm	50µm	20µm	10mm	0-10	flat back	85	35
2318-25F	25mm	0.1mm	60µm	20µm	10mm	0-10	flat back	85	35
2318-30F	30mm	0.1mm	60µm	20µm	10mm	0-10	flat back	90	40
2318-10	10mm	0.1mm	40µm	20µm	10mm	0-10	lug back	70	20
2318-20	20mm	0.1mm	50µm	20µm	10mm	0-10	lug back	85	35
2318-25	25mm	0.1mm	60µm	20µm	10mm	0-10	lug back	85	35
2318-30	30mm	0.1mm	60µm	20µm	10mm	0-10	lug back	90	40

## DIAL INDICATORS (LONG STROKE)



JEWELLED BEARING

SHOCK PROOF

- Shockproof
- Jeweled bearing
- Supplied with limit pointers
- Optional accessory: backs (page 253~254), contact points (page 250~252)



2309-50

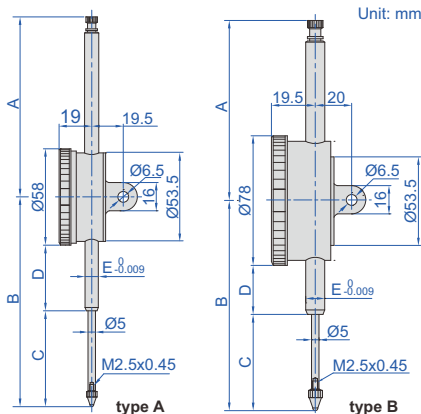

stem clamp Ø10mm for 2309-100D

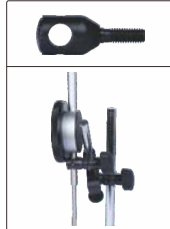

back of type B



Code	Type	A	B	C	D	E
2309-30F	A	37.5	89.5	40.9	19.5	Ø8
2309-30	A	37.5	89.5	40.9	19.5	Ø8
2309-50	A	108.3	126.2	57.7	39.5	Ø8
2309-50D	B	108.3	126.2	57.7	29.5	Ø8
2309-80	A	138.4	168.4	88	51.3	Ø8
2309-80D	B	138.4	168.4	88	41.3	Ø8
2309-100D	B	167.6	207.8	108	60.8	Ø10

Code	Range	Graduation	Type	Accuracy	Hysteresis	Range/rev	Dial reading	Remark
2309-30F *	30mm	0.01mm	A	35µm	7µm	1mm	0-100	flat back
2309-30 *	30mm	0.01mm	A	35µm	7µm	1mm	0-100	lug back
2309-50 *	50mm	0.01mm	A	40µm	8µm	1mm	0-100	flat back with spare lug back
2309-50D *	50mm	0.01mm	B	40µm	8µm	1mm	0-100	flat back with spare lug back
2309-80	80mm	0.01mm	A	50µm	9µm	1mm	0-100	flat back with spare lug back
2309-80D	80mm	0.01mm	B	50µm	9µm	1mm	0-100	flat back with spare lug back
2309-100D	100mm	0.01mm	B	50µm	9µm	1mm	0-100	flat back with spare lug back

Note: 1) 2309-80, 2309-80D and 2309-100D can only be used vertically  
 2) 2309-100D is supplied with stem clamp Ø10mm for magnetic stands (code 6200-60, 6201-60, 6202-80, 6202-100)  
 3) 2309-30 and 2309-30F can not accept optional backs (page 253~254)

\*Supplied with manufacturer inspection certificate

## ONE REVOLUTION PRECISION DIAL INDICATORS



SHOCK PROOF



- Eliminate the possibility of reading errors due to miscounting
- Shockproof
- Jeweled bearing
- Free stroke: 4.5mm
- With limit pointers
- Optional accessory: backs (page 253~254), contact points (page 250~252), lifting lever (code 6289-150)



2885-008

lifting lever (optional)

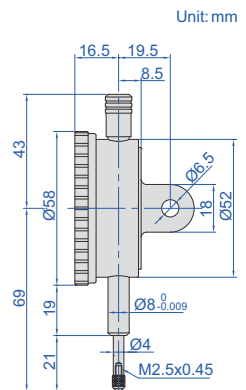

Code	Range	Graduation	Accuracy	Hysteresis	Dial reading	Remark
2885-008 *	0.08mm	0.001mm	3µm	1.5µm	40-0-40	lug back
2885-008F *	0.08mm	0.001mm	3µm	1.5µm	40-0-40	flat back

\*Supplied with manufacturer inspection certificate



SHOCK PROOF

INSPECTION CERTIFICATE

## ONE REVOLUTION DIAL INDICATORS

INSIZE PLUS  
MADE IN EUROPE

- Meet DIN878
- Eliminate the possibility of reading errors due to miscounting
- Shockproof
- Free stroke: 7mm
- With limit pointers
- Optional accessory: backs (page 253~254), contact points (page 250~252)



2882-08

Unit: mm

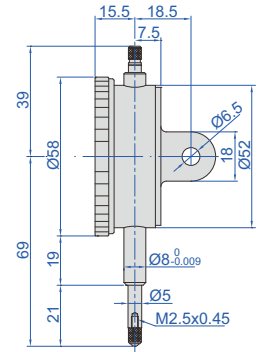

Code	Range	Graduation	Accuracy	Hysteresis	Dial reading	Remark
2882-08 *	0.8mm	0.01mm	9μm	3μm	40-0-40	lug back
2882-08F *	0.8mm	0.01mm	9μm	3μm	40-0-40	flat back

\* Supplied with manufacturer inspection certificate

SHOCK PROOF

INSPECTION CERTIFICATE

## ONE REVOLUTION DIAL INDICATORS

- Meet DIN878
- Eliminate the possibility of reading errors due to miscounting
- Shockproof
- Supplied with limit pointers
- Optional accessory: backs (page 253~254), contact points (page 250~252)



2316-05

Unit: mm

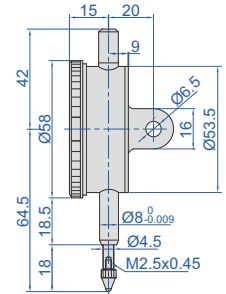

Code	Range	Dial indicator stroke	Graduation	Accuracy	Hysteresis	Dial reading	Remark
2316-05F *	0.5mm	5mm	0.01mm	9μm	3μm	25-0-25	flat back
2316-1F *	1mm	5mm	0.01mm	9μm	3μm	50-0-50	flat back
2316-05 *	0.5mm	5mm	0.01mm	9μm	3μm	25-0-25	lug back
2316-1 *	1mm	5mm	0.01mm	9μm	3μm	50-0-50	lug back

\* Supplied with manufacturer inspection certificate

INSPECTION CERTIFICATE

## INCH DIAL INDICATORS

- Meet ASME B89.1.10M-2001
- With lug back
- Supplied with limit pointers and bezel clamp
- Optional accessory: backs (page 253~254), contact points (page 250~252)



2307-1

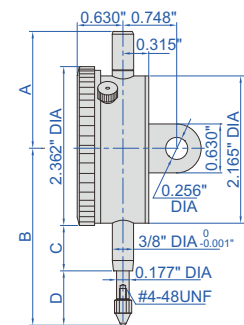

Code	Range	Graduation	Accuracy		Range/rev	Dial reading
			First 2.5 rev	Overall		
2307-025 *	0.25"	0.001"	±0.001"	±0.001"	0.1"	0-100
2307-05 *	0.5"	0.001"	±0.001"	±0.002"	0.1"	0-100
2307-1 *	1"	0.001"	±0.001"	±0.002"	0.1"	0-100
2307-2 *	2"	0.001"	±0.001"	±0.004"	0.1"	0-100
2307-0255 *	0.25"	0.0005"	±0.0005"	±0.0015"	0.05"	0-50
2307-055 *	0.5"	0.0005"	±0.0005"	±0.0015"	0.05"	0-50
2307-105 *	1"	0.0005"	±0.0005"	±0.002"	0.05"	0-50
2307-205 *	2"	0.0005"	±0.0005"	±0.002"	0.05"	0-50

\* Supplied with manufacturer inspection certificate

Range	A	B	C	D
0.25"	1.811"	2.953"	0.787"	0.984"
0.5"	1.811"	2.953"	0.787"	0.984"
1"	1.811"	3.346"	0.787"	1.378"
2"	4.370"	5.472"	1.969"	2.323"

## INCH LONG STROKE DIAL INDICATOR



2326-2

- Graduation 0.001"
- With lug back
- Supplied with limit pointers and bezel clamp
- Optional accessory: backs (page 253~254), contact points (page 250~252)

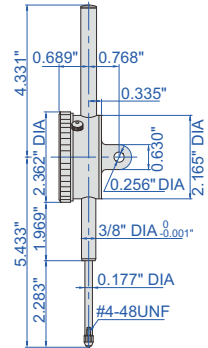

Code	Range	Accuracy		Range/rev	Dial reading
		first 2.5 rev	overall		
2326-2*	2"	±0.001"	±0.004"	0.1"	0-100

\*Supplied with manufacturer inspection certificate

## BALL POINTS



6282-0101

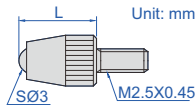

Code	Material of measuring face	L (mm)
6282-0101	carbide	7.3
6282-0103	ceramic	7.3
6282-0104	carbide	8.3
6282-0106	carbide	12.1
6282-0107	carbide	14
6282-0108	carbide	15
6282-0109	ceramic	15
6282-0110	carbide	17

Code	Material of measuring face	L (mm)
6282-0111	carbide	19.3
6282-0112	carbide	20
6282-0113	ceramic	20
6282-0114	carbide	22
6282-0115	carbide	25
6282-0116	ceramic	25
6282-0117	carbide	30
6282-0118	ceramic	30

11



6282-0301

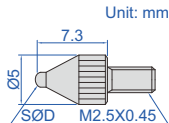

6282-0304

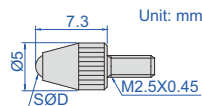

Code	Material of measuring face	SØD (mm)
6282-0301	steel	1
6282-0302	carbide	1.5
6282-0303	carbide	1.8
6282-0304	carbide	2.5
6282-0305	carbide	4

## SHELL TYPE POINTS



6282-0202

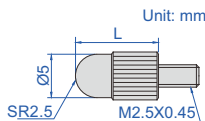

Code	Material of measuring face	L (mm)
6282-0202	steel	5
6282-0203	steel	10
6282-0205	steel	15

Code	Material of measuring face	L (mm)
6282-0207	steel	20
6282-0208	steel	25
6282-0210	steel	30

## SPHERICAL POINT



6282-0401

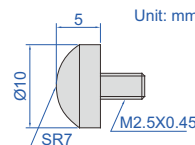

Code	Material of measuring face
6282-0401	steel

## CONICAL POINTS

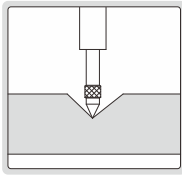

6282-0601

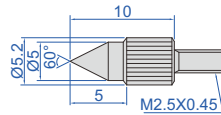

6282-0701

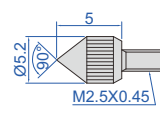

6282-0801

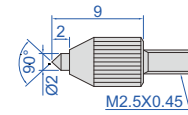

6282-0901

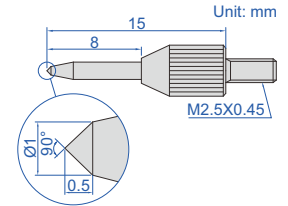

Code	Material of measuring face
6282-0601	steel
6282-0701	steel
6282-0801	steel
6282-0901	steel

## FLAT POINTS



6282-1101

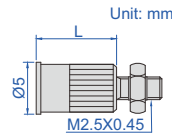

Code	Material of measuring face	L (mm)
6282-1101	steel	8
6282-1102	steel	10



6282-1301

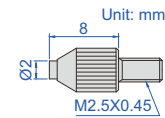

Code	Material of measuring face
6282-1301	carbide



6282-1201

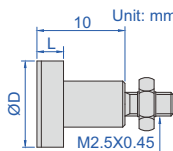

Code	Material of measuring face	ØD	L
6282-1201	steel	10mm	3mm
6282-1202	steel	15mm	4mm
6282-1203	steel	20mm	3mm
6282-1204	steel	25mm	4mm
6282-1205	steel	30mm	4mm



## NEEDLE POINTS



6282-1711

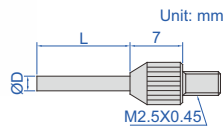

(mm)			
Code	Material of measuring face	ØD	L
6282-1701	steel	0.45	3
6282-1702	steel	0.45	5
6282-1703	carbide	1	3
6282-1704	carbide	1	5
6282-1705	carbide	1	8
6282-1706	carbide	1	10
6282-1707	carbide	1	20
6282-1708	carbide	1	40
6282-1709	carbide	1.5	5

(mm)			
Code	Material of measuring face	ØD	L
6282-1710	carbide	1.5	10
6282-1711	carbide	1.5	13
6282-1712	carbide	1.5	20
6282-1713	carbide	1.5	40
6282-1714	carbide	2	8
6282-1715	carbide	2	18
6282-1716	carbide	2	28
6282-1717	carbide	2	40



6282-1601

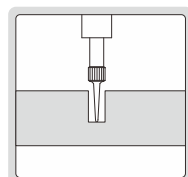
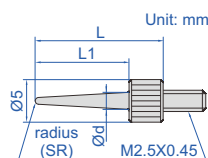

(mm)					
Code	Material of measuring face	L1	L	SR	Ød
6282-1601	steel	11	15	0.4	2
6282-1602	steel	13	17	0.2	2
6282-1603	steel	21	25	0.4	3
6282-1604	steel	31	35	0.4	3

## KNIFE EDGE POINT

Code	Material of measuring face
6282-1001	steel



6282-1001

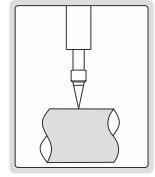
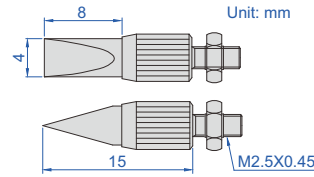

## BLADE POINTS

Code	Material of measuring face	D	W
6282-1801	steel	0.4mm	2mm
6282-1802	steel	0.6mm	2mm
6282-1803	steel	1mm	4mm



6282-1801

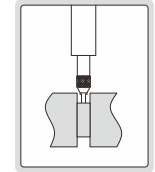
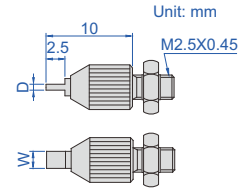

## ROLLER POINT

Code	Material of measuring face
6282-1901	steel

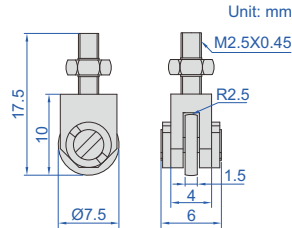

6282-1901

## EXTENSION RODS

11

Code	Material	L (mm)
6282-2001	steel	10
6282-2002	steel	15
6282-2003	steel	20
6282-2004	steel	25
6282-2005	steel	30
6282-2006	steel	35
6282-2007	steel	40
6282-2008	steel	45
6282-2009	steel	50

Code	Material	L (mm)
6282-2010	steel	55
6282-2011	steel	60
6282-2012	steel	65
6282-2013	steel	70
6282-2014	steel	75
6282-2015	steel	80
6282-2016	steel	90
6282-2017	steel	100



6282-2010

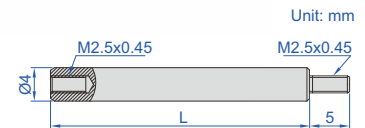

## POINT SET



6282-S6

Code	Material of measuring face
6282-S6	steel

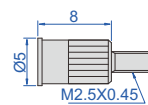

flat point

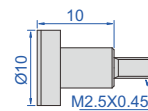

flat point

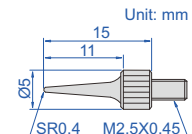

needle point

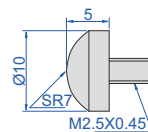

spherical point

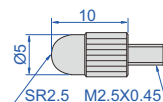

shell type point

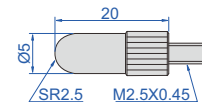

shell type point

SPINDLE LIFT KNOB

- For dial/digital indicators with spindle diameter  $\varnothing 4.5\text{mm}$  or  $\varnothing 5\text{mm}$

Code  
7332



7332

SHAFT SLEEVE

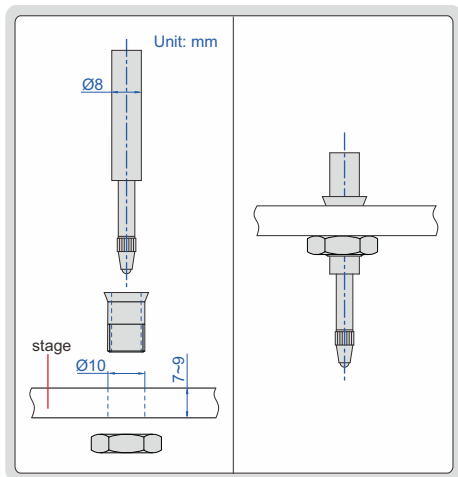

7333

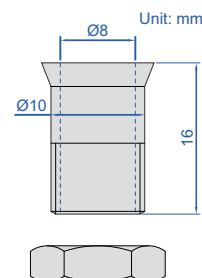

- For dial indicators and probes with shaft diameter  $\varnothing 8\text{mm}$

Code  
7333

MAGNETIC BACKS

Code	ØD	For digital/dial indicators
7331-M1	51.5mm	2103
		2104
		2108
		2109
		2112
		2115
		2116
		2117
		2118
		2138
		2139
		2501
		2301
		2302
		2308
		2309 (except 2309-30, 2309-30F)
		2313
2314		
2316		
2324		
2801		
7331-M2	54mm	2318



7331-M2

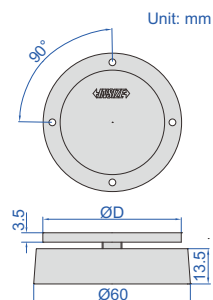

## FLAT BACKS

Code	For digital/ dial indicators
7330-F1	2311
7330-F2	2301
	2302
	2308
	2309 (except 2309-30, 2309-30F)
	2313
	2314
	2316
	2324
7330-F5	2801
	2103
	2104
	2108
	2109
	2112
	2115
	2116
	2117
	2118
	2138
	2139
	2501
	2137



7330-F2



7330-F8

Code	For digital/ dial indicators
7330-F6	2318
	2307
	2326
7330-F7	2830
	2882
	2885
	2888
	2889
	2891
	2892
7330-F8	2890
7330-F9	2887
7330-F10	2886
7330-F10	2310

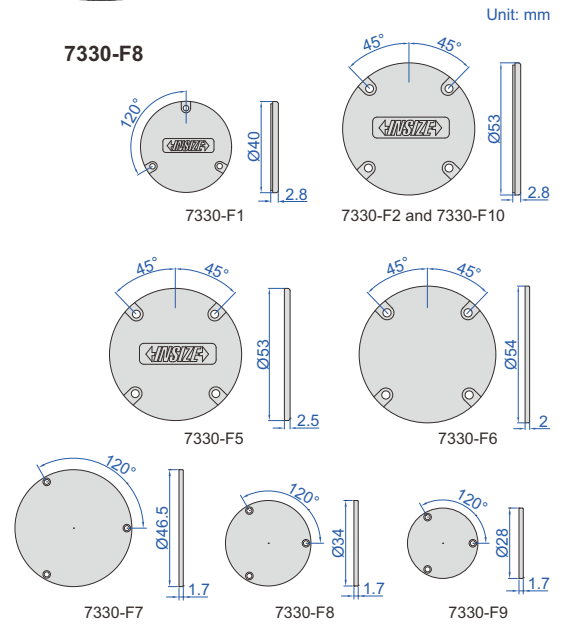

## LUG BACKS

11

Code	For digital/ dial indicators
7330-L1	2311
7330-L2	2301
	2302
	2308
	2309 (except 2309-30, 2309-30F)
	2313
	2314
	2316
	2324
7330-L5	2801
	2103
	2104
	2108
	2109
	2112
	2115
	2116
	2117
	2118
	2138
	2139
	2501
	2137



7330-L2



7330-L8

Code	For digital/ dial indicators
7330-L6	2318
	2307
	2326
7330-L7	2830
	2882
	2885
	2888
	2889
	2891
	2892
7330-L8	2890
7330-L10	2887
7330-L10	2310

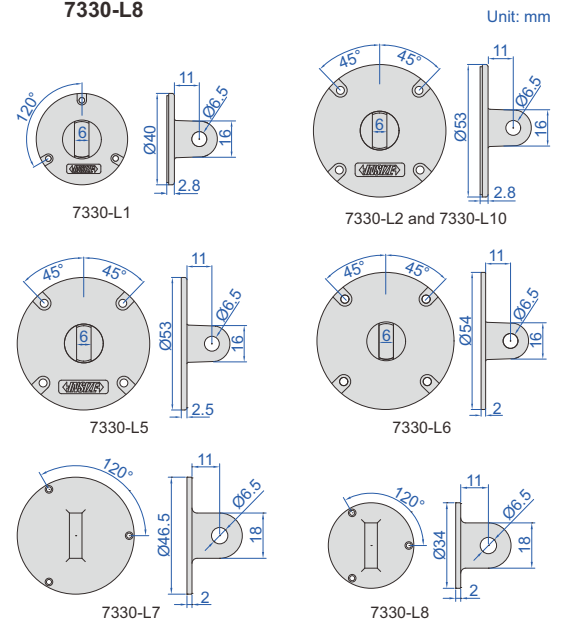

ATTENTION: NOT SUITABLE FOR DIAL INDICATORS WITH GRADUATION 0.001MM



## DIAL INDICATOR TESTER CODE 2396-25A

- To calibrate dial indicators, test indicators and dial bore gages
- Dimension: 270x210x205mm
- Weight: 11kg

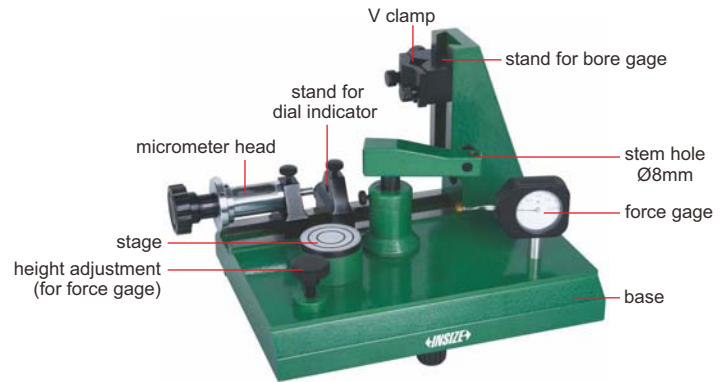

2396-25A

### Micrometer head

Range	Sampling interval	Accuracy	Hysteresis
0-25mm	0.1mm	4µm (0-25mm), 3µm (0-10mm), 2µm (0-1mm)	1µm

### Force gage

Range	Graduation	Accuracy
0-1.6N	0.05N	±5% (of load capacity)

### Stage

Diameter	Flatness	Roughness
50mm	1µm	0.05µm



inspect accuracy of dial indicators (range 0-25mm)



inspect accuracy of dial bore gages (range 6-450mm)



inspect accuracy of test indicators



check force of dial indicators



check repeatability of dial indicators



check the effect of lateral force on accuracy of dial indicators (half round gage block is required)



check the effect of lateral force on accuracy of test indicators (half round gage block is required)

### Half round gage block (optional)

Code	Parallelism
2396-block	1µm



## LINEAR GAGES AND DISPLAY UNIT

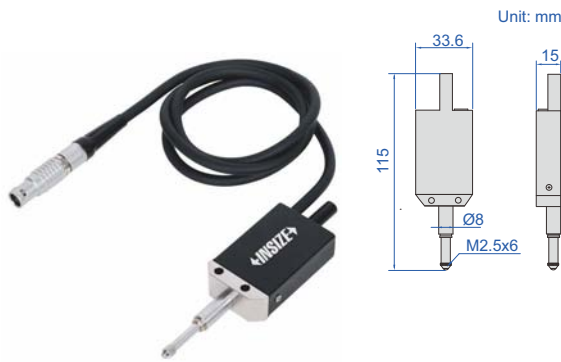

linear gage  
7131-01



display unit  
7131-1A



- Linear gage type: optical grating
- Display unit: display displacement data in real time, data preset, set tolerance and make judgment (out of upper tolerance, within tolerance, out of lower tolerance), set zero, change measuring direction, resolution (0.1μm/1μm), unit switch (μm/mm/inch)
- Two data transmission methods: can output keyboard signal and data can be transmitted to excel, word, txt etc, can also output serial signal and transmit data to serial communication software

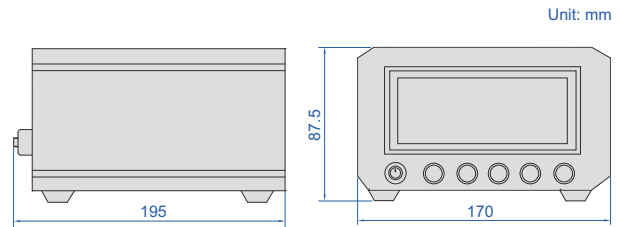

### LINEAR GAGE SPECIFICATION

Code	7131-01	7131-02
Range	12.5mm	12.5mm
Resolution	0.1μm	1μm
Accuracy (19~20°C)	1μm	3μm
Repeatability	0.2μm	2μm
Linear gage type	optical grating	
Working life	ten million times	
Dust/waterproof	IP50	
Measuring force	0.7±0.3N	
Cable length	900mm	
Operation environment	0~40°C, 20~80%RH	
Power supply	5~24V	
Dimension (L×W×H)	33.6×15×115mm	
Weight	133g	



### DISPLAY UNIT SPECIFICATION

Code	7131-1A
Display	4" LCD screen
Unit	μm, mm, inch
Quantity of linear gage to be connected	1 pc
Dimension (L×W×H)	170×195×87.5mm
Weight	1.45kg

## DIGITAL LINEAR GAGES

ABSOLUTE ENCODER, THE ORIGINAL DATA REMAINS AFTER POWER OFF

DUSTPROOF WATERPROOF

- Scale type: optical grating
- Absolute encoder, the original data remains after power off
- Digital signal output, amplifier is not required
- Measuring force: ≤1.5N
- Dust/waterproof: IP43/IP66
- Baud rate: 9600 (can be customized)
- Cable length: 3m (can be customized)



7130-10

7130-10L

To be continued







Continued from previous page

**Dust/waterproof IP43, resolution 0.1µm**

Code	Range	Repeatability	Accuracy	Outgoing cable direction	Output signal	Output interface
7130-10	0-12.5mm	0.5µm	1µm	horizontal	RS232, TTL level	
7130-10L	0-12.5mm	0.5µm	1µm	vertical	RS232, TTL level	
7130-11	0-12.5mm	0.5µm	1µm	horizontal	RS232, 232 level	
7130-11L	0-12.5mm	0.5µm	1µm	vertical	RS232, 232 level	
7130-12	0-12.5mm	0.5µm	1µm	horizontal	RS485 (VCC+5~12V)	
7130-12L	0-12.5mm	0.5µm	1µm	vertical	RS485 (VCC+5~12V)	
7130-13	0-12.5mm	0.5µm	1µm	horizontal	RS232, TTL level	
7130-13L	0-12.5mm	0.5µm	1µm	vertical	RS232, TTL level	
7130-14	0-12.5mm	0.5µm	1µm	horizontal	RS232, 232 level	
7130-14L	0-12.5mm	0.5µm	1µm	vertical	RS232, 232 level	

**Dust/waterproof IP43, resolution 0.5µm**

Code	Range	Repeatability	Accuracy	Outgoing cable direction	Output signal	Output interface
7130-20	0-12.5mm	1.5µm	3µm	horizontal	RS232, TTL level	
7130-20L	0-12.5mm	1.5µm	3µm	vertical	RS232, TTL level	
7130-21	0-12.5mm	1.5µm	3µm	horizontal	RS232, 232 level	
7130-21L	0-12.5mm	1.5µm	3µm	vertical	RS232, 232 level	
7130-22	0-12.5mm	1.5µm	3µm	horizontal	RS485 (VCC+5~12V)	
7130-22L	0-12.5mm	1.5µm	3µm	vertical	RS485 (VCC+5~12V)	
7130-23	0-12.5mm	1.5µm	3µm	horizontal	RS232, TTL level	
7130-23L	0-12.5mm	1.5µm	3µm	vertical	RS232, TTL level	
7130-24	0-12.5mm	1.5µm	3µm	horizontal	RS232, 232 level	
7130-24L	0-12.5mm	1.5µm	3µm	vertical	RS232, 232 level	

**Dust/waterproof IP66, resolution 0.1µm**

Code	Range	Repeatability	Accuracy	Outgoing cable direction	Output signal	Output interface
7130-30	0-12.5mm	0.5µm	1µm	horizontal	RS232, TTL level	
7130-30L	0-12.5mm	0.5µm	1µm	vertical	RS232, TTL level	
7130-31	0-12.5mm	0.5µm	1µm	horizontal	RS232, 232 level	
7130-31L	0-12.5mm	0.5µm	1µm	vertical	RS232, 232 level	
7130-32	0-12.5mm	0.5µm	1µm	horizontal	RS485 (VCC+5~12V)	
7130-32L	0-12.5mm	0.5µm	1µm	vertical	RS485 (VCC+5~12V)	
7130-33	0-12.5mm	0.5µm	1µm	horizontal	RS232, TTL level	
7130-33L	0-12.5mm	0.5µm	1µm	vertical	RS232, TTL level	
7130-34	0-12.5mm	0.5µm	1µm	horizontal	RS232, 232 level	
7130-34L	0-12.5mm	0.5µm	1µm	vertical	RS232, 232 level	

**Dust/waterproof IP66, resolution 0.5µm**

Code	Range	Repeatability	Accuracy	Outgoing cable direction	Output signal	Output interface
7130-40	0-12.5mm	1.5µm	3µm	horizontal	RS232, TTL level	
7130-40L	0-12.5mm	1.5µm	3µm	vertical	RS232, TTL level	
7130-41	0-12.5mm	1.5µm	3µm	horizontal	RS232, 232 level	
7130-41L	0-12.5mm	1.5µm	3µm	vertical	RS232, 232 level	
7130-42	0-12.5mm	1.5µm	3µm	horizontal	RS485 (VCC+5~12V)	
7130-42L	0-12.5mm	1.5µm	3µm	vertical	RS485 (VCC+5~12V)	
7130-43	0-12.5mm	1.5µm	3µm	horizontal	RS232, TTL level	
7130-43L	0-12.5mm	1.5µm	3µm	vertical	RS232, TTL level	
7130-44	0-12.5mm	1.5µm	3µm	horizontal	RS232, 232 level	
7130-44L	0-12.5mm	1.5µm	3µm	vertical	RS232, 232 level	

# PNEUMATIC DIGITAL LINEAR GAGES



DUSTPROOF  
WATERPROOF

ABSOLUTE ENCODER, THE ORIGINAL  
DATA REMAINS AFTER POWER OFF

- Scale type: optical grating
- Absolute encoder, the original data remains after power off
- Digital signal output, amplifier is not required
- Air pressure: 0.2-0.5MPa
- Measuring force: ≤1.5N
- Dust/waterproof: IP43/IP66
- Baud rate: 9600 (can be customized)
- Cable length: 3m (can be customized)

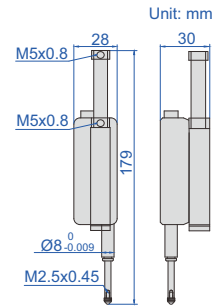

7134-10L

## Dust/waterproof IP43, resolution 0.1µm

Code	Range	Repeatability	Accuracy	Outgoing cable direction	Output signal	Output interface
7134-10	0-12.5mm	0.5µm	1µm	horizontal	RS232, TTL level	
7134-10L	0-12.5mm	0.5µm	1µm	vertical	RS232, TTL level	
7134-11	0-12.5mm	0.5µm	1µm	horizontal	RS232, 232 level	
7134-11L	0-12.5mm	0.5µm	1µm	vertical	RS232, 232 level	
7134-12	0-12.5mm	0.5µm	1µm	horizontal	RS485 (VCC+5~12V)	
7134-12L	0-12.5mm	0.5µm	1µm	vertical	RS485 (VCC+5~12V)	
7134-13	0-12.5mm	0.5µm	1µm	horizontal	RS232, TTL level	
7134-13L	0-12.5mm	0.5µm	1µm	vertical	RS232, TTL level	
7134-14	0-12.5mm	0.5µm	1µm	horizontal	RS232, 232 level	
7134-14L	0-12.5mm	0.5µm	1µm	vertical	RS232, 232 level	

## Dust/waterproof IP43, resolution 0.5µm

Code	Range	Repeatability	Accuracy	Outgoing cable direction	Output signal	Output interface
7134-20	0-12.5mm	1.5µm	3µm	horizontal	RS232, TTL level	
7134-20L	0-12.5mm	1.5µm	3µm	vertical	RS232, TTL level	
7134-21	0-12.5mm	1.5µm	3µm	horizontal	RS232, 232 level	
7134-21L	0-12.5mm	1.5µm	3µm	vertical	RS232, 232 level	
7134-22	0-12.5mm	1.5µm	3µm	horizontal	RS485 (VCC+5~12V)	
7134-22L	0-12.5mm	1.5µm	3µm	vertical	RS485 (VCC+5~12V)	
7134-23	0-12.5mm	1.5µm	3µm	horizontal	RS232, TTL level	
7134-23L	0-12.5mm	1.5µm	3µm	vertical	RS232, TTL level	
7134-24	0-12.5mm	1.5µm	3µm	horizontal	RS232, 232 level	
7134-24L	0-12.5mm	1.5µm	3µm	vertical	RS232, 232 level	

## Dust/waterproof IP66, resolution 0.1µm

Code	Range	Repeatability	Accuracy	Outgoing cable direction	Output signal	Output interface
7134-30	0-12.5mm	0.5µm	1µm	horizontal	RS232, TTL level	
7134-30L	0-12.5mm	0.5µm	1µm	vertical	RS232, TTL level	
7134-31	0-12.5mm	0.5µm	1µm	horizontal	RS232, 232 level	
7134-31L	0-12.5mm	0.5µm	1µm	vertical	RS232, 232 level	
7134-32	0-12.5mm	0.5µm	1µm	horizontal	RS485 (VCC+5~12V)	
7134-32L	0-12.5mm	0.5µm	1µm	vertical	RS485 (VCC+5~12V)	
7134-33	0-12.5mm	0.5µm	1µm	horizontal	RS232, TTL level	
7134-33L	0-12.5mm	0.5µm	1µm	vertical	RS232, TTL level	
7134-34	0-12.5mm	0.5µm	1µm	horizontal	RS232, 232 level	
7134-34L	0-12.5mm	0.5µm	1µm	vertical	RS232, 232 level	

To be continued

Continued from previous page

**Dust/waterproof IP66, resolution 0.5 $\mu$ m**

Code	Range	Repeatability	Accuracy	Outgoing cable direction	Output signal	Output interface
7134-40	0-12.5mm	1.5 $\mu$ m	3 $\mu$ m	horizontal	RS232, TTL level	
7134-40L	0-12.5mm	1.5 $\mu$ m	3 $\mu$ m	vertical	RS232, TTL level	
7134-41	0-12.5mm	1.5 $\mu$ m	3 $\mu$ m	horizontal	RS232, 232 level	
7134-41L	0-12.5mm	1.5 $\mu$ m	3 $\mu$ m	vertical	RS232, 232 level	
7134-42	0-12.5mm	1.5 $\mu$ m	3 $\mu$ m	horizontal	RS485 (VCC+5~12V)	
7134-42L	0-12.5mm	1.5 $\mu$ m	3 $\mu$ m	vertical	RS485 (VCC+5~12V)	
7134-43	0-12.5mm	1.5 $\mu$ m	3 $\mu$ m	horizontal	RS232, TTL level	
7134-43L	0-12.5mm	1.5 $\mu$ m	3 $\mu$ m	vertical	RS232, TTL level	
7134-44	0-12.5mm	1.5 $\mu$ m	3 $\mu$ m	horizontal	RS232, 232 level	
7134-44L	0-12.5mm	1.5 $\mu$ m	3 $\mu$ m	vertical	RS232, 232 level	

**MULTICHANNEL INTERFACE BOXES OF LINEAR GAGES**



- Can be connected with 7130 or 7134 series linear gages
- Optional accessory: software of linear gage (code: 7130-SOFTWARE, 8 linear gages can be connected simultaneously)

software of linear gage (optional)

view and export historical trend

view and export historical data

real-time data

real-time trend

data trend chart

the software can set tolerance and make real-time judgment (red when out of tolerance, green when within tolerance), set zero, data collection interval time, color, type and line width of trend lines, can view and export data to Excel report or BMP image

7212-4A application

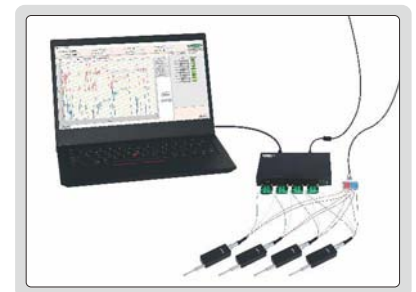

7324-HUB4 application

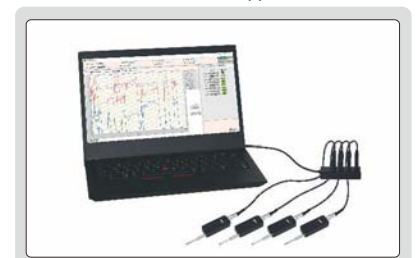

**SPECIFICATION**

Code	7212-4A	7212-8A	7324-HUB4	7324-HUB7
Quantity of linear gages	4	8	4	7
Applicable linear gages	7130-12, 7130-12L, 7130-22, 7130-32, 7130-32L, 7130-42, 7130-42L, 7134-12, 7134-12L, 7134-22, 7134-22L, 7134-32, 7134-32L, 7134-42, 7134-42L		7130-10, 7130-10L, 7130-20, 7130-20L, 7130-30, 7130-30L, 7130-40, 7130-40L, 7134-10, 7134-10L, 7134-20, 7134-20L, 7134-30, 7134-30L, 7134-40, 7134-40L	
Type of linear gage	RS485 protocol		RS232 protocol	
Type of output	USB		USB	

# LINEAR GAGES

LINEAR GAGE  
**IP65**  
WATERPROOF



7107-12

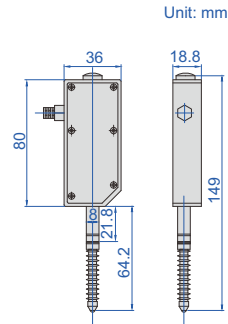

7107-11  
7107-12



7107-12V

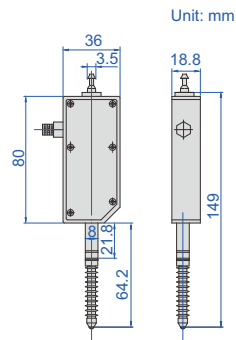

7107-11V  
7107-12V

- Capacitance type linear encoder
- Shock-proof, water proof, dust proof, suitable for high speed movement, long working life
- Optional: display unit **7106-1A**, multichannel interface box **7107-1** or **7107-2**

### SPECIFICATION

Code	7107-11	7107-12	7107-11V	7107-12V
Measuring range	12mm/0.47"	12mm/0.47"	12mm/0.47"	12mm/0.47"
Resolution	0.01mm/0.0004"	0.001mm/0.00004"	0.01mm/0.0004"	0.001mm/0.00004"
Accuracy	20µm	5µm	20µm	5µm
Hysteresis	10µm	2µm	10µm	2µm
Driving type	spring		pneumatic	
Measuring force	1.5N		adjusted by air pressure	
Measuring principle	capacitance type linear encoder			
Voltage	5V			
Sampling frequency	100 times/sec			
Working life	ten million times			
Dust/waterproof	IP65			
Cable length	2m			
Data output	RS232			



## DISPLAY UNIT FOR CAPACITANCE LINEAR GAGES CODE 7106-1A

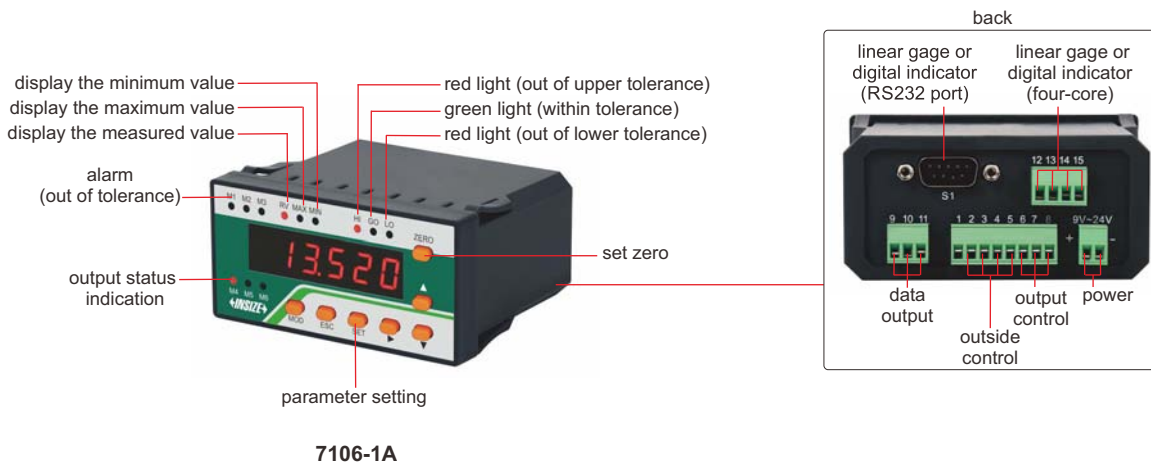

- Can be connected with **7107-11**, **7107-12**, **7107-11V** or **7107-12V** linear gage, can also be connected with digital indicator (data cable **7309-C01M** is needed)
- Set tolerance and make judgment (out of upper tolerance, within tolerance, out of lower tolerance), output the judgment to control outside devices, control from outside (set zero, hold reading and collect data)
- Software of display unit (included): in the software, it is possible to set tolerance and show judgment (red when out of tolerance, green when within tolerance), set zero, collect data manually or automatically (time is adjustable), output data to Excel, print report

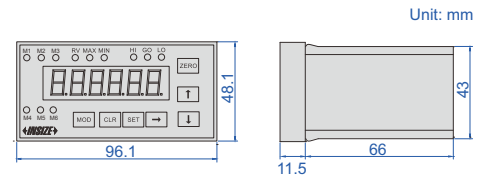

connected with **7107-11**, **7107-12**, **7107-11V** or **7107-12V** linear gage



11

connected with digital indicator (data cable **7309-C01M** is needed)



software (included)



### SPECIFICATION

Display	6 digits
Quantity of linear gage or digital indicator to be connected	1 pc
Tolerance	set tolerance and make judgment with alarm and lights (out of upper tolerance, within tolerance, out of lower tolerance)
Output control	output the tolerance judgment (out of upper tolerance, within tolerance, out of lower tolerance) to control outside devices
Outside control	control the display units from outside (set zero, hold reading and collect data)
Data output	connect to computer software and serial communication
Power supply	DC 9~24V

# MULTICHANNEL INTERFACE BOXES FOR CAPACITANCE LINEAR GAGES

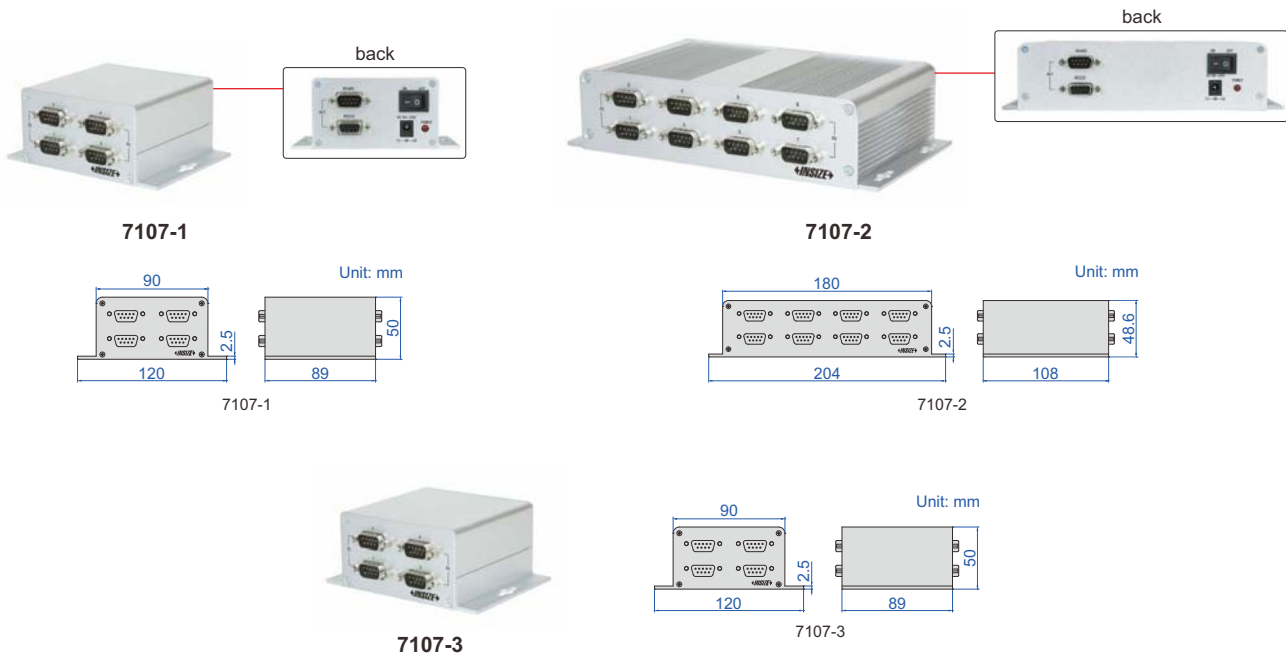

- Can be connected with 7107-11, 7107-12, 7107-11V or 7107-12V linear gages, can also be connected with digital indicators (data cable 7309-C01M is needed)
- Connection box (code: 7107-3) is needed to connect interface boxes, when two or more interface boxes are used. Maximum 4 interface boxes can be connected.
- Software of interface boxes (included): in the software, it is possible to set tolerance of each channel and show judgment (red when out of tolerance, green when within tolerance), set zero, collect data manually or automatically (time is adjustable), output data to Excel, print report.

software (included)

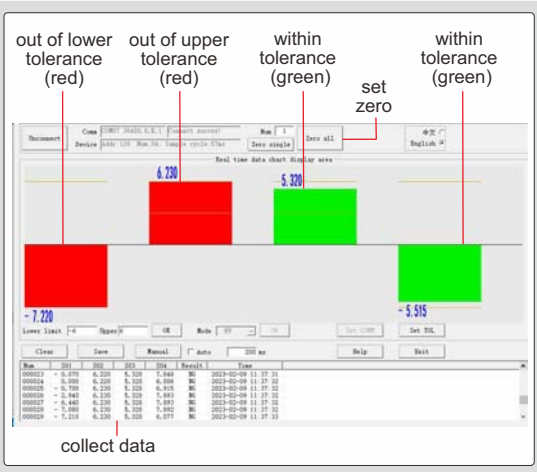

connected with 7107-11, 7107-12, 7107-11V or 7107-12V linear gages

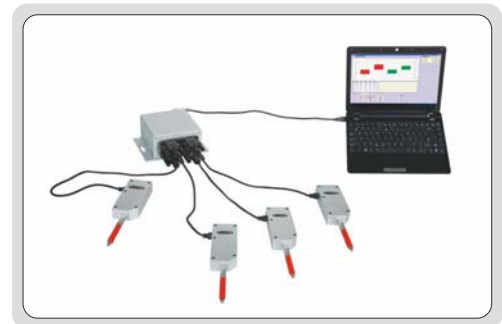

## INTERFACE BOX SPECIFICATION

Code	7107-1	7107-2
Quantity of linear gages or digital indicators to be connected	4 pcs	8 pcs
Data output	RS232 and RS485	
Power supply	DC 9~24V	

## CONNECTION BOX (OPTIONAL) SPECIFICATION

Code	7107-3
Quantity of interface boxes to be connected	4 pcs (maximum 4 interface boxes can be connected)
Data output	RS232 and RS485
Power supply	DC 9~24V

connected with digital indicators (data cable 7309-C01M is needed)

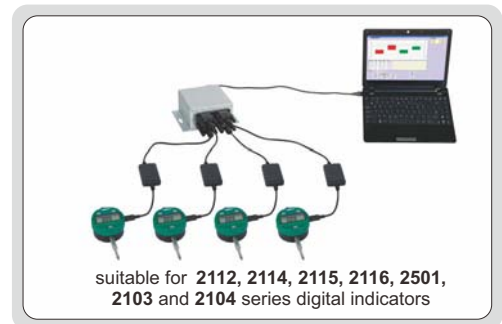

suitable for 2112, 2114, 2115, 2116, 2501, 2103 and 2104 series digital indicators

### DIAL TEST INDICATOR UNIVERSAL HOLDER



6297-1

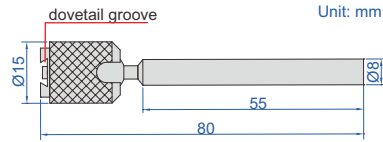

**Code**  
6297-1

- Set the indicators at the desired attitude to the workpiece

### DIAL TEST INDICATOR HOLDER



6296-1

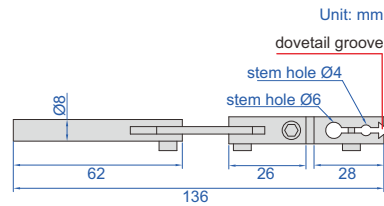

**Code**  
6296-1

- Supplied with hex key

### DIAL TEST INDICATOR HOLDERS



6293-1

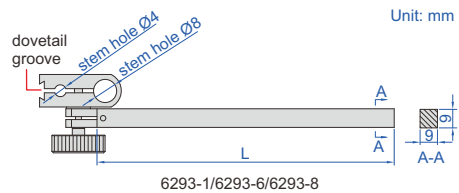

6293-2

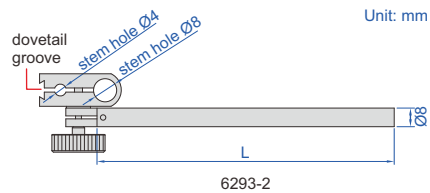

Code	Stem section	Stem length (L)
6293-1	9x9mm	100mm
6293-6	9x9mm	50mm
6293-8 *	9x9mm	200mm
6293-2	Ø8mm	115mm

\* Only apply for 0.01mm dial test indicator



## DIAL TEST INDICATOR HOLDER

- Can be used with dial test indicators



6291-1

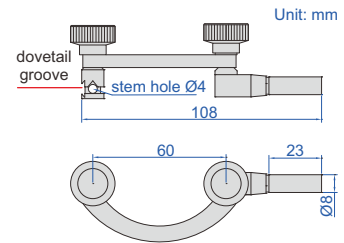

Code

6291-1

## DIAL TEST INDICATOR HOLDER

- Can be used with dial test indicators



6295-1A

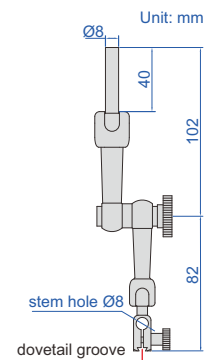

Code

6295-1A

## DIAL INDICATOR HOLDER

- Can be used with dial test indicators or dial indicators



6294-1A

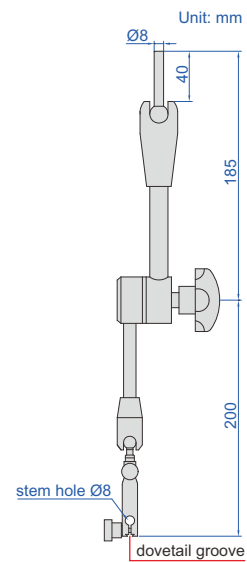

Code

6294-1A



## HYDRAULIC UNIVERSAL MAGNETIC STANDS

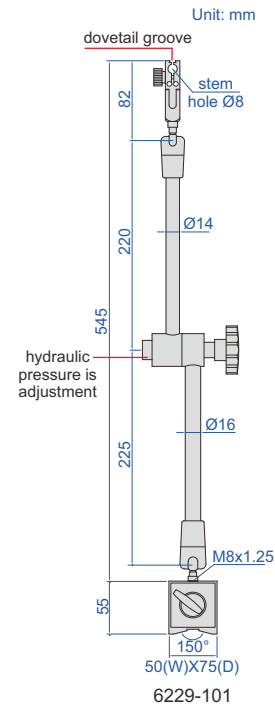
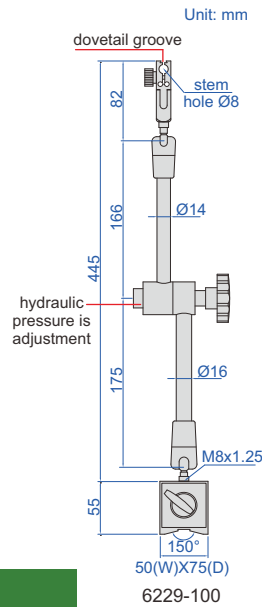
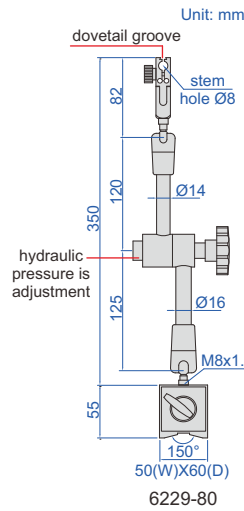
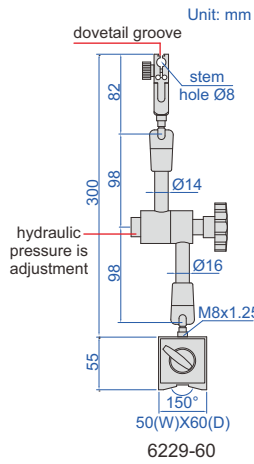

- Hydraulic pressure is adjustment
- For digital/dial indicators and dial test indicators

Code	Magnetic force	Applicable holding stem	Remark
6229-60	60kgf	Ø8mm	with fine adjustment and dovetail groove
6229-80	80kgf	Ø8mm	with fine adjustment and dovetail groove
6229-100	100kgf	Ø8mm	with fine adjustment and dovetail groove
6229-101	100kgf	Ø8mm	with fine adjustment and dovetail groove

## LARGE LOCKING FORCE MAGNETIC STAND

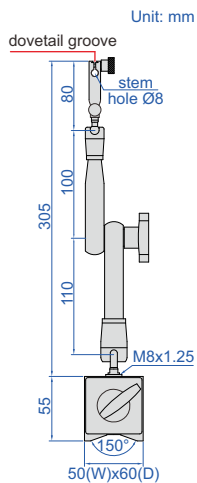

6219-80

- For digital/dial indicators and dial test indicators

Code	Magnetic force	Applicable holding stem	Remark
6219-80	80kgf	Ø8mm	with fine adjustment and dovetail groove

## UNIVERSAL MAGNETIC STANDS

POPULAR MODEL

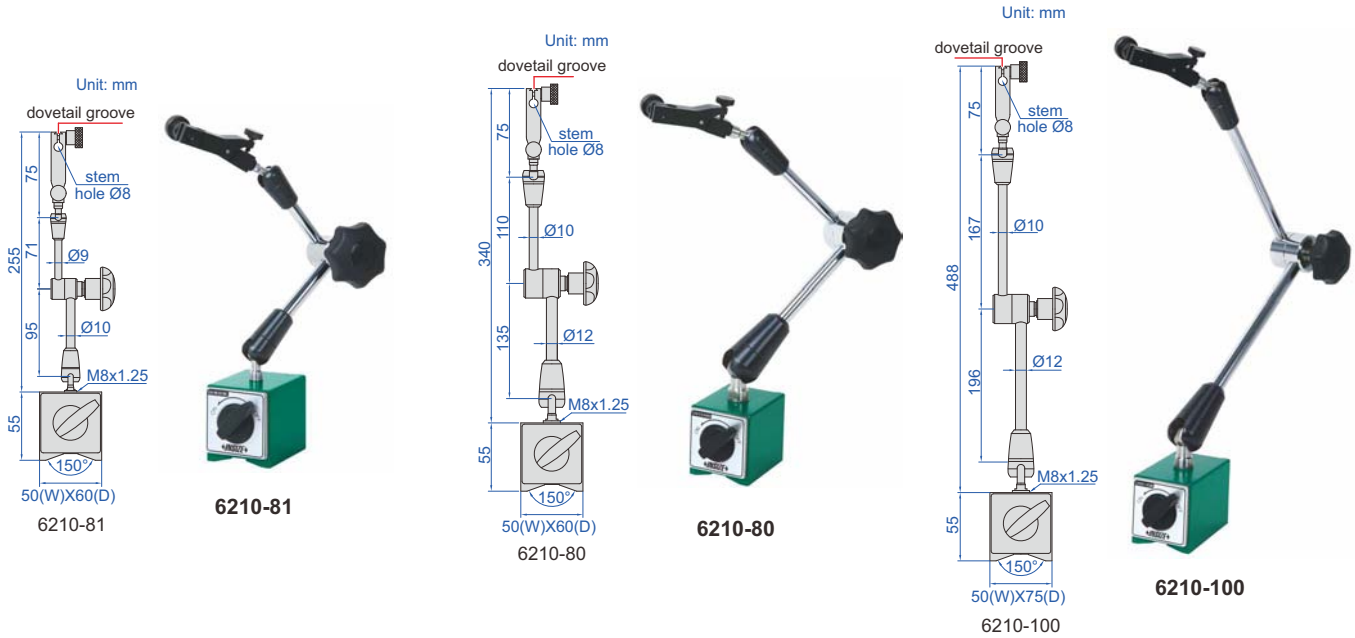

- For digital/dial indicators and dial test indicators

Code	Magnetic force	Applicable holding stem	Remark
6210-81	80kgf	Ø8mm	with fine adjustment and dovetail groove
6210-80	80kgf	Ø8mm	with fine adjustment and dovetail groove
6210-100	100kgf	Ø8mm	with fine adjustment and dovetail groove

11

## UNIVERSAL MAGNETIC STAND (ECONOMIC TYPE)

ATTENTION: LOW LOCKING FORCE

- For digital/dial indicators and dial test indicators

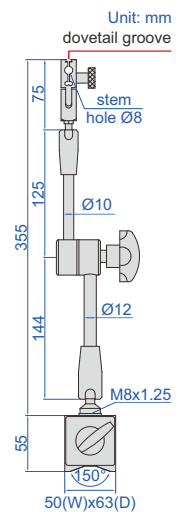

Code	Magnetic force	Applicable holding stem	Remark
6208-80A	80kgf	Ø8mm	with fine adjustment and dovetail groove

## MAGNETIC STAND WITH TWO FINE ADJUSTMENTS

- With two fine adjustments on the head and on the base
- For digital/dial indicators and dial test indicators

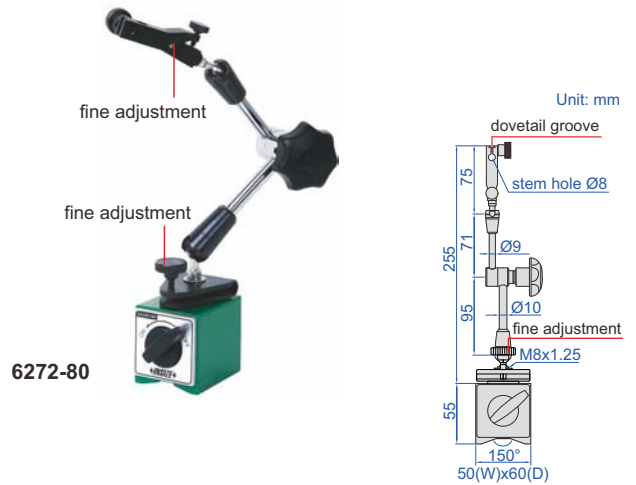

Code	Magnetic force	Applicable holding stem	Remark
6272-80	80kgf	Ø8mm	with two fine adjustments and dovetail groove

ATTENTION: FOR DIAL TEST INDICATORS ONLY

## HYDRAULIC MINI MAGNETIC STAND

- For dial test indicators
- With fine adjustment and dovetail groove
- Adjustable hydraulic force

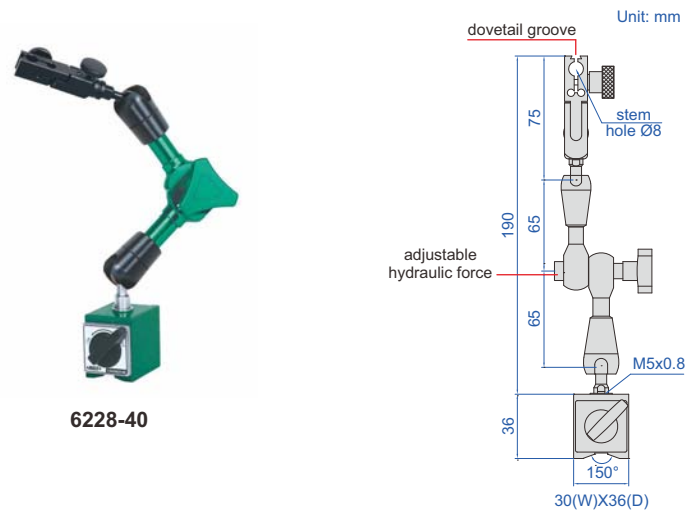

Code	Magnetic force	Applicable holding stem
6228-40	40kgf	Ø8mm

ATTENTION: FOR DIAL TEST INDICATORS ONLY

## MINI MAGNETIC STAND

- For dial test indicators
- With fine adjustment and dovetail groove

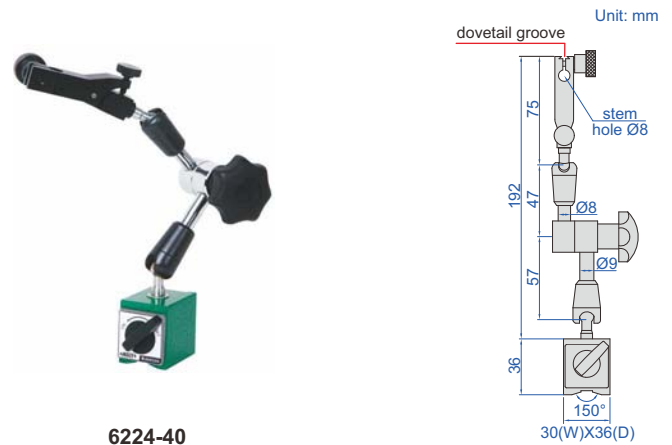

Code	Magnetic force	Applicable holding stem
6224-40	40kgf	Ø8mm

## MAGNETIC STANDS

POPULAR MODEL

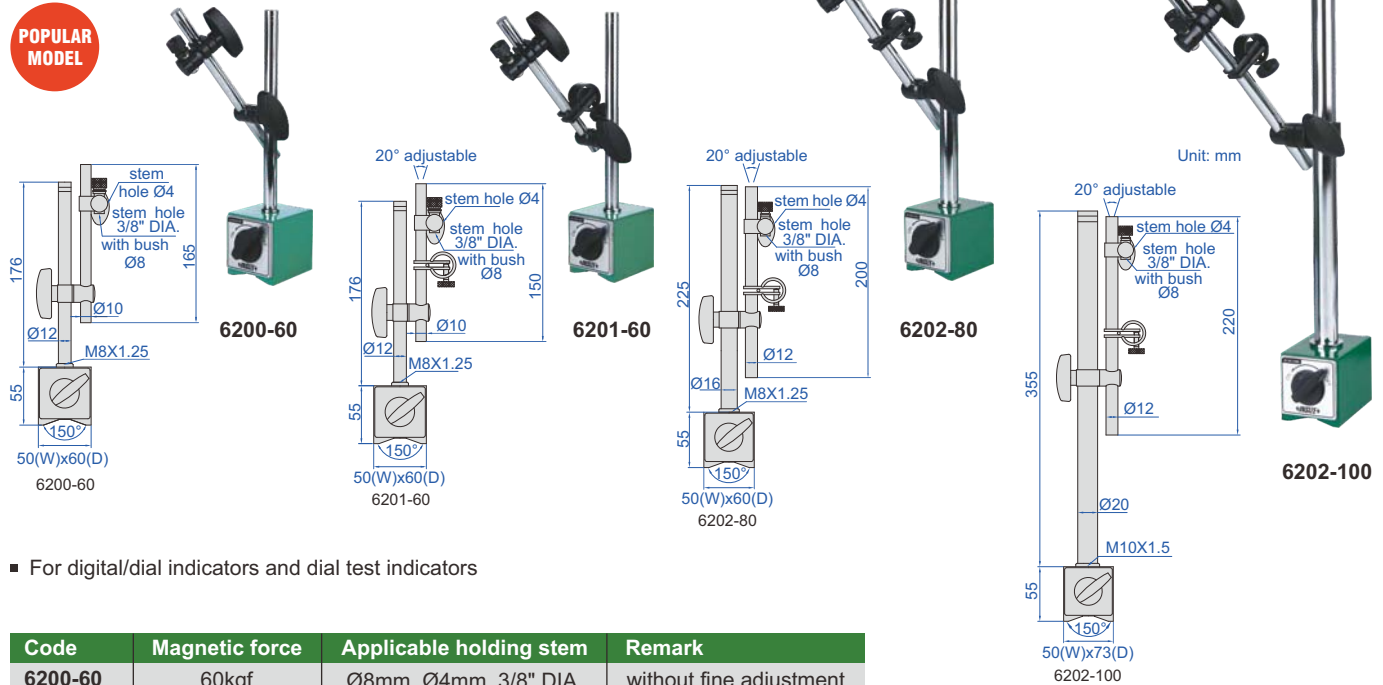

For digital/dial indicators and dial test indicators

Code	Magnetic force	Applicable holding stem	Remark
6200-60	60kgf	Ø8mm, Ø4mm, 3/8" DIA.	without fine adjustment
6201-60	60kgf	Ø8mm, Ø4mm, 3/8" DIA.	with fine adjustment
6202-80	80kgf	Ø8mm, Ø4mm, 3/8" DIA.	with fine adjustment
6202-100	100kgf	Ø8mm, Ø4mm, 3/8" DIA.	with fine adjustment

## MAGNETIC STAND (FOR 0.001MM DIAL AND TEST INDICATORS)

11

For 0.001mm and 0.01mm dial and test indicators

Code	Magnetic force	Applicable holding stem	Remark
6221-80	80kgf	Ø8mm	with fine adjustment and dovetail groove

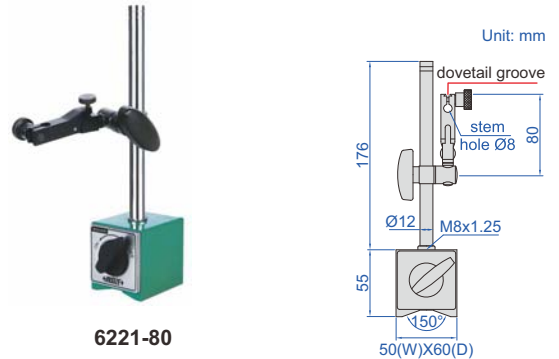

## MAGNETIC STAND

For digital/dial indicators and dial test indicators

Code	Magnetic force	Applicable holding stem	Remark
6216-80	80kgf	Ø8mm	with fine adjustment and dovetail groove



## MAGNETIC STAND FOR UNEVEN SURFACES

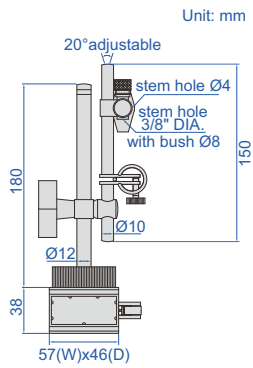

6215-60

- For digital/dial indicators and dial test indicators
- With fine adjustment

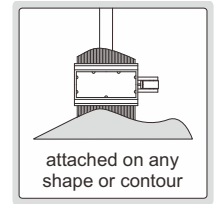

Code	Magnetic force	Applicable holding stem
6215-60	60kgf	Ø8mm, Ø4mm, 3/8" DIA.

## MINI MAGNETIC STAND

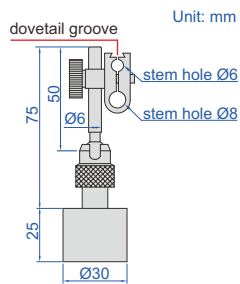

6211-10

ATTENTION: FOR DIAL TEST INDICATORS ONLY

- For dial test indicators
- With dovetail groove

Code	Magnetic force	Applicable holding stem
6211-10	10kgf	Ø6mm, Ø8mm

## FLEX ARM MAGNETIC STAND

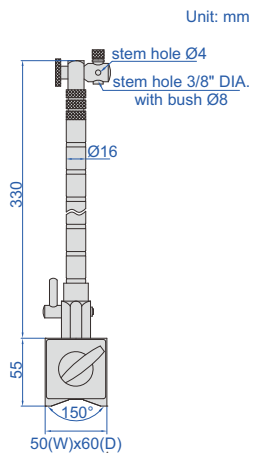

6207-80A

ATTENTION: FOR DIAL TEST INDICATORS ONLY

- For dial test indicators

Code	Magnetic force	Applicable holding stem
6207-80A	80kgf	Ø8mm, Ø4mm, 3/8" DIA.

## MAGNETIC BASES



6212-80

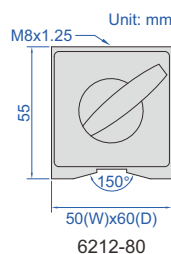

6212-100

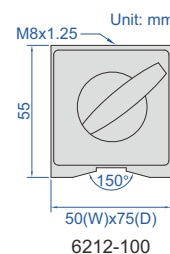

Code	Magnetic force
6212-80	80kgf
6212-100	100kgf

## VACUUM STAND

- Suitable for granite surface plates or cast iron surface plates
- For digital/dial indicators and dial test indicators

Code	Diameter of vacuum disc	Vacuum force	Applicable holding stem	Remark
6217-B	Ø80mm	80kgf	Ø8mm	with fine adjustment and dovetail groove



6217-B

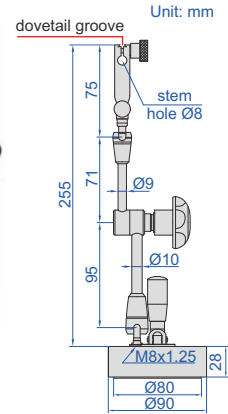

## UNIVERSAL STAND

- For digital/dial indicators and dial test indicators
- With fine adjustment

Code	Applicable holding stem
6214-A	Ø8mm, Ø4mm, 3/8" DIA.



6214-A

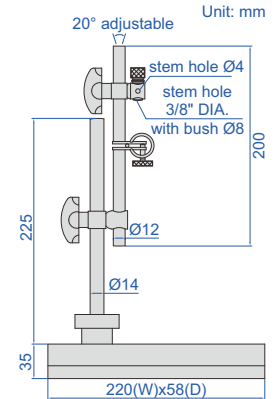

## DIAL INDICATOR STANDS (NON-MAGNETIC)

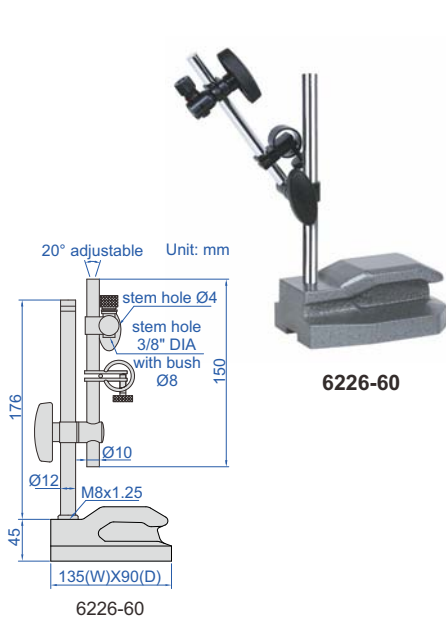

6226-60

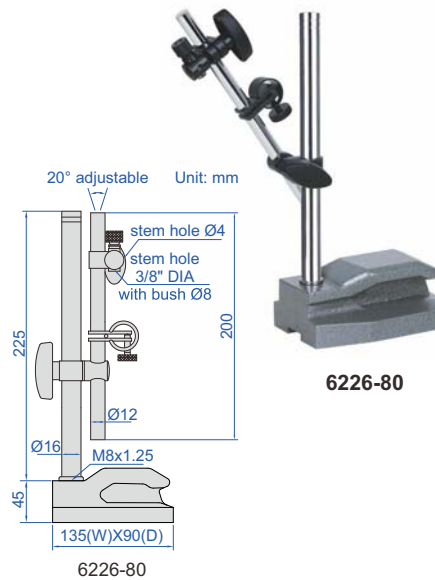

6226-80

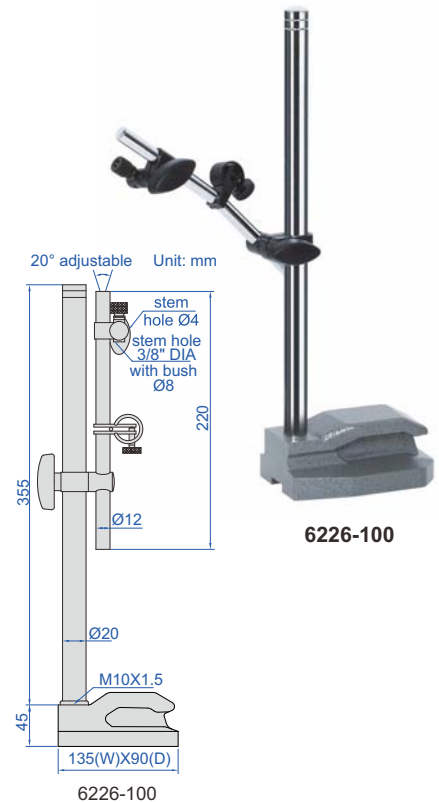

6226-100

Code	Applicable holding stem	Remark
6226-60	Ø8mm, Ø4mm, 3/8" DIA	with fine adjustment
6226-80	Ø8mm, Ø4mm, 3/8" DIA	with fine adjustment
6226-100	Ø8mm, Ø4mm, 3/8" DIA	with fine adjustment

- Hardened base
- Suitable for granite surface plates and cast iron surface plates
- For digital/dial indicators and dial test indicators

## DIAL INDICATOR STAND (FOR 0.001MM DIAL AND TEST INDICATORS)

- Non-magnetic and hardened base
- Suitable for granite surface plates or cast iron surface plates
- For 0.001mm and 0.01mm dial and test indicators

Code	Applicable holding stem	Remark
6230-60	Ø8mm	with fine adjustment and dovetail groove



6230-60

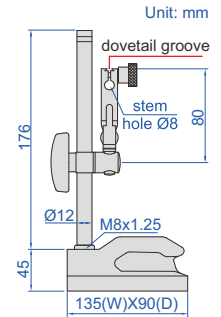

## DIAL INDICATOR STAND (NON-MAGNETIC)

- Hardened base
- Suitable for granite surface plates and cast iron surface plates
- For digital/dial indicators and dial test indicators

Code	Applicable holding stem	Remark
6227-80	Ø8mm	with fine adjustment and dovetail groove

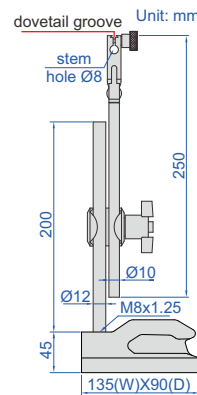

6227-80

## UNIVERSAL DIAL INDICATOR STANDS (NON-MAGNETIC)

- Hardened base
- Suitable for granite surface plates and cast iron surface plates
- For digital/dial indicators and dial test indicators



6225-80

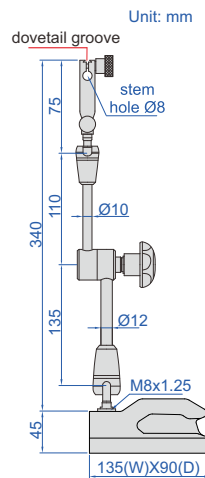

6225-80



6225-100

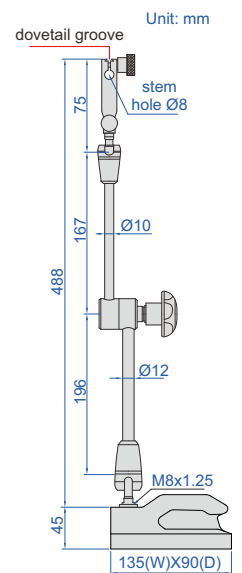

6225-100

Code	Applicable holding stem	Remark
6225-80	Ø8mm	with fine adjustment and dovetail groove
6225-100	Ø8mm	with fine adjustment and dovetail groove

## DIAL INDICATOR STANDS

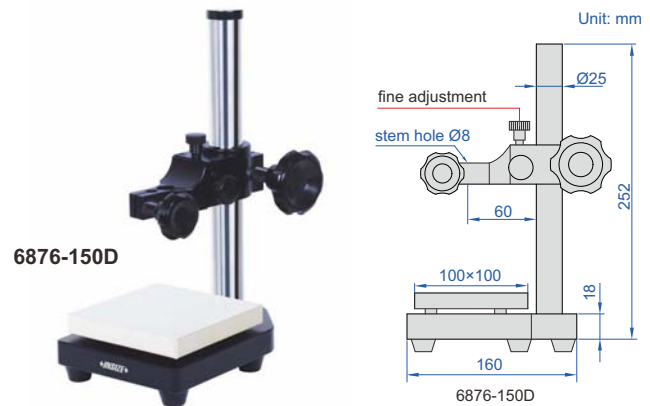
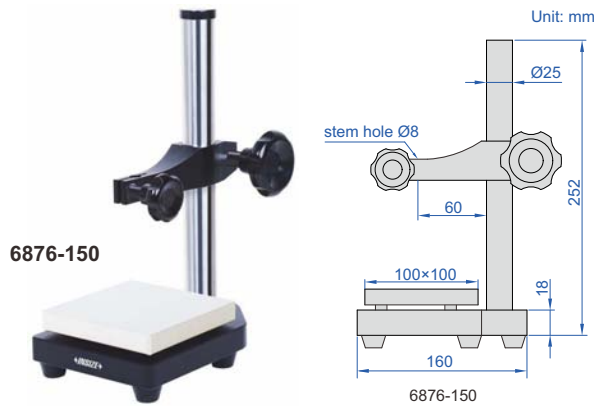

Code	Applicable holding stem	Anvil	Remark
6876-150	Ø8mm	ceramic, plain, flatness 1.5µm	without fine adjustment
6876-150D	Ø8mm	ceramic, plain, flatness 1.5µm	with fine adjustment, fine adjustment range 3mm

- Vertical travel of holder: 150mm
- Ceramic anvil
- Supplied with dust cover

## GRANITE DIAL INDICATOR STANDS (BASIC TYPE)

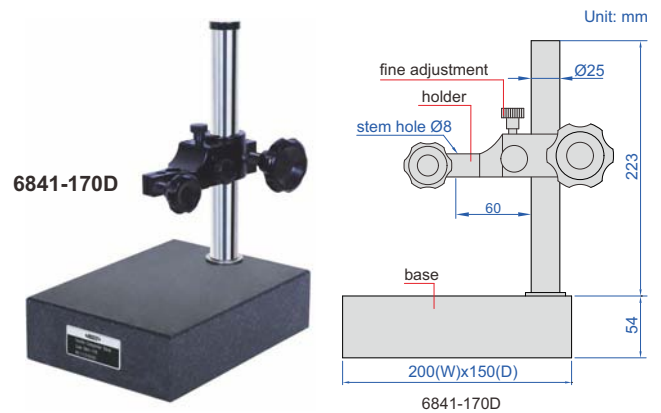
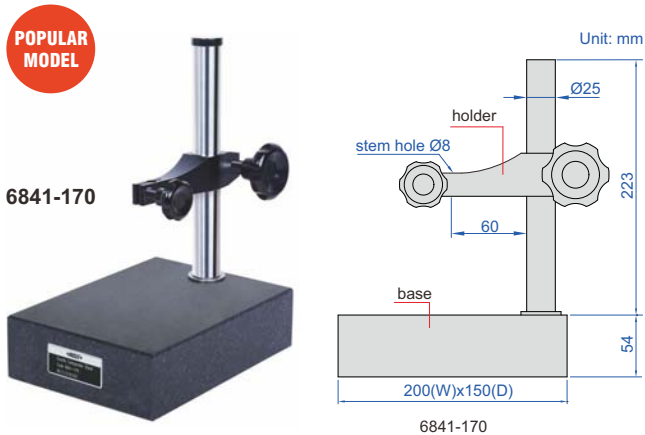

Code	Applicable holding stem	Base	Remark
6841-170	Ø8mm	flatness 2.5µm	without fine adjustment
6841-170D	Ø8mm	flatness 2.5µm	with fine adjustment, fine adjustment range 3mm

- Vertical travel of holder: 170mm
- Supplied with dust cover

## GRANITE DIAL INDICATOR STAND

- Vertical travel of holder: 150mm
- Fine adjustment range: 2mm
- Supplied with dust cover

Code	Applicable holding stem	Base
6866-150	Ø8mm	flatness 2.5µm

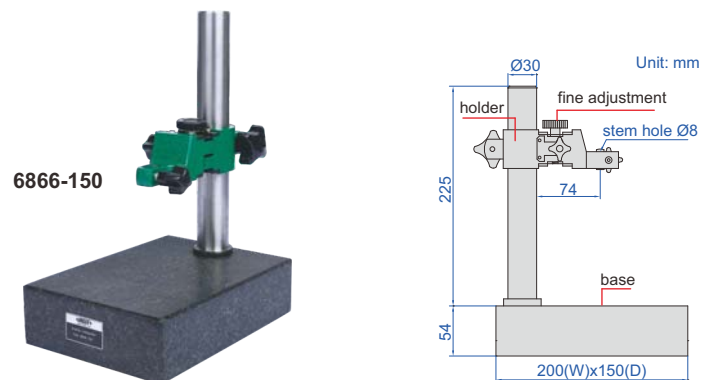



DATA  
OUTPUT

## DIGITAL GROOVE MEASUREMENT STANDS

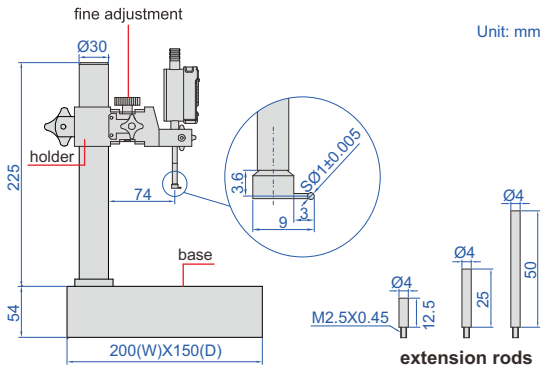

6870-150

- Button function: on/off, zero, mm/inch, measuring direction change, data preset, absolute/incremental measurement
- Vertical travel of holder: 150mm
- Fine adjustment range: 2mm
- CR2032 battery, automatic power off (time is adjustable)
- Data output
- Supplied with extension rods: 12.5mm (1 pc), 25mm (1 pc), 50mm (1 pc)
- Supplied with groove point and dust cover
- Optional accessory: data output cable (code **7315-50M** need receiver page 5, **7302-40M** page 13)

measure width (b) and depth (a) of groove

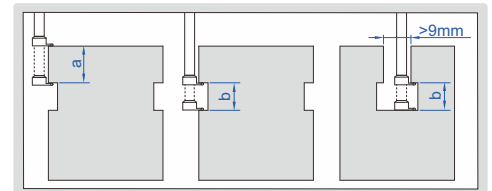

Code	Digital indicator stroke	Digital indicator resolution	Accuracy	Applicable holding stem	Base
6870-150	12.7mm/0.5"	0.01mm/0.0005"	$\pm 20\mu\text{m}$	$\varnothing 8\text{mm}$	flatness $2.5\mu\text{m}$
6870-1501	12.7mm/0.5"	0.001mm/0.00005"	$\pm 5\mu\text{m}$	$\varnothing 8\text{mm}$	flatness $2.5\mu\text{m}$

## GRANITE DIAL INDICATOR STANDS

11

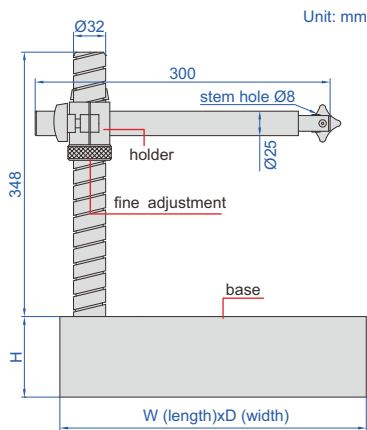

6867-250



6867-400

- Vertical travel of holder: 250mm
- Fine adjustment range: entire stroke
- Supplied with dust cover

Code	Applicable holding stem	W	D	H	Base
6867-250	$\varnothing 8\text{mm}$	300mm	300mm	75mm	flatness $2.8\mu\text{m}$
6867-400	$\varnothing 8\text{mm}$	400mm	300mm	100mm	flatness $3\mu\text{m}$

## DIAL INDICATOR STANDS

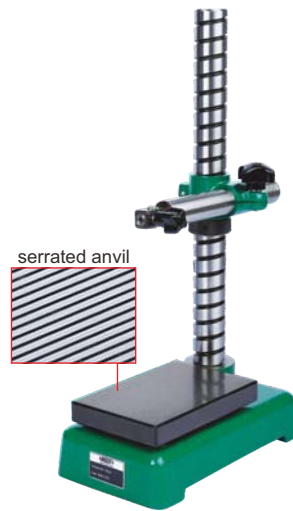
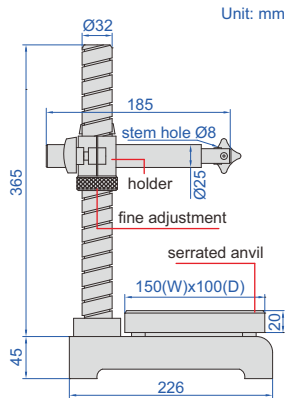

6864-250

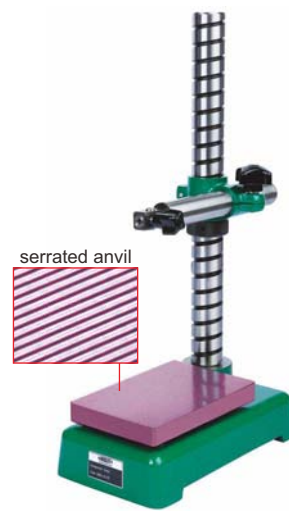

6864-250T

- Vertical travel of holder: 250mm
- Fine adjustment range: entire stroke
- Supplied with dust cover

Code	Applicable holding stem	Anvil
6864-250	Ø8mm	steel (hardness HRC60±2), serrated, flatness 1.5µm
6864-250T	Ø8mm	ceramic, serrated, flatness 1.5µm

## 11 DIAL INDICATOR STANDS

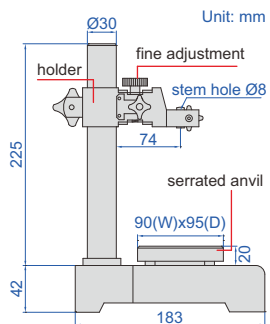

6863-150

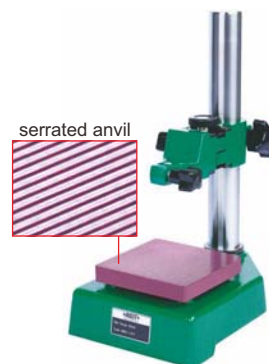

6863-150T

- Vertical travel of holder: 150mm
- Fine adjustment range: 2mm
- Supplied with dust cover

Code	Applicable holding stem	Anvil
6863-150	Ø8mm	steel (hardness HRC60±2), serrated, flatness 1.5µm
6863-150T	Ø8mm	ceramic, serrated, flatness 1.5µm

## DIAL INDICATOR STANDS



6862-1001



6862-1002

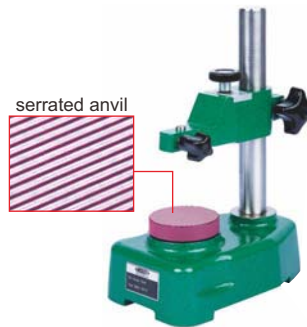
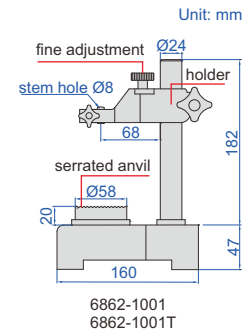

6862-1001T



6862-1002T

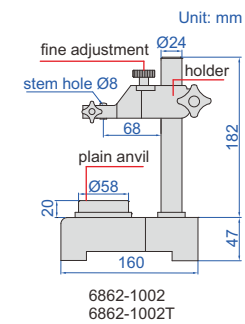

Code	Applicable holding stem	Anvil
6862-1001	Ø8mm	steel (hardness HRC60±2), serrated, flatness 1.5µm
6862-1002	Ø8mm	steel (hardness HRC60±2), plain, flatness 1.5µm
6862-1001T	Ø8mm	ceramic, serrated, flatness 1.5µm
6862-1002T	Ø8mm	ceramic, plain, flatness 1.5µm

- Vertical travel of holder: 100mm
- Fine adjustment range: 2mm
- Supplied with dust cover

## HEAVY DUTY DIAL INDICATOR STAND

- Vertical travel of holder: 300mm
- Fine adjustment range: 5mm
- Carbide base
- Supplied with dust cover
- Optional accessory:  
holder with stem hole Ø28 (code **6869-D28**)

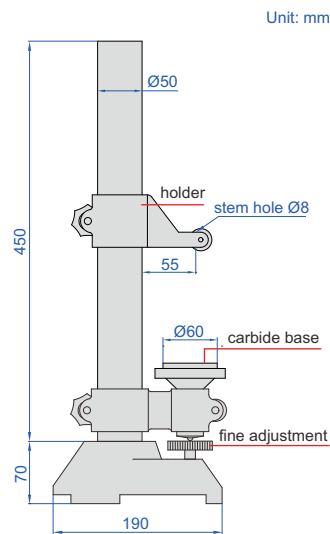

6869-300

Code	Applicable holding stem	Base
6869-300	Ø8mm	plain, flatness 1µm, carbide

DIAL INDICATOR STAND

GAGE BLOCKS ARE NEEDED FOR ZERO SETTING



digital/dial indicator is optional

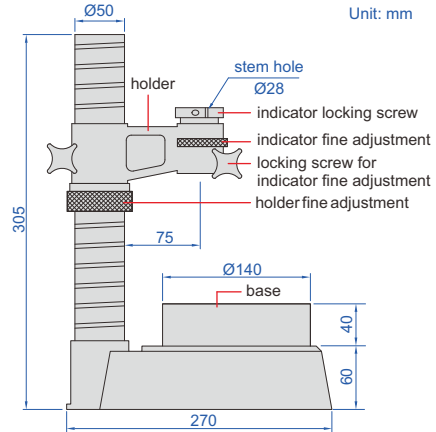

6842-150



locating fork for workpiece (included)



rotary lever probe (included)



base with step (included)



11

- Vertical travel of holder: 180mm
- Holder fine adjustment range: entire stroke
- Indicator fine adjustment range: 10mm
- Optional accessory: Ø28mm/Ø8mm bush (code 6843-B8), 0.001mm digital/dial indicators, high precision digital indicators (code 2140-6, 2140-6WL), gage blocks (4101 series, for zero setting)

the tip of rotary lever probe can reach narrow areas

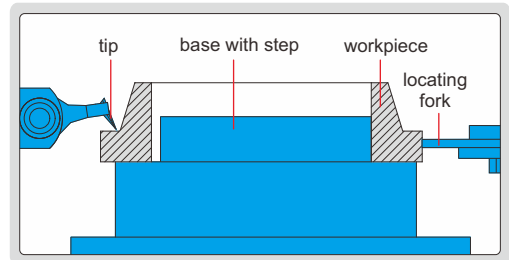

Code	Applicable holding stem	Base
6842-150	Ø28mm	flatness 2µm

Ø28mm/Ø8mm bush (optional)



Code  
6843-B8

application



locating fork for workpieces

base with step



rotary lever probe

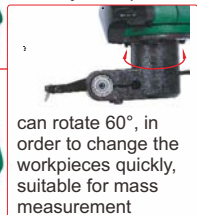

GAGE BLOCKS ARE NEEDED FOR ZERO SETTING

locating fork for workpieces (included)

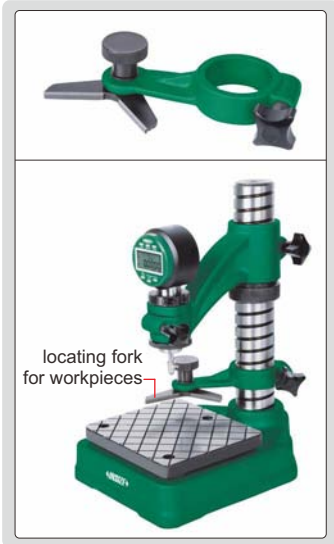

digital/dial indicator is optional



6846-140

## DIAL INDICATOR STAND

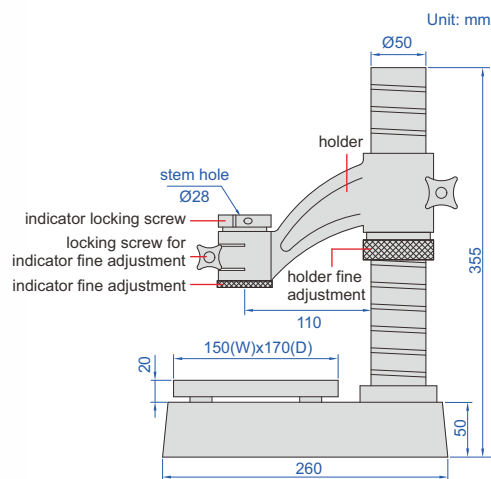

- Vertical travel of holder: 140mm
- Holder fine adjustment range: entire stroke
- Indicator fine adjustment range: 3mm
- Optional accessory: Ø28mm/Ø8mm bush (code 6843-B8), 0.001mm digital/dial indicators, high precision digital indicators (code 2140-6, 2140-6WL), gage blocks (4101 series, for zero setting)

Code	Applicable holding stem	Anvil
6846-140	Ø28mm	grid, flatness 1µm

Ø28mm/Ø8mm bush (optional)



Code 6843-B8

application



GAGE BLOCKS ARE NEEDED FOR ZERO SETTING

locating fork for workpieces (included)



digital/dial indicator is optional



6845-100

## DIAL INDICATOR STAND

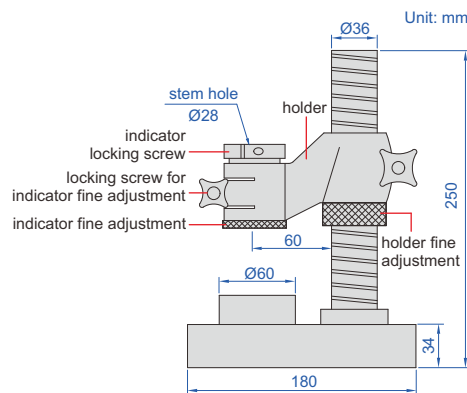

- Vertical travel of holder: 100mm
- Holder fine adjustment range: entire stroke
- Indicator fine adjustment range: 3mm
- Optional accessory: Ø28mm/Ø8mm bush (code 6843-B8), 0.001mm digital/dial indicators, high precision digital indicators (code 2140-6, 2140-6WL), gage blocks (4101 series, for zero setting)

Code	Applicable holding stem	Anvil
6845-100	Ø28mm	serrated, flatness 1µm

Ø28mm/Ø8mm bush (optional)



Code 6843-B8

application



## TRANSFER STANDS

application



rigid construction, designed to make comparison height measurement (set zero with gage block then measure height of workpiece) with dial indicators or digital indicators (variation of measuring force is high)



6865-300



6865-300T

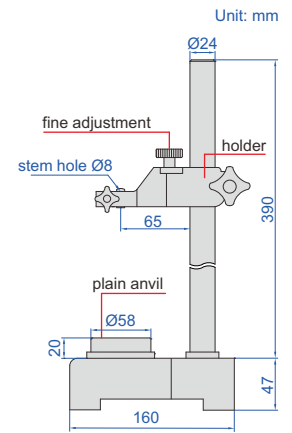

- Vertical travel of holder: 335mm
- Fine adjustment range: 2mm
- Supplied with dust cover

Code	Applicable holding stem	Anvil
6865-300	$\varnothing 8$ mm	steel (hardness HRC60 $\pm$ 2), plain, flatness 1.5 $\mu$ m
6865-300T	$\varnothing 8$ mm	ceramic, plain, flatness 1.5 $\mu$ m

## DIGITAL HEIGHT GAGES

REFER TO PAGE 85-87 FOR DETAILS



1155-505



1157-501



1158-100



Internal Caliper Gages  
Page 280-284



External Caliper Gages  
Page 284-285



Thickness Gages  
Page 286-292



Rubber Thickness Gages  
Page 292



Tube Thickness Gages  
Page 293-294



Saw Teeth Setting Gages  
Page 294



Snap Gages  
Page 294-297



Step And Gap Gages  
Page 298



Mini Digital Height Gages  
Page 298-299



Height Gages  
Page 299-300



Crankshaft Testers  
Page 300

## DIGITAL INTERNAL CALIPER GAGES

DATA  
OUTPUT



2121-15

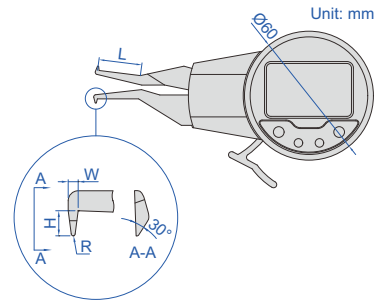

- Resolution: 0.005mm/0.0002"
- Reading in digit and analog
- Display can be rotated by 170°
- Button function: tolerance Go and No-Go display, data preset, max./min. measurement, data holding, inch/metric conversion, absolute/incremental measurement
- CR2032 battery, automatic power off
- Data output
- Optional accessory: data output cable (code 7315-30 need receiver page 4, 7302-30 page 12)

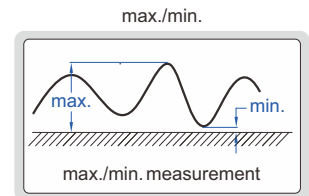
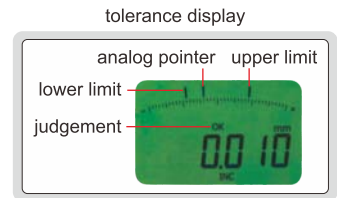
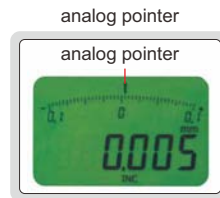

Code	Range	Accuracy	Repeatability	L	H	W	R
2121-15	5-15mm/0.2-0.6"	±0.03mm	0.01mm	20	2	1.5	R0.3
2121-25	5-25mm/0.2-1.0"	±0.03mm	0.01mm	35	1.5	1.0	R0.3
2121-31	10-30mm/0.4-1.2"	±0.03mm	0.01mm	55	5.5	2.5	R0.5
2121-41	20-40mm/0.8-1.6"	±0.03mm	0.01mm	80	6.0	3.0	R0.5
2121-51	30-50mm/1.2-2.0"	±0.03mm	0.01mm	80	8.0	3.0	R0.5
2121-61	40-60mm/1.6-2.4"	±0.03mm	0.01mm	80	8.0	3.0	R0.5

## INTERNAL DIAL CALIPER GAGES



2222-15

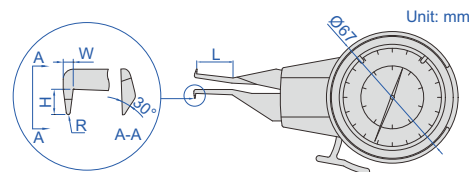

Code	Range	Graduation	Accuracy	L	H	W	R
2222-15	5-15mm	0.01mm	±0.03mm	20	2	1.5	R0.3
2222-25	5-25mm	0.01mm	±0.03mm	35	1.5	1.0	R0.3
2222-301	10-30mm	0.01mm	±0.03mm	55	5.5	2.5	R0.5
2222-401	20-40mm	0.01mm	±0.03mm	80	6.0	3.0	R0.5
2222-501	30-50mm	0.01mm	±0.03mm	80	8.0	3.0	R0.5
2222-60	40-60mm	0.01mm	±0.03mm	80	8.0	3.0	R0.5



**DATA OUTPUT**

**DIGITAL INTERNAL CALIPER GAGES**

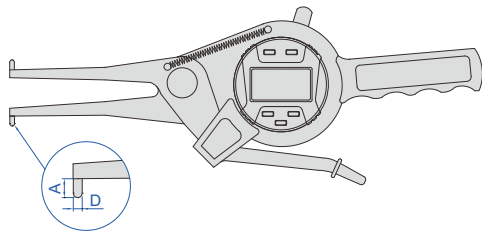

2151-35

- Carbide measuring tips
- Reading in digit and analog
- With transmission button and signal light
- Display can be rotated by 320°
- Button function: on/off, zero, tolerance Go and No-Go display, data preset, measuring direction change, max./min./TIR measurement, inch/metric conversion, data output, absolute/incremental measurement
- CR2032 battery, automatic power off (time is adjustable)
- Data output
- Optional accessory: data output cable (code 7315-50M need receiver page 5, 7302-50M page 13)

Code	Range	Resolution	Accuracy	L	A	D
2151-35	15-35mm/0.6-1.4"	0.01mm/0.0005"	±0.04mm	<50	3	Ø3
2151-AL35	15-35mm/0.6-1.4"	0.01mm/0.0005"	±0.04mm	<200	3	Ø3
2151-55	35-55mm/1.4-2.2"	0.01mm/0.0005"	±0.04mm	<80	6	Ø3
2151-AL55	35-55mm/1.4-2.2"	0.01mm/0.0005"	±0.04mm	<250	8	Ø3
2151-75	55-75mm/2.2-3"	0.01mm/0.0005"	±0.04mm	<90	8	Ø3
2151-AL75	55-75mm/2.2-3"	0.01mm/0.0005"	±0.04mm	<250	8	Ø3
2151-95	75-95mm/3-3.8"	0.01mm/0.0005"	±0.04mm	<100	8	Ø3
2151-115	95-115mm/3.8-4.6"	0.01mm/0.0005"	±0.04mm	<120	10	Ø3.2
2151-135	115-135mm/4.6-5.4"	0.01mm/0.0005"	±0.04mm	<120	10	Ø3.2

(mm)

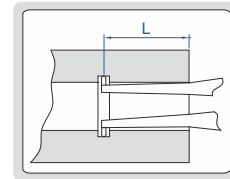

**INTERNAL DIAL CALIPER GAGES**

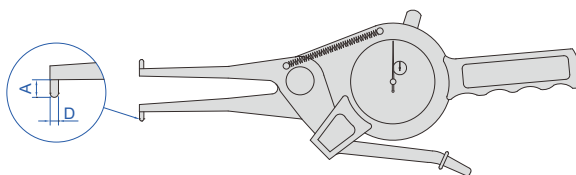

2321-35

- Carbide measuring tips

Code	Range	Graduation	Accuracy	L	A	D
2321-35	15-35mm	0.01mm	±0.04mm	<50	3	Ø3
2321-AL35	15-35mm	0.01mm	±0.04mm	<200	3	Ø3
2321-55	35-55mm	0.01mm	±0.04mm	<80	6	Ø3
2321-AL55	35-55mm	0.01mm	±0.04mm	<250	8	Ø3
2321-75	55-75mm	0.01mm	±0.04mm	<90	8	Ø3
2321-AL75	55-75mm	0.01mm	±0.04mm	<250	8	Ø3
2321-95	75-95mm	0.01mm	±0.04mm	<100	8	Ø3
2321-115	95-115mm	0.01mm	±0.04mm	<120	10	Ø3.2
2321-135	115-135mm	0.01mm	±0.04mm	<120	10	Ø3.2

(mm)

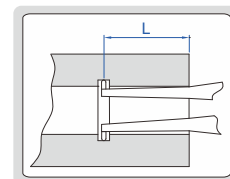

## LARGE RANGE INTERNAL DIAL CALIPER GAGES



2334-155

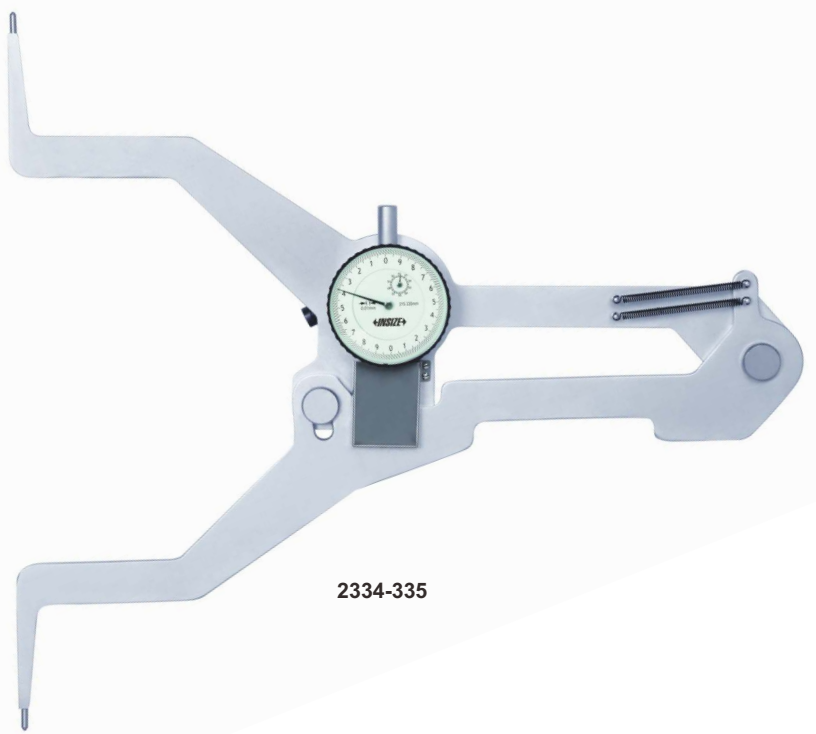
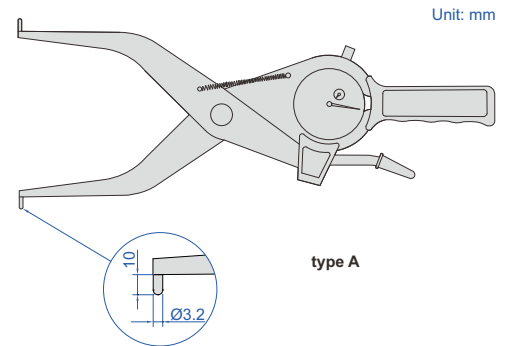

2334-335

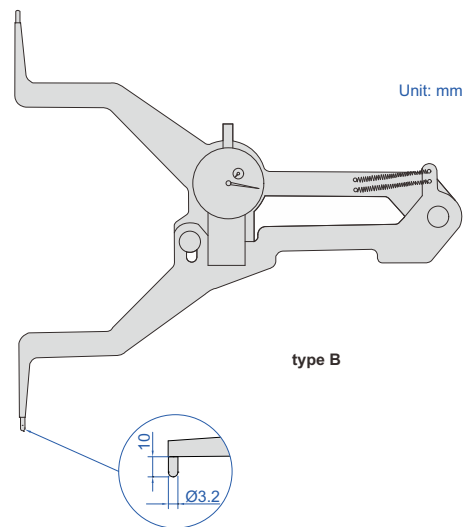

■ Carbide measuring tips

Code	Range	Graduation	Accuracy	Type	(mm) L
2334-155	135-155mm	0.01mm	±0.04mm	A	<200
2334-175	155-175mm	0.01mm	±0.04mm	A	<200
2334-195	175-195mm	0.01mm	±0.04mm	A	<200
2334-215	195-215mm	0.01mm	±0.04mm	A	<200
2334-235	215-235mm	0.01mm	±0.04mm	A	<200
2334-255	235-255mm	0.01mm	±0.04mm	A	<200
2334-275	255-275mm	0.01mm	±0.04mm	A	<200
2334-295	275-295mm	0.01mm	±0.04mm	A	<200
2334-315	295-315mm	0.01mm	±0.04mm	A	<200
2334-335	315-335mm	0.01mm	±0.04mm	B	<200
2334-355	335-355mm	0.01mm	±0.04mm	B	<200
2334-375	355-375mm	0.01mm	±0.04mm	B	<200

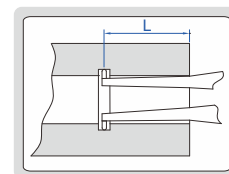

## INTERNAL DIAL CALIPER GAGES WITH INTERCHANGEABLE POINTS



2223-153

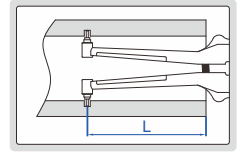
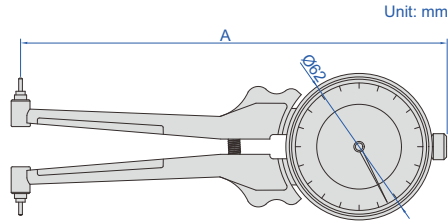

Code	Range	Dial indicator range	Graduation	Accuracy	A	L	Remark
2223-35	20-35mm	2mm	0.01mm	±0.02mm	164mm	<70mm	supplied with 7 pairs of points
2223-62	30-62mm	2mm	0.01mm	±0.02mm	170mm	<75mm	supplied with 5 pairs of points
2223-153	55-153mm	2mm	0.01mm	±0.02mm	179mm	<90mm	supplied with 6 pairs of points

2223-35 points (included)

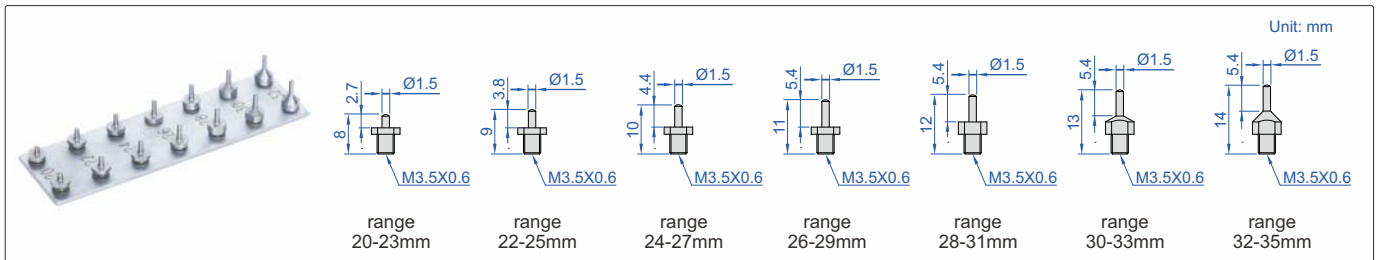

2223-62 points (included)

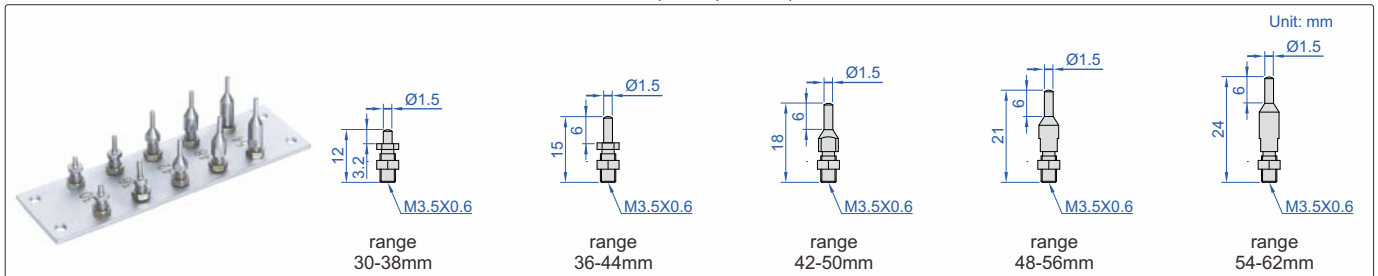

2223-153 points (included)

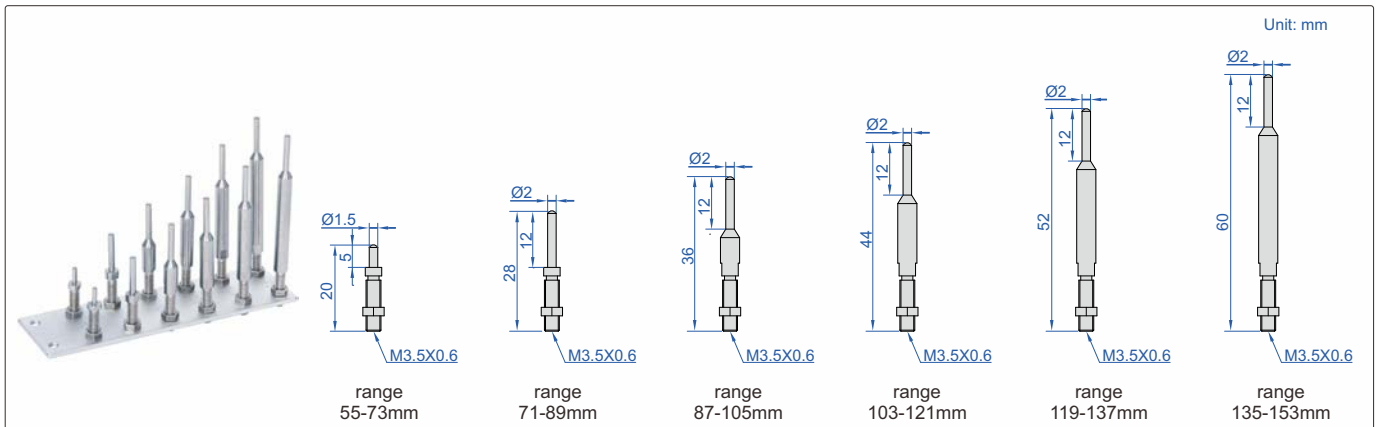

## DIGITAL INTERNAL CALIPER GAGES (ECONOMIC TYPE)



2711-165

Unit: mm

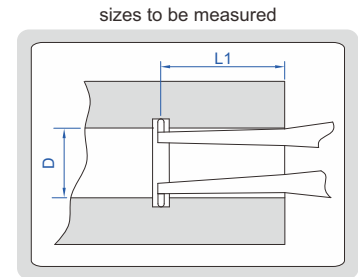
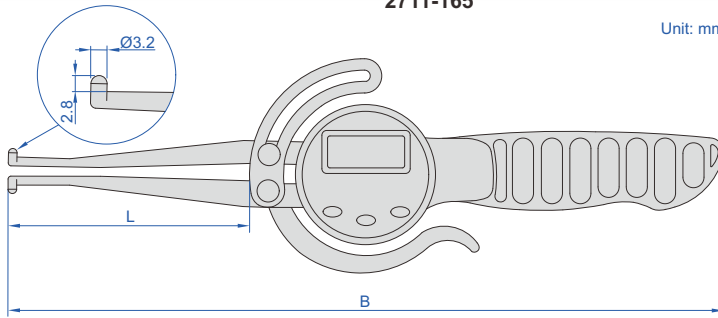

(mm)		(mm)	
Code 2711-165	Code 2711-216	D	L1
Ø13	<42	Ø13	<50
Ø15	<45	Ø15	<55
Ø17	<50	Ø17	<60
Ø20	<60	Ø20	<65
Ø25	<75	Ø25	<75
Ø27	<80	Ø30	<95
Ø29~165	<85	Ø35~216	<160

- Button function: on/off, zero, mm/inch, data hold
- Battery CR2032, automatic power off

Code	Range	Resolution	Accuracy	Repeatability	L	B
2711-165	12.7-165mm/0.5-6.5"	0.1mm/0.01"	±0.3mm	0.2mm	85	252
2711-216	12.7-216mm/0.5-8.5"	0.1mm/0.01"	±0.3mm	0.2mm	160	327

## DIGITAL EXTERNAL CALIPER GAGES

DATA OUTPUT

- Resolution: 0.005mm/0.0002"
- Reading in digit and analog
- Display can be rotated by 170°
- Button function: tolerance Go and No-Go display, data preset, max./min. measurement, data holding, inch/metric conversion, absolute/incremental measurement
- CR2032 battery, automatic power off
- Data output
- Optional accessory: data output cable (code 7315-30 need receiver page 4, 7302-30 page 12)



2131-21

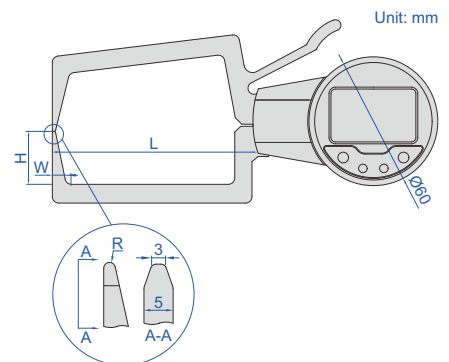
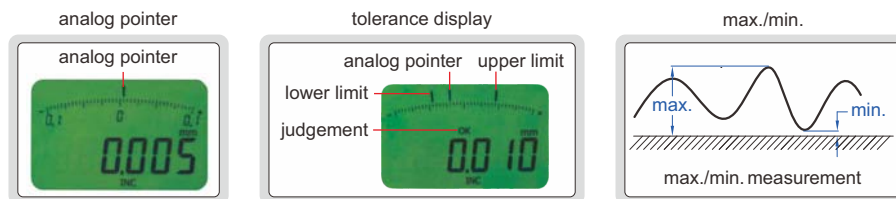

Code	Range	Accuracy	Repeatability	L	H	W	R
2131-21	0-20mm/0-0.8"	±0.03mm	0.01mm	80mm	25mm	6.5mm	R0.5mm
2131-31	10-30mm/0.4-1.2"	±0.03mm	0.01mm	80mm	25mm	6.5mm	R0.5mm
2131-41	20-40mm/0.8-1.6"	±0.03mm	0.01mm	80mm	25mm	6.5mm	R0.5mm
2131-51	30-50mm/1.2-2.0"	±0.03mm	0.01mm	80mm	25mm	6.5mm	R0.5mm
2131-61	40-60mm/1.6-2.4"	±0.03mm	0.01mm	80mm	25mm	6.5mm	R0.5mm

## EXTERNAL DIAL CALIPER GAGES

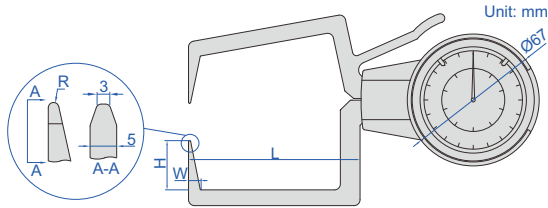

Code	Range	Graduation	Accuracy	L	H	W	R
2333-201	0-20mm	0.01mm	±0.03mm	80	25	6.5	R0.5
2333-301	10-30mm	0.01mm	±0.03mm	80	25	6.5	R0.5
2333-401	20-40mm	0.01mm	±0.03mm	80	25	6.5	R0.5
2333-501	30-50mm	0.01mm	±0.03mm	80	25	6.5	R0.5
2333-601	40-60mm	0.01mm	±0.03mm	80	25	6.5	R0.5

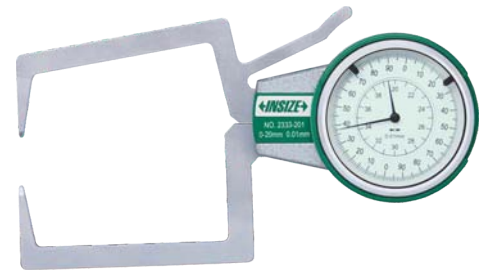

2333-201

## DIGITAL EXTERNAL CALIPER GAGES

DATA OUTPUT

- Carbide measuring tips
- Reading in digit and analog
- With transmission button and signal light
- Display can be rotated by 320°
- Button function: on/off, zero, tolerance Go and No-Go display, data preset, measuring direction change, max./min./TIR measurement, inch/metric conversion, absolute/incremental measurement, data output
- CR2032 battery
- Automatic power off (time is adjustable)
- Data output
- Optional accessory: data output cable (code 7315-50M need receiver page 5, 7302-50M page 13)

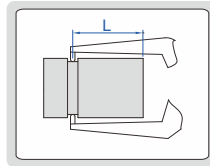

2132-20

Unit: mm

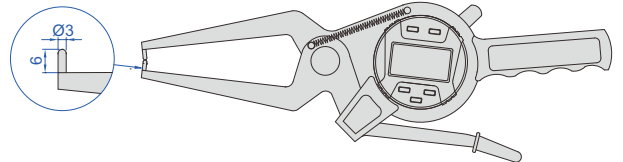

Code	Range	Resolution	Accuracy	L
2132-20	0-20mm/0-0.8"	0.01mm/0.0005"	±0.04mm	<60mm
2132-40	20-40mm/0.8-1.6"	0.01mm/0.0005"	±0.04mm	<60mm
2132-60	40-60mm/1.6-2.4"	0.01mm/0.0005"	±0.04mm	<55mm
2132-80	60-80mm/2.4-3.2"	0.01mm/0.0005"	±0.04mm	<55mm
2132-100	80-100mm/3.2-4"	0.01mm/0.0005"	±0.04mm	<55mm

12

## EXTERNAL DIAL CALIPER GAGES

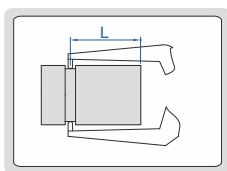

- Carbide measuring tips



2332-20

(mm)

Code	Range	Graduation	Accuracy	L
2332-20	0-20mm	0.01mm	±0.04mm	<60
2332-40	20-40mm	0.01mm	±0.04mm	<60
2332-60	40-60mm	0.01mm	±0.04mm	<55
2332-80	60-80mm	0.01mm	±0.04mm	<55
2332-100	80-100mm	0.01mm	±0.04mm	<55

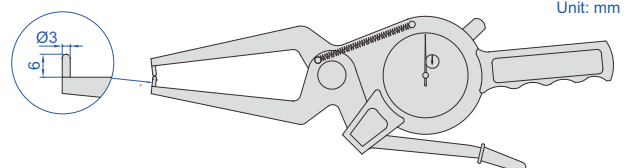

Unit: mm

## DIGITAL THICKNESS GAGES

POPULAR MODEL

DATA OUTPUT

- Ceramic spindle tip and anvil
- Button function: on/off, inch/mm, zero, data preset, change measuring direction, absolute/incremental measurement
- Keep preset data in memory after restart
- CR2032 battery, automatic power off (time is adjustable)
- Data output
- Optional accessory: data output cable (code 7315-50M need receiver page 5, 7302-50M page 13)

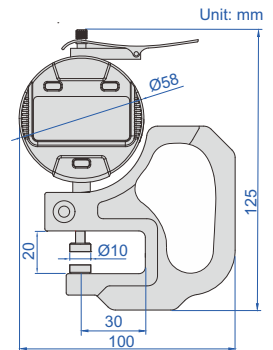

2871-101

Code	Range	Resolution	Accuracy
2871-10	0-10mm/0-0.4"	0.01mm/0.0005"	±0.02mm
2871-101	0-10mm/0-0.4"	0.001mm/0.00005"	±0.005mm

## THICKNESS GAGES

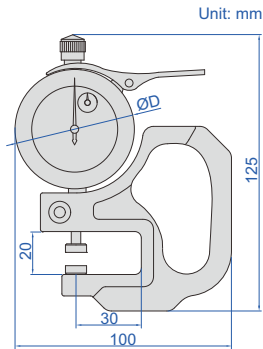
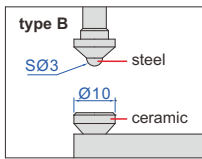
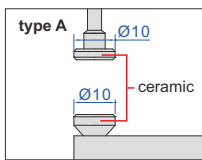

2364-10

2364-1

Code	Range	Graduation	Accuracy	Type	ØD
2364-10	0-10mm	0.01mm	±0.02mm	A	58mm
2364-10B	0-10mm	0.01mm	±0.02mm	B	58mm
2364-1	0-1mm	0.001mm	±0.005mm	A	56mm

12

## THICKNESS GAGES

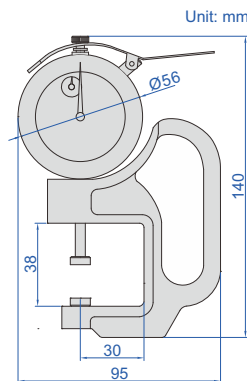
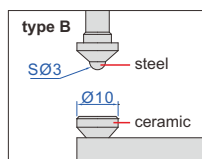
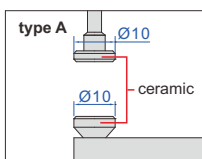

2366-30

Code	Range	Graduation	Accuracy	Type
2366-30	0-30mm	0.01mm	±0.035mm	A
2366-30B	0-30mm	0.01mm	±0.035mm	B

**DATA OUTPUT**

measuring tips and anvils can be custom-made

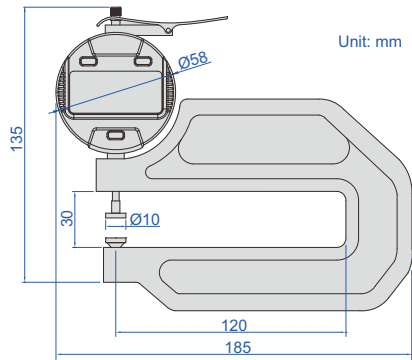

- Ceramic spindle tip and anvil
- Buttons: on/off, inch/mm, zero, data preset, change measuring direction, absolute/incremental measurement
- Keep preset data in memory after restart
- Battery CR2032, automatic power off (time is adjustable)
- Data output
- Optional accessory: data output cable (code 7315-50M need receiver page 5, 7302-50M page 13)

**DIGITAL THICKNESS GAGES**



2872-10

Code	Range	Resolution	Accuracy
2872-10	0-10mm/0-0.4"	0.01mm/0.0005"	±0.02mm
2872-101	0-10mm/0-0.4"	0.001mm/0.00005"	±0.01mm

**THICKNESS GAGES**

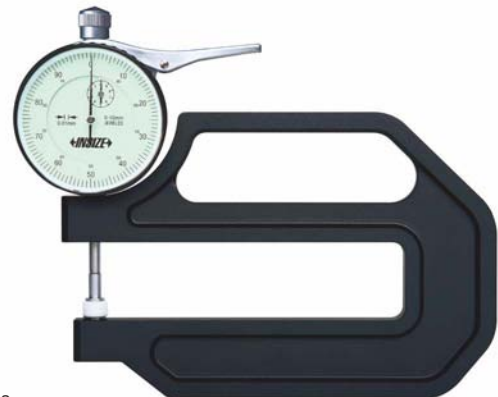
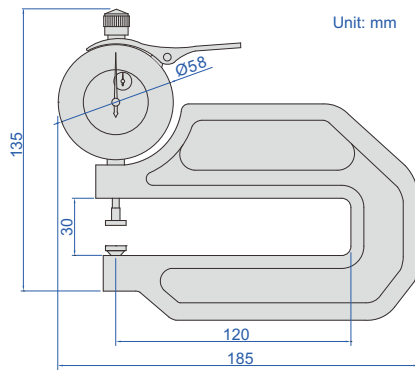
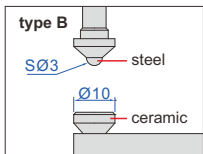
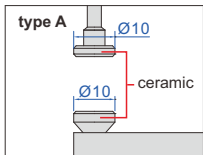

2365-10

measuring tips and anvils can be custom-made



Code	Range	Graduation	Accuracy	Type
2365-10	0-10mm	0.01mm	±0.02mm	A
2365-20	0-20mm	0.01mm	±0.03mm	A
2365-10B	0-10mm	0.01mm	±0.02mm	B
2365-20B	0-20mm	0.01mm	±0.03mm	B

**SUITABLE FOR JEWELLERY**

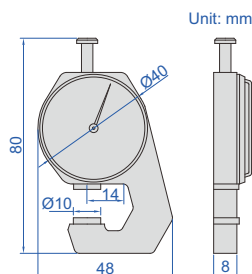
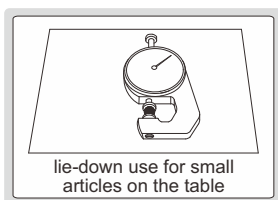

2361-10

**THICKNESS GAGE**

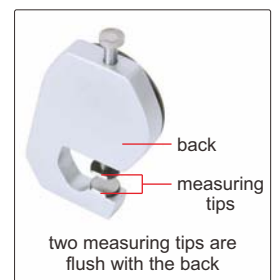

Code	Range	Graduation	Accuracy
2361-10	0-10mm	0.1mm	±0.05mm

## THICKNESS GAGE

- Stainless steel spindle tip and anvil

Code	Range	Graduation	Accuracy
2363-10	0-10mm	0.01mm	±0.03mm



2363-10

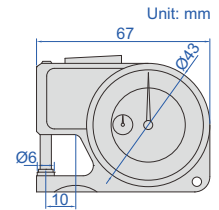

## DIGITAL ROLLER THICKNESS GAGES

DATA OUTPUT



2877-4



2877-10

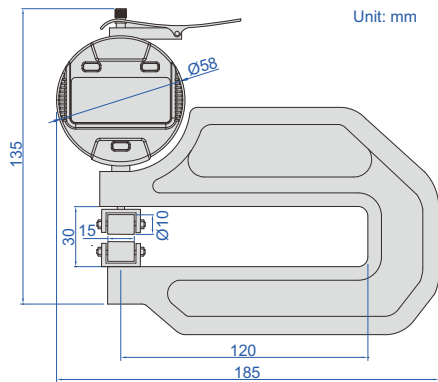

2877-4/2877-41

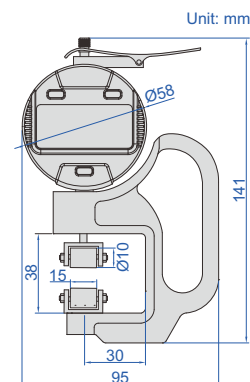

2877-10/2877-101

- Buttons: on/off, inch/mm, zero, data preset, change measuring direction, absolute/incremental measurement
- Keep preset data in memory after restart
- Battery CR2032, automatic power off (time is adjustable)
- Data output
- Optional accessory: data output cable (code 7315-50M need receiver page 5, 7302-50M page 13)

Code	Range	Resolution	Accuracy
2877-4	0-4.5mm/0-0.18"	0.01mm/0.0005"	±0.02mm
2877-41	0-4.5mm/0-0.18"	0.001mm/0.00005"	±0.01mm
2877-10	0-10mm/0-0.4"	0.01mm/0.0005"	±0.02mm
2877-101	0-10mm/0-0.4"	0.001mm/0.00005"	±0.01mm



## THICKNESS GAGES

**INSIZE PLUS**  
MADE IN EUROPE

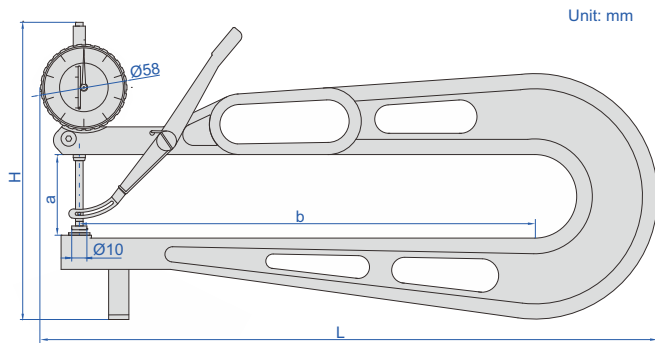

Unit: mm

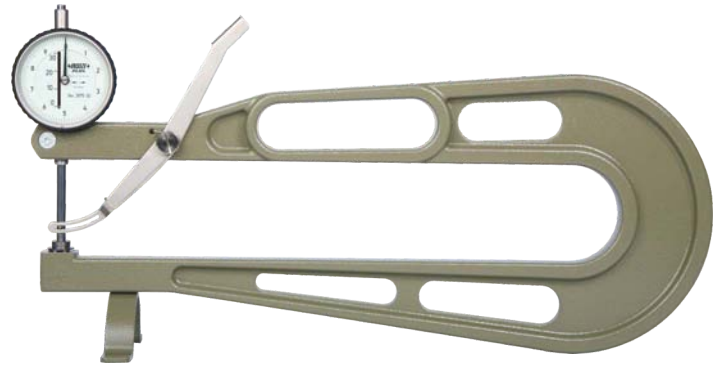

2875-30

Code	Range	Graduation	Accuracy	L	H	a	b
2875-30	0-30mm	0.1mm	±0.05mm	400mm	195mm	55mm	300mm
2875-50	0-50mm	0.1mm	±0.05mm	700mm	295mm	75mm	600mm

**INSPECTION  
CERTIFICATE**

DATA  
OUTPUT

## DIGITAL THICKNESS GAGE

**INSIZE PLUS**  
MADE IN EUROPE

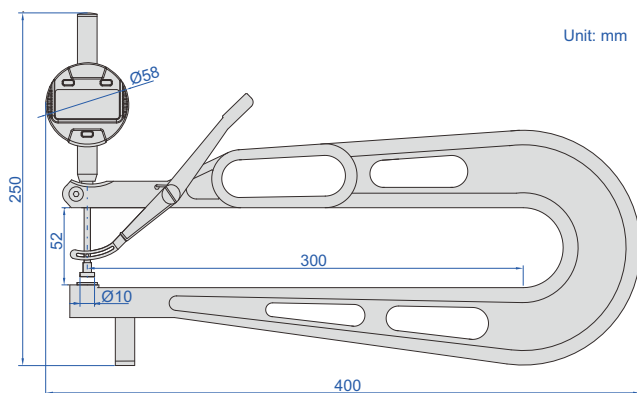

Unit: mm



2860-25

- Buttons: on/off, inch/mm, zero, data preset, change measuring direction, absolute/incremental measurement
- Keep preset data in memory after restart
- Battery CR2032, automatic power off (time is adjustable)
- Data output
- Optional accessory: data output cable (code 7315-50M need receiver page 5, 7302-40M page 13)

Code	Range	Resolution	Accuracy
2860-25*	0-25.4mm/0-1"	0.01mm/0.0005"	±0.05mm

\* Supplied with manufacturer inspection certificate

## HIGH PRECISION DIGITAL THICKNESS GAGES

ATTENTION: RECHARGEABLE BATTERY, FOR 12 HOURS CONTINUOUS WORKING

DATA OUTPUT

MEASURING TIPS AND ANVILS CAN BE CUSTOM-MADE

ABSOLUTE ENCODER, THE ORIGINAL DATA REMAINS AFTER POWER OFF



2879-10



2879-30



2879-60

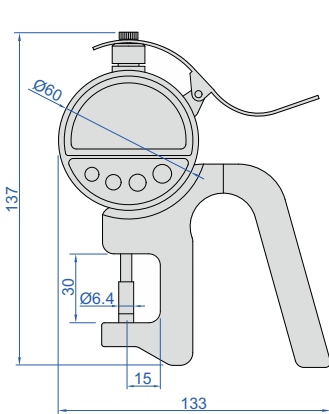

2879-10  
2879-101

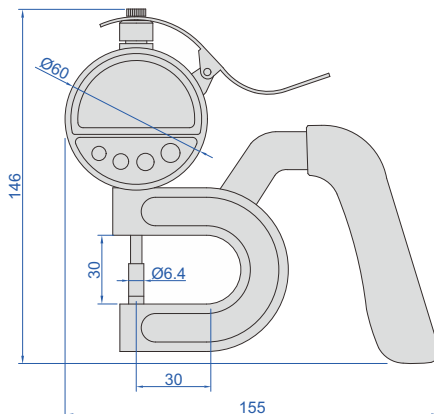

2879-30

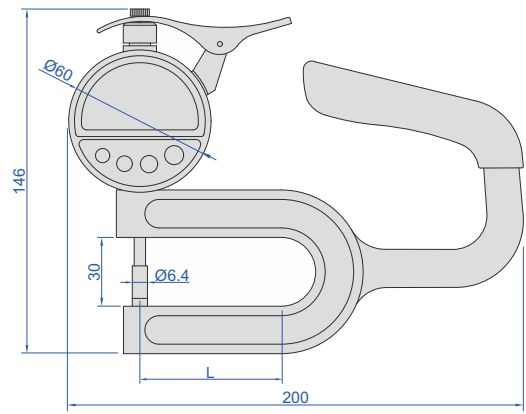

2879-60  
2879-100

Unit: mm

- Absolute encoder, the original data remains after power off
- Button function: on/off, zero, tolerance, absolute/incremental measurement, max./min./TIR, data preset, mm/inch, data output, data hold
- Reading in digital and analog
- Power: rechargeable battery, for 12 hours continuous working
- Data output
- Supplied with data output cable (keyboard format)

Code	Range	Resolution	Accuracy	Repeatability	Measuring force	L
2879-10	0-10mm/0-0.4"	0.001mm/0.00005"	±0.002mm	0.001mm	0.5-1N	—
2879-101	0-10mm/0-0.4"	0.0005mm/0.00002"	±0.0015mm	0.0005mm	0.5-1N	—
2879-30	0-10mm/0-0.4"	0.001mm/0.00005"	±0.002mm	0.001mm	0.5-1N	—
2879-60	0-10mm/0-0.4"	0.001mm/0.00005"	±0.003mm	0.001mm	0.5-1N	60mm
2879-100	0-10mm/0-0.4"	0.001mm/0.00005"	±0.004mm	0.001mm	0.5-1N	100mm

## THICKNESS GAGES

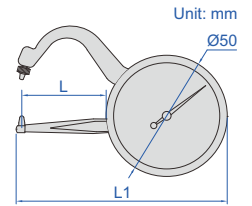
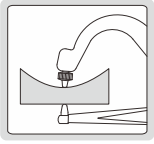

2862-101

Code	Range	Graduation	Accuracy	L	L1
2862-101	0-10mm	0.05mm	±0.1mm	35mm	85mm
2862-102	0-10mm	0.05mm	±0.1mm	60mm	110mm

## THICKNESS GAGE

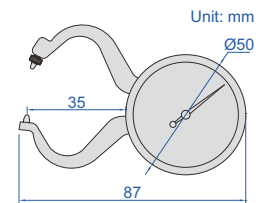
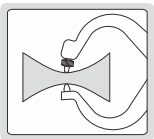

2863-10

Code	Range	Graduation	Accuracy
2863-10	0-10mm	0.05mm	±0.1mm

## THICKNESS GAGE WITH POINTED TIPS

- Pointed tips fit into small grooves and recesses

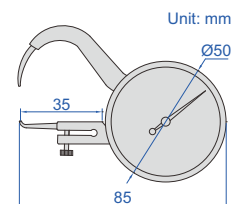
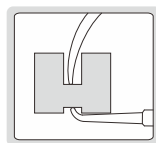

2866-10

Code	Range	Graduation	Accuracy
2866-10	0-10mm	0.05mm	±0.1mm

## THICKNESS GAGE

- Main body is made of hard plastic



2870-10

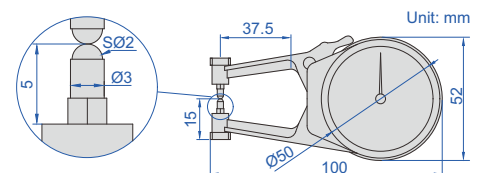

Code	Range	Graduation	Accuracy
2870-10	0-10mm	0.1mm	±0.1mm

## DIGITAL THICKNESS GAGE

- Resolution: 0.01mm, 0.001", 1/64"
- Buttons: on/off, zero, unit (mm/in/fraction), data hold
- Battery CR2032, automatic power off

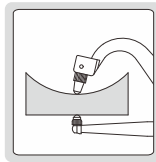

2710-25

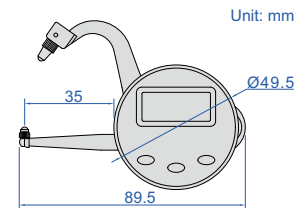

Code	Range	Accuracy	Repeatability
2710-25	0-25.4mm/0-1"	0.05mm	0.02mm

## DIGITAL RUBBER THICKNESS GAGES

DATA OUTPUT

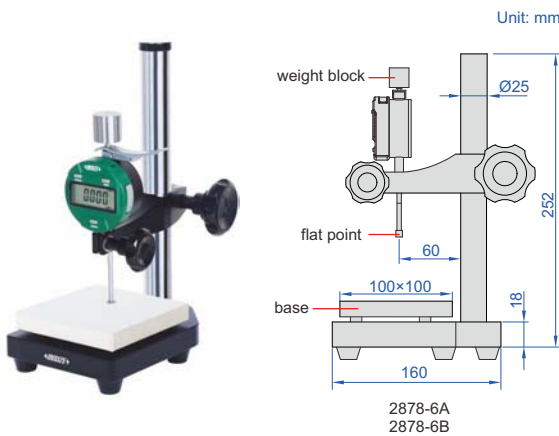

2878-6B

2878-6A  
2878-6B

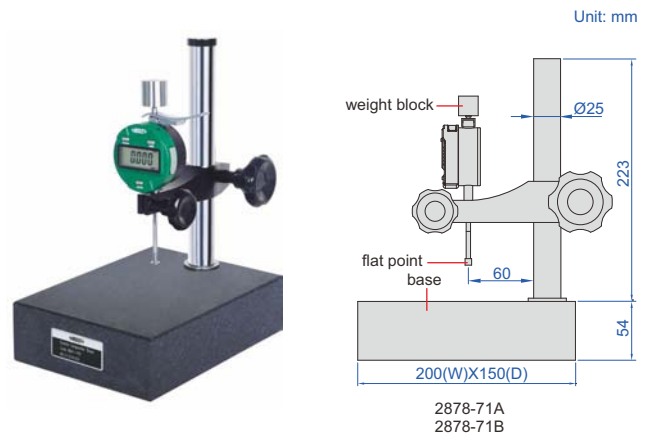

2878-71B

2878-71A  
2878-71B

- Measure thickness of vulcanized rubber and plastic products
- Button function: on/off, inch/mm, zero, data preset, change measuring direction, absolute/incremental measurement
- CR2032 battery, automatic power off (time is adjustable)
- Supplied with dust cover
- Optional accessory: data output cable (code 7315-50M need receiver page 5, 7302-50M page 13), flat points, weight blocks

Code	Range	Resolution	Accuracy	Flat point diameter	Pressure	Base
2878-6A	12.7mm/0.5"	0.01mm/0.0005"	20µm	6mm	22kPa±5kPa	ceramic, plain, flatness 1.5µm
2878-6B	12.7mm/0.5"	0.001mm/0.00005"	5µm	6mm	22kPa±5kPa	ceramic, plain, flatness 1.5µm
2878-71A	12.7mm/0.5"	0.01mm/0.0005"	20µm	6mm	22kPa±5kPa	granite, plain, flatness 2.5µm
2878-71B	12.7mm/0.5"	0.001mm/0.00005"	5µm	6mm	22kPa±5kPa	granite, plain, flatness 2.5µm

### Flat points and weight blocks (optional)

Flat point	Flat point code	Pressure				
		10kPa±2kPa weight block code	22kPa±5kPa weight block code	20kPa±3kPa weight block code	70kPa±5kPa weight block code	1.6kPa±0.1kPa weight block code
Ø4mm	2878-P4	—	2878-W4B	—	—	—
Ø5mm	2878-P5	2878-W5A	2878-W5B	2878-W5C	2878-W5D	—
Ø6mm	2878-P6	2878-W6A	2878-W6B	—	—	—
Ø8mm	2878-P8	2878-W8A	2878-W8B	—	—	—
Ø10mm	2878-P10	2878-W10A	2878-W10B	2878-W10C	—	—
Ø25mm	2878-P25	—	—	—	—	2878-W25E
1x4mm (rectangle)	2878-P14	—	—	—	2878-W14D	—

**DATA OUTPUT**

measure wall thickness of grooves

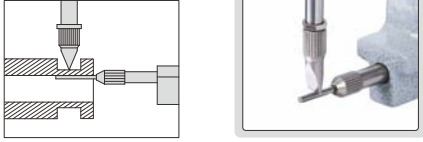

- Buttons: on/off, inch/mm, zero, data preset, change measuring direction, absolute/incremental measurement
- Keep preset data in memory after restart
- Battery CR2032, automatic power off (time is adjustable)
- Data output
- Optional accessory: data output cable (code 7315-50M need receiver page 5, 7302-50M page 13)

Code	Range	Resolution	Accuracy
2873-10	0-10mm/0-0.4"	0.01mm/0.0005"	±0.02mm
2873-101	0-10mm/0-0.4"	0.001mm/0.00005"	±0.005mm

## DIGITAL TUBE THICKNESS GAGES



2873-10

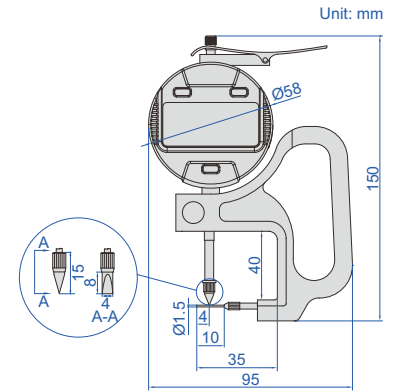

**DATA OUTPUT**

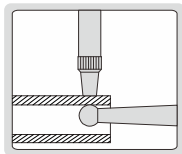

- Buttons: on/off, inch/mm, zero, data preset, change measuring direction, absolute/incremental measurement
- Keep preset data in memory after restart
- Battery CR2032, automatic power off (time is adjustable)
- Data output
- Optional accessory: data output cable (code 7315-50M need receiver page 5, 7302-50M page 13)

Code	Range	Resolution	Accuracy
2876-10	0-10mm/0-0.4"	0.01mm/0.0005"	±0.02mm
2876-101	0-10mm/0-0.4"	0.001mm/0.00005"	±0.005mm

## DIGITAL TUBE THICKNESS GAGES



2876-10

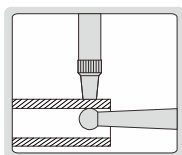
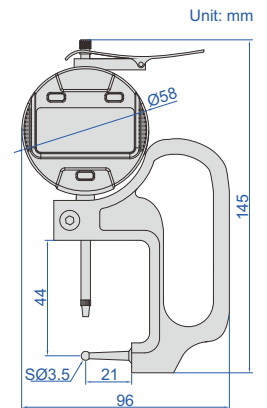

- Measure tube wall thickness

Code	Range	Graduation	Accuracy
2367-10A	0-10mm	0.01mm	±0.02mm

## TUBE THICKNESS GAGE



2367-10A

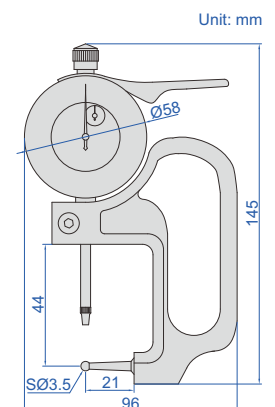

## DIGITAL TUBE THICKNESS GAGES

DATA  
OUTPUT

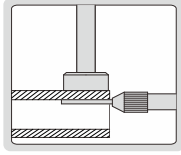

- Buttons: on/off, inch/mm, zero, data preset, change measuring direction, absolute/incremental measurement
- Keep preset data in memory after restart
- Battery CR2032, automatic power off (time is adjustable)
- Data output
- Optional accessory: data output cable (code **7315-50M** need receiver page 5, **7302-50M** page 13)

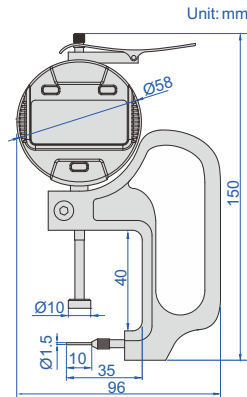

2859-101

Code	Range	Resolution	Accuracy
2859-10	0-10mm/0-0.4"	0.01mm/0.0005"	±0.02mm
2859-101	0-10mm/0-0.4"	0.001mm/0.00005"	±0.005mm

## SAW TEETH SETTING GAGE

**INSIZE PLUS**  
MADE IN EUROPE



front



back

2874-02

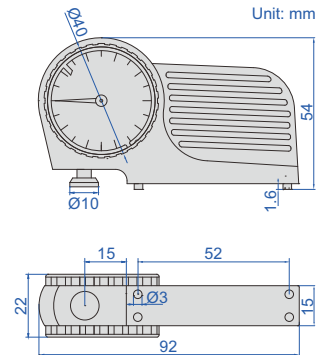

- Supplied with limit pointer
- Read from both sides

Code	Range	Graduation	Accuracy
2874-02	0-2mm	0.05mm	±0.05mm

12

## DIAL SNAP GAGES

**INSIZE PLUS**  
MADE IN EUROPE

IP54  
WATERPROOF

- Quick Go/No-Go measurement for mass production
- Anvil retracting stroke: 2.5mm
- Dial indicator: measuring range ±0.07mm, graduation 1µm, accuracy ±1µm
- Constant measuring force over the whole range: 8.5N
- Carbide measuring faces
- IP54 dust/waterproof
- Zero position of dial indicator is adjustable and can be locked (supplied with locking wrench)
- Adjustable platform height

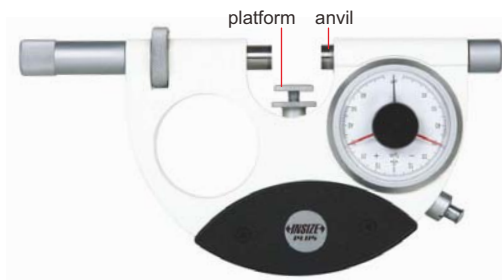

3335-25

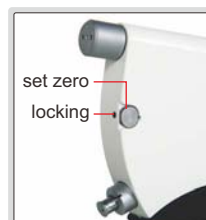

set zero  
locking

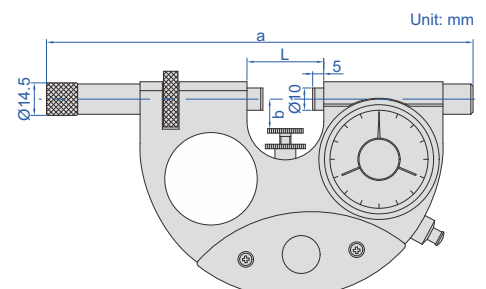

Code	Range	L	a	b
3335-25	0-25mm	35mm	191mm	<15mm
3335-50	25-50mm	60mm	215mm	<25mm
3335-75	50-75mm	84mm	239mm	<37.5mm
3335-100	75-100mm	110mm	265mm	<50mm

ATTENTION: SETTING STANDARDS ARE NOT INCLUDED

IP54 WATERPROOF

### DIAL SNAP GAGES

- Quick measurement for mass production
- Dial indicator: range  $\pm 0.04\text{mm}$ , graduation  $0.001\text{mm}$ , accuracy  $0.001\text{mm}$
- IP54 dust/waterproof
- Measuring force: 5-10N
- Carbide measuring faces
- Optional accessory: gage blocks grade 0 (4101-A series), for zero setting



3334-25

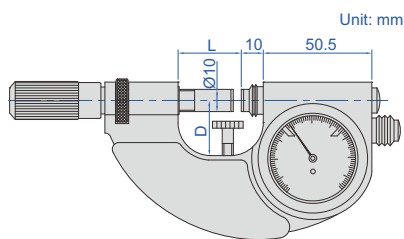

Code	Range	L	D
3334-25	0-25mm	28.5mm	25mm
3334-50	25-50mm	53.5mm	35mm
3334-75	50-75mm	78.5mm	47.5mm
3334-100	75-100mm	103.5mm	60mm

QUICK AND ACCURATE MEASUREMENT OF CYLINDRICAL WORKPIECES

INSPECTION CERTIFICATE

### DIAL SNAP GAGES



- Left anvil retracting stroke: 2mm
- Measuring force: 6-8N
- Flatness of anvil:  $1.5\mu\text{m}$
- Repeatability:  $1\mu\text{m}$
- Carbide measuring faces for anvils
- Front edges of anvils are chamfered for easy workpiece insertion
- Optional accessory: dial indicators and digital indicators (reading  $0.001\text{mm}$  or  $0.01\text{mm}$ )



digital indicator is optional

application



2186-25

Code	Range	Parallelism of measuring faces	(mm)		
			A	B	C
2186-25 *	0-25mm	$4\mu\text{m}$	42	11-18	20
2186-50 *	25-50mm	$4\mu\text{m}$	69	11-32	41
2186-75 *	50-75mm	$5\mu\text{m}$	94	17-41	51
2186-100 *	75-100mm	$6\mu\text{m}$	119	31-55	65
2186-125 *	100-125mm	$6\mu\text{m}$	144	42-70	75
2186-150 *	125-150mm	$8\mu\text{m}$	169	55-82	90
2186-175 *	150-175mm	$8\mu\text{m}$	194	68-95	100
2186-200 *	175-200mm	$10\mu\text{m}$	219	85-110	115
2186-225 *	200-225mm	$10\mu\text{m}$	244	95-120	130
2186-250 *	225-250mm	$10\mu\text{m}$	269	110-135	145
2186-275 *	250-275mm	$12\mu\text{m}$	294	120-150	160
2186-300 *	275-300mm	$12\mu\text{m}$	319	128-160	170

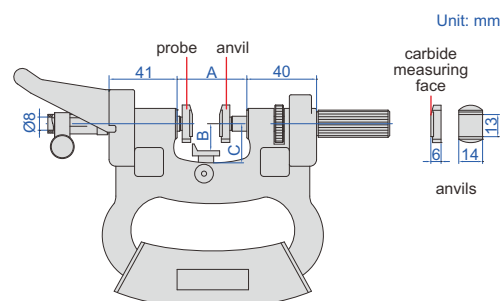

\* Supplied with manufacturer inspection certificate

## DIAL SNAP GAGES

ATTENTION: NOT SUITABLE FOR 0.001MM DIAL INDICATORS

- Quick measurement for mass production
- Anvil retracting stroke: 3mm
- Measuring force: 6-9N
- Carbide measuring faces
- Optional accessory:  
dial indicators (graduation 0.01mm),  
digital indicators (resolution 0.01mm/0.0005")



2184-50W

Code	Range	A	B
2184-25W	0-25mm	34mm	18mm
2184-50W	0-50mm	62mm	32mm
2184-100W	50-100mm	112mm	62mm
2184-150W	100-150mm	162mm	85mm
2184-200W	150-200mm	212mm	110mm

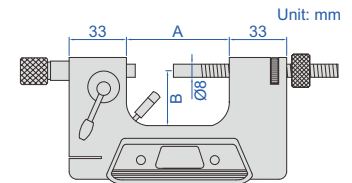

## DIGITAL SNAP GAGE

ATTENTION: NO DATA OUTPUT



2166-12

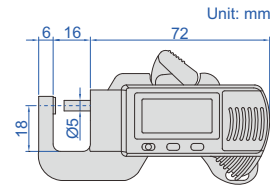

12

Code	Range	Resolution	Accuracy
2166-12	0-12mm/0-0.5"	0.01mm/0.0005"	±0.03mm

## DIGITAL SNAP GAGE

ATTENTION: NO DATA OUTPUT



2167-25

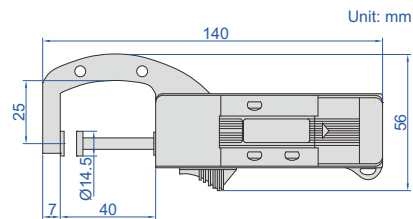

Code	Range	Resolution	Accuracy
2167-25	0-25mm/0-1"	0.01mm/0.0005"	±0.03mm



ATTENTION: NO DATA OUTPUT

## DIGITAL SNAP GAGE



2163-25

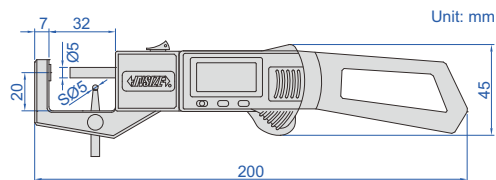

- Resolution: 0.01mm/0.0005"
- Accuracy:  $\pm 0.04$ mm
- For thickness and tube wall thickness measurement

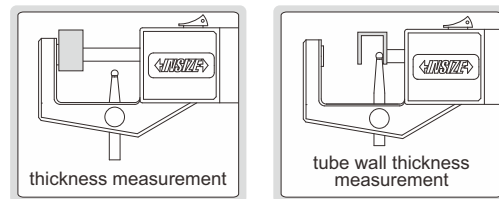

Code	Thickness range	Tube wall thickness range
2163-25	0-25mm/0-1"	0-2mm/0.08"

DATA OUTPUT

## DIGITAL SNAP GAGES



1163-50A

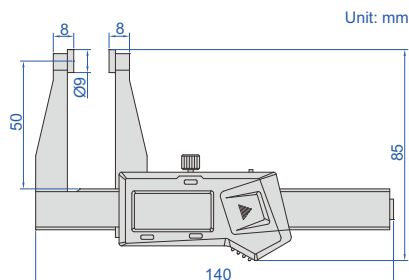

With data interface (data output cable code 7315-21 need receiver page 4, 7302-21 page 12, optional)

Code	Range	Resolution	Accuracy
1163-50A	0-50mm/0-2"	0.01mm/0.0005"	$\pm 0.03$ mm

Built-in wireless (receiver code 7315-2/3/6/7/8/9 is required)

Code	Range	Resolution	Accuracy
1163-50AWL	0-50mm/0-2"	0.01mm/0.0005"	$\pm 0.03$ mm

- Non waterproof
- Buttons: on/off, zero, mm/inch
- Automatic power off, move the digital unit to turn on power
- Battery CR2032
- Made of stainless steel

12

ATTENTION: NO DATA OUTPUT

SUITABLE FOR JEWELLERY

## DIGITAL 3-PURPOSE SNAP GAGE



2164-25A

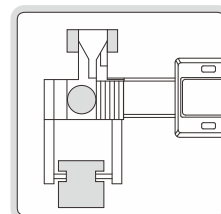
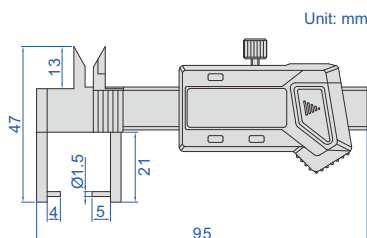

Code	Range	Resolution	Accuracy
2164-25A	0-25mm/0-1"	0.01mm/0.0005"	$\pm 0.03$ mm

- Non waterproof
- Buttons: zero, mm/inch, on/off
- Battery LR44
- Made of stainless steel

## STEP AND GAP GAGES

DATA  
OUTPUT

- Non waterproof
- Measure step height and gap width
- Resolution: 0.01mm/0.0005"
- Buttons: on/off, set, mm/inch, preset (+, -)
- Automatic power off, move the digital unit to turn on power
- Battery CR2032
- Made of stainless steel
- Supplied with zero setting block



With data interface (data output cable code 7315-21 need receiver page 4, 7302-21 page 12, optional)

Code	Range	Accuracy
2168-12	0-12.7mm/0-0.5"	±0.03mm

Built-in wireless (receiver code 7315-2/3/6/7/8/9 is required)

Code	Range	Accuracy
2168-12WL	0-12.7mm/0-0.5"	±0.03mm

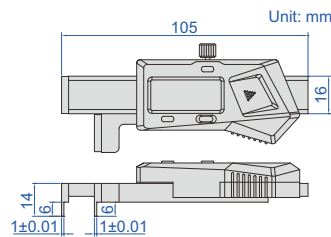

zero setting block (included)

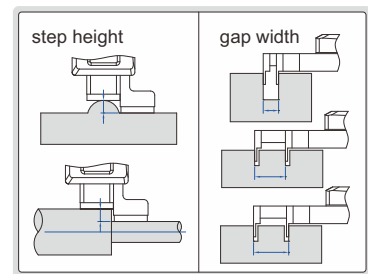

## MINI VERNIER HEIGHT GAGE

12

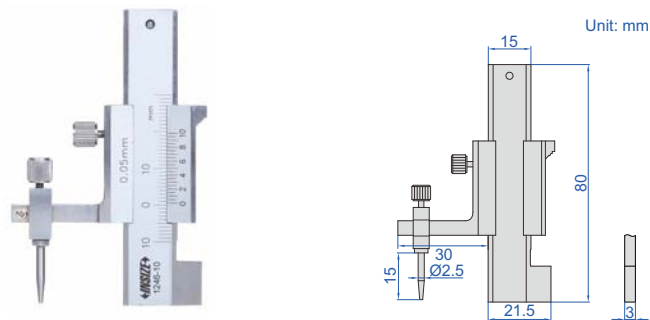

1246-10

- Measure height difference of two surfaces
- Graduation: 0.05mm
- Made of stainless steel
- Satin chrome plated reading surface

Code	Range	Accuracy
1246-10	0~±10mm	±0.05mm

application

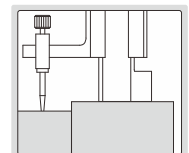

DATA  
OUTPUT

## MINI DIGITAL HEIGHT GAGES

application of  
1146-20A/1146-20AWL

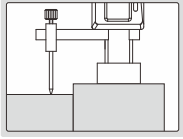

application of  
1146-20B/1146-20BWL

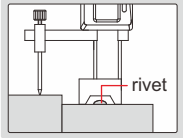

- Non waterproof
- Measure height difference of two surfaces (1146-20B, 1146-20BWL suitable for surfaces with barrier, such as rivet)
- Resolution: 0.01mm/0.0005"
- Buttons: on/off, zero, mm/inch
- Automatic power off, move the digital unit to turn on power
- Battery CR2032
- Made of stainless steel

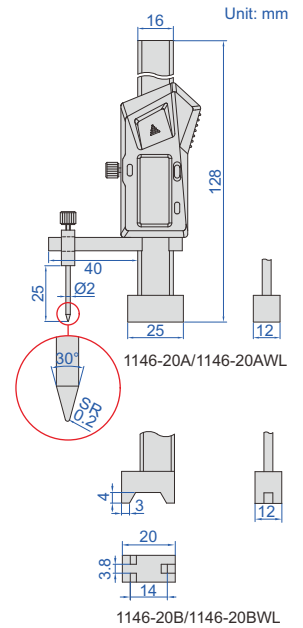
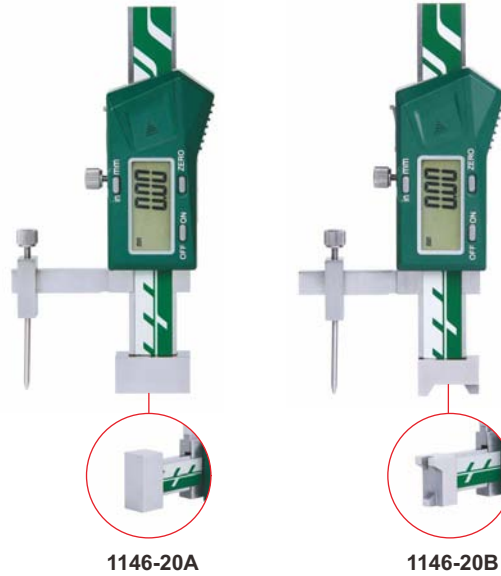

With data interface  
(data output cable code 7315-21 need receiver page 4,  
7302-21 page 12, optional)

Code	Range	Accuracy
1146-20A	0~±20mm/0~±0.8"	±0.02mm
1146-20B	0~±20mm/0~±0.8"	±0.02mm

Built-in wireless  
(receiver code 7315-2/3/6/7/8/9 is required)

Code	Range	Accuracy
1146-20AWL	0~±20mm/0~±0.8"	±0.02mm
1146-20BWL	0~±20mm/0~±0.8"	±0.02mm

## DIAL HEIGHT GAGES

12

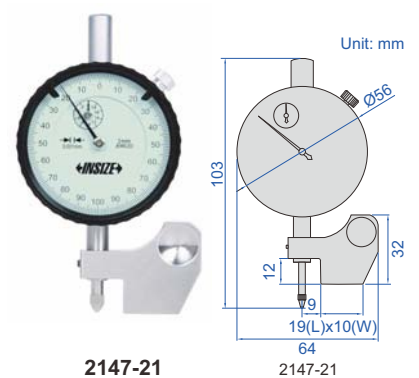
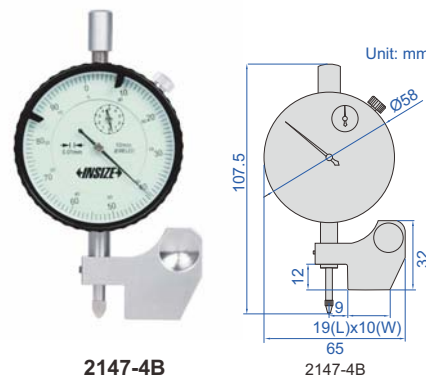
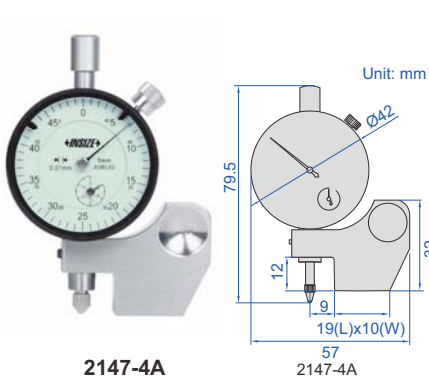

- Measure height difference of two surfaces

Code	Range	Dial indicator stroke	Dial indicator graduation	Accuracy
2147-4A	0~±5mm (adjustable)	5mm	0.01mm	±0.014mm
2147-4B	0~±5mm	10mm	0.01mm	±0.017mm
2147-21	0~±2mm (adjustable)	2mm	0.001mm	±0.006mm

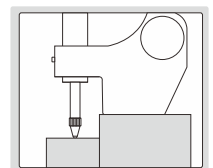

## DIGITAL HEIGHT GAGES

DATA OUTPUT



2146-4A

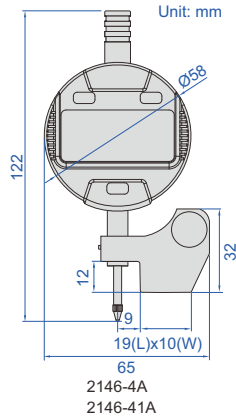

2146-4A  
2146-41A



2146-4B

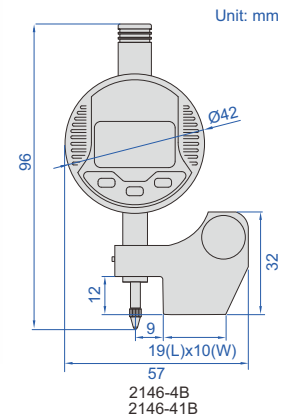

2146-4B  
2146-41B

- Measure height difference of two surfaces
- Button function: on/off, inch/mm, zero, data preset, change measuring direction, absolute/incremental measurement
- Keep preset data in memory after restart
- CR2032 battery, automatic power off (time is adjustable)
- Data output
- Optional accessory: data output cable (code 7315-50M need receiver page 5, 7302-40M page 13)

measure sunked step

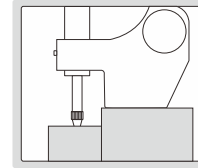

measure raised step

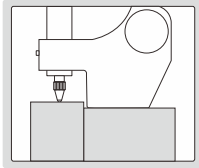

Code	Range (adjustable)	Digital indicator stroke	Digital indicator resolution	Accuracy
2146-4A	0~4mm/0~0.16" (sunked)	12.7mm/0.5"	0.01mm/0.0005"	±0.02mm
2146-41A	0~12.7mm/0~0.5" (raised)	12.7mm/0.5"	0.001mm/0.00005"	±0.005mm
2146-4B	0~4mm/0~0.16" (sunked)	5mm/0.2"	0.01mm/0.0005"	±0.02mm
2146-41B	0~5mm/0~0.2" (raised)	5mm/0.2"	0.001mm/0.00005"	±0.005mm

## CRANKSHAFT TESTERS

12

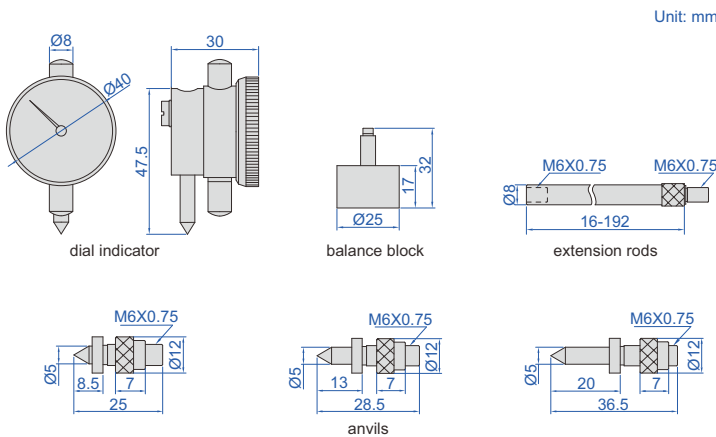

2841-500

- To test crankshaft deflection
- The balance block is mounted on the back of dial indicator to keep the dial indicator facing up

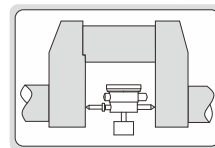

Code	Range	Dial indicator range	Graduation	Extension rods	Accuracy
2841-300	60-300mm	3mm	0.01mm	16mm, 32mm, 64mm, 128mm	±0.016mm
2841-500	60-500mm	3mm	0.01mm	16mm, 32mm, 64mm, 96mm, 128mm, 192mm	±0.016mm



Thread Pitch Measuring Instruments  
Page 302-303

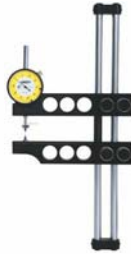

Thread Taper Measuring Instruments  
Page 304-306



Thread Height Measuring Instruments  
Page 307-309



Thread Crest Diameter Measuring  
Instruments  
Page 310-313



Groove Diameter Measuring  
Instruments  
Page 314



Groove Width Measuring Instruments  
Page 315



Calipers With Interchangeable  
Ball Tips  
Page 316



RTJ Ring Groove Calipers  
Page 316



Thread Gages For Petroleum  
Equipment  
Page 316

## DIGITAL THREAD PITCH MEASURING INSTRUMENT

MEET INTERNATIONAL STANDARD API5B

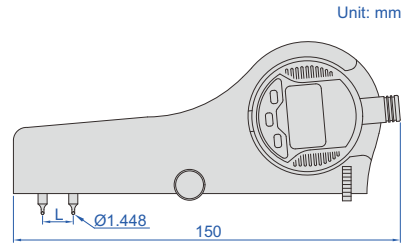

- Measure the pitch of external thread and internal thread with nominal diameter larger than 5 1/2" (139.7mm)
- Optional accessory: data output cable (code 7315-50M need receiver page 5, 7302-50M page 13), ball points (code 6252 series), standard pitch blocks (code 6251 series)

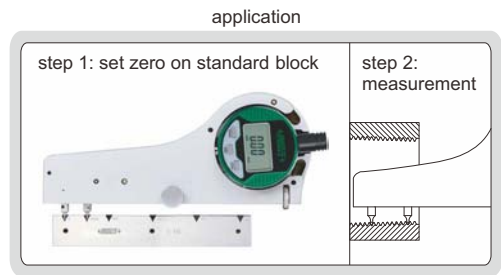

Code	Range (L)	Digital indicator stroke	Resolution	Accuracy
2245-4	0.5-4"/12.7-101.6mm	0.2"/5mm	0.0005"/0.01mm	0.02mm

## THREAD PITCH MEASURING INSTRUMENTS

MEET INTERNATIONAL STANDARD API5B

13

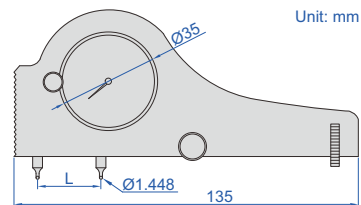
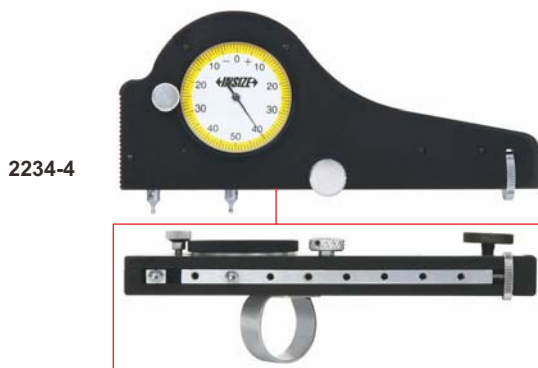

- Measure the pitch of external thread and internal thread with nominal diameter larger than 5 1/2" (139.7mm)
- Optional accessory: ball points (code 6252 series), standard pitch blocks (code 6251 series)

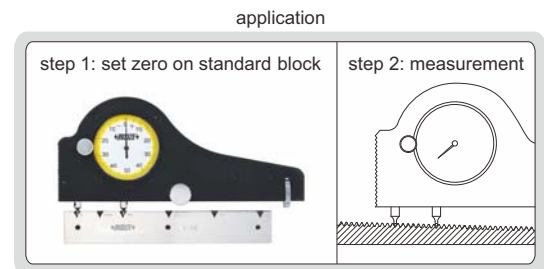

Code	Range (L)	Dial indicator stroke	Dial indicator graduation	Accuracy
2234-4	0.5-4"/12.7-101.6mm	0.5mm	0.01mm	0.02mm
2234-4E	0.5-4"/12.7-101.6mm	0.025"	0.0005"	0.0008"

MEET INTERNATIONAL  
STANDARD API5B

## INTERNAL THREAD PITCH MEASURING INSTRUMENTS



2235-4

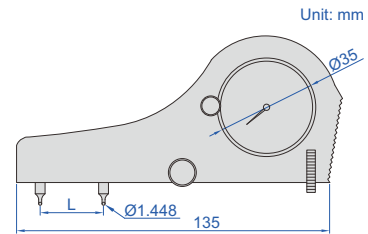

application

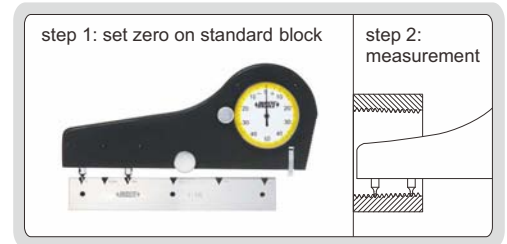

- Measure the pitch of internal thread with nominal diameter larger than 1 1/2" (38.1mm) and less than 5 1/2" (139.7mm)
- Optional accessory: ball points (code 6252 series), standard pitch blocks (code 6251 series)

Code	Range (L)	Dial indicator stroke	Dial indicator graduation	Accuracy
2235-4	0.5-4"/12.7-101.6mm	0.5mm	0.01mm	0.02mm
2235-4E	0.5-4"/12.7-101.6mm	0.025"	0.0005"	0.0008"

CAN BE CUSTOMIZED  
ACCORDING TO WORKPIECES

## STANDARD PITCH BLOCKS 13



6251-S8

- Set zero of internal and external pitch measuring instruments (code 2234, 2235, 2245)

Code	Taper	Threads per inch
6251-S8	1:16	8, 10
6251-S5	1:16	5
6251-S4	1:6	4

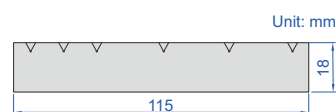

## DIGITAL EXTERNAL THREAD TAPER MEASURING INSTRUMENT

MEET INTERNATIONAL STANDARD API5B

- Measure the taper of external thread
- Digital indicator stroke: 10mm/0.4"
- Optional accessory: data output cable (code 7315-50M need receiver page 5, 7302-40M page 13), ball points (code 6252 series)

principle of measurement

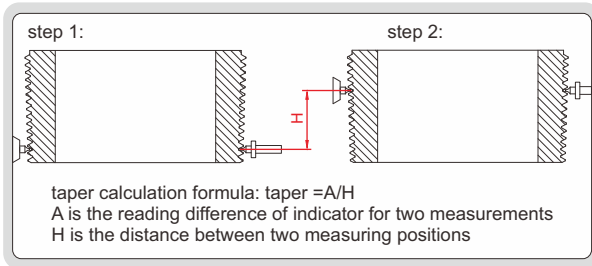

2240-10

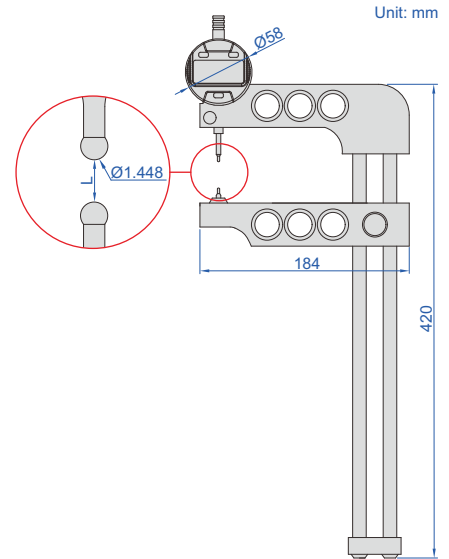

Code	Range (L)	Resolution	Accuracy
2240-10	0-10"/0-254mm	0.0005"/0.01mm	0.03mm

## EXTERNAL THREAD TAPER MEASURING INSTRUMENTS

MEET INTERNATIONAL STANDARD API5B

- Measure the taper of external thread
- Dial indicator stroke: 0.5"
- Dial indicator graduation: 0.001"
- Optional accessory: ball points (code 6252 series)

principle of measurement

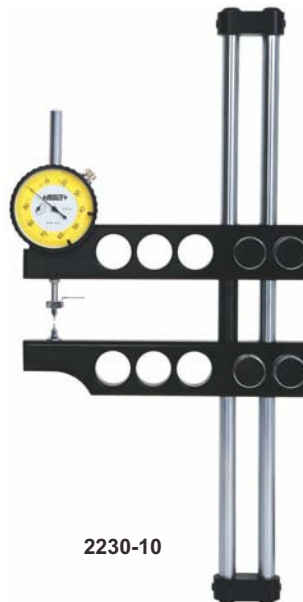
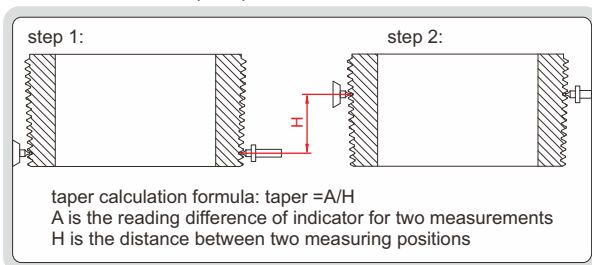

2230-10

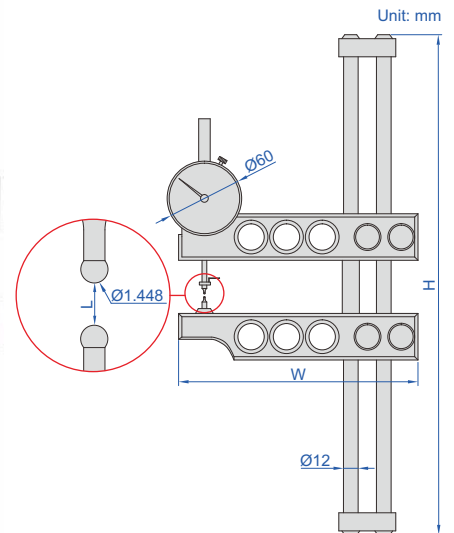

Code	Range (L)	Accuracy	H	W
2230-10	0-10"/0-254mm	0.0015"	400mm	200mm
2230-45	1-4 1/2"/25.4-114.3mm	0.0015"	278mm	178mm
2230-16	8-16"/203.2-406.4mm	0.0015"	600mm	260mm
2230-20	8-20"/203.2-508mm	0.0015"	680mm	260mm



MEET INTERNATIONAL  
STANDARD API5B

## INTERNAL THREAD TAPER MEASURING INSTRUMENTS



2231-6



2231-16

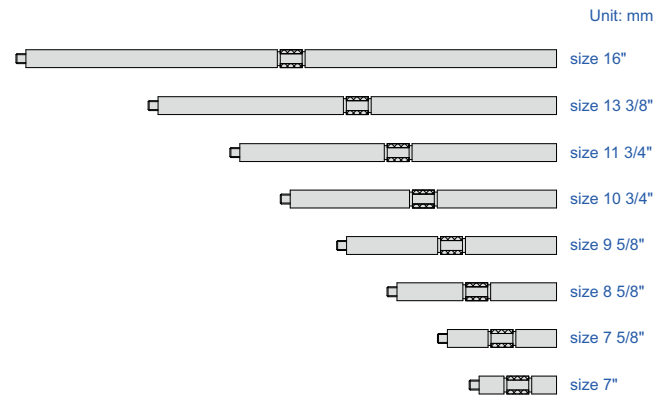
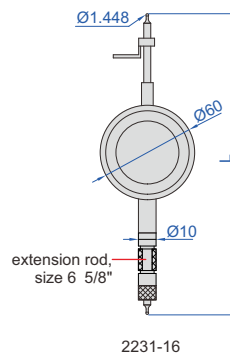
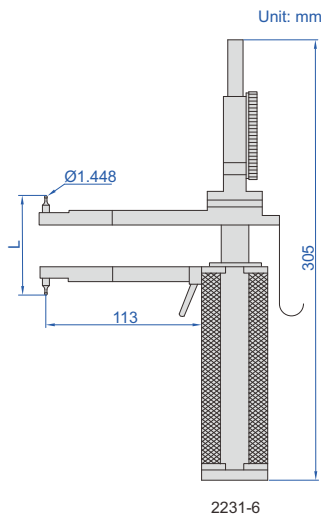

- Measure the taper of internal thread
- Optional accessory: ball points (code 6252 series)

### principle of measurement

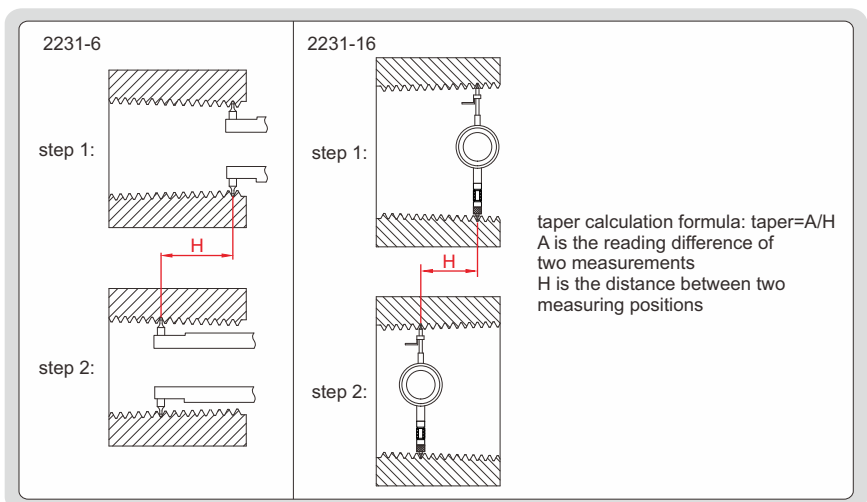

Code	Range (L)	Dial indicator stroke	Dial indicator graduation	Accuracy	Remark
2231-6	1.5-6"/38.1-152.4mm	1"	0.001"	0.0015"	—
2231-16	5 1/2-16"/139.7-406.4mm	0.5"	0.001"	0.0015"	with 9 extension rods

# DIGITAL INTERNAL THREAD TAPER MEASURING INSTRUMENT

MEET INTERNATIONAL STANDARD API5B

principle of measurement

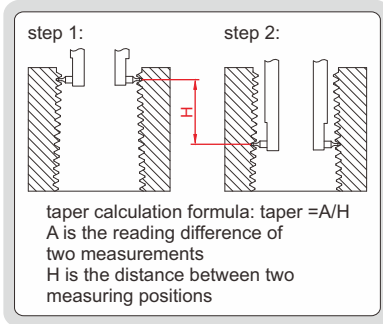

2241-6

- Measure the taper of internal thread
- Digital indicator stroke: 25.4mm/1"
- Optional accessory: data output cable (code 7315-50M need receiver page 5, 7302-40M page 13), ball points (code 6252 series)

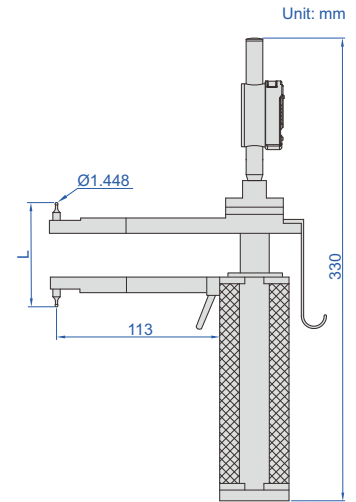

Code	Range (L)	Resolution	Accuracy
2241-6	1.5-6"/38.1-152.4mm	0.0005"/0.01mm	0.04mm

## BALL POINTS

13

- Supplied in pair
- For taper measuring instruments (code 2230, 2231, 2240, 2241) and pitch measuring instruments (code 2234, 2235, 2245)



6252-B10

Code	Thread type	Threads per inch	Ball dia. (Ød)	
			taper	pitch
6252-B8	round thread, line pipe	8	1.829mm	1.829mm
6252-B10	round thread, line pipe	10	1.448mm	1.448mm
6252-B115	line pipe	11.5	1.27mm	1.27mm
6252-B14	line pipe	14	1.041mm	1.041mm
6252-B18	line pipe	18	0.813mm	0.813mm
6252-B27	line pipe	27	0.533mm	0.533mm
6252-B5	buttness thread	5	2.286mm	—
6252-B51	buttness thread	5	—	1.575mm
6252-B52	extreme line thread	5,6	1.524mm	—
6252-B53	extreme line thread	5	—	2.667mm*
6252-B6	extreme line thread	6	—	2.210mm*

\*0.58mm off the top of ball

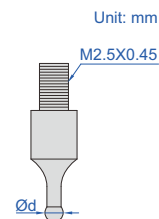

MEET INTERNATIONAL  
STANDARD API5B

## DIGITAL INTERNAL THREAD HEIGHT MEASURING INSTRUMENT

application

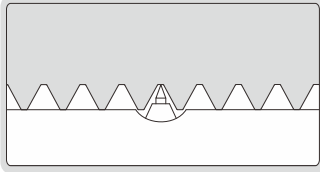

2243-35

- Measure the height of internal thread with nominal diameter less than 5 1/2" (139.7mm)
- Optional accessory: data output cable (code **7315-50M** need receiver page 5, **7302-50M** page 13), thread height standard blocks (code **6250**)

Unit: mm

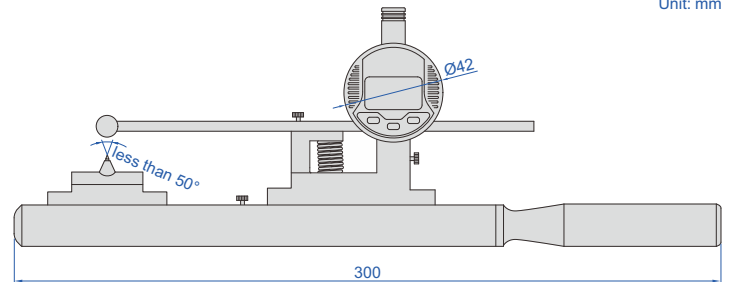

Code	Range	Resolution	Accuracy
2243-35	0-0.135"/0-3.5mm	0.0005"/0.01mm	0.02mm

MEET INTERNATIONAL  
STANDARD API5B

## INTERNAL THREAD HEIGHT MEASURING INSTRUMENTS

application

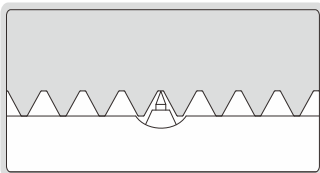

2233-35

- Measure the height of internal thread with nominal diameter less than 5 1/2" (139.7mm)
- Optional accessory: thread height standard blocks (code **6250**)

Unit: mm

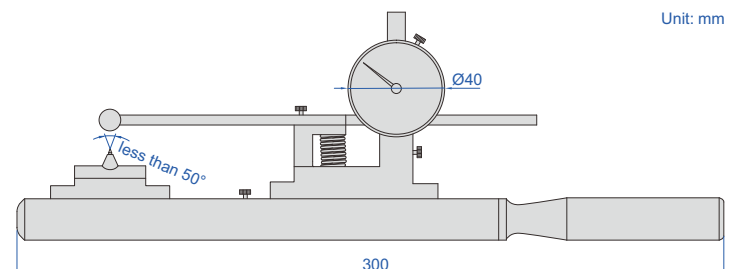

Code	Range	Dial indicator graduation	Accuracy
2233-35	0-3.5mm	0.01mm	0.02mm
2233-35E	0-1/4"	0.0005"	0.0008"

## DIGITAL THREAD HEIGHT MEASURING INSTRUMENT

MEET INTERNATIONAL STANDARD API5B

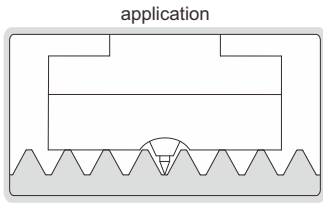

- Measure the height of external thread and internal thread with nominal diameter larger than 5 1/2" (139.7mm)
- Optional accessory: data output cable (code 7315-50M need receiver page 5, 7302-40M page 13), thread height standard blocks (code 6250)



2242-35

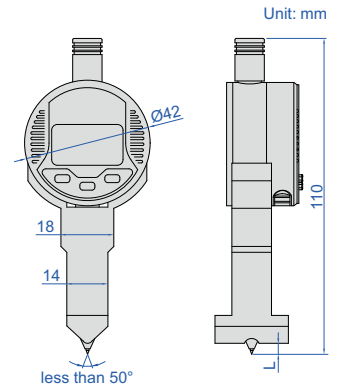

Code	Range (L)	Resolution	Accuracy
2242-35	0-0.135"/0-3.5mm	0.0005"/0.01mm	0.02mm

## THREAD HEIGHT MEASURING INSTRUMENTS

MEET INTERNATIONAL STANDARD API5B

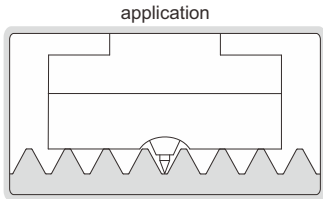

- Measure the height of external thread and internal thread with nominal diameter larger than 5 1/2" (139.7mm)
- Optional accessory: thread height standard blocks (code 6250)



2232-35

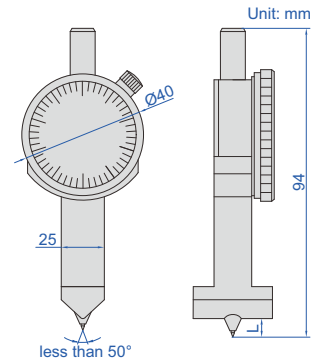

Code	Range (L)	Dial indicator graduation	Accuracy
2232-35	0-3.5mm	0.01mm	0.02mm
2232-35E	0-1/4"	0.0005"	0.0008"

## THREAD HEIGHT STANDARD BLOCKS

CAN BE CUSTOMIZED ACCORDING TO WORKPIECES

- Set zero of internal and external thread height measuring instruments (code 2232, 2233, 2242, 2243)

Code	Taper	Number of thread per inch
6250-4	1:4	4
6250-5	1:4	5
6250-8	1:16	8, 10
6250-51	1:16	5



6250-8

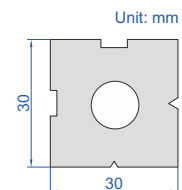

MEET INTERNATIONAL  
STANDARD API 7-2

## ROTARY SHOULDERED EXTERNAL THREAD CONNECTION HEIGHT MEASURING INSTRUMENTS

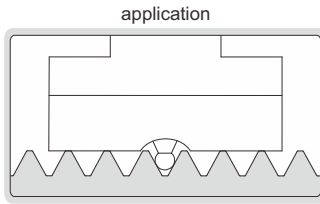

- Measure the height of rotary shouldered external thread connections
- Dial indicator graduation: 0.01mm
- Accuracy: 0.02mm
- Optional accessory: thread height standard blocks (code 6255)

Code	Form of thread to be inspected	Range (L)	A
2255-038	V-0.038R	0-3.5mm	Ø1.829mm
2255-040	V-0.040	0-3.5mm	Ø0.864mm
2255-050	V-0.050	0-5mm	Ø1.118mm
2255-055	V-0.055	0-3.5mm	Ø1.829mm

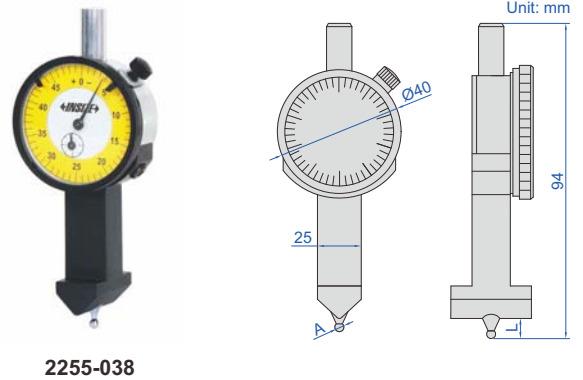

MEET INTERNATIONAL  
STANDARD API 7-2

## ROTARY SHOULDERED INTERNAL THREAD CONNECTION HEIGHT MEASURING INSTRUMENTS

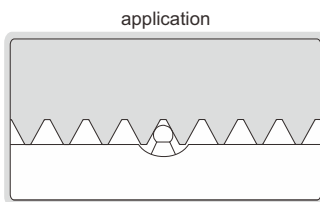

- Measure the height of rotary shouldered internal thread connections
- Dial indicator graduation: 0.01mm
- Accuracy: 0.02mm
- Optional accessory: thread height standard blocks (code 6255)

Code	Form of thread to be inspected	Range (L)	A
2256-038	V-0.038R	0-3.5mm	Ø1.829mm
2256-040	V-0.040	0-3.5mm	Ø0.864mm
2256-050	V-0.050	0-5mm	Ø1.118mm
2256-055	V-0.055	0-3.5mm	Ø1.829mm

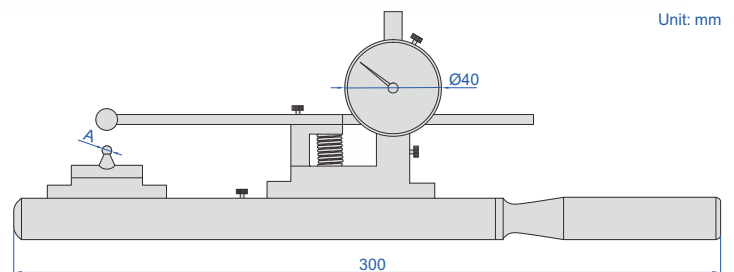

## THREAD HEIGHT STANDARD BLOCKS

- Set zero of internal and external thread height measuring instruments (code 2255, 2256)

CAN BE CUSTOMIZED  
ACCORDING TO WORKPIECES

Code	Form of thread to be inspected	Taper	Number of thread per inch
6255-038	V-0.038R	1:6 and 1:4	4
6255-040	V-0.040	1:4	5
6255-050	V-0.050	1:6 and 1:4	4
6255-055	V-0.055	1:8	6

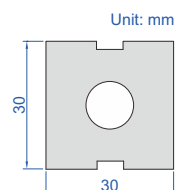

## DIGITAL DEPTH GAGE (60° KNIFE EDGE BASE)

REFER TO PAGE 81  
FOR DETAILS



front view

side view

2143-101

## DIGITAL INTERNAL THREAD CREST DIAMETER MEASURING INSTRUMENT

MEET INTERNATIONAL  
STANDARD API5B

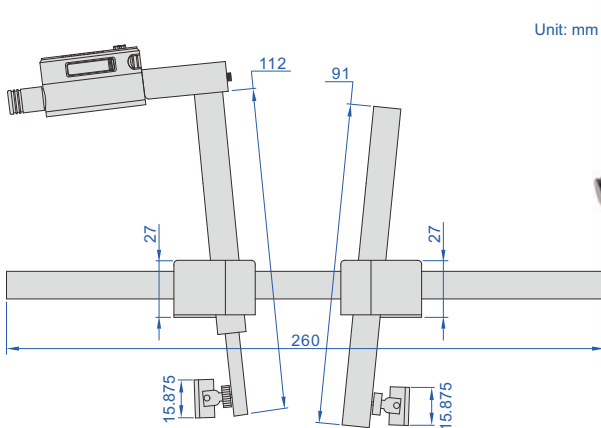

Unit: mm



2247-5

application

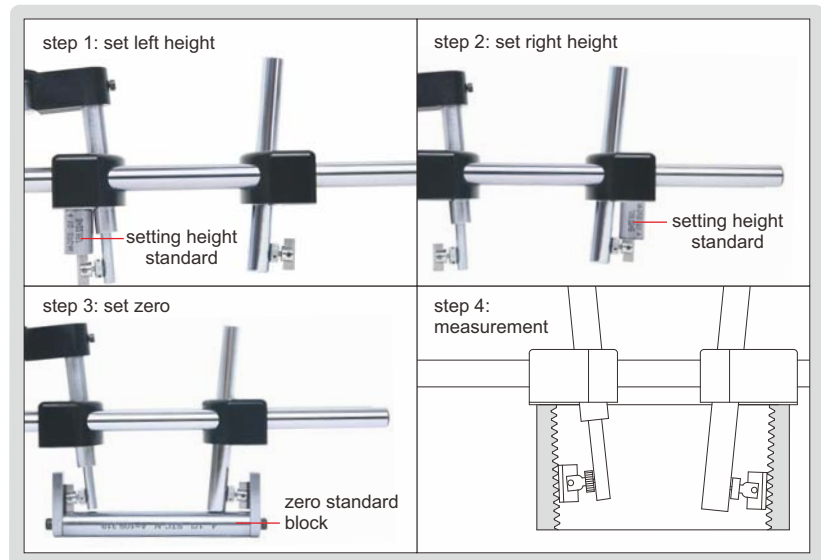

13

- Measure the crest diameter of internal thread with nominal diameter larger than 2 3/8" (60.325mm) and less than 5 1/2" (139.7mm)
- Optional accessory: data output cable (code 7315-50M need receiver page 5, 7302-40M page 13), height standard and zero standard block (code 2237-G□□□, 2237-K□□□)

Code	Range	Digital indicator stroke	Resolution	Accuracy
2247-5	2 3/8-5 1/2"/60.325-139.7mm	0.2"/5mm	0.0005"/0.01mm	0.02mm

MEET INTERNATIONAL  
STANDARD API5B

## INTERNAL THREAD CREST DIAMETER MEASURING INSTRUMENTS



2237-5

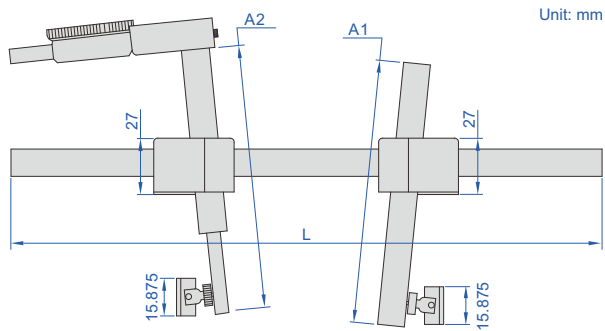

- Measure the crest diameter of internal thread with nominal diameter larger than 2 3/8" (60.325mm) and less than 20" (508mm)
- Optional accessory: height standard and zero standard block

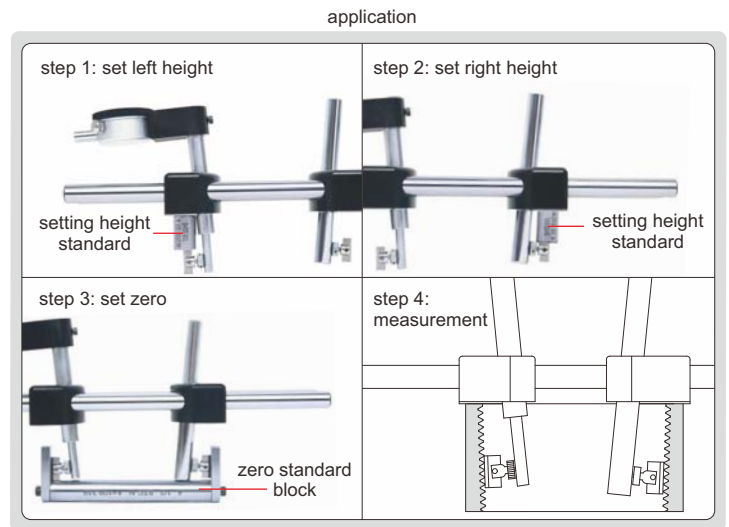

Code	Range	Dial indicator stroke	Dial indicator graduation	Accuracy	L	A1	A2
2237-5	2 3/8-5 1/2"/60.325-139.7mm	5mm	0.01mm	0.02mm	260mm	112mm	91mm
2237-5E	2 3/8-5 1/2"/60.325-139.7mm	0.25"	0.0005"	0.0008"	260mm	112mm	91mm
2237-20	4 1/2-20"/114.3-508mm	0.50"	0.0005"	0.002"	12", 18" or 24" *	177mm	182mm

\* Select suitable length of arm according to workpieces



### HEIGHT STANDARD AND ZERO STANDARD BLOCK (optional)

Code	Remark
2237-G□□□**	including height standard and zero standard block A (without taper)
2237-K□□□**	including height standard and zero standard block B (with taper)

\*\* Can be customized according to workpieces

# DIGITAL EXTERNAL THREAD CREST DIAMETER MEASURING INSTRUMENT

MEET INTERNATIONAL  
STANDARD API5B



2246-5

- Measure the crest diameter of external thread with nominal diameter larger than 2 3/8" (60.325mm) and less than 5 1/2" (139.7mm)
- Optional accessory: data output cable (code **7315-50M** need receiver page 5, **7302-40M** page 13), height standard and zero standard block (code **2236-G□□□**, **2236-K□□□**)

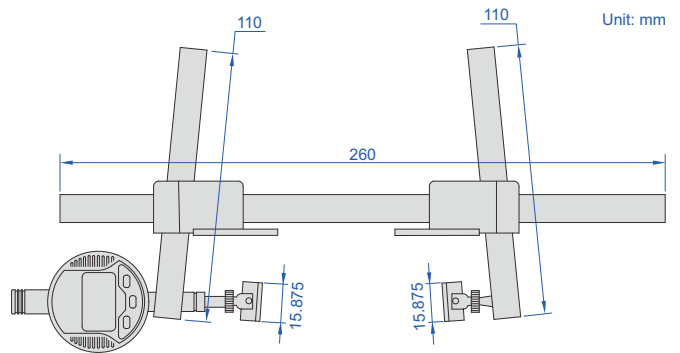

application

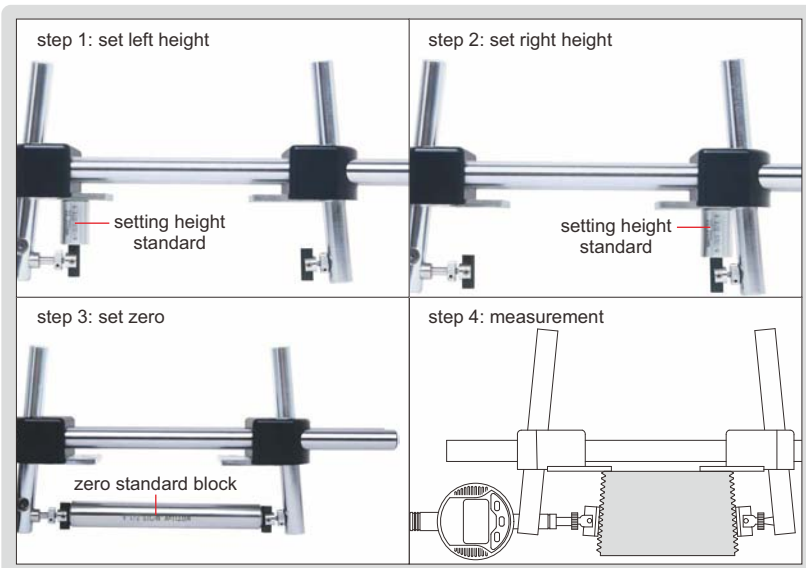

Code	Range	Digital indicator stroke	Resolution	Accuracy
2246-5	2 3/8-5 1/2"/60.325-139.7mm	0.2"/5mm	0.0005"/0.01mm	0.02mm



MEET INTERNATIONAL  
STANDARD API5B

## EXTERNAL THREAD CREST DIAMETER MEASURING INSTRUMENTS



2236-5

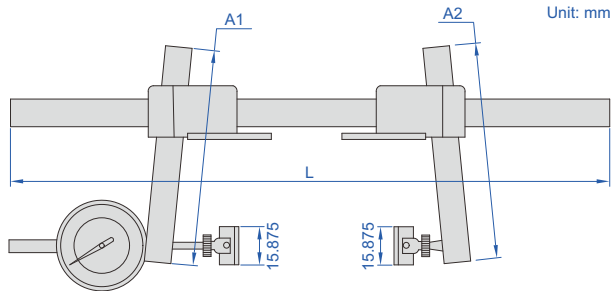

- Measure the crest diameter of external thread with nominal diameter larger than 2 3/8" (60.325mm) and less than 20" (508mm)
- Optional accessory: height standard and zero standard block

application

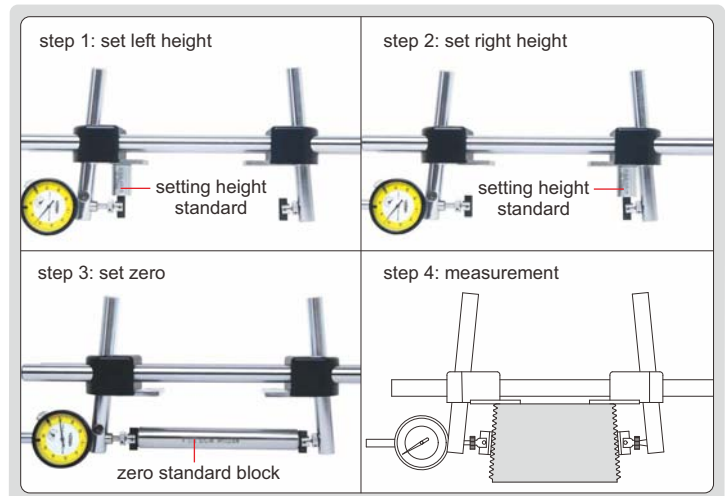

Code	Range	Dial indicator stroke	Dial indicator graduation	Accuracy	L	A1	A2
2236-5	2 3/8-5 1/2"/60.325-139.7mm	5mm	0.01mm	0.02mm	260mm	110mm	110mm
2236-5E	2 3/8-5 1/2"/60.325-139.7mm	0.25"	0.0005"	0.0008"	260mm	110mm	110mm
2236-20	2 3/8-20"/60.325-508mm	0.50"	0.0005"	0.002"	12", 18" or 24" *	177mm	160mm

\* Select suitable length of arm according to workpieces



### HEIGHT STANDARD AND ZERO STANDARD BLOCK (optional)

Code	Remark
2236-G□□□**	including height standard and zero standard block A (without taper)
2236-K□□□**	including height standard and zero standard block B (with taper)

\*\* Can be customized according to workpieces

## DIGITAL GROOVE DIAMETER MEASURING INSTRUMENT

POINT DIAMETER CAN BE CUSTOM-MADE



2261-5

- Measure the groove diameter of flange ring groove
- Point height is adjustable
- Optional: data output cable (code 7315-50M need receiver page 5, 7302-40M page 13), groove standard block (code 6254)

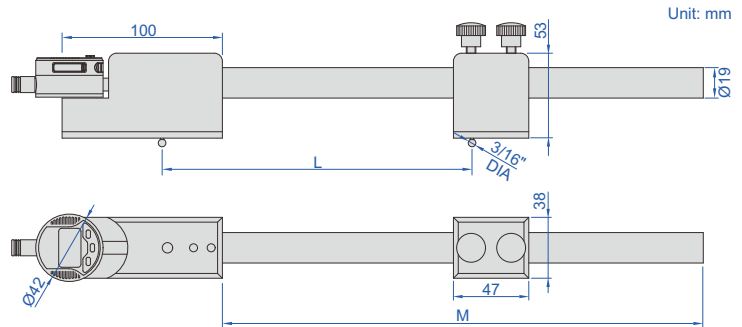
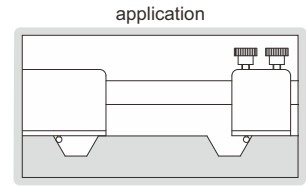

Unit: mm

### Stem (optional)

Code	M
2261-M24	24"/600mm
2261-M30	30"/750mm
2261-M36	36"/900mm

Code	Range (L)	Movable point stroke	Resolution	Repeatability	M
2261-5	2.6-13"/66-330mm	0.2"/5mm	0.00005"/0.001mm	0.002mm	12"/300mm

## GROOVE DIAMETER MEASURING INSTRUMENTS

POINT DIAMETER CAN BE CUSTOM-MADE

13



2251-5

- Measure the groove diameter of flange ring groove
- Point height is adjustable
- Optional: groove standard block (code 6254)

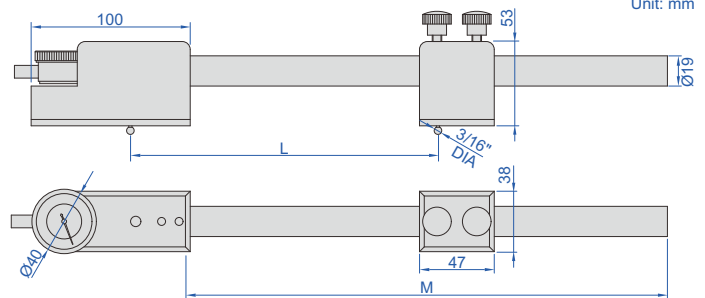
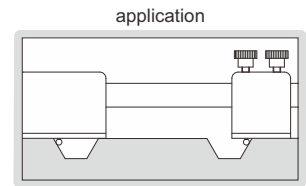

Unit: mm

### Stem (optional)

Code	M
2261-M24	24"/600mm
2261-M30	30"/750mm
2261-M36	36"/900mm

Code	Range (L)	Movable point stroke	Graduation	Repeatability	M
2251-5	2.6-13"/66-330mm	0.2"/5mm	0.01mm	0.005mm	12"/300mm
2251-5E	2.6-13"/66-330mm	0.2"/5mm	0.0005"	0.0002"	12"/300mm

POINT DIAMETER CAN BE CUSTOM-MADE

## DIGITAL GROOVE WIDTH MEASURING INSTRUMENT

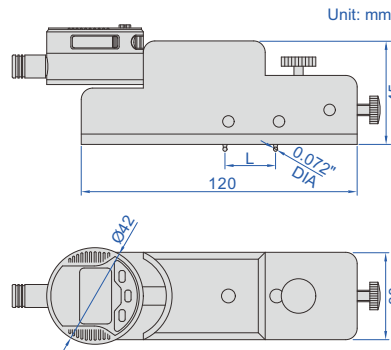
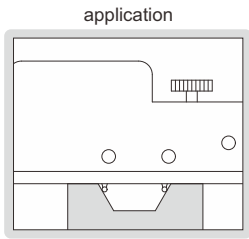

2260-4

- Measure the groove width of flange ring groove
- Point height is adjustable
- Optional: data output cable (code 7315-50M need receiver page 5, 7302-40M page 13), groove standard block (code 6254)

Code	Range (L)	Movable point stroke	Resolution	Repeatability
2260-4	0.55-1.4"/14-35.5mm	0.16"/4mm	0.00005"/0.001mm	0.002mm

POINT DIAMETER CAN BE CUSTOM-MADE

## GROOVE WIDTH MEASURING INSTRUMENTS

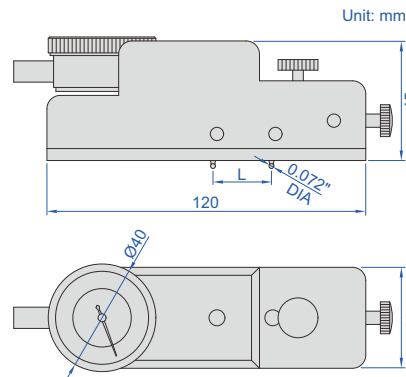
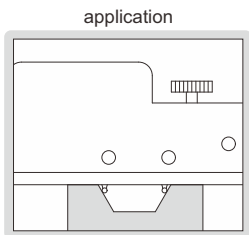

2250-4

- Measure the groove width of flange ring groove
- Point height is adjustable
- Optional: groove standard block (code 6254)

Code	Range (L)	Movable point stroke	Graduation	Repeatability
2250-4	0.55-1.4"/14-35.5mm	0.16"/4mm	0.01mm	0.005mm
2250-4E	0.55-1.4"/14-35.5mm	0.16"/4mm	0.0005"	0.0002"

CUSTOM-MADE

## STANDARD GROOVE BLOCK CODE 6254



- Set zero of groove width and groove diameter measuring instruments (code 2250, 2251, 2260, 2261)

## DIGITAL CALIPERS WITH INTERCHANGEABLE BALL TIPS

REFER TO PAGE 61  
FOR DETAILS



1527-3001



1528-3001

## DIGITAL RTJ RING GROOVE CALIPERS

REFER TO PAGE 60  
FOR DETAILS



1179-300



1179-600

## THREAD GAGES FOR ROTARY SHOULDERED CONNECTIONS OF PETROLEUM EQUIPMENT

REFER TO PAGE 372  
FOR DETAILS



4177-23

## CASING, TUBING AND LINE PIPE THREAD GAGES OF PETROLEUM AND GAS EQUIPMENT

REFER TO PAGE  
373-374 FOR DETAILS



4178-21T



**Gage Blocks**  
Page 318-325



**Caliper Inspection Gage Block Sets**  
Page 326



**Micrometer Inspection Gage Block Sets**  
Page 327



**Gage Block Holders**  
Page 327



**Gage Block Accessories**  
Page 328



**Cylinder Gage Blocks**  
Page 329



**CMM Check Masters**  
Page 330-331



**Caliper/Height Gage Checkers**  
Page 332



**Angle Gage Blocks**  
Page 333



**Pin Gages**  
Page 334-337



**Pin Gage Handles**  
Page 337-339



**Cylinder Gages**  
Page 340



**Adjustable Snap Gages**  
Page 341



**Setting Rings**  
Page 342-344



**Plain Plug Gages**  
Page 345-348



**Measuring Balls**  
Page 349-350



**Threaded Hole Location Gages**  
Page 350-351



**Thread Depth Gages**  
Page 352-353



**Thread Ring/Plug Gages**  
Page 354-374



**Semi-Automatic Thread Inspectors**  
Page 374

## GAGE BLOCKS

Accuracy according to ISO3650

Nominal length (mm)	Grade 0		Grade 1		Grade 2	
	Limit deviation of length	Tolerance for the variation in length	Limit deviation of length	Tolerance for the variation in length	Limit deviation of length	Tolerance for the variation in length
over 0.5 to 10	±0.12µm	0.10µm	±0.20µm	0.16µm	±0.45µm	0.30µm
over 10 to 25	±0.14µm	0.10µm	±0.30µm	0.16µm	±0.60µm	0.30µm
over 25 to 50	±0.20µm	0.10µm	±0.40µm	0.18µm	±0.80µm	0.30µm
over 50 to 75	±0.25µm	0.12µm	±0.50µm	0.18µm	±1.00µm	0.35µm
over 75 to 100	±0.30µm	0.12µm	±0.60µm	0.20µm	±1.20µm	0.35µm
over 100 to 150	±0.40µm	0.14µm	±0.80µm	0.20µm	±1.60µm	0.40µm
over 150 to 200	±0.50µm	0.16µm	±1.00µm	0.25µm	±2.00µm	0.40µm
over 200 to 250	±0.60µm	0.16µm	±1.20µm	0.25µm	±2.40µm	0.45µm
over 250 to 300	±0.70µm	0.18µm	±1.40µm	0.25µm	±2.80µm	0.50µm
over 300 to 400	±0.90µm	0.20µm	±1.80µm	0.30µm	±3.60µm	0.50µm
over 400 to 500	±1.10µm	0.25µm	±2.20µm	0.35µm	±4.40µm	0.60µm
over 500 to 600	±1.30µm	0.25µm	±2.60µm	0.40µm	±5.00µm	0.70µm
over 600 to 700	±1.50µm	0.30µm	±3.00µm	0.45µm	±6.00µm	0.70µm
over 700 to 800	±1.70µm	0.30µm	±3.40µm	0.50µm	±6.50µm	0.80µm
over 800 to 900	±1.90µm	0.35µm	±3.80µm	0.50µm	±7.50µm	0.90µm
over 900 to 1000	±2.00µm	0.40µm	±4.20µm	0.60µm	±8.00µm	1.00µm

### Grade and application

Grade	Application
0	To be used as basic standards in calibration laboratories by skilled inspection staff, to calibrate or set high accuracy measuring instruments, to calibrate gage blocks of grade 1 and 2.
1	To be used in inspection rooms, to check gages, inspect high accuracy parts and set measuring instruments.
2	To be used in workshops, to check production gages, set measuring instruments and mount tools.

## WEAR BLOCK SETS



14

- Protect the measuring surfaces of gage blocks from excessive wear
- Meet ISO3650
- Supplied with manufacturer inspection certificate



4111-2

Blocks per set	Size	Material	Code	
			Grade 0	Grade 1
2	1.0mm	ceramic	4111-1	4111-11
2	1.0mm	alloy steel	4111-1A	4111-11A
2	2.0mm	ceramic	4111-2	4111-12
2	2.0mm	alloy steel	4111-2A	4111-12A

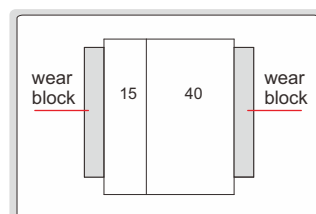



## CERAMIC GAGE BLOCK SETS

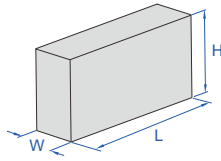

Dimension:

Size (L)	W	H
0.5 ≤ L ≤ 10mm	9mm	30mm
L > 10mm	9mm	35mm



4105-87

- Made of ceramic, extremely wear resistance and corrosion resistance, excellent dimension stability
- Meet ISO3650
- Supplied with manufacturer inspection certificate

Blocks per set	Gage blocks included in set			Code	
	Size (mm)	Step (mm)	Quantity	Grade 0	Grade 1
112	1.0005		1	4105-112	4105-1112
	1.001-1.009	0.001	9		
	1.01-1.49	0.01	49		
	0.5-24.5	0.5	49		
	25-100	25	4		
103	1.005		1	4105-103	4105-1103
	1.01-1.49	0.01	49		
	0.5-24.5	0.5	49		
	25-100	25	4		
88	1.0005		1	4105-88	4105-188
	1.001-1.009	0.001	9		
	1.01-1.49	0.01	49		
	0.5-9.5	0.5	19		
	10-100	10	10		
87	1.001-1.009	0.001	9	4105-87	4105-187
	1.01-1.49	0.01	49		
	0.5-9.5	0.5	19		
	10-100	10	10		
76	1.005		1	4105-76	4105-176
	1.01-1.49	0.01	49		
	0.5-9.5	0.5	19		
	10-40	10	4		
	50-100	25	3		
56	0.5		1	4105-56	4105-156
	1.001-1.009	0.001	9		
	1.01-1.09	0.01	9		
	1.1-1.9	0.1	9		
	1-24	1	24		
	25-100	25	4		

Blocks per set	Gage blocks included in set			Code	
	Size (mm)	Step (mm)	Quantity	Grade 0	Grade 1
47	1.005		1	4105-47A	4105-147A
	1.01-1.09	0.01	9		
	1.1-1.9	0.1	9		
	1-24	1	24		
	25-100	25	4		
47	1.005		1	4105-47	4105-147
	1.01-1.19	0.01	19		
	1.2-1.9	0.1	8		
	1-9	1	9		
	10-100	10	10		
46	1.001-1.009	0.001	9	4105-46	4105-146
	1.01-1.09	0.01	9		
	1.1-1.9	0.1	9		
	1-9	1	9		
	10-100	10	10		
34	1.0005		1	4105-34	4105-134
	1.001-1.009	0.001	9		
	1.01-1.09	0.01	9		
	1.1-1.9	0.1	9		
	1-5	1	5		
32	1.005		1	4105-32	4105-132
	1.01-1.09	0.01	9		
	1.1-1.9	0.1	9		
	1-9	1	9		
	10-30	10	3		
	50	1			

# CERAMIC INDIVIDUAL GAGE BLOCKS



4106-A80

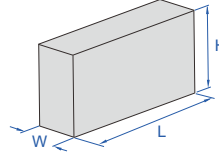

Dimension:

Size (L)	W	H
0.5 ≤ L ≤ 10mm	9mm	30mm
L > 10mm	9mm	35mm

- Grade 0 and 1 gage blocks are available
- Made of ceramic, extremely wear resistance and corrosion resistance
- Meet ISO3650
- Supplied with manufacturer inspection certificate

**Code explanation:**

4106-X□□□□

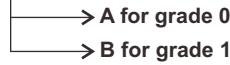

**Code examples:**

Size (L)	Grade	Code
0.5mm	0	4106-AD5
10mm	1	4106-B10

Size	Code	Size	Code	Size	Code	Size	Code
0.5mm	4106- <u>X</u> D5	1.23mm	4106- <u>X</u> 1D23	3mm	4106- <u>X</u> 3	17.6mm	4106- <u>X</u> 17D6
1mm	4106- <u>X</u> 1	1.24mm	4106- <u>X</u> 1D24	3.5mm	4106- <u>X</u> 3D5	18mm	4106- <u>X</u> 18
1.0005mm	4106- <u>X</u> 1D0005	1.25mm	4106- <u>X</u> 1D25	4mm	4106- <u>X</u> 4	18.5mm	4106- <u>X</u> 18D5
1.001mm	4106- <u>X</u> 1D001	1.26mm	4106- <u>X</u> 1D26	4.5mm	4106- <u>X</u> 4D5	19mm	4106- <u>X</u> 19
1.002mm	4106- <u>X</u> 1D002	1.27mm	4106- <u>X</u> 1D27	5mm	4106- <u>X</u> 5	19.5mm	4106- <u>X</u> 19D5
1.003mm	4106- <u>X</u> 1D003	1.28mm	4106- <u>X</u> 1D28	5.1mm	4106- <u>X</u> 5D1	20mm	4106- <u>X</u> 20
1.004mm	4106- <u>X</u> 1D004	1.29mm	4106- <u>X</u> 1D29	5.5mm	4106- <u>X</u> 5D5	20.2mm	4106- <u>X</u> 20D2
1.005mm	4106- <u>X</u> 1D005	1.3mm	4106- <u>X</u> 1D3	6mm	4106- <u>X</u> 6	20.5mm	4106- <u>X</u> 20D5
1.006mm	4106- <u>X</u> 1D006	1.31mm	4106- <u>X</u> 1D31	6.5mm	4106- <u>X</u> 6D5	21mm	4106- <u>X</u> 21
1.007mm	4106- <u>X</u> 1D007	1.32mm	4106- <u>X</u> 1D32	7mm	4106- <u>X</u> 7	21.5mm	4106- <u>X</u> 21D5
1.008mm	4106- <u>X</u> 1D008	1.33mm	4106- <u>X</u> 1D33	7.5mm	4106- <u>X</u> 7D5	22mm	4106- <u>X</u> 22
1.009mm	4106- <u>X</u> 1D009	1.34mm	4106- <u>X</u> 1D34	7.7mm	4106- <u>X</u> 7D7	22.5mm	4106- <u>X</u> 22D5
1.01mm	4106- <u>X</u> 1D01	1.35mm	4106- <u>X</u> 1D35	8mm	4106- <u>X</u> 8	22.8mm	4106- <u>X</u> 22D8
1.02mm	4106- <u>X</u> 1D02	1.36mm	4106- <u>X</u> 1D36	8.5mm	4106- <u>X</u> 8D5	23mm	4106- <u>X</u> 23
1.03mm	4106- <u>X</u> 1D03	1.37mm	4106- <u>X</u> 1D37	9mm	4106- <u>X</u> 9	23.5mm	4106- <u>X</u> 23D5
1.04mm	4106- <u>X</u> 1D04	1.38mm	4106- <u>X</u> 1D38	9.5mm	4106- <u>X</u> 9D5	24mm	4106- <u>X</u> 24
1.05mm	4106- <u>X</u> 1D05	1.39mm	4106- <u>X</u> 1D39	10mm	4106- <u>X</u> 10	24.5mm	4106- <u>X</u> 24D5
1.06mm	4106- <u>X</u> 1D06	1.4mm	4106- <u>X</u> 1D4	10.3mm	4106- <u>X</u> 10D3	25mm	4106- <u>X</u> 25
1.07mm	4106- <u>X</u> 1D07	1.41mm	4106- <u>X</u> 1D41	10.5mm	4106- <u>X</u> 10D5	30mm	4106- <u>X</u> 30
1.08mm	4106- <u>X</u> 1D08	1.42mm	4106- <u>X</u> 1D42	11mm	4106- <u>X</u> 11	40mm	4106- <u>X</u> 40
1.09mm	4106- <u>X</u> 1D09	1.43mm	4106- <u>X</u> 1D43	11.5mm	4106- <u>X</u> 11D5	41.3mm	4106- <u>X</u> 41D3
1.1mm	4106- <u>X</u> 1D1	1.44mm	4106- <u>X</u> 1D44	12mm	4106- <u>X</u> 12	50mm	4106- <u>X</u> 50
1.11mm	4106- <u>X</u> 1D11	1.45mm	4106- <u>X</u> 1D45	12.5mm	4106- <u>X</u> 12D5	60mm	4106- <u>X</u> 60
1.12mm	4106- <u>X</u> 1D12	1.46mm	4106- <u>X</u> 1D46	12.9mm	4106- <u>X</u> 12D9	70mm	4106- <u>X</u> 70
1.13mm	4106- <u>X</u> 1D13	1.47mm	4106- <u>X</u> 1D47	13mm	4106- <u>X</u> 13	75mm	4106- <u>X</u> 75
1.14mm	4106- <u>X</u> 1D14	1.48mm	4106- <u>X</u> 1D48	13.5mm	4106- <u>X</u> 13D5	80mm	4106- <u>X</u> 80
1.15mm	4106- <u>X</u> 1D15	1.49mm	4106- <u>X</u> 1D49	14mm	4106- <u>X</u> 14	90mm	4106- <u>X</u> 90
1.16mm	4106- <u>X</u> 1D16	1.5mm	4106- <u>X</u> 1D5	14.5mm	4106- <u>X</u> 14D5	100mm	4106- <u>X</u> 100
1.17mm	4106- <u>X</u> 1D17	1.6mm	4106- <u>X</u> 1D6	15mm	4106- <u>X</u> 15	125mm	4106- <u>X</u> 125
1.18mm	4106- <u>X</u> 1D18	1.7mm	4106- <u>X</u> 1D7	15.5mm	4106- <u>X</u> 15D5	131.4mm	4106- <u>X</u> 131D4
1.19mm	4106- <u>X</u> 1D19	1.8mm	4106- <u>X</u> 1D8	16mm	4106- <u>X</u> 16	150mm	4106- <u>X</u> 150
1.2mm	4106- <u>X</u> 1D2	1.9mm	4106- <u>X</u> 1D9	16.5mm	4106- <u>X</u> 16D5		
1.21mm	4106- <u>X</u> 1D21	2mm	4106- <u>X</u> 2	17mm	4106- <u>X</u> 17		
1.22mm	4106- <u>X</u> 1D22	2.5mm	4106- <u>X</u> 2D5	17.5mm	4106- <u>X</u> 17D5		



**CUSTOM-MADE**  
CAN SUPPLY ANY SIZES FROM  
0.5 TO 100MM, SUCH AS 70.672MM



## CERAMIC INDIVIDUAL GAGE BLOCKS

**INSIZE PLUS**  
MADE IN EUROPE



4103-A80

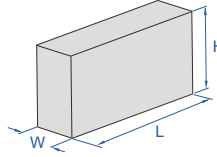

Dimension:

Size (L)	W	H
0.5 ≤ L ≤ 10mm	9mm	30mm
L > 10mm	9mm	35mm

- Grade K, 0 and 1 gage blocks are available
- Made of ceramic, extremely wear resistance and corrosion resistance
- Meet ISO3650
- Supplied with manufacturer inspection certificate

### Code explanation:

4103-X□□□□

- K for grade K
- A for grade 0
- B for grade 1

### Code examples:

Size (L)	Grade	Code
0.5mm	K	4103-KD5
10mm	0	4103-A10
10mm	1	4103-B10

Size	Code	Size	Code	Size	Code	Size	Code
0.5mm	4103-XD5	1.23mm	4103-X1D23	3mm	4103-X3	20mm	4103-X20
1mm	4103-X1	1.24mm	4103-X1D24	3.5mm	4103-X3D5	20.5mm	4103-X20D5
1.0005mm	4103-X1D0005	1.25mm	4103-X1D25	4mm	4103-X4	21mm	4103-X21
1.001mm	4103-X1D001	1.26mm	4103-X1D26	4.5mm	4103-X4D5	21.5mm	4103-X21D5
1.002mm	4103-X1D002	1.27mm	4103-X1D27	5mm	4103-X5	22mm	4103-X22
1.003mm	4103-X1D003	1.28mm	4103-X1D28	5.5mm	4103-X5D5	22.5mm	4103-X22D5
1.004mm	4103-X1D004	1.29mm	4103-X1D29	6mm	4103-X6	23mm	4103-X23
1.005mm	4103-X1D005	1.3mm	4103-X1D3	6.5mm	4103-X6D5	23.5mm	4103-X23D5
1.006mm	4103-X1D006	1.31mm	4103-X1D31	7mm	4103-X7	24mm	4103-X24
1.007mm	4103-X1D007	1.32mm	4103-X1D32	7.5mm	4103-X7D5	24.5mm	4103-X24D5
1.008mm	4103-X1D008	1.33mm	4103-X1D33	8mm	4103-X8	25mm	4103-X25
1.009mm	4103-X1D009	1.34mm	4103-X1D34	8.5mm	4103-X8D5	30mm	4103-X30
1.01mm	4103-X1D01	1.35mm	4103-X1D35	9mm	4103-X9	40mm	4103-X40
1.02mm	4103-X1D02	1.36mm	4103-X1D36	9.5mm	4103-X9D5	50mm	4103-X50
1.03mm	4103-X1D03	1.37mm	4103-X1D37	10mm	4103-X10	60mm	4103-X60
1.04mm	4103-X1D04	1.38mm	4103-X1D38	10.5mm	4103-X10D5	70mm	4103-X70
1.05mm	4103-X1D05	1.39mm	4103-X1D39	11mm	4103-X11	75mm	4103-X75
1.06mm	4103-X1D06	1.4mm	4103-X1D4	11.5mm	4103-X11D5	80mm	4103-X80
1.07mm	4103-X1D07	1.41mm	4103-X1D41	12mm	4103-X12	90mm	4103-X90
1.08mm	4103-X1D08	1.42mm	4103-X1D42	12.5mm	4103-X12D5	100mm	4103-X100
1.09mm	4103-X1D09	1.43mm	4103-X1D43	13mm	4103-X13		
1.1mm	4103-X1D1	1.44mm	4103-X1D44	13.5mm	4103-X13D5		
1.11mm	4103-X1D11	1.45mm	4103-X1D45	14mm	4103-X14		
1.12mm	4103-X1D12	1.46mm	4103-X1D46	14.5mm	4103-X14D5		
1.13mm	4103-X1D13	1.47mm	4103-X1D47	15mm	4103-X15		
1.14mm	4103-X1D14	1.48mm	4103-X1D48	15.5mm	4103-X15D5		
1.15mm	4103-X1D15	1.49mm	4103-X1D49	16mm	4103-X16		
1.16mm	4103-X1D16	1.5mm	4103-X1D5	16.5mm	4103-X16D5		
1.17mm	4103-X1D17	1.6mm	4103-X1D6	17mm	4103-X17		
1.18mm	4103-X1D18	1.7mm	4103-X1D7	17.5mm	4103-X17D5		
1.19mm	4103-X1D19	1.8mm	4103-X1D8	18mm	4103-X18		
1.2mm	4103-X1D2	1.9mm	4103-X1D9	18.5mm	4103-X18D5		
1.21mm	4103-X1D21	2mm	4103-X2	19mm	4103-X19		
1.22mm	4103-X1D22	2.5mm	4103-X2D5	19.5mm	4103-X19D5		

## STEEL GAGE BLOCK SETS

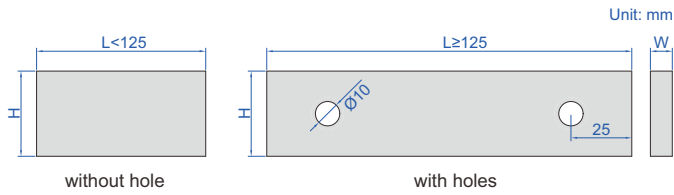

Dimension:

Size (L)	W	H
0.5 ≤ L ≤ 10mm	9mm	30mm
L > 10mm	9mm	35mm

Code example:  
"-122" stands for "4100-122"

- Made of alloy steel
- Meet ISO3650
- Gage blocks ≥ 125mm have clamping holes
- Supplied with manufacturer inspection certificate



**POPULAR MODEL**

4100-87

Blocks per set	Gage blocks included in set			Code (4100)		
	Size (mm)	Step (mm)	Quantity	Grade 0	Grade 1	Grade 2
122	1.0005		1			
	1.001-1.009	0.001	9			
	1.01-1.49	0.01	49			
	1.6-1.9	0.1	4	-122	-1122	-2122
	0.5-24.5	0.5	49			
	30-100	10	8			
	25-75	50	2			
112	1.0005		1			
	1.001-1.009	0.001	9			
	1.01-1.49	0.01	49	-112	-1112	-2112
	0.5-24.5	0.5	49			
	25-100	25	4			
103	1.005		1			
	1.01-1.49	0.01	49	-103	-1103	-2103
	0.5-24.5	0.5	49			
	25-100	25	4			
88	1.0005		1			
	1.001-1.009	0.001	9			
	1.01-1.49	0.01	49	-88	-188	-288
	0.5-9.5	0.5	19			
	10-100	10	10			
87	1.001-1.009	0.001	9			
	1.01-1.49	0.01	49	-87	-187	-287
	0.5-9.5	0.5	19			
	10-100	10	10			
83	0.5		1			
	1		1			
	1.005		1			
	1.01-1.49	0.01	49	-83	-183	-283
	1.5-1.9	0.1	5			
	2-9.5	0.5	16			
10-100	10	10				
76	1.005		1			
	1.01-1.49	0.01	49			
	0.5-9.5	0.5	19	-76	-176	-276
	10-40	10	4			
	50-100	25	3			

Blocks per set	Gage blocks included in set			Code (4100)		
	Size (mm)	Step (mm)	Quantity	Grade 0	Grade 1	Grade 2
56	0.5		1			
	1.001-1.009	0.001	9			
	1.01-1.09	0.01	9	-56	-156	-256
	1.1-1.9	0.1	9			
	1-24	1	24			
	25-100	25	4			
47	1.005		1			
	1.01-1.09	0.01	9			
	1.1-1.9	0.1	9	-47A	-147A	-247A
	1-24	1	24			
47	1.005		1			
	1.01-1.19	0.01	19			
	1.2-1.9	0.1	8	-47	-147	-247
	1-9	1	9			
	10-100	10	10			
46	1.001-1.009	0.001	9			
	1.01-1.09	0.01	9			
	1.1-1.9	0.1	9	-46	-146	-246
	1-9	1	9			
	10-100	10	10			
34	1.0005		1			
	1.001-1.009	0.001	9			
	1.01-1.09	0.01	9	-34	-134	-234
	1.1-1.9	0.1	9			
	1-5	1	5			
	10		1			
32	1.005		1			
	1.01-1.09	0.01	9			
	1.1-1.9	0.1	9			
	1-9	1	9	-32	-132	-232
	10-30	10	3			
	50		1			
9	1.001-1.009	0.001	9	-9	-19	-29
9	0.991-0.999	0.001	9	-9A	-19A	-29A
8	125-175	25	3			
	200-250	50	2	-8	-18	-28
	300-500	100	3			

**CUSTOM-MADE**  
CAN SUPPLY ANY SIZES FROM  
0.5 TO 1000MM, SUCH AS 72.672MM



## STEEL INDIVIDUAL GAGE BLOCKS



4101-A70



4101-A200

Unit: mm

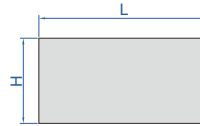

without hole

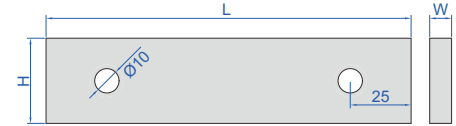

with holes

- Grade 0, 1 and 2 gage blocks are available
- Made of alloy steel
- Meet ISO3650
- Gage blocks with clamping holes: 125, 150, 175, 200, 250, 300, 400, 500, 600, 700, 800, 900, 1000mm
- Supplied with manufacturer inspection certificate

### Code explanation:

4101-X□□□□□

- A for grade 0
- B for grade 1
- C for grade 2

### Code examples:

Size (L)	Grade	Code
0.5mm	0	4101-AD5
1mm	1	4101-B1
10.5mm	2	4101-C10D5

### Dimension:

Size (L)	W	H
0.5 ≤ L ≤ 10mm	9mm	30mm
L > 10mm	9mm	35mm

Size	Code	Size	Code	Size	Code	Size	Code
0.5mm	4101-XD5	1.19mm	4101-X1D19	3.5mm	4101-X3D5	20.2mm	4101-X20D2
0.991mm	4101-XD991	1.2mm	4101-X1D2	4mm	4101-X4	20.5mm	4101-X20D5
0.992mm	4101-XD992	1.21mm	4101-X1D21	4.5mm	4101-X4D5	21mm	4101-X21
0.993mm	4101-XD993	1.22mm	4101-X1D22	5mm	4101-X5	21.5mm	4101-X21D5
0.994mm	4101-XD994	1.23mm	4101-X1D23	5.1mm	4101-X5D1	22mm	4101-X22
0.995mm	4101-XD995	1.24mm	4101-X1D24	5.5mm	4101-X5D5	22.5mm	4101-X22D5
0.996mm	4101-XD996	1.25mm	4101-X1D25	6mm	4101-X6	22.8mm	4101-X22D8
0.997mm	4101-XD997	1.26mm	4101-X1D26	6.5mm	4101-X6D5	23mm	4101-X23
0.998mm	4101-XD998	1.27mm	4101-X1D27	7mm	4101-X7	23.5mm	4101-X23D5
0.999mm	4101-XD999	1.28mm	4101-X1D28	7.5mm	4101-X7D5	24mm	4101-X24
1mm	4101-X1	1.29mm	4101-X1D29	7.7mm	4101-X7D7	24.5mm	4101-X24D5
1.0005mm	4101-X1D0005	1.3mm	4101-X1D3	8mm	4101-X8	25mm	4101-X25
1.001mm	4101-X1D001	1.31mm	4101-X1D31	8.5mm	4101-X8D5	30mm	4101-X30
1.002mm	4101-X1D002	1.32mm	4101-X1D32	9mm	4101-X9	35mm	4101-X35
1.003mm	4101-X1D003	1.33mm	4101-X1D33	9.5mm	4101-X9D5	40mm	4101-X40
1.004mm	4101-X1D004	1.34mm	4101-X1D34	10mm	4101-X10	41.3mm	4101-X41D3
1.005mm	4101-X1D005	1.35mm	4101-X1D35	10.3mm	4101-X10D3	45mm	4101-X45
1.006mm	4101-X1D006	1.36mm	4101-X1D36	10.5mm	4101-X10D5	50mm	4101-X50
1.007mm	4101-X1D007	1.37mm	4101-X1D37	11mm	4101-X11	60mm	4101-X60
1.008mm	4101-X1D008	1.38mm	4101-X1D38	11.5mm	4101-X11D5	70mm	4101-X70
1.009mm	4101-X1D009	1.39mm	4101-X1D39	12mm	4101-X12	75mm	4101-X75
1.01mm	4101-X1D01	1.4mm	4101-X1D4	12.5mm	4101-X12D5	80mm	4101-X80
1.02mm	4101-X1D02	1.41mm	4101-X1D41	12.9mm	4101-X12D9	90mm	4101-X90
1.03mm	4101-X1D03	1.42mm	4101-X1D42	13mm	4101-X13	100mm	4101-X100
1.04mm	4101-X1D04	1.43mm	4101-X1D43	13.5mm	4101-X13D5	125mm	4101-X125
1.05mm	4101-X1D05	1.44mm	4101-X1D44	14mm	4101-X14	131.4mm	4101-X131D4
1.06mm	4101-X1D06	1.45mm	4101-X1D45	14.5mm	4101-X14D5	150mm	4101-X150
1.07mm	4101-X1D07	1.46mm	4101-X1D46	15mm	4101-X15	175mm	4101-X175
1.08mm	4101-X1D08	1.47mm	4101-X1D47	15.5mm	4101-X15D5	200mm	4101-X200
1.09mm	4101-X1D09	1.48mm	4101-X1D48	16mm	4101-X16	250mm	4101-X250
1.1mm	4101-X1D1	1.49mm	4101-X1D49	16.5mm	4101-X16D5	300mm	4101-X300
1.11mm	4101-X1D11	1.5mm	4101-X1D5	17mm	4101-X17	400mm	4101-X400
1.12mm	4101-X1D12	1.6mm	4101-X1D6	17.5mm	4101-X17D5	500mm	4101-X500
1.13mm	4101-X1D13	1.7mm	4101-X1D7	17.6mm	4101-X17D6	600mm	4101-X600
1.14mm	4101-X1D14	1.8mm	4101-X1D8	18mm	4101-X18	700mm	4101-X700
1.15mm	4101-X1D15	1.9mm	4101-X1D9	18.5mm	4101-X18D5	750mm	4101-X750
1.16mm	4101-X1D16	2mm	4101-X2	19mm	4101-X19	800mm	4101-X800
1.17mm	4101-X1D17	2.5mm	4101-X2D5	19.5mm	4101-X19D5	900mm	4101-X900
1.18mm	4101-X1D18	3mm	4101-X3	20mm	4101-X20	1000mm	4101-X1000

## STEEL INDIVIDUAL GAGE BLOCKS

**INSIZE PLUS**  
MADE IN EUROPE

INSPECTION  
CERTIFICATE

CUSTOM-MADE  
CAN SUPPLY ANY SIZES FROM  
0.1 TO 1000MM, SUCH AS 72.672MM



4104-A70



4104-A200

### Code explanation:

4104-X□□□□□

- K for grade K
- A for grade 0
- B for grade 1

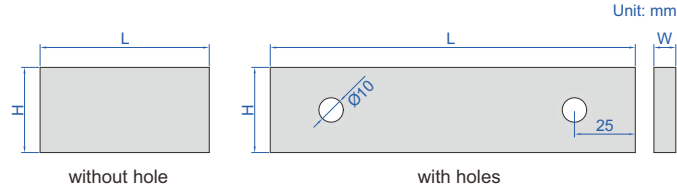

### Code examples:

Size (L)	Grade	Code
0.5mm	K	4104-KD5
1mm	0	4104-A1
10.5mm	1	4104-B10D5

Dimension:

Size (L)	W	H
0.5 ≤ L ≤ 10mm	9mm	30mm
L > 10mm	9mm	35mm

- Grade K, 0 and 1 gage blocks are available
- Made of alloy steel
- Meet ISO3650
- Gage blocks with clamping holes: 125, 150, 175, 200, 250, 300, 400, 500, 600, 700, 800, 900, 1000mm
- Supplied with manufacturer inspection certificate

Size	Code
0.1mm	4104-XD1
0.2mm	4104-XD2
0.3mm	4104-XD3
0.4mm	4104-XD4
0.5mm	4104-XD5
1mm	4104-X1
1.0005mm	4104-X1D0005
1.001mm	4104-X1D001
1.002mm	4104-X1D002
1.003mm	4104-X1D003
1.004mm	4104-X1D004
1.005mm	4104-X1D005
1.006mm	4104-X1D006
1.007mm	4104-X1D007
1.008mm	4104-X1D008
1.009mm	4104-X1D009
1.01mm	4104-X1D01
1.02mm	4104-X1D02
1.03mm	4104-X1D03
1.04mm	4104-X1D04
1.05mm	4104-X1D05
1.06mm	4104-X1D06
1.07mm	4104-X1D07
1.08mm	4104-X1D08
1.09mm	4104-X1D09
1.1mm	4104-X1D1
1.11mm	4104-X1D11
1.12mm	4104-X1D12
1.13mm	4104-X1D13
1.14mm	4104-X1D14
1.15mm	4104-X1D15
1.16mm	4104-X1D16
1.17mm	4104-X1D17
1.18mm	4104-X1D18
1.19mm	4104-X1D19
1.2mm	4104-X1D2

Size	Code
1.21mm	4104-X1D21
1.22mm	4104-X1D22
1.23mm	4104-X1D23
1.24mm	4104-X1D24
1.25mm	4104-X1D25
1.26mm	4104-X1D26
1.27mm	4104-X1D27
1.28mm	4104-X1D28
1.29mm	4104-X1D29
1.3mm	4104-X1D3
1.31mm	4104-X1D31
1.32mm	4104-X1D32
1.33mm	4104-X1D33
1.34mm	4104-X1D34
1.35mm	4104-X1D35
1.36mm	4104-X1D36
1.37mm	4104-X1D37
1.38mm	4104-X1D38
1.39mm	4104-X1D39
1.4mm	4104-X1D4
1.41mm	4104-X1D41
1.42mm	4104-X1D42
1.43mm	4104-X1D43
1.44mm	4104-X1D44
1.45mm	4104-X1D45
1.46mm	4104-X1D46
1.47mm	4104-X1D47
1.48mm	4104-X1D48
1.49mm	4104-X1D49
1.5mm	4104-X1D5
1.6mm	4104-X1D6
1.7mm	4104-X1D7
1.8mm	4104-X1D8
1.9mm	4104-X1D9
2mm	4104-X2
2.5mm	4104-X2D5

Size	Code
3mm	4104-X3
3.5mm	4104-X3D5
4mm	4104-X4
4.5mm	4104-X4D5
5mm	4104-X5
5.5mm	4104-X5D5
6mm	4104-X6
6.5mm	4104-X6D5
7mm	4104-X7
7.5mm	4104-X7D5
8mm	4104-X8
8.5mm	4104-X8D5
9mm	4104-X9
9.5mm	4104-X9D5
10mm	4104-X10
10.5mm	4104-X10D5
11mm	4104-X11
11.5mm	4104-X11D5
12mm	4104-X12
12.5mm	4104-X12D5
13mm	4104-X13
13.5mm	4104-X13D5
14mm	4104-X14
14.5mm	4104-X14D5
15mm	4104-X15
15.5mm	4104-X15D5
16mm	4104-X16
16.5mm	4104-X16D5
17mm	4104-X17
17.5mm	4104-X17D5
18mm	4104-X18
18.5mm	4104-X18D5
19mm	4104-X19
19.5mm	4104-X19D5
20mm	4104-X20
20.5mm	4104-X20D5

Size	Code
21mm	4104-X21
21.5mm	4104-X21D5
22mm	4104-X22
22.5mm	4104-X22D5
23mm	4104-X23
23.5mm	4104-X23D5
24mm	4104-X24
24.5mm	4104-X24D5
25mm	4104-X25
30mm	4104-X30
40mm	4104-X40
50mm	4104-X50
60mm	4104-X60
70mm	4104-X70
75mm	4104-X75
80mm	4104-X80
90mm	4104-X90
100mm	4104-X100
125mm	4104-X125
131.4mm	4104-X131D4
150mm	4104-X150
175mm	4104-X175
200mm	4104-X200
243.5mm	4104-X243D5
250mm	4104-X250
281.2mm	4104-X281D2
300mm	4104-X300
400mm	4104-X400
481.1mm	4104-X481D1
500mm	4104-X500
550mm	4104-X550
600mm	4104-X600
700mm	4104-X700
800mm	4104-X800
900mm	4104-X900
1000mm	4104-X1000



## CARBIDE GAGE BLOCK SETS



4164-32

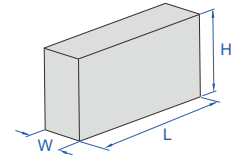

- Made of carbide, extremely wear resistance and corrosion resistance, excellent dimension stability
- Meet ISO3650
- Supplied with manufacturer inspection certificate

Dimension:

Size (L)	W	H
0.5 ≤ L ≤ 10mm	9mm	30mm
L > 10mm	9mm	35mm

Blocks per set	Gage blocks included in set			Code	
	Size (mm)	Step (mm)	Quantity	Grade 0	Grade 1
122	1.0005		1	4164-122	4164-1122
	1.001-1.009	0.001	9		
	1.01-1.49	0.01	49		
	1.6-1.9	0.1	4		
	0.5-24.5	0.5	49		
	30-100	10	8		
	25-75	50	2		
112	1.0005		1	4164-112	4164-1112
	1.001-1.009	0.001	9		
	1.01-1.49	0.01	49		
	0.5-24.5	0.5	49		
	25-100	25	4		
103	1.005		1	4164-103	4164-1103
	1.01-1.49	0.01	49		
	0.5-24.5	0.5	49		
	25-100	25	4		
87	1.001-1.009	0.001	9	4164-87	4164-187
	1.01-1.49	0.01	49		
	0.5-9.5	0.5	19		
	10-100	10	10		
83	0.5		1	4164-83	4164-183
	1		1		
	1.005		1		
	1.01-1.49	0.01	49		
	1.5-1.9	0.1	5		
	2-9.5	0.5	16		
	10-100	10	10		

Blocks per set	Gage blocks included in set			Code	
	Size (mm)	Step (mm)	Quantity	Grade 0	Grade 1
76	1.005		1	4164-76	4164-176
	1.01-1.49	0.01	49		
	0.5-9.5	0.5	19		
	10-40	10	4		
47	50-100	25	3	4164-47A	4164-147A
	1.005		1		
	1.01-1.09	0.01	9		
	1.1-1.9	0.1	9		
47	1-24	1	24	4164-47	4164-147
	25-100	25	4		
	1.005		1		
	1.01-1.19	0.01	19		
47	1.2-1.9	0.1	8	4164-47	4164-147
	1-9	1	9		
	10-100	10	10		
	1.001-1.009	0.001	9		
46	1.01-1.09	0.01	9	4164-46	4164-146
	1.1-1.9	0.1	9		
	1-9	1	9		
	10-100	10	10		
32	1.005		1	4164-32	4164-132
	1.01-1.09	0.01	9		
	1.1-1.9	0.1	9		
	1-9	1	9		
	10-30	10	3		
	50		1		

## CALIPER INSPECTION GAGE BLOCK SET



4108-3005

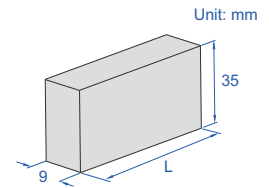

- Meet ISO3650/grade 2
- Supplied with manufacturer inspection certificate

Code	Material	Gage blocks included in set (L)	Applicable calipers
4108-3005	alloy steel	30, 41.3, 131.4, 243.5, 281.2	0-150, 0-200, 0-300

(mm)

## MICROMETER INSPECTION GAGE BLOCK SETS



4107-10

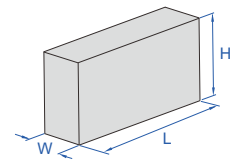

- One piece of optical flat is included in 4107-10 and 4107-101
- Meet ISO3650/grade 0
- Supplied with manufacturer inspection certificate

Dimension:

Size (L)	W	H
0.5 ≤ L ≤ 10mm	9mm	30mm
L > 10mm	9mm	35mm

Code	Material	Gage blocks included in set (mm)	Applicable micrometer	Optical flat
4107-10	ceramic	2.5, 5.1, 7.7, 10.3, 12.9, 15, 17.6, 20.2, 22.8, 25, optical flat	0-25mm	included
4107-101	alloy steel	2.5, 5.1, 7.7, 10.3, 12.9, 15, 17.6, 20.2, 22.8, 25, optical flat	0-25mm	included
4107-112	alloy steel	25, 27.5, 30.1, 32.7, 35.3, 37.9, 40, 42.6, 45.2, 47.8, 50	25-50mm	not included
4107-113	alloy steel	50, 52.5, 55.1, 57.7, 60.3, 62.9, 65, 67.6, 70.2, 72.8, 75	50-75mm	not included
4107-114	alloy steel	75, 77.5, 80.1, 82.7, 85.3, 87.9, 90, 92.6, 95.2, 97.8, 100	75-100mm	not included
4107-115	alloy steel	5.12, 10.24, 15.36, 21.5, 25, 30.12, 35.24, 40.36, 46.5, 50, 55.12, 60.24, 65.36, 71.5, 75, 80.12, 85.24, 90.36, 96.5, 100	0-100mm	not included



## MICROMETER INSPECTION GAGE BLOCK SET

application



4160-10

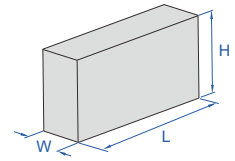

Dimension:

Size (L)	W	H
0.5 ≤ L ≤ 10mm	9mm	30mm
L > 10mm	9mm	35mm

optical flat (included)



- Meet ISO3650/grade 0
- One piece of optical flat is included (size Ø30x12mm)
- Supplied with manufacturer inspection certificate

Code	Material	Gage blocks included in set	Applicable micrometer
4160-10	alloy steel	2.5mm, 5.1mm, 7.7mm, 10.3mm, 12.9mm, 15mm, 17.6mm, 20.2mm, 22.8mm, 25mm	0-25mm

## GAGE BLOCK HOLDERS

- Made of aluminum
- To be used with individual steel gage blocks (code 4101) as Go and No-Go gage

Code	Applicable gage block size
6883-1	1.5-5mm
6883-2	5-10mm
6883-3	10-15mm
6883-4	15-20mm
6883-5	20-25mm



6883-4

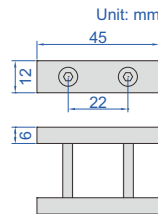

to be used as Go and No-Go gage



VIDEO

## GAGE BLOCK HOLDER

- For gage blocks over 125mm with clamping holes
- Optional accessory: gage block holder accessory, gage block accessory (code 6881)

Code  
6886-1



6886-1

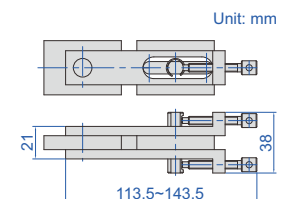

## GAGE BLOCK HOLDER ACCESSORY

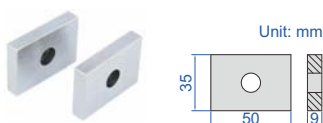

Code  
6886-A

6886-A

application

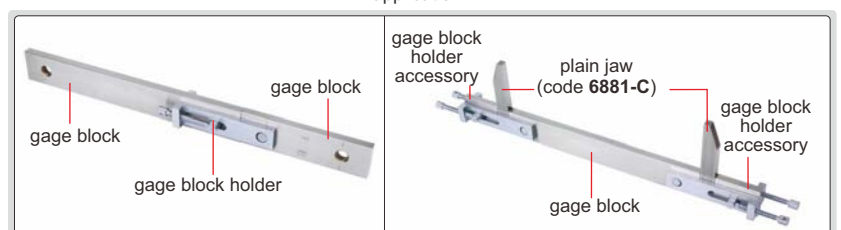

## GAGE BLOCK ACCESSORIES



VIDEO

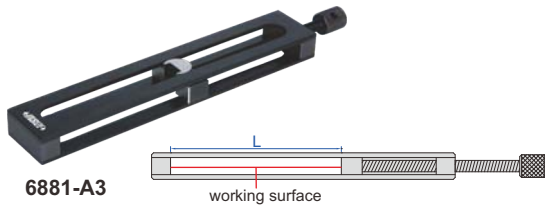

6881-A3

Code	Name	Clamping range* (L)
6881-A1	holder	0-25mm
6881-A2	holder	25-50mm
6881-A3	holder	50-100mm
6881-A4	holder	100-200mm
6881-A5	holder	200-300mm
6881-A6**	holder	300-500mm
6881-A7**	holder	500-750mm
6881-A8**	holder	750-1000mm

\*The actual clamping range should deduct the width of jaws  
 \*\*Not suitable for base 6881-B

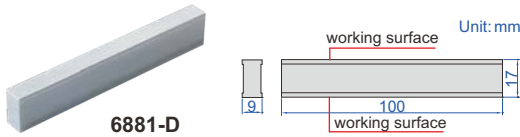

6881-D

Code	Name	Remark
6881-D	parallel jaw	made of carbide



6881-S17

### GAGE BLOCK ACCESSORY SET

Code	Remark
6881-S17	17 pcs (including below items)

holder, 0-25mm (code 6881-A1)	1 pc
holder, 25-50mm (code 6881-A2)	1 pc
holder, 50-100mm (code 6881-A3)	1 pc
holder, 100-200mm (code 6881-A4)	1 pc
holder, 200-300mm (code 6881-A5)	1 pc
base (code 6881-B)	1 pc
plain jaw (code 6881-C)	1 pair
parallel jaw (code 6881-D)	1 pc
half round jaw, 2.5mm (code 6881-E1)	1 pair
half round jaw, 5.0mm (code 6881-E2)	1 pair
half round jaw, 6.0mm (code 6881-E3)	1 pair
scraper (code 6881-F)	1 pc
centre point (code 6881-G)	1 pc



6881-B

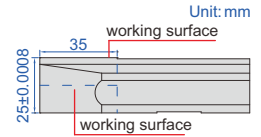

6881-E2

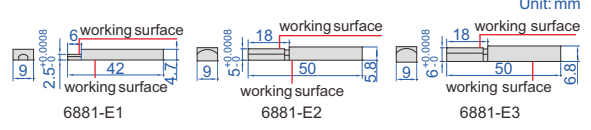

Code	Name	Size	Remark
6881-E1	half round jaw	2.5mm	made of carbide, supplied in pair
6881-E2	half round jaw	5.0mm	made of carbide, supplied in pair
6881-E3	half round jaw	6.0mm	made of carbide, supplied in pair



6881-C

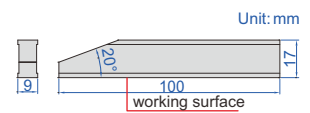

Code	Name	Remark
6881-C	plain jaw	made of carbide, supplied in pair



6881-F

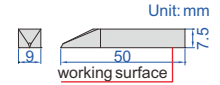

Code	Name	Remark
6881-F	scraper	made of carbide



6881-G

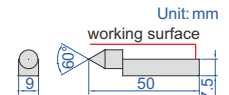

Code	Name	Remark
6881-G	centre point	the tip is made of carbide

### application

<p>(plain jaw+holder) set zero for bore gage and inside micrometers</p>	<p>(base+holder+scraper) measure height or scribe</p>	<p>(half round jaw+holder) measure inside diameter</p>
<p>(scraper+centre point+holder) scribe circle</p>	<p>(plain jaw+parallel jaw+holder) Go and No Go inspection</p>	



**CUSTOM-MADE**  
CAN SUPPLY ANY LENGTH, SUCH AS 80.672MM

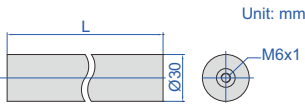

- Made of special alloy steel, hardness HRC64, high stability, wear resistance and easy combination
- Meet ISO3650 grade 1
- Can be connected with M6x1 screw and combined to any sizes up to 4m

can be combined to any sizes up to 4m

Combination 1: combined by several standard size cylinder gage blocks and one custom size cylinder gage block  
For example: 500 (standard) + 200 (standard) + 25.832 (custom)=725.832mm  
Note: in order to reduce cost, custom size should be within 100mm

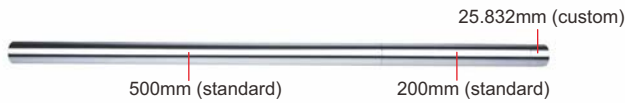

Combination 2: combined by standard size cylinder gage blocks and rectangular gage blocks  
For example: 500 (cylinder) + 200 (cylinder) + 21.5 (rectangular) + 2.33 (rectangular) + 2.002 (rectangular)=725.832mm

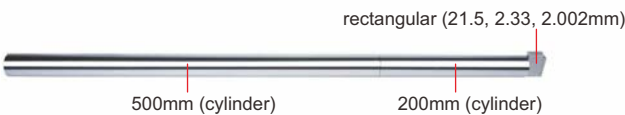

## CYLINDER GAGE BLOCKS

**INSPECTION**  
**CERTIFICATE**

Code	Length (L)
4001-25 *	25mm
4001-50 *	50mm
4001-75 *	75mm
4001-100 *	100mm
4001-200 *	200mm
4001-300 *	300mm
4001-400 *	400mm
4001-500 *	500mm

\* Supplied with manufacturer inspection certificate



high stability in vertical position,  
suitable for checking height gages



connected with M6x1mm screw

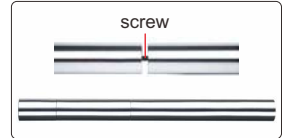

## INTERNAL BLOCKS

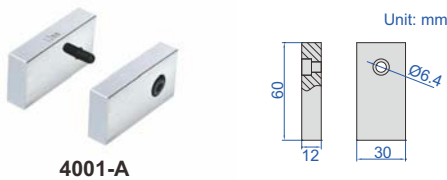

4001-A

- Can be attached to cylinder and rectangular gage blocks
- Made of special alloy steel, hardness HRC64, high stability, wear resistance and easy combination
- Supplied in a matched pair

Code	Size	Flatness
4001-A	12mm	0.2µm

Combination 1: combined by several standard size cylinder gage blocks and one custom size cylinder gage block  
For example: 500 (standard) + 200 (standard) + 25.832 (custom)=725.832mm  
Note: in order to reduce cost, custom size should be within 100mm



Combination 2: combined by standard size cylinder gage blocks and rectangular gage blocks  
For example: 500 (cylinder) + 200 (cylinder) + 50 (rectangular) - 20 (rectangular) - 2.16 (rectangular) - 2.008 (rectangular)=725.832mm

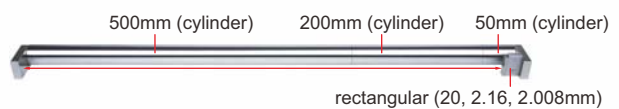

## BASE

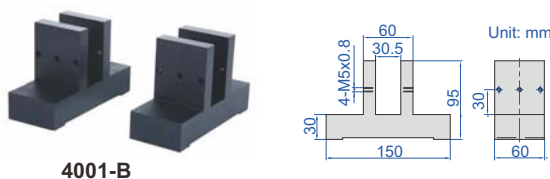

4001-B

Code	Remark
4001-B	supplied in pair

working with base

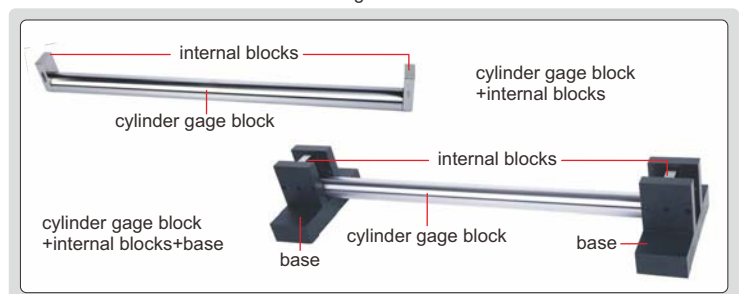

## CMM CHECK MASTERS



6882-600A

- To check the accuracy of table movements of machine tools and calibrate CMM
- Horizontal use and vertical use
- Constructed with ceramic gage blocks
- Can be used with stand

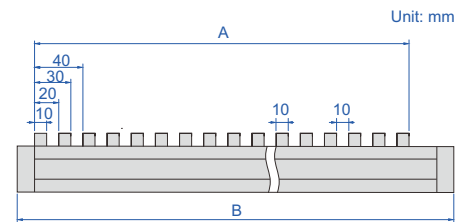

### Standard accuracy

Code	Size	Step	A	B
6882-300A *	0-300mm	10mm	310mm	350mm
6882-400A *	0-400mm	10mm	410mm	450mm
6882-500A *	0-500mm	10mm	510mm	550mm
6882-600A *	0-600mm	10mm	610mm	650mm
6882-1000A *	0-1000mm	10mm	1010mm	1050mm

### High accuracy

Code	Size	Step	A	B
6882-300H *	0-300mm	10mm	310mm	350mm
6882-400H *	0-400mm	10mm	410mm	450mm
6882-500H *	0-500mm	10mm	510mm	550mm
6882-600H *	0-600mm	10mm	610mm	650mm
6882-1000H *	0-1000mm	10mm	1010mm	1050mm

\* Supplied with manufacturer inspection certificate



horizontal use

14

### Accuracy

Range (mm)	Standard accuracy	High accuracy
≤300	±1.3μm	±0.8μm
>300, ≤400	±1.6μm	±1.0μm
>400, ≤500	±2.0μm	±1.0μm
>500, ≤600	±2.5μm	±1.0μm
>600, ≤800	±3.0μm	±2.5μm
>800, ≤1000	±4.0μm	±2.5μm

### Stand (optional)

Code	Applicable check masters
6882-S1	6882-300A, 6882-300H
6882-S2	6882-400A, 6882-400H
6882-S3	6882-500A, 6882-500H
6882-S4	6882-600A, 6882-600H
6882-S5	6882-1000A, 6882-1000H



can be used with stand (optional)

# CMM CHECK MASTERS (ADVANCED TYPE)



6874-1000

- To check the accuracy of table movements of machine tools and calibrate CMM
- Horizontal use and vertical use
- Constructed with ceramic gage blocks
- Can be used with stand

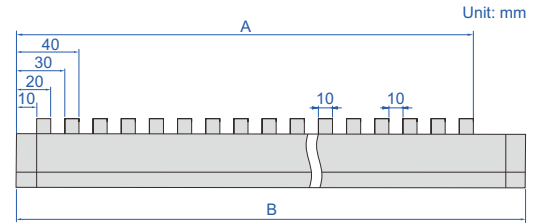

Code	Size	Step	A	B
6874-300 *	0-300mm	10mm	320mm	345mm
6874-450 *	0-450mm	10mm	470mm	495mm
6874-600 *	0-600mm	10mm	620mm	645mm
6874-1000 *	0-1000mm	10mm	1020mm	1045mm

\* Supplied with ISO17025 calibration certificate of Shenzhen Institute of Metrology&Quality Inspection (SMQ)

### Accuracy

Range (mm)	Accuracy	Work face size variation
≤100	±1.0μm	0.5μm
>100, ≤200	±1.1μm	0.5μm
>200, ≤300	±1.3μm	0.6μm
>300, ≤400	±1.6μm	0.7μm
>400, ≤500	±2.0μm	0.8μm
>500, ≤600	±2.5μm	1.0μm
>600, ≤800	±3.0μm	1.4μm
>800, ≤1000	±4.0μm	1.8μm

### Stand (optional)

Code	Applicable check masters
6874-A	6874-300, 6874-450, 6874-600
6874-B	6874-1000



ISO17025 calibration certificate



can be used with stand (optional)

## CALIPER/HEIGHT GAGE CHECKERS

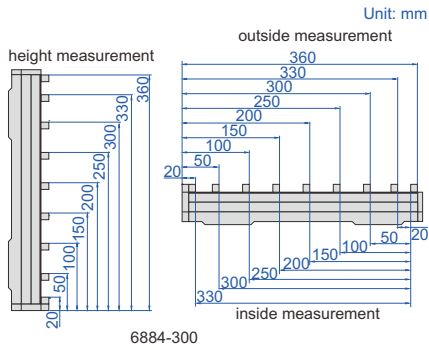

horizontal use



vertical use

6884-300

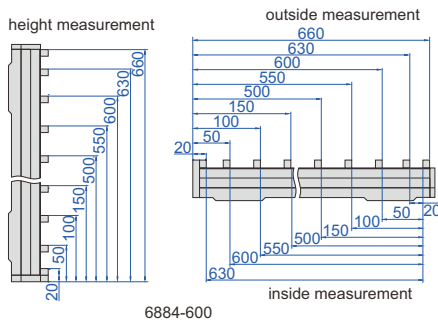

- To check calipers and height gages
- Constructed with steel gage blocks

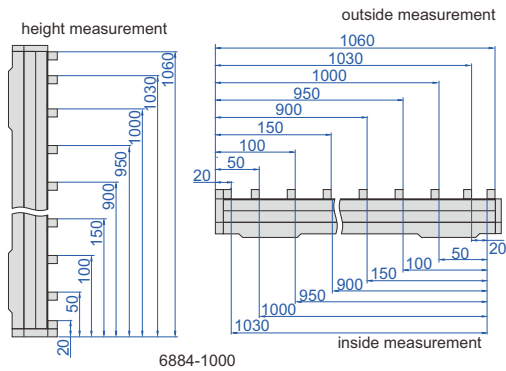

check upper jaws of calipers

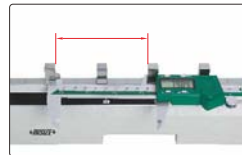

check lower jaws of calipers

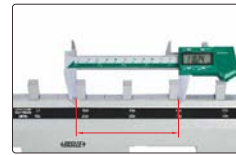

check height gages



Code	Size	Range of inside measurement	Range of outside measurement	Range of height measurement	Accuracy (mm)
6884-300*	0-300mm	20, 50, 100, 150, 200, 250, 300, 330	20, 50, 100, 150, 200, 250, 300, 330, 360	20, 50, 100, 150, 200, 250, 300, 330, 360	±3µm
6884-600*	0-600mm	20, 50, 100, 150, 200, 250, 300, 350, 400, 450, 500, 550, 600, 630	20, 50, 100, 150, 200, 250, 300, 350, 400, 450, 500, 550, 600, 630, 660	20, 50, 100, 150, 200, 250, 300, 350, 400, 450, 500, 550, 600, 630, 660	±5µm
6884-1000*	0-1000mm	20, 50, 100, 150, 200, 250, 300, 350, 400, 450, 500, 550, 600, 650, 700, 750, 800, 850, 900, 950, 1000, 1030	20, 50, 100, 150, 200, 250, 300, 350, 400, 450, 500, 550, 600, 650, 700, 750, 800, 850, 900, 950, 1000, 1030, 1060	20, 50, 100, 150, 200, 250, 300, 350, 400, 450, 500, 550, 600, 650, 700, 750, 800, 850, 900, 950, 1000, 1030, 1060	±7µm

\*Supplied with manufacturer inspection certificate

## INSIDE MICROMETER ACCESSORY

- Supplied with a pair of 5mm carbide gage blocks

Code

6884-A10\*

\*Supplied with manufacturer inspection certificate



6884-A10

set inside micrometers

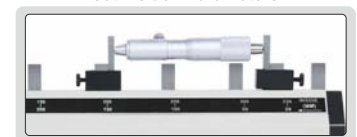

## ANGLE GAGE BLOCKS



combination

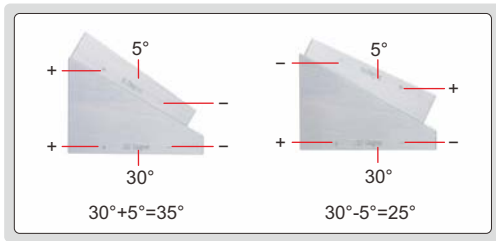

4002-15

- Accuracy:  $\pm 2''$
- To inspect protractor, taper gage, index plate, index head and goniometer, can also be used to set angle
- Made of special alloy steel, hardness HRC64, high stability, wear resistance and easy combination
- Can be combined to any angle with interval 6 seconds after combination (6", 12", 18", ... , 360°)

### Individual

Code	Angle ( $\alpha$ )	H (mm)
4002-A1 *	1°	11.5
4002-A3 *	3°	14.0
4002-A5 *	5°	16.5
4002-A9 *	9°	22.0
4002-A15 *	15°	30.5
4002-A27 *	27°	48.0
4002-A30 *	30°	53.5
4002-A41 *	41°	75.0
4002-A45 *	45°	84.0
4002-B1 *	1'	10.0
4002-B3 *	3'	10.0
4002-B5 *	5'	10.0
4002-B9 *	9'	10.0
4002-B20 *	20'	10.0
4002-B27 *	27'	10.0
4002-B30 *	30'	10.0
4002-C6 *	6"	10.0
4002-C12 *	12"	10.0
4002-C18 *	18"	10.0
4002-C30 *	30"	10.0
4002-D *	90°/90°/90°/90°	75.0

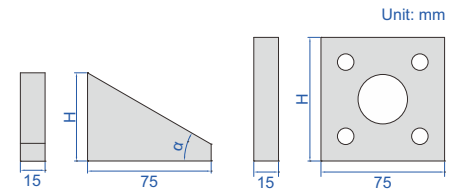

inspect angle



set angle of plate



### Set

Code	Angle ( $\alpha$ )	Total quantity
4002-13 *	1°, 3°, 9°, 27°, 41°, 1', 3', 9', 27', 6", 18", 30", 90°/90°/90°/90°	13
4002-15 *	1°, 3°, 5°, 15°, 30°, 45°, 1', 3', 5', 20', 30', 6", 12", 30", 90°/90°/90°/90°	15

\* Supplied with manufacturer inspection certificate

## ANGLE BLOCK SET

- For angle set-up in tooling, production and inspection
- Accuracy of angle:  $\pm 9$  seconds
- Made of alloy steel
- Hardness HRC60 $\pm 2$

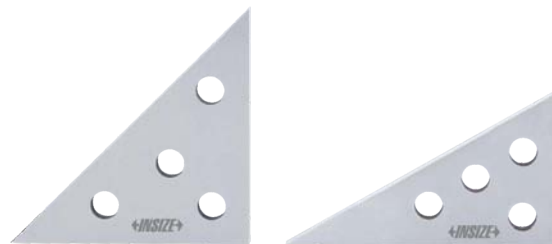

6540-1

Code	Angle plates included	Angle
6540-1	2	45°, 45°, 90°
		30°, 60°, 90°

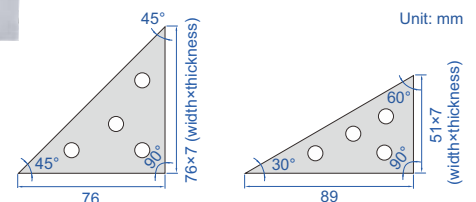

## CARBIDE PIN GAGE SETS

- Meet DIN2269, grade 1
- Made of carbide
- Hardness HRA90-90.5
- Diameter accuracy:  $\pm 1\mu\text{m}$



4194-10D

Code	Diameter $\varnothing d$ (mm)	Step	Pin gages per set
4194-1S	0.30, 0.31, 0.32, ..., 1.00	0.01mm	71
4194-2S	1.00, 1.01, 1.02, ..., 2.00	0.01mm	101
4194-3S	2.00, 2.01, 2.02, ..., 3.00	0.01mm	101
4194-4S	3.00, 3.01, 3.02, ..., 4.00	0.01mm	101
4194-5S	4.00, 4.01, 4.02, ..., 5.00	0.01mm	101
4194-6S	5.00, 5.01, 5.02, ..., 6.00	0.01mm	101
4194-7S	6.00, 6.01, 6.02, ..., 7.00	0.01mm	101
4194-8S	7.00, 7.01, 7.02, ..., 8.00	0.01mm	101
4194-9S	8.00, 8.01, 8.02, ..., 9.00	0.01mm	101
4194-10S	9.00, 9.01, 9.02, ..., 10.00	0.01mm	101
4194-10D	10.00, 10.01, 10.02, ..., 10.50	0.01mm	51
4194-11	10.50, 10.51, 10.52, ..., 11.00	0.01mm	51
4194-11D	11.00, 11.01, 11.02, ..., 11.50	0.01mm	51
4194-12	11.50, 11.51, 11.52, ..., 12.00	0.01mm	51
4194-12D	12.00, 12.01, 12.02, ..., 12.50	0.01mm	51
4194-13	12.50, 12.51, 12.52, ..., 13.00	0.01mm	51
4194-13D	13.00, 13.01, 13.02, ..., 13.50	0.01mm	51
4194-14	13.50, 13.51, 13.52, ..., 14.00	0.01mm	51
4194-14D	14.00, 14.01, 14.02, ..., 14.50	0.01mm	51
4194-15	14.50, 14.51, 14.52, ..., 15.00	0.01mm	51

Unit: mm



## CARBIDE INDIVIDUAL PIN GAGES



14

- Meet DIN2269, grade 1
- Diameter range:  $\varnothing 0.300\text{--}\varnothing 30.000\text{mm}$  with three decimal, for example 0.311mm, 5.562mm, 16.298mm
- Diameter accuracy:  $\pm 1\mu\text{m}$
- Made of carbide
- Hardness HRA90-90.5
- Optional accessory: wooden box (code 7340)



4193-8D015

Unit: mm

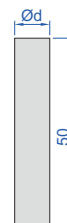

### Ordering examples:

Diameter	Code
0.311mm	4193-0D311
5.562mm	4193-5D562
16.298mm	4193-16D298

Note: "D" stands for "."

Code	Diameter range $\varnothing d$ (mm)
4193-□□□□*	0.300~30.000

\* Supplied with manufacturer inspection certificate



**POPULAR  
MODEL**

## STEEL PIN GAGE SETS

- Meet DIN2269, grade 1
- Made of alloy steel
- Hardness HRC62-65
- Diameter accuracy:  $\pm 1\mu\text{m}$



4166-10

Code	Diameter $\varnothing d$ (mm)	Step	Pin gages per set
4166-2S	1.00, 1.01, 1.02, ..., 2.00	0.01mm	101
4166-3S	2.00, 2.01, 2.02, ..., 3.00	0.01mm	101
4166-4S	3.00, 3.01, 3.02, ..., 4.00	0.01mm	101
4166-5S	4.00, 4.01, 4.02, ..., 5.00	0.01mm	101
4166-6S	5.00, 5.01, 5.02, ..., 6.00	0.01mm	101
4166-7S	6.00, 6.01, 6.02, ..., 7.00	0.01mm	101
4166-8S	7.00, 7.01, 7.02, ..., 8.00	0.01mm	101
4166-9S	8.00, 8.01, 8.02, ..., 9.00	0.01mm	101
4166-10S	9.00, 9.01, 9.02, ..., 10.00	0.01mm	101

Code	Diameter $\varnothing d$ (mm)	Step	Pin gages per set
4166-411	1.0, 1.1, 1.2, ..., 5.0	0.1mm	41
4166-511	5.0, 5.1, 5.2, ..., 10.0	0.1mm	51
4166-512	10.0, 10.1, 10.2, ..., 15.0	0.1mm	51
4166-513	15.0, 15.1, 15.2, ..., 20.0	0.1mm	51

Code	Diameter $\varnothing d$ (mm)	Step	Pin gages per set
4166-0D	0.20, 0.21, 0.22, ..., 0.50	0.01mm	31
4166-1	0.50, 0.51, 0.52, ..., 1.00	0.01mm	51
4166-1D	1.00, 1.01, 1.02, ..., 1.50	0.01mm	51
4166-2	1.50, 1.51, 1.52, ..., 2.00	0.01mm	51
4166-2D	2.00, 2.01, 2.02, ..., 2.50	0.01mm	51
4166-3	2.50, 2.51, 2.52, ..., 3.00	0.01mm	51
4166-3D	3.00, 3.01, 3.02, ..., 3.50	0.01mm	51
4166-4	3.50, 3.51, 3.52, ..., 4.00	0.01mm	51
4166-4D	4.00, 4.01, 4.02, ..., 4.50	0.01mm	51
4166-5	4.50, 4.51, 4.52, ..., 5.00	0.01mm	51
4166-5D	5.00, 5.01, 5.02, ..., 5.50	0.01mm	51
4166-6	5.50, 5.51, 5.52, ..., 6.00	0.01mm	51
4166-6D	6.00, 6.01, 6.02, ..., 6.50	0.01mm	51
4166-7	6.50, 6.51, 6.52, ..., 7.00	0.01mm	51
4166-7D	7.00, 7.01, 7.02, ..., 7.50	0.01mm	51
4166-8	7.50, 7.51, 7.52, ..., 8.00	0.01mm	51
4166-8D	8.00, 8.01, 8.02, ..., 8.50	0.01mm	51
4166-9	8.50, 8.51, 8.52, ..., 9.00	0.01mm	51
4166-9D	9.00, 9.01, 9.02, ..., 9.50	0.01mm	51
4166-10	9.50, 9.51, 9.52, ..., 10.00	0.01mm	51

Code	Diameter $\varnothing d$ (mm)	Step	Pin gages per set
4166-10D	10.00, 10.01, 10.02, ..., 10.50	0.01mm	51
4166-11	10.50, 10.51, 10.52, ..., 11.00	0.01mm	51
4166-11D	11.00, 11.01, 11.02, ..., 11.50	0.01mm	51
4166-12	11.50, 11.51, 11.52, ..., 12.00	0.01mm	51
4166-12D	12.00, 12.01, 12.02, ..., 12.50	0.01mm	51
4166-13	12.50, 12.51, 12.52, ..., 13.00	0.01mm	51
4166-13D	13.00, 13.01, 13.02, ..., 13.50	0.01mm	51
4166-14	13.50, 13.51, 13.52, ..., 14.00	0.01mm	51
4166-14D	14.00, 14.01, 14.02, ..., 14.50	0.01mm	51
4166-15	14.50, 14.51, 14.52, ..., 15.00	0.01mm	51
4166-15D	15.00, 15.01, 15.02, ..., 15.50	0.01mm	51
4166-16	15.50, 15.51, 15.52, ..., 16.00	0.01mm	51
4166-16D	16.00, 16.01, 16.02, ..., 16.50	0.01mm	51
4166-17	16.50, 16.51, 16.52, ..., 17.00	0.01mm	51
4166-17D	17.00, 17.01, 17.02, ..., 17.50	0.01mm	51
4166-18	17.50, 17.51, 17.52, ..., 18.00	0.01mm	51
4166-18D	18.00, 18.01, 18.02, ..., 18.50	0.01mm	51
4166-19	18.50, 18.51, 18.52, ..., 19.00	0.01mm	51
4166-19D	19.00, 19.01, 19.02, ..., 19.50	0.01mm	51
4166-20	19.50, 19.51, 19.52, ..., 20.00	0.01mm	51

## STEEL INDIVIDUAL PIN GAGES WITH TWO DECIMAL PLACES (0.01MM STEP)

### Ordering examples:

Diameter	Code
0.21mm	4110-0D21
5.56mm	4110-5D56
16.00mm	4110-16D00

Note : "D" stands for "."



4110-9D98

Unit: mm

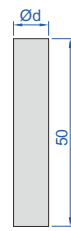

### Diameter Ød (mm)

0.20, 0.21, 0.22, 0.23, ... 1.00
1.01, 1.02, 1.03, 1.04, ... 2.00
2.01, 2.02, 2.03, 2.04, ... 3.00
3.01, 3.02, 3.03, 3.04, ... 4.00
4.01, 4.02, 4.03, 4.04, ... 5.00
5.01, 5.02, 5.03, 5.04, ... 6.00
6.01, 6.02, 6.03, 6.04, ... 7.00
7.01, 7.02, 7.03, 7.04, ... 8.00
8.01, 8.02, 8.03, 8.04, ... 9.00
9.01, 9.02, 9.03, 9.04, ... 10.00
10.01, 10.02, 10.03, 10.04, ... 11.00
11.01, 11.02, 11.03, 11.04, ... 12.00
12.01, 12.02, 12.03, 12.04, ... 13.00
13.01, 13.02, 13.03, 13.04, ... 14.00
14.01, 14.02, 14.03, 14.04, ... 15.00
15.01, 15.02, 15.03, 15.04, ... 16.00
16.01, 16.02, 16.03, 16.04, ... 17.00
17.01, 17.02, 17.03, 17.04, ... 18.00
18.01, 18.02, 18.03, 18.04, ... 19.00
19.01, 19.02, 19.03, 19.04, ... 20.00

- Meet DIN2269, grade 1
- Diameter range: Ø0.20~Ø20.00mm
- Diameter accuracy: ±1µm
- Made of alloy steel
- Hardness HRC62-65
- Optional accessory: wooden box (code **7340**)

### Code

4110-□□□□

## STEEL INDIVIDUAL PIN GAGES WITH THREE DECIMAL PLACES (0.001MM STEP)

- Meet DIN2269, grade 1
- Diameter range: Ø0.200~Ø30.000mm with three decimal, for example 0.211mm, 5.562mm, 16.298mm
- Diameter accuracy: ±1µm
- Made of alloy steel
- Hardness HRC62-65
- Optional accessory: wooden box (code **7340**)



4118-8D015

Unit: mm

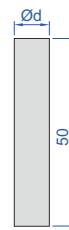

### Ordering examples:

Diameter	Code
0.211mm	4118-0D211
5.562mm	4118-5D562
16.298mm	4118-16D298

Note: "D" stands for "."

### Code

4118-□□□□\*

### Diameter range Ød (mm)

0.200~30.000

\* Supplied with manufacturer inspection certificate

## CERAMIC INDIVIDUAL PIN GAGES

- Meet DIN2269, grade 1
- Diameter range: Ø1.000~Ø15.000mm
- With three decimal, for example 1.211mm, 5.562mm, 14.955mm
- Diameter accuracy: ±1µm
- Made of ceramic, extremely wear resistance, corrosion resistance and dimensional stability
- Optional accessory: wooden box (code **7340**)



4192-10D000

Unit: mm



### Ordering examples:

Diameter	Code
1.211mm	4192-1D211
5.562mm	4192-5D562
14.955mm	4192-14D955

Note : "D" stands for "."

### Code

4192-□□□□

### Diameter range Ød (mm)

1.000-15.000



## BOXES FOR PIN GAGES

- For individual pin gages (4110, 4118, 4192 and 4193 series)

Code	Applicable pin gage diameter Ød	Quantity of pin gages
7340	0.20-10.00mm	51 pcs
7340-101	0.20-10.00mm	101 pcs
7340-201	10.00-15.00mm	51 pcs
7340-202	15.00-20.00mm	51 pcs



7340

## PIN GAGE HANDLE



7345-13

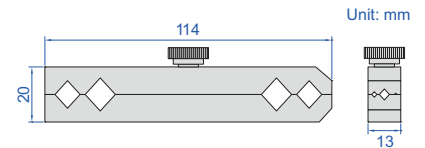

Unit: mm

- Operated without wrench
- Made of aluminum

application



Code	Applicable pin gage diameter
7345-13	1~13mm

## PIN GAGE HANDLES (OPERATED WITHOUT WRENCH)

- Operated without wrench
- Made of aluminum
- Pin gages can be installed



7342-M1

(mm)

Code	Applicable pin gage diameter	H	L
7342-M0	0.30-1.50mm/0.011-0.049"	10	112
7342-M1	1.51-6.35mm/0.050-0.250"	24	131
7342-M2	6.36-12.70mm/0.251-0.500"	32	152
7342-M3	12.71-15.88mm/0.501-0.625"	37	152
7342-M4	15.89-19.00mm/0.626-0.750"	37	152
7342-M5	19.01-21.13mm/0.751-0.832"	40	158
7342-M6	21.14-23.27mm/0.833-0.916"	40	158
7342-M7	23.28-25.40mm/0.917-1.000"	40	158

application



## PIN GAGE HANDLES (OPERATED WITH WRENCH)

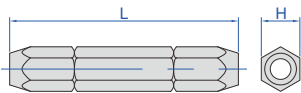
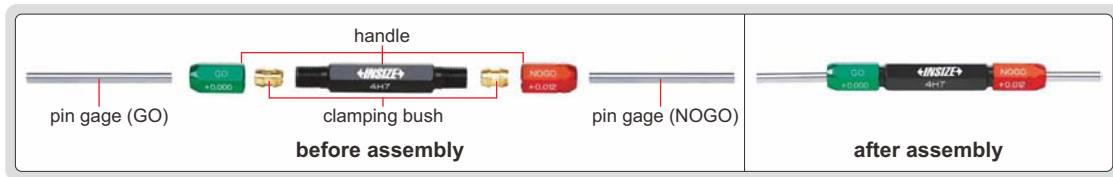

handle



brass clamping bush  
(0.2~7.14mm)



aluminum clamping bush  
(7.14~24.80mm)

- Wrench is needed to install pins
- Clamping bushes (0.2~7.14mm) are made of brass, clamping bushes (7.14~24.80mm) are made of aluminum

Code	Applicable pin gage diameter	Including		(mm)	
		handle	clamping bush (mm)	H	L
7341-0S	0.2-1.02mm	1 pc	6 pairs (the clamping range are 0.2-0.38, 0.38-0.51, 0.51-0.64, 0.64-0.76, 0.76-0.89, 0.89-1.02)	7	57
7341-1S	1.02-1.91mm	1 pc	7 pairs (the clamping range are 1.02-1.14, 1.14-1.27, 1.27-1.40, 1.40-1.52, 1.52-1.65, 1.65-1.78, 1.78-1.91)	7	57
7341-2S	1.91-3.33mm	1 pc	8 pairs (the clamping range are 1.91-2.08, 2.08-2.26, 2.26-2.44, 2.44-2.62, 2.62-2.79, 2.79-2.97, 2.97-3.15, 3.15-3.33)	9	73
7341-3S	3.33-4.57mm	1 pc	7 pairs (the clamping range are 3.33-3.51, 3.51-3.68, 3.68-3.86, 3.86-4.04, 4.04-4.22, 4.22-4.39, 4.39-4.57)	9	73
7341-4S	4.57-5.79mm	1 pc	6 pairs (the clamping range are 4.57-4.78, 4.78-4.98, 4.98-5.18, 5.18-5.38, 5.38-5.59, 5.59-5.79)	14	79
7341-5S	5.79-7.14mm	1 pc	6 pairs (the clamping range are 5.79-5.99, 5.99-6.20, 6.20-6.40, 6.40-6.63, 6.63-6.88, 6.88-7.14)	14	79
7341-6S	7.14-8.66mm	1 pc	6 pairs (the clamping range are 7.14-7.39, 7.39-7.65, 7.65-7.90, 7.90-8.15, 8.15-8.41, 8.41-8.66)	19	91
7341-7S	8.66-10.31mm	1 pc	6 pairs (the clamping range are 8.66-8.92, 8.9 -9.17, 9.17-9.42, 9.42-9.70, 9.70-10.01, 10.01-10.31)	19	91
7341-8S	10.31-11.81mm	1 pc	4 pairs (the clamping range are 10.31-10.67, 10.67-11.05, 11.05-11.43, 11.43-11.81)	22	106
7341-9S	11.81-12.95mm	1 pc	3 pairs (the clamping range are 11.81-12.19, 12.19-12.57, 12.57-12.95)	22	106
7341-10S	12.95-14.71mm	1 pc	4 pairs (the clamping range are 12.95-13.51, 13.51-13.89, 13.89-14.30, 14.30-14.71)	24	115
7341-11S	14.71-16.13mm	1 pc	4 pairs (the clamping range are 14.71-15.09, 15.09-15.49, 15.49-15.88, 15.88-16.13)	24	115
7341-12S	16.13-17.88mm	1 pc	4 pairs (the clamping range are 16.13-16.66, 16.66-17.07, 17.07-17.48, 17.48-17.88)	27	118
7341-13S	17.88-19.30mm	1 pc	4 pairs (the clamping range are 17.88-18.26, 18.26-18.67, 18.67-19.05, 19.05-19.30)	27	118
7341-15S	19.30-24.80mm	1 pc	8 pairs (the clamping range are 19.30-19.84, 19.84-20.62, 20.62-21.41, 21.41-22.23, 22.23-23.03, 23.03-23.80, 23.80-24.59, 24.59-24.80)	32	133

## SINGLE END PIN GAGE HANDLES (OPERATED WITH WRENCH)

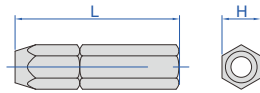
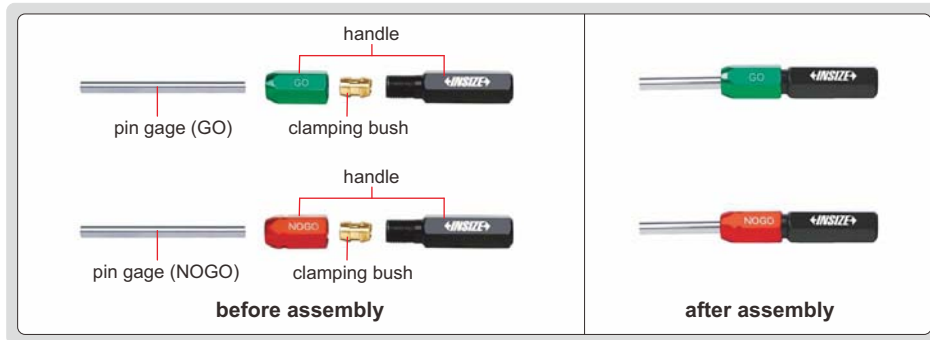

**7344-4G**  
green (GO)



**7344-4R**  
red (NOGO)



brass clamping bush  
(0.2~7.14mm)



aluminum clamping bush  
(7.14~24.80mm)

- Wrench is needed to install pins
- Clamping bushes (0.2~7.14mm) are made of brass, clamping bushes (7.14~24.80mm) are made of aluminum

(mm)

Code		Including		Applicable pin gage diameter	H	L
green (GO)	red (NOGO)	handle	clamping bush (mm)			
7344-0G	7344-0R	1 pc	6 pcs (the clamping range are 0.2-0.38, 0.38-0.51, 0.51-0.64, 0.64-0.76, 0.76-0.89, 0.89-1.02)	0.2-1.02mm	7	52
7344-1G	7344-1R	1 pc	7 pcs (the clamping range are 1.02-1.14, 1.14-1.27, 1.27-1.40, 1.40-1.52, 1.52-1.65, 1.65-1.78, 1.78-1.91)	1.02-1.91mm	7	52
7344-2G	7344-2R	1 pc	8 pcs (the clamping range are 1.91-2.08, 2.08-2.26, 2.26-2.44, 2.44-2.62, 2.62-2.79, 2.79-2.97, 2.97-3.15, 3.15-3.33)	1.91-3.33mm	9	68
7344-3G	7344-3R	1 pc	7 pcs (the clamping range are 3.33-3.51, 3.51-3.68, 3.68-3.86, 3.86-4.04, 4.04-4.22, 4.22-4.39, 4.39-4.57)	3.33-4.57mm	9	68
7344-4G	7344-4R	1 pc	6 pcs (the clamping range are 4.57-4.78, 4.78-4.98, 4.98-5.18, 5.18-5.38, 5.38-5.59, 5.59-5.79)	4.57-5.79mm	14	73
7344-5G	7344-5R	1 pc	6 pcs (the clamping range are 5.79-5.99, 5.99-6.20, 6.20-6.40, 6.40-6.63, 6.63-6.88, 6.88-7.14)	5.79-7.14mm	14	73
7344-6G	7344-6R	1 pc	6 pcs (the clamping range are 7.14-7.39, 7.39-7.65, 7.65-7.90, 7.90-8.15, 8.15-8.41, 8.41-8.66)	7.14-8.66mm	19	79
7344-7G	7344-7R	1 pc	6 pcs (the clamping range are 8.66-8.92, 8.92-9.17, 9.17-9.42, 9.42-9.70, 9.70-10.01, 10.01-10.31)	8.66-10.31mm	19	79
7344-8G	7344-8R	1 pc	4 pcs (the clamping range are 10.31-10.67, 10.67-11.05, 11.05-11.43, 11.43-11.81)	10.31-11.81mm	22	93
7344-9G	7344-9R	1 pc	3 pcs (the clamping range are 11.81-12.19, 12.19-12.57, 12.57-12.95)	11.81-12.95mm	22	93
7344-10G	7344-10R	1 pc	4 pcs (the clamping range are 12.95-13.51, 13.51-13.89, 13.89-14.30, 14.30-14.71)	12.95-14.71mm	24	98
7344-11G	7344-11R	1 pc	4 pcs (the clamping range are 14.71-15.09, 15.09-15.49, 15.49-15.88, 15.88-16.13)	14.71-16.13mm	24	98
7344-12G	7344-12R	1 pc	4 pcs (the clamping range are 16.13-16.66, 16.66-17.07, 17.07-17.48, 17.48-17.88)	16.13-17.88mm	27	110
7344-13G	7344-13R	1 pc	4 pcs (the clamping range are 17.88-18.26, 18.26-18.67, 18.67-19.05, 19.05-19.30)	17.88-19.30mm	27	110
7344-15G	7344-15R	1 pc	8 pcs (the clamping range are 19.30-19.84, 19.84-20.62, 20.62-21.41, 21.41-22.23, 22.23-23.03, 23.03-23.80, 23.80-24.59, 24.59-24.80)	19.30-24.80mm	32	118

## CYLINDER GAGES

CAN SUPPLY CUSTOM SIZES FROM Ø3.000mm TO Ø200.000mm, FOR EXAMPLE, Ø0.218mm



- Made of tungsten steel, quenched, ultra-low temperature treatment
- Wear resistant, long life, dimension stability
- Hardness HRC60-62



6316-30

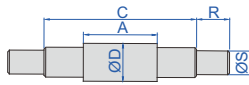

(mm)

Diameter ØD **	A	C	R	ØS	Size *** difference	Roundness and cylindricity
3.0-3.81	9.52	17.46	11.1	2.4	±5µm	0.5µm
3.81-5.84	11.11	19.05	11.1	3.2	±5µm	0.5µm
5.84-9.27	12.7	20.64	11.1	5.6	±5µm	0.5µm

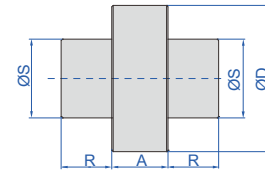

(mm)

Diameter ØD **	A	ØS	R	Size *** difference	Roundness and cylindricity
38.35-51.05	31.8	22.2	15.8	±5µm	1µm
51.05-63.75	31.8	22.2	15.8	±5µm	1µm
63.75-76.45	38.1	25.4	39.8	±5µm	1.2µm
76.45-89.15	38.1	25.4	39.8	±5µm	1.2µm
89.15-101.85	38.1	25.4	39.8	±5µm	1.2µm
101.85-114.55	38.1	25.4	39.8	±5µm	1.2µm
114.55-127.25	38.1	25.4	39.8	±5µm	1.6µm
127.25-139.95	38.1	25.4	39.8	±5µm	1.6µm
139.95-152.62	38.1	25.4	39.8	±5µm	1.6µm
152.65-165.35	38.1	25.4	39.8	±5µm	1.6µm
165.35-178.05	38.1	25.4	39.8	±5µm	2µm
178.05-190.75	38.1	25.4	39.8	±5µm	2µm
190.75-203.45	38.1	25.4	39.8	±5µm	2µm

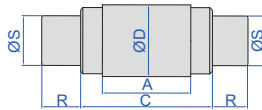

(mm)

Diameter ØD **	A	C	R	ØS	Size *** difference	Roundness and cylindricity
9.27-12.95	14.29	22.22	12.7	8.7	±5µm	0.5µm
12.95-20.96	15.88	23.81	12.7	12.7	±5µm	0.5µm
20.96-28.83	17.46	25.4	15.9	19	±5µm	0.7µm
28.83-38.35	20.64	28.58	15.9	25.4	±5µm	0.7µm

\*\* For example, 3-3.81 indicates 3mm<D≤3.8mm

\*\*\* Size difference (difference between the ordered size and the size marked on the cylinder gages when supplied).

For example, the ordered size is Ø3.000mm, the size marked on the cylinder gages when supplied may be Ø3.003mm

Code	ØD	Code	ØD	Code	ØD	Code	ØD	Code	ØD
6316-3 *	Ø3mm	6316-16 *	Ø16mm	6316-29 *	Ø29mm	6316-42 *	Ø42mm	6316-70 *	Ø70mm
6316-4 *	Ø4mm	6316-17 *	Ø17mm	6316-30 *	Ø30mm	6316-43 *	Ø43mm	6316-75 *	Ø75mm
6316-5 *	Ø5mm	6316-18 *	Ø18mm	6316-31 *	Ø31mm	6316-44 *	Ø44mm	6316-80 *	Ø80mm
6316-6 *	Ø6mm	6316-19 *	Ø19mm	6316-32 *	Ø32mm	6316-45 *	Ø45mm	6316-85 *	Ø85mm
6316-7 *	Ø7mm	6316-20 *	Ø20mm	6316-33 *	Ø33mm	6316-46 *	Ø46mm	6316-87 *	Ø87mm
6316-8 *	Ø8mm	6316-21 *	Ø21mm	6316-34 *	Ø34mm	6316-47 *	Ø47mm	6316-90 *	Ø90mm
6316-9 *	Ø9mm	6316-22 *	Ø22mm	6316-35 *	Ø35mm	6316-48 *	Ø48mm	6316-95 *	Ø95mm
6316-10 *	Ø10mm	6316-23 *	Ø23mm	6316-36 *	Ø36mm	6316-49 *	Ø49mm	6316-100 *	Ø100mm
6316-11 *	Ø11mm	6316-24 *	Ø24mm	6316-37 *	Ø37mm	6316-50 *	Ø50mm	6316-125 *	Ø125mm
6316-12 *	Ø12mm	6316-25 *	Ø25mm	6316-38 *	Ø38mm	6316-55 *	Ø55mm	6316-150 *	Ø150mm
6316-13 *	Ø13mm	6316-26 *	Ø26mm	6316-39 *	Ø39mm	6316-60 *	Ø60mm	6316-175 *	Ø175mm
6316-14 *	Ø14mm	6316-27 *	Ø27mm	6316-40 *	Ø40mm	6316-62 *	Ø62mm	6316-200 *	Ø200mm
6316-15 *	Ø15mm	6316-28 *	Ø28mm	6316-41 *	Ø41mm	6316-65 *	Ø65mm		

\*Supplied with manufacturer inspection certificate

**FAST AND ACCURATE  
MEASUREMENT OF CYLINDERS**

## ADJUSTABLE SNAP GAGES

- Used as Go/No-Go gage by setting upper and lower limits
- Flatness of anvil: 1.5µm
- Parallelism of measuring faces:  
range 0-32mm: 3µm  
range 32-89mm: 4µm  
range 89-300mm: 5µm

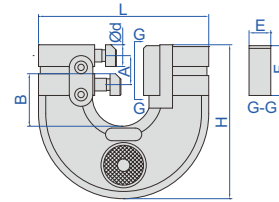

2187-19

(mm)

Code	Range	L	A	B	E	F	H	Ød
2187-6	0-6mm	74	15	17.5	12.2	27.2	71.5	7
2187-13	6-13mm	85	15	26	12.2	27.2	79.5	12.3
2187-19	13-19mm	93	15	27	12.2	27.2	83	12.3
2187-25	19-25mm	100	15	33.5	12.2	27.2	89.5	12.3
2187-32	25-32mm	111	18	38.5	15.2	35.2	104	15.3
2187-38	32-38mm	117	18	41.5	15.2	35.2	105	15.3
2187-44	38-44mm	123	18	44.5	15.2	35.2	109	15.3
2187-51	44-51mm	130	18	48	15.2	35.2	117	15.3
2187-57	51-57mm	136	18	45	15.2	35.2	119	15.3
2187-63	57-63mm	143	18	50	15.2	35.2	122	15.3
2187-70	63-70mm	156	20	58	15.2	35.2	132	15.3
2187-76	70-76mm	163	20	60.5	15.2	35.2	137	15.3
2187-82	76-82mm	169	20	64.5	15.2	35.2	140	15.3
2187-89	82-89mm	175	20	66.5	15.2	35.2	146	15.3
2187-95	89-95mm	181	20	69.5	15.2	35.2	149	15.3
2187-101	95-101mm	188	20	70	15.2	35.2	154	15.3
2187-108	101-108mm	198	24	79	15.2	39.2	166	15.3
2187-114	108-114mm	204	24	81	15.2	39.2	172	15.3
2187-120	114-120mm	210	24	86	15.2	39.2	179	15.3
2187-127	120-127mm	217	24	89.5	15.2	39.2	186	15.3
2187-133	127-133mm	223	24	92.5	15.2	39.2	192	15.3
2187-139	133-139mm	229	24	95.5	15.2	39.2	197	15.3
2187-146	139-146mm	235	24	98.5	15.2	39.2	201	15.3
2187-152	146-152mm	242	24	102	15.2	39.2	205	15.3
2187-163	152-163mm	273	21.4	106.7	18.2	39.2	211	18.3
2187-175	163-175mm	273	21.4	106.7	18.2	39.2	211	18.3
2187-188	175-188mm	298.5	21.4	119.7	18.2	39.2	227	18.3
2187-200	188-200mm	298.5	21.4	119.7	18.2	39.2	227	18.3
2187-213	200-213mm	324	21.4	131.7	18.2	39.2	242	18.3
2187-225	213-225mm	324	21.4	131.7	18.2	39.2	242	18.3
2187-238	225-238mm	349.5	21.4	144.7	18.2	39.2	250	18.3
2187-250	238-250mm	349.5	21.4	149	18.2	39.2	250	18.3
2187-263	250-263mm	375.5	21.4	157.7	18.2	39.2	278	18.3
2187-275	263-275mm	375.5	21.4	157.7	18.2	39.2	278	18.3
2187-288	275-288mm	400	21.4	170.7	18.2	39.2	291	18.3
2187-300	288-300mm	400	21.4	170.7	18.2	39.2	291	18.3

## SETTING RINGS



CAN SUPPLY CUSTOM SETTING RINGS FROM Ø1.50MM TO Ø400.00MM, FOR EXAMPLE, Ø17.08MM

- For zero setting of inside micrometers, three points internal micrometers and bore gages
- The size marked on the setting ring is checked at the direction of the marking line
- Size difference (difference between the ordered size and the size marked on the setting ring when supplied): For example, the ordered size is Ø10.12mm, the size marked on the setting ring when supplied may be Ø10.130mm
- Meet DIN2250-1:2008

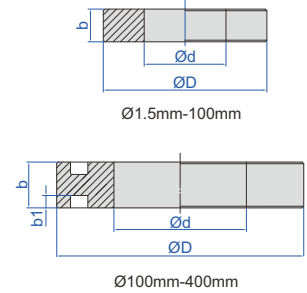

(mm)				
Diameter d**	b	ØD	Size difference	Roundness and cylindricity
Ø1.5-2.5	4	22	±10.0µm	0.3µm
Ø2.5-3	5	22	±10.0µm	0.3µm
Ø3-5	5	22	±10.0µm	0.4µm
Ø5-10	8	32	±10.0µm	0.4µm
Ø10-15	10	38	±10.0µm	0.5µm
Ø15-18	12	45	±10.0µm	0.5µm
Ø18-20	12	45	±10.0µm	0.6µm
Ø20-25	14	53	±10.0µm	0.6µm
Ø25-30	16	63	±10.0µm	0.6µm
Ø30-32	16	63	±10.0µm	0.7µm
Ø32-40	18	71	±10.0µm	0.7µm
Ø40-50	20	85	±10.0µm	0.7µm
Ø50-60	20	100	±10.0µm	0.8µm
Ø60-70	24	112	±10.0µm	0.8µm
Ø70-80	24	125	±10.0µm	0.8µm
Ø80-90	24	140	±10.0µm	1.0µm
Ø90-100	24	160	±10.0µm	1.0µm

\*\* For example Ø3-5mm means Ø3mm < diameter d ≤ Ø5mm

(mm)					
Diameter d**	b	b1	ØD	Size difference	Roundness and cylindricity
Ø100-110	30	8	164	±10.0µm	1.0µm
Ø110-130	34	10	192	±10.0µm	1.0µm
Ø130-150	34	10	220	±10.0µm	1.2µm
Ø150-170	36	10	248	±10.0µm	1.5µm
Ø170-190	36	10	276	±10.0µm	1.5µm
Ø190-210	38	10	300	±10.0µm	1.5µm
Ø210-230	38	10	324	±10.0µm	2.5µm
Ø230-250	40	12	350	±10.0µm	2.5µm
Ø250-270	40	12	375	±10.0µm	3.0µm
Ø270-290	42	12	400	±10.0µm	3.0µm
Ø290-300	42	12	425	±10.0µm	3.0µm
Ø300-320	42	12	430	±10.0µm	4.0µm
Ø320-330	42	12	440	±10.0µm	4.0µm
Ø330-340	42	12	450	±10.0µm	4.0µm
Ø340-350	42	12	460	±10.0µm	4.0µm
Ø350-360	42	12	470	±10.0µm	4.0µm
Ø360-370	42	12	480	±10.0µm	4.0µm
Ø370-380	42	12	490	±10.0µm	4.0µm
Ø380-390	42	12	500	±10.0µm	4.0µm
Ø390-400	42	12	510	±10.0µm	4.0µm

(mm)	
Code	Size
6312-1D5*	Ø1.5
6312-2*	Ø2
6312-2D5*	Ø2.5
6312-3*	Ø3
6312-3D5*	Ø3.5
6312-4*	Ø4
6312-4D5*	Ø4.5
6312-5*	Ø5
6312-5D5*	Ø5.5
6312-6*	Ø6
6312-6D5*	Ø6.5
6312-7*	Ø7
6312-7D5*	Ø7.5
6312-8*	Ø8
6312-8D5*	Ø8.5
6312-9*	Ø9
6312-9D5*	Ø9.5
6312-10*	Ø10
6312-10D5*	Ø10.5
6312-11*	Ø11
6312-11D5*	Ø11.5
6312-12*	Ø12

(mm)	
Code	Size
6312-12D5*	Ø12.5
6312-13*	Ø13
6312-13D5*	Ø13.5
6312-14*	Ø14
6312-14D5*	Ø14.5
6312-15*	Ø15
6312-15D5*	Ø15.5
6312-16*	Ø16
6312-16D5*	Ø16.5
6312-17*	Ø17
6312-17D5*	Ø17.5
6312-18*	Ø18
6312-18D5*	Ø18.5
6312-19*	Ø19
6312-19D5*	Ø19.5
6312-20*	Ø20
6312-20D5*	Ø20.5
6312-21*	Ø21
6312-21D5*	Ø21.5
6312-22*	Ø22
6312-22D5*	Ø22.5
6312-23*	Ø23

(mm)	
Code	Size
6312-23D5*	Ø23.5
6312-24*	Ø24
6312-24D5*	Ø24.5
6312-25*	Ø25
6312-25D5*	Ø25.5
6312-26*	Ø26
6312-26D5*	Ø26.5
6312-27*	Ø27
6312-27D5*	Ø27.5
6312-28*	Ø28
6312-28D5*	Ø28.5
6312-29*	Ø29
6312-29D5*	Ø29.5
6312-30*	Ø30
6312-31*	Ø31
6312-32*	Ø32
6312-33*	Ø33
6312-34*	Ø34
6312-35*	Ø35
6312-36*	Ø36
6312-37*	Ø37
6312-38*	Ø38

(mm)	
Code	Size
6312-39*	Ø39
6312-40*	Ø40
6312-41*	Ø41
6312-42*	Ø42
6312-43*	Ø43
6312-44*	Ø44
6312-45*	Ø45
6312-46*	Ø46
6312-47*	Ø47
6312-48*	Ø48
6312-49*	Ø49
6312-50*	Ø50
6312-55*	Ø55
6312-60*	Ø60
6312-62*	Ø62
6312-65*	Ø65
6312-70*	Ø70
6312-75*	Ø75
6312-80*	Ø80
6312-85*	Ø85
6312-87*	Ø87
6312-90*	Ø90

(mm)	
Code	Size
6312-95*	Ø95
6312-100*	Ø100
6312-112D5*	Ø112.5
6312-125*	Ø125
6312-137D5*	Ø137.5
6312-150*	Ø150
6312-162D5*	Ø162.5
6312-175*	Ø175
6312-187D5*	Ø187.5
6312-200*	Ø200
6312-212D5*	Ø212.5
6312-225*	Ø225
6312-237D5*	Ø237.5
6312-250*	Ø250
6312-262D5*	Ø262.5
6312-275*	Ø275
6312-287D5*	Ø287.5
6312-300*	Ø300
6312-350*	Ø350
6312-400*	Ø400

\* Supplied with manufacturer inspection certificate



CAN SUPPLY CUSTOM SETTING RINGS FROM Ø0.40MM TO Ø50.00MM, FOR EXAMPLE, Ø17.08MM

## CARBIDE SETTING RINGS

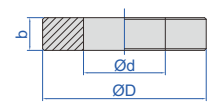

6317-10

(mm)

Diameter d **	b	ØD	Size difference	Roundness and cylindricity
Ø0.4-0.5	4	10	±10µm	0.3µm
Ø0.5-1.6	6	10	±10µm	0.3µm
Ø1.6-12.1	8	30	±10µm	0.3µm
Ø12.1-18.1	12	40	±10µm	0.4µm
Ø18.1-25	15	50	±10µm	0.4µm
Ø25-30	15	60	±10µm	0.4µm
Ø30-35	18	80	±10µm	0.4µm
Ø35-40	20	80	±10µm	0.4µm
Ø40-45	20	90	±10µm	0.4µm
Ø45-50	20	100	±10µm	0.4µm

- For zero setting of inside micrometers, three points internal micrometers and bore gages
- Size difference (difference between the ordered size and the size marked on the setting ring when supplied): For example, the ordered size is Ø10.00mm, the size marked on the setting ring when supplied may be Ø10.002mm
- Meet DIN2250-1:2008

\*\* For example Ø0.4-0.5mm means Ø0.4mm < diameter d ≤ Ø0.5mm

Code	Size
6317-0D5 *	Ø0.5mm
6317-1 *	Ø1mm
6317-1D5 *	Ø1.5mm
6317-2 *	Ø2mm
6317-2D5 *	Ø2.5mm
6317-3 *	Ø3mm
6317-3D5 *	Ø3.5mm
6317-4 *	Ø4mm
6317-4D5 *	Ø4.5mm
6317-5 *	Ø5mm
6317-5D5 *	Ø5.5mm
6317-6 *	Ø6mm
6317-6D5 *	Ø6.5mm
6317-7 *	Ø7mm
6317-7D5 *	Ø7.5mm
6317-8 *	Ø8mm
6317-8D5 *	Ø8.5mm
6317-9 *	Ø9mm
6317-9D5 *	Ø9.5mm
6317-10 *	Ø10mm

Code	Size
6317-10D5 *	Ø10.5mm
6317-11 *	Ø11mm
6317-11D5 *	Ø11.5mm
6317-12 *	Ø12mm
6317-12D5 *	Ø12.5mm
6317-13 *	Ø13mm
6317-13D5 *	Ø13.5mm
6317-14 *	Ø14mm
6317-14D5 *	Ø14.5mm
6317-15 *	Ø15mm
6317-15D5 *	Ø15.5mm
6317-16 *	Ø16mm
6317-16D5 *	Ø16.5mm
6317-17 *	Ø17mm
6317-17D5 *	Ø17.5mm
6317-18 *	Ø18mm
6317-18D5 *	Ø18.5mm
6317-19 *	Ø19mm
6317-19D5 *	Ø19.5mm
6317-20 *	Ø20mm

Code	Size
6317-20D5 *	Ø20.5mm
6317-21 *	Ø21mm
6317-21D5 *	Ø21.5mm
6317-22 *	Ø22mm
6317-22D5 *	Ø22.5mm
6317-23 *	Ø23mm
6317-23D5 *	Ø23.5mm
6317-24 *	Ø24mm
6317-24D5 *	Ø24.5mm
6317-25 *	Ø25mm
6317-25D5 *	Ø25.5mm
6317-26 *	Ø26mm
6317-26D5 *	Ø26.5mm
6317-27 *	Ø27mm
6317-27D5 *	Ø27.5mm
6317-28 *	Ø28mm
6317-28D5 *	Ø28.5mm
6317-29 *	Ø29mm
6317-29D5 *	Ø29.5mm
6317-30 *	Ø30mm

Code	Size
6317-31 *	Ø31mm
6317-32 *	Ø32mm
6317-33 *	Ø33mm
6317-34 *	Ø34mm
6317-35 *	Ø35mm
6317-36 *	Ø36mm
6317-37 *	Ø37mm
6317-38 *	Ø38mm
6317-39 *	Ø39mm
6317-40 *	Ø40mm
6317-41 *	Ø41mm
6317-42 *	Ø42mm
6317-43 *	Ø43mm
6317-44 *	Ø44mm
6317-45 *	Ø45mm
6317-46 *	Ø46mm
6317-47 *	Ø47mm
6317-48 *	Ø48mm
6317-49 *	Ø49mm
6317-50 *	Ø50mm

\* Supplied with manufacturer inspection certificate

# CERAMIC SETTING RINGS



CAN SUPPLY CUSTOM SETTING RINGS FROM Ø1.30MM TO Ø50.00MM, FOR EXAMPLE, Ø17.08MM



6319-10

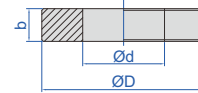

- For zero setting of inside micrometers, three points internal micrometers and bore gages
- Size difference (difference between the ordered size and the size marked on the setting ring when supplied): For example, the ordered size is Ø10.12mm, the size marked on the setting ring when supplied may be Ø10.130mm
- Made of ceramic, extremely wear resistance and corrosion resistance, dimensional stability
- Meet DIN2250-1:2008

(mm)				
Diameter d <sup>**</sup>	b	ØD	Size difference	Roundness and cylindricity
Ø1.3-2.7	6	20	±10µm	0.3µm
Ø2.7-12.1	8	30	±10µm	0.3µm
Ø12.1-18.1	12	40	±10µm	0.4µm
Ø18.1-25	15	50	±10µm	0.4µm
Ø25-30	15	60	±10µm	0.4µm
Ø30-35	18	80	±10µm	0.4µm
Ø35-40	20	80	±10µm	0.4µm
Ø40-45	20	90	±10µm	0.4µm
Ø45-50	20	100	±10µm	0.4µm

\*\* For example Ø1.3-2.7mm means Ø1.3mm < diameter d ≤ Ø2.7mm

Code	Size
6319-1D5 *	Ø1.5mm
6319-2 *	Ø2mm
6319-2D5 *	Ø2.5mm
6319-3 *	Ø3mm
6319-3D5 *	Ø3.5mm
6319-4 *	Ø4mm
6319-4D5 *	Ø4.5mm
6319-5 *	Ø5mm
6319-5D5 *	Ø5.5mm
6319-6 *	Ø6mm
6319-6D5 *	Ø6.5mm
6319-7 *	Ø7mm
6319-7D5 *	Ø7.5mm
6319-8 *	Ø8mm
6319-8D5 *	Ø8.5mm
6319-9 *	Ø9mm
6319-9D5 *	Ø9.5mm
6319-10 *	Ø10mm
6319-10D5 *	Ø10.5mm

Code	Size
6319-11 *	Ø11mm
6319-11D5 *	Ø11.5mm
6319-12 *	Ø12mm
6319-12D5 *	Ø12.5mm
6319-13 *	Ø13mm
6319-13D5 *	Ø13.5mm
6319-14 *	Ø14mm
6319-14D5 *	Ø14.5mm
6319-15 *	Ø15mm
6319-15D5 *	Ø15.5mm
6319-16 *	Ø16mm
6319-16D5 *	Ø16.5mm
6319-17 *	Ø17mm
6319-17D5 *	Ø17.5mm
6319-18 *	Ø18mm
6319-18D5 *	Ø18.5mm
6319-19 *	Ø19mm
6319-19D5 *	Ø19.5mm
6319-20 *	Ø20mm

Code	Size
6319-20D5 *	Ø20.5mm
6319-21 *	Ø21mm
6319-21D5 *	Ø21.5mm
6319-22 *	Ø22mm
6319-22D5 *	Ø22.5mm
6319-23 *	Ø23mm
6319-23D5 *	Ø23.5mm
6319-24 *	Ø24mm
6319-24D5 *	Ø24.5mm
6319-25 *	Ø25mm
6319-25D5 *	Ø25.5mm
6319-26 *	Ø26mm
6319-26D5 *	Ø26.5mm
6319-27 *	Ø27mm
6319-27D5 *	Ø27.5mm
6319-28 *	Ø28mm
6319-28D5 *	Ø28.5mm
6319-29 *	Ø29mm
6319-29D5 *	Ø29.5mm
6319-30 *	Ø30mm

Code	Size
6319-31 *	Ø31mm
6319-32 *	Ø32mm
6319-33 *	Ø33mm
6319-34 *	Ø34mm
6319-35 *	Ø35mm
6319-36 *	Ø36mm
6319-37 *	Ø37mm
6319-38 *	Ø38mm
6319-39 *	Ø39mm
6319-40 *	Ø40mm
6319-41 *	Ø41mm
6319-42 *	Ø42mm
6319-43 *	Ø43mm
6319-44 *	Ø44mm
6319-45 *	Ø45mm
6319-46 *	Ø46mm
6319-47 *	Ø47mm
6319-48 *	Ø48mm
6319-49 *	Ø49mm
6319-50 *	Ø50mm

\* Supplied with manufacturer inspection certificate



CUSTOM-MADE  
 OTHER CLASSES ARE AVAILABLE, SUCH AS H8, H9  
 OTHER DIAMETERS ARE AVAILABLE, SUCH AS 19.003mm  
 OTHER LENGTHS ARE AVAILABLE, SUCH AS 70mm

## PLAIN PLUG GAGES

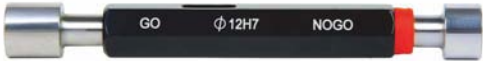

4124-12

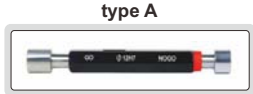

type A

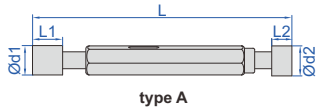

type A

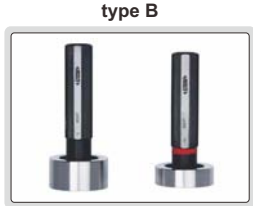

type B

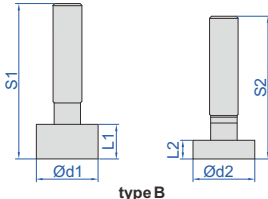

type B

- Supplied with Go and No-Go gages together
- Class H7
- Hardness HRC 60±2
- Standard DIN7150-2

### Size tolerance of H7

(mm)

Diameter $\varnothing d$	Type	Size tolerance of Go gage ( $\mu m$ )	Size tolerance of No-Go gage ( $\mu m$ )	L1	L2	L	S1, S2
$\geq 2, \leq 3$	A	+0.5 / +2.5	+9 / +11	6.5	4.5	62	—
$> 3, \leq 6$	A	+0.75 / +3.25	+10.75 / +13.25	8	6	74	—
$> 6, \leq 10$	A	+0.75 / +3.25	+13.75 / +16.25	10	7	87	—
$> 10, \leq 14$	A	+1 / +4	+16.5 / +19.5	12	8	99	—
$> 14, \leq 18$	A	+1 / +4	+16.5 / +19.5	14	10	114	—
$> 18, \leq 24$	A	+1 / +5	+19 / +23	16	12	132	—
$> 24, \leq 30$	A	+1 / +5	+19 / +23	18	14	136	—
$> 30, \leq 40$	A	+1.5 / +5.5	+23 / +27	20	15	155	—
$> 40, \leq 50$	A	+1.5 / +5.5	+23 / +27	25	18	169	—
$> 50, \leq 65$	B	+1.5 / +6.5	+27.5 / +32.5	30	18	—	164, 152
$> 65, \leq 80$	B	+1.5 / +6.5	+27.5 / +32.5	35	25	—	169, 159
$> 80, \leq 100$	B	+2 / +8	+32 / +38	35	25	—	169, 159

Code	Diameter	Type	Code	Diameter	Type	Code	Diameter	Type	Code	Diameter	Type
4124-2	2mm	A	4124-17	17mm	A	4124-32	32mm	A	4124-47	47mm	A
4124-3	3mm	A	4124-18	18mm	A	4124-33	33mm	A	4124-48	48mm	A
4124-4	4mm	A	4124-19	19mm	A	4124-34	34mm	A	4124-49	49mm	A
4124-5	5mm	A	4124-20	20mm	A	4124-35	35mm	A	4124-50	50mm	A
4124-6	6mm	A	4124-21	21mm	A	4124-36	36mm	A	4124-52	52mm	B
4124-7	7mm	A	4124-22	22mm	A	4124-37	37mm	A	4124-55	55mm	B
4124-8	8mm	A	4124-23	23mm	A	4124-38	38mm	A	4124-60	60mm	B
4124-9	9mm	A	4124-24	24mm	A	4124-39	39mm	A	4124-65	65mm	B
4124-10	10mm	A	4124-25	25mm	A	4124-40	40mm	A	4124-70	70mm	B
4124-11	11mm	A	4124-26	26mm	A	4124-41	41mm	A	4124-75	75mm	B
4124-12	12mm	A	4124-27	27mm	A	4124-42	42mm	A	4124-80	80mm	B
4124-13	13mm	A	4124-28	28mm	A	4124-43	43mm	A	4124-85	85mm	B
4124-14	14mm	A	4124-29	29mm	A	4124-44	44mm	A	4124-90	90mm	B
4124-15	15mm	A	4124-30	30mm	A	4124-45	45mm	A	4124-95	95mm	B
4124-16	16mm	A	4124-31	31mm	A	4124-46	46mm	A	4124-100	100mm	B

# CARBIDE PLAIN PLUG GAGES



CUSTOM-MADE  
OTHER CLASSES ARE AVAILABLE, SUCH AS H8, H9, G7  
OTHER DIAMETERS ARE AVAILABLE, SUCH AS 19.003mm  
OTHER LENGTHS ARE AVAILABLE, SUCH AS 70mm

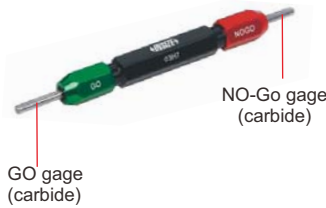

4128-3



4128-50

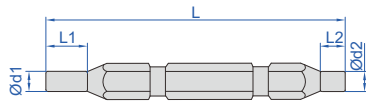

type A

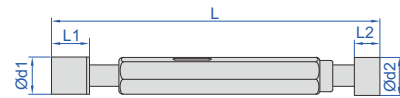

type B

- Supplied with Go and No-Go gages together
- Standard DIN7150-2

### Size tolerance of H7

(mm)

Diameter	Size tolerance of Go gage $\varnothing d1$ ( $\mu\text{m}$ )	Size tolerance of No-Go gage $\varnothing d2$ ( $\mu\text{m}$ )	L1	L2	L
$\geq 1, \leq 1.9$	+0.5/+2.5	+9/+11	15	12	67
$> 1.9, \leq 3$	+0.5/+2.5	+9/+11	15	12	79
$> 3, \leq 4.7$	+0.75/+3.25	+10.75/+13.25	15	12	79
$> 4.7, \leq 6$	+0.75/+3.25	+10.75/+13.25	15	12	88.5
$> 6, \leq 7.1$	+0.75/+3.25	+13.75/+16.25	15	12	88.5
$> 7.1, \leq 8$	+0.75/+3.25	+13.75/+16.25	15	12	99
$> 8, \leq 10$	+0.75/+3.25	+13.75/+16.25	12	7	75
$> 10, \leq 14$	+1/+4	+16.5/+19.5	12	7	82
$> 14, \leq 18$	+1/+4	+16.5/+19.5	17	10	97
$> 18, \leq 24$	+1/+5	+19/+23	17	12	109
$> 24, \leq 30$	+1/+5	+19/+23	17	14	111
$> 30, \leq 40$	+1.5/+5.5	+23/+27	20	15	115
$> 40, \leq 50$	+1.5/+5.5	+23/+27	20	15	160
$> 50, \leq 60$	+1.5/+6.5	+27.5/+32.5	20	15	160

14

### H7

(mm)

Code	Diameter	Type	Code	Diameter	Type	Code	Diameter	Type	Code	Diameter	Type
4128-1*	1	A	4128-14*	14	B	4128-27*	27	B	4128-40*	40	B
4128-2*	2	A	4128-15*	15	B	4128-28*	28	B	4128-41*	41	B
4128-3*	3	A	4128-16*	16	B	4128-29*	29	B	4128-42*	42	B
4128-4*	4	A	4128-17*	17	B	4128-30*	30	B	4128-43*	43	B
4128-5*	5	A	4128-18*	18	B	4128-31*	31	B	4128-44*	44	B
4128-6*	6	A	4128-19*	19	B	4128-32*	32	B	4128-45*	45	B
4128-7*	7	A	4128-20*	20	B	4128-33*	33	B	4128-46*	46	B
4128-8*	8	A	4128-21*	21	B	4128-34*	34	B	4128-47*	47	B
4128-9*	9	B	4128-22*	22	B	4128-35*	35	B	4128-48*	48	B
4128-10*	10	B	4128-23*	23	B	4128-36*	36	B	4128-49*	49	B
4128-11*	11	B	4128-24*	24	B	4128-37*	37	B	4128-50*	50	B
4128-12*	12	B	4128-25*	25	B	4128-38*	38	B	4128-52*	52	B
4128-13*	13	B	4128-26*	26	B	4128-39*	39	B	4128-55*	55	B
									4128-60*	60	B

\* Supplied with manufacturer inspection certificate

## CARBIDE PLAIN PLUG GAGES (SINGLE END)

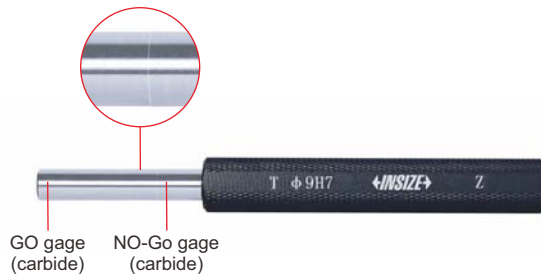

6331-9

- Supplied with Go and No-Go gages together
- Standard DIN7150-2

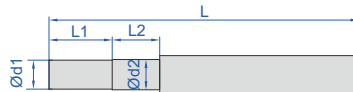

### Size tolerance of H7

(mm)

Diameter	Size tolerance of Go gage Ød1 (µm)	Size tolerance of No-Go gage Ød2 (µm)	L1	L2	L
≥0.5, ≤3	+0.5/+2.5	+9/+11	20	15	95
>3, ≤6	+0.75/+3.25	+10.75/+13.25	20	15	95
>6, ≤10	+0.75/+3.25	+13.75/+16.25	20	15	95
>10, ≤15	+1/+4	+16.5/+19.5	20	15	95
>15, ≤18	+1/+4	+16.5/+19.5	20	15	115
>18, ≤30	+1/+5	+19/+23	20	15	115
>30, ≤40	+1.5/+5.5	+23/+27	20	15	115

CUSTOM-MADE  
OTHER CLASSES ARE AVAILABLE, SUCH AS H8, H9, G7  
OTHER DIAMETERS ARE AVAILABLE, SUCH AS 19.003mm  
OTHER LENGTHS ARE AVAILABLE, SUCH AS 70mm

H7

(mm)

Code	Diameter	Code	Diameter
6331-1*	1	6331-21*	21
6331-2*	2	6331-22*	22
6331-3*	3	6331-23*	23
6331-4*	4	6331-24*	24
6331-5*	5	6331-25*	25
6331-6*	6	6331-26*	26
6331-7*	7	6331-27*	27
6331-8*	8	6331-28*	28
6331-9*	9	6331-29*	29
6331-10*	10	6331-30*	30
6331-11*	11	6331-31*	31
6331-12*	12	6331-32*	32
6331-13*	13	6331-33*	33
6331-14*	14	6331-34*	34
6331-15*	15	6331-35*	35
6331-16*	16	6331-36*	36
6331-17*	17	6331-37*	37
6331-18*	18	6331-38*	38
6331-19*	19	6331-39*	39
6331-20*	20	6331-40*	40

\*Supplied with manufacturer inspection certificate

## CERAMIC PLAIN PLUG GAGES (SINGLE END)



6333-10

- Supplied with Go and No-Go gages together
- Made of ceramic, extremely wear resistance and corrosion resistance, dimensional stability
- Standard DIN7150-2

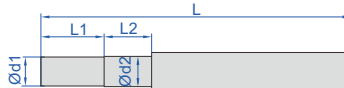

### Size tolerance of H7

(mm)

Diameter	Size tolerance of Go gage Ød1 (µm)	Size tolerance of No-Go gage Ød2 (µm)	L1	L2	L
≥0.5, ≤3	+0.5/+2.5	+9/+11	20	15	95
>3, ≤6	+0.75/+3.25	+10.75/+13.25	20	15	95
>6, ≤10	+0.75/+3.25	+13.75/+16.25	20	15	95
>10, ≤15	+1/+4	+16.5/+19.5	20	15	95
>15, ≤18	+1/+4	+16.5/+19.5	20	15	115
>18, ≤30	+1/+5	+19/+23	20	15	115
>30, ≤40	+1.5/+5.5	+23/+27	20	15	115

CUSTOM-MADE  
OTHER CLASSES ARE AVAILABLE, SUCH AS H8, H9, G7  
OTHER DIAMETERS ARE AVAILABLE, SUCH AS 19.003mm  
OTHER LENGTHS ARE AVAILABLE, SUCH AS 70mm

H7

(mm)

Code	Diameter	Code	Diameter
6333-1*	1	6333-21*	21
6333-2*	2	6333-22*	22
6333-3*	3	6333-23*	23
6333-4*	4	6333-24*	24
6333-5*	5	6333-25*	25
6333-6*	6	6333-26*	26
6333-7*	7	6333-27*	27
6333-8*	8	6333-28*	28
6333-9*	9	6333-29*	29
6333-10*	10	6333-30*	30
6333-11*	11	6333-31*	31
6333-12*	12	6333-32*	32
6333-13*	13	6333-33*	33
6333-14*	14	6333-34*	34
6333-15*	15	6333-35*	35
6333-16*	16	6333-36*	36
6333-17*	17	6333-37*	37
6333-18*	18	6333-38*	38
6333-19*	19	6333-39*	39
6333-20*	20	6333-40*	40

\*Supplied with manufacturer inspection certificate

## CERAMIC PLAIN PLUG GAGES

CUSTOM-MADE  
OTHER CLASSES ARE AVAILABLE, SUCH AS H8, H9, G7  
OTHER DIAMETERS ARE AVAILABLE, SUCH AS 19.003mm  
OTHER LENGTHS ARE AVAILABLE, SUCH AS 70mm



6332-17

- Supplied with Go and No-Go gages together
- Made of ceramic, extremely wear resistance and corrosion resistance, dimensional stability
- Standard DIN7150-2

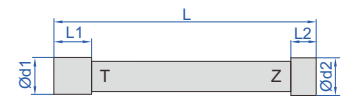

### Size tolerance of H7

(mm)

Diameter	Size tolerance of Go gage Ød1 (µm)	Size tolerance of No-Go gage Ød2 (µm)	L1	L2	L
≥0.5, ≤3	+0.5/+2.5	+9/+11	20	15	95
>3, ≤6	+0.75/+3.25	+10.75/+13.25	20	15	95
>6, ≤10	+0.75/+3.25	+13.75/+16.25	20	15	95
>10, ≤15	+1/+4	+16.5/+19.5	20	15	95
>15, ≤18	+1/+4	+16.5/+19.5	20	15	115
>18, ≤30	+1/+5	+19/+23	20	15	115
>30, ≤40	+1.5/+5.5	+23/+27	20	15	115

### H7

(mm)

Code	Diameter
6332-1 *	1
6332-2 *	2
6332-3 *	3
6332-4 *	4
6332-5 *	5
6332-6 *	6
6332-7 *	7
6332-8 *	8
6332-9 *	9
6332-10 *	10
6332-11 *	11
6332-12 *	12
6332-13 *	13
6332-14 *	14
6332-15 *	15
6332-16 *	16

Code	Diameter
6332-17 *	17
6332-18 *	18
6332-19 *	19
6332-20 *	20
6332-21 *	21
6332-22 *	22
6332-23 *	23
6332-24 *	24
6332-25 *	25
6332-26 *	26
6332-27 *	27
6332-28 *	28
6332-29 *	29
6332-30 *	30
6332-31 *	31
6332-32 *	32
6332-33 *	33

Code	Diameter
6332-34 *	34
6332-35 *	35
6332-36 *	36
6332-37 *	37
6332-38 *	38
6332-39 *	39
6332-40 *	40
6332-41 *	41
6332-42 *	42
6332-43 *	43
6332-44 *	44
6332-45 *	45
6332-46 *	46
6332-47 *	47
6332-48 *	48
6332-49 *	49
6332-50 *	50

\* Supplied with manufacturer inspection certificate



**4190-40D000**

- Zirconia material, high strength and hardness, extremely wear resistance and corrosion resistance, good insulation, antistatic and magnetic resistance
- Mirror surface without holes
- Supplied with manufacturer inspection certificate

**Individual**

Code	Diameter	Accuracy	Roundness
4190-1D000	1.000mm	±2µm	0.5µm
4190-1D200	1.200mm	±2µm	0.5µm
4190-1D300	1.300mm	±2µm	0.5µm
4190-1D340	1.340mm	±2µm	0.5µm
4190-1D500	1.500mm	±2µm	0.5µm
4190-1D588	1.588mm (1/16")	±2µm	0.5µm
4190-1D750	1.750mm	±2µm	0.5µm
4190-2D000	2.000mm	±2µm	0.5µm
4190-2D381	2.381mm (3/32")	±2µm	0.5µm
4190-2D500	2.500mm	±2µm	0.5µm
4190-2D778	2.778mm (7/64")	±2µm	0.5µm
4190-3D000	3.000mm	±2µm	0.5µm
4190-3D175	3.175mm (1/8")	±2µm	0.5µm
4190-3D500	3.500mm	±2µm	0.5µm
4190-3D969	3.969mm (5/32")	±2µm	0.5µm
4190-4D000	4.000mm	±2µm	0.5µm
4190-4D500	4.500mm	±2µm	0.5µm
4190-4D763	4.763mm (3/16")	±2µm	0.5µm
4190-5D000	5.000mm	±2µm	0.5µm
4190-5D556	5.556mm (7/32")	±2µm	0.5µm
4190-5D953	5.953mm (15/64")	±2µm	0.5µm
4190-6D000	6.000mm	±2µm	0.5µm
4190-6D350	6.350mm (1/4")	±2µm	0.5µm
4190-6D500	6.500mm	±2µm	0.5µm
4190-6D747	6.747mm (17/64")	±2µm	0.5µm
4190-7D000	7.000mm	±2µm	0.5µm
4190-7D144	7.144mm (9/32")	±2µm	0.5µm
4190-7D500	7.500mm	±2µm	0.5µm
4190-7D938	7.938mm (5/16")	±2µm	0.5µm
4190-8D000	8.000mm	±2µm	0.5µm
4190-8D731	8.731mm (11/32")	±2µm	0.5µm

**Individual**

Code	Diameter	Accuracy	Roundness
4190-9D525	9.525mm (3/8")	±2µm	0.5µm
4190-10D000	10.000mm	±2µm	0.5µm
4190-10D318	10.318mm (13/32")	±2µm	0.5µm
4190-11D000	11.000mm	±2µm	0.5µm
4190-11D113	11.113mm (7/16")	±2µm	0.5µm
4190-11D509	11.509mm (29/64")	±2µm	0.5µm
4190-11D906	11.906mm (15/32")	±2µm	0.5µm
4190-12D000	12.000mm	±2µm	0.5µm
4190-12D303	12.303mm (31/64")	±2µm	0.5µm
4190-12D700	12.700mm (1/2")	±2µm	0.5µm
4190-13D000	13.000mm	±2µm	0.6µm
4190-13D494	13.494mm (17/32")	±2µm	0.6µm
4190-14D000	14.000mm	±2µm	0.6µm
4190-14D288	14.288mm (9/16")	±2µm	0.6µm
4190-15D000	15.000mm	±2µm	0.6µm
4190-15D081	15.081mm (19/32")	±2.5µm	0.6µm
4190-15D875	15.875mm (5/8")	±2.5µm	0.6µm
4190-16D000	16.000mm	±2.5µm	0.6µm
4190-16D669	16.669mm (21/32")	±2.5µm	0.6µm
4190-17D462	17.462mm (11/16")	±2.5µm	0.6µm
4190-18D000	18.000mm	±2.5µm	0.6µm
4190-18D256	18.256mm (23/32")	±2.5µm	0.6µm
4190-19D050	19.050mm (3/4")	±2.5µm	0.6µm
4190-19D844	19.844mm (25/32")	±2.5µm	0.6µm
4190-20D000	20.000mm	±2.5µm	0.6µm
4190-22D000	22.000mm	±2.5µm	1µm
4190-22D225	22.225mm (7/8")	±2.5µm	1µm
4190-23D812	23.812mm (15/16")	±2.5µm	1µm
4190-25D000	25.000mm	±2.5µm	1µm
4190-40D000	40.000mm	±2.5µm	1.5µm

**Set (25 pairs)**

Code	Ceramic balls included (one pair per size)
4190-S25	1, 1.5, 2, 2.5, 3, 3.5, 4, 4.5, 5, 6, 6.5, 7, 7.5, 8, 10, 11, 12, 13, 14, 15, 16, 18, 20, 22, 25mm

## STEEL MEASURING BALLS



- To measure angle and diameter of taper holes
- Material: tool steel
- Hardness: HRC63
- Diameter accuracy:  $\pm 3\mu\text{m}$
- Roundness:  $1\mu\text{m}$
- Supplied with manufacturer inspection certificate



4168-S25

calculate angle ( $\alpha$ ) and diameter ( $D_{\text{max}}$ ) according to the ball diameter ( $d_1$ ,  $d_2$ ), height ( $A$ ) and depth ( $B$ )

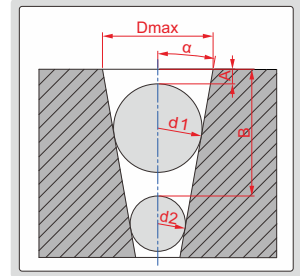

### Individual

Code	Diameter
4168-01	1mm
4168-02	2mm
4168-03	3mm
4168-04	4mm
4168-05	5mm
4168-06	6mm
4168-07	7mm
4168-08	8mm
4168-09	9mm
4168-10	10mm
4168-11	11mm
4168-12	12mm
4168-13	13mm

### Individual

Code	Diameter
4168-14	14mm
4168-15	15mm
4168-16	16mm
4168-17	17mm
4168-18	18mm
4168-19	19mm
4168-20	20mm
4168-21	21mm
4168-22	22mm
4168-23	23mm
4168-24	24mm
4168-25	25mm

### Set (25 pairs)

Code	Steel balls included (one pair per size)
4168-S25	1, 2, 3, 4, 5, 6, 7, 8, 9, 10, 11, 12, 13, 14, 15, 16, 17, 18, 19, 20, 21, 22, 23, 24, 25mm

## THREADED HOLE LOCATION GAGES



ANY SIZE WITHIN THE RANGE OF M3-M150MM CAN BE CUSTOMIZED

ACCURACY CLASS CAN BE CUSTOMIZED

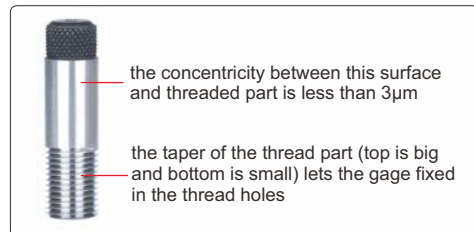

4662-12R



4662-3

Unit: mm

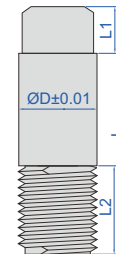

- Hardness: HRC60-63

### application

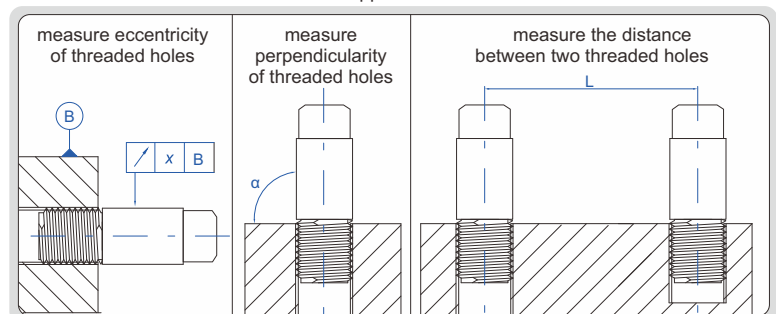

(mm)					
Code	Size	L	L1	L2	ØD
4662-3	M3×0.5-6H	29	8	6	3
4662-4	M4×0.7-6H	31.4	8	8.4	4
4662-5	M5×0.8-6H	32.6	8	9.6	5
4662-6	M6×1-6H	47	10	12	6
4662-8	M8×1.25-6H	50	10	15	8
4662-8P	M8×1-6H	47	10	12	8
4662-10	M10×1.5-6H	53	10	18	10
4662-10P	M10×1-6H	47	10	12	10
4662-12	M12×1.75-6H	56	10	21	12
4662-12P	M12×1-6H	47	10	12	12
4662-12R	M12×1.5-6H	53	10	18	12
4662-14	M14×2-6H	59	10	24	14
4662-14P	M14×1-6H	47	10	12	14
4662-14R	M14×1.5-6H	53	10	18	14
4662-16	M16×2-6H	59	10	24	16
4662-16P	M16×1-6H	47	10	12	16
4662-16R	M16×1.5-6H	53	10	18	16
4662-20	M20×2.5-6H	65	10	30	20
4662-20P	M20×1-6H	47	10	12	20
4662-20R	M20×1.5-6H	53	10	18	20

# THREADED HOLE LOCATION GAGES

**INSIZE PLUS**  
MADE IN EUROPE

**ATTENTION: ONLY FOR THE WORKPIECES THAT THE CHAMFER IS CONCENTRIC WITH THE SCREW PART**



the concentricity between this surface and threaded part is less than 0.01mm



4676-12

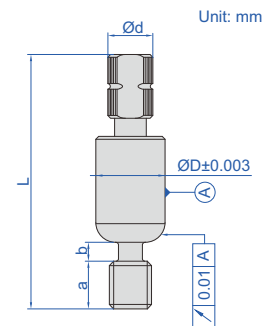

- Only for the workpieces that the chamfer is concentric with the screw part

application

there is a R-shaped guide, which leads the gage to the center of the threaded holes by fitting the R-shaped guide on the chamfer of the threaded holes

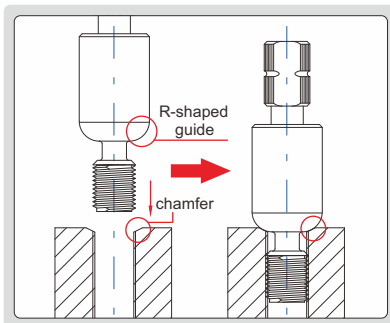
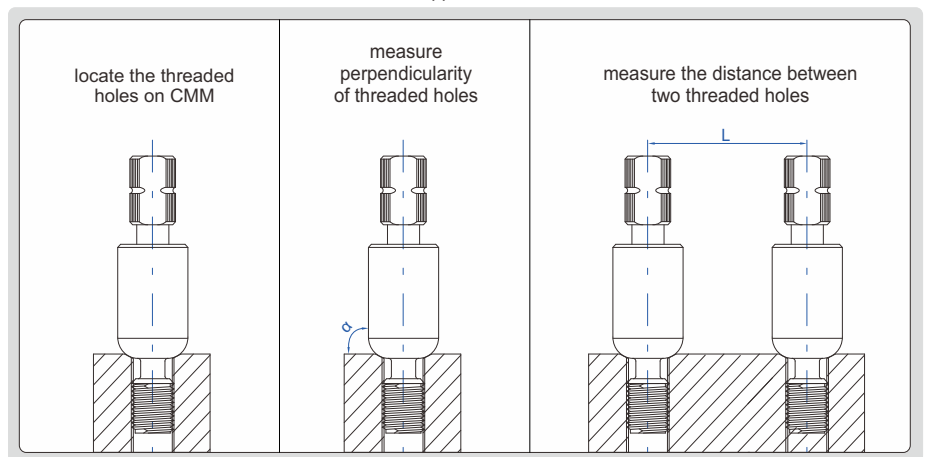
(mm)

Code	Size	Ød	ØD	a	b	L
4676-3	M3×0.5	4	7	4	2	26
4676-4	M4×0.7	4	7	4	2	26
4676-5	M5×0.8	5.5	9	6	2	33
4676-6	M6×1.0	5.5	9	6	2	33
4676-8	M8×1.25	8.5	13	9	3.5	48
4676-10	M10×1.5	8.5	13	9	3.5	48
4676-12	M12×1.75	12	17	10	3.5	55

## DIGITAL THREAD DEPTH GAGES

**INSIZE PLUS**  
MADE IN EUROPE

INSPECTION  
CERTIFICATE

DATA  
OUTPUT



4649-6

- Supplied with GO and NO-GO gages together
- Check GO and NO-GO while measuring the depth of thread holes
- Resolution: 0.01mm/0.0005"
- Depth 0-40mm: accuracy  $\pm 0.04$ mm;  
Depth 40-80mm: accuracy  $\pm 0.06$ mm
- Data output
- Button function: on/of, inch/metric conversion, reading hold, data preset, absolute/incremental measurement
- Battery CR2032, automatic power off, move the digital unit to turn on power
- The GO gage can be replaced after wear
- Optional accessory: data output cable (code **7302-85**), zero block (code **4668-SETTER**), removal tool (code **4668-TOOL**)

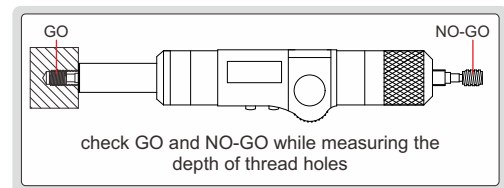
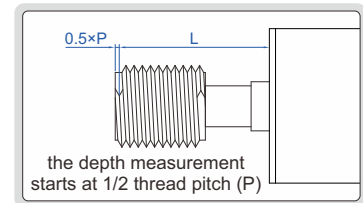

### Metric thread

Code	Size (mm)	Depth range
4649-2 *	M2x0.4-6H	0-8mm
4649-2D5 *	M2.5x0.45-6H	0-10mm
4649-3 *	M3x0.5-6H	0-12mm
4649-3D5 *	M3.5x0.6-6H	0-14mm
4649-4 *	M4x0.7-6H	0-16mm
4649-5 *	M5x0.8-6H	0-20mm
4649-6 *	M6x1-6H	0-24mm
4649-7 *	M7x1-6H	0-28mm
4649-8 *	M8x1.25-6H	0-32mm
4649-10 *	M10x1.5-6H	0-40mm
4649-12 *	M12x1.75-6H	0-48mm
4649-14 *	M14x2-6H	0-56mm
4649-16 *	M16x2-6H	0-64mm
4649-18 *	M18x2.5-6H	0-72mm
4649-20 *	M20x2.5-6H	0-80mm
4649-22 *	M22x2.5-6H	0-80mm
4649-24 *	M24x3-6H	0-80mm
4649-27 *	M27x3-6H	0-80mm
4649-30 *	M30x3.5-6H	0-80mm

### Metric fine thread

Code	Size (mm)	Depth range
4649-8P *	M8x1-6H	0-32mm
4649-10P *	M10x1-6H	0-40mm
4649-10T *	M10x1.25-6H	0-40mm
4649-12P *	M12x1-6H	0-48mm
4649-12T *	M12x1.25-6H	0-48mm
4649-12R *	M12x1.5-6H	0-48mm
4649-14P *	M14x1-6H	0-56mm
4649-14T *	M14x1.25-6H	0-56mm
4649-14R *	M14x1.5-6H	0-56mm
4649-16P *	M16x1-6H	0-64mm
4649-16R *	M16x1.5-6H	0-64mm
4649-18P *	M18x1-6H	0-72mm
4649-18R *	M18x1.5-6H	0-72mm
4649-20P *	M20x1-6H	0-80mm
4649-20R *	M20x1.5-6H	0-80mm
4649-22P *	M22x1-6H	0-80mm
4649-22R *	M22x1.5-6H	0-80mm
4649-24P *	M24x1-6H	0-80mm
4649-24R *	M24x1.5-6H	0-80mm

\* Supplied with manufacturer inspection certificate



## THREAD DEPTH GAGES

**INSIZE PLUS**  
MADE IN EUROPE

**INSPECTION  
CERTIFICATE**



4666-6

- Supplied with GO and NO-GO gages together
- Check GO and NO-GO while measuring the depth thread holes
- The GO gage can be replaced after wear
- Optional accessory: zero block (code 4668-SETTER), removal tool (code 4668-TOOL)



4666-14PA

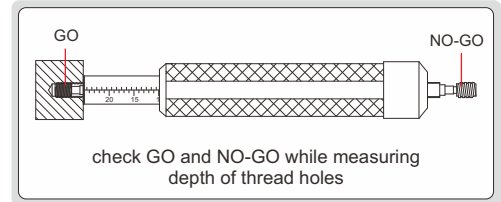
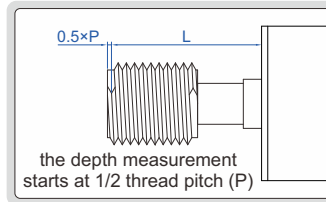

**Metric thread** (without vernier reading, graduation: 0.5mm, accuracy: ±0.25mm)

Code	Size (mm)	Depth range
4666-2*	M2x0.4-6H	0-8mm
4666-2D5*	M2.5x0.45-6H	0-10mm
4666-3*	M3x0.5-6H	0-12mm
4666-3D5*	M3.5x0.6-6H	0-14mm
4666-4*	M4x0.7-6H	0-16mm
4666-5*	M5x0.8-6H	0-20mm
4666-6*	M6x1-6H	0-24mm
4666-7*	M7x1-6H	0-28mm
4666-8*	M8x1.25-6H	0-32mm
4666-10*	M10x1.5-6H	0-40mm
4666-12*	M12x1.75-6H	0-48mm
4666-14*	M14x2-6H	0-56mm
4666-16*	M16x2-6H	0-64mm
4666-18*	M18x2.5-6H	0-72mm
4666-20*	M20x2.5-6H	0-80mm
4666-22*	M22x2.5-6H	0-80mm
4666-24*	M24x3-6H	0-80mm
4666-27*	M27x3-6H	0-80mm
4666-30*	M30x3.5-6H	0-80mm

**Metric thread** (with vernier reading, graduation: 0.1mm, accuracy: ±0.1mm)

Code	Size (mm)	Depth range
4666-2A*	M2x0.4-6H	0-8mm
4666-2D5A*	M2.5x0.45-6H	0-10mm
4666-3A*	M3x0.5-6H	0-12mm
4666-3D5A*	M3.5x0.6-6H	0-14mm
4666-4A*	M4x0.7-6H	0-16mm
4666-5A*	M5x0.8-6H	0-20mm
4666-6A	M6x1-6H	0-24mm
4666-7A*	M7x1-6H	0-28mm
4666-8A*	M8x1.25-6H	0-32mm
4666-10A*	M10x1.5-6H	0-40mm
4666-12A*	M12x1.75-6H	0-48mm
4666-14A*	M14x2-6H	0-56mm
4666-16A*	M16x2-6H	0-64mm
4666-18A*	M18x2.5-6H	0-72mm
4666-20A*	M20x2.5-6H	0-80mm
4666-22A*	M22x2.5-6H	0-80mm
4666-24A*	M24x3-6H	0-80mm
4666-27A*	M27x3-6H	0-80mm
4666-30A*	M30x3.5-6H	0-80mm



**Metric fine thread** (without vernier reading, graduation: 0.5mm, accuracy: ±0.25mm)

Code	Size (mm)	Depth range
4666-8P*	M8x1-6H	0-32mm
4666-10P*	M10x1-6H	0-40mm
4666-10T*	M10x1.25-6H	0-40mm
4666-12P*	M12x1-6H	0-48mm
4666-12T*	M12x1.25-6H	0-48mm
4666-12R*	M12x1.5-6H	0-48mm
4666-14P*	M14x1-6H	0-56mm
4666-14T*	M14x1.25-6H	0-56mm
4666-14R*	M14x1.5-6H	0-56mm
4666-16P*	M16x1-6H	0-64mm
4666-16R*	M16x1.5-6H	0-64mm
4666-18P*	M18x1-6H	0-72mm
4666-18R*	M18x1.5-6H	0-72mm
4666-20P*	M20x1-6H	0-80mm
4666-20R*	M20x1.5-6H	0-80mm
4666-22P*	M22x1-6H	0-80mm
4666-22R*	M22x1.5-6H	0-80mm
4666-24P*	M24x1-6H	0-80mm
4666-24R*	M24x1.5-6H	0-80mm

**Metric fine thread** (with vernier reading, graduation: 0.1mm, accuracy: ±0.1mm)

Code	Size (mm)	Depth range
4666-8PA*	M8x1-6H	0-32mm
4666-10PA*	M10x1-6H	0-40mm
4666-10TA*	M10x1.25-6H	0-40mm
4666-12PA*	M12x1-6H	0-48mm
4666-12TA*	M12x1.25-6H	0-48mm
4666-12RA*	M12x1.5-6H	0-48mm
4666-14PA*	M14x1-6H	0-56mm
4666-14TA*	M14x1.25-6H	0-56mm
4666-14RA*	M14x1.5-6H	0-56mm
4666-16PA*	M16x1-6H	0-64mm
4666-16RA*	M16x1.5-6H	0-64mm
4666-18PA*	M18x1-6H	0-72mm
4666-18RA*	M18x1.5-6H	0-72mm
4666-20PA*	M20x1-6H	0-80mm
4666-20RA*	M20x1.5-6H	0-80mm
4666-22PA*	M22x1-6H	0-80mm
4666-22RA*	M22x1.5-6H	0-80mm
4666-24PA*	M24x1-6H	0-80mm
4666-24RA*	M24x1.5-6H	0-80mm

\* Supplied with manufacturer inspection certificate

## DLC COATED THREAD RING GAGES AND PLUG GAGES



DLC coated GO ring gage



DLC coated GO plug gage

- The DLC coating has the following advantages:
  - High hardness, extremely wear resistance
  - Low friction coefficient
  - Corrosion resistance
- Plug gages: GO is coated, NO-GO is not;  
Ring gages: GO is coated, NO-GO is not
- The following thread ring gages and plug gages are available with DLC coating:
  - Metric fine thread ring gages and plug gages (4139, 4129 series);
  - Metric thread ring gages and plug gages (4130, 4120 series);
  - American standard thread ring gages and plug gages (4131, 4121 series)

Code example:

Original code	DLC coating code
4120-12	4120-12-DLC
4130-4	4130-4-DLC

DLC coating characteristics

Hardness	6000HV
Friction coefficient	0.15
Coating color	interference color

## METRIC THREAD PLUG GAGES

WARNING: LIFE TIME IS LIMITED, CAN BE USED ABOUT 2000 TIMES

- Supplied with Go and No-Go gages together
- Standard ISO1502
- Supplied with manufacturer inspection certificate



4130-10



### Individual

Size (mm)		Code		
Nominal diameter	Pitch	Class 6H	Class 6G	Class 4H
M0.8	0.2	4130-D8	4130-D8G	4130-D8H
M0.9	0.225	4130-D9	4130-D9G	4130-D9H
M1	0.25	4130-1	4130-1G	4130-1H
M1.1	0.25	4130-1D1	4130-1D1G	4130-1D1H
M1.2	0.25	4130-1D2	4130-1D2G	4130-1D2H
M1.4	0.3	4130-1D4	4130-1D4G	4130-1D4H
M1.6	0.35	4130-1D6	4130-1D6G	4130-1D6H
M1.7	0.35	4130-1D7	4130-1D7G	4130-1D7H
M1.8	0.35	4130-1D8	4130-1D8G	4130-1D8H
M2	0.4	4130-2	4130-2G	4130-2H
M2.2	0.45	4130-2D2	4130-2D2G	4130-2D2H
M2.3	0.4	4130-2D3	4130-2D3G	4130-2D3H
M2.5	0.45	4130-2D5	4130-2D5G	4130-2D5H
M2.6	0.45	4130-2D6	4130-2D6G	4130-2D6H
M3	0.5	4130-3	4130-3G	4130-3H
M3.5	0.6	4130-3D5	4130-3D5G	4130-3D5H
M4	0.7	4130-4	4130-4G	4130-4H
M4.5	0.75	4130-4D5	4130-4D5G	4130-4D5H
M5	0.8	4130-5	4130-5G	4130-5H
M6	1	4130-6	4130-6G	4130-6H
M7	1	4130-7	4130-7G	4130-7H
M8	1.25	4130-8	4130-8G	4130-8H

### Individual

Size (mm)		Code		
Nominal diameter	Pitch	Class 6H	Class 6G	Class 4H
M9	1.25	4130-9	4130-9G	4130-9H
M10	1.5	4130-10	4130-10G	4130-10H
M11	1.5	4130-11	4130-11G	4130-11H
M12	1.75	4130-12	4130-12G	4130-12H
M14	2	4130-14	4130-14G	4130-14H
M16	2	4130-16	4130-16G	4130-16H
M18	2.5	4130-18	4130-18G	4130-18H
M20	2.5	4130-20	4130-20G	4130-20H
M22	2.5	4130-22	4130-22G	4130-22H
M24	3	4130-24	4130-24G	4130-24H
M27	3	4130-27	4130-27G	4130-27H
M30	3.5	4130-30	4130-30G	4130-30H
M33	3.5	4130-33	4130-33G	4130-33H
M36	4	4130-36	4130-36G	4130-36H
M39	4	4130-39	4130-39G	4130-39H
M42	4.5	4130-42	4130-42G	4130-42H
M45	4.5	4130-45	4130-45G	4130-45H
M48	5	4130-48	4130-48G	4130-48H
M52	5	4130-52	4130-52G	4130-52H
M56	5.5	4130-56	4130-56G	4130-56H
M60	5.5	4130-60	4130-60G	4130-60H
M64	6	4130-64	4130-64G	4130-64H
M68	6	4130-68	4130-68G	4130-68H

### Set (class 6H)

Code	Thread plug gages included (mm)
4130-S7	M3x0.5 (4130-3), M4x0.7 (4130-4), M5x0.8 (4130-5), M6x1 (4130-6), M8x1.25 (4130-8), M10x1.5 (4130-10), M12x1.75 (4130-12)

WARNING: LIFE TIME IS LIMITED,  
CAN BE USED ABOUT 2000 TIMES

## METRIC FINE THREAD PLUG GAGES



4139-20G

- Supplied with Go and No-Go gages together
- Standard ISO1502
- Supplied with manufacturer inspection certificate

Code example:  
"-1A" stands for "4139-1A"

Size (mm)		Code (4139)		
Nominal diameter	Pitch	Class 6H	Class 6G	Class 4H
M1	0.2	-1A	-1AG	-1AH
M1.2	0.2	-1D2A	-1D2AG	-1D2AH
M1.4	0.2	-1D4A	-1D4AG	-1D4AH
M1.6	0.2	-1D6A	-1D6AG	-1D6AH
M1.8	0.2	-1D8A	-1D8AG	-1D8AH
M2	0.2	-2A	-2AG	-2AH
	0.25	-2B	-2BG	-2BH
M2.5	0.2	-2D5A	-2D5AG	-2D5AH
	0.25	-2D5B	-2D5BG	-2D5BH
	0.35	-2D5D	-2D5DG	-2D5DH
M3	0.25	-3B	-3BG	-3BH
	0.35	-3D	-3DG	-3DH
M3.5	0.25	-3D5B	-3D5BG	-3D5BH
	0.35	-3D5D	-3D5DG	-3D5DH
	0.5	-3D5G	-3D5GG	-3D5GH
M4	0.25	-4B	-4BG	-4BH
	0.35	-4D	-4DG	-4DH
	0.5	-4G	-4GG	-4GH
M4.5	0.35	-4D5D	-4D5DG	-4D5DH
	0.5	-4D5G	-4D5GG	-4D5GH
M5	0.25	-5B	-5BG	-5BH
	0.35	-5D	-5DG	-5DH
	0.5	-5G	-5GG	-5GH
M5.5	0.5	-5D5G	-5D5GG	-5D5GH
M6	0.25	-6B	-6BG	-6BH
	0.35	-6D	-6DG	-6DH
M6.5	0.5	-6G	-6GG	-6GH
	0.5	-6D5G	-6D5GG	-6D5GH
M7	0.35	-7D	-7DG	-7DH
	0.5	-7G	-7GG	-7GH
M7.5	0.5	-7D5G	-7D5GG	-7D5GH
M8	0.35	-8D	-8DG	-8DH
	0.5	-8G	-8GG	-8GH

Size (mm)		Code (4139)		
Nominal diameter	Pitch	Class 6H	Class 6G	Class 4H
M8	1	-8P	-8PG	-8PH
M8.5	0.5	-8D5G	-8D5GG	-8D5GH
	0.35	-9D	-9DG	-9DH
M9	0.5	-9G	-9GG	-9GH
	0.75	-9L	-9LG	-9LH
	1	-9P	-9PG	-9PH
M10	0.35	-10D	-10DG	-10DH
	0.5	-10G	-10GG	-10GH
	1	-10P	-10PG	-10PH
	1.25	-10Q	-10QG	-10QH
M11	0.5	-11G	-11GG	-11GH
	1	-11P	-11PG	-11PH
M12	0.5	-12G	-12GG	-12GH
	1	-12P	-12PG	-12PH
	1.25	-12Q	-12QG	-12QH
	1.5	-12R	-12RG	-12RH
M13	0.5	-13G	-13GG	-13GH
	1	-13P	-13PG	-13PH
M14	1.5	-13R	-13RG	-13RH
	0.5	-14G	-14GG	-14GH
M14	1	-14P	-14PG	-14PH
	1.25	-14Q	-14QG	-14QH
	1.5	-14R	-14RG	-14RH
M15	0.5	-15G	-15GG	-15GH
	1	-15P	-15PG	-15PH
M16	1.5	-15R	-15RG	-15RH
	0.5	-16G	-16GG	-16GH
	1	-16P	-16PG	-16PH
	1.25	-16Q	-16QG	-16QH
M17	1.5	-16R	-16RG	-16RH
	0.5	-17G	-17GG	-17GH
	1	-17P	-17PG	-17PH
M17	1.5	-17R	-17RG	-17RH

To be continued

Continued from previous page

Size (mm)		Code (4139)		
Nominal diameter	Pitch	Class 6H	Class 6G	Class 4H
M18	0.5	-18G	-18GG	-18GH
	1	-18P	-18PG	-18PH
	1.25	-18Q	-18QG	-18QH
	1.5	-18R	-18RG	-18RH
	2	-18T	-18TG	-18TH
M19	0.5	-19G	-19GG	-19GH
	1	-19P	-19PG	-19PH
	1.5	-19R	-19RG	-19RH
M20	0.5	-20G	-20GG	-20GH
	1	-20P	-20PG	-20PH
	1.25	-20Q	-20QG	-20QH
	1.5	-20R	-20RG	-20RH
	2	-20T	-20TG	-20TH
M21	0.5	-21G	-21GG	-21GH
	1	-21P	-21PG	-21PH
	1.5	-21R	-21RG	-21RH
M22	0.5	-22G	-22GG	-22GH
	1	-22P	-22PG	-22PH
	1.25	-22Q	-22QG	-22QH
	1.5	-22R	-22RG	-22RH
M23	0.5	-23G	-23GG	-23GH
	1	-23P	-23PG	-23PH
M24	0.5	-24G	-24GG	-24GH
	1	-24P	-24PG	-24PH
	1.25	-24Q	-24QG	-24QH
	1.5	-24R	-24RG	-24RH
M25	0.5	-25G	-25GG	-25GH
	1	-25P	-25PG	-25PH
	1.5	-25R	-25RG	-25RH
	2	-25T	-25TG	-25TH
M26	0.5	-26G	-26GG	-26GH
	1	-26P	-26PG	-26PH
	1.5	-26R	-26RG	-26RH
	2	-26T	-26TG	-26TH
M27	0.5	-27G	-27GG	-27GH
	1	-27P	-27PG	-27PH
	1.5	-27R	-27RG	-27RH
	2	-27T	-27TG	-27TH
M28	0.5	-28G	-28GG	-28GH
	1	-28P	-28PG	-28PH
	1.5	-28R	-28RG	-28RH
M29	0.5	-29G	-29GG	-29GH
	0.75	-29L	-29LG	-29LH
	1	-29P	-29PG	-29PH
M30	0.5	-30G	-30GG	-30GH
	0.75	-30L	-30LG	-30LH
	1	-30P	-30PG	-30PH
	1.5	-30R	-30RG	-30RH
	2	-30T	-30TG	-30TH
	3	-30V	-30VG	-30VH

Size (mm)		Code (4139)		
Nominal diameter	Pitch	Class 6H	Class 6G	Class 4H
M31	0.5	-31G	-31GG	-31GH
	0.75	-31L	-31LG	-31LH
M32	0.5	-32G	-32GG	-32GH
	0.75	-32L	-32LG	-32LH
	1	-32P	-32PG	-32PH
	1.5	-32R	-32RG	-32RH
M33	2	-32T	-32TG	-32TH
	0.5	-33G	-33GG	-33GH
	0.75	-33L	-33LG	-33LH
	1	-33P	-33PG	-33PH
	1.5	-33R	-33RG	-33RH
M34	2	-33T	-33TG	-33TH
	3	-33V	-33VG	-33VH
	0.75	-34L	-34LG	-34LH
	1	-34P	-34PG	-34PH
M35	1.5	-34R	-34RG	-34RH
	2	-34T	-34TG	-34TH
	0.75	-35L	-35LG	-35LH
M36	1	-35P	-35PG	-35PH
	1.5	-35R	-35RG	-35RH
	2	-35T	-35TG	-35TH
	0.75	-36L	-36LG	-36LH
M37	1	-36P	-36PG	-36PH
	1.5	-36R	-36RG	-36RH
	2	-36T	-36TG	-36TH
M38	3	-36V	-36VG	-36VH
	0.75	-37L	-37LG	-37LH
	1	-37P	-37PG	-37PH
	1.5	-37R	-37RG	-37RH
M39	2	-37T	-37TG	-37TH
	0.75	-38L	-38LG	-38LH
	1	-38P	-38PG	-38PH
M40	1.5	-38R	-38RG	-38RH
	2	-38T	-38TG	-38TH
	0.75	-39L	-39LG	-39LH
	1	-39P	-39PG	-39PH
M42	1.5	-39R	-39RG	-39RH
	2	-39T	-39TG	-39TH
	3	-39V	-39VG	-39VH
M45	0.75	-40L	-40LG	-40LH
	1	-40P	-40PG	-40PH
	1.5	-40R	-40RG	-40RH
	2	-40T	-40TG	-40TH
M48	3	-40V	-40VG	-40VH
	1	-42P	-42PG	-42PH
	1.5	-42R	-42RG	-42RH
M45	2	-42T	-42TG	-42TH
	3	-42V	-42VG	-42VH
	1	-45P	-45PG	-45PH
	1.5	-45R	-45RG	-45RH
M48	2	-45T	-45TG	-45TH
	3	-45V	-45VG	-45VH
	1	-48P	-48PG	-48PH
	1.5	-48R	-48RG	-48RH
	2	-48T	-48TG	-48TH
	3	-48V	-48VG	-48VH

To be continued



Continued from previous page

Size (mm)		Code (4139)		
Nominal diameter	Pitch	Class 6H	Class 6G	Class 4H
M50	1	-50P	-50PG	-50PH
	1.5	-50R	-50RG	-50RH
	2	-50T	-50TG	-50TH
	3	-50V	-50VG	-50VH
M52	1	-52P	-52PG	-52PH
	1.5	-52R	-52RG	-52RH
	2	-52T	-52TG	-52TH
	3	-52V	-52VG	-52VH
	4	-52X	-52XG	-52XH
M55	1	-55P	-55PG	-55PH
	1.5	-55R	-55RG	-55RH
	2	-55T	-55TG	-55TH
	3	-55V	-55VG	-55VH
	4	-55X	-55XG	-55XH
M56	1	-56P	-56PG	-56PH
	1.5	-56R	-56RG	-56RH
	2	-56T	-56TG	-56TH
	3	-56V	-56VG	-56VH
	4	-56X	-56XG	-56XH
M58	1	-58P	-58PG	-58PH
	1.5	-58R	-58RG	-58RH
	2	-58T	-58TG	-58TH
	3	-58V	-58VG	-58VH
	4	-58X	-58XG	-58XH
M60	1	-60P	-60PG	-60PH
	1.5	-60R	-60RG	-60RH
	2	-60T	-60TG	-60TH
	3	-60V	-60VG	-60VH
	4	-60X	-60XG	-60XH
M62	1.5	-62R	-62RG	-62RH
	2	-62T	-62TG	-62TH
	3	-62V	-62VG	-62VH
	4	-62X	-62XG	-62XH
M64	1.5	-64R	-64RG	-64RH
	2	-64T	-64TG	-64TH
	3	-64V	-64VG	-64VH
	4	-64X	-64XG	-64XH
M65	1.5	-65R	-65RG	-65RH
	2	-65T	-65TG	-65TH
	3	-65V	-65VG	-65VH
	4	-65X	-65XG	-65XH
M68	1.5	-68R	-68RG	-68RH
	2	-68T	-68TG	-68TH
	3	-68V	-68VG	-68VH
	4	-68X	-68XG	-68XH
M70	1.5	-70R	-70RG	-70RH
	2	-70T	-70TG	-70TH
	3	-70V	-70VG	-70VH
	4	-70X	-70XG	-70XH
M72	6	-70O	-70OG	-70OH
	1.5	-72R	-72RG	-72RH

Size (mm)		Code (4139)		
Nominal diameter	Pitch	Class 6H	Class 6G	Class 4H
M72	2	-72T	-72TG	-72TH
	3	-72V	-72VG	-72VH
	4	-72X	-72XG	-72XH
	6	-72O	-72OG	-72OH
M75	1.5	-75R	-75RG	-75RH
	2	-75T	-75TG	-75TH
	3	-75V	-75VG	-75VH
	4	-75X	-75XG	-75XH
M76	1.5	-76R	-76RG	-76RH
	2	-76T	-76TG	-76TH
	3	-76V	-76VG	-76VH
	4	-76X	-76XG	-76XH
M78	6	-76O	-76OG	-76OH
	2	-78T	-78TG	-78TH
M80	1.5	-80R	-80RG	-80RH
	2	-80T	-80TG	-80TH
	3	-80V	-80VG	-80VH
	4	-80X	-80XG	-80XH
M82	6	-80O	-80OG	-80OH
	2	-82T	-82TG	-82TH
M85	2	-85T	-85TG	-85TH
	3	-85V	-85VG	-85VH
	4	-85X	-85XG	-85XH
	6	-85O	-85OG	-85OH
M90	2	-90T	-90TG	-90TH
	3	-90V	-90VG	-90VH
	4	-90X	-90XG	-90XH
	6	-90O	-90OG	-90OH
M95	2	-95T	-95TG	-95TH
	3	-95V	-95VG	-95VH
	4	-95X	-95XG	-95XH
	6	-95O	-95OG	-95OH
M100	2	-100T	-100TG	-100TH
	3	-100V	-100VG	-100VH
	4	-100X	-100XG	-100XH
	6	-100O	-100OG	-100OH
M105	2	-105T	-105TG	-105TH
	3	-105V	-105VG	-105VH
	4	-105X	-105XG	-105XH
	6	-105O	-105OG	-105OH
M110	2	-110T	-110TG	-110TH
	3	-110V	-110VG	-110VH
	4	-110X	-110XG	-110XH
	6	-110O	-110OG	-110OH
M115	2	-115T	-115TG	-115TH
	3	-115V	-115VG	-115VH
	4	-115X	-115XG	-115XH
	6	-115O	-115OG	-115OH
M120	2	-120T	-120TG	-120TH
	3	-120V	-120VG	-120VH
	4	-120X	-120XG	-120XH
	6	-120O	-120OG	-120OH

# METRIC THREAD RING GAGES

WARNING: LIFE TIME IS LIMITED, CAN BE USED ABOUT 2000 TIMES



- Standard ISO1502
- Supplied with manufacturer inspection certificate



4120-16



4120-16N

Code example:  
"-2" stands for "4120-2"

### Individual

Size (mm)		Code (4120)					
		Class 6g		Class 6e		Class 6h	
Nominal diameter	Pitch	GO	NOGO	GO	NOGO	GO	NOGO
M2	0.4	-2	-2N	-2E	-2EN	-2H	-2HN
M2.2	0.45	-2D2	-2D2N	-2D2E	-2D2EN	-2D2H	-2D2HN
M2.3	0.4	-2D3	-2D3N	-2D3E	-2D3EN	-2D3H	-2D3HN
M2.5	0.45	-2D5	-2D5N	-2D5E	-2D5EN	-2D5H	-2D5HN
M2.6	0.45	-2D6	-2D6N	-2D6E	-2D6EN	-2D6H	-2D6HN
M3	0.5	-3	-3N	-3E	-3EN	-3H	-3HN
M3.5	0.6	-3D5	-3D5N	-3D5E	-3D5EN	-3D5H	-3D5HN
M4	0.7	-4	-4N	-4E	-4EN	-4H	-4HN
M4.5	0.75	-4D5	-4D5N	-4D5E	-4D5EN	-4D5H	-4D5HN
M5	0.8	-5	-5N	-5E	-5EN	-5H	-5HN
M6	1	-6	-6N	-6E	-6EN	-6H	-6HN
M7	1	-7	-7N	-7E	-7EN	-7H	-7HN
M8	1.25	-8	-8N	-8E	-8EN	-8H	-8HN
M9	1.25	-9	-9N	-9E	-9EN	-9H	-9HN
M10	1.5	-10	-10N	-10E	-10EN	-10H	-10HN
M11	1.5	-11	-11N	-11E	-11EN	-11H	-11HN
M12	1.75	-12	-12N	-12E	-12EN	-12H	-12HN
M14	2	-14	-14N	-14E	-14EN	-14H	-14HN
M16	2	-16	-16N	-16E	-16EN	-16H	-16HN
M18	2.5	-18	-18N	-18E	-18EN	-18H	-18HN
M20	2.5	-20	-20N	-20E	-20EN	-20H	-20HN
M22	2.5	-22	-22N	-22E	-22EN	-22H	-22HN
M24	3	-24	-24N	-24E	-24EN	-24H	-24HN
M27	3	-27	-27N	-27E	-27EN	-27H	-27HN
M30	3.5	-30	-30N	-30E	-30EN	-30H	-30HN
M33	3.5	-33	-33N	-33E	-33EN	-33H	-33HN
M36	4	-36	-36N	-36E	-36EN	-36H	-36HN
M39	4	-39	-39N	-39E	-39EN	-39H	-39HN
M42	4.5	-42	-42N	-42E	-42EN	-42H	-42HN
M45	4.5	-45	-45N	-45E	-45EN	-45H	-45HN
M48	5	-48	-48N	-48E	-48EN	-48H	-48HN
M52	5	-52	-52N	-52E	-52EN	-52H	-52HN
M56	5.5	-56	-56N	-56E	-56EN	-56H	-56HN
M60	5.5	-60	-60N	-60E	-60EN	-60H	-60HN
M64	6	-64	-64N	-64E	-64EN	-64H	-64HN
M68	6	-68	-68N	-68E	-68EN	-68H	-68HN

### Go ring gage set (Class 6g)

Code	Thread ring gages included (mm)
4120-S7	M3x0.5 (4120-3), M4x0.7 (4120-4), M5x0.8 (4120-5), M6x1 (4120-6), M8x1.25 (4120-8), M10x1.5 (4120-10), M12x1.75 (4120-12)

### No Go ring gage set (Class 6g)

Code	Thread ring gages included (mm)
4120-S7N	M3x0.5 (4120-3N), M4x0.7 (4120-4N), M5x0.8 (4120-5N), M6x1 (4120-6N), M8x1.25 (4120-8N), M10x1.5 (4120-10N), M12x1.75 (4120-12N)



WARNING: LIFE TIME IS LIMITED,  
CAN BE USED ABOUT 2000 TIMES

## METRIC FINE THREAD RING GAGES

- Standard ISO1502
- Supplied with manufacturer inspection certificate (except gages larger than M100)



4129-10P



4129-10PN

Code example:  
"-3D5G" stands for "4129-3D5G"

Size (mm)		Code (4129)					
Nominal diameter	Pitch	Class 6g		Class 6e		Class 6h	
		GO	NOGO	GO	NOGO	GO	NOGO
M3.5	0.5	-3D5G	-3D5GN	-3D5GE	-3D5GEN	-3D5GH	-3D5GHN
M4	0.5	-4G	-4GN	-4GE	-4GEN	-4GH	-4GHN
M4.5	0.5	-4D5G	-4D5GN	-4D5GE	-4D5GEN	-4D5GH	-4D5GHN
M5	0.5	-5G	-5GN	-5GE	-5GEN	-5GH	-5GHN
M5.5	0.5	-5D5G	-5D5GN	-5D5GE	-5D5GEN	-5D5GH	-5D5GHN
M6	0.5	-6G	-6GN	-6GE	-6GEN	-6GH	-6GHN
	0.75	-6L	-6LN	-6LE	-6LEN	-6LH	-6LHN
M6.5	0.5	-6D5G	-6D5GN	-6D5GE	-6D5GEN	-6D5GH	-6D5GHN
M7	0.5	-7G	-7GN	-7GE	-7GEN	-7GH	-7GHN
	0.75	-7L	-7LN	-7LE	-7LEN	-7LH	-7LHN
M7.5	0.5	-7D5G	-7D5GN	-7D5GE	-7D5GEN	-7D5GH	-7D5GHN
M8	0.5	-8G	-8GN	-8GE	-8GEN	-8GH	-8GHN
	0.75	-8L	-8LN	-8LE	-8LEN	-8LH	-8LHN
	1	-8P	-8PN	-8PE	-8PEN	-8PH	-8PHN
M8.5	0.5	-8D5G	-8D5GN	-8D5GE	-8D5GEN	-8D5GH	-8D5GHN
M9	0.5	-9G	-9GN	-9GE	-9GEN	-9GH	-9GHN
	0.75	-9L	-9LN	-9LE	-9LEN	-9LH	-9LHN
	1	-9P	-9PN	-9PE	-9PEN	-9PH	-9PHN
M10	0.5	-10G	-10GN	-10GE	-10GEN	-10GH	-10GHN
	0.75	-10L	-10LN	-10LE	-10LEN	-10LH	-10LHN
	1	-10P	-10PN	-10PE	-10PEN	-10PH	-10PHN
	1.25	-10Q	-10QN	-10QE	-10QEN	-10QH	-10QHN
M11	0.5	-11G	-11GN	-11GE	-11GEN	-11GH	-11GHN
	0.75	-11L	-11LN	-11LE	-11LEN	-11LH	-11LHN
	1	-11P	-11PN	-11PE	-11PEN	-11PH	-11PHN
M12	0.5	-12G	-12GN	-12GE	-12GEN	-12GH	-12GHN
	0.75	-12L	-12LN	-12LE	-12LEN	-12LH	-12LHN
	1	-12P	-12PN	-12PE	-12PEN	-12PH	-12PHN
	1.25	-12Q	-12QN	-12QE	-12QEN	-12QH	-12QHN
M13	1.5	-12R	-12RN	-12RE	-12REN	-12RH	-12RHN
	0.5	-13G	-13GN	-13GE	-13GEN	-13GH	-13GHN
	0.75	-13L	-13LN	-13LE	-13LEN	-13LH	-13LHN
M14	1	-13P	-13PN	-13PE	-13PEN	-13PH	-13PHN
	1.5	-13R	-13RN	-13RE	-13REN	-13RH	-13RHN
	0.5	-14G	-14GN	-14GE	-14GEN	-14GH	-14GHN
M14	0.75	-14L	-14LN	-14LE	-14LEN	-14LH	-14LHN
	1	-14P	-14PN	-14PE	-14PEN	-14PH	-14PHN
	1.25	-14Q	-14QN	-14QE	-14QEN	-14QH	-14QHN
	1.5	-14R	-14RN	-14RE	-14REN	-14RH	-14RHN

To be continued

Continued from previous page

Size (mm)		Code (4129)					
		Class 6g		Class 6e		Class 6h	
Nominal diameter	Pitch	GO	NOGO	GO	NOGO	GO	NOGO
M15	0.5	-15G	-15GN	-15GE	-15GEN	-15GH	-15GHN
	0.75	-15L	-15LN	-15LE	-15LEN	-15LH	-15LHN
	1	-15P	-15PN	-15PE	-15PEN	-15PH	-15PHN
	1.5	-15R	-15RN	-15RE	-15REN	-15RH	-15RHN
M16	0.5	-16G	-16GN	-16GE	-16GEN	-16GH	-16GHN
	0.75	-16L	-16LN	-16LE	-16LEN	-16LH	-16LHN
	1	-16P	-16PN	-16PE	-16PEN	-16PH	-16PHN
	1.25	-16Q	-16QN	-16QE	-16QEN	-16QH	-16QHN
	1.5	-16R	-16RN	-16RE	-16REN	-16RH	-16RHN
M17	0.5	-17G	-17GN	-17GE	-17GEN	-17GH	-17GHN
	0.75	-17L	-17LN	-17LE	-17LEN	-17LH	-17LHN
	1	-17P	-17PN	-17PE	-17PEN	-17PH	-17PHN
	1.5	-17R	-17RN	-17RE	-17REN	-17RH	-17RHN
M18	0.5	-18G	-18GN	-18GE	-18GEN	-18GH	-18GHN
	0.75	-18L	-18LN	-18LE	-18LEN	-18LH	-18LHN
	1	-18P	-18PN	-18PE	-18PEN	-18PH	-18PHN
	1.25	-18Q	-18QN	-18QE	-18QEN	-18QH	-18QHN
	1.5	-18R	-18RN	-18RE	-18REN	-18RH	-18RHN
	2	-18T	-18TN	-18TE	-18TEN	-18TH	-18THN
M19	0.5	-19G	-19GN	-19GE	-19GEN	-19GH	-19GHN
	0.75	-19L	-19LN	-19LE	-19LEN	-19LH	-19LHN
	1	-19P	-19PN	-19PE	-19PEN	-19PH	-19PHN
	1.5	-19R	-19RN	-19RE	-19REN	-19RH	-19RHN
M20	0.5	-20G	-20GN	-20GE	-20GEN	-20GH	-20GHN
	0.75	-20L	-20LN	-20LE	-20LEN	-20LH	-20LHN
	1	-20P	-20PN	-20PE	-20PEN	-20PH	-20PHN
	1.25	-20Q	-20QN	-20QE	-20QEN	-20QH	-20QHN
	1.5	-20R	-20RN	-20RE	-20REN	-20RH	-20RHN
	2	-20T	-20TN	-20TE	-20TEN	-20TH	-20THN
M21	0.75	-21L	-21LN	-21LE	-21LEN	-21LH	-21LHN
	1	-21P	-21PN	-21PE	-21PEN	-21PH	-21PHN
	1.5	-21R	-21RN	-21RE	-21REN	-21RH	-21RHN
M22	0.75	-22L	-22LN	-22LE	-22LEN	-22LH	-22LHN
	1	-22P	-22PN	-22PE	-22PEN	-22PH	-22PHN
	1.25	-22Q	-22QN	-22QE	-22QEN	-22QH	-22QHN
	1.5	-22R	-22RN	-22RE	-22REN	-22RH	-22RHN
	2	-22T	-22TN	-22TE	-22TEN	-22TH	-22THN
M23	0.75	-23L	-23LN	-23LE	-23LEN	-23LH	-23LHN
	1	-23P	-23PN	-23PE	-23PEN	-23PH	-23PHN
M24	0.75	-24L	-24LN	-24LE	-24LEN	-24LH	-24LHN
	1	-24P	-24PN	-24PE	-24PEN	-24PH	-24PHN
	1.25	-24Q	-24QN	-24QE	-24QEN	-24QH	-24QHN
	1.5	-24R	-24RN	-24RE	-24REN	-24RH	-24RHN
	2	-24T	-24TN	-24TE	-24TEN	-24TH	-24THN
M25	0.75	-25L	-25LN	-25LE	-25LEN	-25LH	-25LHN
	1	-25P	-25PN	-25PE	-25PEN	-25PH	-25PHN
	1.5	-25R	-25RN	-25RE	-25REN	-25RH	-25RHN
	2	-25T	-25TN	-25TE	-25TEN	-25TH	-25THN
M26	0.75	-26L	-26LN	-26LE	-26LEN	-26LH	-26LHN
	1	-26P	-26PN	-26PE	-26PEN	-26PH	-26PHN
	1.5	-26R	-26RN	-26RE	-26REN	-26RH	-26RHN
	2	-26T	-26TN	-26TE	-26TEN	-26TH	-26THN

To be continued





Continued from previous page

Size (mm)		Code (4129)					
		Class 6g		Class 6e		Class 6h	
Nominal diameter	Pitch	GO	NOGO	GO	NOGO	GO	NOGO
M27	0.75	-27L	-27LN	-27LE	-27LEN	-27LH	-27LHN
	1	-27P	-27PN	-27PE	-27PEN	-27PH	-27PHN
	1.5	-27R	-27RN	-27RE	-27REN	-27RH	-27RHN
	2	-27T	-27TN	-27TE	-27TEN	-27TH	-27THN
M28	0.75	-28L	-28LN	-28LE	-28LEN	-28LH	-28LHN
	1	-28P	-28PN	-28PE	-28PEN	-28PH	-28PHN
	1.5	-28R	-28RN	-28RE	-28REN	-28RH	-28RHN
	2	-28T	-28TN	-28TE	-28TEN	-28TH	-28THN
M29	0.75	-29L	-29LN	-29LE	-29LEN	-29LH	-29LHN
	1	-29P	-29PN	-29PE	-29PEN	-29PH	-29PHN
M30	0.75	-30L	-30LN	-30LE	-30LEN	-30LH	-30LHN
	1	-30P	-30PN	-30PE	-30PEN	-30PH	-30PHN
	1.5	-30R	-30RN	-30RE	-30REN	-30RH	-30RHN
	2	-30T	-30TN	-30TE	-30TEN	-30TH	-30THN
M31	3	-30V	-30VN	-30VE	-30VEN	-30VH	-30VHN
	0.75	-31L	-31LN	-31LE	-31LEN	-31LH	-31LHN
M32	0.75	-32L	-32LN	-32LE	-32LEN	-32LH	-32LHN
	1	-32P	-32PN	-32PE	-32PEN	-32PH	-32PHN
	1.5	-32R	-32RN	-32RE	-32REN	-32RH	-32RHN
M33	2	-32T	-32TN	-32TE	-32TEN	-32TH	-32THN
	0.75	-33L	-33LN	-33LE	-33LEN	-33LH	-33LHN
	1	-33P	-33PN	-33PE	-33PEN	-33PH	-33PHN
	1.5	-33R	-33RN	-33RE	-33REN	-33RH	-33RHN
M34	2	-33T	-33TN	-33TE	-33TEN	-33TH	-33THN
	3	-33V	-33VN	-33VE	-33VEN	-33VH	-33VHN
	1	-34P	-34PN	-34PE	-34PEN	-34PH	-34PHN
	1.5	-34R	-34RN	-34RE	-34REN	-34RH	-34RHN
M35	2	-34T	-34TN	-34TE	-34TEN	-34TH	-34THN
	1	-35P	-35PN	-35PE	-35PEN	-35PH	-35PHN
M36	1.5	-35R	-35RN	-35RE	-35REN	-35RH	-35RHN
	2	-35T	-35TN	-35TE	-35TEN	-35TH	-35THN
M38	1	-36P	-36PN	-36PE	-36PEN	-36PH	-36PHN
	1.5	-36R	-36RN	-36RE	-36REN	-36RH	-36RHN
	2	-36T	-36TN	-36TE	-36TEN	-36TH	-36THN
M39	3	-36V	-36VN	-36VE	-36VEN	-36VH	-36VHN
	1	-38P	-38PN	-38PE	-38PEN	-38PH	-38PHN
	1.5	-38R	-38RN	-38RE	-38REN	-38RH	-38RHN
M40	2	-38T	-38TN	-38TE	-38TEN	-38TH	-38THN
	1	-39P	-39PN	-39PE	-39PEN	-39PH	-39PHN
	1.5	-39R	-39RN	-39RE	-39REN	-39RH	-39RHN
M42	2	-39T	-39TN	-39TE	-39TEN	-39TH	-39THN
	3	-39V	-39VN	-39VE	-39VEN	-39VH	-39VHN
	1.5	-40R	-40RN	-40RE	-40REN	-40RH	-40RHN
M45	2	-40T	-40TN	-40TE	-40TEN	-40TH	-40THN
	3	-40V	-40VN	-40VE	-40VEN	-40VH	-40VHN
	1.5	-42R	-42RN	-42RE	-42REN	-42RH	-42RHN
M45	2	-42T	-42TN	-42TE	-42TEN	-42TH	-42THN
	3	-42V	-42VN	-42VE	-42VEN	-42VH	-42VHN
	1.5	-45R	-45RN	-45RE	-45REN	-45RH	-45RHN
M45	2	-45T	-45TN	-45TE	-45TEN	-45TH	-45THN
	3	-45V	-45VN	-45VE	-45VEN	-45VH	-45VHN

To be continued

Continued from previous page

Size (mm)		Code (4129)					
Nominal diameter	Pitch	Class 6g		Class 6e		Class 6h	
		GO	NOGO	GO	NOGO	GO	NOGO
M48	1.5	-48R	-48RN	-48RE	-48REN	-48RH	-48RHN
	2	-48T	-48TN	-48TE	-48TEN	-48TH	-48THN
	3	-48V	-48VN	-48VE	-48VEN	-48VH	-48VHN
M50	1.5	-50R	-50RN	-50RE	-50REN	-50RH	-50RHN
	2	-50T	-50TN	-50TE	-50TEN	-50TH	-50THN
	3	-50V	-50VN	-50VE	-50VEN	-50VH	-50VHN
M52	1.5	-52R	-52RN	-52RE	-52REN	-52RH	-52RHN
	2	-52T	-52TN	-52TE	-52TEN	-52TH	-52THN
	3	-52V	-52VN	-52VE	-52VEN	-52VH	-52VHN
	4	-52X	-52XN	-52XE	-52XEN	-52XH	-52XHN
M55	1.5	-55R	-55RN	-55RE	-55REN	-55RH	-55RHN
	2	-55T	-55TN	-55TE	-55TEN	-55TH	-55THN
	3	-55V	-55VN	-55VE	-55VEN	-55VH	-55VHN
	4	-55X	-55XN	-55XE	-55XEN	-55XH	-55XHN
M56	1.5	-56R	-56RN	-56RE	-56REN	-56RH	-56RHN
	2	-56T	-56TN	-56TE	-56TEN	-56TH	-56THN
	3	-56V	-56VN	-56VE	-56VEN	-56VH	-56VHN
	4	-56X	-56XN	-56XE	-56XEN	-56XH	-56XHN
M58	1.5	-58R	-58RN	-58RE	-58REN	-58RH	-58RHN
	2	-58T	-58TN	-58TE	-58TEN	-58TH	-58THN
	3	-58V	-58VN	-58VE	-58VEN	-58VH	-58VHN
	4	-58X	-58XN	-58XE	-58XEN	-58XH	-58XHN
M60	1.5	-60R	-60RN	-60RE	-60REN	-60RH	-60RHN
	2	-60T	-60TN	-60TE	-60TEN	-60TH	-60THN
	3	-60V	-60VN	-60VE	-60VEN	-60VH	-60VHN
	4	-60X	-60XN	-60XE	-60XEN	-60XH	-60XHN
M62	1.5	-62R	-62RN	-62RE	-62REN	-62RH	-62RHN
	2	-62T	-62TN	-62TE	-62TEN	-62TH	-62THN
	3	-62V	-62VN	-62VE	-62VEN	-62VH	-62VHN
	4	-62X	-62XN	-62XE	-62XEN	-62XH	-62XHN
M64	1.5	-64R	-64RN	-64RE	-64REN	-64RH	-64RHN
	2	-64T	-64TN	-64TE	-64TEN	-64TH	-64THN
	3	-64V	-64VN	-64VE	-64VEN	-64VH	-64VHN
	4	-64X	-64XN	-64XE	-64XEN	-64XH	-64XHN
M65	1.5	-65R	-65RN	-65RE	-65REN	-65RH	-65RHN
	2	-65T	-65TN	-65TE	-65TEN	-65TH	-65THN
	3	-65V	-65VN	-65VE	-65VEN	-65VH	-65VHN
	4	-65X	-65XN	-65XE	-65XEN	-65XH	-65XHN
M68	1.5	-68R	-68RN	-68RE	-68REN	-68RH	-68RHN
	2	-68T	-68TN	-68TE	-68TEN	-68TH	-68THN
	3	-68V	-68VN	-68VE	-68VEN	-68VH	-68VHN
	4	-68X	-68XN	-68XE	-68XEN	-68XH	-68XHN
M70	1.5	-70R	-70RN	-70RE	-70REN	-70RH	-70RHN
	2	-70T	-70TN	-70TE	-70TEN	-70TH	-70THN
	3	-70V	-70VN	-70VE	-70VEN	-70VH	-70VHN
	4	-70X	-70XN	-70XE	-70XEN	-70XH	-70XHN
	6	-70O	-70ON	-70OE	-70OEN	-70OH	-70OHN
M72	1.5	-72R	-72RN	-72RE	-72REN	-72RH	-72RHN
	2	-72T	-72TN	-72TE	-72TEN	-72TH	-72THN

To be continued



Continued from previous page

Size (mm)		Code (4129)						
		Class 6g		Class 6e		Class 6h		
Nominal diameter	Pitch	GO	NOGO	GO	NOGO	GO	NOGO	
M72	3	-72V	-72VN	-72VE	-72VEN	-72VH	-72VHN	
	4	-72X	-72XN	-72XE	-72XEN	-72XH	-72XHN	
	6	-72O	-72ON	-72OE	-72OEN	-72OH	-72OHN	
M75	1.5	-75R	-75RN	-75RE	-75REN	-75RH	-75RHN	
	2	-75T	-75TN	-75TE	-75TEN	-75TH	-75THN	
	3	-75V	-75VN	-75VE	-75VEN	-75VH	-75VHN	
	4	-75X	-75XN	-75XE	-75XEN	-75XH	-75XHN	
M76	1.5	-76R	-76RN	-76RE	-76REN	-76RH	-76RHN	
	2	-76T	-76TN	-76TE	-76TEN	-76TH	-76THN	
	3	-76V	-76VN	-76VE	-76VEN	-76VH	-76VHN	
	4	-76X	-76XN	-76XE	-76XEN	-76XH	-76XHN	
M78	2	-78T	-78TN	-78TE	-78TEN	-78TH	-78THN	
	M80	1.5	-80R	-80RN	-80RE	-80REN	-80RH	-80RHN
		2	-80T	-80TN	-80TE	-80TEN	-80TH	-80THN
3		-80V	-80VN	-80VE	-80VEN	-80VH	-80VHN	
4		-80X	-80XN	-80XE	-80XEN	-80XH	-80XHN	
M82	6	-80O	-80ON	-80OE	-80OEN	-80OH	-80OHN	
	2	-82T	-82TN	-82TE	-82TEN	-82TH	-82THN	
	M85	2	-85T	-85TN	-85TE	-85TEN	-85TH	-85THN
3		-85V	-85VN	-85VE	-85VEN	-85VH	-85VHN	
4		-85X	-85XN	-85XE	-85XEN	-85XH	-85XHN	
6		-85O	-85ON	-85OE	-85OEN	-85OH	-85OHN	
M90	2	-90T	-90TN	-90TE	-90TEN	-90TH	-90THN	
	3	-90V	-90VN	-90VE	-90VEN	-90VH	-90VHN	
	4	-90X	-90XN	-90XE	-90XEN	-90XH	-90XHN	
	6	-90O	-90ON	-90OE	-90OEN	-90OH	-90OHN	
M95	2	-95T	-95TN	-95TE	-95TEN	-95TH	-95THN	
	3	-95V	-95VN	-95VE	-95VEN	-95VH	-95VHN	
	4	-95X	-95XN	-95XE	-95XEN	-95XH	-95XHN	
	6	-95O	-95ON	-95OE	-95OEN	-95OH	-95OHN	
M100	2	-100T	-100TN	-100TE	-100TEN	-100TH	-100THN	
	3	-100V	-100VN	-100VE	-100VEN	-100VH	-100VHN	
	4	-100X	-100XN	-100XE	-100XEN	-100XH	-100XHN	
	6	-100O	-100ON	-100OE	-100OEN	-100OH	-100OHN	
M105	2	-105T	-105TN	-105TE	-105TEN	-105TH	-105THN	
	3	-105V	-105VN	-105VE	-105VEN	-105VH	-105VHN	
	4	-105X	-105XN	-105XE	-105XEN	-105XH	-105XHN	
	6	-105O	-105ON	-105OE	-105OEN	-105OH	-105OHN	
M110	2	-110T	-110TN	-110TE	-110TEN	-110TH	-110THN	
	3	-110V	-110VN	-110VE	-110VEN	-110VH	-110VHN	
	4	-110X	-110XN	-110XE	-110XEN	-110XH	-110XHN	
	6	-110O	-110ON	-110OE	-110OEN	-110OH	-110OHN	
M115	2	-115T	-115TN	-115TE	-115TEN	-115TH	-115THN	
	3	-115V	-115VN	-115VE	-115VEN	-115VH	-115VHN	
	4	-115X	-115XN	-115XE	-115XEN	-115XH	-115XHN	
	6	-115O	-115ON	-115OE	-115OEN	-115OH	-115OHN	
M120	2	-120T	-120TN	-120TE	-120TEN	-120TH	-120THN	
	3	-120V	-120VN	-120VE	-120VEN	-120VH	-120VHN	
	4	-120X	-120XN	-120XE	-120XEN	-120XH	-120XHN	
	6	-120O	-120ON	-120OE	-120OEN	-120OH	-120OHN	

# AMERICAN STANDARD THREAD PLUG GAGES

WARNING: LIFE TIME IS LIMITED,  
CAN BE USED ABOUT 2000 TIMES



4131-102

- Supplied with Go and No-Go gages together
- Standard ANSI/ASME B1.2
- Supplied with manufacturer inspection certificate

Size	Code	
	Class 2B	Class 3B
No. 0-80UNF	4131-02	4131-02B
No. 1-64UNC	4131-11	4131-11B
No. 1-72UNF	4131-12	4131-12B
No. 2-56UNC	4131-21	4131-21B
No. 2-64UNF	4131-22	4131-22B
No. 3-48UNC	4131-31	4131-31B
No. 3-56UNF	4131-32	4131-32B
No. 4-40UNC	4131-41	4131-41B
No. 4-48UNF	4131-42	4131-42B
No. 5-40UNC	4131-51	4131-51B
No. 5-44UNF	4131-52	4131-52B
No. 6-32UNC	4131-61	4131-61B
No. 6-40UNF	4131-62	4131-62B
No. 8-32UNC	4131-81	4131-81B
No. 8-36UNF	4131-82	4131-82B
No. 10-24UNC	4131-101	4131-101B
No. 10-32UNF	4131-102	4131-102B
No. 12-24UNC	4131-121	4131-121B
No. 12-28UNF	4131-122	4131-122B
No. 12-32UNEF	4131-123	4131-123B
1/4-20UNC	4131-1B1	4131-1B1B
1/4-28UNF	4131-1B2	4131-1B2B
1/4-32UNEF	4131-1B3	4131-1B3B
1/4-36UNS	4131-1B4	4131-1B4B
5/16-18UNC	4131-5D1	4131-5D1B
5/16-24UNF	4131-5D2	4131-5D2B
5/16-32UNEF	4131-5D3	4131-5D3B
3/8-16UNC	4131-3C1	4131-3C1B
3/8-24UNF	4131-3C2	4131-3C2B
3/8-32UNEF	4131-3C3	4131-3C3B
7/16-14UNC	4131-7D1	4131-7D1B
7/16-20UNF	4131-7D2	4131-7D2B
7/16-28UNEF	4131-7D3	4131-7D3B
1/2-13UNC	4131-1A1	4131-1A1B
1/2-20UNF	4131-1A2	4131-1A2B
1/2-28UNEF	4131-1A3	4131-1A3B

Size	Code	
	Class 2B	Class 3B
9/16-12UNC	4131-9D1	4131-9D1B
9/16-18UNF	4131-9D2	4131-9D2B
9/16-24UNEF	4131-9D3	4131-9D3B
5/8-11UNC	4131-5C1	4131-5C1B
5/8-18UNF	4131-5C2	4131-5C2B
5/8-24UNEF	4131-5C3	4131-5C3B
11/16-16UN	4131-11D516	4131-11D516B
11/16-24UNEF	4131-11D3	4131-11D3B
3/4-10UNC	4131-3B1	4131-3B1B
3/4-16UNF	4131-3B2	4131-3B2B
3/4-20UNEF	4131-3B3	4131-3B3B
13/16-16UN	4131-13D516	4131-13D516B
13/16-20UNEF	4131-13D3	4131-13D3B
7/8-9UNC	4131-7C1	4131-7C1B
7/8-14UNF	4131-7C2	4131-7C2B
7/8-16UN	4131-7C516	4131-7C516B
7/8-20UNEF	4131-7C3	4131-7C3B
15/16-20UNEF	4131-15D3	4131-15D3B
1-8UNC	4131-2A1	4131-2A1B
1-12UNF	4131-2A2	4131-2A2B
1-14UNS	4131-2A514	4131-2A514B
1-20UNEF	4131-2A3	4131-2A3B
1-32UN	4131-2A532	4131-2A532B
1 1/16-12UN	4131-1E512	4131-1E512B
1 1/16-18UNEF	4131-1E3	4131-1E3B
1 1/8-7UNC	4131-1F1	4131-1F1B
1 1/8-8UN	4131-1F58	4131-1F58B
1 1/8-12UNF	4131-1F2	4131-1F2B
1 1/8-18UNEF	4131-1F3	4131-1F3B
1 3/16-12UN	4131-3E512	4131-3E512B
1 3/16-18UNEF	4131-3E3	4131-3E3B
1 1/4-7UNC	4131-1G1	4131-1G1B
1 1/4-8UN	4131-1G58	4131-1G58B
1 1/4-12UNF	4131-1G2	4131-1G2B
1 1/4-18UNEF	4131-1G3	4131-1G3B
1 5/16-12UN	4131-5E512	4131-5E512B



WARNING: LIFE TIME IS LIMITED,  
CAN BE USED ABOUT 2000 TIMES

## AMERICAN STANDARD THREAD RING GAGES



- Standard ANSI/ASME B1.2
- Class 2A
- Supplied with manufacturer inspection certificate

Size	Code	
	GO	NOGO
No. 4-40UNC	4121-41	4121-41N
No. 4-48UNF	4121-42	4121-42N
No. 5-40UNC	4121-51	4121-51N
No. 5-44UNF	4121-52	4121-52N
No. 6-32UNC	4121-61	4121-61N
No. 6-40UNF	4121-62	4121-62N
No. 8-32UNC	4121-81	4121-81N
No. 8-36UNF	4121-82	4121-82N
No. 10-24UNC	4121-101	4121-101N
No. 10-32UNF	4121-102	4121-102N
No. 12-24UNC	4121-121	4121-121N
No. 12-28UNF	4121-122	4121-122N
No. 12-32UNEF	4121-123	4121-123N
1/4-20UNC	4121-1B1	4121-1B1N
1/4-28UNF	4121-1B2	4121-1B2N
1/4-32UNEF	4121-1B3	4121-1B3N
1/4-36UNS	4121-1B4	4121-1B4N
5/16-18UNC	4121-5D1	4121-5D1N
5/16-24UNF	4121-5D2	4121-5D2N
5/16-32UNEF	4121-5D3	4121-5D3N
3/8-16UNC	4121-3C1	4121-3C1N
3/8-24UNF	4121-3C2	4121-3C2N
3/8-32UNEF	4121-3C3	4121-3C3N
7/16-14UNC	4121-7D1	4121-7D1N
7/16-20UNF	4121-7D2	4121-7D2N
7/16-28UNEF	4121-7D3	4121-7D3N
1/2-13UNC	4121-1A1	4121-1A1N
1/2-20UNF	4121-1A2	4121-1A2N
1/2-28UNEF	4121-1A3	4121-1A3N
9/16-12UNC	4121-9D1	4121-9D1N
9/16-18UNF	4121-9D2	4121-9D2N
9/16-24UNEF	4121-9D3	4121-9D3N

Size	Code	
	GO	NOGO
5/8-11UNC	4121-5C1	4121-5C1N
5/8-18UNF	4121-5C2	4121-5C2N
5/8-24UNEF	4121-5C3	4121-5C3N
11/16-16UN	4121-11D516	4121-11D516N
11/16-24UNEF	4121-11D3	4121-11D3N
3/4-10UNC	4121-3B1	4121-3B1N
3/4-16UNF	4121-3B2	4121-3B2N
3/4-20UNEF	4121-3B3	4121-3B3N
13/16-16UN	4121-13D516	4121-13D516N
13/16-20UNEF	4121-13D3	4121-13D3N
7/8-9UNC	4121-7C1	4121-7C1N
7/8-14UNF	4121-7C2	4121-7C2N
7/8-16UN	4121-7C516	4121-7C516N
7/8-20UNEF	4121-7C3	4121-7C3N
15/16-20UNEF	4121-15D3	4121-15D3N
1-8UNC	4121-2A1	4121-2A1N
1-12UNF	4121-2A2	4121-2A2N
1-14UNS	4121-2A514	4121-2A514N
1-20UNEF	4121-2A3	4121-2A3N
1-32UN	4121-2A532	4121-2A532N
1 1/16-12UN	4121-1E512	4121-1E512N
1 1/16-18UNEF	4121-1E3	4121-1E3N
1 1/8-7UNC	4121-1F1	4121-1F1N
1 1/8-8UN	4121-1F58	4121-1F58N
1 1/8-12UNF	4121-1F2	4121-1F2N
1 1/8-18UNEF	4121-1F3	4121-1F3N
1 3/16-12UN	4121-3E512	4121-3E512N
1 3/16-18UNEF	4121-3E3	4121-3E3N
1 1/4-7UNC	4121-1G1	4121-1G1N
1 1/4-8UN	4121-1G58	4121-1G58N
1 1/4-12UNF	4121-1G2	4121-1G2N
1 1/4-18UNEF	4121-1G3	4121-1G3N
1 5/16-12UN	4121-5E512	4121-5E512N

## CHECK PLUGS FOR METRIC THREAD RING GAGES

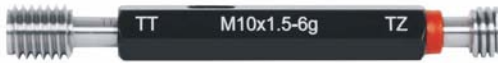

4647-10

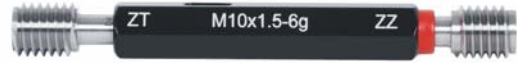

4647-10N

- Standard ISO1502
- Check thread ring gages
- Supplied with manufacturer inspection certificate

Code example:  
"-2" stands for "4647-2"

Size (mm)		Code (4647)					
Nominal diameter	Pitch	Class 6g		Class 6e		Class 6h	
		GO	NOGO	GO	NOGO	GO	NOGO
M2	0.4	-2	-2N	-2E	-2EN	-2H	-2HN
M2.2	0.45	-2D2	-2D2N	-2D2E	-2D2EN	-2D2H	-2D2HN
M2.3	0.4	-2D3	-2D3N	-2D3E	-2D3EN	-2D3H	-2D3HN
M2.5	0.45	-2D5	-2D5N	-2D5E	-2D5EN	-2D5H	-2D5HN
M2.6	0.45	-2D6	-2D6N	-2D6E	-2D6EN	-2D6H	-2D6HN
M3	0.5	-3	-3N	-3E	-3EN	-3H	-3HN
M3.5	0.6	-3D5	-3D5N	-3D5E	-3D5EN	-3D5H	-3D5HN
M4	0.7	-4	-4N	-4E	-4EN	-4H	-4HN
M4.5	0.75	-4D5	-4D5N	-4D5E	-4D5EN	-4D5H	-4D5HN
M5	0.8	-5	-5N	-5E	-5EN	-5H	-5HN
M6	1	-6	-6N	-6E	-6EN	-6H	-6HN
M7	1	-7	-7N	-7E	-7EN	-7H	-7HN
M8	1.25	-8	-8N	-8E	-8EN	-8H	-8HN
M9	1.25	-9	-9N	-9E	-9EN	-9H	-9HN
M10	1.5	-10	-10N	-10E	-10EN	-10H	-10HN
M11	1.5	-11	-11N	-11E	-11EN	-11H	-11HN
M12	1.75	-12	-12N	-12E	-12EN	-12H	-12HN
M14	2	-14	-14N	-14E	-14EN	-14H	-14HN
M16	2	-16	-16N	-16E	-16EN	-16H	-16HN
M18	2.5	-18	-18N	-18E	-18EN	-18H	-18HN
M20	2.5	-20	-20N	-20E	-20EN	-20H	-20HN
M22	2.5	-22	-22N	-22E	-22EN	-22H	-22HN
M24	3	-24	-24N	-24E	-24EN	-24H	-24HN
M27	3	-27	-27N	-27E	-27EN	-27H	-27HN
M30	3.5	-30	-30N	-30E	-30EN	-30H	-30HN
M33	3.5	-33	-33N	-33E	-33EN	-33H	-33HN
M36	4	-36	-36N	-36E	-36EN	-36H	-36HN
M39	4	-39	-39N	-39E	-39EN	-39H	-39HN
M42	4.5	-42	-42N	-42E	-42EN	-42H	-42HN
M45	4.5	-45	-45N	-45E	-45EN	-45H	-45HN
M48	5	-48	-48N	-48E	-48EN	-48H	-48HN
M52	5	-52	-52N	-52E	-52EN	-52H	-52HN
M56	5.5	-56	-56N	-56E	-56EN	-56H	-56HN
M60	5.5	-60	-60N	-60E	-60EN	-60H	-60HN
M64	6	-64	-64N	-64E	-64EN	-64H	-64HN
M68	6	-68	-68N	-68E	-68EN	-68H	-68HN

## CHECK PLUGS FOR METRIC FINE THREAD RING GAGES



4677-10P



4677-10PN

- Standard ISO1502
- Check thread ring gages
- Supplied with manufacturer inspection certificate

Code example:  
 “-3D5G” stands for “4677-3D5G”

Size (mm)		Code (4677)					
Nominal diameter	Pitch	Class 6g		Class 6e		Class 6h	
		GO	NOGO	GO	NOGO	GO	NOGO
M3.5	0.5	-3D5G	-3D5GN	-3D5GE	-3D5GEN	-3D5GH	-3D5GHN
M4	0.5	-4G	-4GN	-4GE	-4GEN	-4GH	-4GHN
M4.5	0.5	-4D5G	-4D5GN	-4D5GE	-4D5GEN	-4D5GH	-4D5GHN
M5	0.5	-5G	-5GN	-5GE	-5GEN	-5GH	-5GHN
M5.5	0.5	-5D5G	-5D5GN	-5D5GE	-5D5GEN	-5D5GH	-5D5GHN
M6	0.5	-6G	-6GN	-6GE	-6GEN	-6GH	-6GHN
	0.75	-6L	-6LN	-6LE	-6LEN	-6LH	-6LHN
M6.5	0.5	-6D5G	-6D5GN	-6D5GE	-6D5GEN	-6D5GH	-6D5GHN
M7	0.5	-7G	-7GN	-7GE	-7GEN	-7GH	-7GHN
	0.75	-7L	-7LN	-7LE	-7LEN	-7LH	-7LHN
M7.5	0.5	-7D5G	-7D5GN	-7D5GE	-7D5GEN	-7D5GH	-7D5GHN
M8	0.5	-8G	-8GN	-8GE	-8GEN	-8GH	-8GHN
	0.75	-8L	-8LN	-8LE	-8LEN	-8LH	-8LHN
	1	-8P	-8PN	-8PE	-8PEN	-8PH	-8PHN
M8.5	0.5	-8D5G	-8D5GN	-8D5GE	-8D5GEN	-8D5GH	-8D5GHN
M9	0.5	-9G	-9GN	-9GE	-9GEN	-9GH	-9GHN
	0.75	-9L	-9LN	-9LE	-9LEN	-9LH	-9LHN
	1	-9P	-9PN	-9PE	-9PEN	-9PH	-9PHN
M10	0.5	-10G	-10GN	-10GE	-10GEN	-10GH	-10GHN
	0.75	-10L	-10LN	-10LE	-10LEN	-10LH	-10LHN
	1	-10P	-10PN	-10PE	-10PEN	-10PH	-10PHN
	1.25	-10Q	-10QN	-10QE	-10QEN	-10QH	-10QHN
M11	0.5	-11G	-11GN	-11GE	-11GEN	-11GH	-11GHN
	0.75	-11L	-11LN	-11LE	-11LEN	-11LH	-11LHN
	1	-11P	-11PN	-11PE	-11PEN	-11PH	-11PHN
M12	0.5	-12G	-12GN	-12GE	-12GEN	-12GH	-12GHN
	0.75	-12L	-12LN	-12LE	-12LEN	-12LH	-12LHN
	1	-12P	-12PN	-12PE	-12PEN	-12PH	-12PHN
	1.25	-12Q	-12QN	-12QE	-12QEN	-12QH	-12QHN
	1.5	-12R	-12RN	-12RE	-12REN	-12RH	-12RHN
M13	0.5	-13G	-13GN	-13GE	-13GEN	-13GH	-13GHN
	0.75	-13L	-13LN	-13LE	-13LEN	-13LH	-13LHN
	1	-13P	-13PN	-13PE	-13PEN	-13PH	-13PHN
	1.5	-13R	-13RN	-13RE	-13REN	-13RH	-13RHN
M14	0.5	-14G	-14GN	-14GE	-14GEN	-14GH	-14GHN
	0.75	-14L	-14LN	-14LE	-14LEN	-14LH	-14LHN
	1	-14P	-14PN	-14PE	-14PEN	-14PH	-14PHN
	1.25	-14Q	-14QN	-14QE	-14QEN	-14QH	-14QHN
	1.5	-14R	-14RN	-14RE	-14REN	-14RH	-14RHN

To be continued

Continued from previous page

Size (mm)		Code (4677)					
Nominal diameter	Pitch	Class 6g		Class 6e		Class 6h	
		GO	NOGO	GO	NOGO	GO	NOGO
M15	0.5	-15G	-15GN	-15GE	-15GEN	-15GH	-15GHN
	0.75	-15L	-15LN	-15LE	-15LEN	-15LH	-15LHN
	1	-15P	-15PN	-15PE	-15PEN	-15PH	-15PHN
	1.5	-15R	-15RN	-15RE	-15REN	-15RH	-15RHN
M16	0.5	-16G	-16GN	-16GE	-16GEN	-16GH	-16GHN
	0.75	-16L	-16LN	-16LE	-16LEN	-16LH	-16LHN
	1	-16P	-16PN	-16PE	-16PEN	-16PH	-16PHN
	1.25	-16Q	-16QN	-16QE	-16QEN	-16QH	-16QHN
	1.5	-16R	-16RN	-16RE	-16REN	-16RH	-16RHN
M17	0.5	-17G	-17GN	-17GE	-17GEN	-17GH	-17GHN
	0.75	-17L	-17LN	-17LE	-17LEN	-17LH	-17LHN
	1	-17P	-17PN	-17PE	-17PEN	-17PH	-17PHN
	1.5	-17R	-17RN	-17RE	-17REN	-17RH	-17RHN
M18	0.5	-18G	-18GN	-18GE	-18GEN	-18GH	-18GHN
	0.75	-18L	-18LN	-18LE	-18LEN	-18LH	-18LHN
	1	-18P	-18PN	-18PE	-18PEN	-18PH	-18PHN
	1.25	-18Q	-18QN	-18QE	-18QEN	-18QH	-18QHN
	1.5	-18R	-18RN	-18RE	-18REN	-18RH	-18RHN
	2	-18T	-18TN	-18TE	-18TEN	-18TH	-18THN
M19	0.5	-19G	-19GN	-19GE	-19GEN	-19GH	-19GHN
	0.75	-19L	-19LN	-19LE	-19LEN	-19LH	-19LHN
	1	-19P	-19PN	-19PE	-19PEN	-19PH	-19PHN
	1.5	-19R	-19RN	-19RE	-19REN	-19RH	-19RHN
M20	0.5	-20G	-20GN	-20GE	-20GEN	-20GH	-20GHN
	0.75	-20L	-20LN	-20LE	-20LEN	-20LH	-20LHN
	1	-20P	-20PN	-20PE	-20PEN	-20PH	-20PHN
	1.25	-20Q	-20QN	-20QE	-20QEN	-20QH	-20QHN
	1.5	-20R	-20RN	-20RE	-20REN	-20RH	-20RHN
	2	-20T	-20TN	-20TE	-20TEN	-20TH	-20THN
M21	0.75	-21L	-21LN	-21LE	-21LEN	-21LH	-21LHN
	1	-21P	-21PN	-21PE	-21PEN	-21PH	-21PHN
	1.5	-21R	-21RN	-21RE	-21REN	-21RH	-21RHN
M22	0.75	-22L	-22LN	-22LE	-22LEN	-22LH	-22LHN
	1	-22P	-22PN	-22PE	-22PEN	-22PH	-22PHN
	1.25	-22Q	-22QN	-22QE	-22QEN	-22QH	-22QHN
	1.5	-22R	-22RN	-22RE	-22REN	-22RH	-22RHN
	2	-22T	-22TN	-22TE	-22TEN	-22TH	-22THN
M23	0.75	-23L	-23LN	-23LE	-23LEN	-23LH	-23LHN
	1	-23P	-23PN	-23PE	-23PEN	-23PH	-23PHN
M24	0.75	-24L	-24LN	-24LE	-24LEN	-24LH	-24LHN
	1	-24P	-24PN	-24PE	-24PEN	-24PH	-24PHN
	1.25	-24Q	-24QN	-24QE	-24QEN	-24QH	-24QHN
	1.5	-24R	-24RN	-24RE	-24REN	-24RH	-24RHN
	2	-24T	-24TN	-24TE	-24TEN	-24TH	-24THN
M25	0.75	-25L	-25LN	-25LE	-25LEN	-25LH	-25LHN
	1	-25P	-25PN	-25PE	-25PEN	-25PH	-25PHN
	1.5	-25R	-25RN	-25RE	-25REN	-25RH	-25RHN
	2	-25T	-25TN	-25TE	-25TEN	-25TH	-25THN
M26	0.75	-26L	-26LN	-26LE	-26LEN	-26LH	-26LHN
	1	-26P	-26PN	-26PE	-26PEN	-26PH	-26PHN
	1.5	-26R	-26RN	-26RE	-26REN	-26RH	-26RHN
	2	-26T	-26TN	-26TE	-26TEN	-26TH	-26THN

To be continued





Continued from previous page

Size (mm)		Code (4677)					
Nominal diameter	Pitch	Class 6g		Class 6e		Class 6h	
		GO	NOGO	GO	NOGO	GO	NOGO
M27	0.75	-27L	-27LN	-27LE	-27LEN	-27LH	-27LHN
	1	-27P	-27PN	-27PE	-27PEN	-27PH	-27PHN
	1.5	-27R	-27RN	-27RE	-27REN	-27RH	-27RHN
	2	-27T	-27TN	-27TE	-27TEN	-27TH	-27THN
M28	0.75	-28L	-28LN	-28LE	-28LEN	-28LH	-28LHN
	1	-28P	-28PN	-28PE	-28PEN	-28PH	-28PHN
	1.5	-28R	-28RN	-28RE	-28REN	-28RH	-28RHN
	2	-28T	-28TN	-28TE	-28TEN	-28TH	-28THN
M29	0.75	-29L	-29LN	-29LE	-29LEN	-29LH	-29LHN
	1	-29P	-29PN	-29PE	-29PEN	-29PH	-29PHN
M30	0.75	-30L	-30LN	-30LE	-30LEN	-30LH	-30LHN
	1	-30P	-30PN	-30PE	-30PEN	-30PH	-30PHN
	1.5	-30R	-30RN	-30RE	-30REN	-30RH	-30RHN
	2	-30T	-30TN	-30TE	-30TEN	-30TH	-30THN
	3	-30V	-30VN	-30VE	-30VEN	-30VH	-30VHN
M31	0.75	-31L	-31LN	-31LE	-31LEN	-31LH	-31LHN
M32	0.75	-32L	-32LN	-32LE	-32LEN	-32LH	-32LHN
	1	-32P	-32PN	-32PE	-32PEN	-32PH	-32PHN
	1.5	-32R	-32RN	-32RE	-32REN	-32RH	-32RHN
	2	-32T	-32TN	-32TE	-32TEN	-32TH	-32THN
M33	0.75	-33L	-33LN	-33LE	-33LEN	-33LH	-33LHN
	1	-33P	-33PN	-33PE	-33PEN	-33PH	-33PHN
	1.5	-33R	-33RN	-33RE	-33REN	-33RH	-33RHN
	2	-33T	-33TN	-33TE	-33TEN	-33TH	-33THN
	3	-33V	-33VN	-33VE	-33VEN	-33VH	-33VHN
M34	1	-34P	-34PN	-34PE	-34PEN	-34PH	-34PHN
	1.5	-34R	-34RN	-34RE	-34REN	-34RH	-34RHN
	2	-34T	-34TN	-34TE	-34TEN	-34TH	-34THN
M35	1	-35P	-35PN	-35PE	-35PEN	-35PH	-35PHN
	1.5	-35R	-35RN	-35RE	-35REN	-35RH	-35RHN
M36	2	-35T	-35TN	-35TE	-35TEN	-35TH	-35THN
	1	-36P	-36PN	-36PE	-36PEN	-36PH	-36PHN
	1.5	-36R	-36RN	-36RE	-36REN	-36RH	-36RHN
	2	-36T	-36TN	-36TE	-36TEN	-36TH	-36THN
	3	-36V	-36VN	-36VE	-36VEN	-36VH	-36VHN
M38	1	-38P	-38PN	-38PE	-38PEN	-38PH	-38PHN
	1.5	-38R	-38RN	-38RE	-38REN	-38RH	-38RHN
	2	-38T	-38TN	-38TE	-38TEN	-38TH	-38THN
M39	1	-39P	-39PN	-39PE	-39PEN	-39PH	-39PHN
	1.5	-39R	-39RN	-39RE	-39REN	-39RH	-39RHN
	2	-39T	-39TN	-39TE	-39TEN	-39TH	-39THN
	3	-39V	-39VN	-39VE	-39VEN	-39VH	-39VHN
M40	1.5	-40R	-40RN	-40RE	-40REN	-40RH	-40RHN
	2	-40T	-40TN	-40TE	-40TEN	-40TH	-40THN
	3	-40V	-40VN	-40VE	-40VEN	-40VH	-40VHN
M42	1.5	-42R	-42RN	-42RE	-42REN	-42RH	-42RHN
	2	-42T	-42TN	-42TE	-42TEN	-42TH	-42THN
	3	-42V	-42VN	-42VE	-42VEN	-42VH	-42VHN
M45	1.5	-45R	-45RN	-45RE	-45REN	-45RH	-45RHN
	2	-45T	-45TN	-45TE	-45TEN	-45TH	-45THN
	3	-45V	-45VN	-45VE	-45VEN	-45VH	-45VHN

To be continued

Continued from previous page

Size (mm)		Code (4677)					
Nominal diameter	Pitch	Class 6g		Class 6e		Class 6h	
		GO	NOGO	GO	NOGO	GO	NOGO
M48	1.5	-48R	-48RN	-48RE	-48REN	-48RH	-48RHN
	2	-48T	-48TN	-48TE	-48TEN	-48TH	-48THN
	3	-48V	-48VN	-48VE	-48VEN	-48VH	-48VHN
M50	1.5	-50R	-50RN	-50RE	-50REN	-50RH	-50RHN
	2	-50T	-50TN	-50TE	-50TEN	-50TH	-50THN
	3	-50V	-50VN	-50VE	-50VEN	-50VH	-50VHN
M52	1.5	-52R	-52RN	-52RE	-52REN	-52RH	-52RHN
	2	-52T	-52TN	-52TE	-52TEN	-52TH	-52THN
	3	-52V	-52VN	-52VE	-52VEN	-52VH	-52VHN
	4	-52X	-52XN	-52XE	-52XEN	-52XH	-52XHN
M55	1.5	-55R	-55RN	-55RE	-55REN	-55RH	-55RHN
	2	-55T	-55TN	-55TE	-55TEN	-55TH	-55THN
	3	-55V	-55VN	-55VE	-55VEN	-55VH	-55VHN
	4	-55X	-55XN	-55XE	-55XEN	-55XH	-55XHN
M56	1.5	-56R	-56RN	-56RE	-56REN	-56RH	-56RHN
	2	-56T	-56TN	-56TE	-56TEN	-56TH	-56THN
	3	-56V	-56VN	-56VE	-56VEN	-56VH	-56VHN
	4	-56X	-56XN	-56XE	-56XEN	-56XH	-56XHN
M58	1.5	-58R	-58RN	-58RE	-58REN	-58RH	-58RHN
	2	-58T	-58TN	-58TE	-58TEN	-58TH	-58THN
	3	-58V	-58VN	-58VE	-58VEN	-58VH	-58VHN
	4	-58X	-58XN	-58XE	-58XEN	-58XH	-58XHN
M60	1.5	-60R	-60RN	-60RE	-60REN	-60RH	-60RHN
	2	-60T	-60TN	-60TE	-60TEN	-60TH	-60THN
	3	-60V	-60VN	-60VE	-60VEN	-60VH	-60VHN
	4	-60X	-60XN	-60XE	-60XEN	-60XH	-60XHN
M62	1.5	-62R	-62RN	-62RE	-62REN	-62RH	-62RHN
	2	-62T	-62TN	-62TE	-62TEN	-62TH	-62THN
	3	-62V	-62VN	-62VE	-62VEN	-62VH	-62VHN
	4	-62X	-62XN	-62XE	-62XEN	-62XH	-62XHN
M64	1.5	-64R	-64RN	-64RE	-64REN	-64RH	-64RHN
	2	-64T	-64TN	-64TE	-64TEN	-64TH	-64THN
	3	-64V	-64VN	-64VE	-64VEN	-64VH	-64VHN
	4	-64X	-64XN	-64XE	-64XEN	-64XH	-64XHN
M65	1.5	-65R	-65RN	-65RE	-65REN	-65RH	-65RHN
	2	-65T	-65TN	-65TE	-65TEN	-65TH	-65THN
	3	-65V	-65VN	-65VE	-65VEN	-65VH	-65VHN
	4	-65X	-65XN	-65XE	-65XEN	-65XH	-65XHN
M68	1.5	-68R	-68RN	-68RE	-68REN	-68RH	-68RHN
	2	-68T	-68TN	-68TE	-68TEN	-68TH	-68THN
	3	-68V	-68VN	-68VE	-68VEN	-68VH	-68VHN
	4	-68X	-68XN	-68XE	-68XEN	-68XH	-68XHN
M70	1.5	-70R	-70RN	-70RE	-70REN	-70RH	-70RHN
	2	-70T	-70TN	-70TE	-70TEN	-70TH	-70THN
	3	-70V	-70VN	-70VE	-70VEN	-70VH	-70VHN
	4	-70X	-70XN	-70XE	-70XEN	-70XH	-70XHN
	6	-70O	-70ON	-70OE	-70OEN	-70OH	-70OHN
M72	1.5	-72R	-72RN	-72RE	-72REN	-72RH	-72RHN
	2	-72T	-72TN	-72TE	-72TEN	-72TH	-72THN
	3	-72V	-72VN	-72VE	-72VEN	-72VH	-72VHN

To be continued



Continued from previous page

Size (mm)		Code (4677)					
Nominal diameter	Pitch	Class 6g		Class 6e		Class 6h	
		GO	NOGO	GO	NOGO	GO	NOGO
M72	4	-72X	-72XN	-72XE	-72XEN	-72XH	-72XHN
	6	-72O	-72ON	-72OE	-72OEN	-72OH	-72OHN
M75	1.5	-75R	-75RN	-75RE	-75REN	-75RH	-75RHN
	2	-75T	-75TN	-75TE	-75TEN	-75TH	-75THN
	3	-75V	-75VN	-75VE	-75VEN	-75VH	-75VHN
	4	-75X	-75XN	-75XE	-75XEN	-75XH	-75XHN
M76	1.5	-76R	-76RN	-76RE	-76REN	-76RH	-76RHN
	2	-76T	-76TN	-76TE	-76TEN	-76TH	-76THN
	3	-76V	-76VN	-76VE	-76VEN	-76VH	-76VHN
	4	-76X	-76XN	-76XE	-76XEN	-76XH	-76XHN
M78	6	-76O	-76ON	-76OE	-76OEN	-76OH	-76OHN
	2	-78T	-78TN	-78TE	-78TEN	-78TH	-78THN
	1.5	-80R	-80RN	-80RE	-80REN	-80RH	-80RHN
M80	2	-80T	-80TN	-80TE	-80TEN	-80TH	-80THN
	3	-80V	-80VN	-80VE	-80VEN	-80VH	-80VHN
	4	-80X	-80XN	-80XE	-80XEN	-80XH	-80XHN
	6	-80O	-80ON	-80OE	-80OEN	-80OH	-80OHN
M82	2	-82T	-82TN	-82TE	-82TEN	-82TH	-82THN
M85	2	-85T	-85TN	-85TE	-85TEN	-85TH	-85THN
	3	-85V	-85VN	-85VE	-85VEN	-85VH	-85VHN
	4	-85X	-85XN	-85XE	-85XEN	-85XH	-85XHN
	6	-85O	-85ON	-85OE	-85OEN	-85OH	-85OHN
M90	2	-90T	-90TN	-90TE	-90TEN	-90TH	-90THN
	3	-90V	-90VN	-90VE	-90VEN	-90VH	-90VHN
	4	-90X	-90XN	-90XE	-90XEN	-90XH	-90XHN
	6	-90O	-90ON	-90OE	-90OEN	-90OH	-90OHN
M95	2	-95T	-95TN	-95TE	-95TEN	-95TH	-95THN
	3	-95V	-95VN	-95VE	-95VEN	-95VH	-95VHN
	4	-95X	-95XN	-95XE	-95XEN	-95XH	-95XHN
	6	-95O	-95ON	-95OE	-95OEN	-95OH	-95OHN
M100	2	-100T	-100TN	-100TE	-100TEN	-100TH	-100THN
	3	-100V	-100VN	-100VE	-100VEN	-100VH	-100VHN
	4	-100X	-100XN	-100XE	-100XEN	-100XH	-100XHN
	6	-100O	-100ON	-100OE	-100OEN	-100OH	-100OHN
M105	2	-105T	-105TN	-105TE	-105TEN	-105TH	-105THN
	3	-105V	-105VN	-105VE	-105VEN	-105VH	-105VHN
	4	-105X	-105XN	-105XE	-105XEN	-105XH	-105XHN
	6	-105O	-105ON	-105OE	-105OEN	-105OH	-105OHN
M110	2	-110T	-110TN	-110TE	-110TEN	-110TH	-110THN
	3	-110V	-110VN	-110VE	-110VEN	-110VH	-110VHN
	4	-110X	-110XN	-110XE	-110XEN	-110XH	-110XHN
	6	-110O	-110ON	-110OE	-110OEN	-110OH	-110OHN
M115	2	-115T	-115TN	-115TE	-115TEN	-115TH	-115THN
	3	-115V	-115VN	-115VE	-115VEN	-115VH	-115VHN
	4	-115X	-115XN	-115XE	-115XEN	-115XH	-115XHN
	6	-115O	-115ON	-115OE	-115OEN	-115OH	-115OHN
M120	2	-120T	-120TN	-120TE	-120TEN	-120TH	-120THN
	3	-120V	-120VN	-120VE	-120VEN	-120VH	-120VHN
	4	-120X	-120XN	-120XE	-120XEN	-120XH	-120XHN
	6	-120O	-120ON	-120OE	-120OEN	-120OH	-120OHN

## THREAD GAGES FOR ROTARY SHOULDERED CONNECTIONS OF PETROLEUM EQUIPMENT

API PRODUCTION LICENSE



- Measure the thread of rotary shouldered connections

4177-23

### Number style gages

Code	Gage code	Form of thread to be inspected	Number of thread per inch	Taper	Angle of thread	Basic pitch dia
4177-10	NC10	V-0.055	6	1:8	60°	27.000mm
4177-12	NC12	V-0.055	6	1:8	60°	32.121mm
4177-13	NC13	V-0.055	6	1:8	60°	35.331mm
4177-16	NC16	V-0.055	6	1:8	60°	40.869mm
4177-23	NC23	V-0.038R	4	1:6	60°	59.817mm
4177-26	NC26	V-0.038R	4	1:6	60°	67.767mm
4177-31	NC31	V-0.038R	4	1:6	60°	80.848mm
4177-35	NC35	V-0.038R	4	1:6	60°	89.687mm
4177-38	NC38	V-0.038R	4	1:6	60°	96.723mm
4177-40	NC40	V-0.038R	4	1:6	60°	103.429mm
4177-44	NC44	V-0.038R	4	1:6	60°	112.192mm
4177-46	NC46	V-0.038R	4	1:6	60°	117.500mm
4177-50	NC50	V-0.038R	4	1:6	60°	128.059mm
4177-56	NC56	V-0.038R	4	1:4	60°	142.646mm
4177-61	NC61	V-0.038R	4	1:4	60°	156.921mm
4177-70	NC70	V-0.038R	4	1:4	60°	179.146mm
4177-77	NC77	V-0.038R	4	1:4	60°	196.621mm

### Regular style gages

Code	Gage code	Form of thread to be inspected	Number of thread per inch	Taper	Angle of thread	Basic pitch dia
4177-2R	2 3/8 REG	V-0.040	5	1:4	60°	60.080mm
4177-21R	2 7/8 REG	V-0.040	5	1:4	60°	69.605mm
4177-3R	3 1/2 REG	V-0.040	5	1:4	60°	82.293mm
4177-4R	4 1/2 REG	V-0.040	5	1:4	60°	110.868mm
4177-5R	5 1/2 REG	V-0.050	4	1:4	60°	132.944mm
4177-6R	6 5/8 REG	V-0.050	4	1:6	60°	146.248mm
4177-7R	7 5/8 REG	V-0.050	4	1:4	60°	170.549mm
4177-8R	8 5/8 REG	V-0.050	4	1:4	60°	194.731mm

### Full-hole style gages

Code	Gage code	Form of thread to be inspected	Number of thread per inch	Taper	Angle of thread	Basic pitch dia
4177-3H	3 1/2 FH	V-0.040	5	1:4	60°	94.844mm
4177-4H	4 1/2 FH	V-0.040	5	1:4	60°	115.113mm
4177-5H	5 1/2 FH	V-0.050	4	1:6	60°	142.011mm
4177-6H	6 5/8 FH	V-0.050	4	1:6	60°	165.598mm

### Internal-flush style gage

Code	Gage code	Form of thread to be inspected	Number of thread per inch	Taper	Angle of thread	Basic pitch dia
4177-5F	5 1/2 IF	V-0.065	4	1:6	60°	157.201mm

## CASING, TUBING AND LINE PIPE THREAD GAGES OF PETROLEUM AND GAS EQUIPMENT

### Casing round thread gages

Code	Gage code	Outer dia	Number of thread per inch	Taper	Angle of thread
4178-4	4 1/2 CSG	114.30mm	8	1:16	60°
4178-4L	4 1/2 LCSG				
4178-5	5 CSG	127.00mm	8	1:16	60°
4178-5L	5 LCSG				
4178-51	5 1/2 CSG	139.70mm	8	1:16	60°
4178-51L	5 1/2 LCSG				
4178-6	6 5/8 CSG	168.28mm	8	1:16	60°
4178-6L	6 5/8 LCSG				
4178-7	7 CSG	177.80mm	8	1:16	60°
4178-7L	7 LCSG				
4178-71	7 5/8 CSG	193.68mm	8	1:16	60°
4178-71L	7 5/8 LCSG				
4178-8	8 5/8 CSG	219.08mm	8	1:16	60°
4178-8L	8 5/8 LCSG				
4178-9	9 5/8 CSG	244.48mm	8	1:16	60°
4178-9L	9 5/8 LCSG				
4178-10	10 3/4 CSG	273.05mm	8	1:16	60°
4178-10L	10 3/4 LCSG				
4178-11	11 3/4 CSG	298.45mm	8	1:16	60°
4178-11L	11 3/4 LCSG				
4178-13	13 3/8 CSG	339.73mm	8	1:16	60°
4178-13L	13 3/8 LCSG				
4178-16	16 CSG	406.40mm	8	1:16	60°
4178-16L	16 LCSG				



4178-21T

- Measure the casing, tubing and line pipe threads

### Non-upset tubing thread gages

Code	Gage code	Outer dia	Number of thread per inch	Taper	Angle of thread
4178-11T	1.050 TBG	26.67mm	10	1:16	60°
4178-13T	1.315 TBG	33.40mm	10	1:16	60°
4178-16T	1.660 TBG	42.16mm	10	1:16	60°
4178-19T	1.900 TBG	48.26mm	10	1:16	60°
4178-2T	2 3/8 TBG	60.33mm	10	1:16	60°
4178-21T	2 7/8 TBG	73.03mm	10	1:16	60°
4178-3T	3 1/2 TBG	88.90mm	10	1:16	60°
4178-4T	4 TBG	101.60mm	8	1:16	60°
4178-41T	4 1/2 TBG	114.30mm	8	1:16	60°

### External-upset tubing thread gages

Code	Gage code	Outer dia	Number of thread per inch	Taper	Angle of thread
4178-11U	1.050 UP TBG	26.67mm	10	1:16	60°
4178-13U	1.315 UP TBG	33.40mm	10	1:16	60°
4178-16U	1.660 UP TBG	42.16mm	10	1:16	60°
4178-19U	1.900 UP TBG	48.26mm	10	1:16	60°
4178-2U	2 3/8 UP TBG	60.33mm	8	1:16	60°
4178-21U	2 7/8 UP TBG	73.03mm	8	1:16	60°
4178-3U	3 1/2 UP TBG	88.90mm	8	1:16	60°
4178-4U	4 UP TBG	101.60mm	8	1:16	60°
4178-41U	4 1/2 UP TBG	114.30mm	8	1:16	60°

To be continued

Continued from previous page

**Buttress casing thread gages**

Code	Gage code	Outer dia	Number of thread per inch	Taper	Angle of thread
4178-4B	4 1/2 BCSG	114.30mm	5	1:16	3°, 10°
4178-5B	5 BCSG	127.00mm	5	1:16	3°, 10°
4178-51B	5 1/2 BCSG	139.70mm	5	1:16	3°, 10°
4178-6B	6 5/8 BCSG	168.28mm	5	1:16	3°, 10°
4178-7B	7 BCSG	177.80mm	5	1:16	3°, 10°
4178-71B	7 5/8 BCSG	193.68mm	5	1:16	3°, 10°
4178-8B	8 5/8 BCSG	219.08mm	5	1:16	3°, 10°
4178-9B	9 5/8 BCSG	244.48mm	5	1:16	3°, 10°
4178-10B	10 3/4 BCSG	273.05mm	5	1:16	3°, 10°
4178-11B	11 3/4 BCSG	298.45mm	5	1:16	3°, 10°
4178-13B	13 3/8 BCSG	339.73mm	5	1:16	3°, 10°
4178-16B	16 BCSG	406.40mm	5	1:12	3°, 10°

**Line pipe thread gages**

Code	Gage code	Outer dia	Number of thread per inch	Taper	Angle of thread
4178-01P	1/8 LP	3.18mm	27	1:16	60°
4178-02P	1/4 LP	6.35mm	18	1:16	60°
4178-03P	3/8 LP	9.53mm	18	1:16	60°
4178-05P	1/2 LP	12.70mm	14	1:16	60°
4178-07P	3/4 LP	19.05mm	14	1:16	60°
4178-10P	1 LP	25.40mm	11 1/2	1:16	60°
4178-12P	1 1/4 LP	31.75mm	11 1/2	1:16	60°
4178-15P	1 1/2 LP	38.10mm	11 1/2	1:16	60°
4178-20P	2 LP	50.80mm	11 1/2	1:16	60°
4178-25P	2 1/2 LP	63.50mm	8	1:16	60°
4178-30P	3 LP	76.20mm	8	1:16	60°
4178-35P	3 1/2 LP	88.90mm	8	1:16	60°
4178-40P	4 LP	101.60mm	8	1:16	60°
4178-50P	5 LP	127.00mm	8	1:16	60°
4178-60P	6 LP	152.40mm	8	1:16	60°
4178-80P	8 LP	203.20mm	8	1:16	60°
4178-100P	10 LP	254.00mm	8	1:16	60°

**SEMI-AUTOMATIC THREAD INSPECTOR**

CUSTOM-MADE

- Rapid inspection of thread
- Speed and torque are adjustable
- Reverse button: if abnormal thread is detected, thread gage will be stuck, press the reverse button to exit
- Different thread gages and workpiece fixtures can be replaced
- Thread gages with DLC coating, excellent wear resistance
- For different length of thread by adjusting the position of approach switch



**SPECIFICATION**

Measuring range	external thread: M5~M20 (Go thread ring gage)
	internal thread: M3~M36 (Go thread plug gage)
Torque range	clearance fit: 0.1~0.35Nm, interference fit: 0.4~1.4Nm
Speed range	100~2200r/min
Power supply	power adapter
Rated power	24W
Weight	3kg
Dimension	160×190×250mm

Code No. example (thread gages are optional)  
TGI-□□□ (□□□ is the code No. of Go thread gage)

TGI-4641-6T	thread inspector with M6-6H Go thread plug gage
TGI-4631-8	thread inspector with M8-6g Go thread ring gage

# ANGLE, STRAIGHTNESS, FLATNESS MEASUREMENT



Angle Meters  
Page 376



Protractors  
Page 376-381



Granite Squares  
Page 381-382



Cylinder Squares  
Page 382



Perpendicularity Testers  
Page 383



Squares  
Page 383-389



Straight Edges  
Page 389



Straight Edges  
Page 390-391



Optical Flats  
Page 391



Flatness Measurement Stands  
Page 392

## DIGITAL ANGLE METER CODE 2177-121



- Clockwise and counter-clockwise operation
- 9 target angle values can be set, with audible and visible alarm:
  - Green LED light on and buzzer sounds when angle value is 80%~99.5% of target angle
  - Both green and red LED light on and buzzer sounds when angle value is over 99.5% of target angle
- Memory of 250 results, can upload to the computer
- Back with magnet
- Power off in 2 minutes automatically

### SPECIFICATION

Display range	0~999°
Setting range	1~360° (increment 1°)
Resolution	0.1°
Accuracy	±2° for 90° rotation @30°/sec
Power supply	2×1.5V AAA batteries
Dimension	58×58×41mm
Weight	70g



## WATERPROOF DIGITAL PROTRACTOR (HEAVY DUTY)

AUTOMATIC  
BACKLIGHT

ABSOLUTE  
LEVEL

IP54  
WATERPROOF

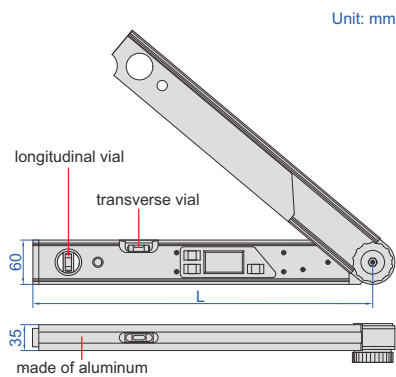

2174-225

- Suitable for setting horizontal and vertical mitre angles of cutting machines
- Buttons: ON/OFF, HOLD/SUP, SPR/CNR/MTR/BVL
- IP54 dust/waterproof
- With transverse and longitudinal vials
- 2xAAA batteries
- Absolute level, zero setting is not needed when batteries are replaced
- Backlight turns off in one minute after reading is stable, automatic power off in 5 minutes

Code	Size (L)	Range	Resolution	Accuracy
2174-225	460mm	0-225°	0.05°	±0.10°

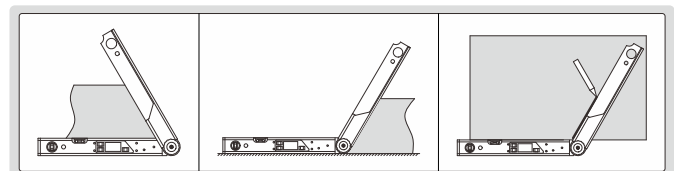



## DIGITAL PROTRACTOR



2171-250

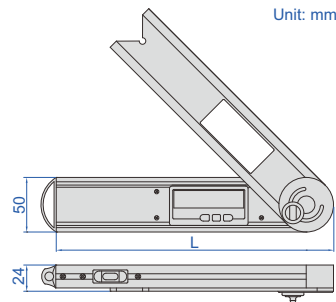

- Buttons: on/off, hold (keep the reading), zero, ABS (absolute and incremental measurement)
- Fix the locking screw at 4 positions for different measuring ranges: 0°~225°, -225°~0°, -45°~180°, -180°~45°
- Remove the locking screw for 360° range
- With level vial
- Battery CR2032, automatic power off

Code	Size (L)	Range	Resolution	Accuracy
2171-250	250mm	0-360°	0.05°	±0.15°

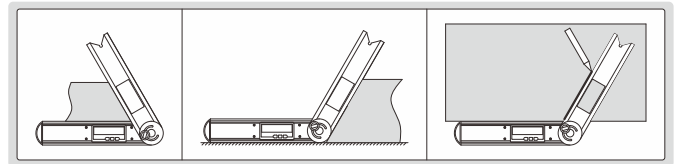

## DIGITAL PROTRACTORS



2176-200

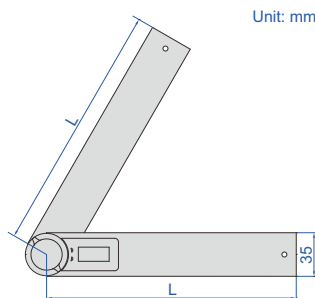

- Buttons: on/off, zero
- With clamping screw to lock the blades
- Graduation of blade: 1mm and 1/32"
- Made of stainless steel
- CR2032 battery
- Automatic power off

Code	Size (L)	Range	Resolution	Accuracy
2176-200	200mm	0-360°	0.1°	±0.3°
2176-300	300mm	0-360°	0.1°	±0.3°

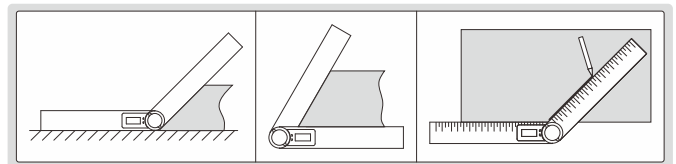

REFER TO PAGE  
498~500 FOR DETAILS

## DIGITAL LEVELS AND SLOPE METERS



2179-360



2175-360



2199-1



2170-1

## PROTRACTOR (ECONOMIC TYPE)

- Graduation: 1°
- Made of stainless steel
- With clamping screw



4780-85A

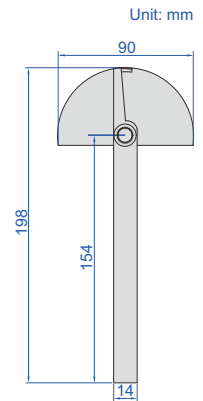

Code	Size	Range	Accuracy
4780-85A	90x154mm	0-180°	±0.5°

## PROTRACTOR

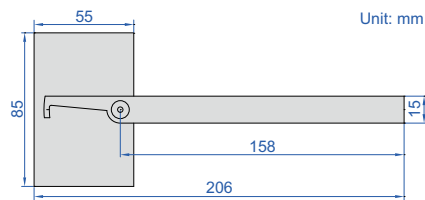

4781-85A

- Made of stainless steel
- Satin chrome plated scale
- With clamping screw

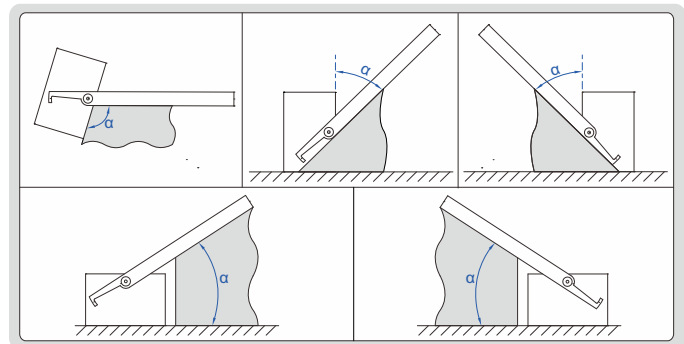

Code	Size	Range	Graduation	Accuracy
4781-85A	85x158mm	0-180°	1°	±0.3°

## PROTRACTORS

- Graduation: 1°
- Made of stainless steel  
(4799-1300 is made of carbon steel)
- Satin chrome plated scale
- With clamping screw



4799-180

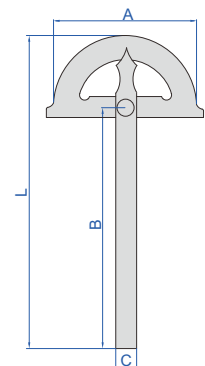

Code	Size (AxB)	Range	Accuracy	L	C
4799-180	80x120mm	0-180°	±0.3°	168mm	11mm
4799-1120	120x150mm	0-180°	±0.3°	220mm	14mm
4799-1150	150x200mm	0-180°	±0.3°	285mm	16mm
4799-1200	200x300mm	0-180°	±0.3°	413mm	20mm
4799-1300	300x500mm	0-180°	±0.3°	675mm	30mm

PROTRACTORS

- Graduation: 1°
- Made of carbon steel
- Satin chrome plated
- With clamping screw
- The blade is moveable



4797-100

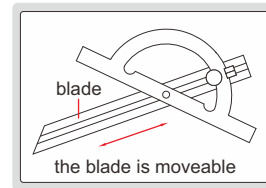
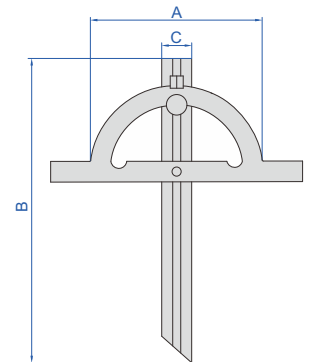

Code	Size (AxB)	Range	Accuracy	C
4797-100	100x150mm	10-170°	±0.3°	18mm
4797-150	150x300mm	10-170°	±0.3°	22mm
4797-200	200x400mm	10-170°	±0.3°	24mm
4797-250	250x500mm	10-170°	±0.3°	28mm
4797-300	300x600mm	10-170°	±0.3°	32mm

PROTRACTORS



2374-320

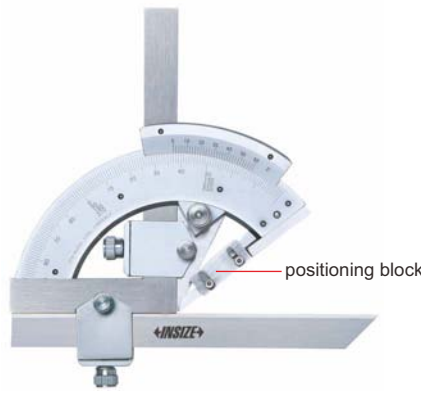

2374-320D

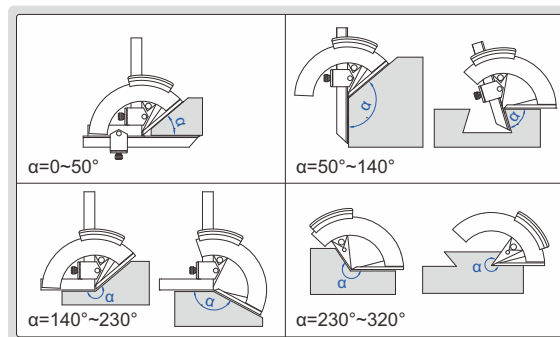
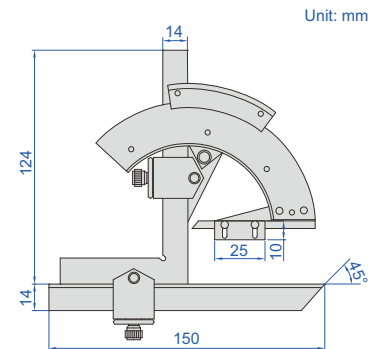

- Made of stainless steel
- Satin chrome plated scale

application of 2374-320D



the positioning block can be moved down for positioning, and moved up when not in use

Code	Range	Graduation	Accuracy	Remark
2374-320	0-320°	2'	±2'	without positioning block
2374-320D	0-320°	2'	±2'	with positioning block

## UNIVERSAL PROTRACTOR

clamp for height gages (optional)

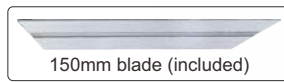
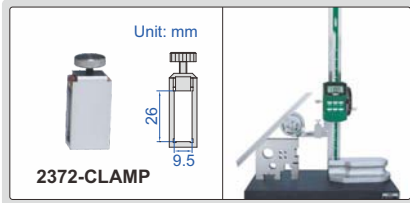

- Parallax-free reading
- Made of stainless steel
- Optional accessory: clamp (code 2372-CLAMP), suitable for height gages 1156, 1150-300, 1351, 1250 and 1151

Code	Range	Graduation	Accuracy
2372-360	0-360°	5'	±5'

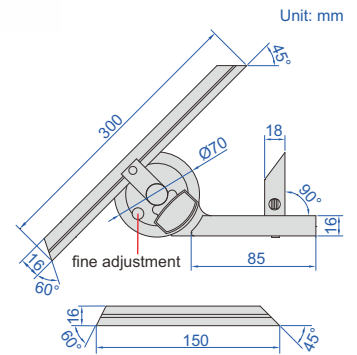

## DIAL PROTRACTOR

clamp for height gages (optional)

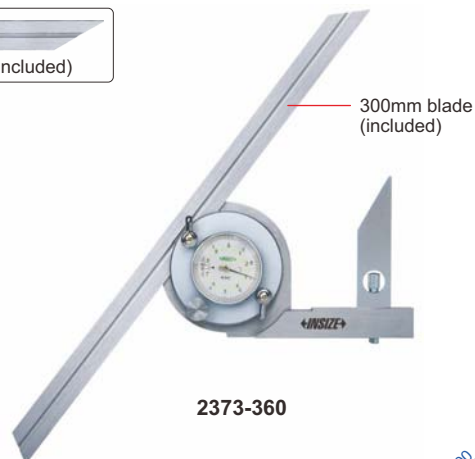
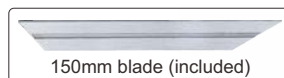
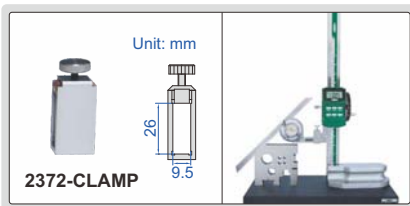

- Made of stainless steel
- Optional accessory: clamp (code 2372-CLAMP), suitable for height gages 1156, 1150-300, 1351, 1250 and 1151

Code	Range	Graduation	Accuracy
2373-360	0-360°	5'	±5'

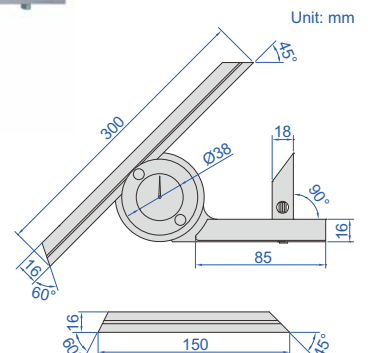

DATA OUTPUT

ABSOLUTE ZERO

POPULAR MODEL

DIGITAL PROTRACTOR

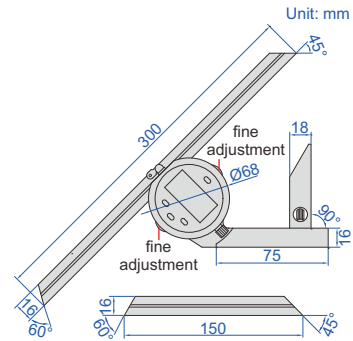
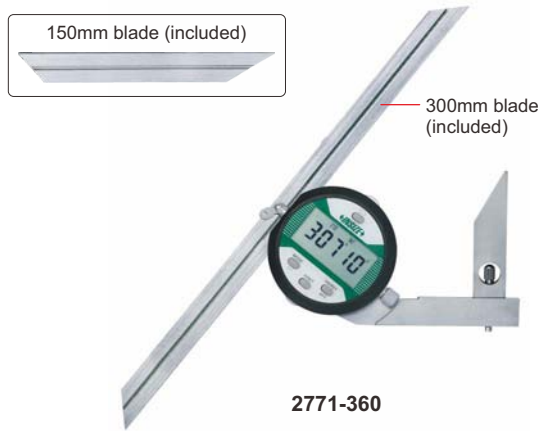

- Absolute zero, zero setting is not needed when batteries are replaced
- Button function: choose 0-90°, 0-180° or 0-360° display, change resolution, display flips over, data hold, zero, on/off supplementary angle measurement
- Battery CR2032, automatic power off, data output
- Made of stainless steel
- Optional square for zero setting
- Optional accessory: clamp (code **2372-CLAMP**), suitable for height gages **1156, 1150-300, 1351, 1250** and **1151**, data output cable (code **7315-2771** need receiver page 6, **7302-50M** page 13)

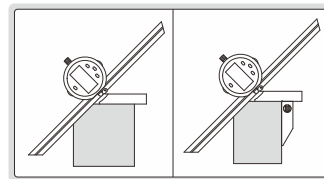

square (optional)

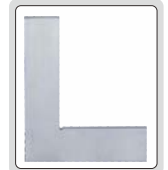

clamp for height gages (optional)

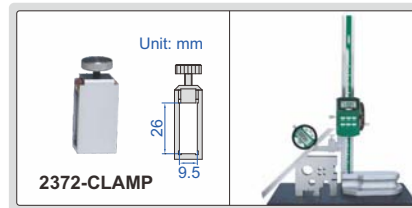

Square (for zero setting, optional)

Code  
2771-S90

Code	Range	Resolution	Accuracy
2771-360	0-360°	1'/0.01°	±5'

GRANITE SQUARE

CUSTOM-MADE  
SUPPLY SPECIAL SIZES ACCORDING  
TO CUSTOMER'S REQUEST



4144-315

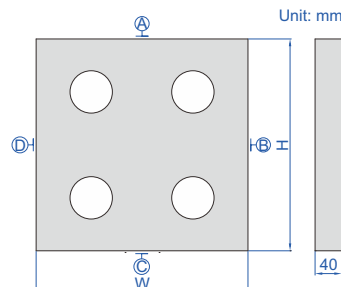

Code	Size (HxW)	Flatness of A, B, C and D	Squareness and parallelism between A, B, C and D
4144-315	315x315mm	1.1µm	2.6µm

## GRANITE SQUARES

CUSTOM-MADE  
SUPPLY SPECIAL SIZES ACCORDING  
TO CUSTOMER'S REQUEST

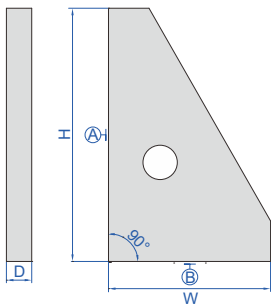

type A



4141-250

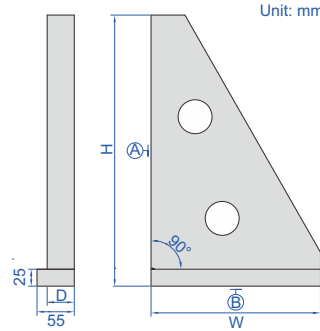

type B

Unit: mm



4141-400B

Code	Size (HxW)	Type	Flatness of A	Flatness of B	Squareness of A to B	D
4141-250	250x160mm	A	1µm	1µm	2µm	25mm
4141-400	400x250mm	A	1.5µm	1µm	3µm	40mm
4141-630	630x400mm	A	2µm	1.5µm	4µm	63mm
4141-400B	400x250mm	B	1.5µm	1µm	3µm	40mm

## CYLINDER SQUARES



4710-200

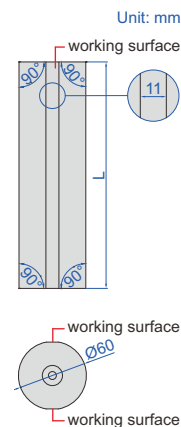

inspect 90° internal and external angles

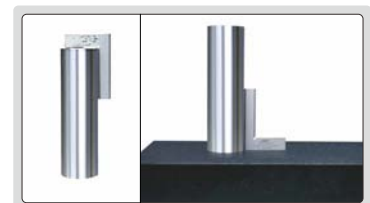

- Made of special alloy steel, hardness HRC58-60
- The handle can be removed

Code	Length (L)	Squareness
4710-200*	200mm	1µm
4710-300*	300mm	2µm

\*Supplied with manufacturer inspection certificate

PERPENDICULARITY TESTERS

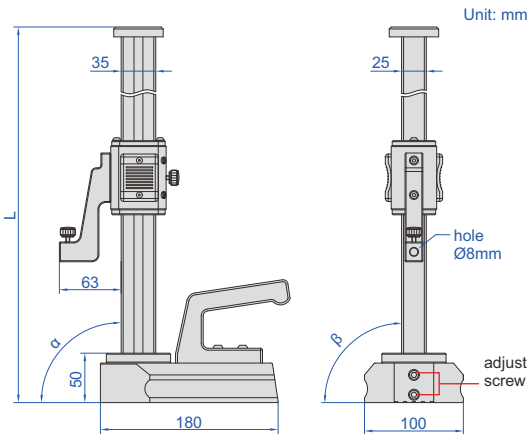

4770-300



- Optional accessory: dial test indicators (graduation: 1µm or 2µm)

Code	Range (H)	Perpendicularity (α)	Side perpendicularity (β)	L
4770-300	0-300mm	3µm	10µm	460mm
4770-600	0-600mm	5µm	20µm	760mm

90° BEVELED EDGE SQUARES

- Satin chrome plating
- Beveled edges for inside and outside measurements
- Made of hardened stainless steel



4790-0100

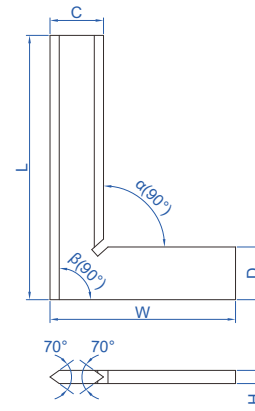

Code	Size (LxW)	Squareness		C	D	H
		Inside (α)	Outside (β)			
4790-050	50x40mm	2.4µm	2.5µm	13	13	4
4790-075	75x50mm	2.6µm	2.8µm	15	15	4
4790-0100	100x70mm	2.8µm	3.0µm	20	20	5
4790-0150	150x100mm	3.2µm	3.5µm	30	30	6
4790-0200	200x130mm	3.7µm	4.0µm	34	34	7
4790-0250	250x165mm	4.2µm	4.5µm	35	35	7
4790-0300	300x200mm	4.6µm	5.0µm	40	40	8

Code	Size (LxW)	Squareness		C	D	H
		Inside (α)	Outside (β)			
4790-500	50x40mm	6µm	6µm	13	13	4
4790-750	75x50mm	6µm	7µm	15	15	4
4790-1000	100x70mm	7µm	7µm	20	20	5
4790-1500	150x100mm	7µm	8µm	30	30	6
4790-2000	200x130mm	8µm	9µm	34	34	7
4790-2500	250x165mm	9µm	10µm	35	35	7
4790-3000	300x200mm	10µm	11µm	40	40	8

## 90° TOOL MAKER SQUARES

- DIN875 grade 00
- Beveled edge for inside measurement
- Made of hardened stainless steel

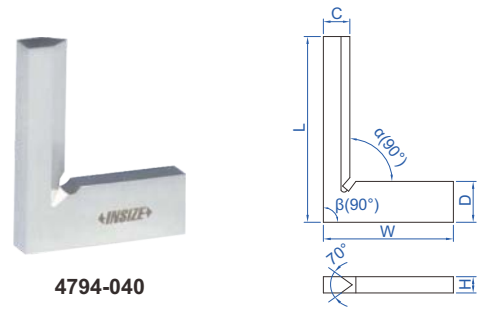

4794-040

(mm)

Code	Size (LxW)	Squareness		C	D	H
		Inside ( $\alpha$ )	Outside ( $\beta$ )			
4794-025	25x20mm	2.2 $\mu$ m	2.3 $\mu$ m	4	6.5	3.5
4794-040	40x28mm	2.3 $\mu$ m	2.4 $\mu$ m	5.5	8.5	3.5

## 90° FLAT EDGE SQUARES

- Made of hardened stainless steel

### DIN875 grade 0

(mm)

Code	Size (LxW)	Squareness		C	D	H
		Inside ( $\alpha$ )	Outside ( $\beta$ )			
4791-50	50x40mm	6 $\mu$ m	6 $\mu$ m	15	15	4
4791-75	75x50mm	6 $\mu$ m	7 $\mu$ m	15	15	4
4791-100	100x70mm	7 $\mu$ m	7 $\mu$ m	20	20	5
4791-150	150x100mm	7 $\mu$ m	8 $\mu$ m	30	30	6
4791-200	200x130mm	8 $\mu$ m	9 $\mu$ m	30	30	7
4791-250	250x165mm	9 $\mu$ m	10 $\mu$ m	35	35	7
4791-300	300x200mm	10 $\mu$ m	11 $\mu$ m	40	40	8



4791-100

### DIN875 grade 1

(mm)

Code	Size (LxW)	Squareness		C	D	H
		Inside ( $\alpha$ )	Outside ( $\beta$ )			
4791-501	50x40mm	12 $\mu$ m	13 $\mu$ m	15	15	4
4791-751	75x50mm	13 $\mu$ m	14 $\mu$ m	15	15	4
4791-1001	100x70mm	14 $\mu$ m	15 $\mu$ m	20	20	5
4791-1501	150x100mm	16 $\mu$ m	18 $\mu$ m	30	30	6
4791-2001	200x130mm	19 $\mu$ m	20 $\mu$ m	30	30	7
4791-2501	250x165mm	21 $\mu$ m	23 $\mu$ m	35	35	7
4791-3001	300x200mm	23 $\mu$ m	25 $\mu$ m	40	40	8

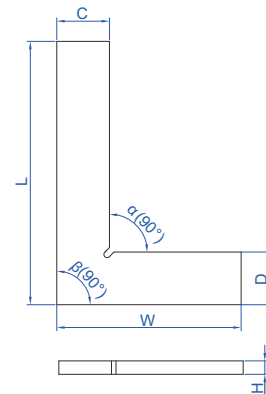

### DIN875 grade 2

(mm)

Code	Size (LxW)	Squareness		C	D	H
		Inside ( $\alpha$ )	Outside ( $\beta$ )			
4791-502	50x40mm	24 $\mu$ m	25 $\mu$ m	15	15	4
4791-752	75x50mm	26 $\mu$ m	28 $\mu$ m	15	15	4
4791-1002	100x70mm	28 $\mu$ m	30 $\mu$ m	20	20	5
4791-1502	150x100mm	33 $\mu$ m	35 $\mu$ m	30	30	6
4791-2002	200x130mm	38 $\mu$ m	40 $\mu$ m	30	30	7
4791-2502	250x165mm	43 $\mu$ m	45 $\mu$ m	35	35	7
4791-3002	300x200mm	47 $\mu$ m	50 $\mu$ m	40	40	8



ATTENTION: NO ANTI-RUST TREATMENT, NOT HARDEND

## MACHINIST SQUARES (ECONOMIC TYPE)

- DIN875 grade 2
- Made of carbon steel, no anti-rust treatment, not hardend

Code	Size (LxW)	Squareness		C	D	H
		Inside ( $\alpha$ )	Outside ( $\beta$ )			
4796-50	50x30mm	24 $\mu$ m	25 $\mu$ m	12	12	3
4796-75	75x50mm	26 $\mu$ m	28 $\mu$ m	16	16	3
4796-100	100x70mm	28 $\mu$ m	30 $\mu$ m	19	19	5
4796-125	125x80mm	30 $\mu$ m	33 $\mu$ m	22	22	5
4796-150	150x100mm	33 $\mu$ m	35 $\mu$ m	25	25	6
4796-200	200x130mm	38 $\mu$ m	40 $\mu$ m	25	25	6
4796-250	250x165mm	43 $\mu$ m	45 $\mu$ m	25	25	6
4796-300	300x200mm	47 $\mu$ m	50 $\mu$ m	30	30	6
4796-350	350x200mm	51 $\mu$ m	55 $\mu$ m	38	38	6
4796-400	400x200mm	56 $\mu$ m	60 $\mu$ m	38	38	9
4796-450	450x250mm	58 $\mu$ m	65 $\mu$ m	38	38	9
4796-500	500x300mm	69 $\mu$ m	70 $\mu$ m	38	38	9

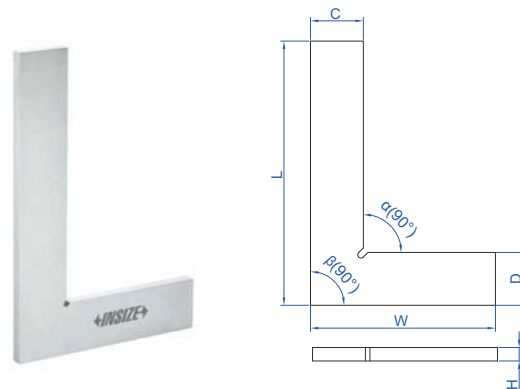

4796-150

## 90° FLAT EDGE SQUARES WITH WIDE BASE

- Made of hardened stainless steel

Code	Size (LxW)	Squareness		C	D	H	E
		Inside ( $\alpha$ )	Outside ( $\beta$ )				
4793-50	50x40mm	6 $\mu$ m	6 $\mu$ m	15	15	4	13
4793-75	75x50mm	6 $\mu$ m	7 $\mu$ m	15	15	4	15
4793-100	100x70mm	7 $\mu$ m	7 $\mu$ m	20	20	5	20
4793-150	150x100mm	7 $\mu$ m	8 $\mu$ m	30	30	6	30
4793-200	200x130mm	8 $\mu$ m	9 $\mu$ m	30	30	7	30
4793-250	250x165mm	9 $\mu$ m	10 $\mu$ m	35	35	7	35
4793-300	300x200mm	10 $\mu$ m	11 $\mu$ m	40	40	8	40



4793-100

Code	Size (LxW)	Squareness		C	D	H	E
		Inside ( $\alpha$ )	Outside ( $\beta$ )				
4793-501	50x40mm	12 $\mu$ m	13 $\mu$ m	15	15	4	13
4793-751	75x50mm	13 $\mu$ m	14 $\mu$ m	15	15	4	15
4793-1001	100x70mm	14 $\mu$ m	15 $\mu$ m	20	20	5	20
4793-1501	150x100mm	16 $\mu$ m	18 $\mu$ m	30	30	6	30
4793-2001	200x130mm	19 $\mu$ m	20 $\mu$ m	30	30	7	30
4793-2501	250x165mm	21 $\mu$ m	23 $\mu$ m	35	35	7	35
4793-3001	300x200mm	23 $\mu$ m	25 $\mu$ m	40	40	8	40

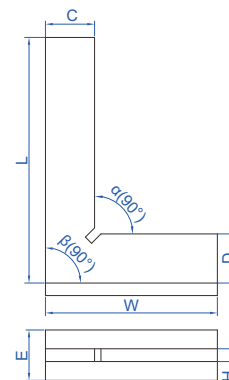

Code	Size (LxW)	Squareness		C	D	H	E
		Inside ( $\alpha$ )	Outside ( $\beta$ )				
4793-502	50x40mm	24 $\mu$ m	25 $\mu$ m	15	15	4	13
4793-752	75x50mm	26 $\mu$ m	28 $\mu$ m	15	15	4	15
4793-1002	100x70mm	28 $\mu$ m	30 $\mu$ m	20	20	5	20
4793-1502	150x100mm	33 $\mu$ m	35 $\mu$ m	30	30	6	30
4793-2002	200x130mm	38 $\mu$ m	40 $\mu$ m	30	30	7	30
4793-2502	250x165mm	43 $\mu$ m	45 $\mu$ m	35	35	7	35
4793-3002	300x200mm	47 $\mu$ m	50 $\mu$ m	40	40	8	40

## 90° FLAT EDGE SQUARES WITH WIDE BASE

- DIN875 grade 0
- Made of hardened stainless steel

Code	Size (LxW)	Squareness		C	D	H	E
		Inside ( $\alpha$ )	Outside ( $\beta$ )				
4792-50	50x40mm	6 $\mu$ m	6 $\mu$ m	12	12	3	10
4792-75	75x50mm	6 $\mu$ m	7 $\mu$ m	14	14	3	10
4792-100	100x70mm	7 $\mu$ m	7 $\mu$ m	18	18	3	10
4792-150	150x100mm	8 $\mu$ m	8 $\mu$ m	22	22	4	12
4792-200	200x130mm	9 $\mu$ m	9 $\mu$ m	25	25	4	12

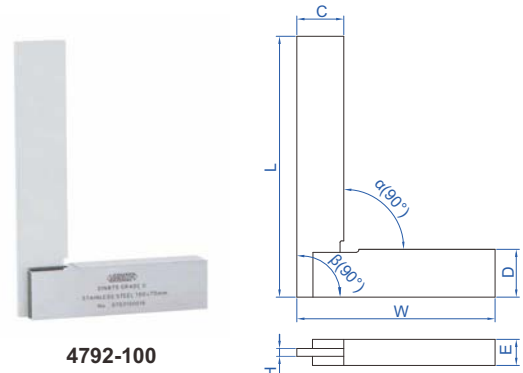

4792-100

## MACHINIST SQUARES WITH WIDE BASE (ECONOMIC TYPE)

ATTENTION: NO ANTI-RUST TREATMENT, NOT HARDEND

- DIN875 grade 2
- Made of carbon steel, no anti-rust treatment, not hardend

Code	Size (LxW)	Squareness		C	D	H	E
		Inside ( $\alpha$ )	Outside ( $\beta$ )				
4707-50	50x40mm	24 $\mu$ m	25 $\mu$ m	16	12	3	9
4707-75	75x50mm	26 $\mu$ m	28 $\mu$ m	16	16	3	9
4707-100	100x70mm	28 $\mu$ m	30 $\mu$ m	19	19	3	12
4707-150	150x100mm	33 $\mu$ m	35 $\mu$ m	25	25	3	16
4707-200	200x130mm	37 $\mu$ m	40 $\mu$ m	30	32	4	16
4707-250	250x165mm	42 $\mu$ m	45 $\mu$ m	30	32	4	19
4707-300	300x200mm	47 $\mu$ m	50 $\mu$ m	32	32	4	19
4707-400	400x250mm	56 $\mu$ m	60 $\mu$ m	38	38	5	22
4707-500	500x300mm	65 $\mu$ m	70 $\mu$ m	45	50	6	25
4707-600	600x350mm	75 $\mu$ m	80 $\mu$ m	50	50	6	30
4707-750	750x400mm	90 $\mu$ m	95 $\mu$ m	55	55	6	50
4707-900	900x500mm	103 $\mu$ m	110 $\mu$ m	65	75	9	50
4707-1000	1000x550mm	113 $\mu$ m	120 $\mu$ m	65	75	9	50



4707-100

## 90° BEVELED EDGE SQUARES WITH WIDE BASE

15

- DIN875 grade 0
- Beveled edges for inside and outside measurements
- Made of hardened stainless steel

Code	Size (LxW)	Squareness		C	D	H	E
		Inside ( $\alpha$ )	Outside ( $\beta$ )				
4795-50	50x40mm	6 $\mu$ m	6 $\mu$ m	12	12	3	10
4795-75	75x50mm	6 $\mu$ m	7 $\mu$ m	14	14	3	10
4795-100	100x70mm	7 $\mu$ m	7 $\mu$ m	18	18	3	10
4795-150	150x100mm	8 $\mu$ m	8 $\mu$ m	22	22	4	12
4795-200	200x130mm	9 $\mu$ m	9 $\mu$ m	25	25	4	12

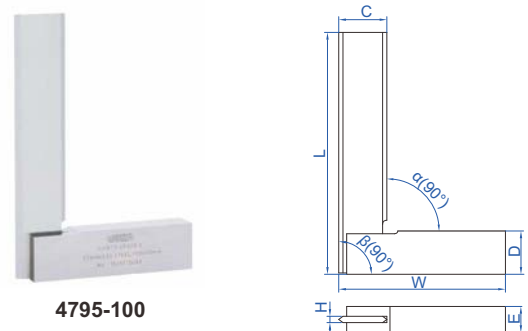

4795-100

### TRY SQUARE

- Graduation: 1mm
- Stainless steel blade, aluminum base

Code	Size (LxW)	Squareness	
		Inside ( $\alpha$ )	Outside ( $\beta$ )
2275-300	300x170mm	0.5mm	0.5mm



2275-300

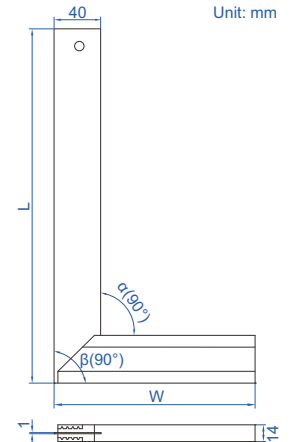

### TRY SQUARE

- Graduation: 1mm
- Aluminum blade and base
- 4 milled surfaces
- Retractable metal ledge support
- Etchings and holes for beveling and framing: 10°, 15°, 22.5°, 30°, 45°, 50° and 60°
- Etchings and holes every cm for fluid pencil marking

Code	Size (LxW)	Squareness	
		Inside ( $\alpha$ )	Outside ( $\beta$ )
2280-300	300x150mm	0.5mm	0.5mm

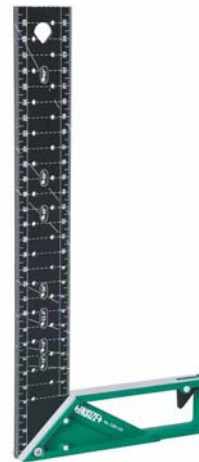

2280-300

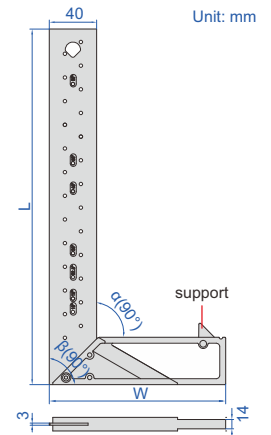

### ADJUSTABLE SQUARE

- The straight edge can move and can be locked by the clamping screw
- Made of hardened stainless steel

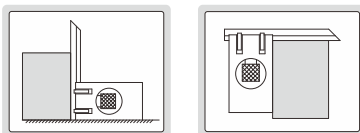

4701-1

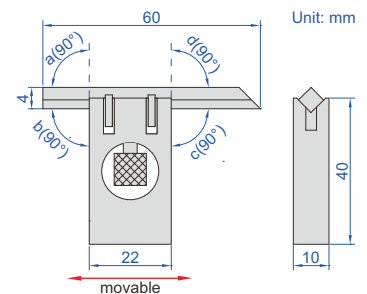

Code	Squareness (a, b, c, d)
4701-1	7 $\mu$ m

## 45° SQUARES

- Made of hardened stainless steel

Code	Size (LxW)	Accuracy		(mm)		
		Inside ( $\alpha$ )	Outside ( $\beta$ )	C	D	H
4745-1120	120x80mm	29 $\mu$ m	32 $\mu$ m	20	20	5
4745-1150	150x100mm	32 $\mu$ m	35 $\mu$ m	20	20	5
4745-1200	200x130mm	36 $\mu$ m	40 $\mu$ m	25	25	5

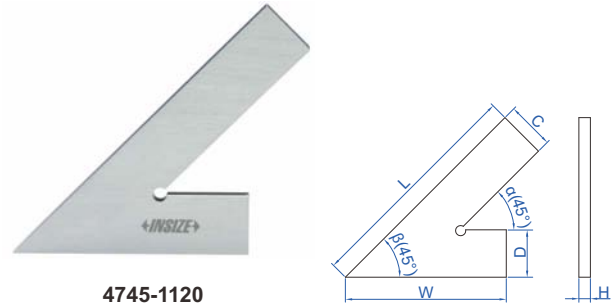

4745-1120

## 45° SQUARES WITH WIDE BASE

- Made of hardened stainless steel

Code	Size (LxW)	Accuracy		(mm)			
		Inside ( $\alpha$ )	Outside ( $\beta$ )	C	D	H	E
4747-120	120x80mm	29 $\mu$ m	33 $\mu$ m	20	20	5	20
4747-150	150x100mm	32 $\mu$ m	36 $\mu$ m	20	20	5	20
4747-200	200x130mm	36 $\mu$ m	41 $\mu$ m	25	25	5	25

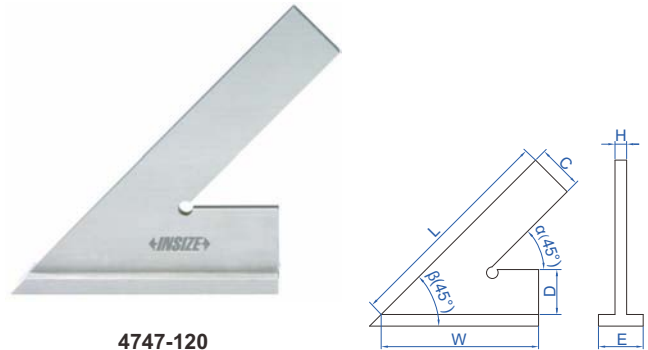

4747-120

## 60° SQUARES

- Made of hardened stainless steel

Code	Size (LxW)	Accuracy		(mm)		
		Inside ( $\alpha$ )	Outside ( $\beta$ )	C	D	H
4760-1120	120x80mm	30 $\mu$ m	32 $\mu$ m	20	20	5
4760-1150	150x100mm	32 $\mu$ m	35 $\mu$ m	20	20	5
4760-1200	200x130mm	37 $\mu$ m	40 $\mu$ m	25	25	5

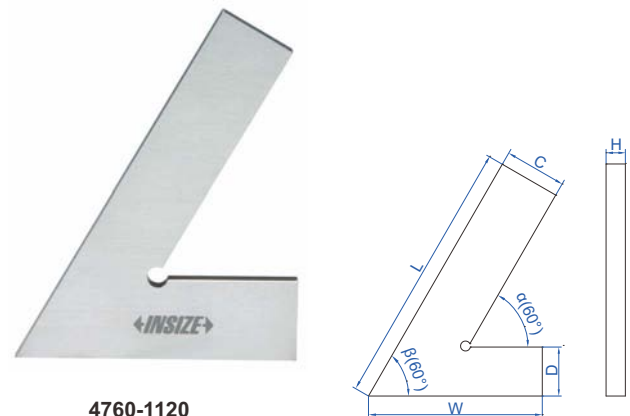

4760-1120

## 60° SQUARES WITH WIDE BASE

- Made of hardened stainless steel

Code	Size (LxW)	Accuracy		(mm)			
		Inside ( $\alpha$ )	Outside ( $\beta$ )	C	D	H	E
4762-120	120x80mm	30 $\mu$ m	33 $\mu$ m	20	20	5	20
4762-150	150x100mm	33 $\mu$ m	36 $\mu$ m	20	20	5	20
4762-200	200x130mm	37 $\mu$ m	41 $\mu$ m	25	25	5	25

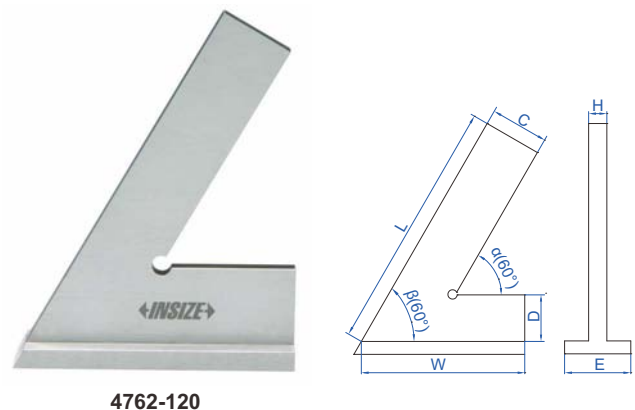

4762-120

## 120° SQUARES

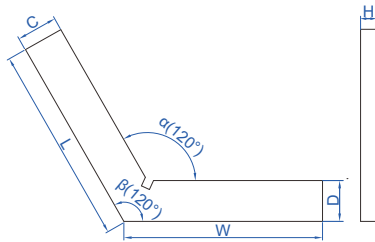

(mm)

Code	Size (LxW)	Accuracy		C	D	H
		Inside ( $\alpha$ )	Outside ( $\beta$ )			
4706-150	50x50mm	24 $\mu$ m	25 $\mu$ m	15	15	5
4706-175	75x75mm	26 $\mu$ m	28 $\mu$ m	20	20	5
4706-1100	100x100mm	29 $\mu$ m	30 $\mu$ m	20	20	5
4706-1150	150x150mm	34 $\mu$ m	35 $\mu$ m	25	25	5
4706-1200	200x200mm	38 $\mu$ m	40 $\mu$ m	30	30	7



4706-1100

- Made of hardened stainless steel

## 135° SQUARES WITH WIDE BASE

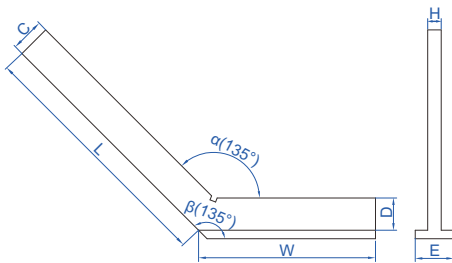

(mm)

Code	Size (LxW)	Accuracy		C	D	H	E
		Inside ( $\alpha$ )	Outside ( $\beta$ )				
4754-3120	120x80mm	31 $\mu$ m	33 $\mu$ m	20	20	5	20
4754-3150	150x100mm	34 $\mu$ m	36 $\mu$ m	20	20	5	20
4754-3200	200x130mm	39 $\mu$ m	41 $\mu$ m	30	30	7	30



4754-3120

- Made of hardened stainless steel

Code	Size (L)	Straightness	W	H
4700-50	50mm	2.2 $\mu$ m	5mm	20mm
4700-75	75mm	2.3 $\mu$ m	5mm	25mm
4700-100	100mm	2.4 $\mu$ m	5mm	25mm
4700-125	125mm	2.5 $\mu$ m	6mm	30mm
4700-150	150mm	2.6 $\mu$ m	6mm	30mm
4700-200	200mm	2.8 $\mu$ m	6mm	30mm
4700-250	250mm	3.0 $\mu$ m	8mm	40mm
4700-300	300mm	3.2 $\mu$ m	8mm	40mm
4700-400	400mm	3.6 $\mu$ m	10mm	50mm
4700-500	500mm	4.0 $\mu$ m	10mm	50mm

## STRAIGHT EDGES



4700-100

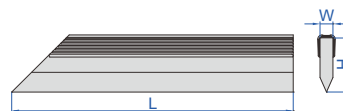

- DIN874
- Beveled edge
- Made of hardened stainless steel
- Satin chrome plating



4702-1

Code  
4702-1

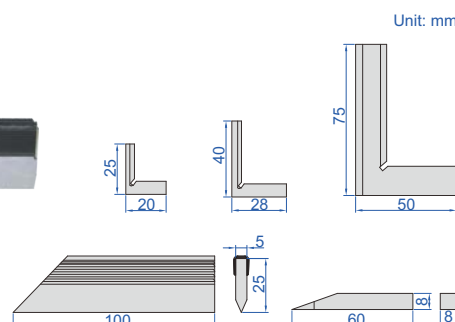

Unit: mm

- Includes:
  - 90° tool maker square 25x20mm DIN875 grade 00 (code **4794-025**)
  - 90° tool maker square 40x28mm DIN875 grade 00 (code **4794-040**)
  - 90° beveled edge square 75x50mm DIN875 grade 00 (code **4790-075**)
  - straight edge 100mm DIN874 (code **4700-100**)
  - scriber
- Made of hardened stainless steel

## GRANITE STRAIGHT EDGES

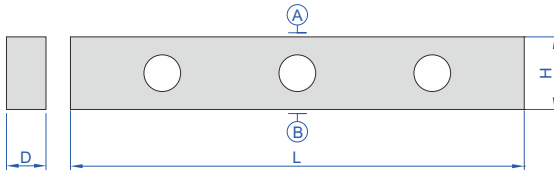

4147-500A

Code	Length (L)	Flatness of A and B	Parallelism between A and B	D	H
4147-500A	500mm	2.1µm	3.2µm	50mm	80mm
4147-1000A	1000mm	3.0µm	4.5µm	60mm	120mm

## MAGNALIUM STRAIGHT EDGES

LIGHT WEIGHT

- Made of magnalium, light weight, non-deform, no rusty



4180-1500

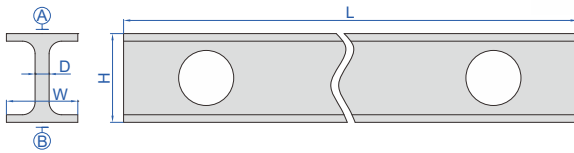

Code	Length (L)	Flatness of A and B	Parallelism between A and B	H	W	D	Weight
4180-500	500mm	3µm	4µm	60mm	30mm	5mm	1kg
4180-1000	1000mm	5µm	8µm	60mm	30mm	5mm	1.5kg
4180-1500	1500mm	15µm	22µm	100mm	40mm	7mm	4.5kg
4180-2000	2000mm	18µm	27µm	100mm	40mm	7mm	6kg
4180-2500	2500mm	22µm	33µm	100mm	40mm	7mm	7.5kg
4180-3000	3000mm	48µm	72µm	150mm	80mm	8mm	21kg

## PRECISION STRAIGHT EDGES

15



7117-300

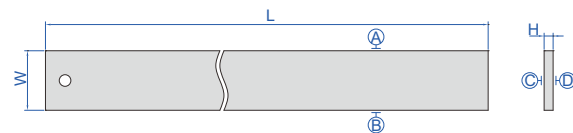

- Check flatness and for marking
- Made of tool steel

Code	Range (L)	Flatness of A and B	Flatness of C and D	W	H
7117-300	305mm	0.005mm	0.05mm	41mm	6.3mm
7117-600	610mm	0.006mm	0.06mm	51mm	7.9mm
7117-900	914mm	0.007mm	0.06mm	64mm	9.5mm

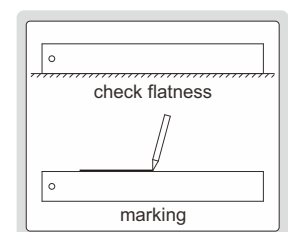

## PRECISION STRAIGHT EDGES WITH BEVELED EDGE



7118-300

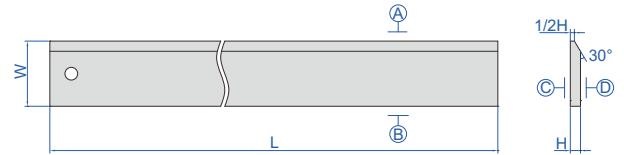

- Check flatness and for marking
- Made of tool steel

Code	Range (L)	Flatness of A and B	Flatness of C and D	W	H
7118-300	305mm	0.005mm	0.05mm	41mm	6.3mm
7118-600	610mm	0.006mm	0.06mm	51mm	7.9mm
7118-900	914mm	0.007mm	0.06mm	64mm	9.5mm

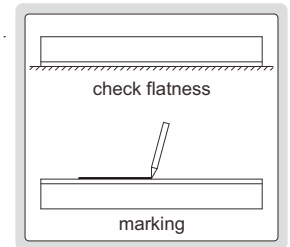

## STRAIGHT EDGES



7111-300A

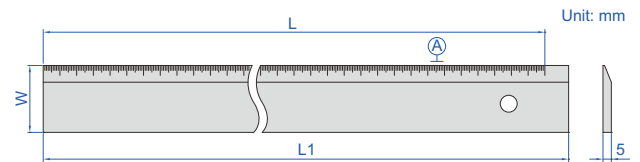

- Check flatness and straightness, as well as for marking
- Graduation on the beveled edge
- Made of hardened tool steel
- Chrome plated
- Graduation: 1mm

Code	Range (L)	Straightness of A	L1	W
7111-300A	300mm	0.02mm	310mm	40mm
7111-500A	500mm	0.03mm	510mm	40mm
7111-1000A	1000mm	0.04mm	1010mm	50mm

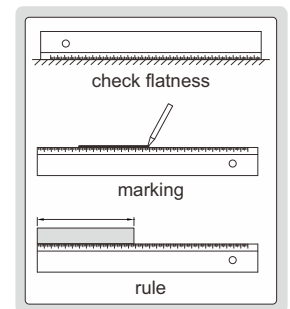

## OPTICAL FLATS

- Check flatness
- Single working face, the arrow indicates the working face



4191-45B

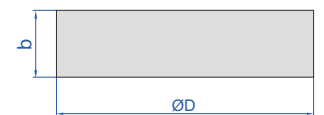

Code	b	ØD	Flatness
4191-45A	12mm	45mm	0.03µm
4191-60A	15mm	60mm	0.03µm

Code	b	ØD	Flatness
4191-45B	12mm	45mm	0.1µm
4191-60B	15mm	60mm	0.1µm

## STRAIGHTNESS/FLATNESS GAGE



GRANITE HOLDER CAN BE CUSTOMIZED ACCORDING TO WORKPIECES

DATA OUTPUT

- Optional accessory: data output cable (code 7315-50M need receiver page 5, 7302-40M page 13)



2144-200

Unit: mm

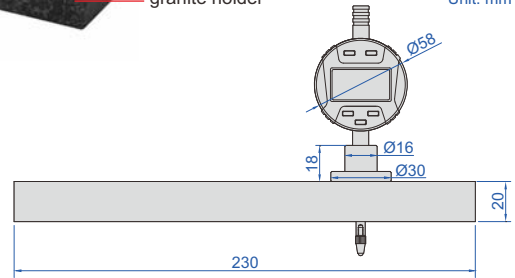
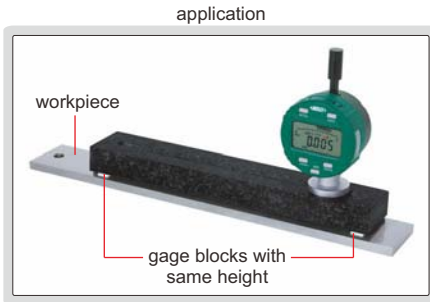

Code	Range	Digital indicator resolution	Straightness measurement accuracy	Parallelism of top and bottom surfaces of granite holder	Flatness of top and bottom surfaces of granite holder
2144-200	200mm	0.001mm/0.00005"	3µm	2µm	1.5µm

## FLATNESS MEASUREMENT STAND

DATA OUTPUT

GRANITE PLATE CAN BE CUSTOMIZED ACCORDING TO WORKPIECES



6852-150

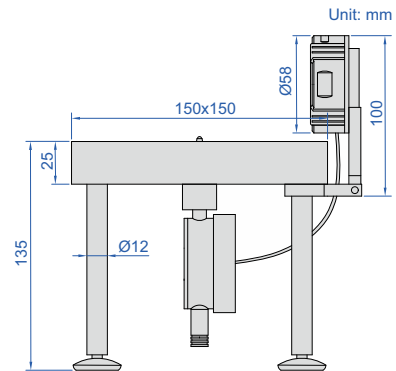

application



- Optional accessory: data output cable (code 7315-50M need receiver page 5, 7302-40M page 13, 7305-40M page 9)

Code	Digital indicator resolution	Flatness measurement accuracy	Flatness of granite plate
6852-150	0.001mm/0.00005"	2µm	2µm





**Concentricity Gages**  
Page 394-398

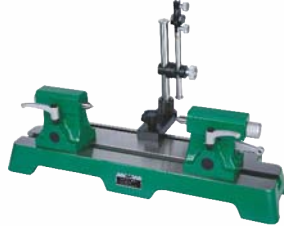

**Bench Centers**  
Page 398-404



**Shank Runout Testers**  
Page 405

## CONCENTRICITY GAGE WITH STRAIGHTNESS MEASUREMENT

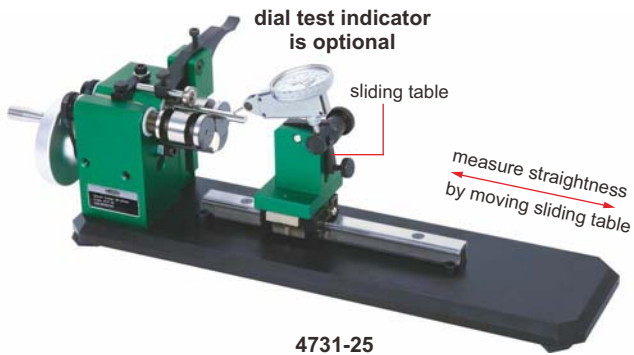

4731-25

- Maximum moving range of sliding table: 120mm
- Optional accessory: dial test indicator



to ensure the accuracy 2 $\mu$ m, the distance between measuring point and roller should be <30mm

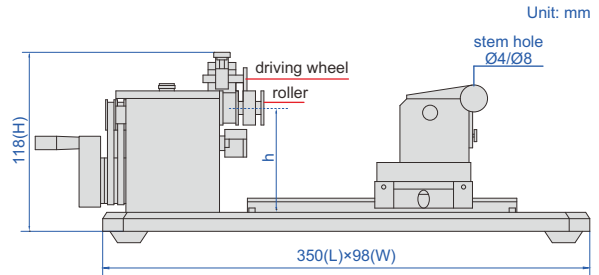
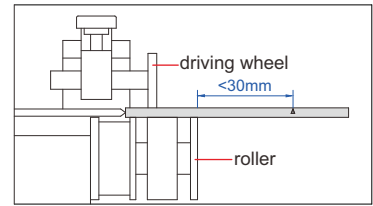

Code	Diameter range	Workpiece length	Roller concentricity accuracy	Straightness measurement accuracy	Center height (h)	L×W×H	Weight
4731-25	Ø1-25mm	15-80mm	2 $\mu$ m	0.01mm	70mm	350×98×118mm	5.3kg

## CONCENTRICITY GAGES

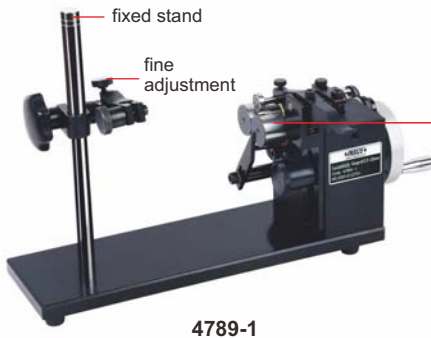

4789-1

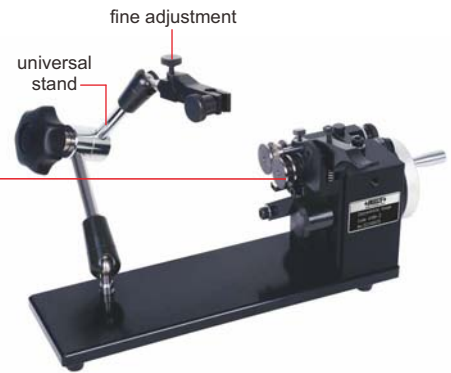

4789-2A

to ensure the accuracy 2 $\mu$ m, the distance between measuring point and roller should be <30mm

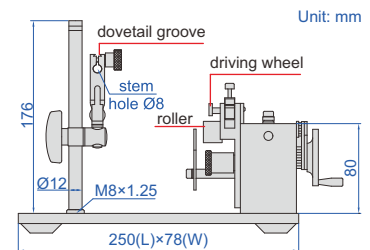
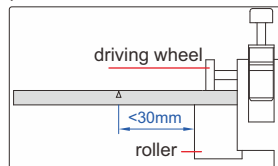

4789-1

- Accuracy 2 $\mu$ m
- Optional accessory: dial test indicator

Code	Applicable diameter	Remark
4789-1	Ø3.5mm-25mm	fixed stand, high accuracy, inconvenient operation
4789-2	Ø1mm-25mm	fixed stand, high accuracy, inconvenient operation
4789-3	Ø1mm-25mm	fixed stand, high accuracy, inconvenient operation
4789-1A	Ø3.5mm-25mm	universal stand, low accuracy, convenient operation
4789-2A	Ø1mm-25mm	universal stand, low accuracy, convenient operation
4789-3A	Ø1mm-25mm	universal stand, low accuracy, convenient operation

HIGH STABILITY,  
LONG WORKING LIFE

## CONCENTRICITY GAGES

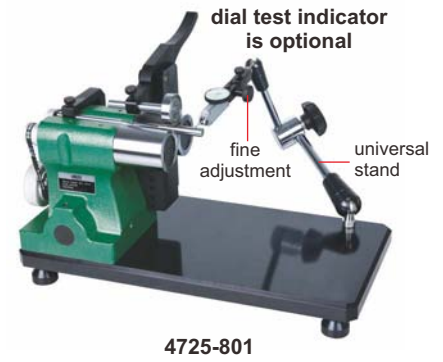
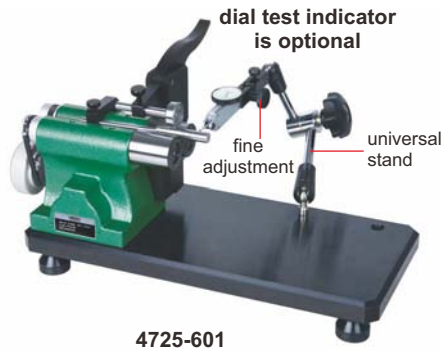
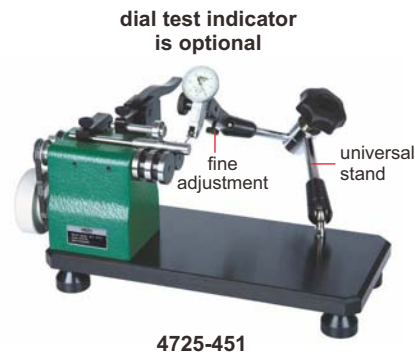
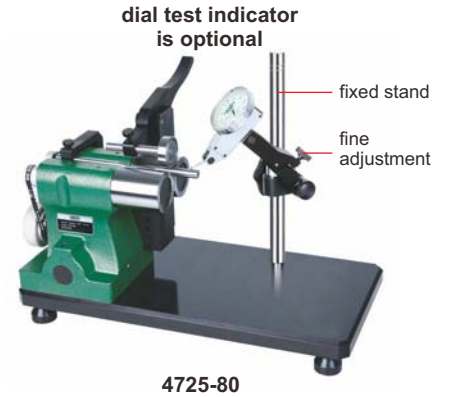
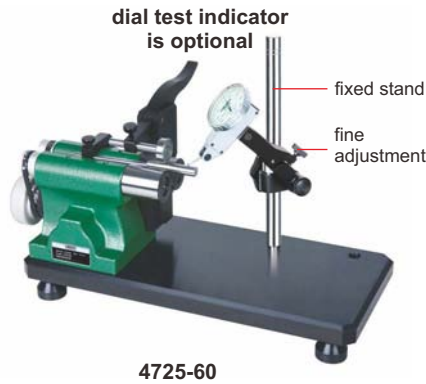

to ensure the accuracy 2 $\mu$ m,  
the distance between measuring  
point and roller should be <30mm

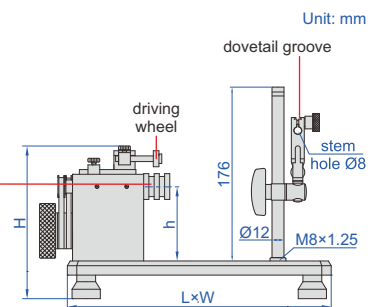
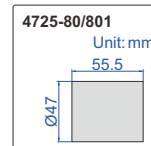
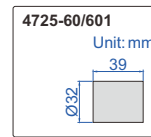
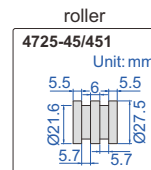
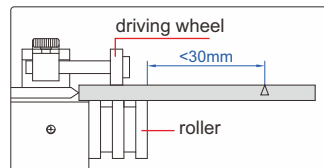

- With ball bearing, high stability, long working life
- Accuracy: 2 $\mu$ m
- Optional accessory: dial test indicator

Code	Diameter range	Center height (h)	L×W×H	Weight	Remark
4725-45	Ø3-45mm	80mm	280×130×170mm	6kg	fixed stand, high accuracy, inconvenient operation
4725-60	Ø8-60mm	90mm	350×160×190mm	15.6kg	fixed stand, high accuracy, inconvenient operation
4725-80	Ø8-80mm	130mm	400×200×250mm	25kg	fixed stand, high accuracy, inconvenient operation
4725-451	Ø3-45mm	80mm	280×130×170mm	6kg	universal stand, low accuracy, convenient operation
4725-601	Ø8-60mm	90mm	350×160×190mm	15.6kg	universal stand, low accuracy, convenient operation
4725-801	Ø8-80mm	130mm	400×200×250mm	25kg	universal stand, low accuracy, convenient operation

## CONCENTRICITY GAGES

QUICK-POSITIONING, SUITABLE FOR MASS MEASUREMENT

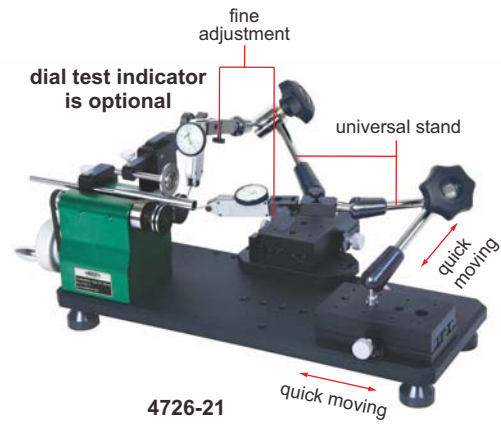
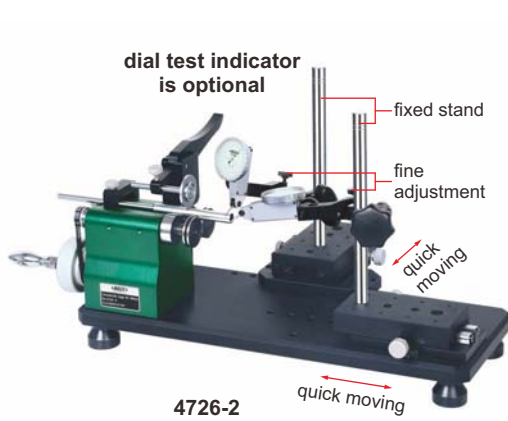

to ensure the accuracy 2 $\mu$ m, the distance between measuring point and roller should be <30mm

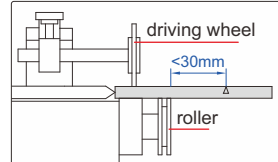

- With ball bearing, high stability, long working life
- Accuracy: 2 $\mu$ m
- Optional accessory: dial test indicator

Code	Applicable diameter	Remark
4726-1	Ø4-40mm	fixed stand, high accuracy, inconvenient operation
4726-2	Ø2-40mm	fixed stand, high accuracy, inconvenient operation
4726-11	Ø4-40mm	universal stand, low accuracy, convenient operation
4726-21	Ø2-40mm	universal stand, low accuracy, convenient operation

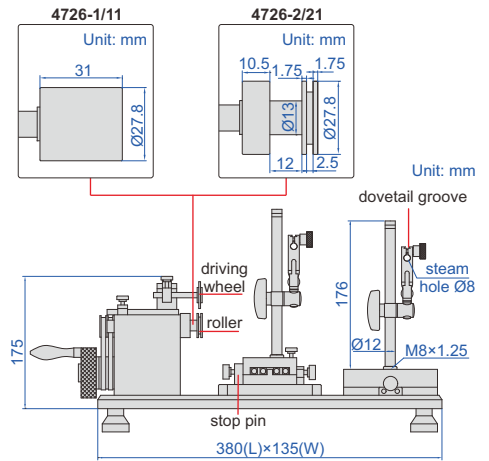

## QUICK POSITIONING CONCENTRICITY GAGE

QUICK-POSITIONING, SUITABLE FOR MASS MEASUREMENT



to ensure the accuracy 2 $\mu$ m, the distance between measuring point and roller should be <30mm

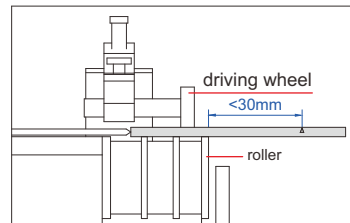

- Quick positioning, suitable for mass measurement
- Optional accessory: dial test indicators

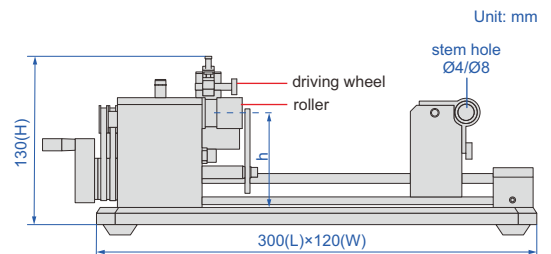

Code	Diameter range	Workpiece length	Accuracy	Center height (h)	L×W×H	Weight
4734-25	Ø3-25mm	15-100mm	2 $\mu$ m	70mm	300×120×130mm	3kg

QUICK-POSITIONING, SUITABLE FOR MASS MEASUREMENT

## QUICK POSITIONING CONCENTRICITY GAGES

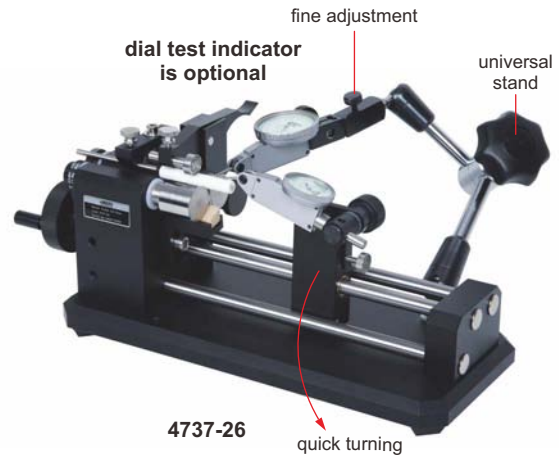
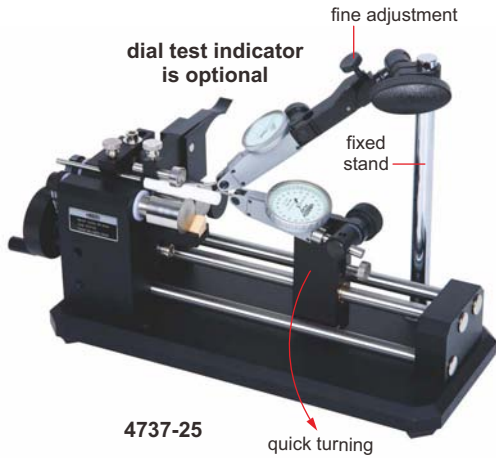

standard rod (included)



to ensure the accuracy 2 $\mu$ m, the distance between measuring point and roller should be <30mm

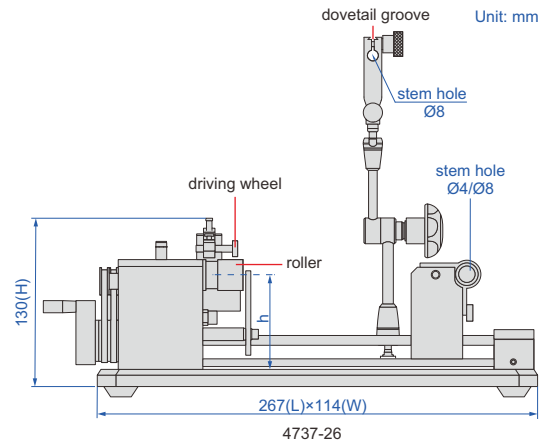
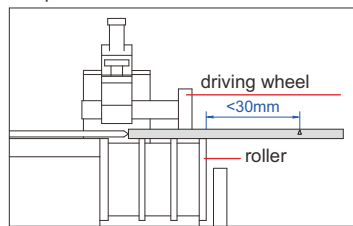

- Quick positioning, suitable for mass measurement
- Supplied with standard rod to verify accuracy
- Optional accessory: dial test indicators

Code	Diameter range	Workpiece length	Accuracy	Center height (h)	L×W×H	Weight	Remark
4737-25	Ø3-25mm	15-100mm	2 $\mu$ m	70mm	267×114×130mm	3kg	fixed stand, high accuracy, inconvenient operation
4737-26	Ø3-25mm	15-100mm	2 $\mu$ m	70mm	267×114×130mm	3kg	universal stand, low accuracy, convenient operation

## CONCENTRICITY GAGES



4786-1

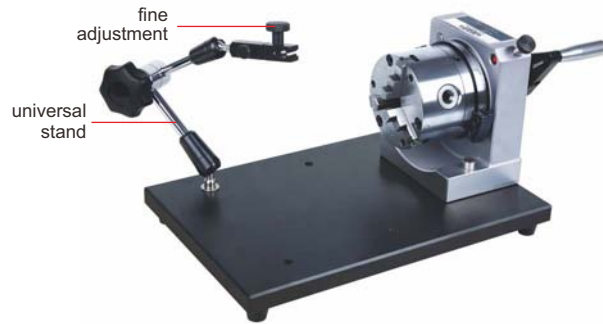

4786-2

- Accuracy: 3 $\mu$ m
- $\varnothing$ 50mm setting ring and  $\varnothing$ 55mm calibration cylinder are included
- Optional accessory: dial test indicator



for cylinder

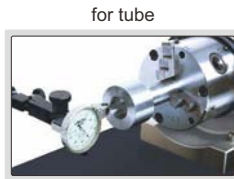

for tube

to ensure the accuracy 3 $\mu$ m, the distance between measuring point and roller should be <50mm

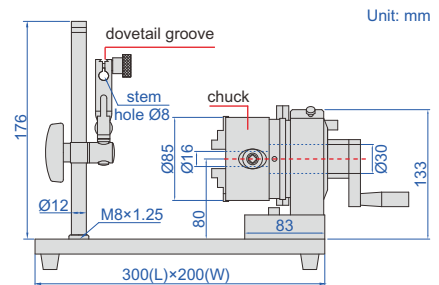
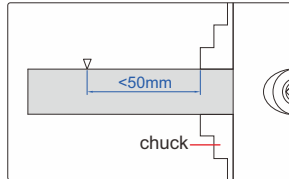

Unit: mm

Code	Applicable inside diameter	Applicable outside diameter	Remark
4786-1	$\varnothing$ 24-64mm	$\varnothing$ 2-70mm	fixed stand, high accuracy, inconvenient operation
4786-2	$\varnothing$ 24-64mm	$\varnothing$ 2-70mm	universal stand, low accuracy, convenient operation

## MOTORIZED BENCH CENTER

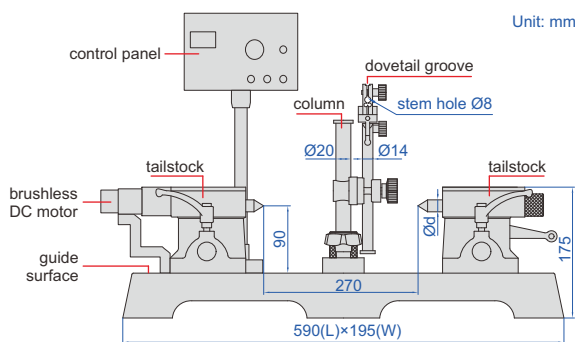

Unit: mm



4735-270

- Moveable column
- Hardened cast-iron guide surface
- Motorized measurement is suitable for mass production inspection
- Power supply: AC220V/10A/(50/60)Hz
- Optional accessory: dial test indicators

Code	Parallelism*	Runout accuracy	Center height	Distance between two centers	Diameter of center ( $\varnothing$ d)	Taper of center	Weight	Load
4735-270	0.010mm	2 $\mu$ m	90mm	270mm	18mm	MT2	40kg	25kg

\*Parallelism of two centers to the guide surface

## MINI BENCH CENTER

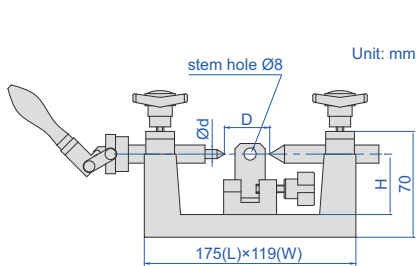

4721-75A

Code	Runout accuracy	Center height (H)	Distance between two centers (D)	Diameter of center (Ød)	Taper of center	Weight	Load
4721-75A	2µm	40mm	35-100mm	6mm	MT1	4.5kg	4kg

## BENCH CENTERS

umbrella centers  
(optional)



rotary centers  
(optional)

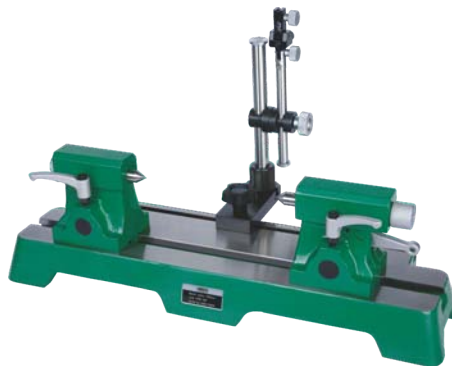

4788-300

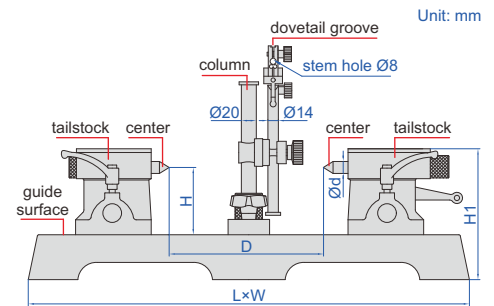

- Movable column
- Optional accessory: umbrella centers, rotary centers

High accuracy

(mm)

Code	Parallelism*	Runout accuracy	Center height (H)	Distance between two centers (D)	L	W	H1	Diameter of center (Ød)	Taper of center	Weight	Load
4788-300	0.010mm	2µm	90	300	590	192	175	18.0	MT2	34kg	25kg
4788-400	0.010mm	2µm	130	400	770	206	241	24.1	MT3	66kg	60kg
4788-600	0.010mm	2µm	130	600	930	220	250	24.1	MT3	90kg	60kg
4788-600H2	0.010mm	2µm	200	600	930	220	325	24.1	MT3	105kg	60kg
4788-1000	0.010mm	3µm	130	1000	1330	220	262	24.1	MT3	112kg	60kg
4788-1000H2	0.010mm	3µm	200	1000	1330	220	337	24.1	MT3	125kg	85kg
4788-1000H3	0.010mm	3µm	300	1000	1330	220	442	31.6	MT4	165kg	85kg

Standard accuracy

(mm)

Code	Parallelism*	Runout accuracy	Center height (H)	Distance between two centers (D)	L	W	H1	Diameter of center (Ød)	Taper of center	Weight	Load
4788-D2	0.010mm	3µm	90	200	490	180	175	20.0	MT2	27kg	25kg
4788-D3	0.010mm	3µm	90	300	590	195	175	20.0	MT2	36kg	25kg
4788-D4	0.012mm	3µm	130	400	730	205	241	28.0	MT3	68kg	60kg
4788-D6	0.015mm	3µm	130	600	930	220	250	28.0	MT3	91kg	60kg
4788-D8	0.015mm	3µm	130	800	1130	220	250	28.0	MT3	99kg	60kg
4788-D10	0.015mm	3µm	130	1000	1330	220	262	28.0	MT3	116kg	60kg

\*Parallelism of two centers to the guide surface

## BENCH CENTER WITH STRAIGHTNESS MEASUREMENT



VIDEO

straightness measurement

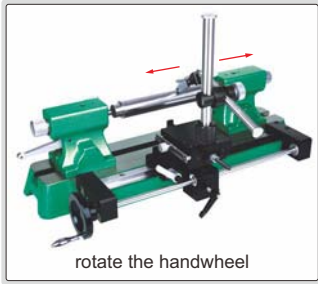

rotate the handwheel



4723-300

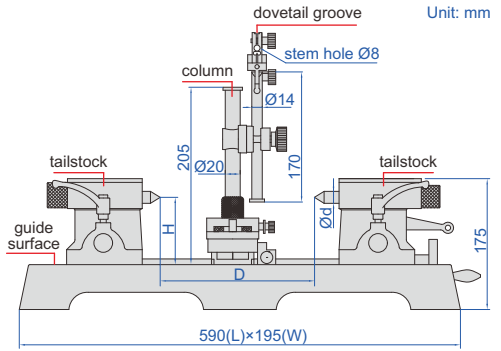

Unit: mm

- Hardened cast-iron guide surface

Code	Parallelism *	Runout accuracy	Accuracy of straightness measurement	Center height (H)	Distance between two centers (D)	Diameter of center (Ød)	Taper of center	Weight	Load
4723-300	4µm	2µm	0.02mm	90mm	300mm	18mm	MT2	38kg	25kg

\* Parallelism of two centers to the guide surface

## BULL NOSE CENTERS

- Supplied in pair
- Suitable for 4723 and 4788 series bench centers

application



6391-MT2

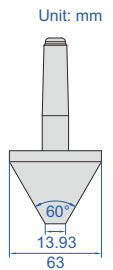

Unit: mm

Code	Taper of handle
6391-MT2	MT2
6391-MT3	MT3

## VERTICAL AND HORIZONTAL BENCH CENTER



vertical use



horizontal use

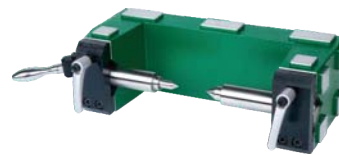

side use

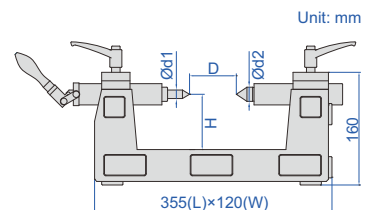

Unit: mm

- For vertical, side and horizontal use

Code	Runout accuracy	Center height (H)	Distance between two centers (D)	Diameter of center (Ød1/Ød2)	Weight	Load
4722-200	2µm	80mm	200mm	16mm/20.2mm	22kg	25kg



## BENCH CENTER (BASIC TYPE)

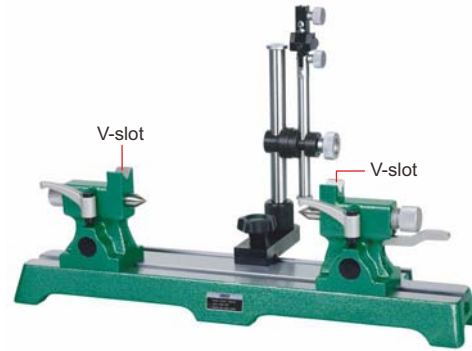
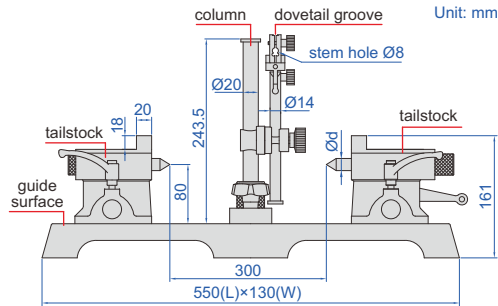

4782-300

- Hardened cast-iron guide surface
- Movable column
- V-slot for cylinder  $\varnothing 4\sim\varnothing 22\text{mm}$

Code	Parallelism*	Runout accuracy	Center height	Distance between two centers	Diameter of center ( $\varnothing d$ )	Load
4782-300	0.01mm	2 $\mu\text{m}$	80mm	300mm	$\varnothing 16\text{mm}$	25kg

\*Parallelism of two centers to the guide surface

## BENCH CENTER WITH ROLLER TAILSTOCKS

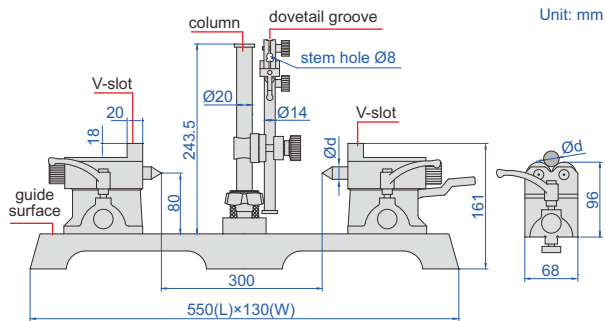

4720-300

roller tailstocks (included)



- Hardened cast-iron guide surface
- Supplied with V-slot/center tailstocks and roller tailstocks
- V-slot for cylinder  $\varnothing 4\sim 22\text{mm}$
- Roller for cylinder  $\varnothing 5\sim 100\text{mm}$

Code	Parallelism*	Runout accuracy	Center height	Distance between two centers	Diameter of center ( $\varnothing d$ )	Taper of center	Load
4720-300	0.01mm	2 $\mu\text{m}$	80mm	300mm	16mm	MT1	25kg (40kg for roller tailstocks)

\*Parallelism of two centers to the guide surface

## BENCH CENTERS

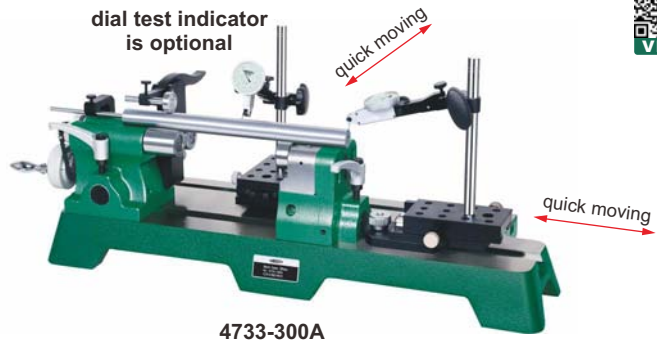
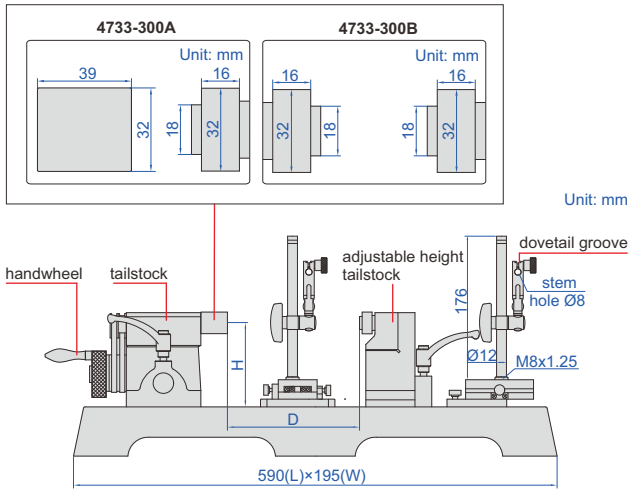

4733-300A

- Hardened cast-iron guide surface
- Quick moving is suitable for mass production inspection
- Adjustable height tailstock: 0-15mm, suitable for inspecting workpieces with different diameters
- Optional accessory: dial test indicator

Code	Runout accuracy	Center height (H)	Distance between two centers (D)	Applicable diameter	Adjustable height	Remarks
4733-300A	2µm	90mm	300mm	Ø8-60mm	0-15mm	with handwheel
4733-300B	2µm	90mm	300mm	Ø8-60mm	0-15mm	without handwheel

## BENCH CENTERS

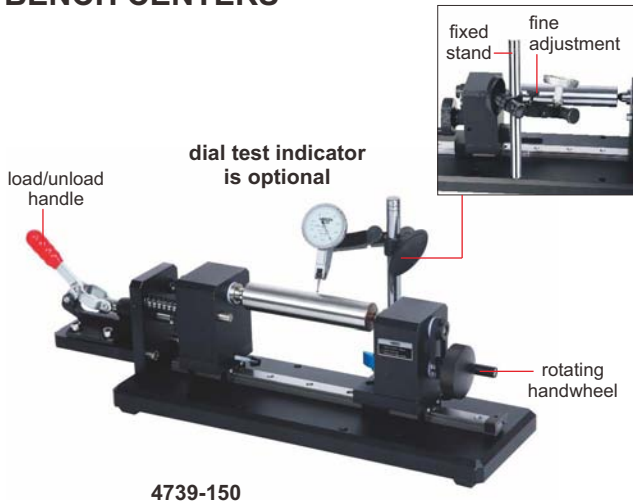

4739-150

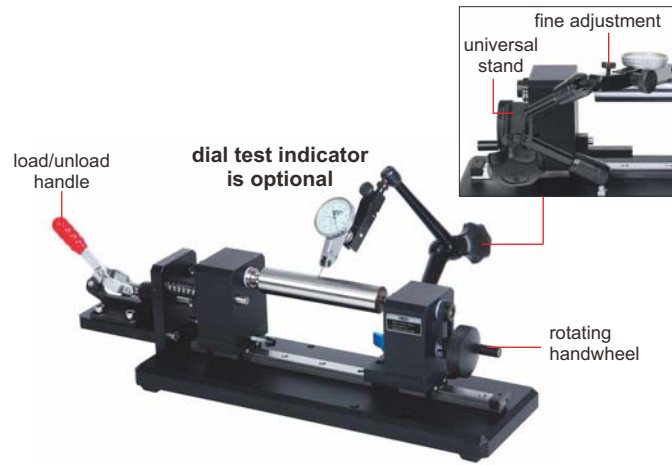

4739-151



**POPULAR MODEL**

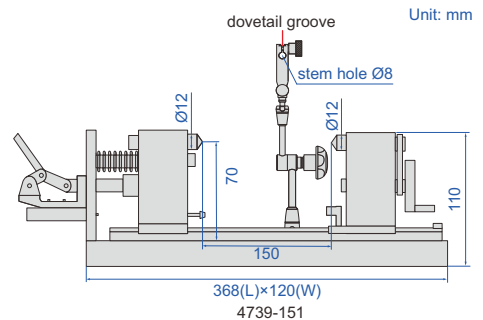

- Quick positioning, suitable for mass measurement
- Suitable for cylinders with outside diameter Ø3-140mm or inside diameter Ø1-12mm
- Supplied with standard rod to verify accuracy
- Optional accessory: dial test indicators

Code	Center height	Distance between two centers	Runout accuracy	Weight	Load	Remark
4739-150	70mm	150mm	2µm	6.5kg	15kg	fixed stand, high accuracy, inconvenient operation
4739-151	70mm	150mm	2µm	6.5kg	15kg	universal stand, low accuracy, convenient operation

BENCH CENTERS

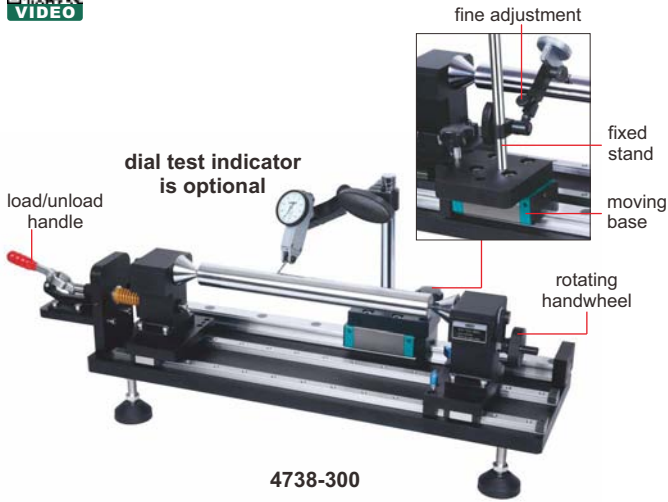

4738-300

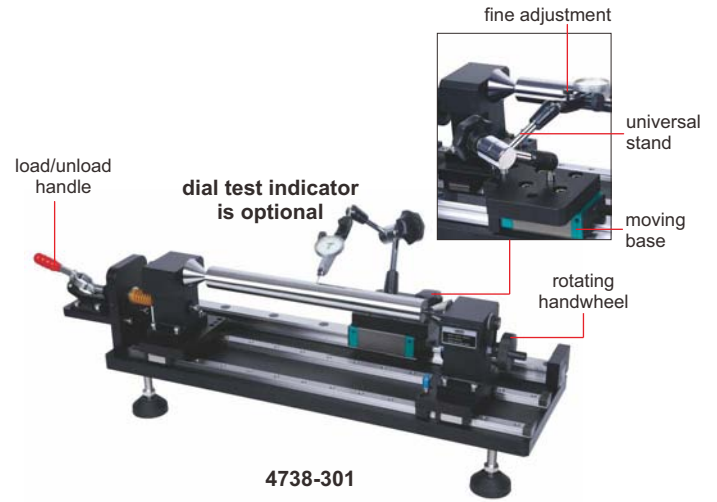

4738-301

dual base (optional)



standard rod (included)

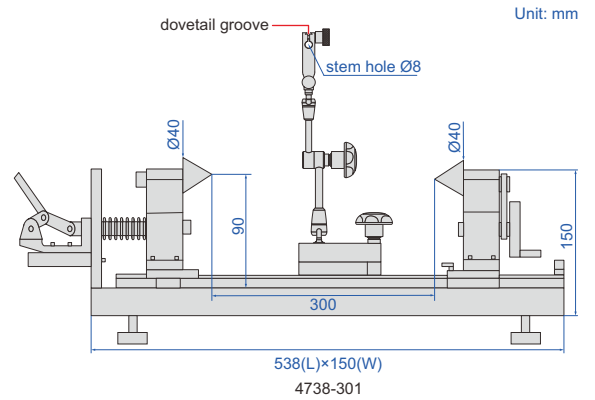

Unit: mm

4738-301

- Quick positioning, suitable for mass measurement
- Suitable for cylinders with outside diameter Ø3-180mm or inside diameter Ø1-40mm
- Supplied with standard rod to verify accuracy
- Optional accessory: dial test indicators

Code	Center height	Distance between two centers	Runout accuracy	Weight	Load	Remark
4738-300	90mm	300mm	2µm	15kg	20kg	fixed stand, high accuracy, inconvenient operation
4738-301	90mm	300mm	2µm	15kg	20kg	universal stand, low accuracy, convenient operation



BENCH CENTER

- Quick positioning, suitable for mass measurement
- Optional accessory: dial test indicators

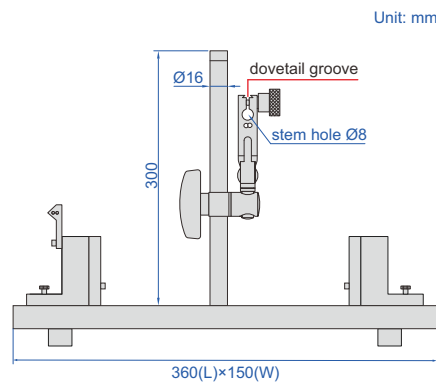

Unit: mm

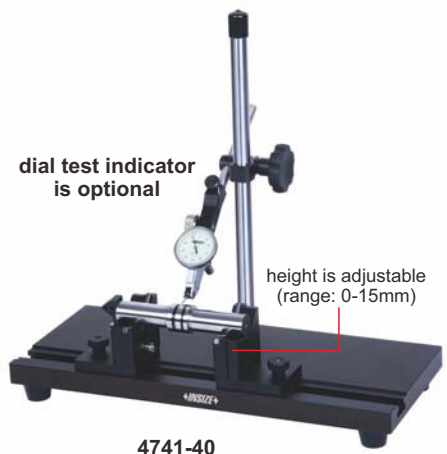

4741-40

Code	Diameter range	Workpiece length	Accuracy	Weight
4741-40	Ø3-40mm	15-300mm	2µm	3.8kg

## VERTICAL BENCH CENTER

- Distance between two centers (L): 360mm
- Hardened cast-iron guide surface
- Use handwheel to move the tailstock
- Optional accessory: magnetic stands, dial test indicator

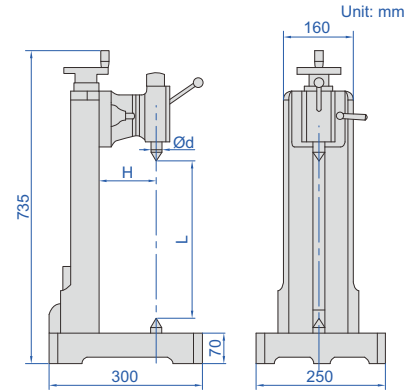
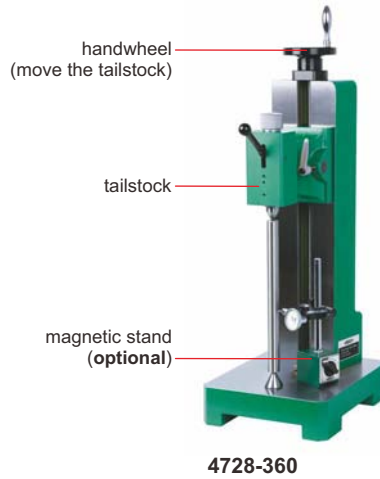

Code	Parallelism*	Runout accuracy	Center height (H)	Diameter of center (Ød)	Taper of center	Weight	Load
4728-360	0.01mm	2µm	130mm	24.1mm	MT3	85kg	80kg

\*Parallelism of two centers to the guide surface

## TAPER INSPECTION INSTRUMENTS

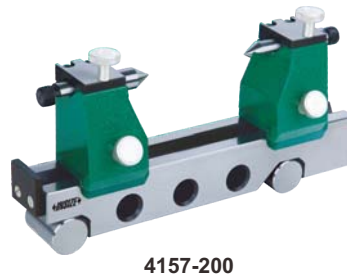
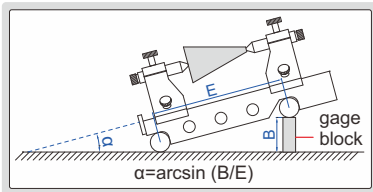

CAN BE CUSTOMIZED

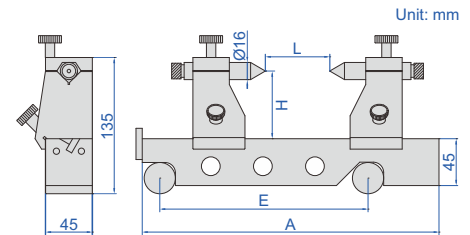

- Check the taper angle of taper bar/taper plug gages /Morse taper/ISO taper etc. The run out can be checked as well

Code	Center height (H)	Center distance (L)	Sine bar accuracy (when α=30°)	E	A
4157-200	65mm	200mm	±5 seconds	200mm	285mm
4157-300	65mm	300mm	±8 seconds	300mm	385mm

## MAGNETIC SQUARE WITH V GROOVE

REFER TO PAGE 459 FOR DETAILS



6539-100

REFER TO PAGE  
452-458 FOR DETAILS

## V-BLOCKS



6896-1



6887-3

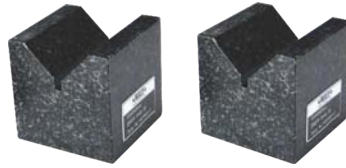

6897-1

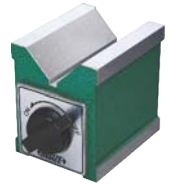

6890-702



6888-1

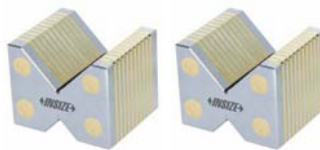

6878-1



6891-1



## SHANK RUNOUT TESTERS



4771-30

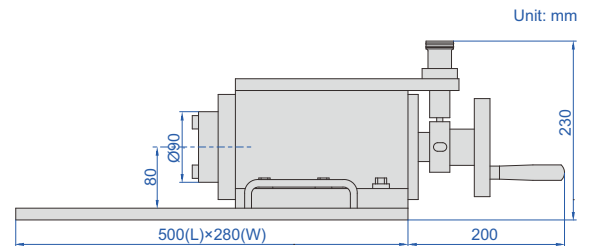

- Measure the radial runout of shanks, collets and cutting tools
- Optional accessory: dial test indicator, magnetic stand

measure radial runout of shank

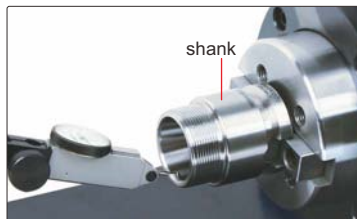

measure radial runout of collet

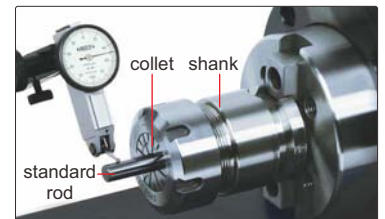

standard shank (included)



measure radial runout of cutter

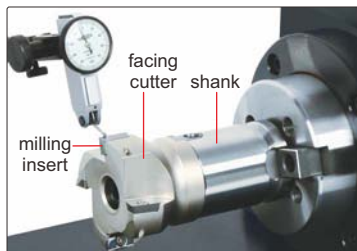

measure radial runout of end mill

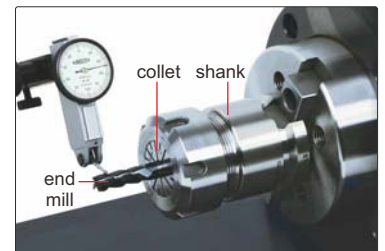

Code	Taper	Accuracy
4771-30	BT30	1µm
4771-40	BT40	1µm
4771-50	BT50	1µm



**Feeler Gages**  
Page 409-412



**Pitch Gages**  
Page 413-414



**Gear Tooth Pitch Gages**  
Page 414

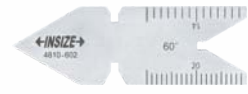

**Center Gages**  
Page 414



**Thread Gages**  
Page 415



**Angle Gages**  
Page 415



**Radius Gages**  
Page 416



**Drill Gages**  
Page 417



**Angle Gages**  
Page 417



**Wire Gages**  
Page 418

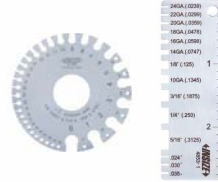

**Thickness Gages**  
Page 418-419

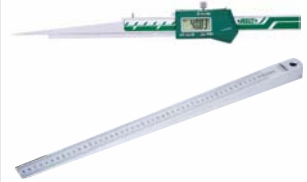

**Taper Slot Gages**  
Page 419-420



**Taper Gages**  
Page 420



**Taper Bore Gages**  
Page 421



**Welding Gages**  
Page 421-422



**Fillet Welding Gages**  
Page 422-423/426



Welding Gages  
Page 423-426



Pipe Welding Gages  
Page 427

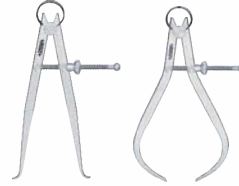

Inside/Outside Calipers  
Page 429



Dividers  
Page 430



Length Tapes  
Page 430



Measuring Tapes  
Page 431-432



Long Measuring Tapes  
Page 433



Measuring Wheels  
Page 433



Digital Measuring Wheels  
Page 434



Steel Rules  
Page 434-436



Combination Squares  
Page 437-438



Plastic Angle Squares  
Page 439



T-bevels  
Page 439



Marking Gages  
Page 439-440



Center Marking Gages  
Page 440



Locators  
Page 440

# 17

## SIMPLE MEASURING TOOLS

←INSIZE→



Scribing Calipers  
Page 441



Height Scribes  
Page 442



Scribers  
Page 442



Precision Screwdriver Sets  
Page 442



LED Flashlights  
Page 442



Measuring Tool Sets  
Page 443-447



## FEELER GAGE



**4601-25**

Unit: mm

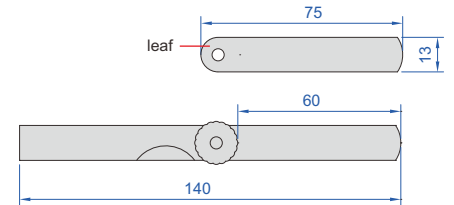

- Made of hardened alloy steel
- Meet DIN2275/grade TC1
- Accuracy:  $\pm(3+T/80)$   $\mu\text{m}$ ,  
'T' is the thickness of leaves in  $\mu\text{m}$

Code	Range	Thickness of leaves included (mm)	Quantity of leaves
4601-25	0.04-1.00mm	0.04, 0.05, 0.06, 0.07, 0.08, 0.09, 0.10, 0.15, 0.20, 0.25, 0.30, 0.35, 0.40, 0.45, 0.50, 0.55, 0.60, 0.65, 0.70, 0.75, 0.80, 0.85, 0.90, 0.95, 1.00	25

## FEELER GAGES



**4602-20**

Unit: mm

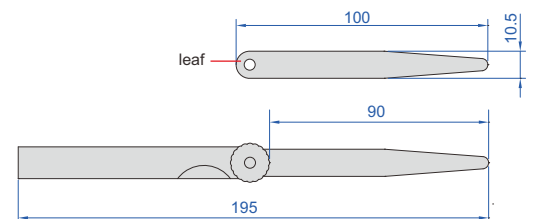

- Made of hardened alloy steel
- Meet DIN2275/grade TC1
- Accuracy:  $\pm(3+T/80)$   $\mu\text{m}$ ,  
'T' is the thickness of leaves in  $\mu\text{m}$

Code	Range	Thickness of leaves included (mm)	Quantity of leaves
4602-13A	0.03-0.50mm	0.03, 0.04, 0.05, 0.06, 0.07, 0.08, 0.09, 0.10, 0.15, 0.20, 0.30, 0.40, 0.50	13
4602-13	0.05-1.00mm	0.05, 0.10, 0.15, 0.20, 0.25, 0.30, 0.40, 0.50, 0.60, 0.70, 0.80, 0.90, 1.00	13
4602-17	0.02-1.00mm	0.02, 0.03, 0.04, 0.05, 0.06, 0.07, 0.08, 0.09, 0.10, 0.15, 0.20, 0.25, 0.30, 0.40, 0.50, 0.75, 1.00	17
4602-20	0.05-1.00mm	0.05, 0.10, 0.15, 0.20, 0.25, 0.30, 0.35, 0.40, 0.45, 0.50, 0.55, 0.60, 0.65, 0.70, 0.75, 0.80, 0.85, 0.90, 0.95, 1.00	20
4602-28	0.05-1.00mm	0.05, 0.06, 0.07, 0.08, 0.09, 0.10, 0.11, 0.12, 0.13, 0.14, 0.15, 0.20, 0.25, 0.30, 0.35, 0.40, 0.45, 0.50, 0.55, 0.60, 0.65, 0.70, 0.75, 0.80, 0.85, 0.90, 0.95, 1.00	28
4602-32	0.03-1.00mm	0.03, 0.04, 0.05, 0.06, 0.07, 0.08, 0.09, 0.10, 0.13, 0.15, 0.18, 0.20, 0.23, 0.25, 0.28, 0.30, 0.33, 0.35, 0.38, 0.40, 0.45, 0.50, 0.55, 0.60, 0.63, 0.65, 0.70, 0.75, 0.80, 0.85, 0.90, 1.00	32

## LONG FEELER GAGES



4605-20

- Made of hardened alloy steel
- Meet DIN2275/grade TC1
- Accuracy:  $\pm(3+T/80)$   $\mu\text{m}$ ,  
'T' is the thickness of leaves in  $\mu\text{m}$

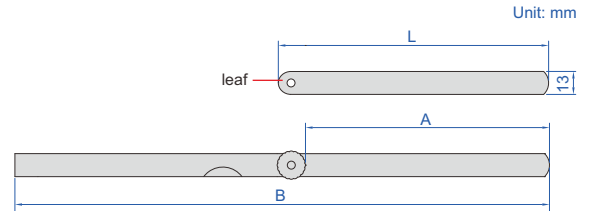

Code	Range	Thickness of leaves included (mm)	Quantity of leaves	L	A	B
4605-13	0.05-1.00mm	0.05, 0.10, 0.15, 0.20, 0.25, 0.30, 0.40, 0.50, 0.60, 0.70, 0.80, 0.90, 1.00	13	150mm	135mm	295mm
4605-131	0.05-1.00mm		13	200mm	185mm	395mm
4605-132	0.05-1.00mm		13	300mm	285mm	590mm
4605-20	0.05-1.00mm	0.05, 0.10, 0.15, 0.20, 0.25, 0.30, 0.35, 0.40, 0.45, 0.50, 0.55, 0.60, 0.65, 0.70, 0.75, 0.80, 0.85, 0.90, 0.95, 1.00	20	150mm	135mm	295mm
4605-201	0.05-1.00mm		20	200mm	185mm	395mm
4605-202	0.05-1.00mm		20	300mm	285mm	590mm

## INCH FEELER GAGE

- 0.010" is made of brass, others are made of hardened alloy steel
- Each blade is marked with inch/metric size



4608-31

Code	Range	Quantity of Leaves
4608-31	0.0015"~0.035"	32

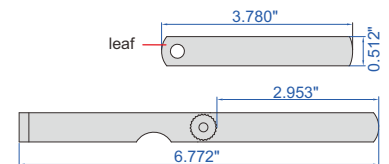

Thickness of leaves included	Accuracy
0.010" (brass)	$\pm 0.00039"$
0.0015", 0.002"	$\pm 0.0002"$
0.0025", 0.003", 0.004", 0.005", 0.006", 0.007"	$\pm 0.00028"$
0.008", 0.009"	$\pm 0.00035"$
0.010", 0.011"	$\pm 0.00039"$
0.012", 0.013"	$\pm 0.00047"$
0.014", 0.015"	$\pm 0.00051"$

Thickness of leaves included	Accuracy
0.016", 0.017"	$\pm 0.00055"$
0.018", 0.019"	$\pm 0.00059"$
0.020", 0.021"	$\pm 0.00067"$
0.022", 0.023"	$\pm 0.00071"$
0.024", 0.025", 0.026"	$\pm 0.00075"$
0.028"	$\pm 0.00091"$
0.030"	$\pm 0.00094"$
0.032", 0.035"	$\pm 0.00102"$

## PLASTIC FEELER GAGES



4623-2

Unit: mm

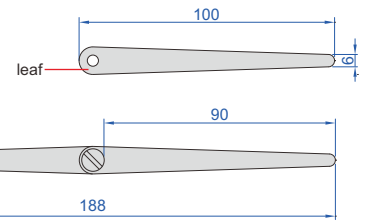

- Accuracy:  $\pm 0.04\text{mm}$  (thickness of leaves: 0.25mm)
- $\pm 0.05\text{mm}$  (thickness of leaves: 0.5mm)
- $\pm 0.08\text{mm}$  (thickness of leaves:  $\geq 1\text{mm}$ )

Code	Range	Thickness of leaves included	Quantity of leaves
4623-2	0.25-2.00mm	2.00mm (0.078"), 1.00mm (0.039"), 0.50mm (0.020"), 0.50mm (0.020"), 0.50mm (0.020"), 0.25mm (0.010"), 0.25mm (0.010"), 1.00mm (0.039"), 2.00mm (0.078"), 1.00mm (0.039"), 2.00mm (0.078"), 1.00mm (0.039"), 2.00mm (0.078")	13
4623-5	0.25-5.00mm	1.00mm (0.039"), 0.25mm (0.010"), 0.50mm (0.020"), 1.50mm (0.059"), 2.00mm (0.078"), 2.50mm (0.098"), 3.00mm (0.118"), 3.50mm (0.138"), 4.00mm (0.157"), 4.50mm (0.177"), 5.00mm (0.196")	11

## PLASTIC FEELER GAGE

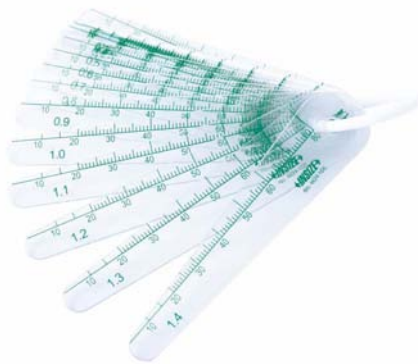

4624-1D5

Unit: mm

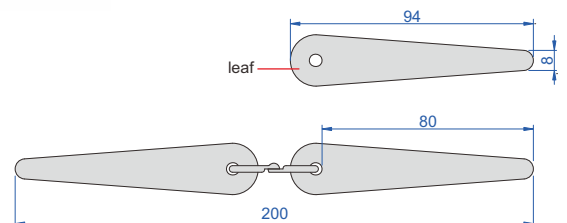

- Accuracy:  $\pm 0.02\text{mm}$  (thickness of leaves: 0.05-0.1mm)
- $\pm 0.03\text{mm}$  (thickness of leaves: 0.15-0.6mm)
- $\pm 0.04\text{mm}$  (thickness of leaves:  $\geq 0.7\text{mm}$ )

Code	Range	Thickness of leaves included (mm)	Quantity of leaves
4624-1D5	0.05-1.5mm	0.05, 0.1, 0.15, 0.2, 0.3, 0.4, 0.5, 0.6, 0.7, 0.8, 0.9, 1.0, 1.1, 1.2, 1.3, 1.4, 1.5	17

## FEELER GAGE STOCKS



- Used as shims to accurately set spacing
- Made of hardened alloy steel
- Length 300mm
- Width 13mm
- 10 pcs per package



4622-10

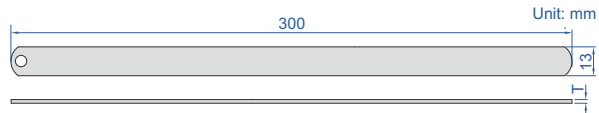

Code	Thickness (T)	Accuracy
4622-02	0.02mm	±3μm
4622-03	0.03mm	±3μm
4622-04	0.04mm	±3μm
4622-05	0.05mm	±3μm
4622-06	0.06mm	±3μm
4622-07	0.07mm	±4μm
4622-08	0.08mm	±4μm
4622-09	0.09mm	±4μm
4622-10	0.10mm	±4μm
4622-12	0.12mm	±5μm

Code	Thickness (T)	Accuracy
4622-15	0.15mm	±5μm
4622-18	0.18mm	±6μm
4622-20	0.20mm	±6μm
4622-25	0.25mm	±6μm
4622-30	0.30mm	±7μm
4622-35	0.35mm	±7μm
4622-40	0.40mm	±8μm
4622-45	0.45mm	±8μm
4622-50	0.50mm	±9μm
4622-55	0.55mm	±9μm

Code	Thickness (T)	Accuracy
4622-60	0.60mm	±9μm
4622-65	0.65mm	±9μm
4622-70	0.70mm	±12μm
4622-75	0.75mm	±12μm
4622-80	0.80mm	±13μm
4622-85	0.85mm	±13μm
4622-90	0.90mm	±14μm
4622-95	0.95mm	±14μm
4622-100	1.00mm	±16μm

## FEELER GAGE TAPES



4621-30

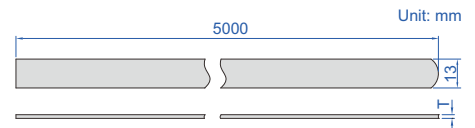

Code	Thickness (T)	Accuracy
4621-02	0.02mm	±4μm
4621-03	0.03mm	±4μm
4621-04	0.04mm	±4μm
4621-05	0.05mm	±4μm
4621-06	0.06mm	±4μm
4621-07	0.07mm	±5μm
4621-08	0.08mm	±5μm
4621-09	0.09mm	±5μm
4621-10	0.10mm	±5μm
4621-12	0.12mm	±5μm
4621-15	0.15mm	±6μm
4621-18	0.18mm	±7μm
4621-20	0.20mm	±8μm
4621-25	0.25mm	±9μm

Code	Thickness (T)	Accuracy
4621-30	0.30mm	±9μm
4621-35	0.35mm	±11μm
4621-40	0.40mm	±12μm
4621-45	0.45mm	±12μm
4621-50	0.50mm	±14μm
4621-55	0.55mm	±14μm
4621-60	0.60mm	±14μm
4621-65	0.65mm	±14μm
4621-70	0.70mm	±17μm
4621-75	0.75mm	±17μm
4621-80	0.80mm	±19μm
4621-85	0.85mm	±19μm
4621-90	0.90mm	±22μm
4621-95	0.95mm	±22μm
4621-100	1.00mm	±24μm

- Used as shims to accurately set spacing
- Made of hardened alloy steel
- Length 5m
- Width 13mm

## PITCH GAGES



4820-122

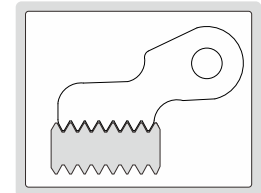

- Identify the pitch of screw thread
- Made of medium carbon steel

### Metric 60° screw

Code	Range	Pitch of leaves included (mm)	Quantity of leaves
4820-122	0.4-7.0mm	0.4, 0.5, 0.6, 0.7, 0.75, 0.8, 0.9, 1, 1.25, 1.5, 1.75, 2, 2.5, 3, 3.5, 4, 4.5, 5, 5.5, 6, 6.5, 7	22
4820-124	0.25-7.0mm	0.25, 0.3, 0.35, 0.4, 0.5, 0.7, 0.75, 0.8, 0.9, 1, 1.25, 1.5, 1.75, 2, 2.5, 3, 3.5, 4, 4.5, 5, 5.5, 6, 6.5, 7	24
4820-1241	0.25-6.0mm	0.25, 0.3, 0.35, 0.4, 0.45, 0.5, 0.6, 0.7, 0.75, 0.8, 0.9, 1, 1.25, 1.5, 1.75, 2, 2.5, 3, 3.5, 4, 4.5, 5, 5.5, 6	24

### Unified 60° screw

Code	Range	Pitch of leaves included	Quantity of leaves
4820-230	4-42TPI	4, 4-1/2, 5, 5-1/2, 6, 7, 8, 9, 10, 11, 11-1/2, 12, 13, 14, 15, 16, 18, 20, 22, 24, 26, 27, 28, 30, 32, 34, 36, 38, 40, 42TPI	30

### Whitworth 55° screw

Code	Range	Pitch of leaves included	Quantity of leaves
4820-330	4-42TPI	4, 4-1/2, 5, 5-1/2, 6, 7, 8, 9, 10, 11, 12, 13, 14, 15, 16, 18, 19, 20, 22, 24, 26, 27, 28, 30, 32, 34, 36, 38, 40, 42TPI	30
4820-328	4-62TPI	4, 4-1/2, 5, 6, 7, 8, 9, 10, 11, 12, 13, 14, 16, 18, 19, 20, 22, 24, 25, 26, 28, 30, 32, 36, 40, 48, 60, 62TPI	28

### Metric 60° and Whitworth 55° screw

Code	Range	Pitch of leaves included	Quantity of leaves
4820-452	0.25-6.0mm	0.25, 0.3, 0.35, 0.4, 0.45, 0.5, 0.6, 0.7, 0.75, 0.8, 0.9, 1, 1.25, 1.5, 1.75, 2, 2.5, 3, 3.5, 4, 4.5, 5, 5.5, 6mm	52
	4-62TPI	4, 4-1/2, 5, 6, 7, 8, 9, 10, 11, 12, 13, 14, 16, 18, 19, 20, 22, 24, 25, 26, 28, 30, 32, 36, 40, 48, 60, 62TPI	
4820-450	0.4-7.0mm	0.4, 0.5, 0.6, 0.7, 0.75, 0.8, 0.9, 1, 1.25, 1.5, 1.75, 2, 2.5, 3, 3.5, 4, 4.5, 5, 5.5, 6, 6.5, 7mm	50
	4-62TPI	4, 4-1/2, 5, 6, 7, 8, 9, 10, 11, 12, 13, 14, 16, 18, 19, 20, 22, 24, 25, 26, 28, 30, 32, 36, 40, 48, 60, 62TPI	

### Metric 60° and Unified 60° screw

Code	Range	Pitch of leaves included	Quantity of leaves
4820-552	0.4-7.0mm	0.4, 0.5, 0.6, 0.7, 0.75, 0.8, 0.9, 1, 1.25, 1.5, 1.75, 2, 2.5, 3, 3.5, 4, 4.5, 5, 5.5, 6, 6.5, 7mm	52
	4-42TPI	4, 4-1/2, 5, 5-1/2, 6, 7, 8, 9, 10, 11, 11-1/2, 12, 13, 14, 15, 16, 18, 20, 22, 24, 26, 27, 28, 30, 32, 34, 36, 38, 40, 42TPI	

## PITCH GAGES

- Check the pitch of screw thread
- Accuracy:  $\pm 0.07\text{mm}$
- Made of medium carbon steel



4824-12

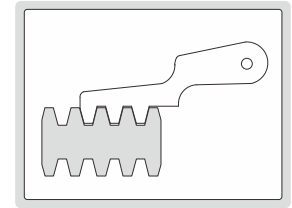

Code	Range	Thread type	Pitch of leaves included	Quantity of leaves
4824-12	2-20mm	Tr30°	2, 3, 4, 5, 6, 7, 8, 9, 10, 12, 16, 20mm	12
4824-16	1-12TPI	ACME 29°	1, 1-1/3, 1-1/2, 1-3/4, 2, 2-1/2, 3, 3-1/2, 4, 5, 6, 7, 8, 9, 10, 12TPI	16

## GEAR TOOTH PITCH GAGES

- Check the module pitch of gear tooth
- Accuracy:  $\pm 0.05\text{mm}$
- Made of hardened stainless steel



4860-245

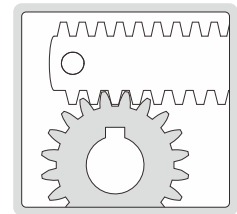

Code	Range	Pressure angle	Quantity of leaves
4860-145	0.35-4.5mm	14.5°	15
4860-245	0.35-4.5mm	20°	15
4860-112	5-12mm	14.5°	8
4860-212	5-12mm	20°	8

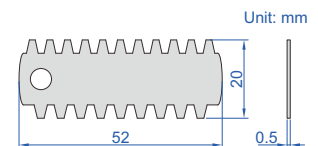

## CENTER GAGES

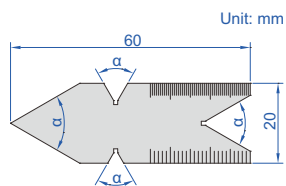

4810-602

- To check and set screw cutting tools, and check the angle and pitch of screw thread
- Angle accuracy:  $\pm 30\text{min}$ .
- Made of stainless steel

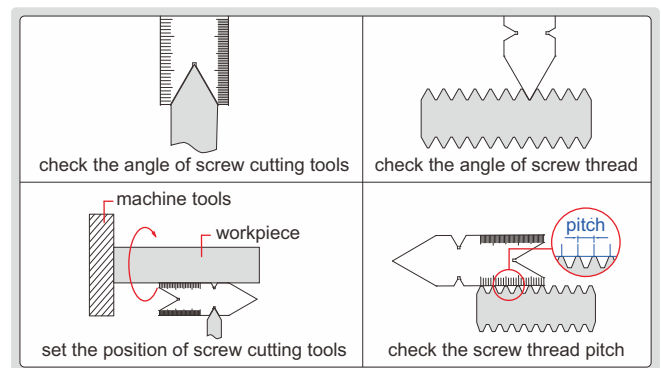

Code	Thread type	Angle ( $\alpha$ )	Graduation
4810-601	METRIC 60°	60°	0.5mm and 1mm
4810-602	UNIFIED 60°	60°	14ths and 20ths on front side, 24ths and 32ths on back side
4810-55	WHITWORTH 55°	55°	14ths and 20ths on front side, 24ths and 32ths on back side

## THREAD GAGES

- To check and set screw cutting tools
- Made of medium carbon steel



4812-E

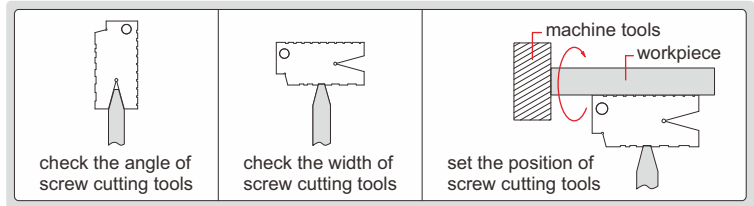
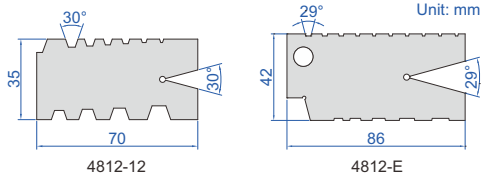

Code	Range	Thread type	Pitch
4812-12	2-12mm	Tr 30°	2, 3, 4, 5, 6, 7, 8, 9, 10, 12mm
4812-E	1-10TPI	ACME 29°	1, 1-1/3, 1-1/2, 1-3/4, 2, 2-1/2, 3, 4, 5, 6, 7, 8, 9, 10TPI

## ANGLE GAGE

- To check complementary angles
- Made of stainless steel



4806-20

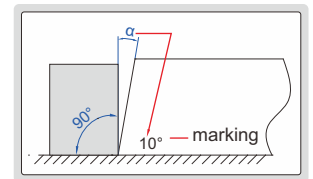

Code	Range (α)	Angle of leaves included	Quantity of leaves	Accuracy
4806-20	1°-45°	1°, 2°, 3°, 4°, 5°, 6°, 7°, 8°, 9°, 10°, 12°, 14°, 16°, 18°, 20°, 25°, 30°, 35°, 40°, 45°	20	±30'

## ANGLE GAGE SET

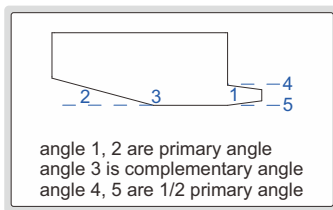

type A

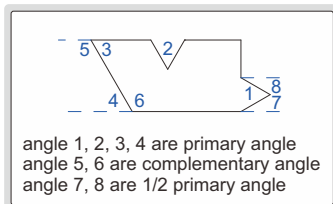

type B



4807

- Each blade checks primary, 1/2 primary and complementary angles
- Made of medium carbon steel

Code	Quantity of leaves	Accuracy
4807	18	±10'

Primary angle	1/2 primary angle	Complementary angle	Type
5°	2°30'	175°	A
10°	5°	170°	A
15°	7°30'	165°	A
20°	10°	160°	B
25°	12°30'	155°	B
30°	15°	150°	B
35°	17°30'	145°	B
40°	20°	140°	B
45°	22°30'	135°	B
50°	25°	130°	B
55°	27°30'	125°	B
60°	30°	120°	B
65°	32°30'	115°	B
70°	35°	110°	B
75°	37°30'	105°	B
80°	40°	100°	B
85°	42°30'	95°	B
90°	45°	90°	B

## RADIUS GAGES

- Made of medium carbon steel



4801-17

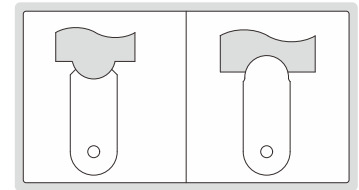

Code	Range	Radius of leaves included (mm)	Quantity of leaves (internal + external)
4801-17	1-7mm	1, 1.25, 1.5, 1.75, 2, 2.25, 2.5, 2.75, 3, 3.5, 4, 4.5, 5, 5.5, 6, 6.5, 7	17+17
4801-16	7.5-15mm	7.5, 8, 8.5, 9, 9.5, 10, 10.5, 11, 11.5, 12, 12.5, 13, 13.5, 14, 14.5, 15	16+16
4801-15	15.5-25mm	15.5, 16, 16.5, 17, 17.5, 18, 18.5, 19, 19.5, 20, 21, 22, 23, 24, 25	15+15

## RADIUS GAGE

- Made of stainless steel

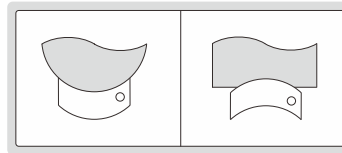

4802-31

Code	Range	Radius of leaves included (mm)	Quantity of leaves
4802-31	25-40mm	25, 25.5, 26, 26.5, 27, 27.5, 28, 28.5, 29, 29.5, 30, 30.5, 31, 31.5, 32, 32.5, 33, 33.5, 34, 34.5, 35, 35.5, 36, 36.5, 37, 37.5, 38, 38.5, 39, 39.5, 40	31

## RADIUS GAGE SET

- Each piece has 3 concave and 2 convex gauging surfaces
- Supplied with handle
- Made of medium carbon steel

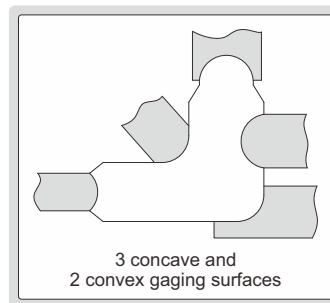

4804-26

Code	Range	Radius of leaves included (mm)	Quantity of leaves
4804-26	0.5-13mm	0.5, 1, 1.5, 2, 2.5, 3, 3.5, 4, 4.5, 5, 5.5, 6, 6.5, 7, 7.5, 8, 8.5, 9, 9.5, 10, 10.5, 11, 11.5, 12, 12.5, 13	26



## DRILL POINT GAGE

- For twist drills with 118° angle, to check if the center of tip is concentric with the drill body
- Made of stainless steel

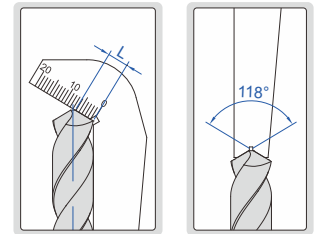
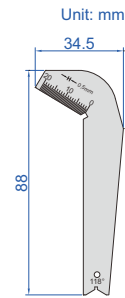

4843-1

Code	Accuracy	
	Angle	Length
4843-1	±0.5°	±0.5mm

## DRILL ANGLE GAGE

- Check drills with angle 60°, 70°, 90°, 118°, 125°, 135°, 150° or 160°
- Made of stainless steel

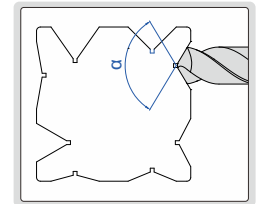
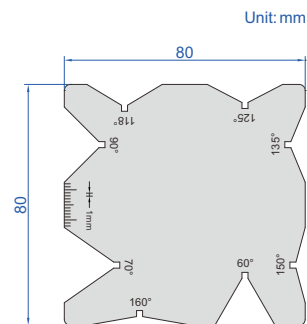

4842-1

Code	Accuracy
4842-1	±0.5°

## ANGLE GAGE

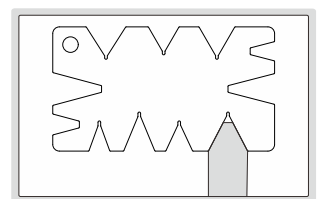

check the angle of screw cutting tools



4854-1

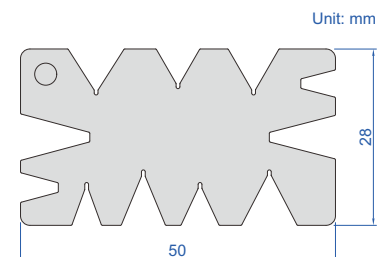

- Made of stainless steel

Code	Range	Accuracy
4854-1	29°, 30°, 40°, 45°, 50°, 55°, 60°	±10'

## AMERICAN STANDARD WIRE GAGE



4808

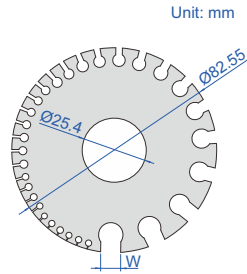

Code	Range
4808	0-36 (8.250-0.127mm/0.3249-0.0050")

- For gaging non-ferrous wire and metals such as copper, brass and aluminum
- Hardened to HRC50-57

No.	W
0	8.250mm/0.3249"
1	7.350mm/0.2893"
2	6.540mm/0.2576"
3	5.830mm/0.2294"
4	5.190mm/0.2043"
5	4.620mm/0.1819"
6	4.110mm/0.1620"
7	3.670mm/0.1443"
8	3.260mm/0.1285"
9	2.910mm/0.1144"
10	2.590mm/0.1019"
11	2.300mm/0.0907"
12	2.050mm/0.0808"
13	1.820mm/0.0720"
14	1.630mm/0.0641"
15	1.450mm/0.0571"
16	1.290mm/0.0508"
17	1.150mm/0.0453"

No.	W
18	1.020mm/0.0403"
19	0.912mm/0.0359"
20	0.813mm/0.0320"
21	0.724mm/0.0285"
22	0.643mm/0.0253"
23	0.574mm/0.0226"
24	0.511mm/0.0201"
25	0.440mm/0.0179"
26	0.404mm/0.0159"
27	0.361mm/0.0142"
28	0.320mm/0.0126"
29	0.287mm/0.0113"
30	0.254mm/0.0100"
31	0.226mm/0.0089"
32	0.203mm/0.0080"
33	0.180mm/0.0071"
34	0.160mm/0.0063"
35	0.142mm/0.0056"
36	0.127mm/0.0050"

## U.S. STANDARD SHEET METAL GAGE



4809

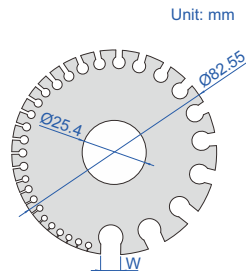

Code	Range
4809	0-36 (7.938-0.179mm/0.3125-0.0070")

- For gaging sheet metal, plate iron and steel
- Hardened to HRC50-57

No.	W
0	7.938mm/0.3125"
1	7.144mm/0.2813"
2	6.747mm/0.2656"
3	6.350mm/0.2500"
4	5.953mm/0.2344"
5	5.556mm/0.2188"
6	5.159mm/0.2031"
7	4.763mm/0.1875"
8	4.366mm/0.1719"
9	3.969mm/0.1563"
10	3.572mm/0.1406"
11	3.175mm/0.1250"
12	2.778mm/0.1094"
13	2.381mm/0.0938"
14	1.984mm/0.0781"
15	1.786mm/0.0703"
16	1.588mm/0.0625"
17	1.429mm/0.0563"

No.	W
18	1.270mm/0.0500"
19	1.111mm/0.0438"
20	0.953mm/0.0375"
21	0.873mm/0.0344"
22	0.794mm/0.0313"
23	0.714mm/0.0281"
24	0.635mm/0.0250"
25	0.556mm/0.0219"
26	0.476mm/0.0188"
27	0.437mm/0.0172"
28	0.397mm/0.0156"
29	0.357mm/0.0141"
30	0.318mm/0.0125"
31	0.278mm/0.0109"
32	0.258mm/0.0102"
33	0.238mm/0.0094"
34	0.218mm/0.0086"
35	0.198mm/0.0078"
36	0.179mm/0.0070"

## WIRE GAGE



4803-1

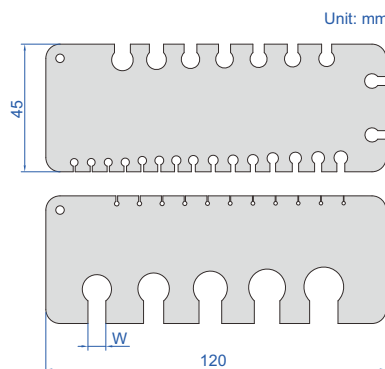

Code	Range
4803-1	0.2-10mm

- For gaging non-ferrous wire and metals such as copper, brass and aluminum
- Hardened to HRC51-53
- Including 2 pcs wire gages

Wire diameter (W)
0.200mm
0.224mm
0.250mm
0.280mm
0.315mm
0.355mm
0.400mm
0.450mm
0.500mm
0.560mm
0.630mm
0.710mm
0.750mm
0.800mm
0.900mm
1.000mm
1.120mm
1.250mm
1.400mm
1.500mm

Wire diameter (W)
1.60mm
1.80mm
2.00mm
2.24mm
2.50mm
2.80mm
3.00mm
3.15mm
3.55mm
3.75mm
4.00mm
4.25mm
4.50mm
5.00mm
5.60mm
6.30mm
7.10mm
8.00mm
9.00mm
10.00mm

## THICKNESS GAGE

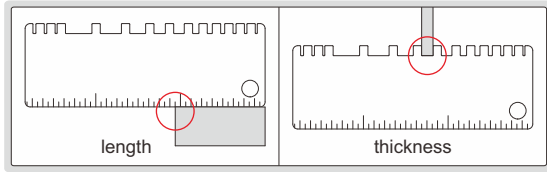

- Made of stainless steel

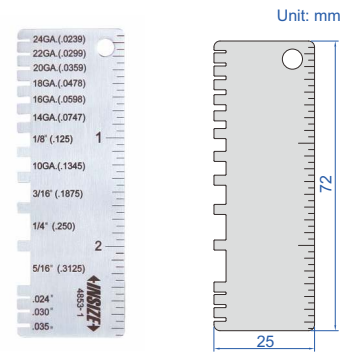

4853-1

Code	Measurement	Range	Graduation	Accuracy
4853-1	length	0-2 3/4"	1/16"	1/32"
	thickness	24GA. (0.0239"), 22GA. (0.0299"), 20GA. (0.0359")	—	±0.002"
		18GA. (0.0478"), 16GA. (0.0598"), 14GA. (0.0747"), 1/8" (0.125"), 10GA. (0.1345"), 3/16" (0.1875"), 1/4" (0.250"), 5/16" (0.3125")		±0.004"
		0.024", 0.030", 0.035"		±0.002"

DATA OUTPUT

DIRECT READING, CALCULATION IS NOT REQUIRED

## DIGITAL TAPER SLOT GAGES



1160-10

- Non waterproof
- Measuring opening, slot width
- Resolution: 0.01mm/0.0005"
- Buttons: on/off, zero, mm/inch
- Automatic power off, move the digital unit to turn on power
- Battery CR2032
- Data output
- Made of stainless steel
- Optional accessory: data output cable (code 7315-1529 need receiver, 7302-1529)

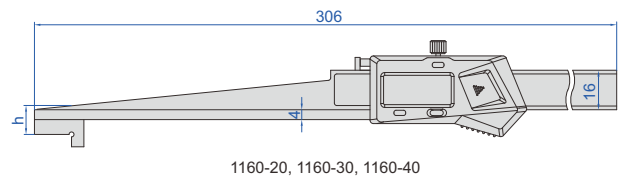
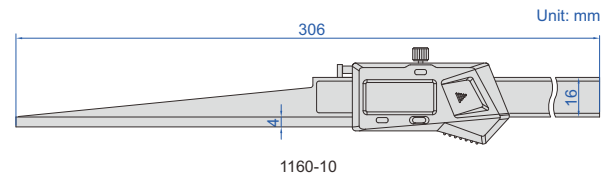

Code	Range	Accuracy	h
1160-10	0.2-10mm/0.01-0.39"	±0.03mm	—
1160-20	10-20mm/0.39-0.79"	±0.05mm	10mm
1160-30	20-30mm/0.79-1.18"	±0.05mm	20mm
1160-40	30-40mm/1.18-1.58"	±0.05mm	30mm

measure slot width

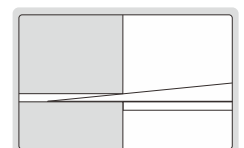

## TAPER SLOT GAGES

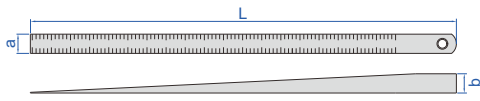

4630-1

- For quick measurement of slot width
- Satin chrome plated reading surface
- Made of stainless steel

Code	Range	Graduation	Accuracy	L	a	b
4630-3	0.4-6mm	0.05mm	±0.04mm	164mm	12.5mm	6.5mm
4630-1	0.5-10mm	0.05mm	±0.07mm	220mm	10mm	10.5mm
4630-2	0.5-15mm	0.1mm	±0.08mm	184mm	12.5mm	16.5mm

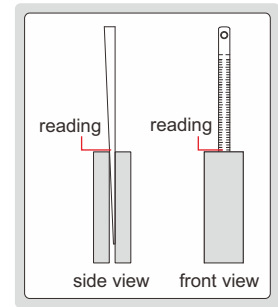

## TAPER GAGES

measure diameter of hole

measure slot width

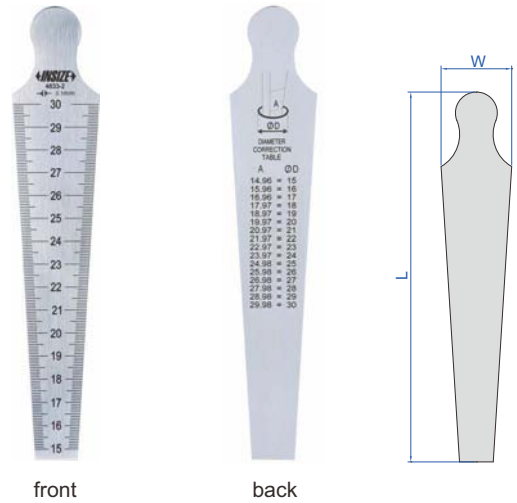
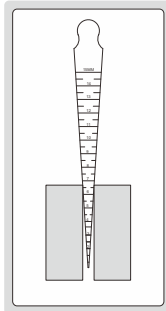
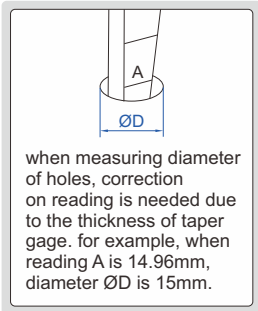

front

back

4833-2

- Measure opening, slot width, hole diameter, etc.
- Diameter correction table on the back (only for 4833-1, 4833-2)
- Made of stainless steel

Code	Range	Graduation	Accuracy	L	W
4833-1	0.8-15mm	0.1mm	±0.05mm	146mm	17mm
4833-2	15-30mm	0.1mm	±0.05mm	159mm	30.4mm
4833-3	30-45mm	0.1mm	±0.05mm	166mm	45.4mm
4833-4	45-60mm	0.1mm	±0.05mm	170mm	60.5mm

## TAPER GAGE SET



front

back

4837-1

- Include 4 pcs (1~8mm, 8~15mm, 15~22mm, 22~29mm)
- Measure opening, slot width, hole diameter, etc.
- Diameter correction table on the back
- Made of stainless steel

Code	Range	Graduation	Accuracy
4837-1	1-29mm	0.05mm	±0.05mm

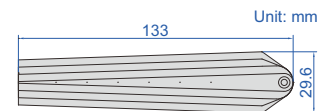

measure diameter of hole

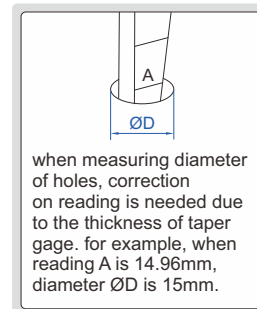

measure slot width

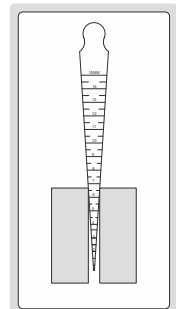

## TAPER BORE GAGES

- Quick measurement of bore diameter
- Hardened steel, HRC50-58
- Satin chrome plated surface
- Aluminium oxidized handle

Code	Range	Graduation	Accuracy	L	Ød1	Ød2
4852-1	1-6.5mm	0.1mm	±0.05mm	62.5	7	0.8
4852-3	3-16mm	0.1mm	±0.05mm	143	17	2.8
4852-15	15-30mm	0.1mm	±0.05mm	165	31	14.7
4852-30	30-45mm	0.1mm	±0.05mm	165	46	29.6
4852-45	45-60mm	0.1mm	±0.05mm	167	61	44.3



4852-15

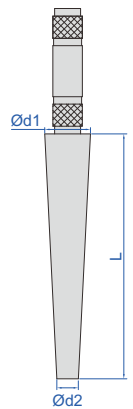

## SMALL TAPER BORE GAGE

- Quick measurement of small bore diameter
- Hardened working face
- Supplied with protection cap

Code	Range	Graduation	Accuracy
4855-5	0.1-5mm	0.01mm	±0.03mm



4855-5

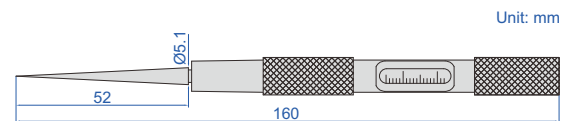

supplied with protection cap



## WELDING GAGE

- Made of stainless steel
- Satin chrome plated reading surface

Code	Measurement	Range	Graduation	Accuracy
4830	crown height	0-8mm	0.1mm	±0.1mm
	fillet weld throat size	0-20mm	0.1mm	±0.3mm
	angle	60°, 70°, 80°, 90°	—	±1°

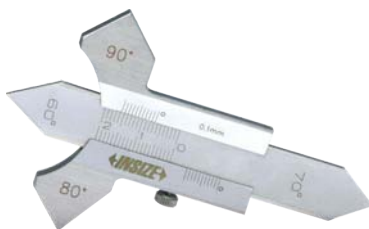

4830

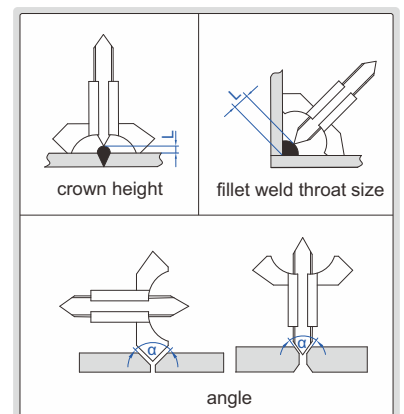
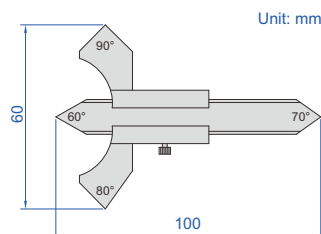

## DIGITAL WELDING GAGE

ATTENTION:  
NO DATA OUTPUT



4831-20A

- Non waterproof
- Buttons: zero, mm/inch, on/off
- Battery LR44
- Made of stainless steel

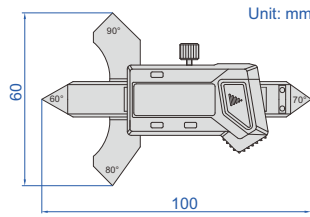

Unit: mm

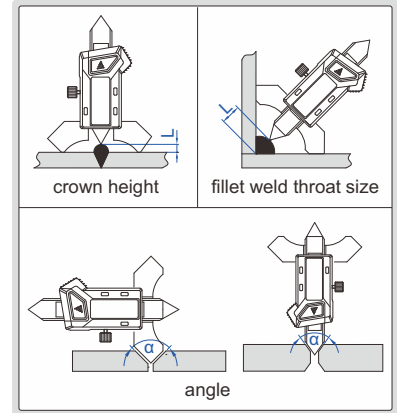

Code	Measurement	Range	Resolution	Accuracy
4831-20A	crown height	0-7mm	0.01mm/0.0005"	±0.03mm
	fillet weld throat size	0-20mm	0.01mm/0.0005"	±0.1mm
	angle	60°, 70°, 80°, 90°	—	±1°

## FILLET WELDING GAGE

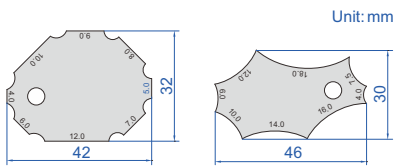

Unit: mm



4832-1

- Made of stainless steel
- Sizes marked on both faces

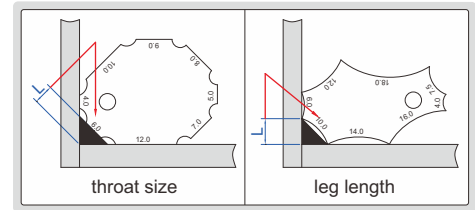

Code	Throat size	Leg length	Accuracy
4832-1	4, 5, 6, 7, 8, 9, 10, 12mm	4, 6, 7.5, 10, 12, 14, 16, 18mm	±0.5mm

## FILLET WELDING GAGES

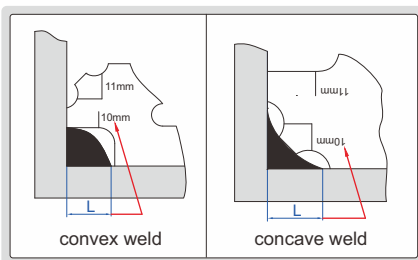

4836-1



4836-2

- Measure concave and convex weld sizes
- 7 blades are included
- Made of stainless steel

Code	Size	Accuracy
4836-1	3mm, 4mm, 5mm, 6mm, 8mm, 9mm, 10mm, 11mm, 12mm, 14mm, 16mm, 19mm, 22mm, 25mm	±0.5mm
4836-2	1/8" (3.2mm), 3/16" (4.8mm), 1/4" (6.4mm), 5/16" (7.9mm), 3/8" (9.5mm), 7/16" (11.1mm), 1/2" (12.7mm), 5/8" (15.9mm), 3/4" (19.1mm), 7/8" (22.2mm), 1" (25.4mm)	±0.02" (0.5mm)

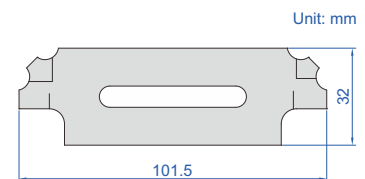

Unit: mm

## FILLET WELDING GAGE

- Measure convex weld sizes
- 3 blades are included
- Made of stainless steel



4847-1

Code	Measurement	Range	Graduation	Accuracy
4847-1	convex weld size	4, 6, 8, 10, 12, 14mm	—	±0.5mm
	length	0-50mm	1mm	±0.5mm

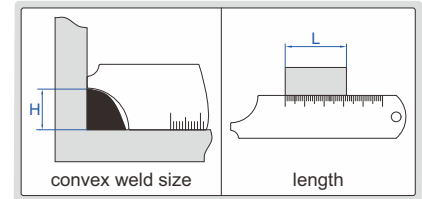
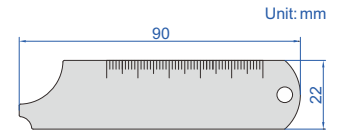

## WELDING GAGE

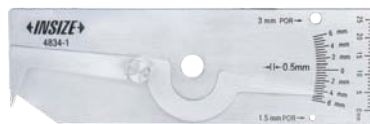
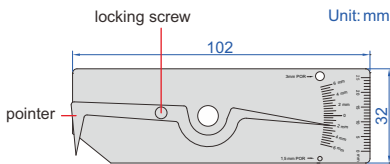

4834-1

- Pointer can be locked for later reference
- Made of stainless steel

Code	Measurement	Range	Graduation	Accuracy
4834-1	undercut depth	0-6mm	0.5mm	±0.5mm
	crown height	0-6mm	0.5mm	±0.5mm
	porosity size comparison	1.5mm, 3mm	—	±0.2mm
	amount of porosity per 25mm	25mm	1mm	—

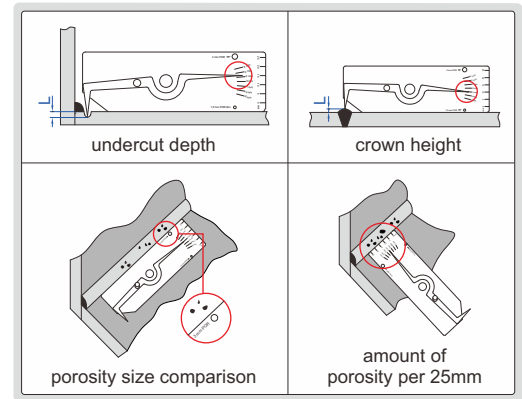

## WELDING GAGE

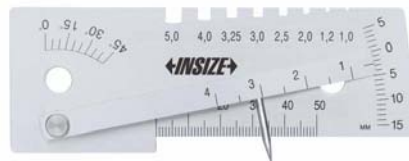
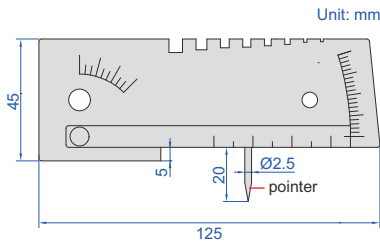

4848-1

- Made of stainless steel

Code	Measurement	Range	Graduation	Accuracy
4848-1	misalignment (high-low)	-5mm~+15mm	1mm	±0.5mm
	angle of preparation	0°-45°	5°	±2.5°
	length	0-50mm	1mm	±0.5mm
	gap	1-4mm	0.5mm	±0.25mm
	thickness	1, 1.2, 2.0, 2.5, 3.0, 3.25, 4.0, 5.0mm	—	—

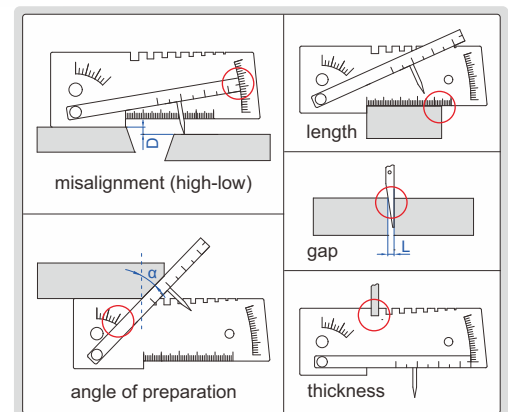

## WELDING GAGE



front



back

6832-1

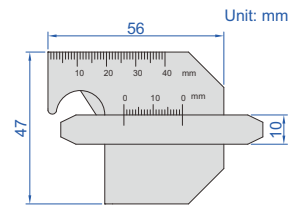

- Made of stainless steel
- Satin chrome plated surface

Code	Measurement	Range	Graduation	Accuracy
6832-1	leg length	0-20mm	1mm	±0.3mm
	leg height	0-20mm	1mm	±0.3mm
	crown height	0-20mm	1mm	±0.3mm
	throat size	0-10mm	1mm	±0.3mm
	angle	0°-60°	5°	±1°
	gap	1-3.5mm	0.5mm	±0.2mm
	length	0-40mm	1mm	±0.3mm

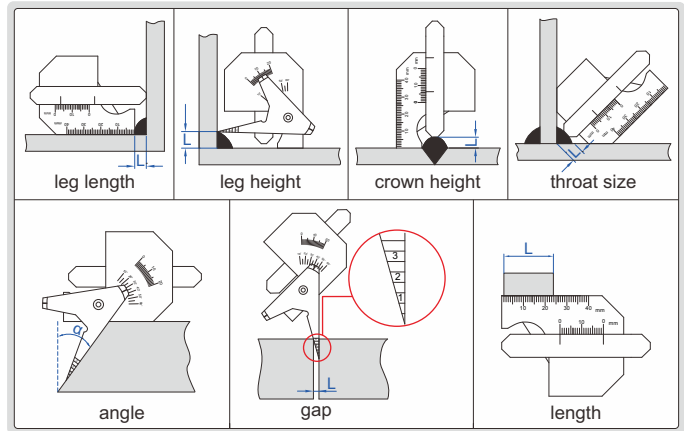

## WELDING GAGES

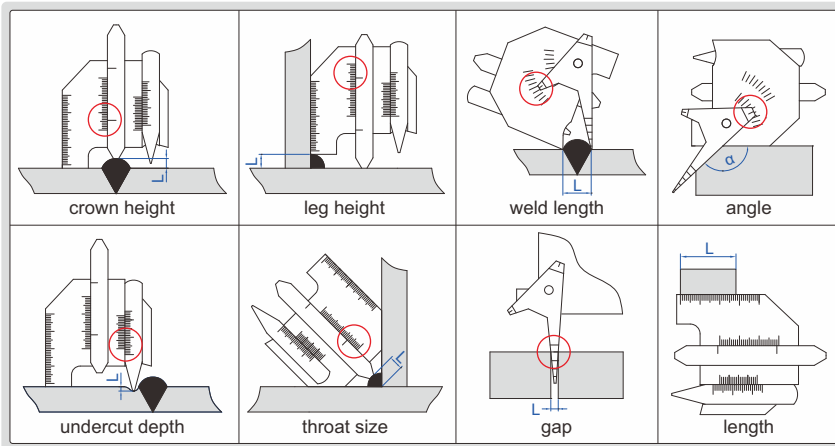

- Made of stainless steel

Measurement	Code 4838-1			Code 4838-2		
	Range	Graduation	Accuracy	Range	Graduation	Accuracy
crown height	0-10mm	1mm	±0.5mm	0-15mm	1mm	±0.5mm
leg height	0-14mm	1mm	±0.5mm	0-15mm	1mm	±0.5mm
undercut depth	0-5mm	0.05mm	±0.05mm	0-5mm	0.05mm	±0.05mm
throat size	0-13mm	1mm	±0.5mm	0-13mm	1mm	±0.5mm
weld length	0-40mm	1mm	±1mm	0-60mm	1mm	±1mm
angle	90°-150°	5°	±1°	80°-160°	5°	±1°
gap	0.5-5mm	1mm	±0.5mm	1-6mm	1mm	±0.5mm
length	0-40mm	1mm	±0.5mm	0-50mm	1mm	±0.5mm
LxW	62x77mm			99x84mm		

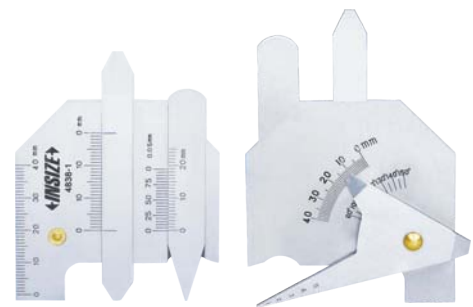

front

4838-1

back

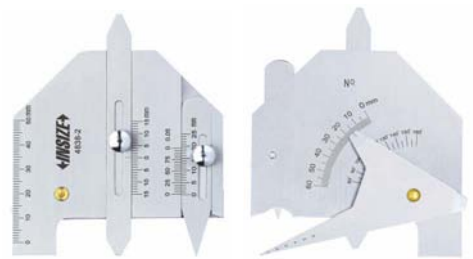

front

4838-2

back

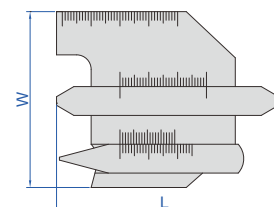



## WELDING GAGE

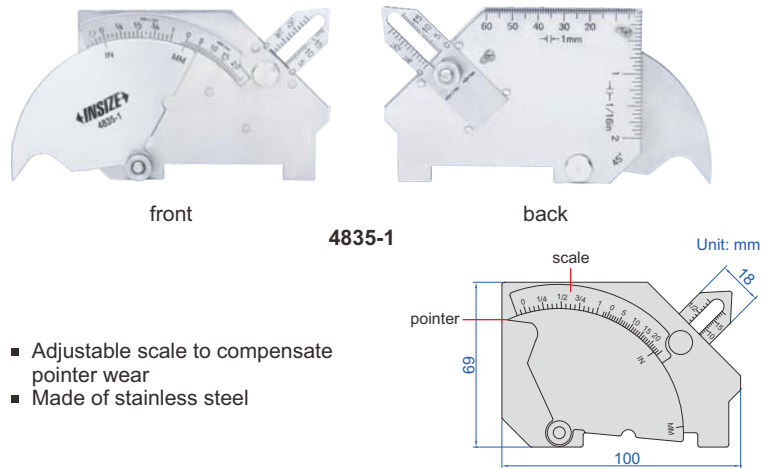
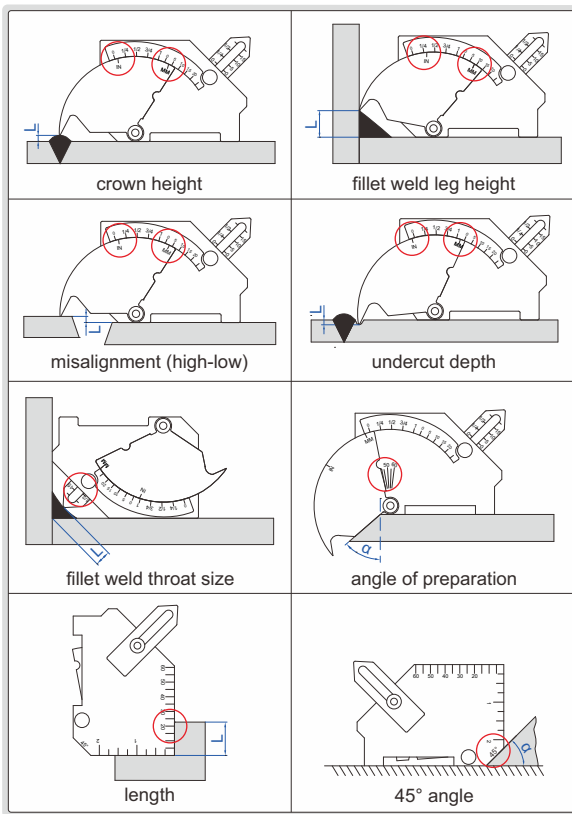

- Adjustable scale to compensate pointer wear
- Made of stainless steel

Code	Measurement	Range	Graduation	Accuracy
4835-1	crown height	0-25mm (0-1")	1mm (1/16")	±0.5mm
	fillet weld leg height	0-25mm (0-1")	1mm (1/16")	±0.5mm
	misalignment (high-low)	0-25mm (0-1")	1mm (1/16")	±0.5mm
	undercut depth	0-2mm (0-1/8")	1mm (1/16")	±0.5mm
	fillet weld throat size	0-20mm (0-3/4")	1mm (1/16")	±0.5mm
	angle of preparation	0-60°	5°	±1°
	length	0-60mm (0-2")	1mm (1/16")	±0.5mm
	45° angle	—	—	±1°

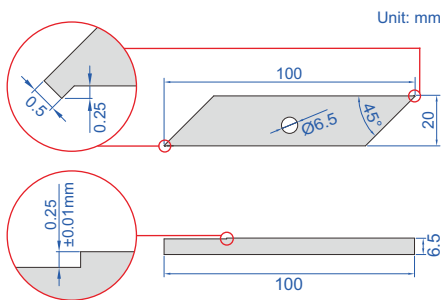

4849-1

calibration block (included)

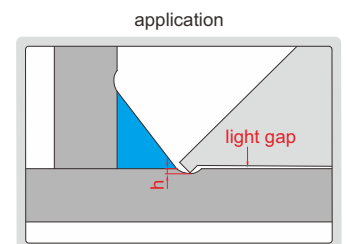

when there is a light gap,  $h < 0.25\text{mm}$ ;  
when there is no light gap,  $h \geq 0.25\text{mm}$

Code  
4849-1

- Measure undercut
- Calibration block is included
- Made of stainless steel

## WELDING GAGE

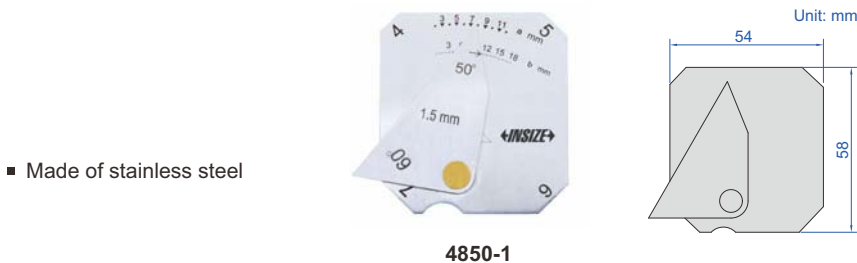

- Made of stainless steel

4850-1

Code	Measurement	Range	Graduation	Accuracy
4850-1	leg height (b)	0-18mm	1mm	±0.5mm
	theoretical throat size (a)	2-12mm	1mm	±0.5mm
	throat size	4, 5, 6, 7mm	—	±0.5mm
	angle of preparation	50°, 60°	—	±1°
	thickness	1.5, 2, 3.5mm	—	±0.2mm

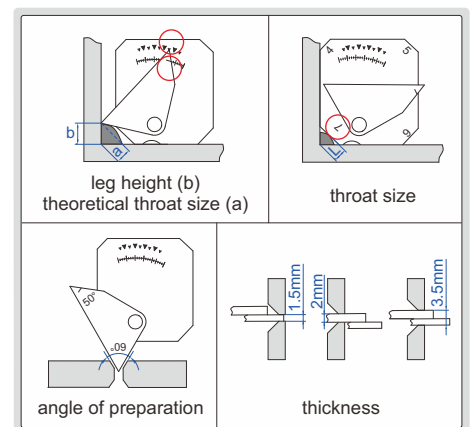

## FILLET WELDING GAGE

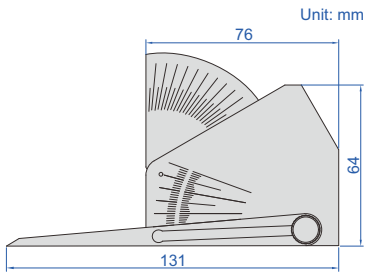

4846-1

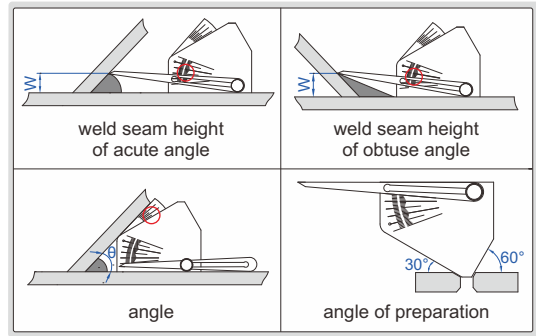

calculating card (included)

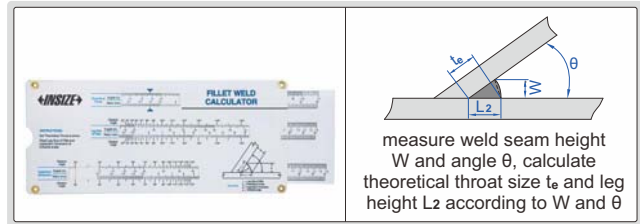

- Calculating card is included
- Made of stainless steel

Code	Measurement	Range	Graduation	Accuracy
4846-1	weld seam height W	0-50mm/0-2"	2mm/0.05"	±1mm
	angle $\theta$	30°-90°	2.5°	±1°
	60° angle	—	—	±0.5°

## WELDING GAGE



4851-1

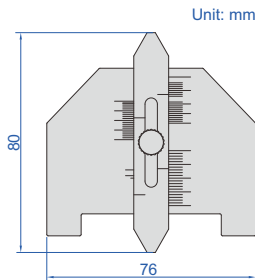

- Made of stainless steel

Code	Measurement	Range	Graduation	Accuracy
4851-1	leg height	0-20mm	1mm	±0.5mm
	crown height	0-3mm	—	±0.5mm
	theoretical leg height of convex weld	0-20mm	1mm	±0.5mm
	theoretical leg height of concave weld	0-20mm	1mm	±0.5mm

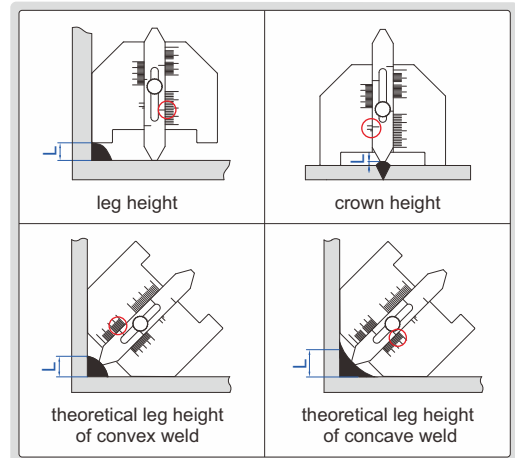

## WELDING GAGE

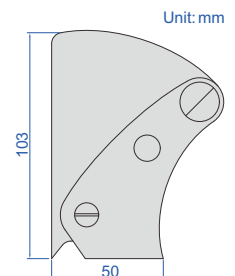
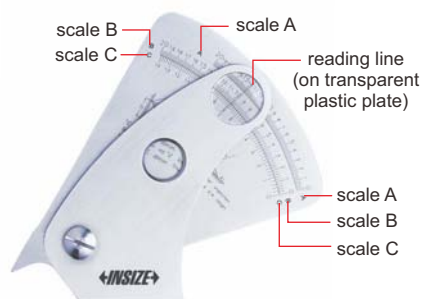
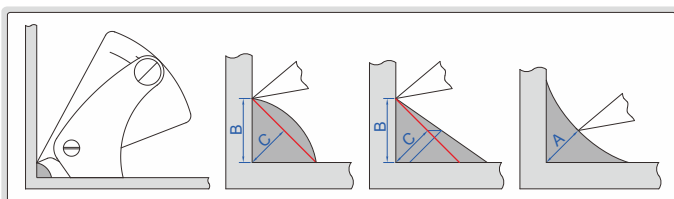

4840-1

Code	Graduation	Accuracy
4840-1	0.2mm	±0.3mm

- Made of stainless steel

## PIPE WELDING GAGE

- Made of stainless steel

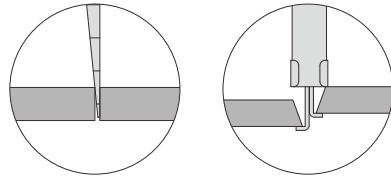

fit-up gap

internal misalignment



4841-1

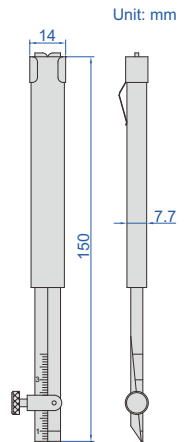

Code	Measurement	Range	Graduation	Accuracy
4841-1	internal misalignment	0-30mm	1mm	±0.5mm
	fit-up gap	0.7-4mm	0.1mm	±0.1mm

## PIPE WELDING GAGE

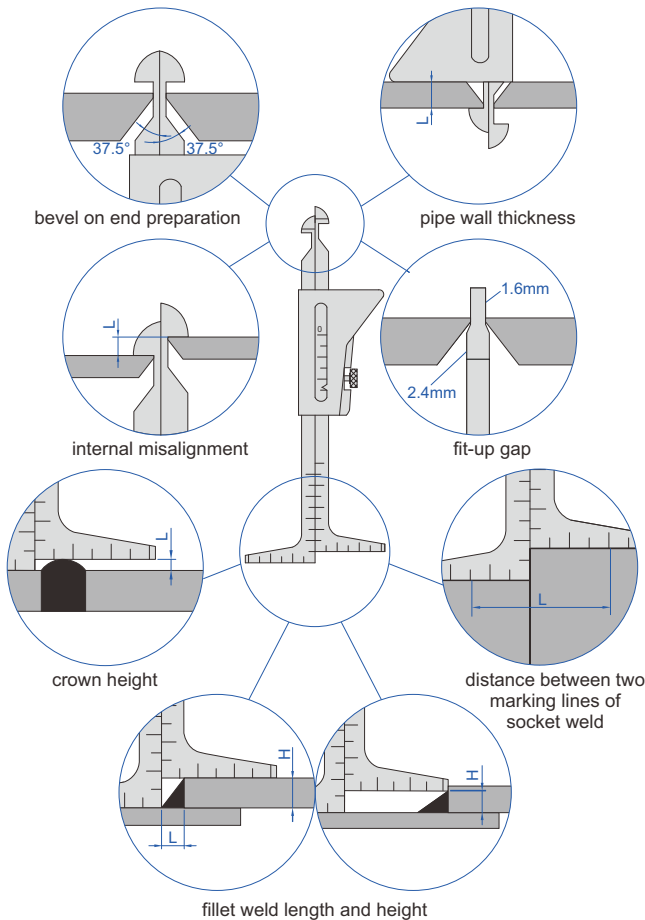

Unit: mm

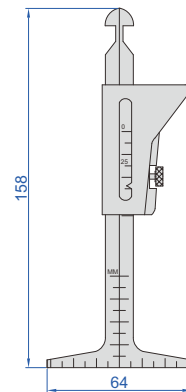

front

back

4839-1

Code	Measurement	Range	Graduation	Accuracy
4839-1	bevel on end preparation	37.5°	—	±1°
	pipe wall thickness	0-45mm (0~1-3/4")	1mm (1/16")	±0.5mm
	internal misalignment	0-35mm (0~1-3/8")	1mm (1/32")	±0.5mm
	fit-up gap	1.6mm, 2.4mm	—	±0.1mm
	crown height	0-35mm (0~1-3/8")	1mm (1/32")	±0.5mm
	distance between two marking lines of socket weld	0-60mm (0~2-3/8")	1mm (1/16")	±0.5mm
	fillet weld length	0-30mm (0~1-1/4")	1mm (1/16")	±0.5mm
	fillet weld height	0-35mm (0~1-3/8")	1mm (1/32")	±0.5mm

- Made of stainless steel

## 6-PIECE WELDING GAGE SET

■ Includes:

- 1) Welding gage (code **4834-1**)
- 2) Fillet welding gage, size 3~25mm, 7 blades (code **4836-1**)
- 3) Pipe welding gage (code **4841-1**)
- 4) Telescoping inspection mirror, size of mirror  $\varnothing 32\text{mm}$ , length 178~505mm (code **7160-1**)
- 5) Pocket rule with sliding clip, range 150mm/6", graduation 1mm, 1/64" (code **7119-150**)
- 6) LED flashlight (code **ISGF-0501**)

Code

5064



5064

## 7-PIECE WELDING GAGE SET

■ Includes:

- 1) Welding gage (code **4834-1**)
- 2) Welding gage (code **4851-1**)
- 3) Pipe welding gage (code **4839-1**)
- 4) Outside micrometer, range 0-25mm, graduation 0.01mm (code **3203-25A**)
- 5) Telescoping inspection mirror, size of mirror  $\varnothing 32\text{mm}$ , length 178~505mm (code **7160-1**)
- 6) Magnifier with illumination, magnification 4X (code **7513-4**)
- 7) Steel rule, range 150mm/6", graduation 0.5mm, 1mm, 1/64", 1/32", 1/16" (code **7110-150**)

Code

5071



5071

## 7-PIECE WELDING GAGE SET

■ Includes:

- 1) Welding gage (code **4834-1**)
- 2) Welding gage (code **4851-1**)
- 3) Fillet welding gage, size 3~25mm, 7 blades (code **4836-1**)
- 4) Outside micrometer, range 0-25mm, graduation 0.01mm (code **3203-25A**)
- 5) Digital caliper, range 0-150mm/0-6", resolution 0.01mm/0.005" (code **1108-150**)
- 6) Pocket rule with sliding clip, range 150mm/6", graduation 1mm, 1/64" (code **7119-150**)
- 7) Magnifier with illumination, magnification 4X (code **7513-4**)

Code

5072



5072

## INSIDE CALIPERS

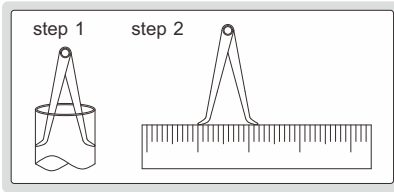

- Made of carbon steel

Code	Size (L)	Range (W)	h
7240-150	150mm	17-150mm	2mm
7240-200	200mm	17-200mm	3mm
7240-300	300mm	18-300mm	3mm

7240-150

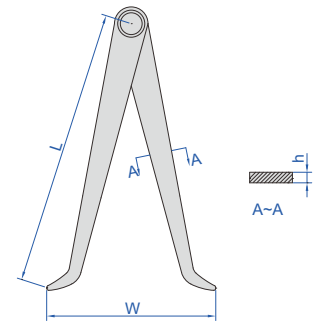

## OUTSIDE CALIPERS

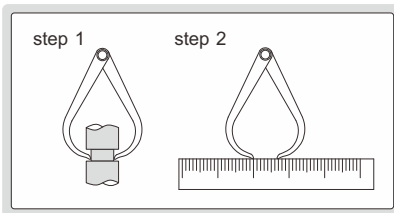

- Made of carbon steel

Code	Size (L)	Range (W)	h
7241-150	150mm	0-150mm	2mm
7241-200	200mm	0-200mm	3mm
7241-300	300mm	0-300mm	3mm

7241-150

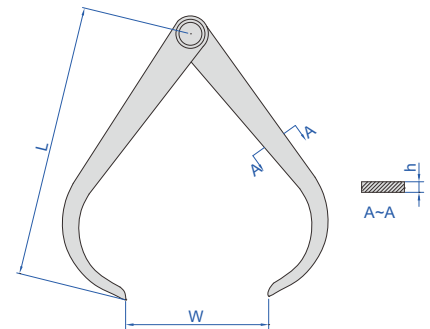

## INSIDE SPRING CALIPERS

- Made of carbon steel



7261-150

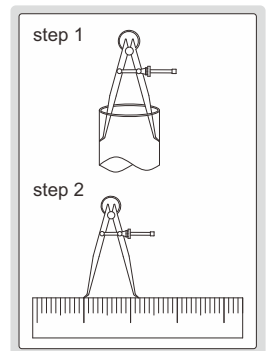
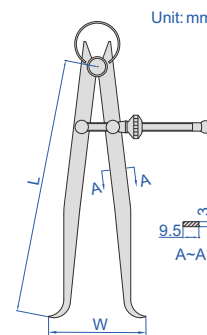

Code	Size (L)	Range (W)
7261-150	150mm	20-170mm
7261-200	200mm	22-220mm
7261-250	245mm	30-270mm
7261-300	300mm	30-320mm

## OUTSIDE SPRING CALIPERS

- Made of carbon steel



7262-150

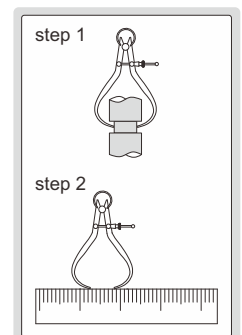
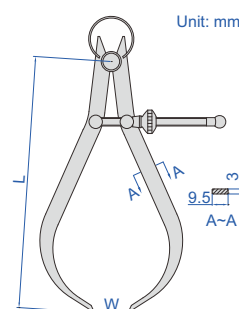

Code	Size (L)	Range (W)
7262-150	155mm	0-140mm
7262-200	210mm	0-210mm
7262-250	265mm	0-270mm
7262-300	310mm	0-320mm

## SPRING DIVIDERS

- Made of carbon steel
- Hardened points

Code	Size (L)	Range (W)
7260-150	150mm	0-150mm
7260-200	200mm	0-210mm
7260-250	245mm	0-260mm
7260-300	300mm	0-320mm



7260-150

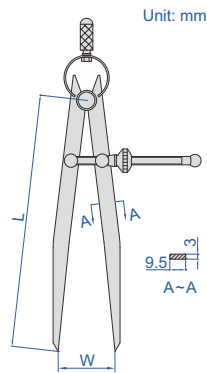

Unit: mm

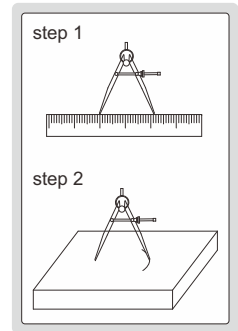

## DIVIDERS

- Made of carbon steel
- Hardened points

Code	Size (L)	Range (W)	(mm)	
			a	b
7247-150	150mm	0-140mm	8.5	7
7247-200	200mm	0-190mm	10	7
7247-300	300mm	0-290mm	12	7



7247-150

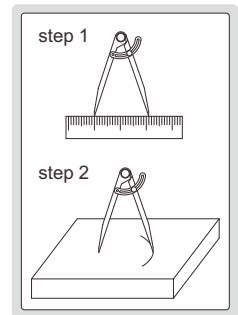
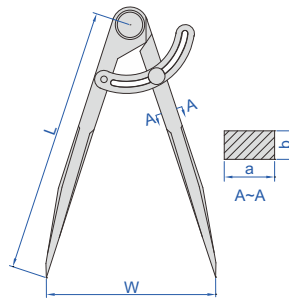

## LENGTH TAPES

**INSIZE PLUS**  
MADE IN EUROPE

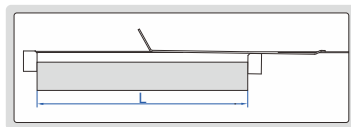

- Measure the distance between two parallel surfaces
- Laser engraved scale
- Made of stainless steel



7141-2200

Code	Range (L)	Graduation	Accuracy
7141-950	60-950mm	0.1mm	±0.15mm
7141-2200	900-2200mm	0.1mm	±0.20mm
7141-3460	2190-3460mm	0.1mm	±0.20mm
7141-4780	3400-4780mm	0.1mm	±0.25mm
7141-6000	4700-6000mm	0.1mm	±0.30mm

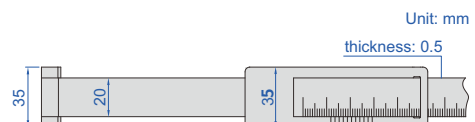

Unit: mm

thickness: 0.5



## WIRELESS DIGITAL MEASURING TAPES + LASER DISTANCE METERS

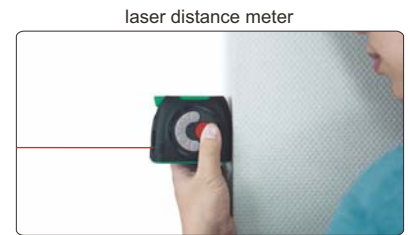
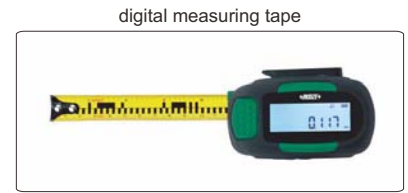

- Built-in bluetooth or wireless Zigbee transmission
- Display with backlight
- Automatic power off: laser 30s, main unit 180s
- Can work continuously for 5 hours
- Can store 50 groups of measurement data

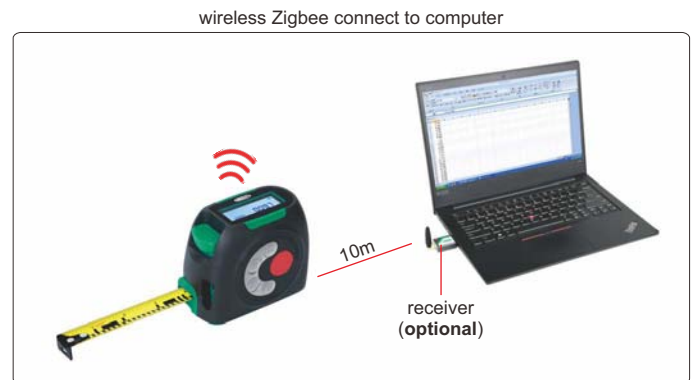

### SPECIFICATION

Code	9563-C40	9563-C60	9563-WL40	9563-WL60	
Output	bluetooth (data can be transmitted to APP)		wireless Zigbee (optional receiver required: code 7315-2/3/6/7/8/9) (data can be transmitted to excel, word, txt etc.)		
Digital measuring tape	range	5m			
	resolution	0.001m			
	accuracy	±1.5mm			
	blade width	19mm			
	horizontal stand-out	≥1.8m			
Laser distance meter	range	40m	60m	40m	60m
	resolution	0.001m			
	accuracy	±(3+D/20)mm, D: measured distance, unit: m			
	units	m, ft, in, ft+in			
	measurement function	single, continuous, area, volume, pythagoras measurement			
Operation temperature	0~40°C				
Storage temperature	-10~60°C				
Power supply	built-in rechargeable lithium battery				
Dimension (L×W×H)	95×74×56mm				
Weight	313g				

## MEASURING TAPES

EG II

graduation

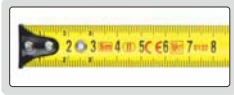

7140-5

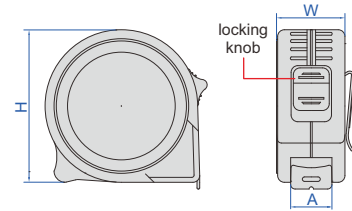

- Non-glare nylon surface for wear resistance
- Accuracy:  $\pm(0.3+0.2L)\text{mm}$  (L is the measured length rounded up to the next whole meter), meet MI-008 of DIRECTIVE 2014/32/EU

### Individual (1 pc per package)

Code	Range	Graduation	Width of tape A	W	H
7140-3	0-3m	1mm	16mm	28mm	62mm
7140-5	0-5m	1mm	19mm	30mm	68mm
7140-8	0-8m	1mm	25mm	38mm	78mm

### Set (12 pcs per package)

Code	Range	Graduation	Width of tape A	W	H
7140-3A	0-3m	1mm	16mm	28mm	62mm
7140-5A	0-5m	1mm	19mm	30mm	68mm
7140-8A	0-8m	1mm	25mm	38mm	78mm

## MEASURING TAPES (BASIC TYPE)

EG II

- Non-glare nylon coating tape, wear resistance
- Accuracy:  $\pm(0.3+0.2L)\text{mm}$  (L is the measured length rounded up to the next whole meter), meet MI-008 of DIRECTIVE 2014/32/EU



7142-5

graduation

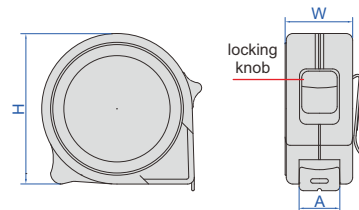
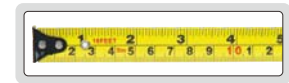

### Individual (1 pc per package)

Code	Range	Graduation	Width of tape A	W	H
7142-5	0-5m/0-16ft	1mm, 1/16"	19mm	31mm	64mm

### Set (12 pcs per package)

Code	Range	Graduation	Width of tape A	W	H
7142-5A	0-5m/0-16ft	1mm, 1/16"	19mm	31mm	64mm

## SELF ADHESIVE MEASURING TAPES

type of reading

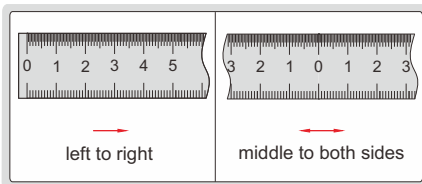

7139-50

self adhesive back



- Self adhesive back
- Steel tape, non-glare coating, wear resistance

Code	Range (L)	Graduation	Accuracy	Type of reading
7139-50	50-0-50cm	1mm	$\pm 0.2\text{mm}$	middle to both sides
7139-100	0-100cm	1mm	$\pm 0.4\text{mm}$	left to right

Unit: mm

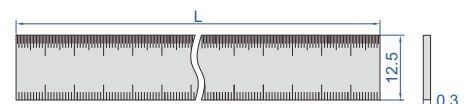



**LONG MEASURING TAPE**

graduation

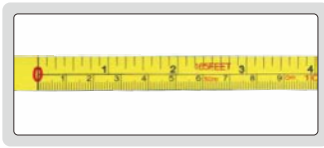

- High tensile strength fibreglass tape
- Nylon coating tape, wear resistance
- Accuracy:  $\pm(0.3+0.2L)$ mm (L is the measured length rounded up to the next whole meter), meet MI-008 of DIRECTIVE 2014/32/EU

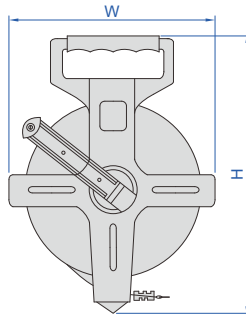

**EG II**

**7143-50**

Code	Range	Graduation	Width of tape	W	H
7143-50	0-50m/0-165ft	1mm, 1/8"	13mm	220mm	320mm

**MEASURING WHEEL (BASIC TYPE)**

- ABS plastic frame, wear-resistant PU tire
- Three-section adjustable handle

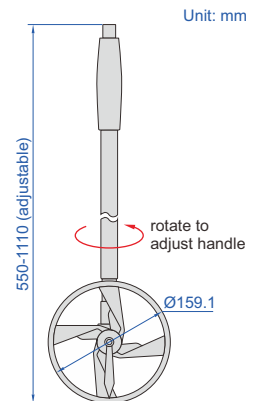
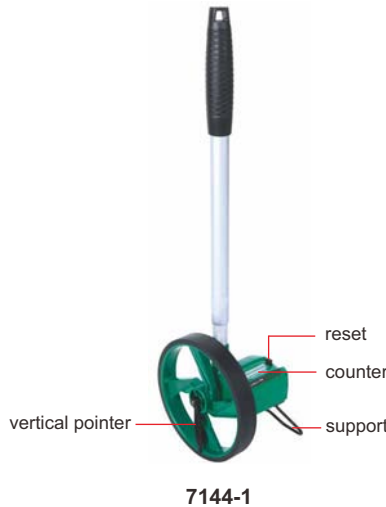

Code	Range	Resolution
7144-1	0.1-9999.9m	0.1m

**7144-1**

**MEASURING WHEEL**

- ABS plastic frame, wear-resistant PU tire
- Two-section foldable handle



after folding



backpack (included)

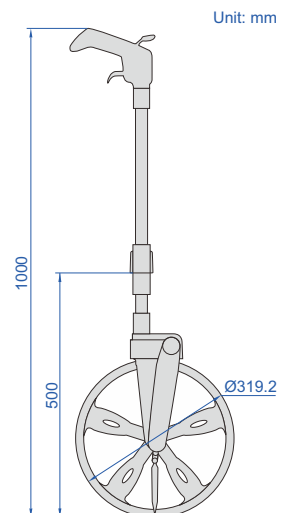

Code	Range	Resolution
7145-1	0.1-9999.9m	0.1m

**7145-1**

## DIGITAL MEASURING WHEEL

**IP40**  
WATERPROOF

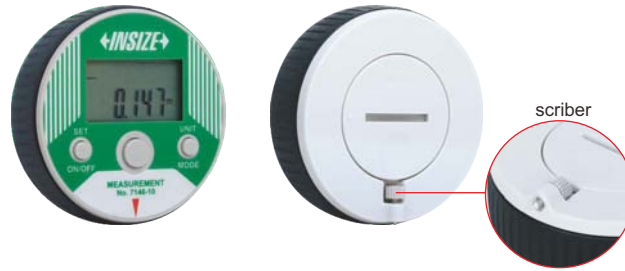

7146-10

- IP40 dust/waterproof
- Measuring length of curve
- Four measurement modes: length, rectangle area, diameter of circle, cube
- Resolution: 0.001m/0.01ft
- Button function: on/off, mm/inch, one or two sides set, measurement mode conversion, measurement
- Battery CR2032, automatic power off

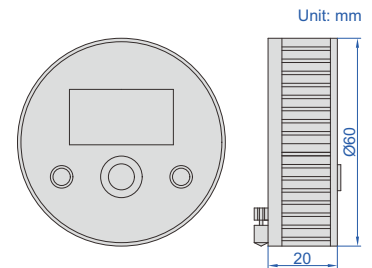

Code	Range	Accuracy
7146-10	0-10m/0-32.8ft	±0.3%L (L is the measured length)

## RIGID RULES



- Rigid rules
- Graduation on front and back sides
- Made of special steel
- Satin chrome plated

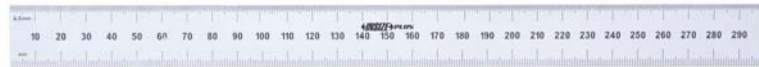

7122-300

Code	Range (L)	Graduation	Accuracy	W	T
7122-150	150mm	0.5mm/1mm	+0.10/-0.09mm	18.50mm	1mm
7122-300	300mm	0.5mm/1mm	+0.13/-0.09mm	24.50mm	1mm
7122-600	600mm	0.5mm/1mm	+0.18/-0.09mm	29.50mm	1mm

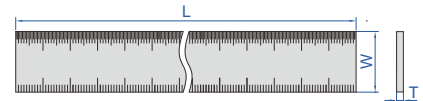

## RIGID RULE



7113-300A



groove on the back

- Rigid rules
- With groove on the back, suitable for combination square set (2278 series)
- Satin chrome plated

Code	Range	Graduation		Accuracy	L
		front	back		
7113-300A	300mm/12"	0.5mm and 1/32"	1mm and 1/64"	±0.15mm	300mm



## FLEXIBLE RULES

**INSIZE PLUS**  
MADE IN USA



7121-150

- Can be used in the way of bending
- Graduation on front and back sides
- Made of special steel
- Satin chrome plated

Code	Range (L)	Graduation	Accuracy	W	T
7121-150	150mm	0.5mm/1mm	+0.10/-0.09mm	12.50mm	0.40mm
7121-300	300mm	0.5mm/1mm	+0.13/-0.09mm	12.50mm	0.40mm
7121-600	600mm	0.5mm/1mm	+0.18/-0.09mm	19.50mm	0.50mm

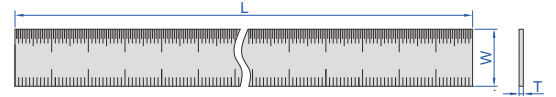

can be used in the way of bending



## POCKET RULE WITH SLIDING CLIP

- With sliding clip, clip can be inserted in the pocket, also can be used as depth gage base
- Inch/metric conversion table on the back
- Made of stainless steel



7119-150

Code	Range	Graduation	Accuracy
7119-150	150mm/6"	1mm, 1/64"	±0.3mm

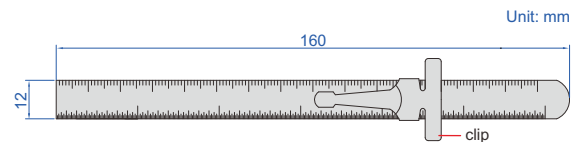

Unit: mm

## TAPER GAGE AND STEEL RULER SET



front

4829-1

back

use the taper gage to measure slot width

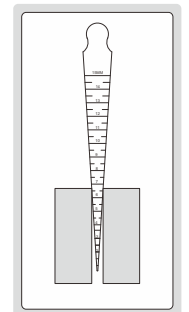

- Diameter correction table on the taper gage back
- Made of stainless steel

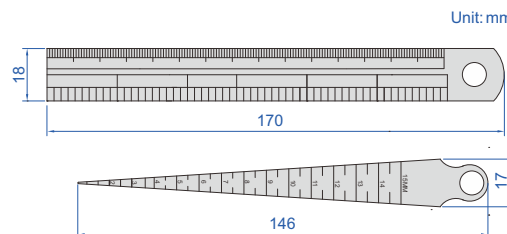

Unit: mm

use the taper gage to measure diameter of hole

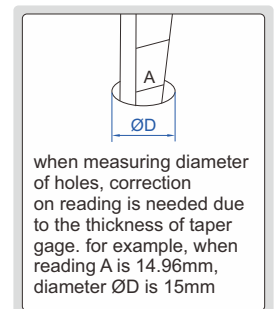

when measuring diameter of holes, correction on reading is needed due to the thickness of taper gage. for example, when reading A is 14.96mm, diameter ØD is 15mm

Code	Tool	Range	Graduation	Accuracy
4829-1	taper gage	0.8-15mm	0.1mm	±0.05mm
	steel ruler	150mm/6"	1.0mm	±0.18mm

## STEEL RULES

POPULAR MODEL



7110-300

- Graduation: 0.5mm, 1mm, 1/64", 1/32", 1/16"
- Rigid rules
- Made of stainless steel
- Non-glare surface

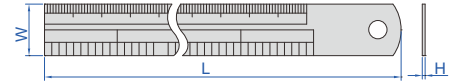

Individual (1 pc per package)

(mm)

Code	Range	Accuracy	L	W	H	Remark
7110-150	150mm/6"	±0.18mm	170	18	1.0	graduation on front and back
7110-200	200mm/8"	±0.18mm	220	18	1.0	graduation on front and back
7110-300	300mm/12"	±0.27mm	330	25	1.0	graduation on front and back
7110-3001	300mm/12"	±0.27mm	325	30	1.0	graduation on front and back
7110-500	500mm/20"	±0.40mm	530	30	1.2	graduation on front and back
7110-600	600mm/24"	±0.50mm	630	30	1.2	graduation on front and back
7110-1000	1000mm/40"	±0.50mm	1040	32	1.5	graduation on front and back
7110-1200	1200mm/48"	±0.80mm	1240	35	1.8	graduation on front
7110-1500	1500mm/60"	±1.00mm	1550	38	1.8	graduation on front
7110-2000	2000mm/80"	±1.00mm	2065	40	2.0	graduation on front

Set

(mm)

Code	Range	Accuracy	L	W	H	Remark	Quantity per package
7110-150A	150mm/6"	±0.18mm	170	18	1.0	graduation on front and back	10 pcs
7110-200A	200mm/8"	±0.18mm	220	18	1.0	graduation on front and back	10 pcs
7110-300A	300mm/12"	±0.27mm	330	25	1.0	graduation on front and back	5 pcs
7110-3001A	300mm/12"	±0.27mm	325	30	1.0	graduation on front and back	5 pcs
7110-500A	500mm/20"	±0.40mm	530	30	1.2	graduation on front and back	5 pcs
7110-600A	600mm/24"	±0.50mm	630	30	1.2	graduation on front and back	5 pcs
7110-1000A	1000mm/40"	±0.50mm	1040	32	1.5	graduation on front and back	5 pcs
7110-1200A	1200mm/48"	±0.80mm	1240	35	1.8	graduation on front	5 pcs
7110-1500A	1500mm/60"	±1.00mm	1550	38	1.8	graduation on front	5 pcs
7110-2000A	2000mm/80"	±1.00mm	2065	40	2.0	graduation on front	5 pcs

## ALUMINUM RULES

- Made of aluminum, oxidized surface

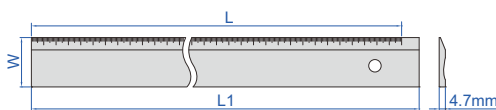

7123-300

Code	Range (L)	Graduation	Accuracy	L1	W
7123-300	300mm	1mm	±0.5mm	321mm	50mm
7123-600	600mm	1mm	±0.9mm	624mm	50mm
7123-1000	1000mm	1mm	±0.9mm	1024mm	50mm

## COMBINATION SQUARE (ECONOMIC TYPE)

- Square head (made of zinc): set the blade at 90° or 45° to an edge of a workpiece accuracy:  $\pm 0.5^\circ$
- Blade (made of stainless steel): range: 300mm/12", graduation: 1mm and 1/32" on front face, 1mm and 1/16" on back face



2276-300

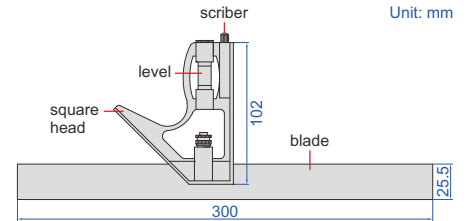
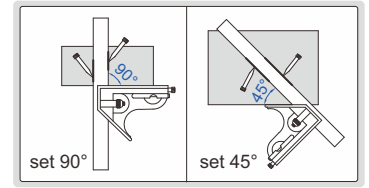

Code
2276-300

## COMBINATION SQUARE SET (OPEN TYPE PROTRACTOR)

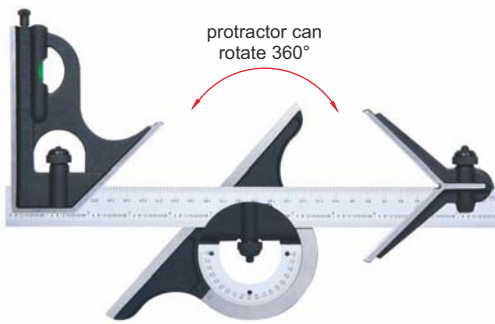

2274-4

protractor can rotate 360°

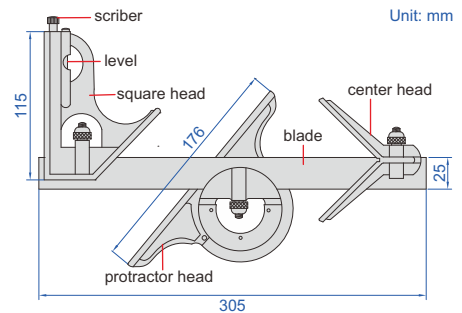

- Center head (made of cast iron): to locate center of cylinders with diameter ( $\varnothing$ ): 30-100mm accuracy:  $\pm 0.15\text{mm}$
- Protractor head (made of cast iron): set the blade at desired angle to an edge of a workpiece, and can be used to measure angles range: 0-180° accuracy:  $\pm 20\text{min}$
- Square head (made of cast iron): set the blade at 90° or 45° to an edge of a workpiece accuracy:  $\pm 8\text{min}$  for 90° square,  $\pm 10\text{min}$  for 45° square
- Blade (made of stainless steel): range: 300mm/12", graduation: 0.5mm and 1/32" on front face, 1mm and 1/64" on back face
- Optional accessory: rigid rule (code 7113)

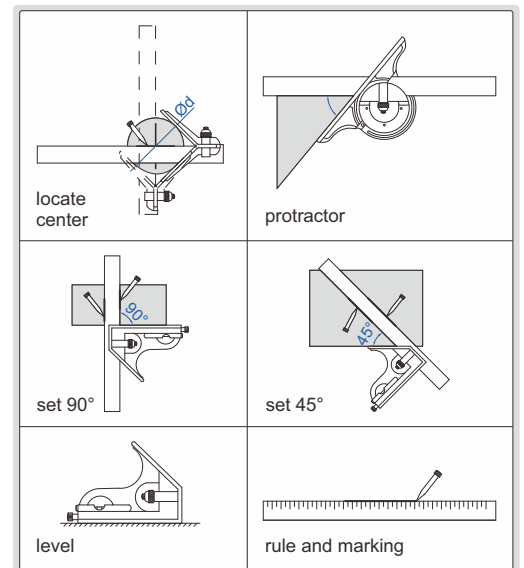

Code	Remark
2274-4	4-piece set

## COMBINATION SQUARE SETS (CLOSE TYPE PROTRACTOR)



2278-2



2278-3

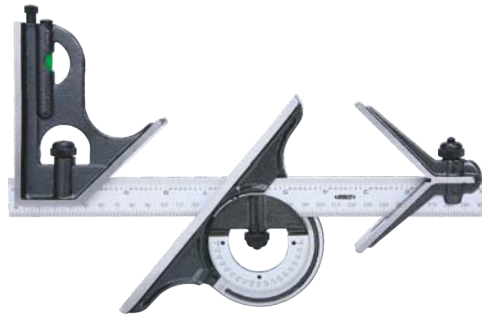

2278-180

- Center head (made of cast iron):  
to locate center of cylinders with diameter ( $\varnothing$ ): 30-100mm  
accuracy:  $\pm 0.15\text{mm}$
- Protractor head (made of cast iron):  
set the blade at desired angle to an edge of a workpiece,  
and can be used to measure angles  
range: 0-180°  
accuracy:  $\pm 20\text{min}$ .
- Square head (made of cast iron):  
set the blade at 90° or 45° to an edge of a workpiece  
accuracy:  $\pm 8\text{min}$  for 90° square,  
 $\pm 10\text{min}$  for 45° square
- Blade (made of stainless steel):  
range: 300mm/12",  
graduation: 0.5mm and 1/32" on front face,  
1mm and 1/64" on back face
- Optional accessory: rigid rule (code 7113)

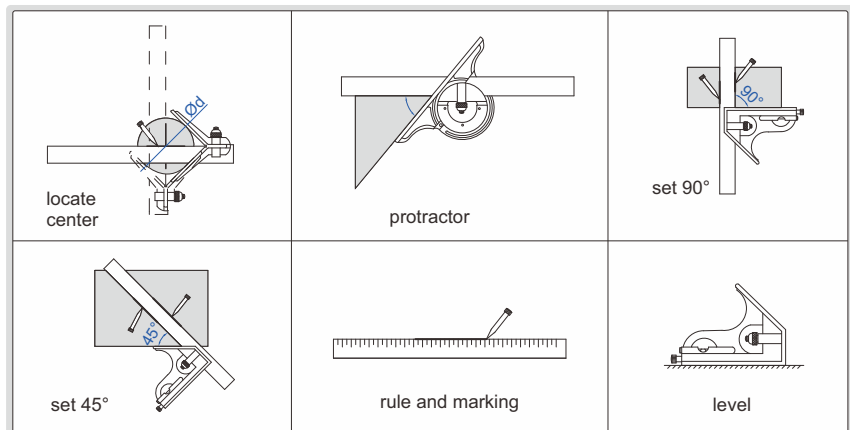
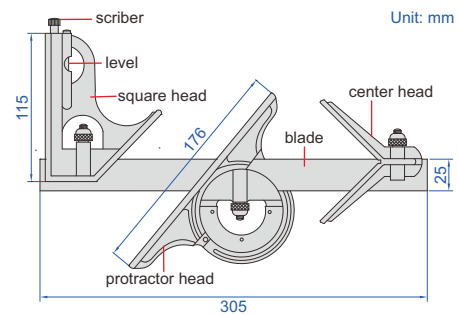

Code	Remark
2278-2	2-piece set
2278-3	3-piece set
2278-180	4-piece set

## PLASTIC ANGLE SQUARE

- Length range: 0-7", graduation: 1/8"
- Angel range: 0-90°, graduation: 1°

Code	Size (L×W)	Accuracy of angle
2282-180	180×185mm	±0.3°



2282-180

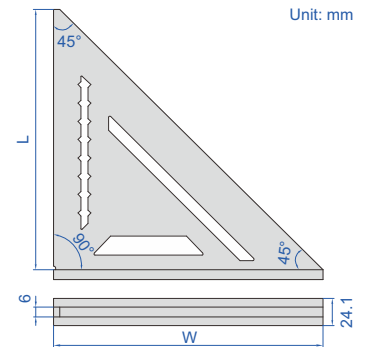

Unit: mm

## T-BEVEL

blade can rotate 360°

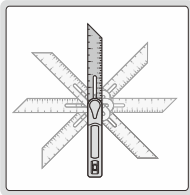

- Easy-to-read vial
- The blade can move and can be locked by the clamping screw
- Stainless steel blade
- Tough rubber handle
- Centimeter/inch graduations

Code	Angle mark	Accuracy of angle
2281-360	15°, 30°, 45°, 60°, 90°	±1°



2281-360

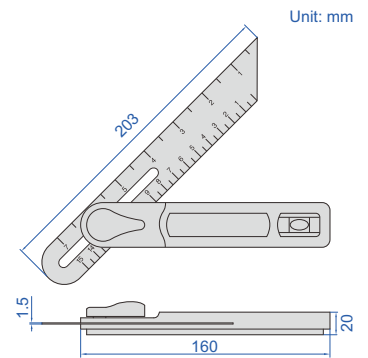

Unit: mm

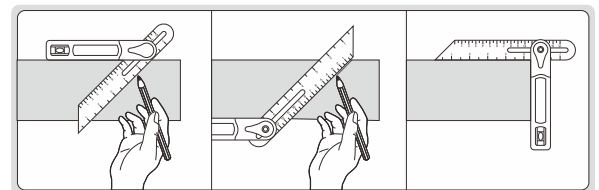

## MARKING GAGES



7120-200A

- Made of carbon steel
- Satin chrome plated

Code	Range	Graduation	Accuracy	L	W
7120-200A	0-200mm	0.1mm	±0.1mm	250mm	40mm
7120-250A	0-250mm	0.1mm	±0.1mm	300mm	40mm
7120-300A	0-300mm	0.1mm	±0.1mm	350mm	40mm

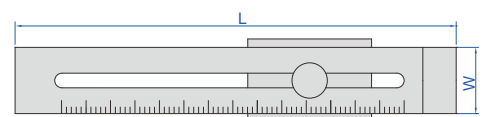
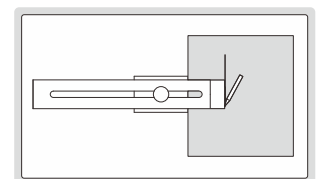

**T-SHAPE MARKING GAGE**

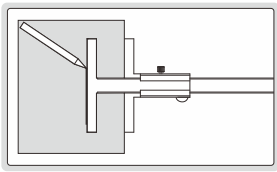

**1275-150B**

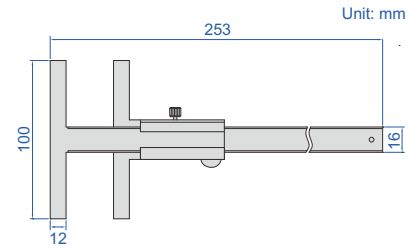

- Made of stainless steel
- Satin chrome plated reading surface

Code	Range	Graduation	Accuracy
1275-150B	0-150mm	0.02mm	±0.04mm

**CENTER MARKING GAGES**

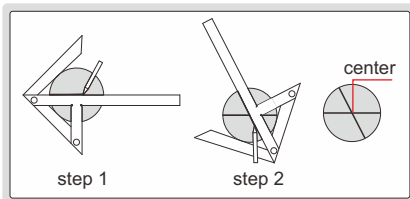

**7205-100**

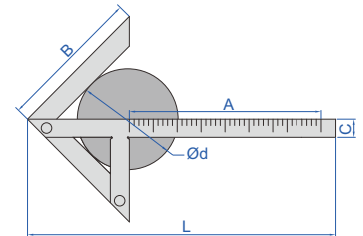

Code	Size (AxB)	Diameter of shafts (Ød)	Accuracy	C	L
7205-100	100x70mm	4-90mm	±0.15mm	12mm	153mm
7205-150	150x130mm	4-190mm	±0.15mm	15mm	245mm
7205-200	200x150mm	6-220mm	±0.15mm	15mm	310mm
7205-300	300x180mm	6-270mm	±0.15mm	20mm	435mm

- Marking the center of round plates and shafts
- Made of stainless steel
- Satin chrome plated

**LOCATOR**

**INSIZE PLUS**  
MADE IN USA



**2849-90**

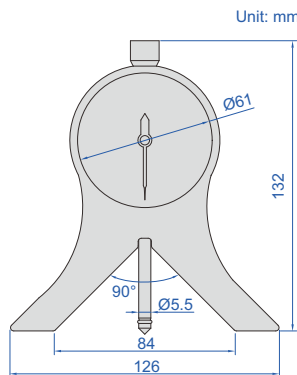

mark the center position

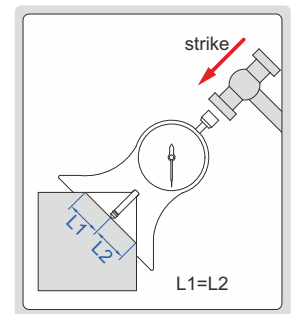

mark the angle on cylindrical workpieces

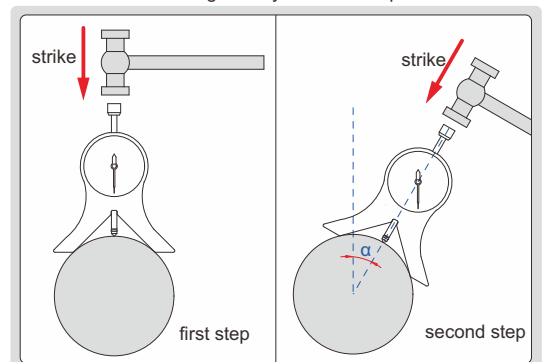

- Mark the position when drilling, milling or welding, suitable for cylindrical and rectangular workpieces
- The punch hardness is HRC59-63
- Optional accessory: punch (code 2849-P1)

Code	Range	Graduation	Accuracy	Dial reading
2849-90	4x90°	1°	±1°	0-90-0-90-0



## SCRIBING CALIPER

- Made of stainless steel
- Satin chrome plated reading surface
- Carbide scriber tip
- Optional accessory: carbide scriber tip (code **SP-SCRIBER-7202**)

the position of scriber tip can be adjusted

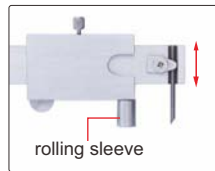

7202-200A

Code	Range	Graduation	Accuracy
7202-200A	0-200mm/0-8"	0.1mm, 1/128"	±0.1mm

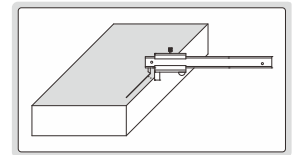
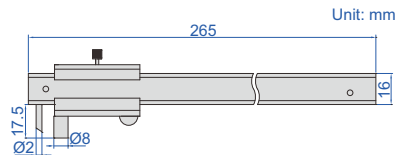

## DIGITAL SCRIBING CALIPERS

- Non waterproof
- The carbide-tipped jaws facilitate scribing on workpieces
- Resolution: 0.01mm/0.0005"
- Buttons: on/off, zero, mm/inch
- Automatic power off, move the digital unit to turn on power
- Battery CR2032
- Made of stainless steel

With data interface (data output cable code 7315-21 need receiver page 4, 7302-21 page 12, optional)

Code	Range	Accuracy
1166-150A	0-150mm/0-6"	±0.03mm

Built-in wireless (receiver code 7315-2/3/6/7/8/9 is required)

Code	Range	Accuracy
1166-150AWL	0-150mm/0-6"	±0.03mm

DATA OUTPUT



1166-150A

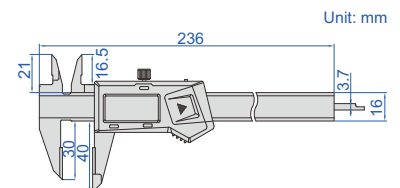
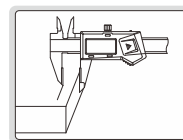

## SCRIBING CALIPER

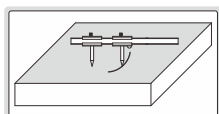

- Made of stainless steel
- Satin chrome plated reading surface
- Hardened scriber tips

Code	Range	Graduation	Accuracy
7203-300A	51-300mm	0.1mm	±0.1mm



7203-300A

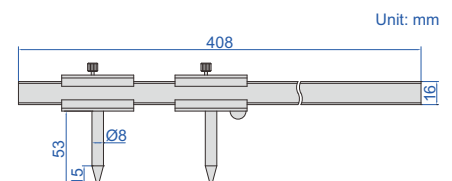

## HEIGHT SCRIBER

- Grooved bottom for cylinders
- Two pins to be set against the edge of surface plate

**Code**  
6990-300A

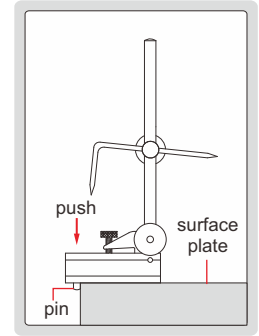
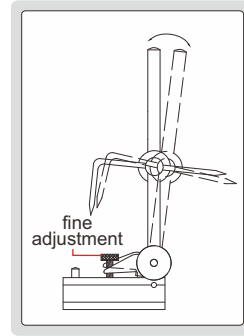
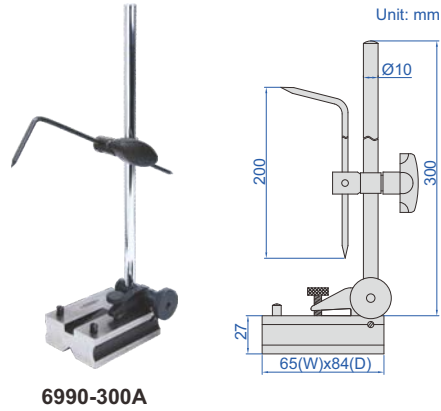

## SCRIBERS

- 7230 and 7231 are nickel plated, 7232 is zinc-plated

Code	Tip
7230	hardened tips
7231	hardened tip
7232	carbide tip

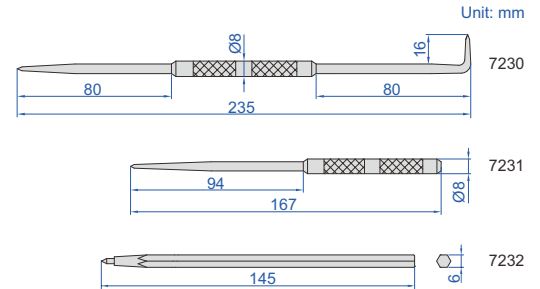

## PRECISION SCREWDRIVER SET CODE ISGF-0901

- Includes:
  - 4 pcs "-": 1.4mm, 2.0mm, 2.4mm, 3.0mm
  - 2 pcs "+": 0#, 1#
- Rotating cap
- Material: CRV, hardness: HRC52~56



ISGF-0901



## LED FLASHLIGHT CODE ISGF-0501

- Toshiba high performance LED
- Powered by 3x AAA batteries (batteries are not included)
- Max output: 120 lumens
- Battery life: 4 hours
- Beam distance: 70 meters
- IP54 dust/waterproof



ISGF-0501



## MEASURING TOOLS REPAIR TOOL SET

- For repairing of calipers, micrometers and indicators
- Including:
  - 1) Slotted screwdriver, 1.4×20mm
  - 2) Slotted screwdriver, 2.0×20mm
  - 3) Slotted screwdriver, 2.4×25mm
  - 4) Slotted screwdriver, 3.0×25mm
  - 5) Cross screwdriver, 0#×25mm
  - 6) Cross screwdriver, 1#×25mm
  - 7) Magnetizer and demagnetizer
  - 8) Pointed tweezers, 125mm
  - 9) Mini needle-nose pliers, 5"
  - 10) Extended flat head allen wrench, 1.5×80mm
  - 11) Extended flat head allen wrench, 2.5×94mm
  - 12) Extended flat head allen wrench, 3×92mm
  - 13) Needle puller, 3 pcs
  - 14) Copper hammer, 126g
  - 15) Copper rod, Ø10×60mm
  - 16) Dial face suction cup, Ø30mm
  - 17) Oil stone, 100×20×10mm
  - 18) Cleaning brush
  - 19) Micrometer wrench
  - 20) Three point inside micrometer rod wrench, 2 pcs
  - 21) Anti rust oil, 30ml
  - 22) Special anti rust oil for micrometers, 30ml
  - 23) Dust free cloth, 5 pcs



7338-1

### Code

7338-1

## 2-PIECE MEASURING TOOL SETS

- Includes:
  - 1) Vernier caliper, range 0-150mm/0-6", graduation 0.05mm/1/128" (code 1205-150S) for 5021, graduation 0.02mm/0.001" (code 1205-1502S) for 5021-2
  - 2) Outside micrometer, range 0-25mm, graduation 0.01mm (code 3202-25A)

Code	Remark
5021	vernier caliper, graduation 0.05mm/1/128" (code 1205-150S)
5021-2	vernier caliper, graduation 0.02mm/0.001" (code 1205-1502S)



5021

## 2-PIECE MEASURING TOOL SET

- Includes:
  - 1) Digital caliper, range 0-150mm/0-6", resolution 0.01mm/0.0005" (code 1108-150)
  - 2) Digital outside micrometer, range 0-25mm/0-1", resolution 0.001mm/0.00005" (code 3109-25A)

### Code

5022



5022

## 2-PIECE MEASURING TOOL SET

Includes:

- 1) Dial test indicator, range 0.8mm, graduation 0.01mm (code **2380-08**)
- 2) Magnetic stand

Code

5023



5023

## 2-PIECE MEASURING TOOL SET

Includes:

- 1) Dial indicator, range 10mm, graduation 0.01mm (code **2308-10A**)
- 2) Magnetic stand (code **6201-60**)

Code

5024



5024

## 3-PIECE MEASURING TOOL SET

Includes:

- 1) Digital indicator, range 12.7mm/0.5", resolution 0.01mm/0.0005" (code **2112-10**)
- 2) Flex arm
- 3) Locking pliers, adjustable jaw opening from 0 to 25mm



Code

5031



5031

## 3-PIECE MEASURING TOOL SET

Includes:

- 1) Vernier caliper, range 0-150mm graduation 0.02mm (code **1205-1501S**)
- 2) Outside micrometer, range 0-25mm, graduation 0.01mm (code **3203-25A**)
- 3) Steel rule, range 150mm/6", graduation 0.5mm, 1mm, 1/64", 1/32", 1/16" (code **7110-150**)
- 4) Dust free gloves and dust free cloth

dust free gloves and  
dust free cloth



Code

5032



5032

## 4-PIECE MEASURING TOOL SETS



5041

- Includes:
  - 1) Vernier caliper, range 0-150mm/0-6", graduation 0.05mm/1/128" (code **1205-150S**) for **5041**, graduation 0.02mm/0.001" (code **1205-1502S**) for **5041-2**
  - 2) Outside micrometer, range 0-25mm, graduation 0.01mm (code **3202-25A**)
  - 3) 90° beveled edge square, 100x70mm, grade 0 (code **4790-1000**)
  - 4) Steel rule, 150mm/6" (code **7110-150**)

Code	Remark
<b>5041</b>	vernier caliper, graduation 0.05mm/1/128" (code <b>1205-150S</b> )
<b>5041-2</b>	vernier caliper, graduation 0.02mm/0.001" (code <b>1205-1502S</b> )

## 4-PIECE MEASURING TOOL SET



5042

- Includes:
  - 1) Digital caliper, range 0-150mm/0-6", resolution 0.01mm/0.0005" (code **1108-150**)
  - 2) Outside micrometer, range 0-25mm, graduation 0.01mm, (code **3202-25A**)
  - 3) 90° beveled edge square, 100x70mm, grade 0 (code **4790-1000**)
  - 4) Steel rule, 150mm/6" (code **7110-150**)

**Code**  
**5042**

## 5-PIECE MEASURING TOOL SET



5051

- Includes:
  - 1) Digital caliper, range 0-150mm/0-6", resolution 0.01mm/0.0005", (code **1108-150**)
  - 2) Outside micrometer, range 0-25mm, graduation 0.01mm (code **3203-25A**)
  - 3) Dial indicator, range 10mm, graduation 0.01mm (code **2308-10A**)
  - 4) Magnetic stand (code **6201-60**)
  - 5) Micrometer stand (code **6300**)

**Code**  
**5051**

## 5-PIECE MEASURING TOOL SET



5052

- Includes:
  - 1) Digital caliper, range 0-150mm/0-6", resolution 0.01mm/0.0005" (code **1108-150**)
  - 2) Digital outside micrometer, range 0-25mm/0-1", resolution 0.001mm/0.00005" (code **3109-25A**)
  - 3) Digital indicator, range 12.7mm/0.5", resolution 0.01mm/0.0005" (code **2112-10**)
  - 4) Magnetic stand (code **6201-60**)
  - 5) Micrometer stand (code **6300**)

**Code**  
**5052**

## 6-PIECE MEASURING TOOL SET

- Includes:
  - 1) Digital caliper, range 0-150mm/0-6", resolution 0.01mm/0.0005" (code **1108-150**)
  - 2) Outside micrometer, range 0-25mm, graduation 0.01mm (code **3202-25A**)
  - 3) Dial indicator, range 10mm, graduation 0.01mm (code **2308-10FA**)
  - 4) 90° beveled edge square, 100x70mm, grade 0 (code **4790-1000**)
  - 5) Scriber (code **7230**)
  - 6) Steel rule, 150mm/6" (code **7110-150**)

Code
5061



5061

## 6-PIECE MEASURING TOOL SET

- Includes:
  - 1) Digital caliper, range 0-150mm/0-6" resolution 0.01mm/0.0005" (code **1108-150**)
  - 2) Outside micrometer, range 0-25mm graduation 0.01mm (code **3202-25A**)
  - 3) 90° beveled edge square, 100x70mm grade 00 (code **4790-0100**)
  - 4) Straight edge, 100mm (code **4700-100**)
  - 5) Spring divider, 150mm (code **7260-150**)
  - 6) Steel rule, 200mm/8" (code **7110-200**)

Code
5062



5062

## 6-PIECE MEASURING TOOL SETS

- Includes:
  - 1) Vernier caliper, range 0-150mm/0-6", graduation 0.05mm/1/128" (code **1205-150S**) for **5063**, graduation 0.02mm/0.001" (code **1205-1502S**) for **5063-2**
  - 2) Outside micrometer, range 0-25mm graduation 0.01mm (code **3202-25A**)
  - 3) 90° beveled edge square, 100x70mm grade 00 (code **4790-0100**)
  - 4) Straight edge, 100mm (code **4700-100**)
  - 5) Spring divider, 150mm (code **7260-150**)
  - 6) Steel rule, 200mm/8" (code **7110-200**)

Code	Remark
5063	vernier caliper, graduation 0.05mm/1/128" (code <b>1205-150S</b> )
5063-2	vernier caliper, graduation 0.02mm/0.001" (code <b>1205-1502S</b> )



5063

## 8-PIECE MEASURING TOOL SET

- Includes:
  - 1) Digital caliper, range 0-150mm/0-6", resolution 0.01mm/0.0005" (code **1108-150**)
  - 2) Digital outside micrometer, range 0-25mm/0-1", graduation 0.001mm/0.00005" (code **3109-25A**)
  - 3) Dial test indicator, range 0.8mm, graduation 0.01mm (code **2380-08**)
  - 4) Magnetic stand (code **6201-60**)
  - 5) Parallel/square set, 75x50x25mm (code **6531-25**)
  - 6) Steel rule, 150mm/6" (code **7110-150**)
  - 7) Depth base attachment (code **6140**)
  - 8) Zero setting bar for depth base attachment

**Code**

**5081**



5081

## 9-PIECE MEASURING TOOL SET

- Includes:
  - 1) Digital caliper, range 0-150mm/0-6", resolution 0.01mm/0.0005" (code **1108-150**)
  - 2) Outside micrometer, range 0-25mm, graduation 0.01mm (code **3202-25A**)
  - 3) Protractor, range 0-180°, graduation 1° (code **4799-180**)
  - 4) Pitch gauge, range 0.25-7mm, 24 pcs, metric 60° thread (code **4820-124**)
  - 5) Radius gauge, range 1-7mm (code **4801-17**)
  - 6) Feeler gauge, range 0.05-1.00mm, 20 pcs (code **4602-20**)
  - 7) 90° beveled edge square, 100x70mm, grade 0 (code **4790-1000**)
  - 8) Scriber (code **7230**)
  - 9) Steel rule, 150mm/6" (code **7110-150**)

**Code**

**5091**



5091

## 13-PIECE MEASURING TOOL SET

- Includes:
  - 1) Digital caliper, range 0-150mm/0-6", resolution 0.01mm/0.0005" (code **1108-150**)
  - 2) Outside micrometer, range 0-25mm, graduation 0.01mm (code **3202-25A**)
  - 3) Dial indicator, range 10mm, graduation 0.01mm (code **2308-10A**)
  - 4) Magnetic stand (code **6201-60**)
  - 5) Protractor, range 0-180°, graduation 1° (code **4799-180**)
  - 6) Pitch gauge, range 0.25-7mm, 24 pcs, metric 60° thread (code **4820-124**)
  - 7) Radius gauge, range 1-7mm (code **4801-17**)
  - 8) Feeler gauge, range 0.05-1.00mm, 20 pcs (code **4602-20**)
  - 9) 90° beveled edge square, 100x70mm, grade 0 (code **4790-1000**)
  - 10) Scriber (code **7230**)
  - 11) Steel rule, 150mm/6" (code **7110-150**)
  - 12) Depth base attachment (code **6140**)
  - 13) Zero setting bar for depth base attachment

**Code**

**5013**



5013



**Granite Surface Plates**  
Page 450



**Jack Sets For Granite Surface Plates**  
Page 451



**Stands For Granite Surface Plates**  
Page 451



**Magnetic Rectangular Blocks**  
Page 452



**V-blocks**  
Page 452-456



**Magnetic V-blocks**  
Page 456-458

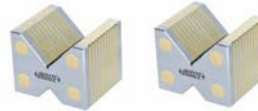

**Magnetic Induction V-blocks**  
Page 458



**Squares With V Groove**  
Page 459



**Permanent Magnetic Chucks**  
Page 459



**Parallels**  
Page 460-462



**Parallel/Square Sets**  
Page 462

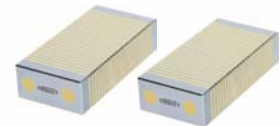

**Magnetic Induction Parallel Sets**  
Page 463



**Angle Plate Sets**  
Page 463



**Adjustable Angle Blocks**  
Page 464



**Right Angle Plates**  
Page 464-465



**Sine Bars**  
Page 465





Sine Tables  
Page 466



Precision Sine Vises  
Page 467-468



Precision Universal Vises  
Page 468

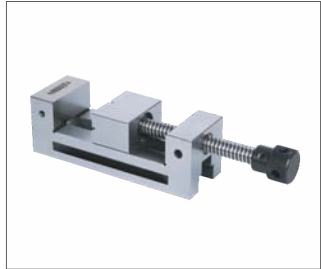

Precision Vises  
Page 469



Anvil Vises  
Page 469



Stages  
Page 470-473

## GRANITE SURFACE PLATES



CUSTOM-MADE  
SUPPLY SPECIAL SIZES ACCORDING  
TO CUSTOMER'S REQUEST

- Made of Indian granite, high hardness, free from deterioration or dimensional change over time, minimal changes in dimension due to temperature changes
- Meet DIN876, grade 00 is for inspection room or lab, grade 0 is for workshop
- Optional accessory:  
stand for granite surface plate (code **6902**),  
jack for granite surface plate (code **6903**)



6900-132

### Grade 00

Code	Size (L×W×H)	Flatness	Weight	Max. load
6900-132*	300×200×60mm	2.7µm	11kg	30kg
6900-142*	400×250×60mm	2.9µm	18kg	50kg
6900-144*	400×400×60mm	3.1µm	29kg	60kg
6900-153*	500×315×70mm	3.2µm	33kg	60kg
6900-164*	630×400×80mm	3.5µm	60kg	65kg
6900-166*	630×630×100mm	3.8µm	119kg	75kg
6900-185*	800×500×100mm	3.9µm	120kg	100kg
6900-1106*	1000×630×140mm	4.4µm	265kg	200kg
6900-1107*	1000×750×150mm	4.5µm	337kg	300kg
6900-1101*	1000×1000×150mm	4.8µm	450kg	400kg
6900-1128*	1200×800×160mm	4.9µm	461kg	500kg
6900-1161*	1600×1000×180mm	5.8µm	864kg	600kg
6900-1201*	2000×1000×220mm	6.5µm	1320kg	650kg
6900-1202*	2000×1500×250mm	7.0µm	2250kg	750kg

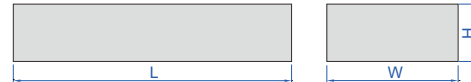

### Grade 0

Code	Size (L×W×H)	Flatness	Weight	Max. load
6900-032*	300×200×60mm	5.4µm	11kg	60kg
6900-042*	400×250×60mm	5.9µm	18kg	100kg
6900-044*	400×400×60mm	6.3µm	29kg	120kg
6900-053*	500×315×70mm	6.4µm	33kg	120kg
6900-064*	630×400×80mm	7.0µm	60kg	130kg
6900-066*	630×630×100mm	7.6µm	119kg	150kg
6900-085*	800×500×100mm	7.8µm	120kg	200kg
6900-0106*	1000×630×140mm	8.7µm	265kg	400kg
6900-0107*	1000×750×150mm	9.0µm	337kg	600kg
6900-0101*	1000×1000×150mm	9.7µm	450kg	800kg
6900-0128*	1200×800×160mm	9.8µm	461kg	1000kg
6900-0161*	1600×1000×180mm	11.5µm	864kg	1200kg
6900-0201*	2000×1000×220mm	12.9µm	1320kg	1300kg
6900-0202*	2000×1500×250mm	14.0µm	2250kg	1500kg

\*Supplied with manufacturer inspection certificate



## JACK SET FOR GRANITE SURFACE PLATES

- 5 jacks per set
- Adjustable height
- For large granite surface plates:  
2000×1000×220mm  
(code **6900-0201** and **6900-1201**)  
2000×1500×250mm  
(code **6900-0202** and **6900-1202**)

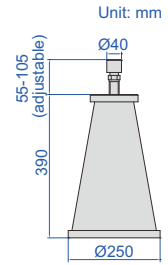

6903-B

Code
6903-B

## STANDS FOR GRANITE SURFACE PLATES

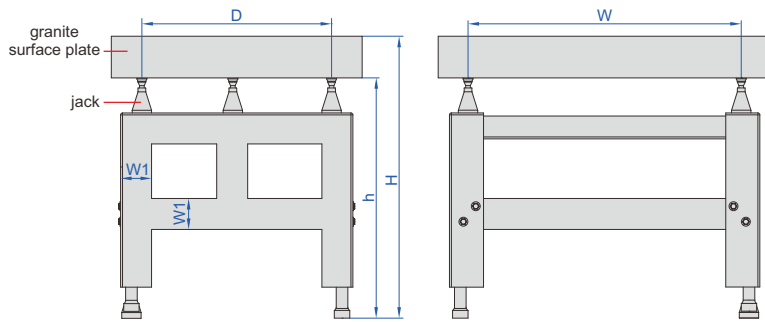

6902-64A

- For medium size granite surface plates
- 5 jacks are included
- Adjusting range of jacks: 25mm
- One foot on the bottom is adjustable

### Low stands

(mm)

Code	For granite surface plate	W	D	H (with granite surface plate)	h (without granite surface plate)	W1
6902-64A	630×400×80mm (code <b>6900-064</b> and <b>6900-164</b> )	352	224	775-800	695-720	80
6902-66A	630×630×100mm (code <b>6900-066</b> and <b>6900-166</b> )	352	352	775-800	675-700	80
6902-85A	800×500×100mm (code <b>6900-085</b> and <b>6900-185</b> )	448	280	775-800	675-700	80
6902-106A	1000×630×140mm (code <b>6900-0106</b> and <b>6900-1106</b> )	560	352	755-780	615-640	80
6902-107A	1000×750×150mm (code <b>6900-0107</b> and <b>6900-1107</b> )	560	420	755-780	605-630	80
6902-101A	1000×1000×150mm (code <b>6900-0101</b> and <b>6900-1101</b> )	560	560	755-780	605-630	80
6902-128A	1200×800×160mm (code <b>6900-0128</b> and <b>6900-1128</b> )	672	448	755-780	595-620	80
6902-161A	1600×1000×180mm (code <b>6900-0161</b> and <b>6900-1161</b> )	896	560	755-780	575-600	100
6902-201A	2000×1000×220mm (code <b>6900-0201</b> and <b>6900-1201</b> )	1120	560	755-780	535-560	100
6902-202A	2000×1500×250mm (code <b>6900-0202</b> and <b>6900-1202</b> )	1120	840	755-780	505-530	100

### High stands

(mm)

Code	For granite surface plate	W	D	H (with granite surface plate)	h (without granite surface plate)	W1
6902-64H	630×400×80mm (code <b>6900-064</b> and <b>6900-164</b> )	352	224	1000-1025	920-945	80
6902-66H	630×630×100mm (code <b>6900-066</b> and <b>6900-166</b> )	352	352	1000-1025	900-925	80
6902-85H	800×500×100mm (code <b>6900-085</b> and <b>6900-185</b> )	448	280	1000-1025	900-925	80
6902-106H	1000×630×140mm (code <b>6900-0106</b> and <b>6900-1106</b> )	560	352	1000-1025	860-885	80
6902-107H	1000×750×150mm (code <b>6900-0107</b> and <b>6900-1107</b> )	560	420	1000-1025	850-875	80
6902-101H	1000×1000×150mm (code <b>6900-0101</b> and <b>6900-1101</b> )	560	560	1000-1025	850-875	80
6902-128H	1200×800×160mm (code <b>6900-0128</b> and <b>6900-1128</b> )	672	448	1000-1025	840-865	80
6902-161H	1600×1000×180mm (code <b>6900-0161</b> and <b>6900-1161</b> )	896	560	1000-1025	820-845	100
6902-201H	2000×1000×220mm (code <b>6900-0201</b> and <b>6900-1201</b> )	1120	560	1000-1025	780-805	100
6902-202H	2000×1500×250mm (code <b>6900-0202</b> and <b>6900-1202</b> )	1120	840	1000-1025	750-775	100

## MAGNETIC RECTANGULAR BLOCKS

HARDENED SURFACES

HIGH PRECISION

STRONG MAGNETIC FORCE

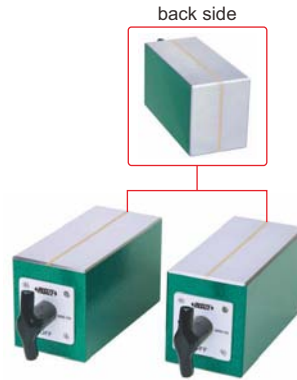
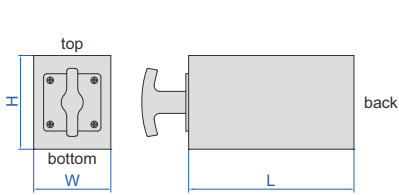

6898-150

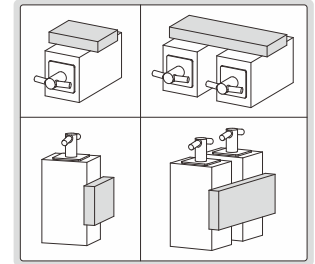

- For grinding, light milling, drilling and inspection of round and square jobs
- Hardened, high accuracy, strong magnetic force
- Working surfaces are hardened to HRC58-62
- Magnetic force on top, bottom and back sides
- Supplied in matched pair

Code	Size (L×W×H)	Magnetic force	Parallelism of top to bottom side	Squareness of top and bottom to back side	Height difference of a matched pair
6898-100	100×70×70mm	100kgf	5µm	5µm	5µm
6898-150	150×70×85mm	125kgf	5µm	5µm	5µm

## V-BLOCK SETS



6896-10

6896-11

- Hold cylindrical workpieces for inspection and machining
- Two V-blocks per set
- Made of alloy steel
- Hardened to HRC60±2
- V groove on the top for large shafts
- V groove on the bottom for small shafts (except 6896-10)

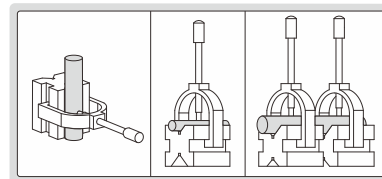

Code	Size (L×W×H)	Range of shafts (Ød)	Parallelism of both V grooves to top and bottom sides	Squareness of both V grooves to front and back sides	Height difference of a matched pair
6896-10	25×20×20mm	3-20mm	3µm	3µm	3µm
6896-11	50×40×40mm	5-30mm	5µm	5µm	5µm
6896-12	80×63×63mm	7-63mm	5µm	5µm	5µm
6896-13	100×80×80mm	7-80mm	5µm	5µm	5µm
6896-14	70×140×140mm	9-140mm	5µm	5µm	5µm

SIDE LIE-DOWN  
USE IS POSSIBLE

## V-BLOCK SET



6802-1

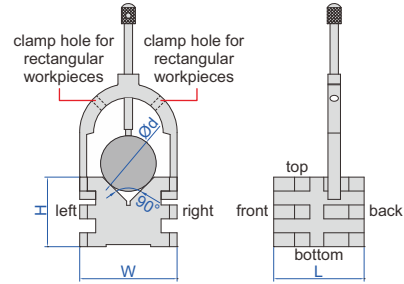

- Hold cylindrical or rectangular workpieces for inspection and machining
- Two V-blocks per set
- Made of alloy steel
- Hardened to HRC60±2
- Applicable for cylinder with diameter ( $\varnothing d$ ): 5-50mm
- Applicable for rectangular workpieces with thickness:  $\leq 35$ mm

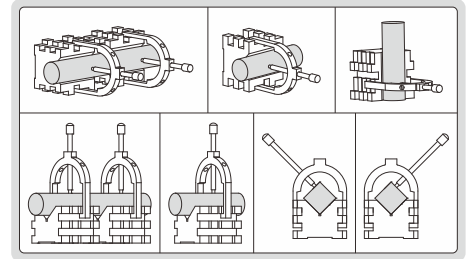

Code	Size (L×W×H)	Parallelism of V groove to top, bottom, left, right sides	Squareness of V groove to front and back sides	Height difference of a matched pair
6802-1	65×70×50mm	5 $\mu$ m	5 $\mu$ m	5 $\mu$ m

SIDE LIE-DOWN  
USE IS POSSIBLE

## V-BLOCK SETS



6803-1

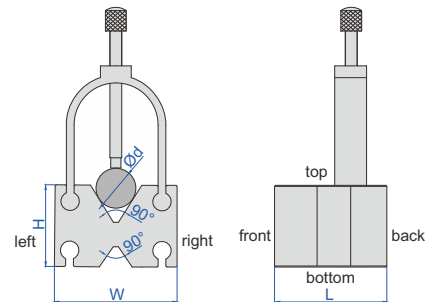

- Hold cylindrical workpieces for inspection and machining
- Two V-blocks per set
- Made of alloy steel
- Hardened to HRC60±2
- V groove on the top for large shafts
- V groove on the bottom for small shafts

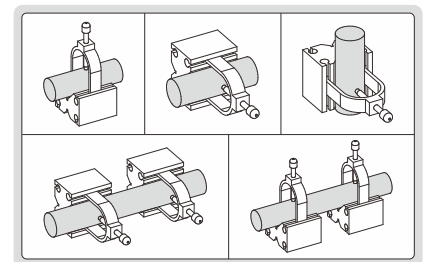

Code	Size (L×W×H)	Range of shafts ( $\varnothing d$ )	Parallelism of both V grooves to top, bottom, left, right sides	Squareness of both V grooves to front and back sides	Height difference of a matched pair
6803-1	55×60×40mm	4-35mm	5 $\mu$ m	5 $\mu$ m	5 $\mu$ m
6803-2	65×70×45mm	4-47mm	5 $\mu$ m	5 $\mu$ m	5 $\mu$ m

## V-BLOCK SET

SIDE LIE-DOWN  
USE IS POSSIBLE

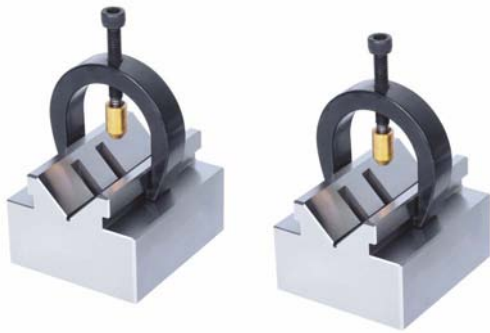

6806-20

- Hold cylindrical workpieces for inspection and machining
- Two V-blocks per set
- Made of alloy steel
- Hardened to HRC60±2
- Applicable for cylinder with diameter (Ød): 2-20mm

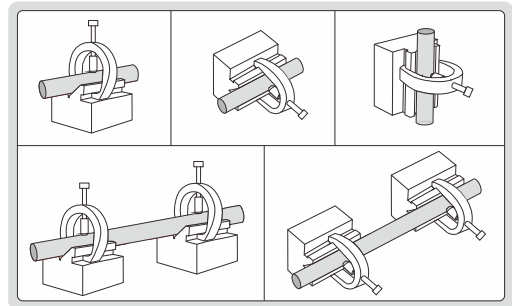
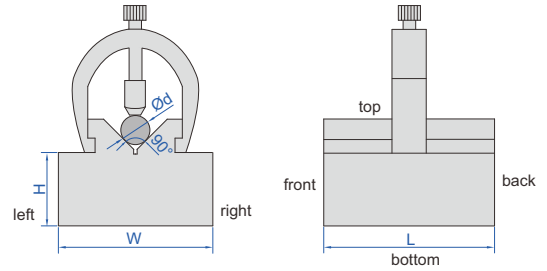

Code	Size (L×W×H)	Parallelism of V groove to bottom, left, right sides	Squareness of V groove to front and back sides	Height difference of a matched pair
6806-20	70×63×46mm	5µm	5µm	5µm

## V-BLOCK

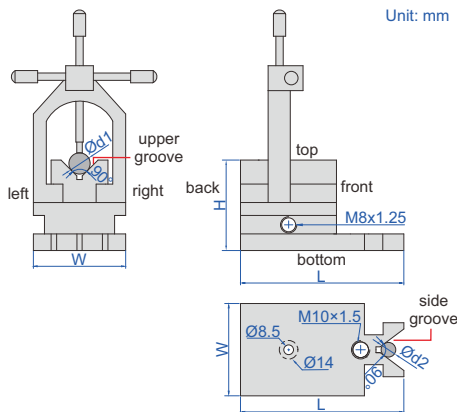

Unit: mm



6804-M2

- Hold cylindrical workpieces for inspection and machining
- Made of alloy steel
- Hardened to HRC60±2



Code	Size (L×W×H)	Range of shafts (Ød1 and Ød2)	Parallelism of upper groove to bottom, left and right sides	Squareness of upper groove to back side	Parallelism of side groove to back side
6804-M2	90×48×48mm	5-33mm	5µm	5µm	5µm

## V-BLOCK SETS

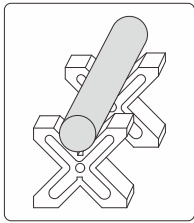

- For positioning cylindrical workpieces
- Two V-blocks per set
- Each V-block has four 90° V-grooves
- Cast iron, hardness HB170-240



6805-2

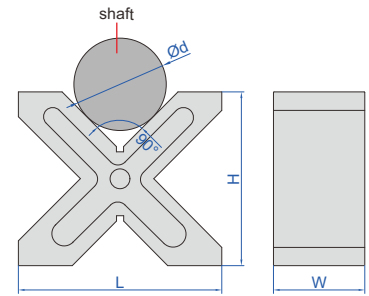

Code	Size (L×H×W)	Range of shafts (Ød)	Parallelism of four V grooves to all sides	Height difference of a matched pair
6805-1	150×130×75mm	8-120mm	15µm	20µm
6805-2	200×170×90mm	12-180mm	15µm	20µm

## V-BLOCK SETS

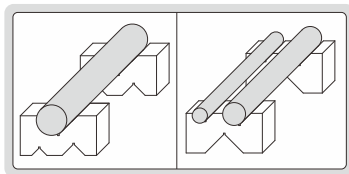

- Two V-blocks per set
- Made of hardened tool steel



6887-3

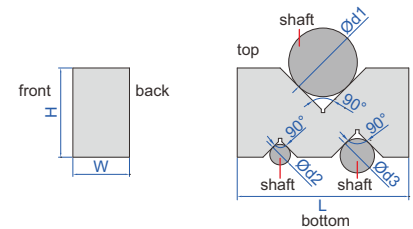

Code	Size (L×W×H)	Range of shafts (Ød1)	Range of shafts (Ød2)	Range of shafts (Ød3)
6887-1	50×19×24mm	3-32mm	3-16mm	3-22mm
6887-2	75×24×35mm	3-50mm	3-20mm	3-32mm
6887-3	100×33×52mm	3-68mm	3-26mm	3-40mm
6887-4	125×44×69mm	3-87mm	3-34mm	3-50mm

Code	Parallelism of three V grooves to top and bottom sides	Height difference of a matched pair
6887-1	5µm	5µm
6887-2	5µm	5µm
6887-3	5µm	5µm
6887-4	5µm	5µm

## ROLLER BEARING V-BLOCK SETS

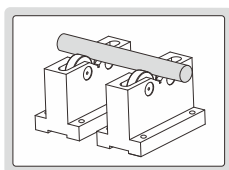

- Runout accuracy: 5µm
- Parallelism of bearings to bottom: 12µm
- Two V-blocks per set
- Workpieces don't get damaged due to bearings
- Suitable for heavy workpieces



6888-1

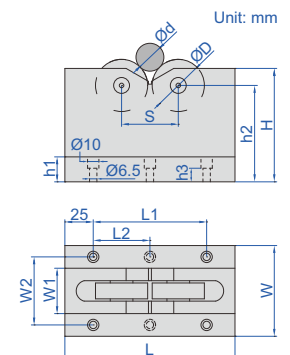

Code	Size (L×W×H)	Code of bearings	Diameter of bearings (ØD)	Range of shafts (Ød)	Load capacity
6888-1	150×60×100mm	16004 ZZ	42mm	25-70mm	500kg
6888-2	150×80×100mm	6303 ZZ	47mm	5-55mm	1000kg
6888-3	230×100×150mm	6306 ZZ	72mm	70-200mm	1000kg

Code	W1	W2	h1	h2	h3	L1	L2	S
6888-1	22	44	20	85	12	100	-	60
6888-2	40	60	22	85	12	100	-	50
6888-3	60	80	30	124	20	180	90	120

## GRANITE V-BLOCK SETS

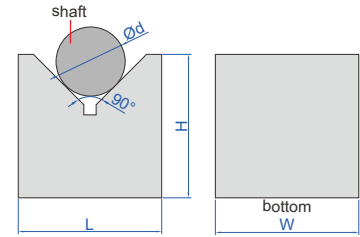
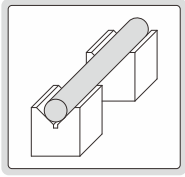

- Two V-blocks per set

6897-1

Code	Size (L×W×H)	Range of shafts (Ød)	Parallelism of V groove to bottom	Height difference of a matchet pair
6897-1	70×50×70mm	6-70mm	4µm	5µm
6897-2	100×50×70mm	6-84mm	4µm	5µm

## MAGNETIC V-BLOCKS (PROFESSIONAL TYPE)

HARDENED SURFACES

HIGH PRECISION

STRONG MAGNETIC FORCE

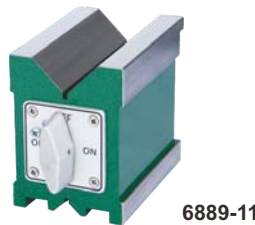
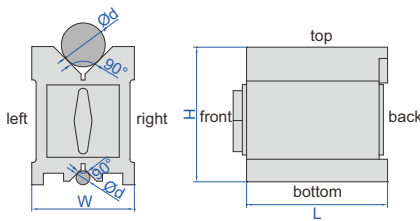

6889-11

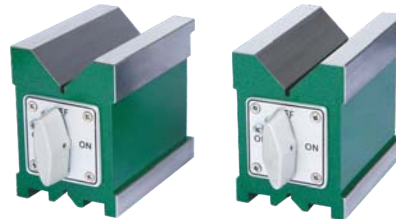

6889-1

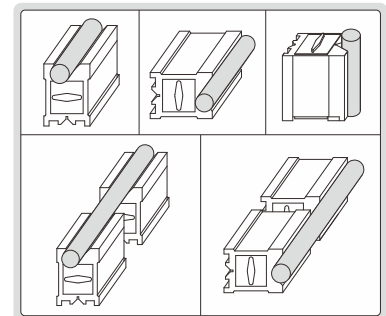

- Hardened, high accuracy, strong magnetic force, for grinding, light milling, drilling and inspection of round and square workpieces
- All working surfaces are hardened to HRC60±2
- Magnetic force on top, bottom and two V grooves
- V groove on the top for large shafts
- V groove on the bottom for small shafts
- Suitable for cast iron surface plates and granite surface plates

### Individual

Code	Size (L×W×H)	Range of shafts (Ød)	Magnetic force	Parallelism of V grooves to top, bottom, left, right sides	Squareness of V grooves to back side
6889-11	75×56×75mm	5-40mm	85kgf	5µm	5µm
6889-22	100×70×95mm	5-65mm	150kgf	5µm	5µm
6889-33	150×75×100mm	5-70mm	190kgf	6µm	6µm
6889-55	160×125×130mm	5-140mm	220kgf	12µm	12µm
6889-44	200×125×150mm	10-140mm	400kgf	12µm	12µm

### Matched pair

Code	Size (L×W×H)	Range of shafts (Ød)	Magnetic force	Parallelism of V grooves to top, bottom, left, right sides	Squareness of V grooves to back side	Height difference of a matched pair
6889-1	75×56×75mm	5-40mm	85kgf	5µm	5µm	5µm
6889-2	100×70×95mm	5-65mm	150kgf	5µm	5µm	5µm
6889-3	150×75×100mm	5-70mm	190kgf	6µm	6µm	6µm
6889-5	160×125×130mm	5-140mm	220kgf	12µm	12µm	12µm
6889-4	200×125×150mm	10-140mm	400kgf	12µm	12µm	12µm



ATTENTION: NOT SUITABLE FOR STEEL OR IRON SURFACES, OTHERWISE THE MAGNETIC FORCE WILL BE REDUCED

ATTENTION: NOT HARDENED

## MAGNETIC V-BLOCK (ECONOMIC TYPE)

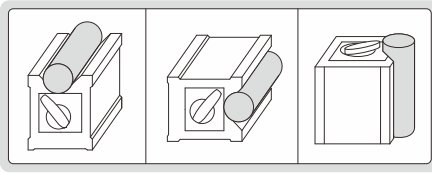

6890-702

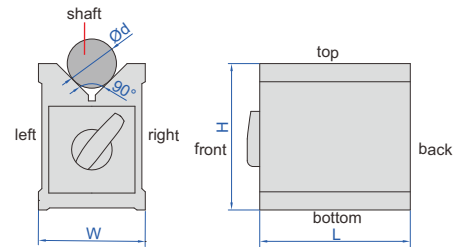

- Hold cylindrical workpieces for inspection and machining
- Supplied in single piece
- Not hardened
- Not suitable for steel or iron surfaces, otherwise the magnetic force will be reduced

Code	Size (L×W×H)	Range of shafts (Ød)	Magnetic force	Parallelism of V groove to top, bottom, left and right sides	Squareness of V groove to back side
6890-702	70×60×73mm	6-44mm	56kgf	10µm	10µm

ATTENTION: NOT SUITABLE FOR STEEL OR IRON SURFACES, OTHERWISE THE MAGNETIC FORCE WILL BE REDUCED

ATTENTION: NOT HARDENED

## MAGNETIC V-BLOCKS (ECONOMIC TYPE)

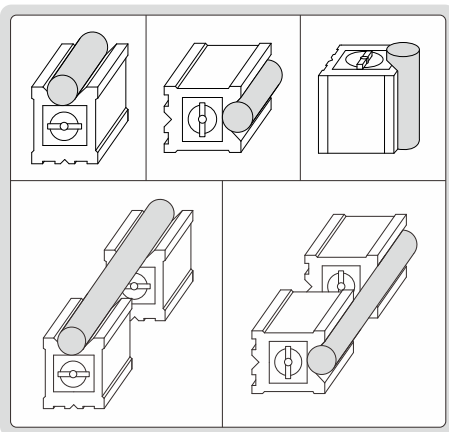

6801-1201



6801-1

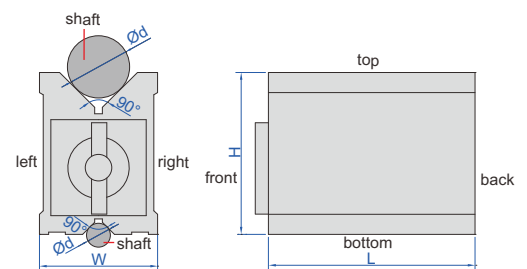

- Hold cylindrical workpieces for inspection and machining
- Not hardened
- V groove on the top for large shafts
- V groove on the bottom for small shafts
- Not suitable for steel or iron surfaces, otherwise the magnetic force will be reduced

### Individual

Code	Size (L×W×H)	Range of shafts (Ød)	Magnetic force	Parallelism of V grooves to top, bottom, left, right side	Squareness of V grooves to back side
6801-1201	80×70×95mm	6-67mm	64kgf	10µm	10µm
6801-1202	100×70×95mm	6-67mm	80kgf	10µm	10µm
6801-1203	120×70×95mm	6-67mm	96kgf	10µm	10µm

### Matched pair

Code	Size (L×W×H)	Range of shafts (Ød)	Magnetic force	Parallelism of V grooves to top, bottom, left, right side	Squareness of V grooves to back side	Height difference of a matched pair
6801-1	80×70×95mm	6-67mm	64kgf	10µm	10µm	10µm
6801-2	100×70×95mm	6-67mm	80kgf	10µm	10µm	10µm
6801-3	120×70×95mm	6-67mm	96kgf	10µm	10µm	10µm

## MAGNETIC INDUCTION V-BLOCK SET

ATTENTION: NOT HARDENED, DO NOT ROTATE WORKPIECES ON V-BLOCKS

- Hold cylindrical workpieces for inspection and machining
- To be used on magnetic chucks
- Two V-blocks per set
- V groove on the top for large shafts
- V groove on the bottom for small shafts
- Hardness HRB70
- Copper magnetic strips

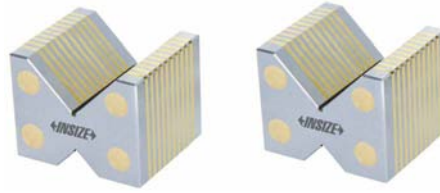

6878-1

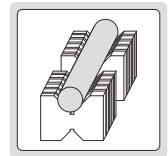
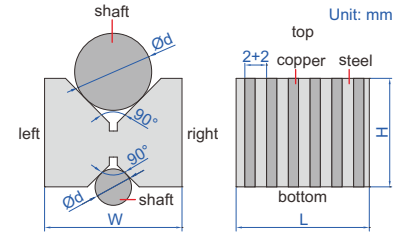

Code	Size (L×W×H)	Range of shafts (Ød)	Pole pitch	Parallelism of both V grooves to top and bottom sides	Height difference of a matched pair
6878-1	49×58×46mm	5-56mm	2+2mm	10µm	10µm

## MAGNETIC INDUCTION V-BLOCK

ATTENTION: NOT HARDENED, DO NOT ROTATE WORKPIECES ON V-BLOCKS

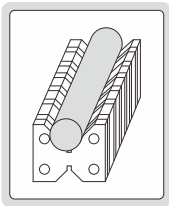

- Hold cylindrical workpieces for inspection and machining
- To be used on magnetic chucks
- Supplied in single piece
- V groove on the top for large shafts
- V groove on the bottom for small shafts
- Hardness HRB70



6892-1

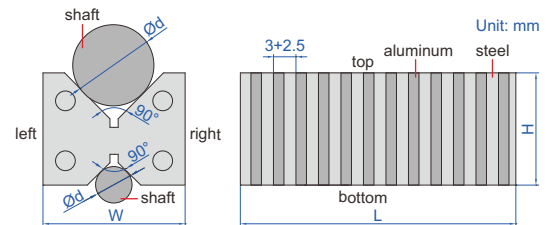

Code	Size (L×W×H)	Range of shafts (Ød)	Pole pitch	Parallelism of both V grooves to top and bottom sides
6892-1	110×60×48mm	6-50mm	3+2.5mm	10µm

## MAGNETIC V-BLOCK SETS

ATTENTION: NOT HARDENED, DO NOT ROTATE WORKPIECES ON V-BLOCKS

ATTENTION: LOW MAGNETIC FORCE

- Hold cylindrical workpieces for inspection, not suitable for machining due to low magnetic force
- Two V-blocks per set
- Hardness HRB70



6891-1

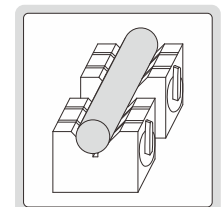
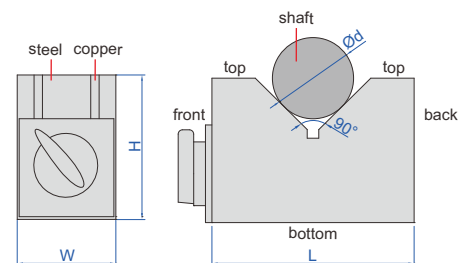

Code	Size (L×W×H)	Range of shafts (Ød)	Magnetic force	Parallelism of V groove to bottom and back sides	Height difference of a matched pair
6891-1	70×40×50mm	6-46mm	15kgf	10µm	10µm
6891-3	150×50×100mm	6-125mm	21kgf	10µm	10µm

## GRANITE SQUARE WITH V GROOVE



4142-200

- Parallelism and squareness of A, B, C, D, E and F: 6µm
- Parallelism and squareness of V groove to A, B, C, D, E and F: 6µm

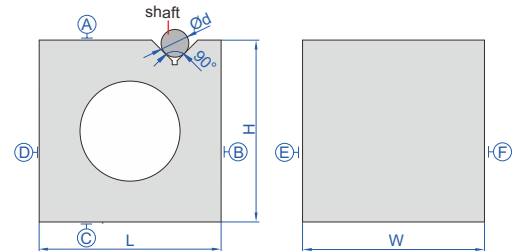

Code	Size (L×W×H)	Range of shaft (Ød)
4142-200	200×200×200mm	9~70mm

ATTENTION: NOT HARDENED, DO NOT ROTATE WORKPIECES ON V-BLOCKS

## MAGNETIC SQUARE WITH V GROOVE



6539-100

- Hold flat and cylindrical workpieces for inspection and machining
- Magnetic force on top, left, right and V grooves
- Parallelism and squareness of top, bottom, left, right and back: 20µm
- Parallelism and squareness of V grooves to top, bottom, left, right and back: 20µm

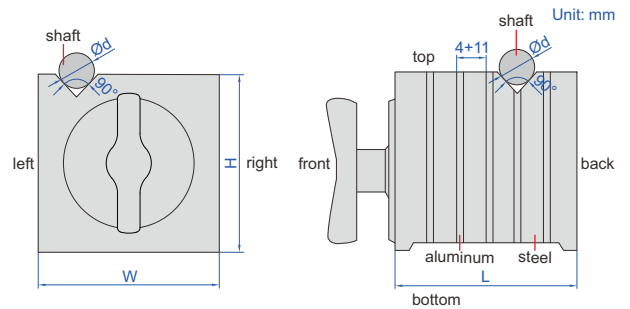

Code	Size (L×W×H)	Magnetic force of V grooves		Magnetic force of top, left and right sides		Range of shafts (Ød)
		on granite surface plate	on cast iron plate	on granite surface plate	on cast iron plate	
6539-100	100×100×100mm	30kgf	25kgf	50kgf	30kgf	5-30mm

ATTENTION: NOT HARDENED

## PERMANENT MAGNETIC CHUCK



6537-400

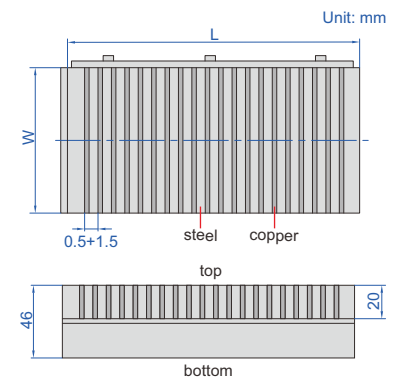

Code	Table size (L×W)	Magnetic force	Pole pitch	Parallelism of top to bottom
6537-400	400×200mm	8kgf/cm <sup>2</sup>	0.5+1.5mm	0.02mm/300mm

## PARALLELS

- Made of alloy tool steel
- Hardened to HRC55-60
- Supplied in pair

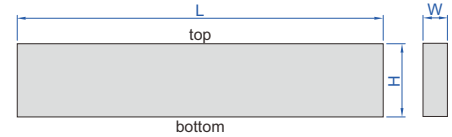

### 6512-2210A

L=125mm	L=150mm	L=200mm			
Code	Code	Code	H×W	Parallelism between top and bottom	Height difference of a matched pair
6512-118	6512-1181	6512-1182	11×8mm	5μm	5μm
6512-168	6512-1681	6512-1682	16×8mm	5μm	5μm
6512-218	6512-2181	6512-2182	21×8mm	5μm	5μm
6512-268	6512-2681	6512-2682	26×8mm	5μm	5μm
6512-318	6512-3181	6512-3182	31×8mm	5μm	5μm
6512-368	6512-3681	6512-3682	36×8mm	5μm	5μm
6512-1310	6512-13101	6512-13102	13×10mm	5μm	5μm
6512-1810	6512-18101	6512-18102	18×10mm	5μm	5μm
6512-2310	6512-23101	6512-23102	23×10mm	5μm	5μm
6512-2810	6512-28101	6512-28102	28×10mm	5μm	5μm
6512-3310	6512-33101	6512-33102	33×10mm	5μm	5μm
6512-3810	6512-38101	6512-38102	38×10mm	5μm	5μm
6512-1512	6512-15121	6512-15122	15×12mm	5μm	5μm
6512-2012	6512-20121	6512-20122	20×12mm	5μm	5μm
6512-2512	6512-25121	6512-25122	25×12mm	5μm	5μm
6512-3012	6512-30121	6512-30122	30×12mm	5μm	5μm
6512-3512	6512-35121	6512-35122	35×12mm	5μm	5μm
6512-4012	6512-40121	6512-40122	40×12mm	5μm	5μm
6512-1714	6512-17141	6512-17142	17×14mm	5μm	5μm
6512-2214	6512-22141	6512-22142	22×14mm	5μm	5μm
6512-2714	6512-27141	6512-27142	27×14mm	5μm	5μm
6512-3214	6512-32141	6512-32142	32×14mm	5μm	5μm
6512-3714	6512-37141	6512-37142	37×14mm	5μm	5μm
6512-4214	6512-42141	6512-42142	42×14mm	5μm	5μm

### L=100mm

Code	H×W	Parallelism between top and bottom	Height difference of a matched pair
6512-52	5×2mm	7μm	7μm
6512-102	10×2mm	5μm	5μm
6512-152	15×2mm	5μm	5μm
6512-202	20×2mm	5μm	5μm
6512-63	6×3mm	7μm	7μm
6512-113	11×3mm	5μm	5μm
6512-163	16×3mm	5μm	5μm
6512-213	21×3mm	5μm	5μm
6512-74	7×4mm	7μm	7μm
6512-124	12×4mm	5μm	5μm
6512-174	17×4mm	5μm	5μm
6512-224	22×4mm	5μm	5μm
6512-85	8×5mm	7μm	7μm
6512-135	13×5mm	5μm	5μm
6512-185	18×5mm	5μm	5μm
6512-235	23×5mm	5μm	5μm
6512-96	9×6mm	7μm	7μm
6512-146	14×6mm	5μm	5μm
6512-196	19×6mm	5μm	5μm
6512-246	24×6mm	5μm	5μm

### L=150mm

Code	H×W	Parallelism between top and bottom	Height difference of a matched pair
6512-1410A	14×10mm	5μm	5μm
6512-1610A	16×10mm	5μm	5μm
6512-1810A	18×10mm	5μm	5μm
6512-2010A	20×10mm	5μm	5μm
6512-2210A	22×10mm	5μm	5μm
6512-2410A	24×10mm	5μm	5μm
6512-2610A	26×10mm	5μm	5μm
6512-2810A	28×10mm	5μm	5μm
6512-3010A	30×10mm	5μm	5μm
6512-3210A	32×10mm	5μm	5μm
6512-3510A	35×10mm	5μm	5μm
6512-4010A	40×10mm	5μm	5μm
6512-4510A	45×10mm	5μm	5μm
6512-5010A	50×10mm	5μm	5μm



Continued from previous page

L=160mm

Code	H×W	Parallelism between top and bottom	Height difference of a matched pair
6512-104A	10×4mm	5μm	5μm
6512-144A	14×4mm	5μm	5μm
6512-184A	18×4mm	5μm	5μm
6512-224A	22×4mm	5μm	5μm
6512-264A	26×4mm	5μm	5μm
6512-304A	30×4mm	5μm	5μm
6512-344A	34×4mm	5μm	5μm
6512-384A	38×4mm	5μm	5μm
6512-424A	42×4mm	5μm	5μm
6512-128A	12×8mm	5μm	5μm
6512-178A	17×8mm	5μm	5μm
6512-228A	22×8mm	5μm	5μm
6512-258A	25×8mm	5μm	5μm
6512-288A	28×8mm	5μm	5μm
6512-328A	32×8mm	5μm	5μm
6512-368A	36×8mm	5μm	5μm
6512-388A	38×8mm	5μm	5μm

L=200mm

Code	H×W	Parallelism between top and bottom	Height difference of a matched pair
6512-178B	17×8mm	5μm	5μm
6512-228B	22×8mm	5μm	5μm
6512-268B	26×8mm	5μm	5μm
6512-288B	28×8mm	5μm	5μm
6512-328B	32×8mm	5μm	5μm
6512-368B	36×8mm	5μm	5μm
6512-388B	38×8mm	5μm	5μm
6512-428B	42×8mm	5μm	5μm

## PARALLEL SETS

- Parallelism between top and bottom: 5μm
- Height difference of a matched pair: 5μm
- Made of alloy tool steel
- Hardened to HRC55-60



6533-144

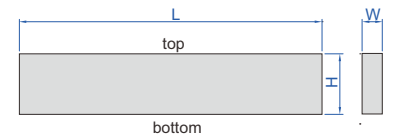

Code	Parallels per set	Length (L)	Thickness (W)	Height (H)
6533-6	6 pairs	200mm	9.5mm	35, 40, 45, 50, 55, 58mm
6533-8	8 pairs	160mm	8mm	12*, 17, 22, 25, 28, 32, 36, 38mm
6533-81	8 pairs	200mm	8mm	17, 22, 26, 28, 32, 36, 38, 42mm
6533-9	9 pairs	160mm	4mm	10*, 14*, 18, 22, 26, 30, 34, 38, 42mm
6533-10	10 pairs	150mm	3mm	13, 16, 19, 22, 25, 28, 31, 35, 38, 41mm
6533-144	14 pairs	150mm	10mm	14, 16, 18, 20, 22, 24, 26, 28, 30, 32, 35, 40, 45, 50mm

\* Parallelism between top and bottom and height difference of a matched pair of 12mm in **6533-8**, 10mm, 14mm in **6533-9** is 7μm

## PARALLEL SET

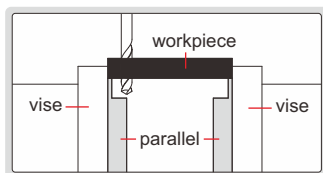

- Parallelism between top and bottom: 5μm
- Height difference of a matched pair: 5μm
- Made of alloy tool steel
- Hardened to HRC55-60



6534-6

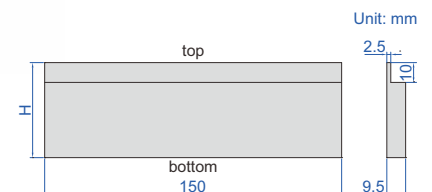

Code	Parallels per set	Height (H)
6534-6	6 pairs	25, 30, 35, 40, 45, 48mm

## PARALLEL SETS

- Parallelism between top and bottom: 5µm
- Height difference of a matched pair: 5µm
- Made of alloy tool steel
- Hardened to HRC55-60



6511-20

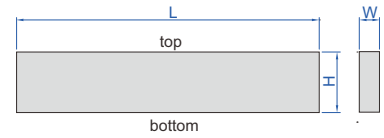

Code	Parallels per set	Length (L)	Height (H)×Thickness (W)
6511-20	20 pairs	100mm	5×2*, 10×2, 15×2, 20×2, 6×3*, 11×3, 16×3, 21×3, 7×4*, 12×4, 17×4, 22×4, 8×5*, 13×5, 18×5, 23×5, 9×6*, 14×6, 19×6, 24×6mm
6511-24	24 pairs	125mm	11×8, 16×8, 21×8, 26×8, 31×8, 36×8, 13×10, 18×10, 23×10, 28×10, 33×10, 38×10, 15×12, 20×12, 25×12, 30×12, 35×12, 40×12, 17×14, 22×14, 27×14, 32×14, 37×14, 42×14mm
6511-241	24 pairs	150mm	11×8, 16×8, 21×8, 26×8, 31×8, 36×8, 13×10, 18×10, 23×10, 28×10, 33×10, 38×10, 15×12, 20×12, 25×12, 30×12, 35×12, 40×12, 17×14, 22×14, 27×14, 32×14, 37×14, 42×14mm

\* Parallelism between top and bottom and height difference of a matched pair of 5×2mm, 6×3mm, 7×4mm, 8×5mm and 9×6mm in 6511-20 is 7µm

## GRANITE PARALLEL SET

- Made of granite, hard and no rusty, no dimensional change over time or temperature change
- Two parallels per set



4143-250

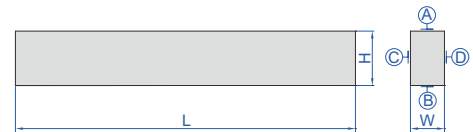
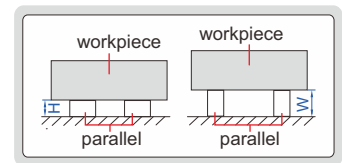

Code	Size (L×W×H)	Parallelism between A and B	Parallelism between C and D	Height difference of a matched pair
4143-250	250×25×40mm	3µm	3µm	3µm

## PARALLEL/SQUARE SET

screws and wrench are included



6531-25

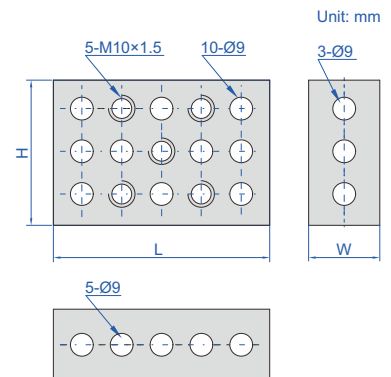

- Pairs of matched blocks for positioning and set-up
- Screws and wrench are included
- Hardness HRC 55-62

Code	Size (L×H×W)	Size accuracy	Squareness	Parallelism	Height difference of a matched pair
6531-25	75×50×25mm	10µm	7µm/25mm	10µm	10µm

**ATTENTION:  
NOT HARDENED**

## MAGNETIC INDUCTION PARALLEL SET



6879-1

- To be used on magnetic chucks
- Two parallels per set
- Hardness HRB70
- Copper magnetic strips

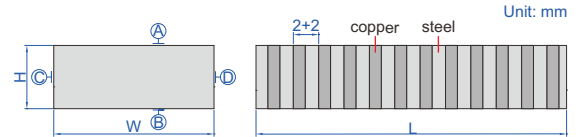
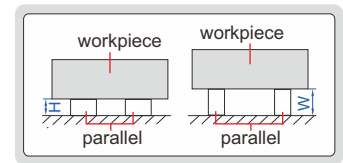

Code	Size (L×W×H)	Pole pitch	Parallelism between A and B	Parallelism between C and D	Height difference of a matched pair
6879-1	100×50×25mm	2+2mm	10µm	10µm	10µm

## ANGLE PLATE SETS

- For angle set-up in tooling, production and inspection
- Hardness HRC52

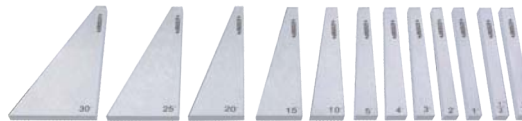

4006-12

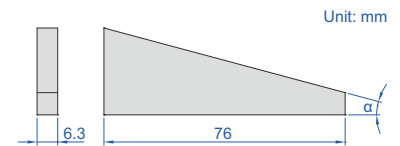

Code	Angle plates included	Angle $\alpha$	Accuracy
4006-10	10 pcs	1°, 2°, 3°, 4°, 5°, 10°, 15°, 20°, 25°, 30°	±20 seconds
4006-12	12 pcs	1/4°, 1/2°, 1°, 2°, 3°, 4°, 5°, 10°, 15°, 20°, 25°, 30°	±20 seconds

## ANGLE PLATE SET

- For angle set-up in tooling, production and inspection
- Made of tool steel
- Hardness HRC55



4004-9

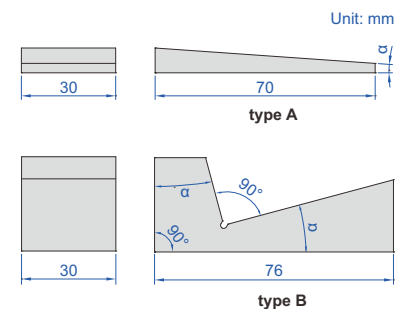

Code	Angle plates included	Angle $\alpha$	Type	Accuracy
4004-9	9 pcs	1/2°, 1°, 2°, 3°, 4°, 5°	type A	±30 seconds
		10°, 15°, 30°	type B	±50 seconds

## ADJUSTABLE ANGLE BLOCKS



6535-30

- Made of hardened tool steel
- With locking screw
- Accuracy of angle: 10 minutes

Code	Size (L×W×H)	h	Adjustable angle	Graduation of angle
6535-25	75×25×36mm	25mm	30°~0°~60°	10 minutes
6535-30	102×30×49mm	30mm	30°~0°~60°	10 minutes

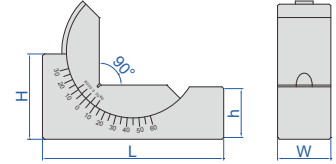

## RIGHT ANGLE PLATE

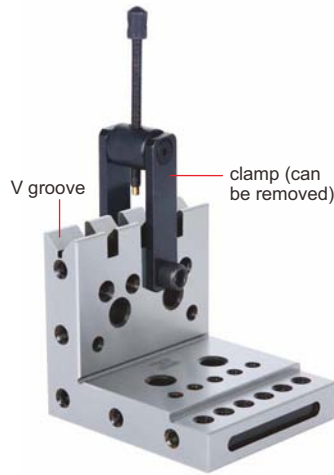

6547-1

- Made of alloy steel
- Hardened to HRC60±2
- V groove for cylinders
- Parallelism and squareness between A, B, C, D, E, F, G and H: 10µm
- Parallelism and squareness of V groove to A, B, C, D, E, F, G and H: 10µm

Code	Size (L×W×H)
6547-1	100×100×115mm

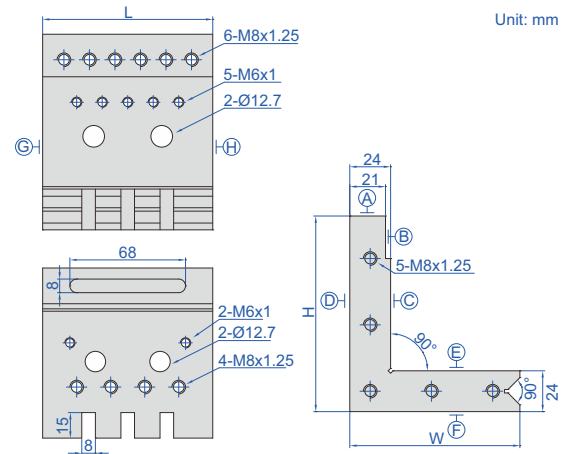

## RIGHT ANGLE PLATE

- Made of tool steel
- Hardened to HRC60±2
- Squareness or parallelism between A, B, C and D: 5µm



6548-1

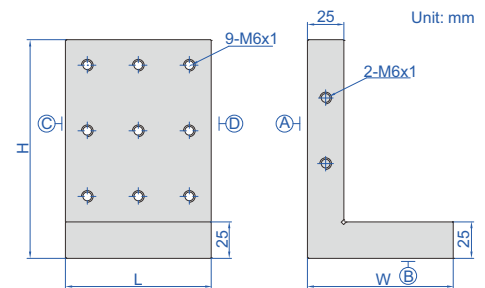

Code	Size (L×W×H)
6548-1	100×100×150mm



## RIGHT ANGLE PLATE

- Made of tool steel
- Hardened to HRC56-58
- Parallelism between A, B, C, D, E and F: 3μm
- Squareness between A, B, C, D, E and F: 5μm



6549-1

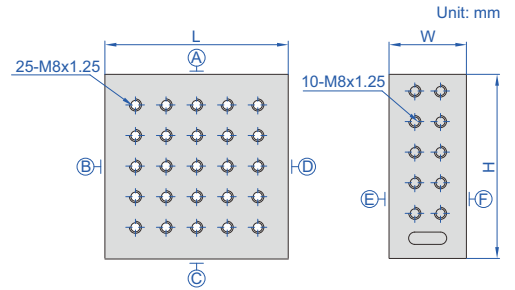

Code	Size (L×W×H)
6549-1	150×63×150mm

CAN BE CUSTOMIZED

## SINE BARS



4155-100

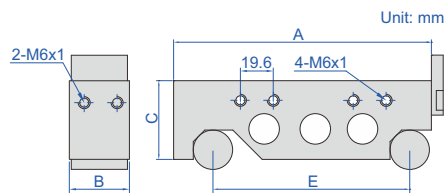

- Made of alloy tool steel

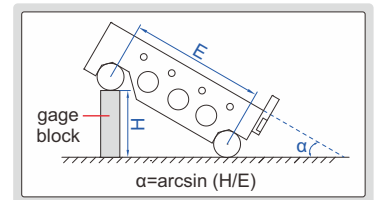

the front and back ends and two sides have mounting holes to install plate

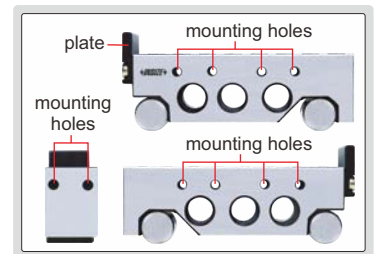

Code	Roller distance (E)	Table size (A×B)	C	Accuracy of α at 30°
4155-100	100mm	130×30mm	40mm	±5 seconds
4155-200	200mm	230×30mm	40mm	±5 seconds
4155-300	300mm	345×40mm	50mm	±8 seconds

## SINE BAR

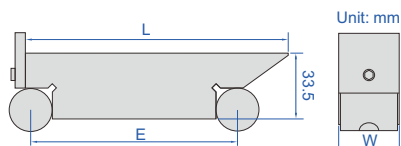

- Made of alloy tool steel



4158-100

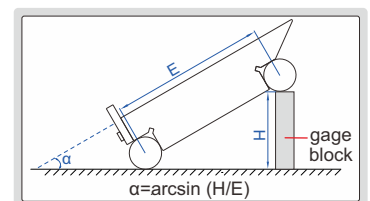

Code	Roller distance (E)	Table size (L×W)	Accuracy of α at 30°
4158-100	100mm	130×30mm	±5 seconds

## COMPOUND SINE TABLE



6536-100

- Accuracy of angle:  $\pm 15$  seconds
- Made of alloy tool steel
- Hardness HRC58-60

Code	Roller distance (E)	Table size (L×W)	Adjustable angle
6536-100	100mm	150×150mm	0-60°

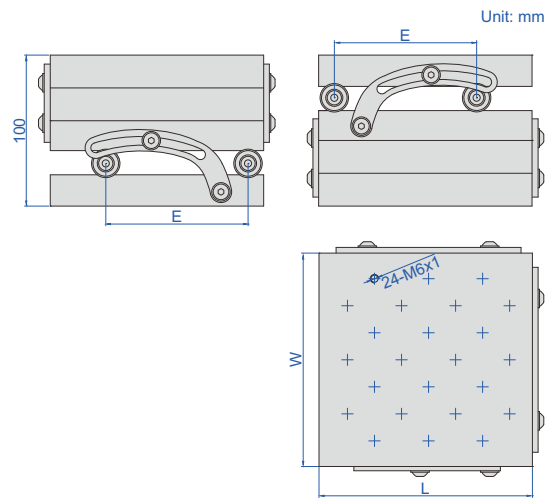

## SINE TABLE



6527-100

- Accuracy of angle:  $\pm 15$  seconds
- Made of alloy tool steel
- Hardness HRC58-60

Code	Roller distance (E)	Table size (L×W)	Adjustable angle
6527-100	100mm	150×150mm	0-60°

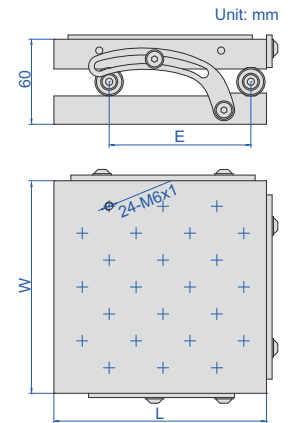

## MAGNETIC SINE TABLE



6538-100

ATTENTION:  
NOT HARDENED

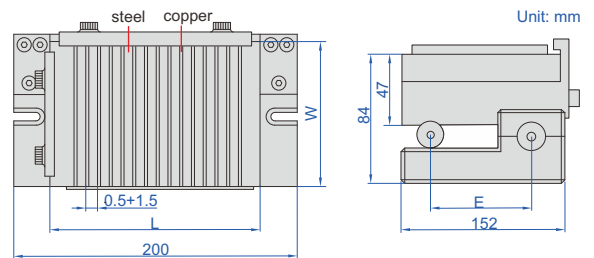

Code	Table size (L×W)	Roller distance (E)	Adjustable angle	Accuracy of angle
6538-100	150×150mm	100mm	0-60°	$\pm 15$ seconds

## PRECISION SINE VISES



6513-85

- Parallelism: 5µm/100mm
- Squareness: 5µm/100mm
- Accuracy of angle: ±20 seconds
- Made of alloy steel
- Hardness HRC58-60

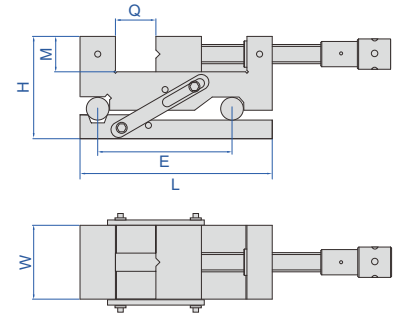

Code	Jaw opening (Q)	Jaw width (W)	Roller distance (E)	L	H	M
6513-65	0-65	50	100	150	85	25
6513-85	0-85	63	100	185	91.5	32
6513-100	0-100	73	150	205	105	35
6513-1001	0-100	80	150	215	108	40
6513-125	0-125	88	150	245	108	40
6513-1251	0-125	100	200	255	116	45
6513-160	0-160	125	200	295	125	50
6513-175	0-175	150	200	315	125	50

(mm)

## PRECISION SINE VISE

there is a 1mm step (accuracy +/-0.002mm). gage blocks smaller than 0.5mm are not available. if small gage blocks are needed (for example, 0.25mm), a gage block 1.25mm can be used in order to make 1.25mm-1mm=0.25mm

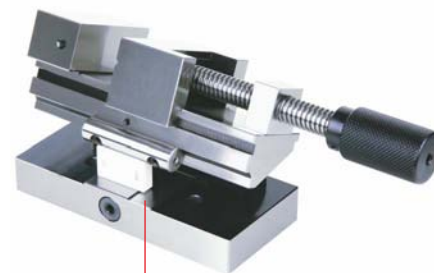

6523-80

- Parallelism: 3µm/100mm
- Squareness: 5µm/100mm
- Accuracy of angle: ±15 seconds
- Made of SKS tool steel, subzero treatment
- Hardness HRC58-60

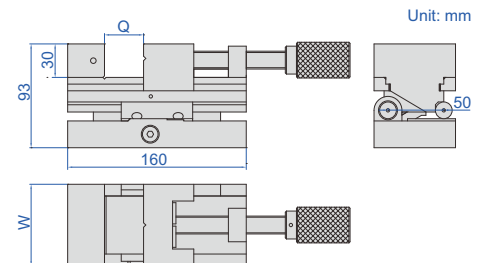

Code	Jaw opening (Q)	Jaw width (W)	Adjustable angle
6523-80	0-80mm	73mm	0-46°

## PRECISION COMPOUND SINE VISE

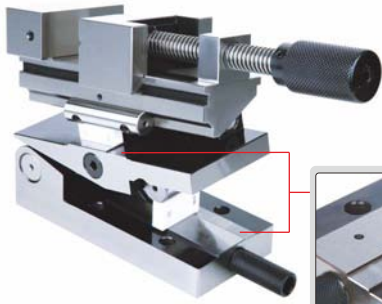

6524-80

there is a 1mm step (accuracy  $\pm 0.002\text{mm}$ ). gage blocks smaller than 0.5mm are not available. if small gage blocks are needed (for example, 0.25mm), a gage block 1.25mm can be used in order to make  $1.25\text{mm} - 1\text{mm} = 0.25\text{mm}$

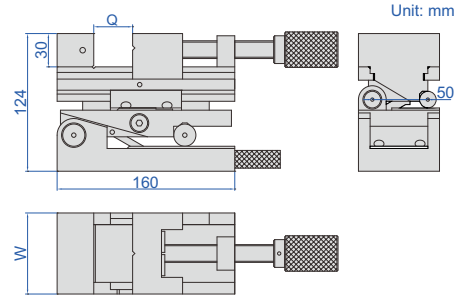
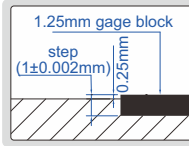

- Parallelism:  $3\mu\text{m}/100\text{mm}$
- Squareness:  $5\mu\text{m}/100\text{mm}$
- Accuracy of angle:  $\pm 15$  seconds
- Made of SKS tool steel, subzero treatment
- Hardness HRC58-60

Code	Jaw opening (Q)	Jaw width (W)	Adjustable angle
6524-80	0-80mm	73mm	0-46°

## PRECISION UNIVERSAL VISE

- Horizontal rotary: range  $360^\circ$ , graduation  $0.05^\circ$
- Vertical incline: range  $45^\circ$ , graduation  $0.05^\circ$
- With incline adjust knob
- Parallelism and squareness between A, B, C and D:  $5\mu\text{m}/100\text{mm}$ , parallelism between D and E at  $0^\circ$ :  $10\mu\text{m}/100\text{mm}$
- Made of tool steel
- Hardness HRC56-58

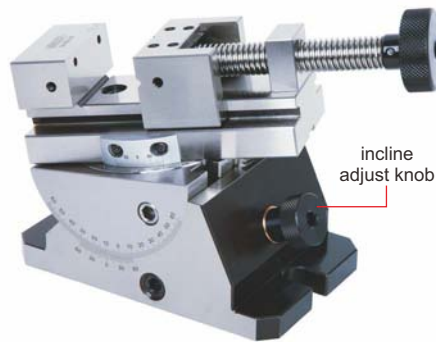

6521-80

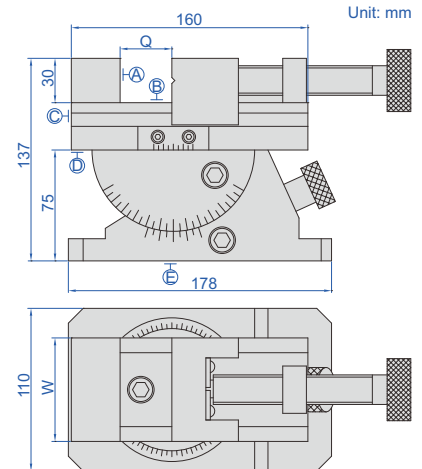

Code	Jaw opening (Q)	Jaw width (W)
6521-80	0-80mm	70mm

## PRECISION UNIVERSAL VISE WITH CHUCK

- Horizontal rotary: range  $360^\circ$ , graduation  $0.05^\circ$
- Vertical incline: range  $45^\circ$ , graduation  $0.05^\circ$
- With vertical incline adjust knob
- Runout of chuck is less than 0.05mm (test position is at less than 50mm from clamping jaws)
- The clamping jaws of chuck are reversible
- Made of tool steel
- Hardness HRC56-58

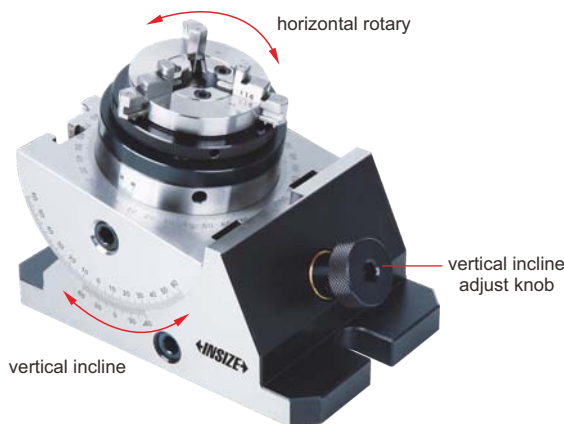

6528-85

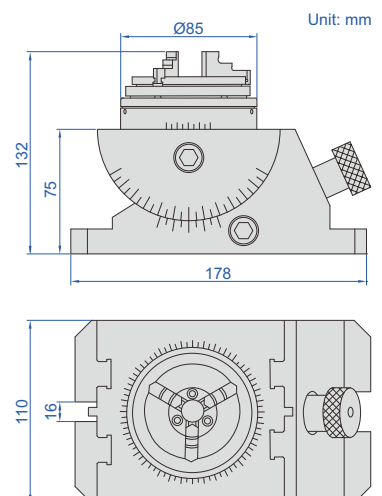

Code	Range of external clamping	Range of internal clamping
6528-85	$\text{Ø}0.8\text{--}\text{Ø}63\text{mm}$	$\text{Ø}23\text{--}\text{Ø}58\text{mm}$

## PRECISION VISES

- Parallelism: 5µm/100mm
- Squareness: 5µm/100mm
- Made of alloy steel
- Hardness HRC58-60

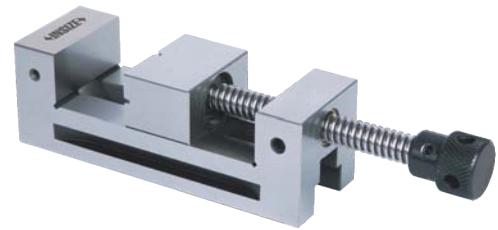

(mm)

Code	Jaw opening (Q)	Jaw width (W)	L	H	M
6520-36	0-36	38	115	48	25
6520-67	0-67	50	150	50	25
6520-87	0-87	63	185	63	32
6520-102	0-102	73	205	70	35
6520-1021	0-102	80	215	80	40
6520-127	0-127	88	245	80	40
6520-1271	0-127	100	255	90	45
6520-162	0-162	125	295	100	50
6520-175	0-175	150	315	100	50
6520-200	0-200	200	350	110	55

6520-87

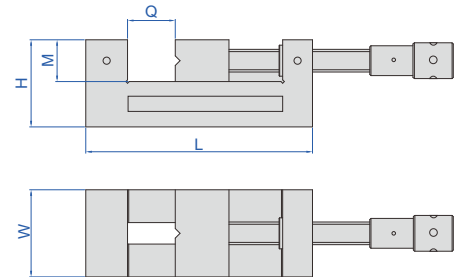

## QUICK MOVING PRECISION VISES

(mm)

Code	Jaw opening (Q)	Jaw width (W)	L	H	M
6526-20	0-20	25	65	29	9.3
6526-40	0-40	38	100	48	23
6526-65	0-65	50	135	50	25
6526-85	0-85	63	170	63	32
6526-100	0-100	73	185	70	35
6526-1001	0-100	80	195	80	40
6526-125	0-125	88	230	80	40
6526-1251	0-125	100	240	90	45
6526-160	0-160	125	280	100	50
6526-175	0-175	150	300	100	50
6526-208	0-208	200	350	110	55



6526-85

- Parallelism: 5µm/100mm
- Squareness: 5µm/100mm
- Made of alloy steel
- Hardness HRC58-60

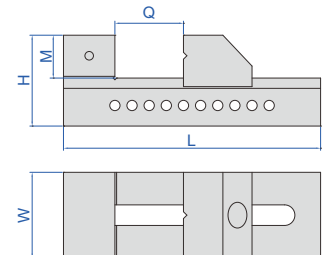

## ANVIL VISES

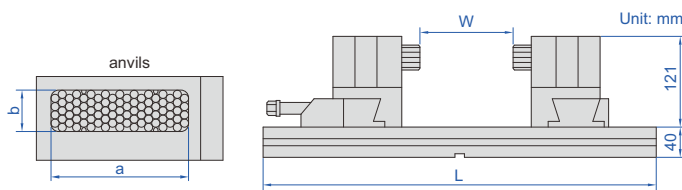

- The vise is used to fix workpieces during machining. The anvils are formed according to the shape of workpieces to be fixed, so the vise can fix workpieces quickly.
- The anvils are made of stainless steel (HRC20), can be customized to carbon steel (HRC40-45)
- Diameter of anvil: 6mm, stroke of anvil: 24mm
- Movement range of rotary clamp: 0-50mm

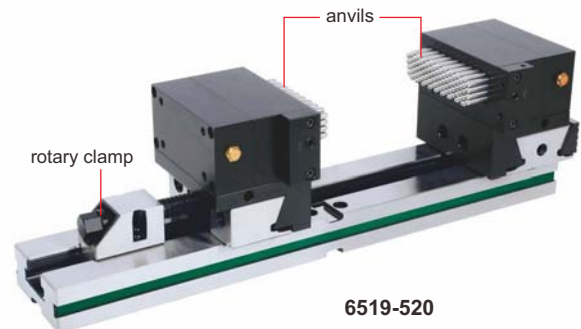

6519-520

application



Code	Guide length (L)	Clamp range (W)	Clamp force*	Weight	a	b
6519-520	520mm	0-190mm	6500N	22.5kg	100mm	30mm
6519-680	680mm	0-320mm	8000N	39.5kg	120mm	36mm

\* When all anvils contact the workpieces

## X-AXIS STAGES



6582-401

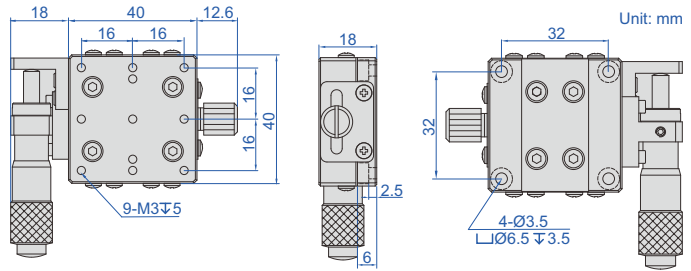

6582-602

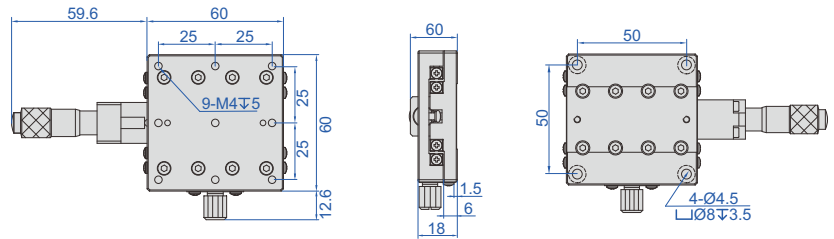

6582-903

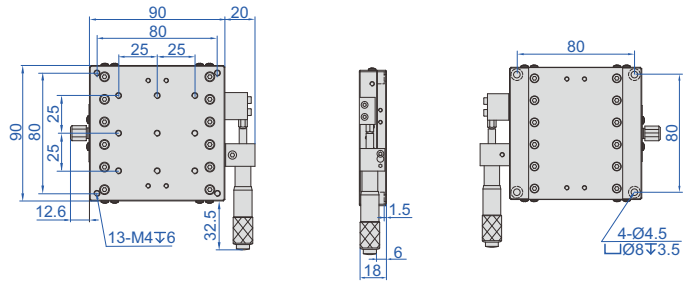

- Cross roller guides, achieve high precision and smooth movement
- Stages made of aluminum alloy

### SPECIFICATION (micrometer on the left)

Code	X-axis displacement	Parallelism of top to bottom surface	Micrometer graduation	Micrometer accuracy	Maximum load	Micrometer location	Stage size	Weight
6582-401	±6.5mm	0.02mm	0.01mm	0.01mm	29.4N (3kgf)	left	40x40mm	0.14kg
6582-601	±6.5mm	0.03mm	0.01mm	0.01mm	49N (5kgf)	left	60x60mm	0.24kg
6582-901	±12.5mm	0.03mm	0.01mm	0.02mm	93.1N (9.5kgf)	left	90x90mm	0.47kg
6582-1251	±12.5mm	0.04mm	0.01mm	0.02mm	180N (18.4kgf)	left	125x125mm	1.40kg

### SPECIFICATION (micrometer in the middle)

Code	X-axis displacement	Parallelism of top to bottom surface	Micrometer graduation	Micrometer accuracy	Maximum load	Micrometer location	Stage size	Weight
6582-402	±6.5mm	0.02mm	0.01mm	0.01mm	29.4N (3kgf)	middle	40x40mm	0.14kg
6582-602	±6.5mm	0.03mm	0.01mm	0.01mm	49N (5kgf)	middle	60x60mm	0.24kg
6582-902	±12.5mm	0.03mm	0.01mm	0.02mm	93.1N (9.5kgf)	middle	90x90mm	0.47kg
6582-1252	±12.5mm	0.04mm	0.01mm	0.02mm	180N (18.4kgf)	middle	125x125mm	1.40kg

### SPECIFICATION (micrometer on the right)

Code	X-axis displacement	Parallelism of top to bottom surface	Micrometer graduation	Micrometer accuracy	Maximum load	Micrometer location	Stage size	Weight
6582-403	±6.5mm	0.02mm	0.01mm	0.01mm	29.4N (3kgf)	right	40x40mm	0.14kg
6582-603	±6.5mm	0.03mm	0.01mm	0.01mm	49N (5kgf)	right	60x60mm	0.24kg
6582-903	±12.5mm	0.03mm	0.01mm	0.02mm	93.1N (9.5kgf)	right	90x90mm	0.47kg
6582-1253	±12.5mm	0.04mm	0.01mm	0.02mm	180N (18.4kgf)	right	125x125mm	1.40kg

## XY-AXIS STAGES

Unit: mm



6584-401

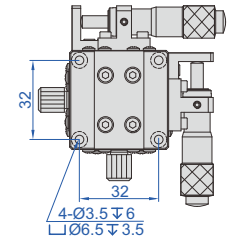
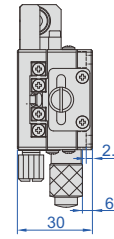
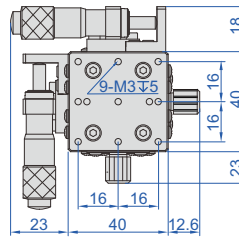

6584-602

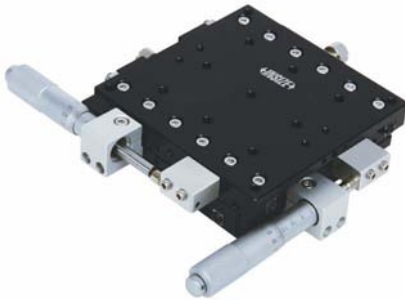
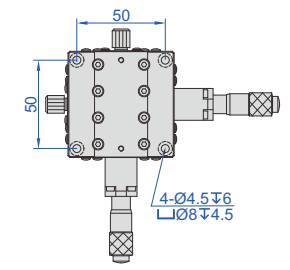
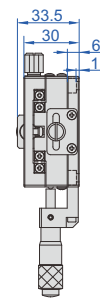
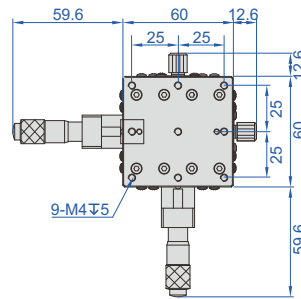

6584-903

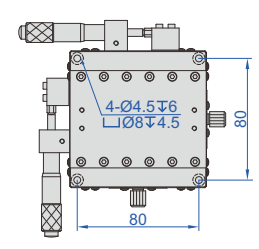
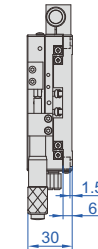
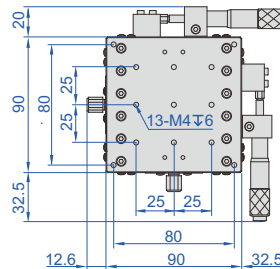

- Cross roller guides, achieve high precision and smooth movement
- Stages made of aluminum alloy

### SPECIFICATION (micrometer on the left)

Code	XY-axis displacement	Parallelism of top to bottom surface	Micrometer graduation	Micrometer accuracy	Maximum load	Micrometer location	Stage size	Weight
6584-401	±6.5mm	0.04mm	0.01mm	0.01mm	29.4N (3kgf)	left	40x40mm	0.27kg
6584-601	±6.5mm	0.06mm	0.01mm	0.01mm	49N (5kgf)	left	60x60mm	0.48kg
6584-901	±12.5mm	0.06mm	0.01mm	0.02mm	93.1N (9.5kgf)	left	90x90mm	1kg
6584-1251	±12.5mm	0.08mm	0.01mm	0.02mm	180N (18.4kgf)	left	125x125mm	2.8kg

### SPECIFICATION (micrometer in the middle)

Code	XY-axis displacement	Parallelism of top to bottom surface	Micrometer graduation	Micrometer accuracy	Maximum load	Micrometer location	Stage size	Weight
6584-402	±6.5mm	0.04mm	0.01mm	0.01mm	29.4N (3kgf)	middle	40x40mm	0.27kg
6584-602	±6.5mm	0.06mm	0.01mm	0.01mm	49N (5kgf)	middle	60x60mm	0.48kg
6584-902	±12.5mm	0.06mm	0.01mm	0.02mm	93.1N (9.5kgf)	middle	90x90mm	1kg
6584-1252	±12.5mm	0.08mm	0.01mm	0.02mm	180N (18.4kgf)	middle	125x125mm	2.8kg

### SPECIFICATION (micrometer on the right)

Code	XY-axis displacement	Parallelism of top to bottom surface	Micrometer graduation	Micrometer accuracy	Maximum load	Micrometer location	Stage size	Weight
6584-403	±6.5mm	0.04mm	0.01mm	0.01mm	29.4N (3kgf)	right	40x40mm	0.27kg
6584-603	±6.5mm	0.06mm	0.01mm	0.01mm	49N (5kgf)	right	60x60mm	0.48kg
6584-903	±12.5mm	0.06mm	0.01mm	0.02mm	93.1N (9.5kgf)	right	90x90mm	1kg
6584-1253	±12.5mm	0.08mm	0.01mm	0.02mm	180N (18.4kgf)	right	125x125mm	2.8kg

## Z-AXIS STAGE CODE 6586-60

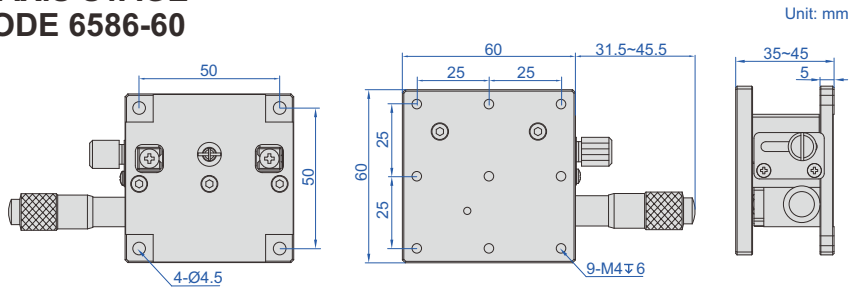

- Cross roller guides, achieve high precision and smooth movement
- Stage made of aluminum alloy

### SPECIFICATION

Code	Z-axis displacement	Parallelism of top to bottom surface	Micrometer graduation	Micrometer accuracy	Maximum load	Stage size	Weight
6586-60	10mm	0.05mm	0.01mm	0.02mm	20.4N (3kgf)	60x60mm	0.27kg

## XZ-AXIS STAGE CODE 6587-60

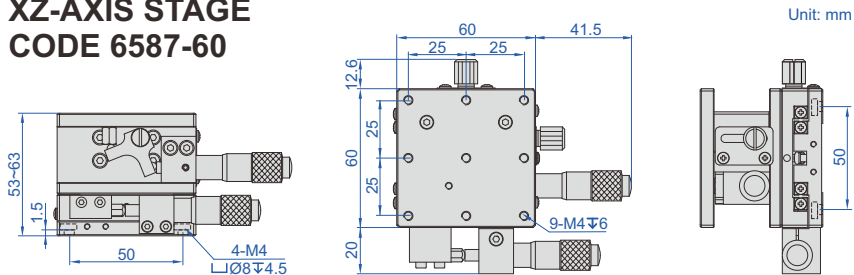

- Cross roller guides, achieve high precision and smooth movement
- Stage made of aluminum alloy

### SPECIFICATION

Code	X-axis displacement	Z-axis displacement	Micrometer graduation	Maximum load	Stage size	Weight
6587-60	±6.5mm	10mm	0.01mm	29.4N (3kgf)	60x60mm	0.51kg

## XYZ-AXIS STAGE CODE 6585-60

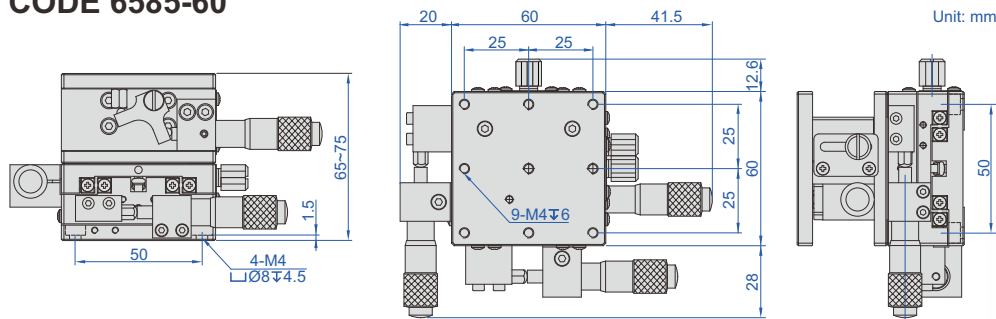

- Cross roller guides, achieve high precision and smooth movement
- Stage made of aluminum alloy

### SPECIFICATION

Code	XY-axis displacement	Z-axis displacement	Micrometer graduation	Maximum load	Stage size	Weight
6585-60	±6.5mm	10mm	0.01mm	29.4N (3kgf)	60x60mm	0.75kg



## ROTARY STAGES



6583-60H

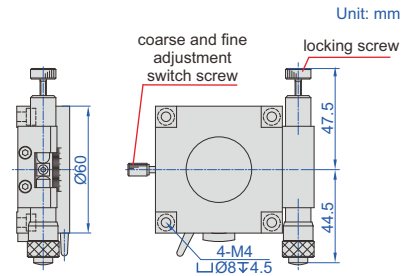
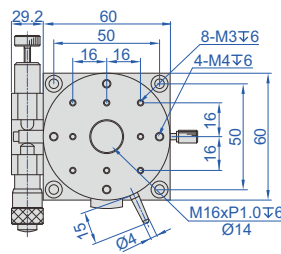

6583-90

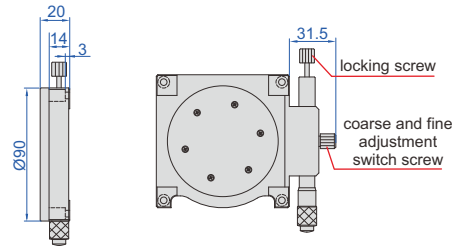
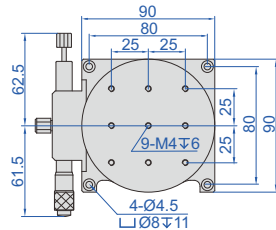

- Precise angle adjustment
- Coarse and fine adjustments
- Stages made of aluminum alloy

### SPECIFICATION

Code	Range	Parallelism of top to bottom surface	Concentricity	Rotation accuracy	Maximum load	Stage size	Weight
6583-60H	360° coarse, ±5° fine	0.03mm	0.03mm	12 seconds	29.4N (3kgf)	Ø60mm	0.30kg
6583-90	360° coarse, ±5° fine	0.04mm	0.03mm	5 seconds	29.4N (3kgf)	Ø90mm	0.50kg

## XY-AXIS ROTARY STAGE CODE 6588-60

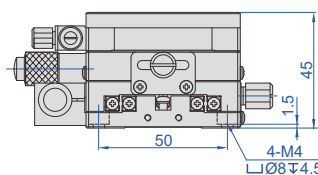
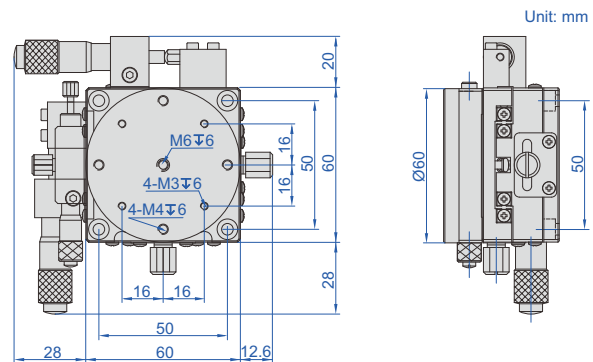

- Cross roller guides, achieve high precision and smooth movement
- Coarse and fine adjustments
- Precise angle adjustment
- Stage made of aluminum alloy

### SPECIFICATION

Code	XY-axis displacement	Rotation range	Micrometer graduation	Rotation accuracy	Maximum load	Stage size	Weight
6588-60	±6.5mm	360° coarse, ±5° fine	0.01mm	10 seconds	29.4N (3kgf)	60x60mm	0.64kg



**Video Measuring Instrument For Machine Tools**  
Page 475-476



**Centering Indicators**  
Page 477-478



**Edge Finders**  
Page 478-480



**Edge Finders For EDM**  
Page 481



**3D Testers**  
Page 482-483



**Trigger-Type 3D Probes**  
Page 484



**Infrared Transmission Probes For CNC Machine Tools**  
Page 485-488



**Zero Setters With Cable**  
Page 489-491



**Zero Setters**  
Page 492



**Zero Setters**  
Page 493-494



## VIDEO MEASURING INSTRUMENT FOR MACHINE TOOLS

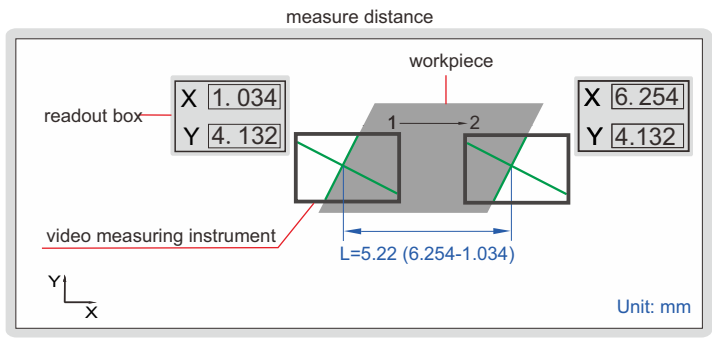
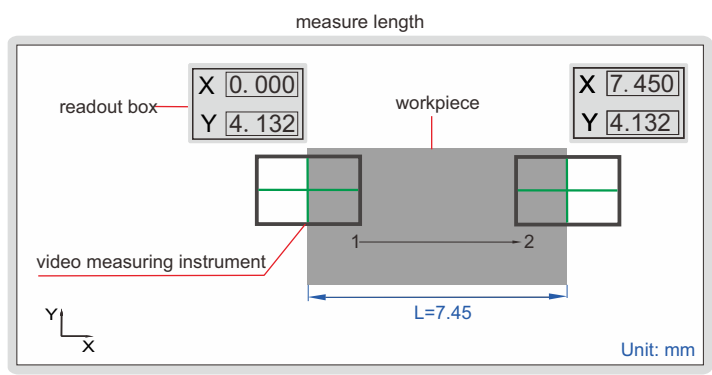
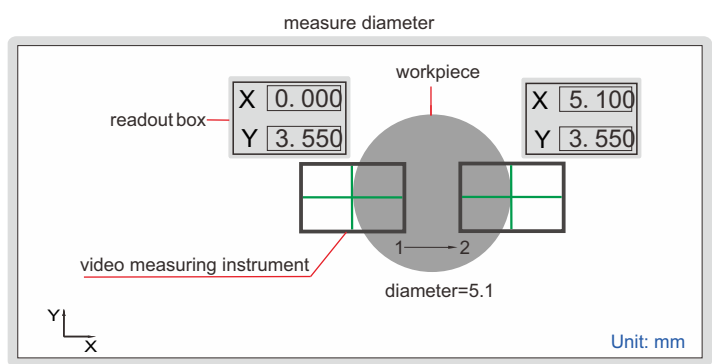
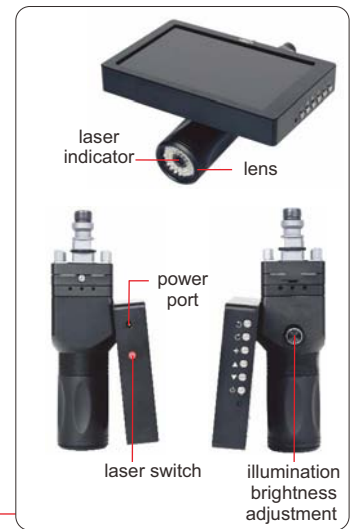

- Used in machine tools such as EDM and CNC
- Working together with linear scale and readout box of machine tools to make 2D measurement, especially suitable for small or thin parts
- Can rotate crosshair and change its color
- With laser indicator to locate position

To be continued

Continued from previous page

**SPECIFICATION**

<b>Code</b>	<b>5314-R31</b>	<b>5314-R32</b>	<b>5314-R33</b>	<b>5314-R34</b>
<b>Adapter</b>	EROWA	3R	multifunction	magnet
<b>Screen size/pixel</b>	7"/1080P			
<b>Visual accuracy</b>	±0.003mm			
<b>Magnification</b>	50X			
<b>Angle resolution</b>	15'			
<b>Automatic edge-find</b>	after finding the edge, the crosshair changes to green color and prompts			
<b>Color of crosshair</b>	red, blue			
<b>Rotation of crosshair</b>	manual			
<b>Focus distance</b>	50mm			
<b>Light source</b>	LED (adjustable brightness)			
<b>Lithium battery</b>	4800mA (for 4 hours working)			
<b>Power supply</b>	power adapter			
<b>Dimension (LxWxH)</b>	178x90x215mm			
<b>Weight</b>	2kg			

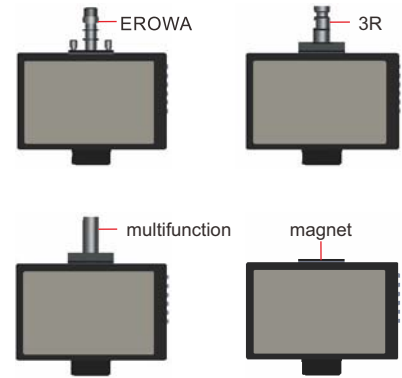

**STANDARD DELIVERY**

<b>Main unit</b>	1 pc
<b>Power adapter</b>	1 pc

select crosshair color

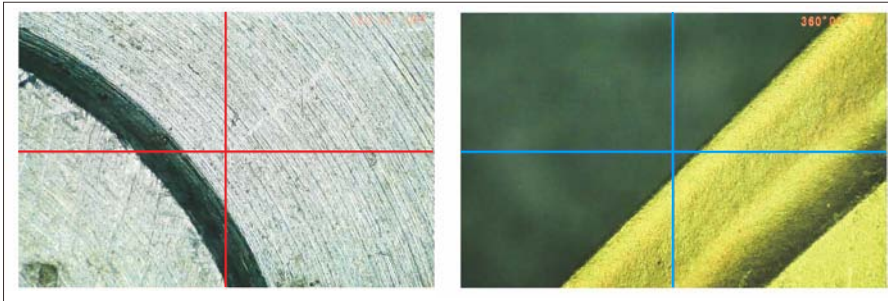

rotate crosshair

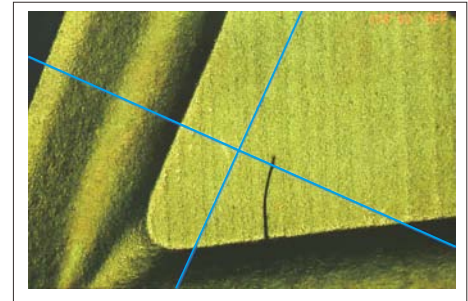

laser indicator locates the central point

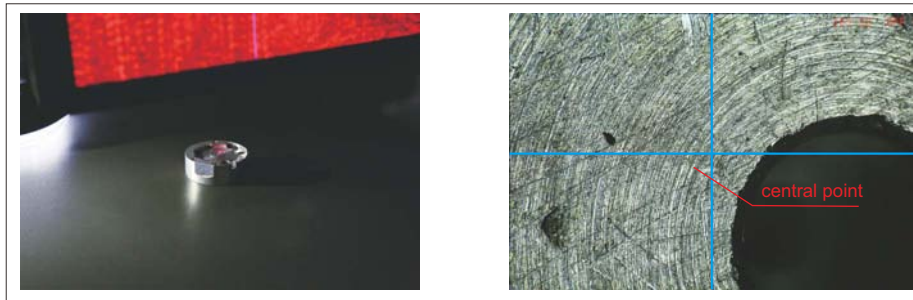

after finding the edge, the crosshair changes to green color and prompts

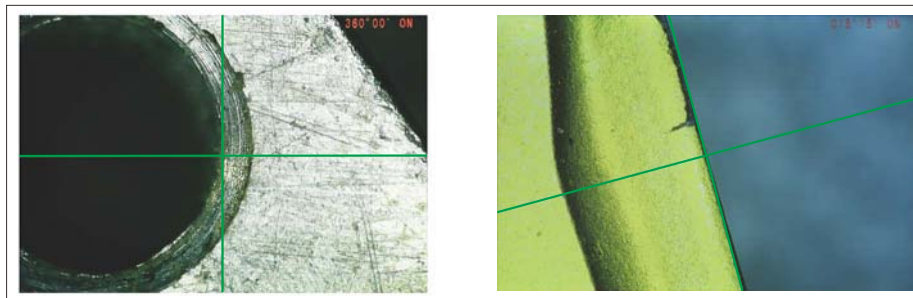

READING SHOWS MOVEMENT VALUE OF PROBE

## CENTERING INDICATOR

**INSIZE PLUS**  
MADE IN EUROPE

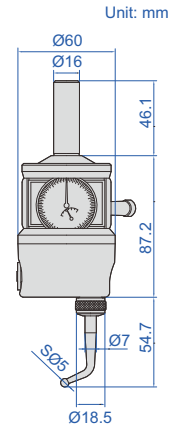
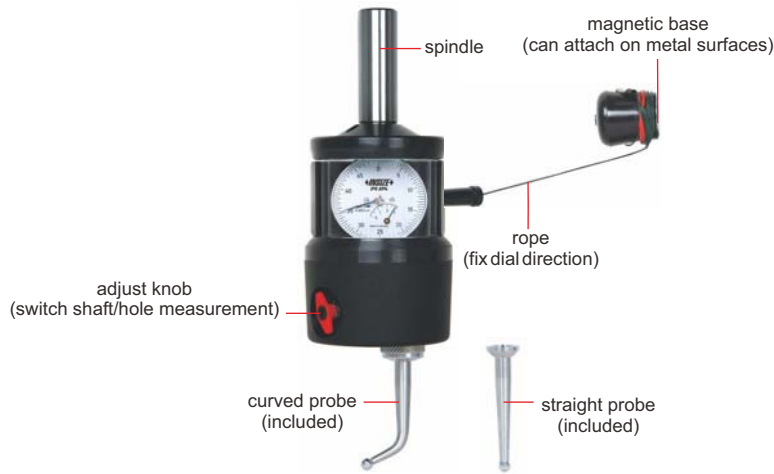

2847-3

- Provides quick and accurate shaft/hole centering in boring and milling set-up, can also measure squareness between workpiece and spindle
- Dial indicator can rotate 360°
- Reading show movement value of probe, for example, if probe moves 0.01mm, reading changes 0.01mm (2 graduations)
- Optional accessory: probes

application

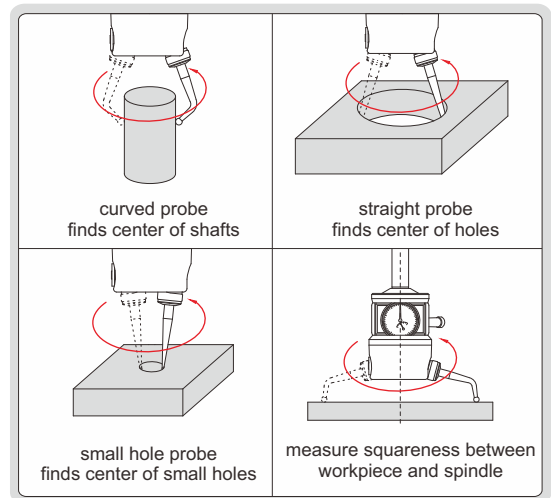

Code	Graduation	Travel
2847-3	0.005mm	2.5mm

### SPECIFICATION OF PROBE

Description	Measurement type	Diameter measurement	Depth measurement	Accuracy
straight probe (included)	hole center	Ø6-125mm	55mm	0.005mm
	squareness	Ø120-160mm	40mm	
small hole probe (optional)	small hole center	Ø2-125mm	55mm	
	squareness	Ø120-160mm	40mm	
curved probe (included)	shaft center	Ø0-125mm	55mm	0.005mm
	squareness	Ø120-160mm	40mm	

### PROBE (optional)

Code	Description
2847-P1	straight probe
2847-P2	small hole probe
2847-P3	curved probe

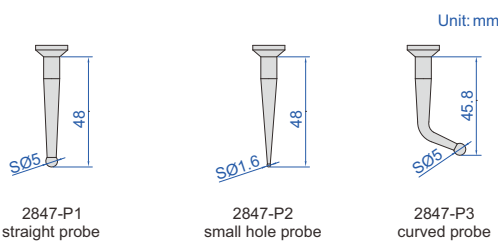

**CENTERING INDICATOR**



**POPULAR MODEL**



**2385-3**

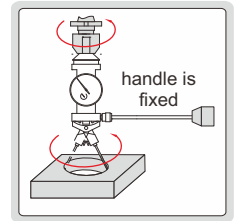
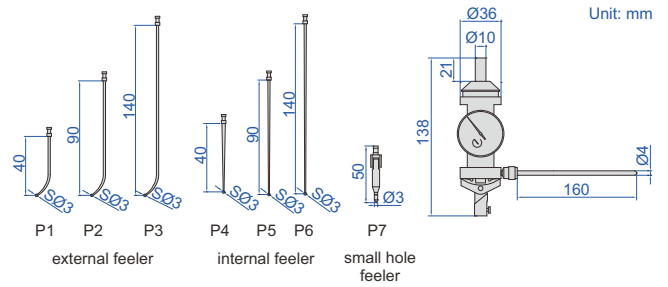

- Provides quick and accurate centering in boring and milling set-up
- Maximum speed is recommended not to exceed 800rpm

Feeler	Measuring diameter	Accuracy
P1	Ø0-60mm	0.015mm
P2	Ø0-160mm	0.02mm
P3	Ø0-250mm	0.03mm
P4	Ø3.2-80mm	0.015mm
P5	Ø3.2-180mm	0.02mm
P6	Ø3.2-280mm	0.03mm
P7	Ø0-2.8mm	0.015mm

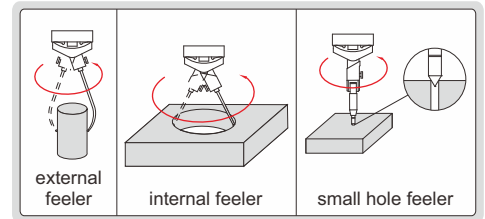

**Code**

**2385-3**

**3D ELECTRONIC EDGE FINDERS**

**INSIZE PLUS**  
MADE IN EUROPE

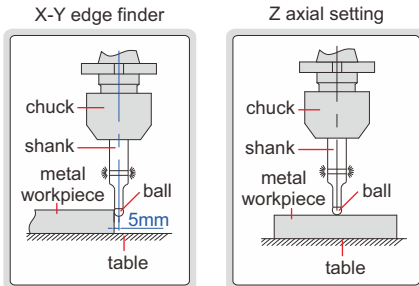

**6571-1**

**6571-2**

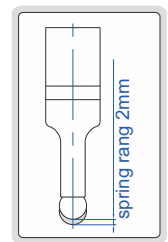

- The shank is electrically conducted to the metal workpiece through the chuck and table. The LED lights up, when the ball touches the workpiece
- Not suitable for rotary use
- Hardened contact ball

Code	Shank	Contact ball	Accuracy	Battery
6571-1	Ø16mm	SØ10mm	10µm	23A, 12Vx1 pc
6571-2	Ø20mm	SØ10mm	10µm	23A, 12Vx1 pc

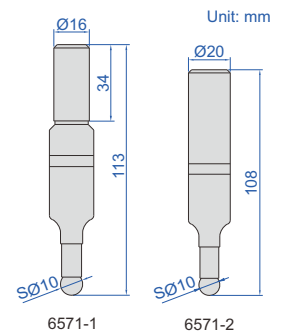

## LARGE SHANK ELECTRONIC EDGE FINDERS

- The shank is electrically conducted to the metal workpiece through the chuck and table. The LED lights up and the beeper sounds (only for **6572-2**), when the ball touches the workpiece
- Not suitable for rotary use
- Hardened shank and contact ball

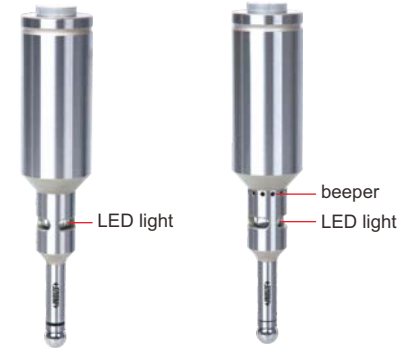
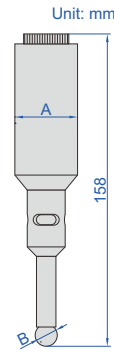
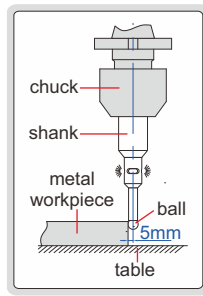

6572-1

6572-2

Code	Shank (A)	Contact ball (B)	Accuracy	Beeper	Battery
6572-1	Ø32mm	SØ10mm	5µm	without	23A, 12V×1 pc
6572-2	Ø32mm	SØ10mm	5µm	with	23A, 12V×1 pc

## ELECTRONIC EDGE FINDERS

- The shank is electrically conducted to the metal workpiece through the chuck and table. The LED lights up and the beeper sounds (only for **6566-3**), when the ball touches the workpiece
- Not suitable for rotary use
- Hardened shank and contact ball

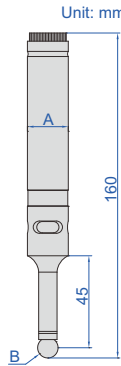
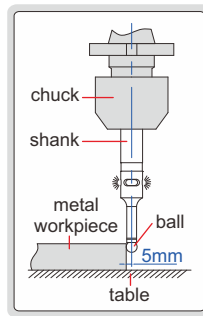

6566-2

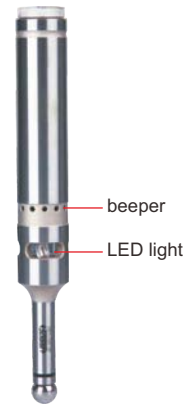

6566-3

Code	Shank (A)	Contact ball (B)	Accuracy	Beeper	Battery
6566-2	Ø20mm	SØ10mm	5µm	without	23A, 12V×1 pc
6566-3	Ø20mm	SØ10mm	5µm	with	23A, 12V×1 pc

## NON-MAGNETIC EDGE FINDERS

- TiAlN coating, non-magnetic, hardness HV2500, extremely wear resistance
- Suitable for machine speed 400~600rpm

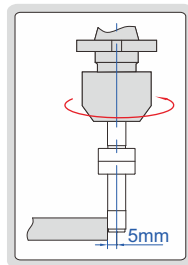

6573-1

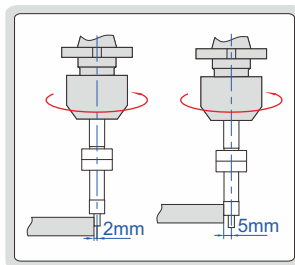

6573-2



6573-1

6573-2

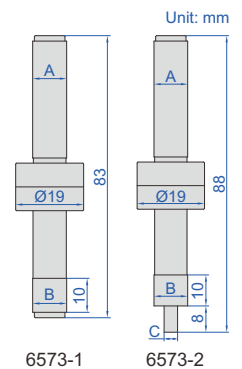

6573-1

6573-2

Code	Shank (A)	Contact point (B)	Contact point (C)	Accuracy
6573-1	Ø10mm	Ø10mm	—	5µm
6573-2	Ø10mm	Ø10mm	Ø4mm	5µm

## EDGE FINDERS

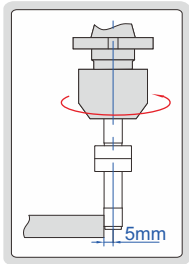

6562-3

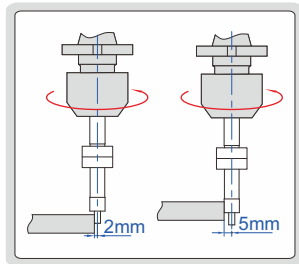

6562-4



6562-3

6562-4

- Hardened shank and contact point
- Suitable for machine speed 400~600rpm

Code	Shank (A)	Contact point (B)	Contact point (C)	Accuracy
6562-3	Ø10mm	Ø10mm	—	5µm
6562-4	Ø10mm	Ø10mm	Ø4mm	5µm

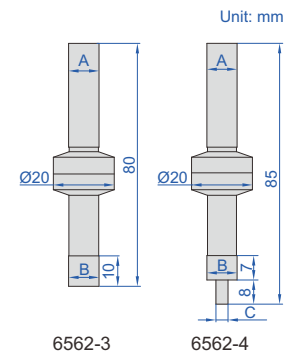

## EDGE FINDER

- Hardened shank and contact point
- Suitable for machine speed 400~600rpm

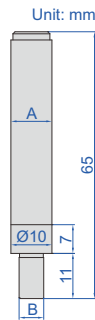

6567-1

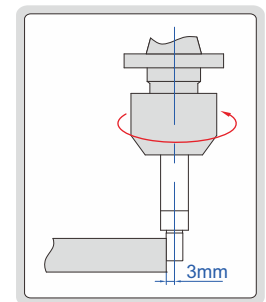

Code	Shank (A)	Contact point (B)	Accuracy
6567-1	Ø10mm	Ø6mm	8µm

## CERAMIC EDGE FINDER

- Ceramic contact point, non magnetic
- Suitable for machine speed 400~600rpm

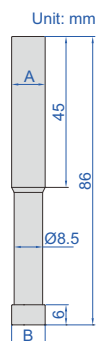

6568-1

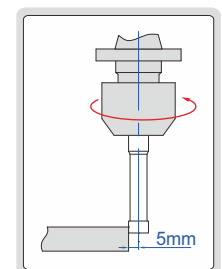

Code	Shank (A)	Contact point (B)	Accuracy
6568-1	Ø10mm	Ø10mm	8µm



## EDGE FINDERS FOR EDM

CAN BE  
CUSTOM-MADE

spindle type

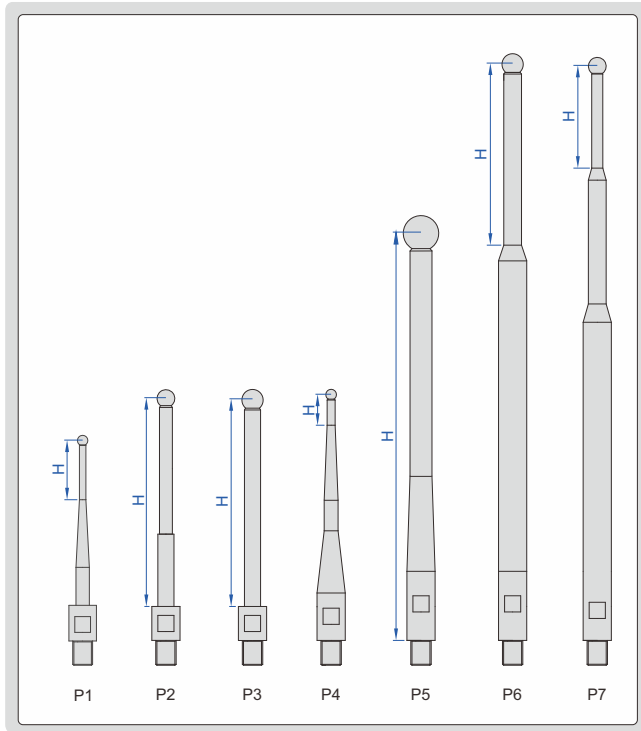

6558-52

- To locate workpieces
- Buzzer in EDM sounds when the ball touches the workpiece
- Tungsten steel ball, diameter accuracy:  $\pm 0.003\text{mm}$
- Non magnetic stainless steel spindle
- Magnetic base

(mm)

Code	Ball dia. (SØD)	Spindle length (L)	Measuring depth (H)	Spindle type
6558-11	SØ1	69	5	P4
6558-21	SØ2	49	6	P1
6558-22	SØ2	69	6	P4
6558-23	SØ2	119	8	P4
6558-31	SØ3	48	6	P1
6558-32	SØ3	68	7	P4
6558-33	SØ3	118	10	P4
6558-41	SØ4	48	37	P3
6558-42	SØ4	68	57	P2
6558-43	SØ4	118	16	P4
6558-44	SØ4	168	28	P7
6558-51	SØ5	47	36	P3
6558-52	SØ5	67	56	P2
6558-53	SØ5	117	106	P2
6558-54	SØ5	167	46	P6
6558-61	SØ6	47	35	P3
6558-62	SØ6	67	56	P3
6558-63	SØ6	87	76	P3
6558-64	SØ6	117	107	P2
6558-65	SØ6	167	51	P6
6558-81	SØ8	46	46	P5
6558-82	SØ8	66	54	P3
6558-83	SØ8	116	105	P3
6558-84	SØ8	166	51	P6
6558-101	SØ10	45	34	P3
6558-102	SØ10	65	53	P3
6558-103	SØ10	115	114	P5
6558-104	SØ10	165	53	P6

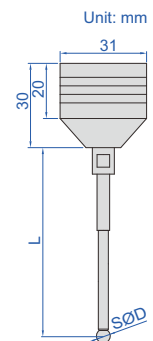

## DIGITAL 3D TESTER

**INSIZE PLUS**  
MADE IN EUROPE

**IP65**  
WATERPROOF

**SHOCK**  
PROOF



if the probe is pressed too much, the probe breaks at the breaking point, in order to prevent damage of the main body

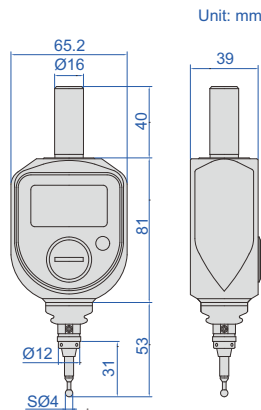
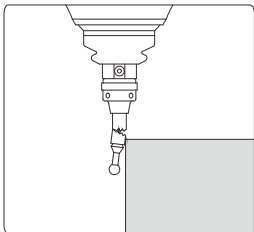

- Shockproof, IP65 dust/waterproof
- Mainly used for milling machines and CNC machine tools
  1. determine coordinate point on workpieces
  2. find center of holes
  3. adjust and position workpieces
- Can be used to measure length and depth
- Reading shows movement value of probe.  
for example, if probe moves 0.01mm, reading changes 0.01mm
- Large working range on three axes (X, Y, Z), which avoids damage of probes due to collision by mistake
- Optional accessory: probe (code **2840-N1**)

Code	Range	Resolution	Repeatability at zero (one direction)	X, Y, Z range
2846-3D	±2mm	0.005mm	±0.005mm	6mm

find center of holes

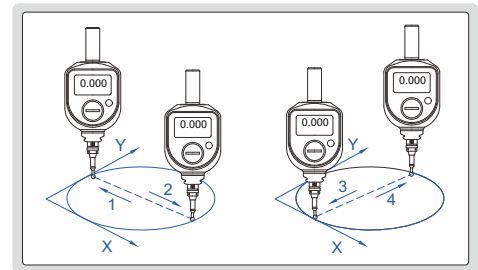

length measurement

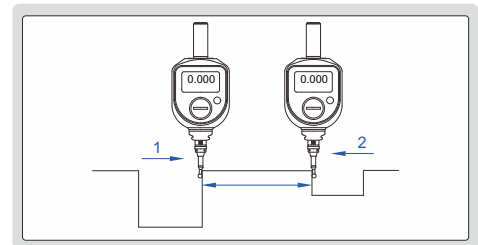

depth measurement

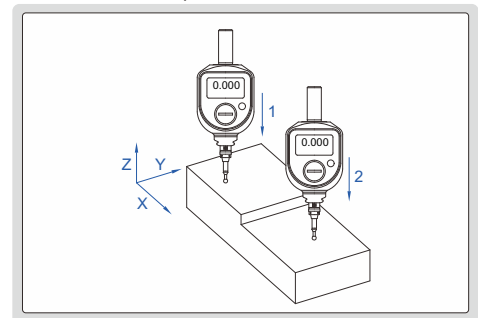

position workpieces

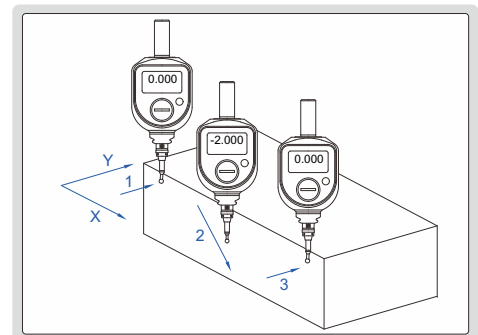

**ATTENTION: WHEN USING STANDARD PROBE, READING SHOWS MOVEMENT VALUE OF PROBE. WHEN USING EXTENDED PROBE, READING DOES NOT SHOW MOVEMENT VALUE OF PROBE**

**IP67**  
WATERPROOF

**SHOCK**  
PROOF

**3D TESTER**  
**INSIZE PLUS**  
MADE IN EUROPE

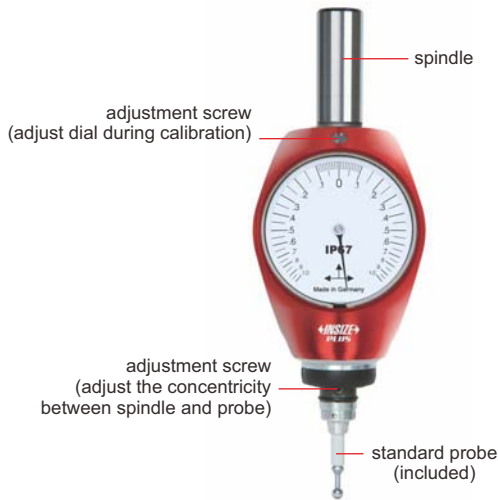

**2840-3D**

if the probe is pressed too much, the probe breaks at the breaking point, in order to prevent damage of the main body

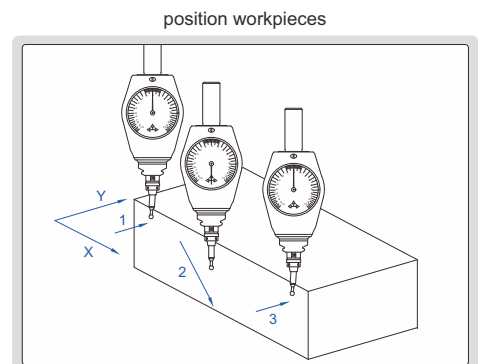
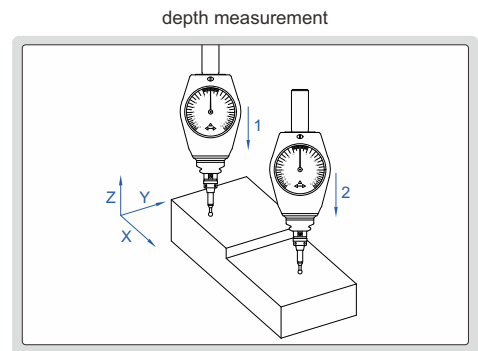
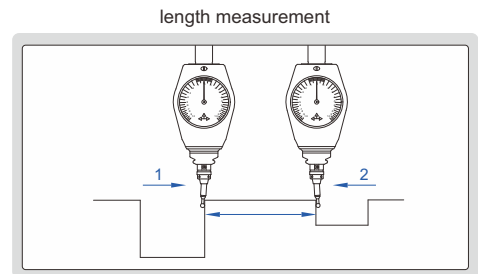
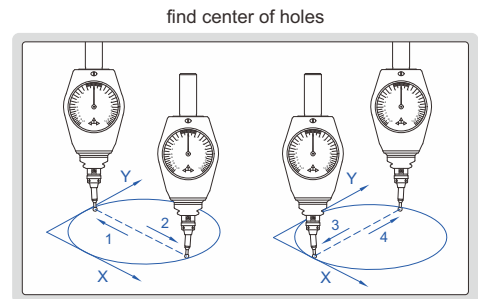
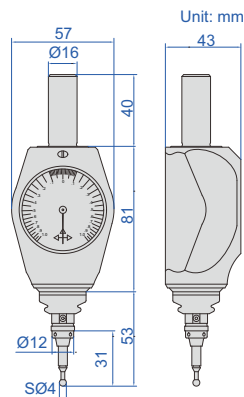
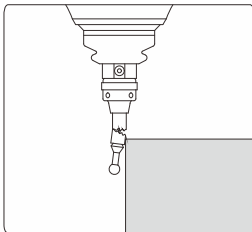

- Shockproof, IP67 dust/waterproof
- Mainly used for milling machines and CNC machine tools
  - determine coordinate point on workpieces
  - find center of holes
  - adjust and position workpieces
- Can be used to measure length and depth
- When using standard probe, reading shows movement value of probe, for example, if probe moves 0.05mm, reading changes 0.05mm (5 graduations). When using extended probe, reading does not show movement value of probe
- Large working range on three axes (X, Y, Z), which avoids damage of probes due to collision by mistake

Code	Range	Graduation	Repeatability at zero (one direction)	X, Y, Z range
2840-3D	±1.0mm	0.01mm	±0.01mm	6mm

**PROBE (optional)**

Code	Description	L	D
2840-N1	standard probe	31mm	SØ4mm
2840-N2	extended probe	56.6mm	SØ6mm

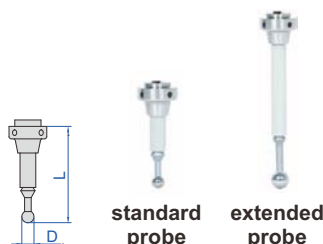

# TRIGGER-TYPE 3D PROBE (AUDIBLE AND VISUAL ALARM) CODE 9410

**IP67**  
WATERPROOF

type-C charging cable (included)



signal extension cord (included)



- Suitable for all kinds of machining centers, CNC boring machines, milling machines, drilling and tapping centers
- Suitable for workpiece detection of various solid materials
- Manually set the workpiece coordinates and machining reference points before CNC machining process
- In the process of CNC machining, manually detect and control key dimensions and position coordinates and their accuracy
- Detect the accuracy of the key size, shape and position of the workpiece after completion of CNC machining
- Standard Ø20mm shank diameter, held by CNC
- LED indicator and buzzer indicate the trigger state of the probe
- Using lithium battery charging technology, no need to replace the battery
- The battery (5% utilization rate per shift) can be used continuously for 90 days
- Type-C interface
- Optional accessory: styli and extension bar

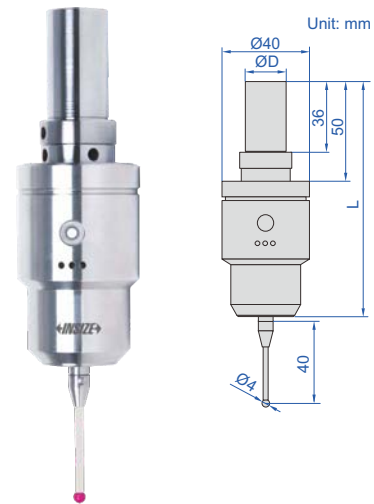

application

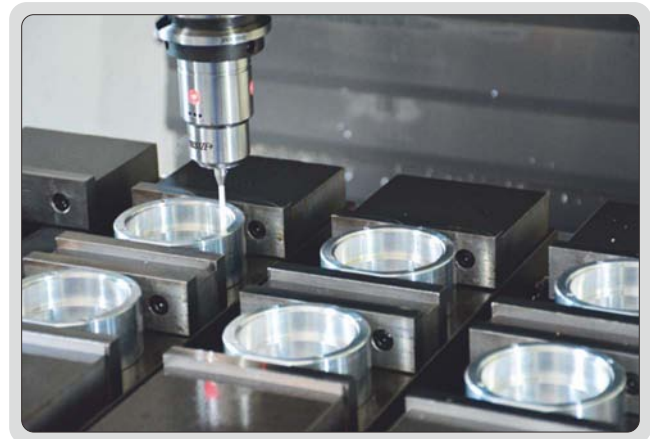

## SPECIFICATION

Probe length (L)	115.5mm
Shank diameter (ØD)	20mm
Trigger direction	±X, ±Y, +Z
Directional trigger protection stroke	X-Y: ±12°, Z: +5mm
Arbitrary one-way repeated trigger accuracy	≤1µm
Trigger force in X-Y direction (with standard styli)	0.3-0.6N
Trigger force in Z direction	4N
Dust/waterproof	IP67
Type-C charging cable	1.5m
Signal extension cord (provide signals to CNC)	1m

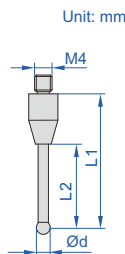
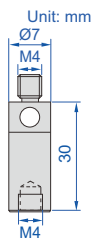

## EXTENSION ROD (OPTIONAL)

Code	Material
9410-R1	ceramic

## STYLI (OPTIONAL)

(mm)

Code	L1	L2	Ød	Material of rod *	Material of ball
9410-P1	18	13	4	stainless steel	ruby
9410-P2	18	13.5	5	stainless steel	ruby
9410-P3	18.5	13	3	stainless steel	ruby
9410-P4	19	8	2	carbide	ruby
9410-P5	19.5	4	1	carbide	ruby
9410-P6	50	40	2	carbide	ruby
9410-P7	50	34	5	ceramic	ruby
9410-P8	100	86	6	ceramic	ruby
9410-P9	40	30	4	ceramic	ruby
9410-P10	50	36	6	ceramic	ruby

\* For stainless steel or carbide rods, it is recommended to use extension rods to protect spindles in case of break



# INFRARED TRANSMISSION PROBES FOR CNC MACHINE TOOLS

**IP68**  
WATERPROOF

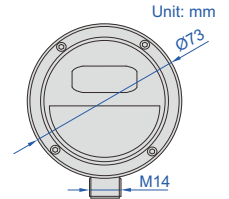
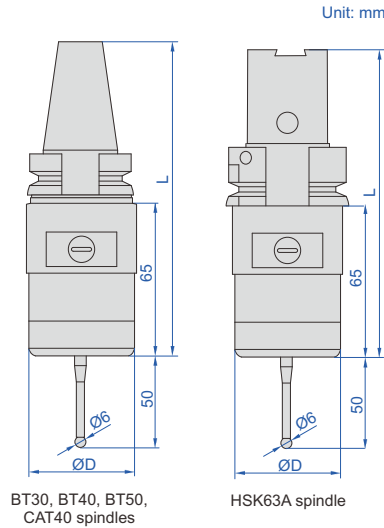

- On-machine measurement of all kinds of small and medium-sized machining centers, CNC boring, milling machines and five-axis CNC machine tools
- Automatically set the workpiece coordinate and machining reference point before CNC machining process
- Automatically measure dimension and position coordinate during CNC machining
- Measure dimension, shape and position after CNC machining is completed
- Four kinds of SSR signals such as probe status, error, low voltage and pulse are transmitted to CNC machine tools
- M code is used to control on or off of probes
- Infrared transmission, strong anti-interference
- Infrared transmission/reception range: 5m
- Supplied with automatic measurement software
- Optional accessory: styli

## PROBE SPECIFICATION

Code	9413-1	9413-2	9413-3	9413-4	9413-5
Probe length (L)	140mm	166mm	216mm	168mm	136mm
Probe diameter (ØD)	48mm	48mm	48mm	48mm	48mm
Applicable spindle *	BT30	BT40	BT50	CAT40	HSK63A
Trigger accuracy of styli in any direction	1µm				
Protection stroke triggered by styli in all directions	X and Y axis stroke: ±12.5°, Z axis stroke: 5mm				
Trigger force of styli in all directions	X and Y axis: 1-1.6N, Z axis: 5-10N				
Dust/waterproof	IP68				
Power supply	2×LS14250 lithium battery				

\* SK and ISO spindle probes also can be customized

## RECEIVER SPECIFICATION

Code	9413-A
Protection function	low battery voltage or probe transmitting signal all the time**
Applicable probe	code 9413-1, 9413-2, 9413-3, 9413-4, 9413-5
Cable length	8m
Dust/waterproof	IP68
Power supply	input voltage: 24V±10% (DC), load current: 50mA

\*\* When battery voltage is low or probe is in wrong state, receiver sends a signal to CNC machine to stop working

To be continued

Continued from previous page

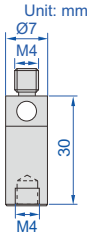
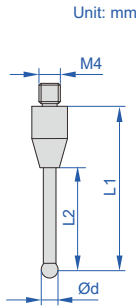

### EXTENSION ROD (OPTIONAL)

Code	Material
9410-R1	ceramic

### STYLI (OPTIONAL)

(mm)

Code	L1	L2	Ød	Material of rod ***	Material of ball
9410-P1	18	13	4	stainless steel	ruby
9410-P2	18	13.5	5	stainless steel	ruby
9410-P3	18.5	13	3	stainless steel	ruby
9410-P4	19	8	2	carbide	ruby
9410-P5	19.5	4	1	carbide	ruby
9410-P6	50	40	2	carbide	ruby
9410-P7	50	34	5	ceramic	ruby
9410-P8	100	86	6	ceramic	ruby
9410-P9	40	30	4	ceramic	ruby
9410-P10	50	36	6	ceramic	ruby

\*\*\* For stainless steel or carbide rods, it is recommended to use extension rods to protect spindles in case of break

application

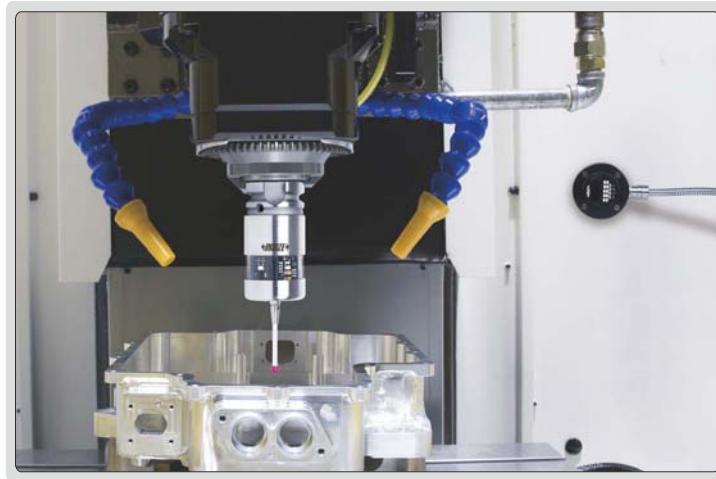

### AUTOMATIC MEASUREMENT SOFTWARE (INCLUDED)

1. Stylus automatic calibration
2. Protection of stylus during probe movement (avoid collision)
3. Groove and boss measurement

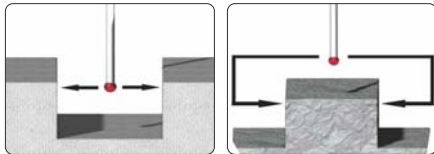

5. X or Y single-surface measurement



7. 4th axis measurement
8. Angle on X and Y plane measurement
9. Three points measurement of arc

4. Bore and axis measurement

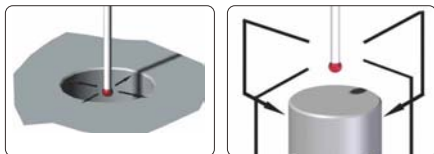

6. Internal and external corner measurement

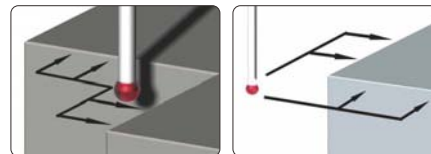

10. Measure the distance between two holes

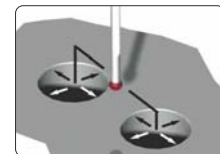

## INFRARED TRANSMISSION PROBES FOR CNC MACHINE TOOLS (CAN BE USED IN COMBINATION WITH ZERO SETTER WITH INFRARED TRANSMISSION)

**IP68**  
WATERPROOF

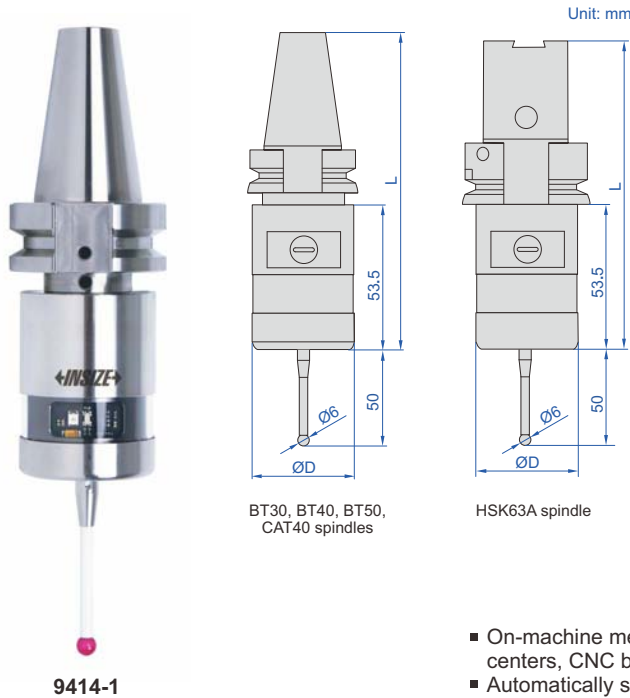

BT30, BT40, BT50,  
CAT40 spindles

HSK63A spindle



9414-A

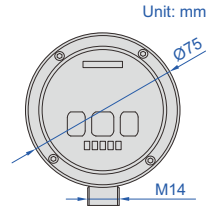

9414-1



- On-machine measurement of all kinds of small and medium-sized machining centers, CNC boring, milling machines and five-axis CNC machine tools
- Automatically set the workpiece coordinate and machining reference point before CNC machining process
- Automatically measure dimension and position coordinate during CNC machining
- Measure dimension, shape and position after CNC machining is completed
- Four kinds of SSR signals such as probe status, error, low voltage and pulse are transmitted to CNC machine tools
- Working status can be displayed on receiver LED indicator
- Signal transmitting range of probe can be set
- Infrared transmission, fast response, high reliability
- The battery (5% utilization rate per shift) can be used continuously for 90 days
- Supplied with measurement software package
- Can be used in combination with zero setter with infrared transmission (code 9415-1, 9415-2)
- Optional accessory: styli

### PROBE SPECIFICATION

Code	9414-1	9414-2	9414-3	9414-4	9414-5
Probe length (L)	130mm	151.5mm	208.3mm	156mm	126.5mm
Probe diameter (ØD)	40mm	40mm	40mm	40mm	40mm
Applicable spindle*	BT30	BT40	BT50	CAT40	HSK63A
Trigger accuracy of styli in any direction	1µm				
Protection stroke triggered by styli in all directions	X and Y axis stroke: ±12°, Z axis stroke: 5mm				
Trigger force of styli in all directions	X and Y axis: 0.5-1N, Z axis: 7.5N				
Dust/waterproof	IP68				
Power supply	2xLS14250 lithium battery				

\*SK and ISO spindle probes also can be customized

### RECEIVER SPECIFICATION

Code	9414-A
Protection function	low battery voltage, overstroke and signal interrupt protection**
Applicable	probe code 9414-1, 9414-2, 9414-3, 9414-4, 9414-5; zero setter code 9415-1, 9415-2
Infrared transmission/reception range	3m
Cable length	8m
Dust/waterproof	IP68
Power supply	input voltage: 24V±10% (DC), load current (max): 50mA

\*\*When battery voltage is low or zero setter is in wrong state, receiver sends a signal to CNC machine to stop working

To be continued

Continued from previous page

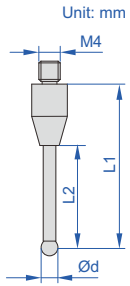

### STYLI (OPTIONAL)

(mm)

Code	L1	L2	Ød	Material of rod ***	Material of ball
9410-P1	18	13	4	stainless steel	ruby
9410-P2	18	13.5	5	stainless steel	ruby
9410-P3	18.5	13	3	stainless steel	ruby
9410-P4	19	8	2	carbide	ruby
9410-P5	19.5	4	1	carbide	ruby
9410-P6	50	40	2	carbide	ruby
9410-P7	50	34	5	ceramic	ruby
9410-P8	100	86	6	ceramic	ruby
9410-P9	40	30	4	ceramic	ruby
9410-P10	50	36	6	ceramic	ruby

\*\*\* For stainless steel or carbide rods, it is recommended to use extension rods to protect spindles in case of break

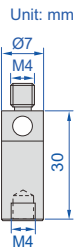

### EXTENSION ROD (OPTIONAL)

Code	Material
9410-R1	ceramic

application

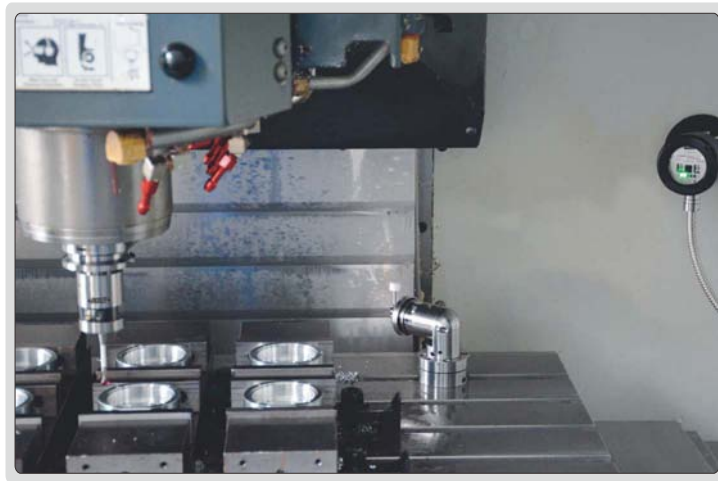

### AUTOMATIC MEASUREMENT SOFTWARE (INCLUDED)

1. Stylus automatic calibration
2. Protection of stylus during probe movement (avoid collision)
3. Groove and boss measurement

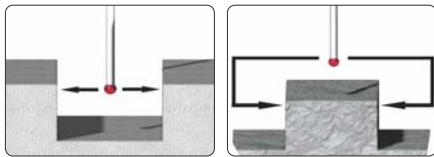

5. X or Y single-surface measurement

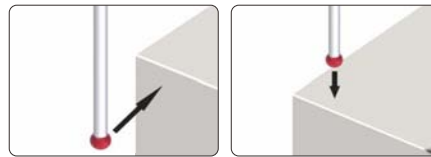

7. 4th axis measurement
8. Angle on X and Y plane measurement
9. Three points measurement of arc

4. Bore and axis measurement

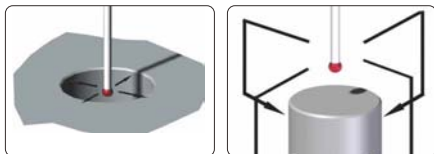

6. Internal and external corner measurement

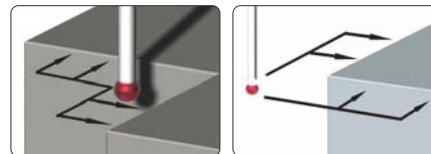

10. Measure the distance between two holes

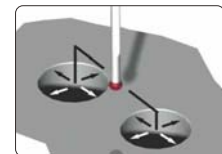



**IP68**  
WATERPROOF

## ZERO SETTER WITH INFRARED TRANSMISSION (FIVE-SIDE)



9415-1



9414-A

Unit: mm

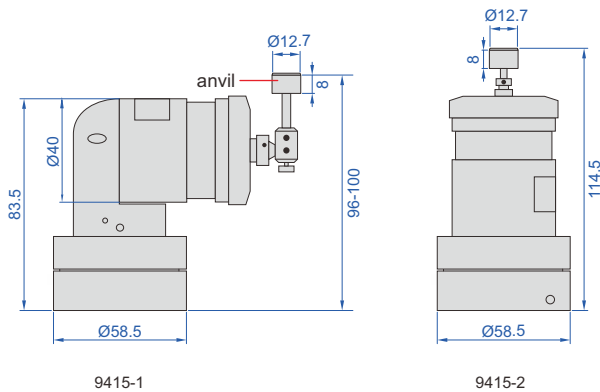

Unit: mm

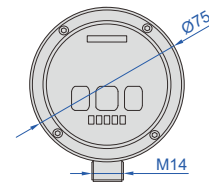

- Suitable for all kinds of small and medium-sized machining centers, CNC boring, milling machines and five-axis CNC machine tools, etc.
- Automatically set the tool length parameters before CNC machining process
- Automatic detection of tool wear or damage during CNC machining
- Automatic detection of tool wear or damage after CNC machining is completed
- The working surface of anvil is ceramic and has chamfer, which can greatly improve the service life
- Infrared transmission, fast response, high reliability
- The battery (5% utilization rate per shift) can be used continuously for 90 days
- Supplied with automatic zero setter software package
- Can be used in combination with infrared transmission probes for CNC machine tools (code 9414-1, 9414-2, 9414-3, 9414-4, 9414-5)
- Optional accessory: square anvil (code 9412-B1)

### ZERO SETTER SPECIFICATION

Code	9415-1	9415-2
Height (factory setting)	96-100mm	114.5mm
Diameter of zero setter	Ø12.7mm	
Trigger direction	±X, ±Y, +Z	
Trigger protection stroke	X-Y: ±5mm, Z: 8mm	
Trigger force of zero setter all directions	X and Y axis: 0.5-1N, Z axis: 1.5N	X and Y axis: 0.5-1N, Z axis: 5N
Repeated trigger accuracy	≤1µm	
Start/stop mode	M code control *	
Hardness of the zero setter	HM8.5	
Dust/waterproof	IP68	
Power supply	2xLS14250 lithium battery	

\* Before purchasing, please confirm whether CNC still has enough M code to be used

To be continued

Continued from previous page

**RECEIVER SPECIFICATION**

<b>Code</b>	<b>9414-A</b>
<b>Protection function</b>	low battery voltage, overstroke and signal interrupt protection**
<b>Applicable</b>	probe code <b>9414-1, 9414-2, 9414-3, 9414-4, 9414-5</b> ; zero setter code <b>9415-1, 9415-2</b>
<b>Infrared transmission/reception range</b>	3m
<b>Cable length</b>	8m
<b>Dust/waterproof</b>	IP68
<b>Power supply</b>	input voltage: 24V±10% (DC), load current (max): 50mA

\*\* When battery voltage is low or zero setter is in wrong state, receiver sends a signal to CNC machine to stop working

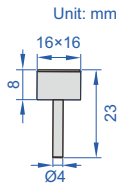

**SQUARE ANVIL (OPTIONAL)**

Code	Shape	Dimension	Material
9412-B1	square	16×16mm	ceramic

application

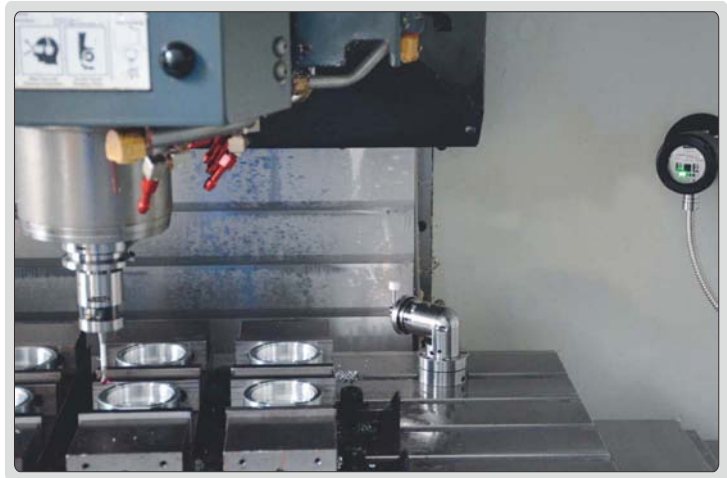

**Automatic zero setter software (included)**

1. Automatic calibration of the center position of the anvil
2. Standard knife length setting
3. Semi-automatic and fully automatic tool setting for tool length



4. Semi-automatic and fully automatic tool diameter settings



5. Automatic detection of tool wear and breakage



**IP68**  
WATERPROOF

## ZERO SETTER WITH CABLE (FIVE-SIDE) CODE 9412

- Suitable for various machining centers, CNC boring and milling machines, etc.
- Automatically set the tool length parameters before CNC machining process
- Automatic detection of tool wear or damage during CNC machining
- Automatic detection of tool wear or damage after CNC machining is completed
- The working surface adopts ceramic material and chamfering process, which can greatly improve the service life
- The plug, cable part and output signal of the host are protected, so that the zero setter can work in the splash environment for a long time
- Signal transmission through the cable, the reverse connection of the power line can change the state of the signal output
- The working status is displayed by the indicator light
- Supplied with automatic zero setter software package
- Optional accessory: square feeler block (code **9412-B1**)



### SPECIFICATION

Height (factory setting)	80±0.5mm
Diameter of zero setter	Ø12.7mm
Trigger direction	±X, ±Y, +Z
Trigger protection stroke	X-Y: ±5mm, Z: 8mm
Axial reset force	3.4N-3.6N
Repeated trigger accuracy	≤1µm
Hardness of the zero setter	HM8.5
Class of protection	IP68
Cable length *	6m (stainless steel sheath 3m)
Input voltage	24V±10% (DC)
Load current	max: 50mA
Signal type and logic **	SSR (NC/NO)

\*The length of the cable can be customized

\*\*Before purchasing, it is necessary to confirm whether the working logic of the tool setter output signal matches CNC control system

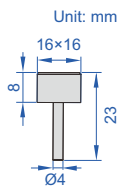
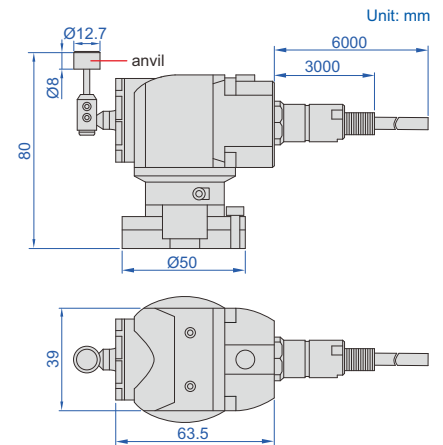

### SQUARE ANVIL (OPTIONAL)

Code	Shape	Dimension	Material
9412-B1	square	16×16mm	ceramic

application



### Automatic zero setter software (included)

1. Automatic calibration of the center position of the anvil
2. Standard knife length setting
3. Semi-automatic and fully automatic tool setting for tool length



4. Semi-automatic and fully automatic tool diameter settings



5. Automatic detection of tool wear and breakage



## ZERO SETTER (WITH CABLE) CODE 9411

**IP68**  
WATERPROOF

- Suitable for various machining centers, CNC boring and milling machines, etc.
- Automatically set the tool length parameters before CNC machining process
- Automatic detection of tool wear or damage during CNC machining
- Automatic detection of tool wear or damage after CNC machining is completed
- The working surface is made of hard alloy material, which can greatly improve the scratch resistance
- Signal transmission through the cable, the reverse connection of the power line can change the state of the signal output
- The working status is displayed by the indicator light
- Supplied with 20mm mounting base
- Supplied with automatic zero setter software package
- Optional accessory: blow-cleaning device (code 9411-C1)



mounting base (included)

### SPECIFICATION

Height	80mm (the height is 100mm after adding the mounting base)
Diameter of zero setter	Ø25mm
Downward travel	5mm
Axial reset force	6N±0.3N
Repeated trigger accuracy	≤1µm
Hardness of the zero setter	HRA90-93
Class of protection	IP68
Cable length *	6m (stainless steel sheath 3m)
Input voltage	24V±10% (DC)
Load current	max: 50mA
Signal type and logic **	SSR (NC/NO)

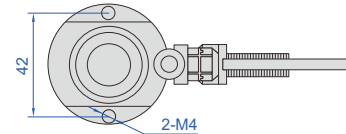
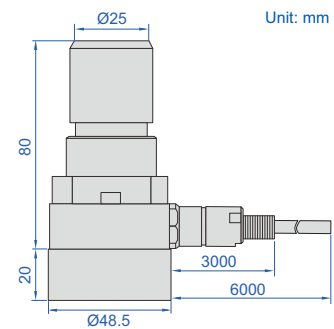

\*The length of the cable can be customized

\*\*Before purchasing, it is necessary to confirm whether the working logic of the tool setter output signal matches CNC control system

### BLOW-CLEANING DEVICE (OPTIONAL)

Code	Material
9411-C1	stainless steel

Before purchasing a blow-cleaning device, it is necessary to confirm whether CNC machine has the M-code to control the cleaning

application



### blow-cleaning device (optional)

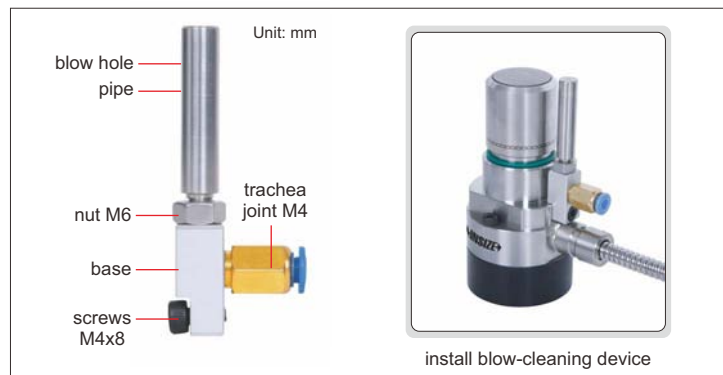

### Automatic zero setter software package (included)

1. Automatic calibration of the center position of the cutter block
2. Standard knife length setting
3. Semi-automatic and fully automatic tool setting for tool length

4. Automatic detection of tool wear and breakage



**LOW TEST FORCE**

- The base is electrically conducted to the cutting tools through the table and chuck. The LED lights up when the cutting tool touches the anvil
- Magnetic base
- Two batteries LR44

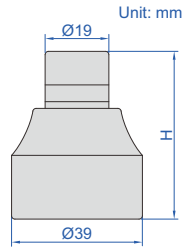

6553-50

**ELECTRONIC ZERO SETTER**

**INSIZE PLUS**  
MADE IN EUROPE

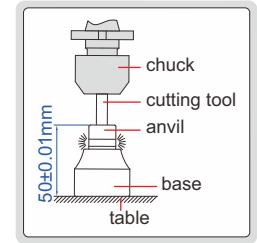
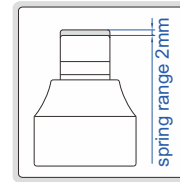

Code	Height (H)	Accuracy	Test force
6553-50	50mm	±10µm	7N (at 49mm)

**IP65 WATERPROOF**

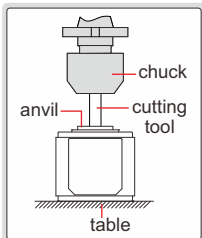

6557-50



**DIGITAL ZERO SETTER**

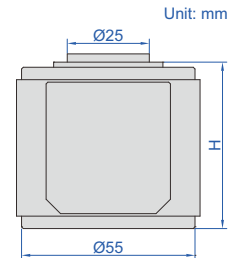

- Resolution: 0.001mm/0.00005"
- IP65 dust/waterproof
- Buttons: on/off, mm/inch, zero
- CR2032 battery
- Automatic power off
- Magnetic base
- Automatic backlight at zero

Code	Height (H)	Anvil stroke	Accuracy *	Test force	Repeatability
6557-50	50mm	2.5mm	±10µm/0.0004"	10N (at 50mm)	2µm

\* The accuracy is ensured within Ø10mm of the center

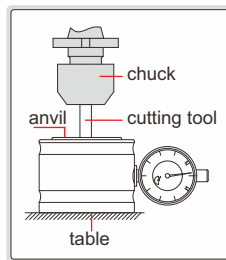
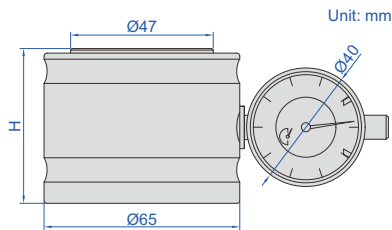

6554-50

**ZERO SETTER**

**INSIZE PLUS**  
MADE IN EUROPE

Code	Height (H)	Graduation	Accuracy	Test force
6554-50	50mm	0.01mm	±0.02mm	9N (at 50mm)

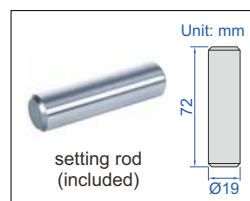
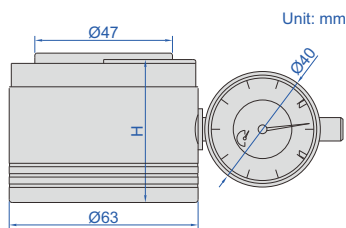

6556-50

**ZERO SETTER**

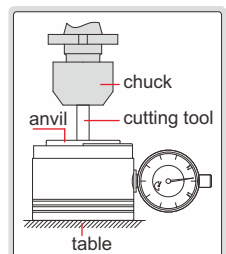

Code	Height (H)	Graduation	Accuracy	Test force
6556-50	50mm	0.01mm	±0.01mm	10N (at 50mm)

**ZERO SETTER**

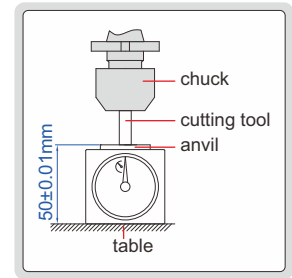
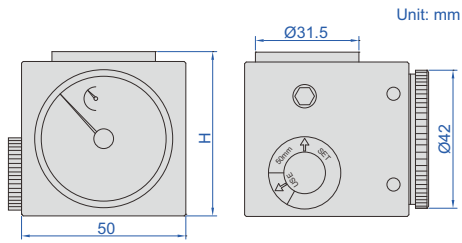

- Magnetic base

2397-502A

Code	Height (H)	Graduation	Accuracy	Test force
2397-502A	50mm	0.01mm	±0.01mm	9N (at 50mm)

**ZERO SETTER**

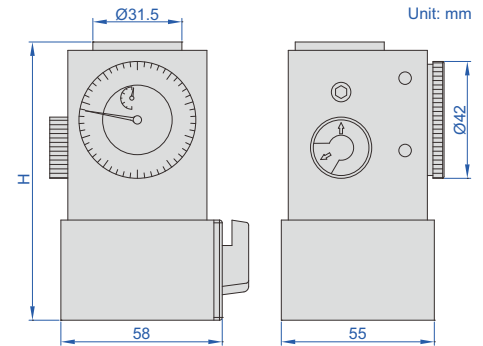
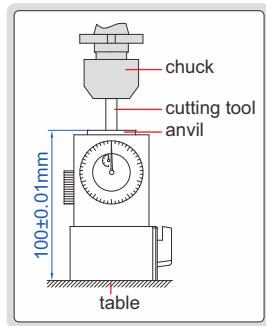

- Magnetic base with on-off switch

2394-100A

Code	Height (H)	Graduation	Accuracy	Test force
2394-100A	100mm	0.01mm	±0.01mm	9N (at 100mm)

**LOW TEST FORCE ZERO SETTER**

**INSIZE PLUS**  
MADE IN EUROPE

LOW TEST FORCE

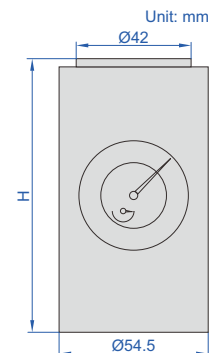
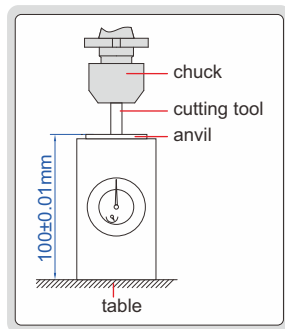

- Magnetic base
- Low test force, suitable for micro tools with minimum diameter Ø0.1mm

6555-100B

Code	Height (H)	Graduation	Accuracy	Test force
6555-100B	100mm	0.01mm	±0.01mm	1N (at 100mm)



**Electronic Levels**  
Page 496



**Digital Levels And Slope Meters**  
Page 497-500



**Frame Levels**  
Page 501



**Block Levels**  
Page 502



**Levels**  
Page 503-506



**Cross-Line Laser Levels**  
Page 507



**Self-Leveling Rotary Lasers**  
Page 508

## ELECTRONIC LEVELS

**INSIZE PLUS**  
MADE IN EUROPE

INSPECTION  
CERTIFICATE

DATA  
OUTPUT

SHOCK  
PROOF

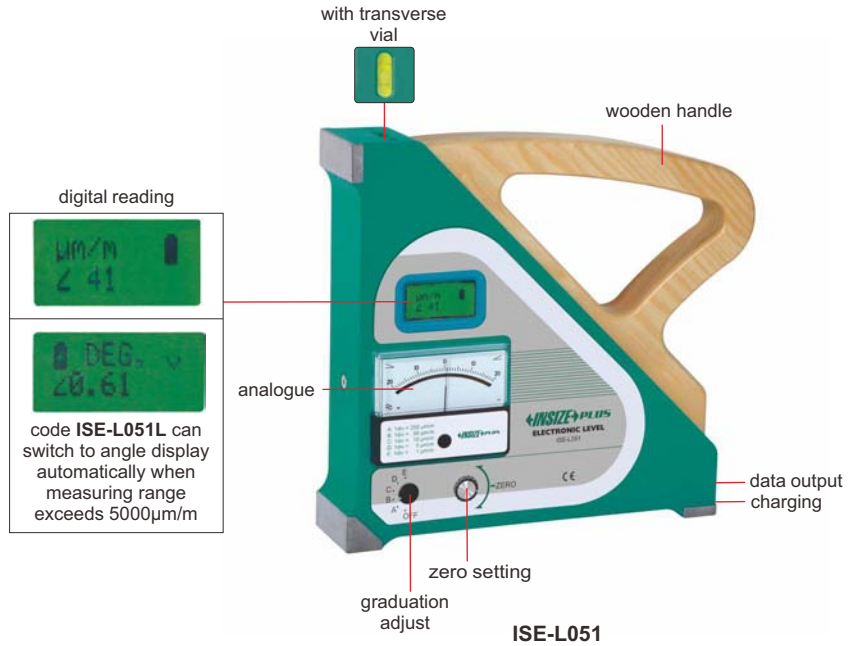
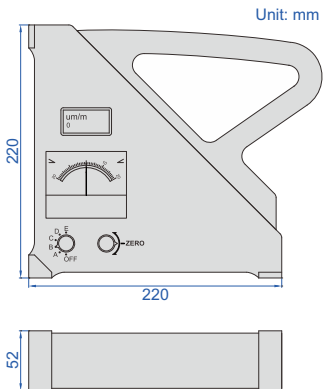

- Shockproof
- Analogue and digital reading modes

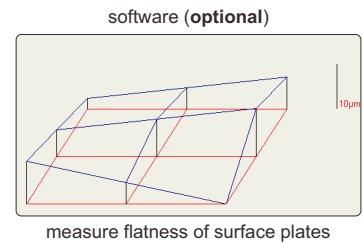
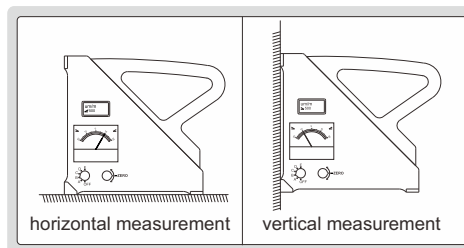

### SPECIFICATION

Code	ISE-L051			ISE-L051L	
Analogue graduation (adjustable)	250µm/m (=0.014°)	50µm/m (=10")	10µm/m (=2")	5µm/m (=1")	1µm/m (=0.2")
Analogue range	±5000µm/m	±1000µm/m	±200µm/m	±100µm/m	±20µm/m
Digital reading resolution	horizontal: 1µm/m (=0.2")			horizontal: 1µm/m (=0.2"), angle: 0.01°	
Digital reading range	horizontal: 5000µm/m			horizontal: 5000µm/m, angle: 0.3-85°	
Accuracy	horizontal: ±1%			horizontal: ±1%, angle: ±0.7%	
Zero setting range	±1500µm/m				
Response time	<3s				
Data output	RS232				
Power supply	rechargeable Li-ion battery, provides power for 10h continuous working				
Dimension	220×220×52mm				
Weight	4.4kg				

20

### STANDARD DELIVERY

Main unit	1 pc
AC/DC adapter	1 pc

### OPTIONAL ACCESSORY

Software and data output cable	ISE-L050-SOFTWARE
--------------------------------	-------------------



DATA OUTPUT

## DIGITAL LEVEL CODE ISE-2DT



- Color LCD, touch panel
- X-Y axis measurement
- Set the tolerance and the display is shown in different colors

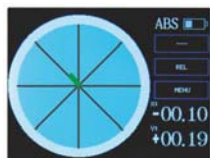

within the tolerance (green)

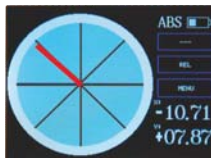

out of the tolerance (red)

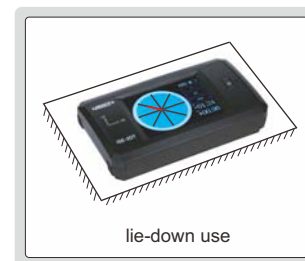

- To show the incline with line or bubble

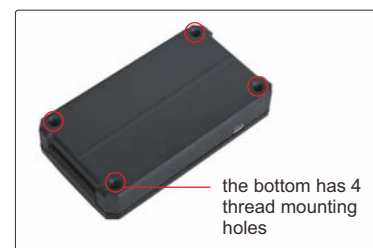
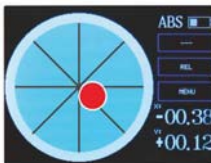
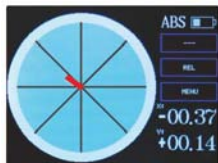

### SPECIFICATION

Measuring range	±30°
Resolution	0.1°, 0.01°, 0.1mm/m
Accuracy	±0.03° (range 0~3°) ±0.05° (range >3°)
Power supply	rechargeable battery
Dimension	115×66×25mm
Weight	224g

### STANDARD DELIVERY

Main unit	1 pc
USB cable	1 pc

### OPTIONAL ACCESSORY

Software	ISE-2DT-SOFTWARE
----------	------------------

PC software (optional), send data to txt

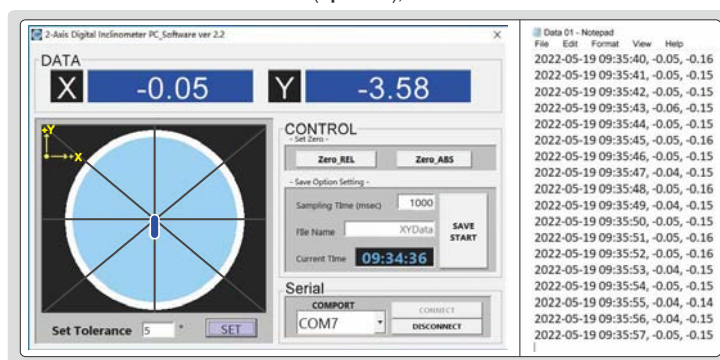

## DUAL AXIS DIGITAL LEVEL AND GYRO ANGLE METER



DATA  
OUTPUT

DISPLAY FLIPS OVER WHEN  
THE BOTTOM FACES UP

AUDIBLE ALARM  
WHEN OUT OF LIMIT

BACKLIGHT

ATTENTION: HARD  
PLASTIC CASE



2199-1

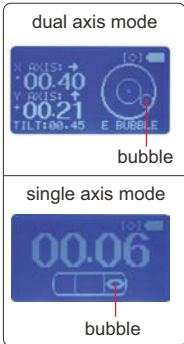
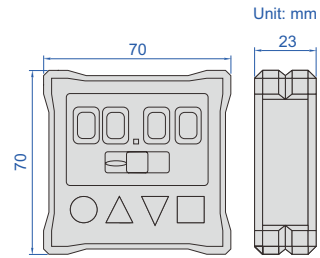

M4 threaded holes  
on the back for fixing

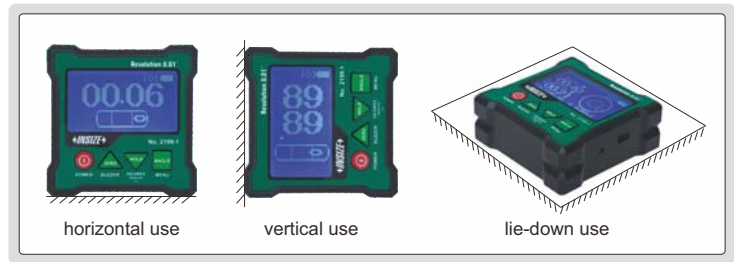

- Single axis/double axis level and slope meter, gyro technique can measure the angle between two planes in any direction
- Hard plastic case, with V-shaped grooves, four magnetic sides
- Display flips over when the bottom faces up
- Audible alarm when out of limit
- Buttons: POWER, ZERO, HOLD, display unit ( $^{\circ}$ , mm/m, %), MENU
- Rechargeable Li-ion battery 3.7V, operation time is 40 hours
- Automatic power off in 30 minutes
- Data output
- Optional accessory: wired data transmission (code **2199-A01**), bluetooth (code **2199-A02**), transmission distance is 10 meters (under the condition of no obstruction and no electromagnetic interference)

measurement of angle between two  
planes in any direction (gyro technique)

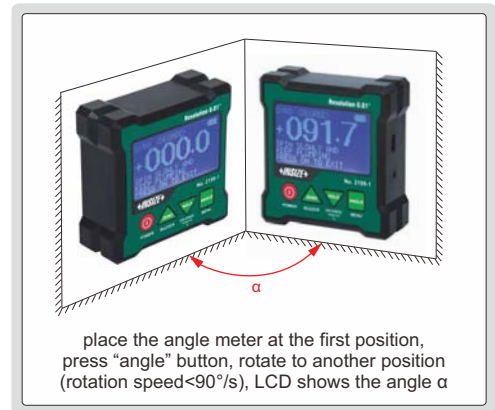

Code	Range	Resolution	Accuracy
2199-1	single axis level: $4 \times 90^{\circ}$ dual axis level: $\pm 40^{\circ}$	0.01 $^{\circ}$	at $0^{\circ}$ and $20^{\circ}$ : $\pm 0.08^{\circ}$ at $20^{\circ}$ and $70^{\circ}$ : $\pm 0.15^{\circ}$ at $70^{\circ}$ and $90^{\circ}$ : $\pm 0.08^{\circ}$
	gyro angle meter: $360^{\circ}$	0.1 $^{\circ}$	$\pm 0.5^{\circ}$



connect to computer via wired data transmission



connect to mobile phone via bluetooth



bluetooth (optional)



wired data transmission (optional)



ABSOLUTE LEVEL

BACKLIGHT

BUZZER ALARM AT 0° AND 90°

WORKING TEMPERATURE -5°C~50°C

IP67 WATERPROOF



2175-360

## DIGITAL LEVEL AND SLOPE METER

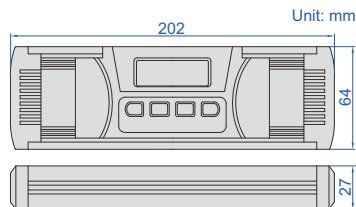

- IP67 dust/waterproof
- Used as level and slope meter
- Aluminum frame, shock absorbing rubber end caps
- Magnetic bottom with V-groove for shafts
- The sea level is permanently set inside the chip, zero setting is not needed when batteries are replaced
- Buttons: ON/OFF, backlight/buzzer alarm, absolute and incremental measurement, unit (mm/m, %, °), HOLD (keep the reading)
- Three AAA batteries, automatic power off

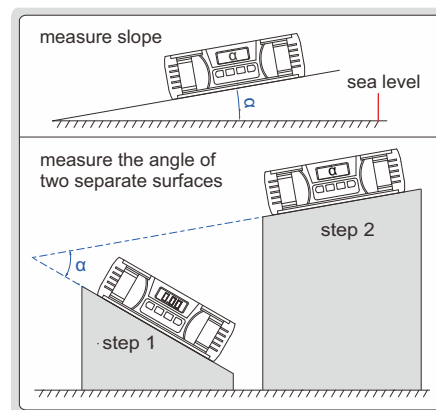

Code	Range	Resolution	Accuracy
2175-360	0-360° (90°x4)	0.05° (=0.873mm/m)	at 0°: ±0.05°; at others: ±0.1°

ABSOLUTE LEVEL

BACKLIGHT

BUZZER ALARM AT 0° AND 90°

WORKING TEMPERATURE -5°C~50°C

IP54 WATERPROOF



2179-360

## DIGITAL LEVEL AND SLOPE METER

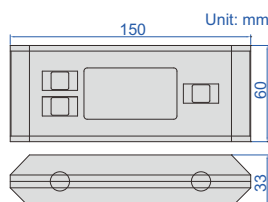

- IP54 dust/waterproof
- Used as level and slope meter
- Aluminum frame
- Magnetic bottom with V-groove for shafts
- The sea level is permanently set inside the chip, zero setting is not needed when battery is replaced
- Buttons: ON/OFF, absolute and incremental measurement, keep the reading, buzzer alarm, unit (mm/m, %, in/ft), conversion, backlight
- Two AAA batteries, automatic power off

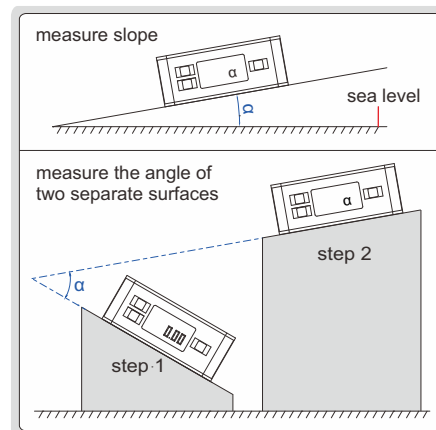

Code	Range	Resolution	Accuracy
2179-360	0-360° (90°x4)	0.05° (=0.873mm/m)	at 0° and 90°: ±0.1°; at others: ±0.2°

## DIGITAL LEVEL AND SLOPE METER

POPULAR MODEL

- Used as level and slope meter
- Aluminum frame
- Magnetic bottom
- The display flips over when the bottom faces up
- The backlight is on automatically when in use, and automatically off in 15 seconds after use
- The sea level is permanently set inside the chip, zero setting is not needed when battery is replaced
- Buttons: ON/OFF, ZERO, absolute and incremental measurement
- One AAA battery, automatic power off in 5 minutes



2170-1

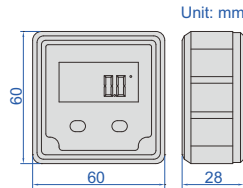

Unit: mm

MAGNETIC BOTTOM

WORKING TEMPERATURE  
-5°C~50°C

BACKLIGHT

DISPLAY FLIPS OVER WHEN THE BOTTOM FACES UP

ABSOLUTE LEVEL

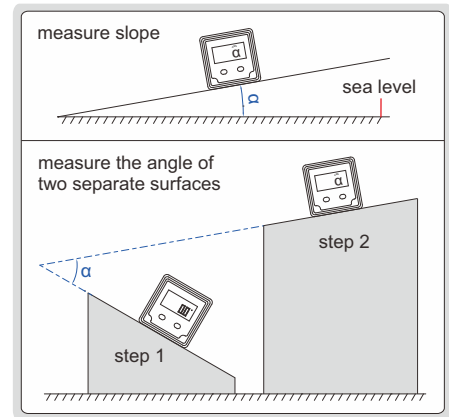

Code	Range	Resolution	Accuracy
2170-1	4x90°	0.1° (=1.745mm/m)	at 0° and 90°: ±0.1°; at others: ±0.2°



## BLUETOOTH DIGITAL LEVEL AND SLOPE METER

- Used as level and slope meter
- Aluminum frame
- Magnetic bottom
- The display flips over when the bottom faces up
- The backlight is on automatically when in use, and automatically off in 15 seconds after use
- The sea level is permanently set inside the chip, zero setting is not needed when battery is replaced
- Buttons: ON/OFF, ZERO, HOLD, absolute and incremental measurement
- Built-in bluetooth, transmission distance is 15 meters (under the condition of no obstruction and no electromagnetic interference). Android and iPhone APP are included
- One AAA battery, automatic power off in 5 minutes



2198-2

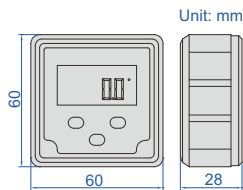

Unit: mm

BACKLIGHT

MAGNETIC BOTTOM

DISPLAY FLIPS OVER WHEN THE BOTTOM FACES UP

WORKING TEMPERATURE  
-5°C~50°C

ABSOLUTE LEVEL

Android and iPhone APP (included), can choose real-time display (continuous transmission) or single transmission

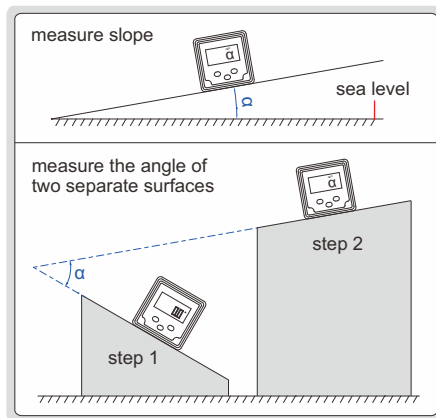

Code	Range	Resolution	Accuracy
2198-2	4x90°	0.1° (=1.745mm/m)	at 0° and 90°: ±0.1°; at others: ±0.2°

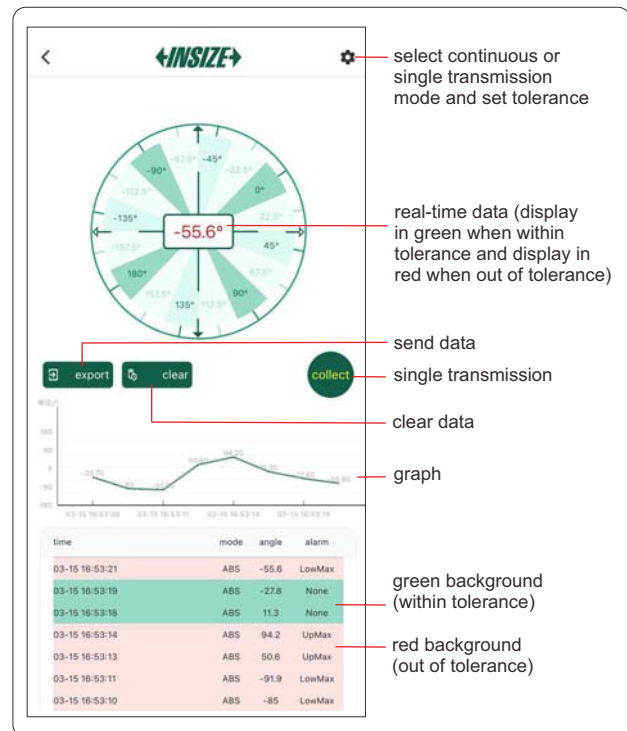

**NO NEED TO SET ZERO BEFORE USE**

**FRAME LEVELS**  
**INSIZE PLUS**  
 MADE IN EUROPE

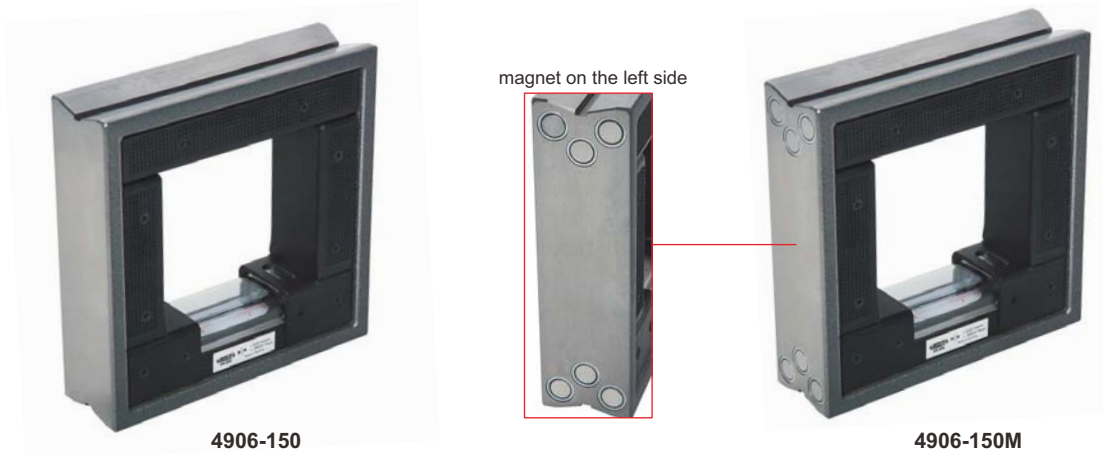

- No need to set zero before use
- Three V-grooves for shafts (shafts dia. 19.3~115.9mm)
- With longitudinal vial

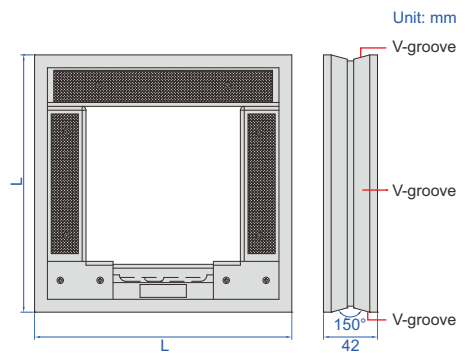

Code		Size (LxL)	Remark
Sensitivity 0.02mm/m (=0.001°)	Sensitivity 0.1mm/m (=0.0057°)		
4906-150	4906-B150	150x150mm	—
4906-200	4906-B200	200x200mm	—
4906-300	4906-B300	300x300mm	—
4906-150M	4906-B150M	150x150mm	with magnet
4906-200M	4906-B200M	200x200mm	with magnet
4906-300M	4906-B300M	300x300mm	with magnet



- V-groove on bottom and left for shafts (shafts dia. 15~68mm)
- With transverse vial

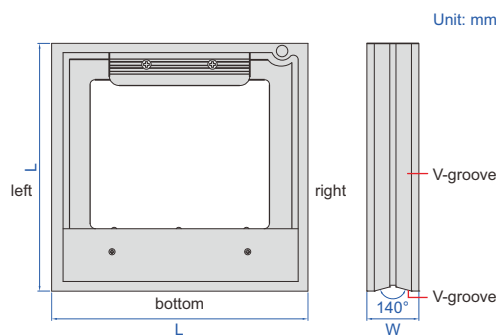

**FRAME LEVELS**



4902-200

Code		Size (LxL)	W
Sensitivity 0.02mm/m (=0.001°)	Sensitivity 0.05mm/m (=0.0029°)		
4902-150	4902-C150	150x150mm	40mm
4902-200	4902-C200	200x200mm	40mm
4902-300	4902-C300	300x300mm	45mm

## BLOCK LEVELS

**INSIZE PLUS**  
MADE IN EUROPE

- No need to set zero before use
- V-groove on bottom for shafts (shafts dia. 19.3~115.9mm)
- With longitudinal vial



4905-200

NO NEED TO SET ZERO BEFORE USE

Code		Size (L)
Sensitivity 0.02mm/m (=0.001°)	Sensitivity 0.1mm/m (=0.0057°)	
4905-160	4905-B160	160mm
4905-200	4905-B200	200mm
4905-300	4905-B300	300mm
4905-500	4905-B500	500mm

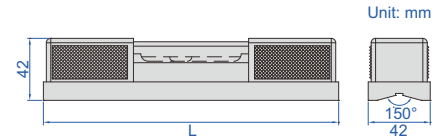

## BLOCK LEVELS

POPULAR MODEL



- V-groove on bottom for shafts (shafts dia. 15~68mm)
- With transverse vial

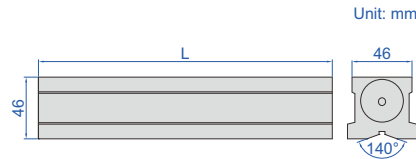

4903-200A

Code		Length (L)
Sensitivity 0.02mm/m (=0.001°)	Sensitivity 0.05mm/m (=0.0029°)	
4903-150A	4903-C150	150mm
4903-200A	4903-C200	200mm
4903-300A	4903-C300	300mm

## SHORT LEVEL

**INSIZE PLUS**  
MADE IN EUROPE

- No need to set zero before use
- Suitable for small spaces like crankshaft
- Longitudinal and transverse V-grooves on bottom for shafts (shafts dia. 19.3~115.9mm)
- With transverse vial



4907-90

NO NEED TO SET ZERO BEFORE USE

Code	Length	Sensitivity
4907-90	90mm	0.1mm/m (=0.0057°)

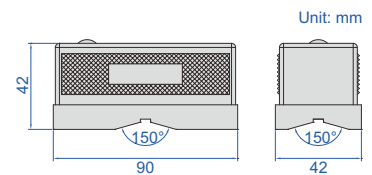

## MINI LEVEL

**INSIZE PLUS**  
MADE IN EUROPE

- No need to set zero before use
- With mounting holes (for M5 screws)



4908-100

NO NEED TO SET ZERO BEFORE USE

Code	Length	Sensitivity
4908-100	100mm	0.1mm/m (=0.0057°)

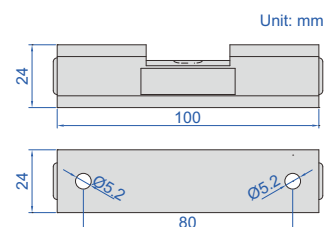

ABSOLUTE LEVEL

BACKLIGHT

WORKING TEMPERATURE  
0°C~50°C

## DIGITAL LEVELS AND SLOPE METERS

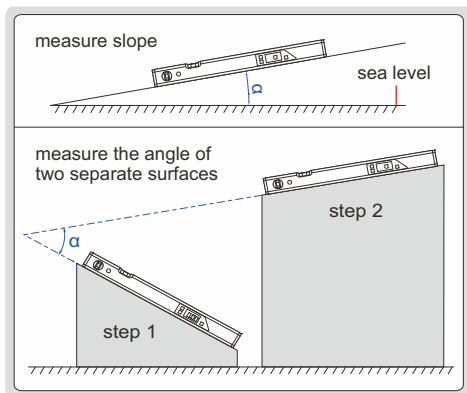

both angle and slope are displayed



- With transverse and longitudinal vials
- Used as level and slope meter
- Aluminum frame, magnetic bottom
- The sea level is permanently set inside the chip, zero setting is not needed when batteries are replaced
- Buttons: ON/OFF, absolute and incremental measurement, keep the reading, buzzer alarm (not for 4910-400), unit (mm/m, %, in/ft), conversion (not for 4910-400), backlight
- The display flips over when the bottom faces up
- Two AAA batteries
- Automatic power off

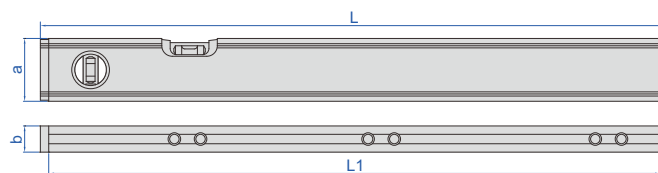

(mm)

Code	Range	Resolution	Accuracy	Remark	L	L1	a	b
4910-400	0~360° (90°×4)	angle: 0.1°; slope: 1mm/m	±0.2°	both angle and slope are displayed	416	400	50	21
4910-600	0~360° (90°×4)	at 0° and 90°: 0.05° (=0.8725mm/m); at others: 0.1° (=1.745mm/m)	at 0° and 90°: ±0.1°; at others: ±0.2°	at 0° and 90° buzzer alarms	600	585	60	25

LIFETIME WARRANTY VIALS

MAGNETIC BASE

## HANDY LEVEL



- Shockproof vials
- Magnetic base
- Shock absorbing rubber end caps
- Working temperature: -15°C~55°C

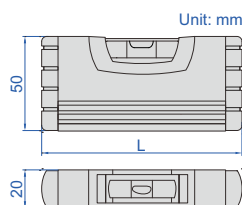

magnetic base surface



packaging



Code	Size (L)	Accuracy
4912-100	100mm	0.5mm/m

## HANDY LEVELS

MAGNETIC BASE

LIFETIME WARRANTY VIALS



4922-100

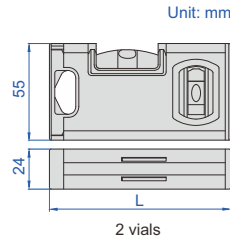

4922-150

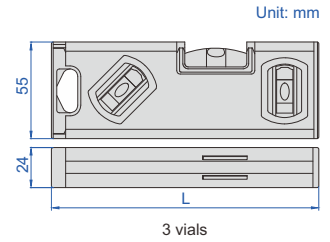

Code	Size (L)	Accuracy	Number of vials
4922-100	100mm	0.5mm/m	2
4922-150	150mm	0.5mm/m	3
4922-200	200mm	0.5mm/m	3

- Shockproof horizontal and vertical vials
- Magnetic base
- Shock absorbing rubber end caps
- Working temperature: -15°C~55°C

## CASTING ALUMINUM LEVEL

MAGNETIC BASE

LIFETIME WARRANTY VIALS

magnetic bottom surface (milled)

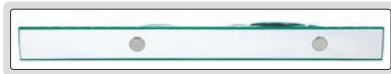

4913-250

packaging



- Shockproof horizontal and vertical vials
- Magnetic base
- Working temperature: -15°C~55°C
- Casting aluminum body

Code	Size (L)	Accuracy
4913-250	250mm	0.5mm/m

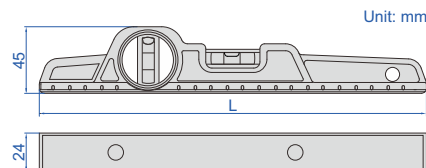

## ALUMINUM LEVEL

MAGNETIC BASE

LIFETIME WARRANTY VIALS

- Shockproof horizontal and vertical vials
- Magnetic base
- Shock absorbing rubber end caps
- Working temperature: -15°C~55°C



4921-230

Code	Size (L)	Accuracy
4921-230	230mm	0.5mm/m

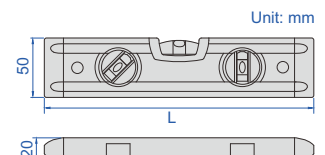



LIFETIME WARRANTY VIALS

MAGNETIC BASE

## ALUMINUM LEVELS



4914-600

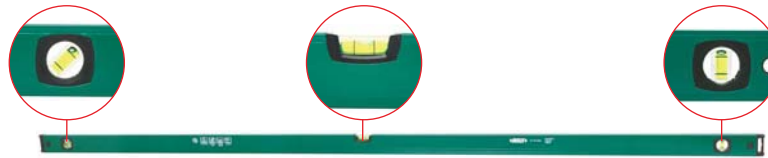

4914-2000

- Shockproof horizontal and vertical vials
- Magnetic base
- Shock absorbing rubber end caps
- Working temperature: -15°C~55°C

Code	Size (L)	Accuracy	Number of vials
4914-300	300mm	0.5mm/m	2
4914-600	600mm	0.5mm/m	2
4914-800	800mm	0.5mm/m	2
4914-1000	1000mm	0.5mm/m	2
4914-1200	1200mm	0.5mm/m	2
4914-2000	2000mm	0.5mm/m	3

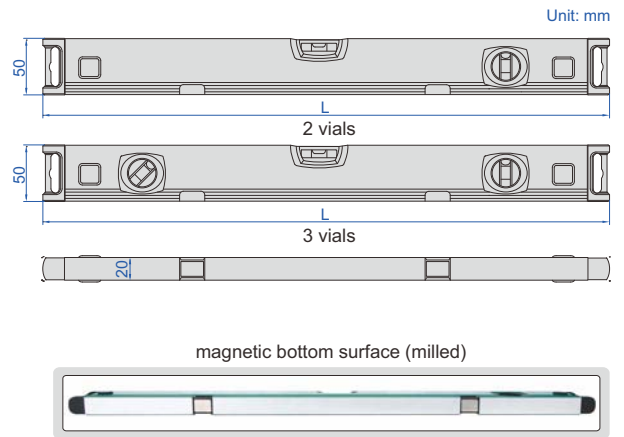

LIFETIME WARRANTY VIALS

## ALUMINUM LEVELS

- Top and bottom working surfaces
- Shock-proof and UV-proof vials
- Die casting aluminum alloy frame
- Zero position of horizontal vial can be set
- One graduation of horizontal vial is 2% slope
- Working temperature: -15°C~55°C



4911-600

bottom surface (non-magnetic, milled)



Code	Size (L)	Accuracy
4911-600	600mm	0.5mm/m
4911-800	800mm	0.5mm/m

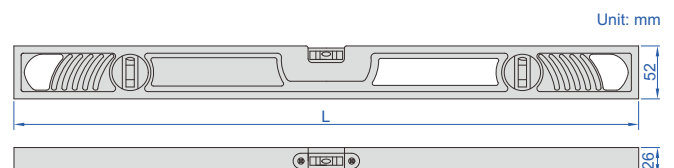

## ALUMINUM LEVELS (BASIC TYPE)

MAGNETIC BASE

LIFETIME WARRANTY VIALS



4918-300

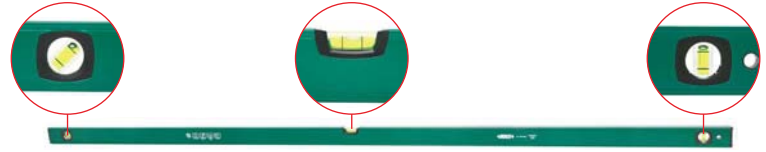

4918-2000

- Shock-proof and UV-proof vials
- Magnetic base
- Shock absorbing rubber end caps
- Working temperature: -15°C~55°C

Code	Size (L)	Accuracy	Number of vials
4918-300	300mm	1mm/m	2
4918-600	600mm	1mm/m	2
4918-800	800mm	1mm/m	2
4918-1000	1000mm	1mm/m	2
4918-1200	1200mm	1mm/m	2
4918-2000	2000mm	1mm/m	3

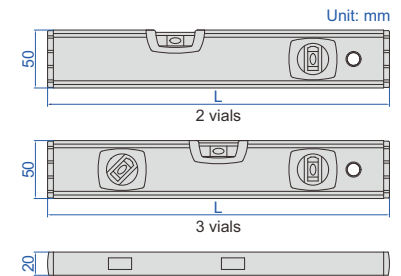
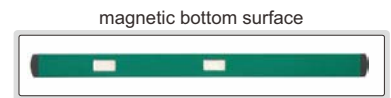

## ALUMINUM LEVEL WITH RULER

LIFETIME WARRANTY VIALS



4923-600

- Shockproof horizontal and vertical vials
- Non-magnetic milled base
- Shock absorbing rubber end caps
- Range of ruler: 0-60cm, graduation: 1mm
- Working temperature: -15°C~55°C

Code	Size (L)	Accuracy
4923-600	600mm	0.5mm/m

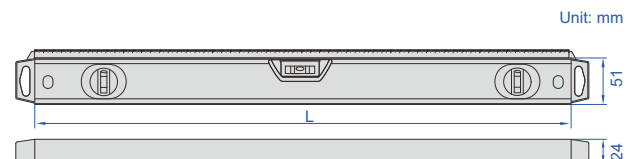

**IP54**  
WATERPROOF

AUDIBLE AND VISUAL  
ALARM WHEN OUT OF  $\pm 3^\circ$

## CROSS-LINE LASER LEVEL CODE 4917-30



- Red horizontal and vertical cross laser lines
- Self-leveling within  $\pm 3^\circ$ , self-leveling time within 4s, audible and visual alarm when out of  $\pm 3^\circ$
- Folding legs for angle and height adjustment
- Outdoor use with the detector (code: 4917-DETECTOR)



application examples



folding legs for angle and height adjustment

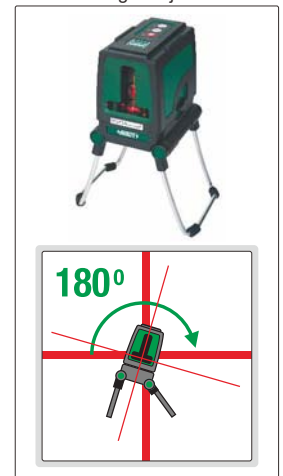

### SPECIFICATION

Laser line width	2 $\pm$ 0.5mm (within 5m)
Laser type	630~660nm, class II, <1mW
Beam angle	120 $\pm$ 0.5 $^\circ$
Self-leveling range	$\pm 3^\circ$
Working distance	indoor: 30m, outdoor: 50m with detector (optional)
Accuracy	0.2mm/m
Operation temperature	-10~40 $^\circ$ C
Power supply	3 $\times$ AA batteries, for 3 hours working
Dimension	100 $\times$ 82 $\times$ 104mm
Weight	620g



stand  
(included with outdoor detector)

### OUTDOOR DETECTOR (OPTIONAL)

Detecting distance	horizontal 1~50m, vertical 1~30m
Detecting accuracy *	high accuracy $\pm 1.5$ mm, low accuracy $\pm 2.5$ mm
Power supply	9V battery
Dimension	168 $\times$ 58 $\times$ 30mm
Weight	140g (battery included)



outdoor detector (optional)

\* Use high accuracy detection mode within 15m, use low accuracy detection mode over 15m

### STANDARD DELIVERY

Main unit	1 pc
1/4" to 5/8" tripod adaptor	1 pc
Battery (AA)	3 pcs

### OPTIONAL ACCESSORY

Outdoor detector	4917-DETECTOR
------------------	---------------

# SELF-LEVELING ROTARY LASER CODE GRL-L340

INDICATOR FLASHING  
WHEN OUT OF  $\pm 5^\circ$

IP65  
WATERPROOF



VIDEO



detector (included)



remote controller (included)



bracket for C battery (included)



beam finder glasses (included)



tripod (included)

- Applicable fields: construction, decoration, pipeline and equipment installation
- Green laser beam rotates 360° horizontally or vertically
- Self-leveling range  $\pm 5^\circ$  on both X and Y planes
- Alarm when inclination is out of  $\pm 5^\circ$
- $\pm 5^\circ$  leveling range for manual mode on both X and Y planes
- 5 variable speeds 0-600rpm
- 6 scan modes
- Plumb up and plumb down dots
- Remote control for long distance
- Power supply: AC or DC

### application examples



horizontal leveling

vertical leveling

working with detector

### SPECIFICATION

Working range		indoor 50m, outdoor 300m (with detector)
Self leveling range		$\pm 5^\circ$
Horizontal/vertical beam accuracy		$\pm 0.1\text{mm/m}$
Main laser type		520~540nm, class 2, <1mW
Auxiliary laser type		645~655nm, class 2, <1mW
Rotating speed		0/60/120/300/600rpm
Scanning range		0/10/45/90/180/360°
Setting slope		X axis: $\pm 5^\circ$ , Y axis: $\pm 5^\circ$
Operation temperature		-20~50°C
Maximum remote control distance		20m
Power supply	remote controller	2x1.5V AAA batteries
	main unit	NI-MH batteries or 4x1.5V C batteries
	detector	1x9V battery
Dimension		210x210x213mm
Weight		2.5kg

### STANDARD DELIVERY

Main unit (including NI-MH batteries)	1 pc
C battery and bracket	1 set
Detector	1 pc
Remote controller	1 pc
Beam finder glasses	1 pc
Laser target	1 pc
Power adapter	1 pc
AAA battery	2 pcs
9V battery	1 pc
Tripod	1 pc



**Linear Scales**  
Page 510-512/515



**Digital Readouts**  
Page 513-515

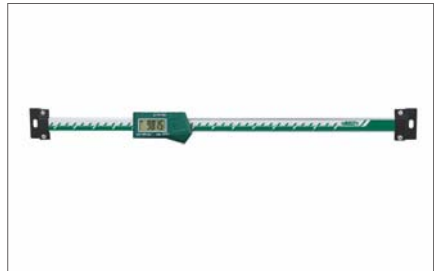

**Scales**  
Page 516-517



**Air Gages And Displays**  
Page 517-518



**Air Leakage Testers**  
Page 519



**Laser Scan Micrometers**  
Page 520-521



**Spectrometers**  
Page 522-526



**Tool Presetters**  
Page 527-529

# LINEAR SCALES (TTL SIGNAL)



ISL-A1-300

- Optical TTL (Through-The-Lens) detection. These optical TTL linear scales use a transistor logic to transmit and record high-resolution distance measurements. They are the most accurate type of encoder and are paired with ISL-DR2/DR3 and ISL-LCD7 (digital readout)

### Series ISL-A1 and ISL-A5

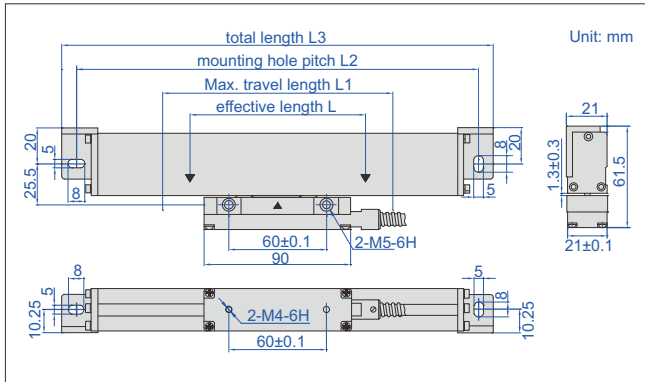

### Series ISL-B5

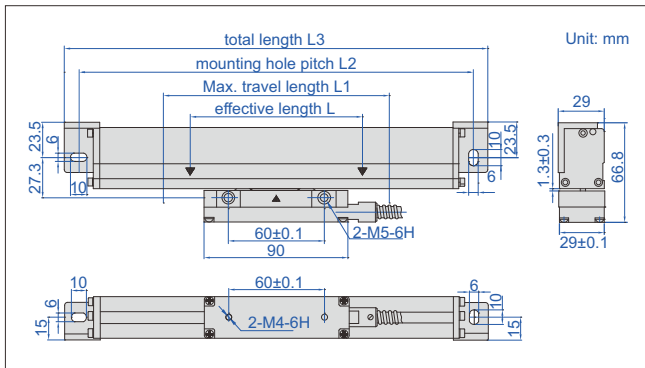

Effective length (L)	Code		
	Thin type		Thick type
	Series ISL-A1	Series ISL-A5	Series ISL-B5
50mm	ISL-A1-50	ISL-A5-50	ISL-B5-50
100mm	ISL-A1-100	ISL-A5-100	ISL-B5-100
150mm	ISL-A1-150	ISL-A5-150	ISL-B5-150
200mm	ISL-A1-200	ISL-A5-200	ISL-B5-200
250mm	ISL-A1-250	ISL-A5-250	ISL-B5-250
300mm	ISL-A1-300	ISL-A5-300	ISL-B5-300
350mm	ISL-A1-350	ISL-A5-350	ISL-B5-350
400mm	ISL-A1-400	ISL-A5-400	ISL-B5-400
450mm	ISL-A1-450	ISL-A5-450	ISL-B5-450
500mm	ISL-A1-500	ISL-A5-500	ISL-B5-500
550mm	ISL-A1-550	ISL-A5-550	ISL-B5-550
600mm	ISL-A1-600	ISL-A5-600	ISL-B5-600
650mm	ISL-A1-650	ISL-A5-650	ISL-B5-650
700mm	ISL-A1-700	ISL-A5-700	ISL-B5-700
750mm	ISL-A1-750	ISL-A5-750	ISL-B5-750
800mm	ISL-A1-800	ISL-A5-800	ISL-B5-800
850mm	ISL-A1-850	ISL-A5-850	ISL-B5-850
900mm	ISL-A1-900	ISL-A5-900	ISL-B5-900
950mm	ISL-A1-950	ISL-A5-950	ISL-B5-950
1000mm	ISL-A1-1000	ISL-A5-1000	ISL-B5-1000
1100mm			ISL-B5-1100
1200mm			ISL-B5-1200
1300mm			ISL-B5-1300
1400mm			ISL-B5-1400
1500mm			ISL-B5-1500
1600mm			ISL-B5-1600
1700mm			ISL-B5-1700
1800mm			ISL-B5-1800
1900mm			ISL-B5-1900
2000mm			ISL-B5-2000
2100mm			ISL-B5-2100
2200mm			ISL-B5-2200
2300mm			ISL-B5-2300
2400mm			ISL-B5-2400
2500mm			ISL-B5-2500
2600mm			ISL-B5-2600
2700mm			ISL-B5-2700
2800mm			ISL-B5-2800
2900mm			ISL-B5-2900
3000mm			ISL-B5-3000
3100mm			ISL-B5-3100
3200mm			ISL-B5-3200

### STANDARD DELIVERY

Main unit	1 pc
'L' shape support	1 pc
Anti-dust cover	1 pc
Plain base	1 pc (for L≥1500mm)
Mounting accessories	1 package

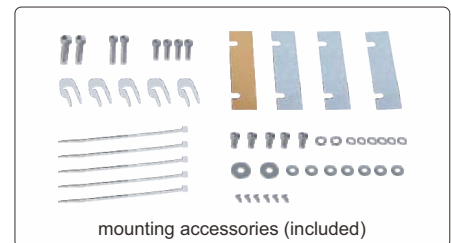
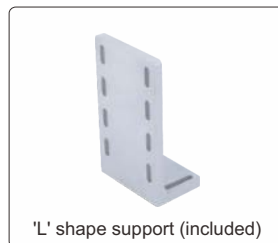

To be continued

Continued from previous page



anti-dust cover (included)



plain base (included, for L≥1500mm)

### SPECIFICATION

Code	Series ISL-A1		Series ISL-A5		Series ISL-B5	
L1 (mm)	L+30 (L≤900)	L+50 (L>900)	L+30 (L≤900)	L+50 (L>900)	L+30 (L≤900)	L+50 (L>900)
L2 (mm)	L+132 (L≤900)	L+152 (L>900)	L+132 (L≤900)	L+152 (L>900)	L+136 (L≤900)	L+156 (L>900)
L3 (mm)	L+148 (L≤900)	L+168 (L>900)	L+148 (L≤900)	L+168 (L>900)	L+154 (L≤900)	L+174 (L>900)
Resolution	1μm		5μm		5μm	
Max. response speed	50m/min		90m/min		60m/min	
Scale grating pitch	20μm					
Scale reference point pitch	50mm					
Accuracy	±(5+5L/1000)μm L is the effective length in mm					
Cable length	3.5m (L: 50-950mm), 5m (L: 1000-1500mm), 10m (L: 1600-3200mm)					
Output signal	TTL					
Socket	9PD					
Power supply	5±0.5V					

## LINEAR SCALES (RS422 SIGNAL)



ISL-B5-450A

- Connected to digital display box or PLC

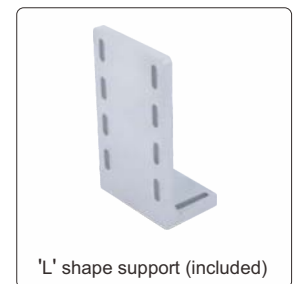

'L' shape support (included)

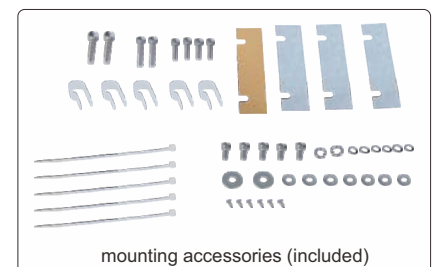
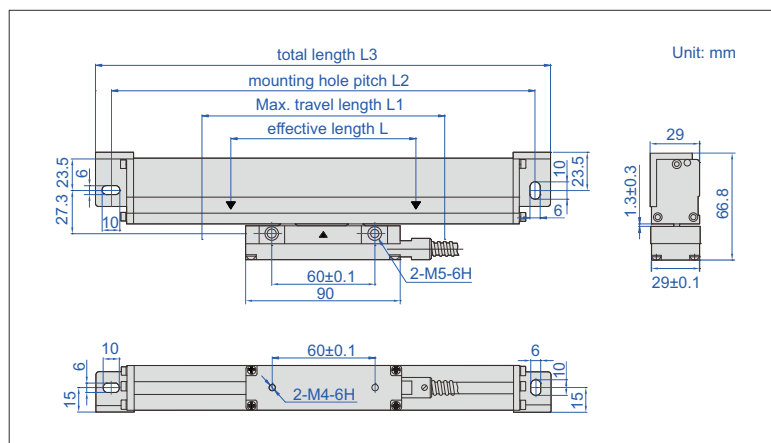

mounting accessories (included)

To be continued

Continued from previous page

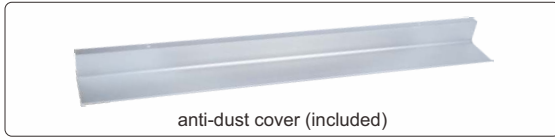

Effective length (L)	Code	
	Series ISL-B1	Series ISL-B5
50mm	ISL-B1-50A	ISL-B5-50A
100mm	ISL-B1-100A	ISL-B5-100A
150mm	ISL-B1-150A	ISL-B5-150A
200mm	ISL-B1-200A	ISL-B5-200A
250mm	ISL-B1-250A	ISL-B5-250A
300mm	ISL-B1-300A	ISL-B5-300A
350mm	ISL-B1-350A	ISL-B5-350A
400mm	ISL-B1-400A	ISL-B5-400A
450mm	ISL-B1-450A	ISL-B5-450A
500mm	ISL-B1-500A	ISL-B5-500A
550mm	ISL-B1-550A	ISL-B5-550A
600mm	ISL-B1-600A	ISL-B5-600A
650mm	ISL-B1-650A	ISL-B5-650A
700mm	ISL-B1-700A	ISL-B5-700A
750mm	ISL-B1-750A	ISL-B5-750A
800mm	ISL-B1-800A	ISL-B5-800A
850mm	ISL-B1-850A	ISL-B5-850A
900mm	ISL-B1-900A	ISL-B5-900A
950mm	ISL-B1-950A	ISL-B5-950A
1000mm	ISL-B1-1000A	ISL-B5-1000A

Effective length (L)	Code	
	Series ISL-B1	Series ISL-B5
1100mm	ISL-B1-1100A	ISL-B5-1100A
1200mm	ISL-B1-1200A	ISL-B5-1200A
1300mm	ISL-B1-1300A	ISL-B5-1300A
1400mm	ISL-B1-1400A	ISL-B5-1400A
1500mm	ISL-B1-1500A	ISL-B5-1500A
1600mm	ISL-B1-1600A	ISL-B5-1600A
1700mm	ISL-B1-1700A	ISL-B5-1700A
1800mm	ISL-B1-1800A	ISL-B5-1800A
1900mm	ISL-B1-1900A	ISL-B5-1900A
2000mm	ISL-B1-2000A	ISL-B5-2000A
2100mm	ISL-B1-2100A	ISL-B5-2100A
2200mm	ISL-B1-2200A	ISL-B5-2200A
2300mm	ISL-B1-2300A	ISL-B5-2300A
2400mm	ISL-B1-2400A	ISL-B5-2400A
2500mm	ISL-B1-2500A	ISL-B5-2500A
2600mm	ISL-B1-2600A	ISL-B5-2600A
2700mm	ISL-B1-2700A	ISL-B5-2700A
2800mm	ISL-B1-2800A	ISL-B5-2800A
2900mm	ISL-B1-2900A	ISL-B5-2900A
3000mm	ISL-B1-3000A	ISL-B5-3000A

#### SPECIFICATION

Code	Series ISL-B1	Series ISL-B5
L1 (mm)	L+30 (L≤900), L+50 (L>900)	L+30 (L≤900), L+50 (L>900)
L2 (mm)	L+136 (L≤900), L+156 (L>900)	L+136 (L≤900), L+156 (L>900)
L3 (mm)	L+154 (L≤900), L+174 (L>900)	L+154 (L≤900), L+174 (L>900)
Resolution	1μm	5μm
Thickness	29mm	
Max. response speed	60m/min	
Scale grating pitch	20μm	
Scale reference point pitch	50mm	
Accuracy	±(5+5L/1000)μm, L is the effective length in mm	
Cable length	3.5m (L: 50-950mm), 5m (L: 1000-1900mm), 10m (L: 2000-3000mm)	
Output signal	RS422	
Socket	9 PD	
Power supply	5±0.25V	

#### STANDARD DELIVERY

Main unit	1 pc
'L' shape support	1 pc
Anti-dust cover	1 pc
Plain base	1 pc (for L≥1500mm)
Mounting accessories	1 package



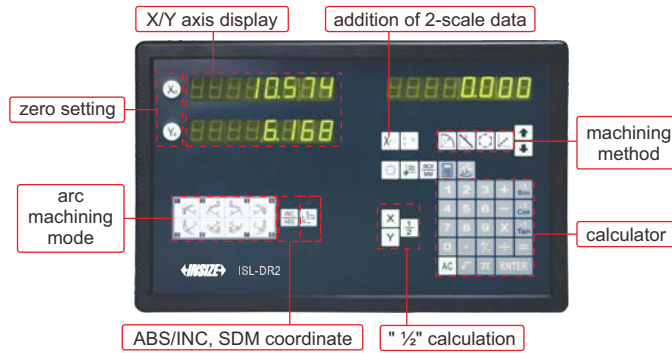

ISL-DR2

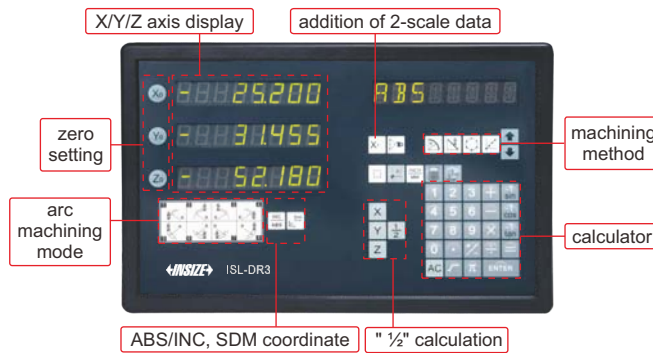

ISL-DR3



software flash disk (included)

- For ISL-A1, ISL-A5, ISL-B1, ISL-B5 series linear scales

### SPECIFICATION

Code	ISL-DR2	ISL-DR3
Application	two-axis	three-axis
Scale input ports	2	3
Resolution	0.05μm, 0.1μm, 0.2μm, 0.5μm, 1μm, 2μm, 5μm, 10μm, 20μm, 50μm	
Functions	addition of 2-scale data, linearity error compensation, smoothing, RS232C interface unit, BCD code out, zero setting, preset, resolution setting, counting direction setting, inch/mm conversion, ABS/INC conversion, expansion/contraction coefficient setting, "1/2" calculation, detecting RI, bolt-hole circle machining, ramp circle machining	
Power supply	110/220V, 50/60Hz	
Dimension	295×185×45mm	
Weight	1.45kg	

### STANDARD DELIVERY

Main unit	1 pc
Mounting bracket	1 pc
Ground cable	1 pc
RS232C cable	1 pc
Software flash disk for RS232C	1 pc



mounting bracket (included)

## DIGITAL READOUTS CODE ISL-LCD7



- 7.57 inch LCD display
- Language: English, Simplified Chinese, Traditional Chinese
- Can be connected with ISL-A1, ISL-A5, ISL-B1, ISL-B5 series linear scales



### SPECIFICATION

Application	three-axis: X/Y/Z
Scale input ports	3
Resolution	0.05μm, 0.1μm, 0.2μm, 0.5μm, 1μm, 2μm, 5μm, 10μm, 20μm, 50μm
Function	X/Y/Z addition of 3-scale data, linearity error compensation, smoothing, RS232C interface unit, BCD code out, zero setting, preset, resolution setting, counting direction setting, inch/mm conversion, ABS/INC conversion, expansion/contraction coefficient setting, "1/2" calculation, detecting RI, bolt-hole circle machining, ramp circle machining, circular arc machining, oblique surface machining, automatic edge finding, discharge machining
Dimension	200×88×260mm
Weight	1.26kg

### STANDARD DELIVERY

Main unit	1 pc
Mounting bracket	1 pc
Ground cable	1 pc
RS232C cable	1 pc
Software flash disk for RS232C	1 pc

## LINEAR SCALE AND READOUT SET FOR LATHE CODE ISL-SET1



software flash disk (included)

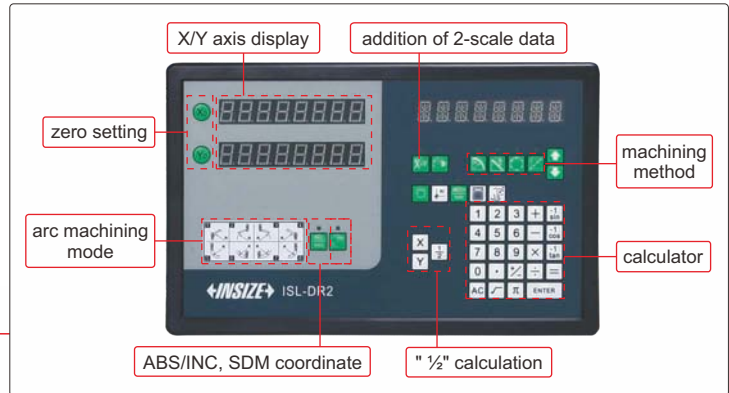

- Optical TTL (Through-The-Lens) detection. These optical TTL linear scales use an transistor logic to transmit and record high-resolution distance measurements

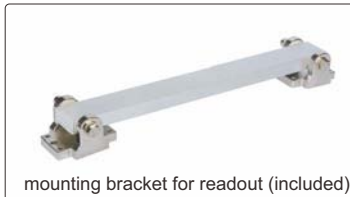

mounting bracket for readout (included)

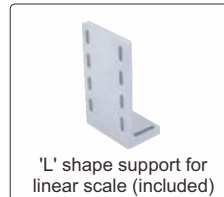

'L' shape support for linear scale (included)



anti-dust cover for linear scale (included)

### READOUT SPECIFICATION

Application	two-axis
Scale input ports	2
Resolution	1 $\mu$ m
Functions	addition of 2-scale data, linearity error compensation, smoothing, RS232C interface unit, BCD code out, zero setting, preset, resolution setting, counting direction setting, inch/mm conversion, ABS/INC conversion, expansion/contraction coefficient setting, "1/2" calculation, detecting RI, bolt-hole circle machining, ramp circle machining
Power supply	110/220V, 50/60Hz
Dimension	295×185×45mm
Weight	1.45kg

### LINEAR SCALE SPECIFICATION

X-axis	200mm
Y-axis	1000mm
Max. response speed	50m/min
Scale grating pitch	20 $\mu$ m
Scale reference point pitch	50mm
Accuracy	$\pm(5+5L/1000)\mu$ m L is the effective length in mm
Cable length	200mm scale: 3.5m, 1000mm scale: 5m

### STANDARD DELIVERY

Readout box	1 pc
200mm linear scale	1 pc
1000mm linear scale	1 pc
Mounting bracket for readout	1 pc
Ground cable for readout	1 pc
RS232C cable for readout	1 pc
Software flash disk for RS232C of readout	1 pc
'L' shape support for linear scale	1 pc
Anti-dust cover for linear scale	1 pc
Mounting accessories for linear scale	1 package

## DIGITAL HORIZONTAL SCALES

DATA OUTPUT



7101-300A

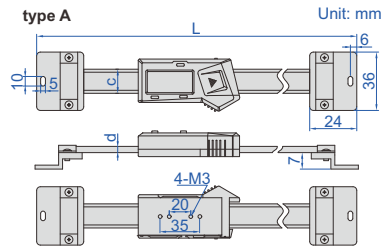

7101-400A

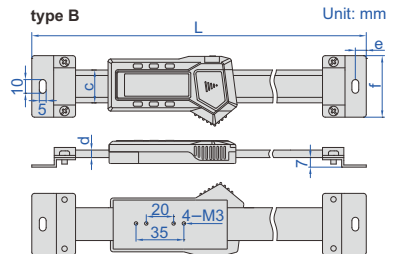

- Non waterproof
- Resolution: 0.01mm/0.0005"
- Buttons type A: on/off, zero, mm/inch, type B: on/off, zero, mm/inch, ABS, data preset
- Automatic power off, move the digital unit to turn on power
- Battery CR2032
- Data output
- Made of stainless steel
- Supplied with bracket to be mounted on the back

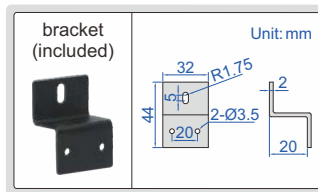

example of application

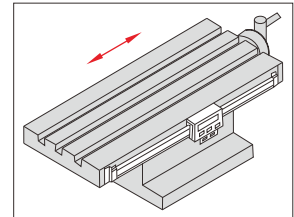

With data interface  
(data output cable code 7315-21 need receiver page 4,  
7302-21 page 12, 7305-21 page 8, optional)

(mm)

Code	Range	Type	Accuracy	L	c	d
7101-100A	100mm	A	±0.02mm	215	16	4
7101-150A	150mm	A	±0.03mm	265	16	4
7101-200A	200mm	A	±0.03mm	315	16	4
7101-300A	300mm	A	±0.04mm	445	16	4

With data interface  
(data output cable code 7315-22 need receiver page 4,  
7302-22 page 12, 7305-22 page 8, optional)

(mm)

Code	Range	Type	Accuracy	L	c	d	e	f
7101-400A	400mm	B	±0.05mm	590	24	5.5	8	45
7101-500A	500mm	B	±0.05mm	690	24	5.5	8	45
7101-600A	600mm	B	±0.08mm	790	24	5.5	8	45
7101-800A	800mm	B	±0.10mm	990	24	5.5	8	45
7101-1000A	1000mm	B	±0.10mm	1240	31	10.5	10	60

## DIGITAL VERTICAL SCALES

DATA  
OUTPUT

example of application

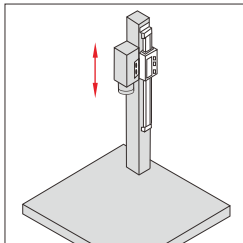

- Non waterproof
- Resolution: 0.01mm/0.0005"
- Buttons: on/off, zero, mm/inch, ABS/INC, data hold, TOL, set
- Battery LR44, data output
- Made of stainless steel
- Supplied with bracket to be mounted on the back
- Optional accessory: wireless data transmission (transmitter code **7315-1150** need receiver page 6), data output cable (code **7302-SPC7** page 13, keyboard format), data output cable (code **7305-1150** page 9, serial port format)

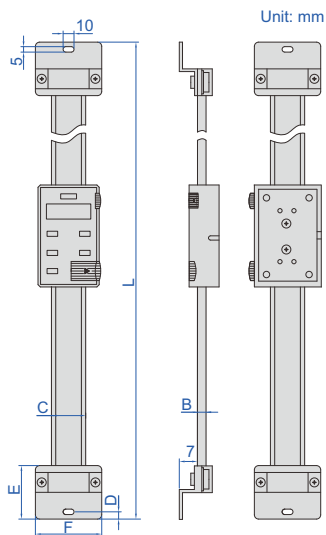

7102-300

(mm)

Code	Range	Accuracy	B	C	D	E	F	L
7102-100	100mm/4"	±0.02mm	4	20	6	24	40	245
7102-150	150mm/6"	±0.03mm	4	20	6	24	40	296
7102-200	200mm/8"	±0.03mm	4	20	6	24	40	345
7102-300	300mm/12"	±0.04mm	4	20	6	24	40	445
7102-400	400mm/16"	±0.05mm	4	20	6	24	40	545
7102-500	500mm/20"	±0.05mm	5.5	24	8	32	45	685
7102-600	600mm/24"	±0.08mm	5.5	24	8	32	45	785
7102-800	800mm/32"	±0.10mm	5.5	24	8	32	45	985
7102-1000	1000mm/40"	±0.10mm	10.5	31	9.5	40	60	1245

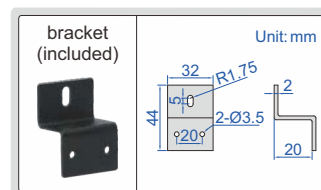

CUSTOM-MADE

## AIR GAGES CODE 9401-PB

air plug gage and  
standard rings



measure diameter of hole,  
range: Ø4~230mm

air ring gage and  
standard plain plug gages



measure diameter of shaft,  
range: Ø4~160mm

air snap gage and  
standard column gages



measure diameter of shaft,  
range: Ø15~160mm

air taper gage and  
standard gages



# AIR GAGE DISPLAY CODE 9408-QD100

DATA  
OUTPUT

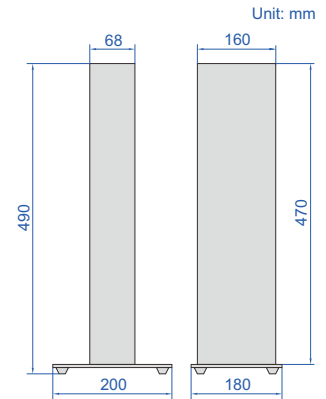
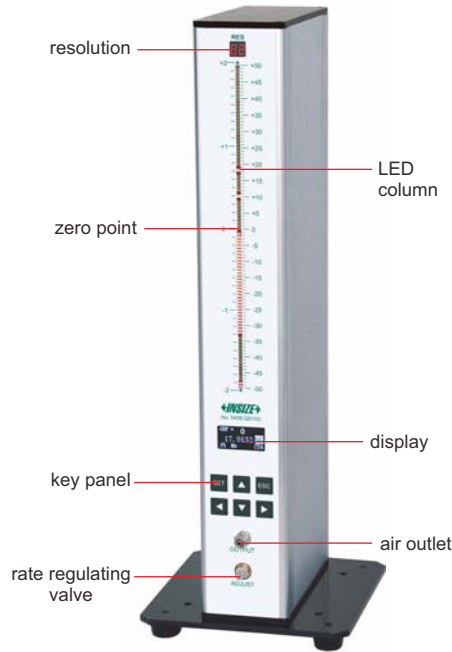
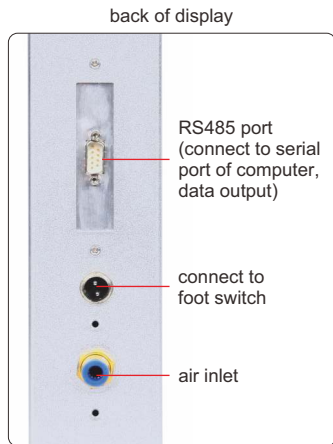

- Can store 10 measuring programs, and the program can be switched quickly
- Data storage function, support manual and automatic storing, 1500 groups data can be stored



foot switch (optional)



RS485 cable (optional)



pressure regulating valve (optional)



air filter (optional)

## SPECIFICATION

LED quantity	101 pcs			
LED color	red, orange, green			
LED height	254mm			
Range, resolution and accuracy	range	resolution		accuracy
		LED	display	
	10 $\mu$ m	0.1 $\mu$ m	0.1 $\mu$ m	0.2 $\mu$ m
	20 $\mu$ m	0.2 $\mu$ m	0.1 $\mu$ m	0.4 $\mu$ m
	50 $\mu$ m	0.5 $\mu$ m	0.1 $\mu$ m	1 $\mu$ m
	100 $\mu$ m	1 $\mu$ m	0.1 $\mu$ m	2 $\mu$ m
Unit	mm, $\mu$ m			
Air supply	dry and clean, 0.4~0.8MPa			
Data interface	RS485			
Operation temperature	-20~45°C			
Power supply	110~220V, 50/60Hz			
Dimension (L×W×H)	200×180×490mm			
Weight	4.5kg			

## STANDARD DELIVERY

Main unit	1 pc
-----------	------

## OPTIONAL ACCESSORY

Air filter	9401-FILTER-A
Pressure regulating valve	9404-PRV
RS485 cable	9408-CB
Foot switch	9408-FS
Data output cable (keyboard format)	7302-9408

DATA  
OUTPUT

## AIR LEAKAGE TESTER CODE ALT-P150

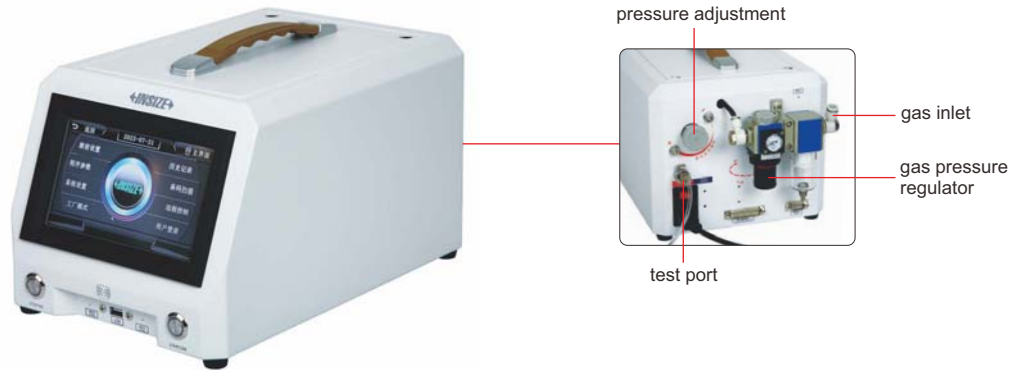

- Smart operation system with touch screen, operation UI based on testing procedure
- High sensitivity pressure sensor and adjustment unit with software algorithm ensure high accuracy and stability
- Test pressure range: -100~1000kPa, positive and negative pressure mode with 8 basic test mode
- Up to 100 groups of subprogram, each can be edited separately, for individual or combination testing
- Built-in communication interface, MODBUS and TCP/IP communication protocol supported
- Pressure curve screenshot and history data can export to flash disk
- Accessories such as testing tooling and fixture, inflatable bypass, fast connector, standard leak can be customized for different products; optional electronic regulator enables multiple sets of pressure sequence testing
- Language: English, Chinese



standard leak (optional)



quick connector (optional)



scanner (optional)



tooling and fixture (optional)

### SPECIFICATION

Device type	direct pressure
Channel	single-channel (customizable dual-channel)
Pressure mode	positive and negative pressure
Range	-60~150kPa
Resolution	0.1Pa
Accuracy	±0.2%FS
Pressure unit	kPa, Pa, kgf/cm <sup>2</sup> , psi, mmH <sub>2</sub> O, bar, mbar, mmHg
Flow unit	SCCM
Test medium	compressed air or specified gas, 0.4~0.8MPa
Tube caliber	gas inlet: 8mm, test port: 4mm
Pressure regulation	mechanical pressure regulator
Interface	USB, RS232, 25 PIN I/O interface, RJ45 (optional)
Operation environment	temperature: 0°C~50°C, humidity: ≤95%RH, no condensation
Power supply	AC 220V (±15%), 50Hz
Dimension (L×W×H)	340×225×187mm
Weight	7.3kg

\* Available range-80~0kPa, -80~600kPa, 0~200kPa, 10~700kPa;  
other ranges customizable

### STANDARD DELIVERY

Main unit	1 pc
Gas pressure regulator	1 pc

### OPTIONAL ACCESSORY

Tooling and fixture	customizable according to specific products
Software	ALT-P150-SW
Standard leak	ALT-P150-LK
Quick connector	ALT-P150-CO
Scanner (with scan software)	ALT-P150-SC

# LASER SCAN MICROMETERS

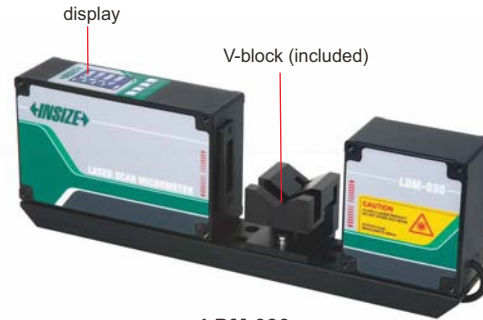
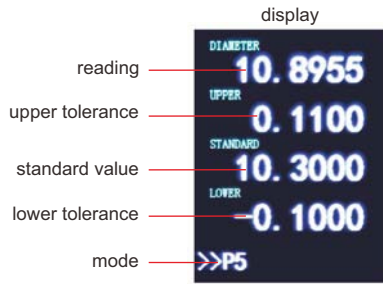

LDM-030

- Measure outer diameter, ellipticity, run-out, maximum diameter of tools, etc.
- Can be used for transparent or non transparent workpieces
- Tolerance measurement
- Online or offline measurement
- Connected with computer, PLC, control box

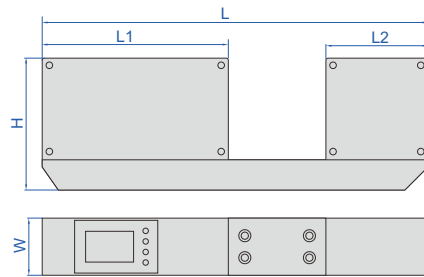

Dimension (mm)

Code	LDM-030	LDM-065
L	351	469
W	52	52
H	120	146
L1	170	203
L2	95	131

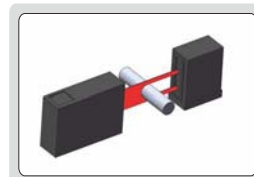

measure external diameter

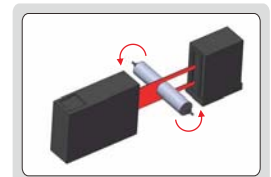

measure ellipticity and run-out

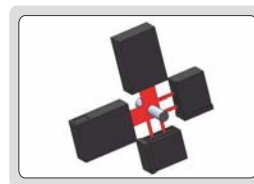

two-axis measurement

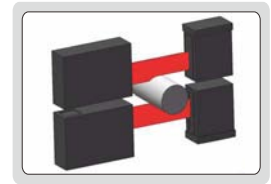

large size measurement



connect to control box (optional)



calibration gage (optional)

## SPECIFICATION

Code	LDM-030	LDM-065
Measuring range	0.1~30mm	0.5~65mm
Resolution	0.01/0.1/1/10/100µm selectable	
25°C accuracy	±(0.5+10%D)µm, D is measuring diameter in mm	
Repeatability	±(0.3+5%D)µm, D is measuring diameter in mm	
Laser wave length	650nm	
Measuring speed	800~3200times/s (adjustable)	
Operation temperature	0~50°C	
Operation humidity	35~85RH without condensation	
Output	dual channel RS485	
Alarm output	24V, 1A	
Power supply	DC24V, 2A	
Dimension (L×W×H)	351×52×120mm	469×52×146mm
Weight	5kg	8kg

## STANDARD DELIVERY

Main unit	1 pc
V-block	1 pc
AC/DC adapter	1 pc
RS485 cable	1 pc

## OPTIONAL ACCESSORY

Calibration gage	custom made
Control box	custom made



# LASER SCAN MICROMETER CODE LDM-D090



calibration gage (optional)

- Can measure the width and thickness of flat cables and tapes
- Can measure the outer diameter of cables, pipes and wires
- Laser scanning technology, large measurement range, high accuracy, high repeatability
- Connected with PLC and PC with RS485 interface
- Use high-precision F (θ) mirror, the swing of the measured object does not affect the measurement

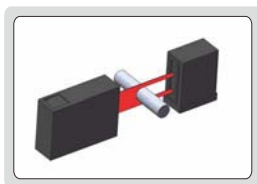

measure external diameter

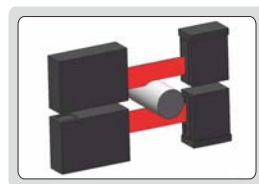

large size measurement

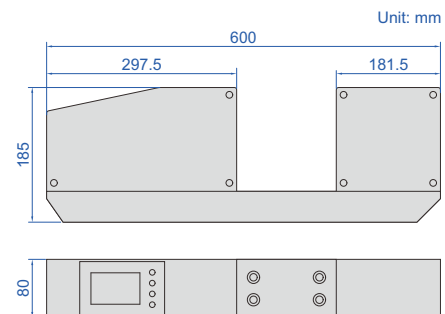

## SPECIFICATION

Measuring range	0.5~90mm
Resolution	1μm
25°C accuracy	±(5+20%D)μm, D is measuring diameter in mm
Repeatability	±(3+20%D)μm, D is measuring diameter in mm
Laser wave length	650nm
Measuring speed	600 times/s
Operation temperature	5~45°C
Operation humidity	≤80%RH without condensation
Output	RS485/MODBUS protocol
Alarm output	24V, 1A
Power supply	AC85V~220V (50~60Hz)
Dimension (L×W×H)	600×80×185mm
Weight	6.5kg

## STANDARD DELIVERY

Main unit	1 pc
V-block	1 pc
AC/DC adapter	1 pc
RS485 cable	1 pc

## OPTIONAL ACCESSORY

Calibration gage	custom made
------------------	-------------

## SPECTROMETER CODE OES-T350



**CUSTOMIZE**  
CAN CUSTOMIZE OTHER METAL MATRIX DETECTION,  
SUCH AS: Fe (004~009), Al, Cu, Zn, Ti, Ni, Pb, etc



printer (included)



filter element (included)



electrode brush (included)



single-phase AC voltage  
regulator (included)



pressure valve (included)



calibration sample (included)



gray iron control sample  
(optional)



15# carbon steel control  
sample (optional)

- The standard machine can do analysis Fe 001~003
- The full-spectrum technology covers the full range of element analysis, which can determine trace amounts of carbon (C), phosphorus (P), sulfur (S) and other elements
- The analysis speed is fast, and the element composition of all channels is measured within 20 seconds
- Paschen-Runge structure with full wavelength coverage, the most concise and stable optical system structure
- Perfect aberration correction, so that the spectrometer has excellent resolution, minimize the cross interference of different elements
- Argon-filled optical chamber, effectively reducing the attenuation of P and S rays in the far ultraviolet region
- The software has automatic spectrum correction technology, can store database, trace historical data, output and print reports
- Report format can be customized, data can be sent out

To be continued



Continued from previous page

**SPECIFICATION**

<b>Optical system</b>	<b>optical structure</b>	paschen-runge structure
	<b>rowland circle of diameter</b>	350mm
	<b>wavelength range</b>	160~510nm
	<b>detector</b>	multi high resolution CCD detectors
	<b>pixel resolution</b>	20pm
	<b>full spectrum</b>	cover the full range of element analysis
	<b>light room temperature</b>	34±0.5°C (be controlled automatically)
<b>Spark source</b>	<b>type</b>	digital arc and spark source/new plasma generator
	<b>spark frequency</b>	100~1000Hz
	<b>plasma current</b>	1~80A
	<b>ignition voltage</b>	>7000V
<b>Spark stand</b>	spray discharge electrode technology reduces argon consumption and improves argon use efficiency	
	good heat dissipation, continuous excitation for 100 times, the temperature of the excitation table does not rise more than 5°C	
<b>Others</b>	<b>measurable elements</b>	Fe base, Al base, Cu base, Zn base, etc
	<b>operation temperature</b>	10~30°C, 23±2°C is recommended
	<b>operation humidity</b>	20%~80%RH
	<b>power</b>	AC220V/50Hz
	<b>power consumption</b>	excitation: 300W, stand by: 40W
	<b>argon quality</b>	99.999% high purity argon, argon pressure≥4MPa
	<b>argon consumption</b>	5L/min during spark mode
	<b>dimension (LxWxH)</b>	700x660x340mm
<b>weight</b>	30kg	

**STANDARD DELIVERY**

<b>Main unit</b>	1 pc
<b>Computer</b>	1 pc
<b>Software</b>	1 pc
<b>Printer</b>	1 pc
<b>Calibration sample</b>	1 pc
<b>Electrode brush</b>	2 pcs
<b>Filter element</b>	2 pcs
<b>Single-phase AC voltage regulator</b>	1 pc
<b>Pressure valve</b>	1 pc

**OPTIONAL ACCESSORY**

<b>Control sample</b>	custom specifications
<b>Argon cylinder</b>	<b>OES-T350-ARGON</b>
<b>Grinding prototype</b>	code: <b>OES-T350-GRIND</b> for ferrous metal sample preparation
<b>Small lathe</b>	code: <b>OES-T350-LATHE</b> for non-ferrous metal sample preparation
<b>Argon purifier</b>	<b>OES-T350-PURIFIER</b>

# X RAY FLUORESCENCE SPECTROMETER (RoHS DETECTOR/ALLOY COMPOSITION ANALYZER/COATING THICKNESS GAGE) CODE XRF-B210



CALIBRATION CURVE CAN BE CUSTOMIZED  
ACCORDING TO CUSTOMER REQUIREMENTS

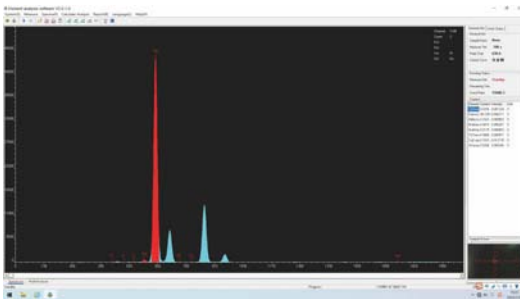

alloy composition analysis software (included)

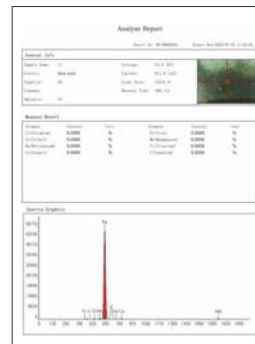

alloy composition analysis report (included)

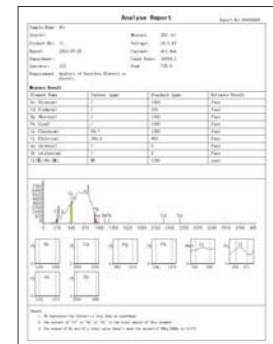

RoHS test report (included)

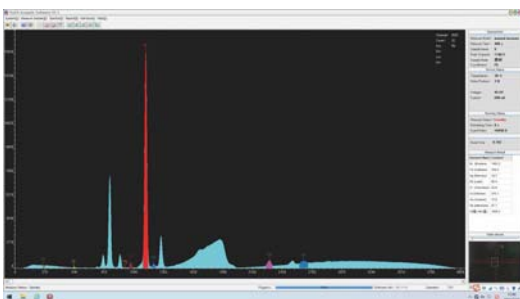

RoHS test software (included)



coating thickness test report (included)

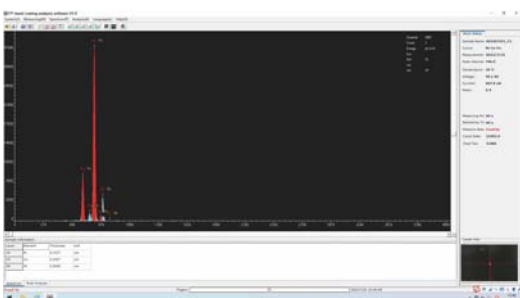

coating thickness detection software (included)

To be continued



Continued from previous page

- Used for RoHS detection, alloy element analysis, coating thickness measurement
- Using SI-PIN detector with electric cooling, small size, accurate data analysis and low maintenance cost
- Seven optical path correction and collimation system, automatically switch according to different samples
- Multiple radiation leakage prevention design
- The temperature monitoring technology ensures the safe and reliable operation of the X-ray source
- Dedicated software, standard window design, friendly interface, easy to operate
- Can display multiple spectrograms at the same time and print multiple report forms
- USB3.0 interface to ensure accurate, high-speed and efficient data transmission

**SPECIFICATION**

<b>Detector</b>	<b>type</b>	Si-PIN electrical refrigeration semiconductor detector	
	<b>resolution</b>	149±5 EV	
	<b>amplifier circuit module</b>	detect the sample characteristic X-ray, further enlarge the information collected by detection	
<b>X ray excitation device</b>	<b>maximum output current</b>	1mA	
	<b>power</b>	50W, air cooling	
<b>High and low voltage power</b>	<b>maximum output voltage</b>	50KV, built-in voltage overload protection	
	<b>minimum output voltage</b>	5KV	
<b>Multi-channel pulse amplitude analyzer</b>		maximum channel number: 4096	
<b>Optical path filter module</b>		reduce interference light path in the process of sending x-rays, guarantee the accuracy of the detector signal	
		Integrate the collimator with the filter	
<b>Collimator automatic switching module</b>		7 kinds, Ø0.5~Ø8mm	
<b>Filter automatic switching module</b>		5 kinds (free to choose and switch)	
<b>RoHS analysis software</b>	<b>elemental analysis range</b>	S~U	
	<b>harmful element analysis</b>	Cd, Pb, Hg, Br, Cr, Cl, As, Sb	
	<b>test time</b>	60~200s	
	<b>detection limit</b>	2PPM	
	<b>content analysis range</b>	2PPM~99.9%	
<b>Alloy analysis software</b>	<b>elemental analysis range</b>	Ti~U	
	<b>detection limit</b>	100PPM	
	<b>content analysis range</b>	100PPM~99.9%	
	<b>repeatability</b>	0.1%	
	<b>stability</b>	0.1%	
<b>Metal coating analysis software</b>	<b>elemental analysis range</b>	Ti~U	
	<b>detection limit</b>	0.01µm	
	<b>analysis thickness</b>	single layer thickness	0.01~30µm
		3 layer thickness	≤10µm
	<b>repeatability</b>	0.1µm (for outside coating less than 1µm)	
	<b>stability</b>	0.1µm (for outside coating less than 1µm)	
<b>light spot</b>	within 0.2mm		
<b>Operation temperature</b>		10~30°C	
<b>Relative humidity</b>		10%~90%	
<b>Power</b>		AC 220V±5V	
<b>Dimension (L×W×H)</b>		700×460×370mm	
<b>Weight</b>		49kg	

**STANDARD DELIVERY**

<b>Main unit</b>	1 pc
<b>Standard sample</b>	1 pc
<b>Silver calibration</b>	1 pc
<b>Sample cup</b>	2 pcs
<b>Test film</b>	50 pcs
<b>Computer</b>	1 pc
<b>Printer</b>	1 pc
<b>Collimator (built-in)</b>	7 pcs
<b>Software</b>	RoHS test software, alloy composition analysis software, coating thickness detection software

# HAND-HELD SPECTROMETER CODE HSM-A310

**IP54**  
WATERPROOF



test



analysis

- Fast and non-destructive test to identify alloy grade and composition
- For all kinds of high and low temperature alloy steel, stainless steel, tool steel, chromium/molybdenum steel, nickel alloy, cobalt alloy, nickel/cobalt heat resistant alloy, titanium alloy
- Multiple tests, it can automatically calculate maximum value, minimum value and standard deviation
- IP54 dust/waterproof



## SPECIFICATION

Excitation source	50KV/200μA; Ag target, integrated end window, micro X-ray tube and high voltage power supply, matching power ≥4W
Detector	Si-PIN, window area 25mm <sup>2</sup>
Elemental analysis range	Ti, V, Cr, Mn, Fe, Co, Ni, Cu, Zn, Se, Zr, Nb, Mo, Rh, Pd, Ag, Cd, Sn, Sb, Hf, Ta, W, Re, Pb, Bi
Alloy analysis mode	1. automatically identify alloy grade 2. alloy material qualified test mode
Collimator filter	7 groups
Display	5-inch LCD touch screen
CPU	quad-core processor, 1.4GHz, 4G memory
Memory	built-in 64G, storage data, >500000 groups
Data transmission	built-in WIFI, U disk, bluetooth (support bluetooth printer)
Data export format	EXCEL, BMP, PDF, CSV
Battery	6800mAh lithium battery, for 8 hours working time
Air pressure compensation	built-in pressure measurement module for system compensation and correction
System	Win-IOT operation system
Work environment	temperature: 0~40°C, relative humidity: 10%~90%
Dimension	250x320x80mm
Weight	1.9kg

## STANDARD DELIVERY

Main unit	1 pc
Charger	1 pc
Battery	2 pcs
Test film	50 pcs
Sample cup	1 pc
Standard sample	1 pc
Protection support (including calibration silver)	1 pc
USB and cable	1 pc



standard sample (included)



protection support (included)



## TOOL PRESETTER (PROJECTOR TYPE) CODE TLP-P340

projection screen Ø120mm with scale  
(protractor with 1° graduation, radius with 0.2,  
0.4, 0.8, 1.2, 1.5, 2, 2.5, 3mm graduation)



- 99 data can be saved and printed



standard rod (included)



BT50/BT40 converter (optional)



BT50/BT30 converter (optional)

### SPECIFICATION

Maximum tool diameter (X axis)		Ø300mm
Height measuring range (Z axis)		30~400mm
Accuracy	X axis	±6µm
	Z axis	±13µm
Resolution		0.5µm
Diameter of projection screen		Ø120mm
Lens	magnification	20X
	view filed	Ø6mm
Illumination		24V/20W
Spindle holder		BT50
Power supply		220V, 50/60HZ
Dimension (L×W×H)		940×520×870mm
Weight		90kg

### STANDARD DELIVERY

Main unit	1 pc
BT50 spindle holder	1 pc
Standard rod	1 pc
Foot-switch	1 pc
Anti-dust cover	1 pc

### OPTIONAL ACCESSORY

BT50/BT30 converter	TLP-P340-C1
BT30 rod	TLP-P340-R1
BT50/BT40 converter	TLP-P340-C2
BT40 rod	TLP-P340-R2

# TOOL PRESETTER CODE TLP-400E



rotate the handwheel to rotate tools



standard rod (included)



BT50/BT40 converter (optional)



BT50/BT30 converter (optional)

- Absolute linear scales, zero setting is not needed after power on and off

### SPECIFICATION

Maximum tool diameter (X axis)	Ø300mm
Height measuring range	60~400mm
Repeatability	0.005mm
Measuring accuracy	0.01mm
Linear scale resolution	0.001mm
Dial indicator graduation	0.001mm
Spindle holder	BT50
Power supply	110/220V, 50/60HZ
Dimension (L×W×H)	720x480x930mm
Weight	150kg

### STANDARD DELIVERY

Main unit	1 pc
BT50 spindle holder	1 pc
Standard rod	1 pc
Dial indicator	2 pcs
Wrench	1 set
Anti-dust cover	1 pc

### OPTIONAL ACCESSORY

BT50/BT30 converter	TLP-300H-C1
BT50/BT40 converter	TLP-300H-C2



# TOOL PRESETTER (BASIC TYPE) CODE TLP-300H



standard rod (included)



BT50/BT40 converter (optional)



BT50/BT30 converter (optional)

- Absolute linear scales, zero setting is not needed after power on and off

### SPECIFICATION

Maximum tool diameter (X axis)	Ø300mm
Height measuring range	60~300mm
Repeatability	0.005mm
Measuring accuracy	0.02mm
Linear scale resolution	0.005mm
Dial indicator graduation	0.01mm
Spindle holder	BT50
Power supply	110/220V, 50/60HZ
Dimension (L×W×H)	600x365x690mm
Weight	68kg

### STANDARD DELIVERY

Main unit	1 pc
BT50 spindle holder	1 pc
Standard rod	1 pc
Dial indicator	2 pcs
Wrench	1 set
Anti-dust cover	1 pc

### OPTIONAL ACCESSORY

BT50/BT30 converter	TLP-300H-C1
BT50/BT40 converter	TLP-300H-C2



Digital Ultrasonic Flaw Detectors  
Page 531-532



Portable Magnetic Powder Flaw  
Detectors  
Page 533



UV Flaw Detection Lights  
Page 534



Penetration Standard Test Blocks  
Page 534-535



Black And White Densitometers  
Page 535



## DIGITAL ULTRASONIC FLAW DETECTOR CODE UFD-T680

- The all-aluminum metal shell is strong and durable, and the electromagnetic shielding performance is very good
- Tempered glass panel, extremely hard, wear-resistant and scratch-resistant
- Full-digital multi-color high resolution (640×480 pixels) TFT LCD display
- 4 operation interface styles can be selected according to the environment
- Real-time screenshots of all pages and flaw detection reports, and save them as BMP pictures to U disk
- Export the flaw detection report as a PDF file
- Unique Fn multifunction key design
- There is no limit of the number and duration of video recording through U disk
- Memory of 500 channel files to store calibration setups and probe parameter
- Memory of 1000 wave report files to store A-Scan wave and settings
- Two fully independent gates offer a range of measurement options for signal height or distance using peak triggering
- Can choose to set the incoming wave alarm or lost wave alarm, accompanied by LED light display
- Selectable frequency ranges (automatically set by the instrument) to match probe for optimum performance
- The unique automatic gain adjustment and gain scanning function make flaw detection fast and accurate



straight-beam probe  
(included)



angle-beam probe  
(included)



USB disk  
(included)



couplant (included)

### FUNCTIONS

<b>Flaw detection standard</b>	built-in common flaw detection standards, direct call, convenient and fast
<b>Auto calibration</b>	automatic calibration of probe zero offset, probe angle (K value) and material velocity
<b>Peak hold</b>	compare frozen peak waveforms to live A-Scans to easily interpret test result
<b>Flaw locating</b>	live display sound-path, projection (surface distance), depth, amplitude
<b>Flaw discrimination</b>	automatic flaw sizing using AVG or DAC, speeds reporting of defect acceptance or rejection
<b>Flaw sizing</b>	the equivalent dB value of defects or equivalent size of defects are displayed in real time
<b>Curved surface correction</b>	used for flaw detection of curved workpiece, it can display the circumferential position of defects in real time
<b>DAC/AVG</b>	the curve is automatically generated, and the sampling points can be compensated and corrected. The curve automatically floats with the gain, automatically expands with the detection distance, and automatically moves with the delay time. It can display the AVG curve of any aperture
<b>AWS D1.1</b>	choosing this standard can reduce manual calculations and improve detection efficiency
<b>Weld diagram</b>	support V type, T type, L type and other weld types, acoustic path navigation real-time display, weld and defect location real-time display, scaling, easy to locate defects
<b>Automatic rating</b>	select different AWS standards, automatically calculate the rating of defects and display
<b>Crack height</b>	the crack height is measured and calculated automatically by the diffracted wave at the end
<b>Gate magnify</b>	spreading of the gate range over the entire screen width
<b>Continuous record</b>	video recording and playback
<b>Echo coding</b>	display 1~9 echo display area in different colors, used to analyze the defect position
<b>Scan freeze</b>	display freeze holds waveform and test distance data
<b>Peak mark</b>	capture and mark the peak in real time
<b>B scan</b>	intuitively display the defect shape of the workpiece and the detection result is more intuitive

To be continued

Continued from previous page

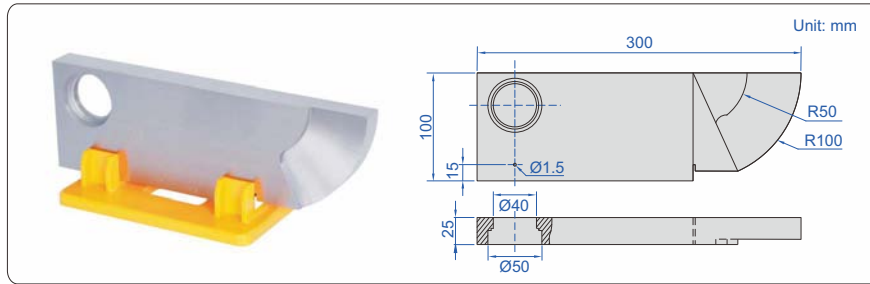

calibration block (optional)

## SPECIFICATION

Measuring range	0~15000mm
Working frequency	0.2~20MHz
Material velocity	100~20000m/s
Repetition frequency	20~2000Hz
Dynamic range	≥36dB
Vertical linearity	≤1.5%
Horizontal linearity	≤0.1%
Resolving power	>42dB
Sensitivity leavings	>65dB
Suppression	0~80%
Noise	≤10%
Probe selection	single crystal probe, dual crystal probe, penetrating probe, climbing probe
Pulse energy	100V, 200V, 250V, 300V, 350V, 400V, 450V, 500V (selectable)
Pulse width	30ns-510ns
Probe damping	50Ω, 150Ω, 250Ω, 500Ω (selectable)
Rectification	positive half wave, negative half wave, full wave, RF
Gates	two independent gates controllable over entire sweep range
Interface	USB 2.0
Operation temperature	-10~50°C
Relative humidity	20~95%RH
Power	build-in rechargeable battery
Size	263×170×61mm
Weight	1.92kg

## STANDARD DELIVERY

Main unit	1 pc
Single-element straight probe UFD-T60	1 pc
Single-element angle probe UFD-T61	1 pc
USB cable	1 pc
Couplant	1 bottle
Probe connecting cable	1 pc
USB disk	1 pc
Power adapter	1 pc

## OPTIONAL ACCESSORY

Calibration block	UFD-CSK1
-------------------	----------

## SPECIFICATION OF PROBE

Code	Frequency	Size	Probe type	Transducer sensor angle
UFD-T60 (included)	2.5MHz	Ø20mm	single-element straight probe	90°
UFD-T61 (included)	4.0MHz	8x9mm	single-element angle probe	60°
UFD-T62 (optional)	5.0MHz	Ø10mm	dual-element straight probe	90°
UFD-T63 (optional)	5.0MHz	Ø10mm	single-element straight probe	90°
UFD-T64 (optional)	4.0MHz	8x9mm	single-element angle probe	45°
UFD-T65 (optional)	4.0MHz	8x9mm	single-element angle probe	70°

Note: Other types of the probes are available



## PORTABLE MAGNETIC POWDER FLAW DETECTORS

- Conformity to standards JB/T7411-2012 ASTM E1444-05 ASTM E709 EN10228-1:1999 ISO 9934 ASTM E3024
- Multiple power supply modes available



MPI-P110



DC battery pack 4400mAh (optional)



AC battery pack 6600mAh (optional)

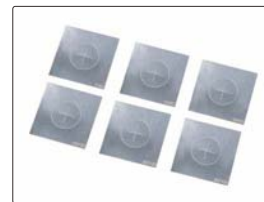

A1 standard sensitivity test piece (optional)



45N lifting force test block (optional)



177N lifting force test block (optional)



magnetic pole slope angle A (optional)



magnetic pole slope angle B (optional)



bag (optional)

### SPECIFICATION

Code	MPI-P110	MPI-P220	MPI-P330
Magnetic field strength	>2KA/m		
Sensitivity	15/50 engraved groove clearly displayed on A1 standard sensitivity test piece		
Illumination	—	white light $\geq 2320$ Lux	UV lamp $\geq 5220\mu\text{W}/\text{cm}^2$
Duty cycle	>50% maximum excitation time 90 seconds		>30%
Lifting power	AC	$\geq 4.5\text{kg}$ (44N)	
	DC	$\geq 18.1\text{kg}$ (177N)	
Magnetic pole spacing	0-230mm		
Magnetic pole size	22×22mm		
Power supply	AC220V, 50Hz (DC battery pack or AC battery pack are optional)		
Operation temperature	-10~40°C		
Relative humidity	<80% (no condensation)		
Dimension (L×W×H)	235×50×195mm		
Weight	2.3kg		

### STANDARD DELIVERY

Main unit	1 pc
-----------	------

### OPTIONAL ACCESSORY

DC battery pack 4400mAh	MPI-PDC440
AC battery pack 6600mAh	MPI-PAC660
A1 standard sensitivity test piece	MPI-PA1
45N lifting force test block	MPI-P45N
177N lifting force test block	MPI-P177N
Magnetic pole slope angle A	MPI-PMA
Magnetic pole slope angle B	MPI-PMB
Bag	MPI-PBG

## RECHARGEABLE UV FLAW DETECTION LIGHT CODE MPI-HF360

- UV-B content is 0
- Without preheating, instant start, instant on/off, no need to wait
- Supplied with glass filter
- External surface temperature increase <8K (8°C) for continuous working

goggles (included)



### SPECIFICATION

UV (light) Lux	about 6000 $\mu$ W/cm <sup>2</sup>
UV light power	UV LED-12VA
Covering area	diameter approximately 300mm (calibrated at 381mm distance)
FLUX error	$\pm$ 10% (at 0°C~40°C)
White light content	$\leq$ 20LUX
Lighting characteristics	center lighting
Wavelength	room temperature 25°C, 365nm $\pm$ 3nm (UVA)
Power supply	12V rechargeable lithium battery
Battery capacity	3500mAh
Charging time	3~4h
Battery life	UV LED 5~6h
Dimension	175 $\times$ 75 $\times$ 170mm
Weight	750g (including battery)

### STANDARD DELIVERY

Main unit	1 pc
Battery	2 pcs
Charger	1 pc
Goggles	1 pc

## UV FLAW DETECTION LIGHT CODE MPI-HD130



### STANDARD DELIVERY

Main unit	1 pc
Battery	2 pcs
Charger	1 pc

### SPECIFICATION

UV (light) Lux	6000~11000 $\mu$ W/cm <sup>2</sup>
UV light power	UV LED-3W
FLUX error	$\pm$ 10% (at 0°C~40°C)
Lighting characteristics	center lighting
Wavelength	room temperature 25°C, 365nm $\pm$ 3nm (UVA)
Power supply	3.7V rechargeable lithium battery
Battery capacity	2600mAh
Charging time	2h~3h
Battery life	UV LED 3h~4h
Dimension	180 $\times$ 47mm
Weight	260g (including battery)



- UV-B content is 0
- No need to wait, instantly reaches 100% power
- Supplied with glass filter
- External surface temperature increase <5K (5°C) for continuous working

## PENETRATION STANDARD TEST BLOCK CODE ISU-PB3

- Comply with ASME standard requirements
- The test block shows the number and clarity of lines of radiating cracks to determine the sensitivity level
- Suitable for verifying the sensitivity and operational accuracy of penetrants, as well as for testing the corrosion of stainless steel materials by penetrants



### SPECIFICATION

Type	JB/T6064 B3 type
Surface treatment	chrome plating
Material	stainless steel

### STANDARD DELIVERY

B3 test block	1 pc
B3 test block display image	1 pc

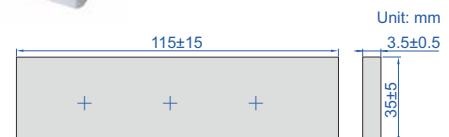



## PENETRATION STANDARD TEST BLOCK CODE ISU-PB5

- Meets NB/47013.5 and ASME standards
- This test block is a means of verifying the sensitivity and operational accuracy of the penetrant, and has a rough surface in the sandblasting area to verify the cleaning performance of the penetrant and the accuracy of the cleaning method. Its sensitivity is determined by the number of defects displayed and the diameter of each point in the radial domain. It is a functional standard test block

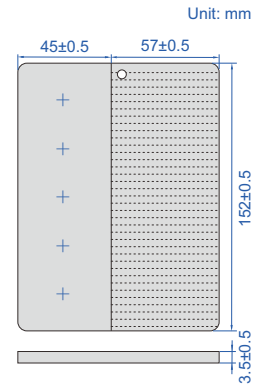

### SPECIFICATION

Type	JB/T6064 B5 type
Surface treatment	chrome plating
Material	stainless steel

### STANDARD DELIVERY

B5 test block	1 pc
B5 test block display image	1 pc

## BLACK AND WHITE DENSITOMETER CODE RXT-BM301



black and white density film  
(0.0~5.0, included)



- With accurate reading, good stability, easy to operate
- Small size, light weight, 27 LED lighting source, good shock resistance
- Comes with calibration software and standard black and white density film, allowing self calibration of instruments
- Suitable for industries such as non-destructive testing, photosensitive materials, printing, etc

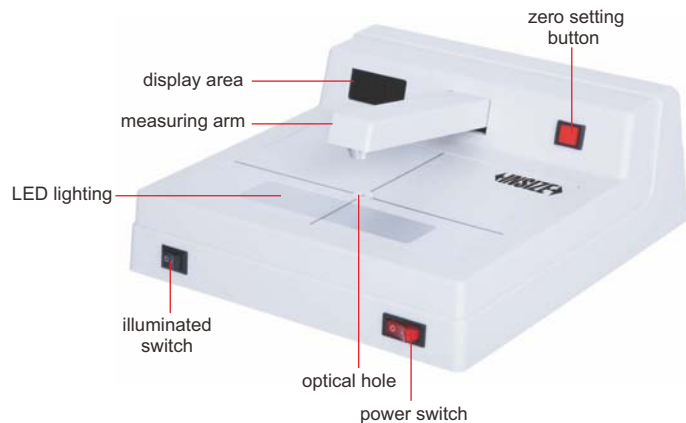

### SPECIFICATION

Blackness range	D=0.00~5.00
Reading stability	±0.02
Accuracy	±0.02 (0.0<D≤2.0) ±1% (2.0<D≤4.0) ±0.05 (4.0<D≤5.0)
Optical aperture	∅2mm
Sampling time	0.8s
Display form	three-digit display
Interface	RS232 (optional accessory USB cable)
Operation environment	0°C~40°C, relative humidity≤85%
Power supply	220V, 50/60Hz
Dimension	260×265×110mm
Weight	2.1kg

### STANDARD DELIVERY

Main unit	1 pc
Black and white density film (0.0~5.0)	1 pc
USB flash disk	1 pc
RS232 cable	1 pc

### OPTIONAL ACCESSORY

USB cable	RXT-BM301-CA
-----------	--------------



**CMM**  
Page 537-542



**Measuring Arms**  
Page 543-544



**Styli For CMM**  
Page 545-549



**CMM Check Masters**  
Page 549



**Gage Block Stands For CMM**  
Page 550



**Ceramic Ball Gages**  
Page 550



**Jigs For CMM**  
Page 551-557



Can be used in shop floor, with the following features:

- Temperature compensation system, suitable for wide temperature range
- Water and oil resistance
- Compact design, small size
- Three sides open, easy to load and unload workpieces
- Without compress air
- Easy installation

ATTENTION: ROTATION OF PROBE HEAD IS MANUAL

ATTENTION: MEASUREMENT ON THE LEFT SIDE OF WORKPIECES IS LIMITED

## MINI CNC CMM (SHOP FLOOR TYPE) CODE CMM-MN432



CMM-MN432

### FEATURES

- Integrated control system, safe, reliable and easy to operate
- High precision linear guide rail and ball screw for three axes
- 4 temperature sensors for X, Y, Z three axes and workpiece, suitable for wide temperature range

### CONTROL SYSTEM

- Double computer control systems
- Driven by DC servo motor
- The control system supports communication with machine tools
- The control system has 12 buttons for customize

### NET-DMIS SOFTWARE

- Can measure point, straight line, curve, circle, ellipse, plane, groove, cylinder, sphere, cone, ring, edge point, corner point, polygon, straightness, flatness, circularity, cylindricity, profile of a line, profile of a surface, perpendicularity, parallelism, angularity, coaxiality, concentricity, symmetry, position, composite position, circular runout and total runout
- Modular software structure, can support: temperature compensation, turning table, I/O interface
- Can program in offline mode and do virtual measurement based on CAD model, can extract the element features of CAD for programming
- Support dynamic point measurement and import DMO theoretical point coordinates for vector point measurement
- Can import and convert CAD model (SAT, IGES, STEP)
- Can select multi language, metric and inch, polar and straight coordinate system
- Have multiple export ways: export measured data (SAT, IGES, STEP), report windows (PDF, HTML, MHT, RTF, EXCEL, CSV, txt, images, WORD, etc.), custom EXCEL template
- Support uploading the measuring result to server

To be continued

Continued from previous page

### SPECIFICATION

<b>Code</b>	<b>CMM-MN432</b>
<b>Measuring range (X×Y×Z)</b>	400×200×300mm
<b>Resolution</b>	0.1μm
<b>Repeatability</b>	1μm
<b>Accuracy (L is measuring range in mm)</b>	±(4.5+L/200)μm (15°C~30°C, variation≤2°C/h) ±(5.5+L/200)μm (10°C~15°C, 30°C~40°C, variation≤2°C/h)
<b>Probe error</b>	±5μm
<b>Temperature</b>	10°C~40°C, variation≤2°C/h
<b>Humidity</b>	40~60%
<b>Power</b>	220V±10%, 50Hz
<b>Max. load</b>	50kg
<b>Dimension (L×W×H)</b>	1270×1110×1630mm
<b>Weight</b>	280kg

### STANDARD DELIVERY

<b>Main unit</b>		1 pc
<b>Probe system</b>	probe head *	1 pc
	probe *	1 pc
	styli **	1 set
<b>Calibration system</b>	datum sphere (Ø25mm)	1 pc
	pivot pillar	1 pc
<b>Computer system</b>	computer	1 pc
	printer	1 pc
<b>Temperature compensation system</b>		1 pc
<b>Software</b>		1 pc

\* The probe head and probe are Renishaw brand

\*\* The styli system includes styli and extensions

### PROBE (included) SPECIFICATION

<b>Probe head</b>	angular movement with horizontal axis	0°~90° in 15 steps
	angular movement with vertical axis	±180° in 15 steps
	control mode	manual
	number of positions	168
	probe mounting	M8
<b>Probe</b>	weight	210g
	detect direction	±X, ±Y, +Z
	styli mounting	M2
	rating life	>1000,000 times
	weight	22g

### EXTENSION (included) SPECIFICATION

Code	Material	Stem diameter	Length	Quantity
SE4	stainless steel	Ø3mm	10mm	1 pc
SE5			20mm	1 pc

### STYLUS (included) SPECIFICATION

Code	Material	Ball diameter	Length	Stem diameter	Effective working length	Quantity
PS2R	ruby ball / stainless steel stem	SØ2mm	20mm	Ø1.4mm	14mm	1 pc
PS17R		SØ4mm		Ø1.5mm	20mm	1 pc

## COORDINATE MEASURING MACHINES



### FEATURES

- X&Z axis beam are made of aviation aluminum
- RENISHAW steel scale
- High precision, rigid, pre-loaded air bearings on all axis

### RENISHAW UCC CONTROL SYSTEM

- High speed measurement & servo control system

### RATIONAL-DMIS SOFTWARE

- Unique operation interface, complete drag-and-drop operation
- Instructional programming allows users to replace text
- Intelligent recognition of the construction, calculation and output of relevant geometric elements
- Seamless link with CAD data

### RENISHAW PROBE BODY

- The TP20 is a touch trigger probe
- The TP200B is a touch triggered probe of electronic strain sensing technology, with high measurement accuracy and operate life
- The SP25M is high performance scanning and touch trigger probe



CMM-ST564A

### SPECIFICATION

Code	Range (X×Y×Z)	Probe body	MPEE	MPEP	Max. dimension of workpiece	Max. weight of workpiece	Overall dimension	Weight
	mm		μm	μm				
CMM-ST454A	400×500×400	TP20	±(2.1+3.3L/1000)	±2.2	525×995×600	500	1000×1240×2240	570
CMM-ST454B		TP200B	±(1.8+3.3L/1000)	±1.9				
CMM-ST454C		SP25M						
CMM-ST564A	500×600×400	TP20	±(2.1+3.3L/1000)	±2.2	625×1095×600	500	1100×1340×2240	700
CMM-ST564B		TP200B	±(1.8+3.3L/1000)	±1.9				
CMM-ST564C		SP25M						
CMM-ST686A	600×800×600	TP20	±(2.2+3.3L/1000)	±2.3	730×1400×800	700	1200×1650×2660	960
CMM-ST686B		TP200B	±(1.9+3.3L/1000)	±2.0				
CMM-ST686C		SP25M						
CMM-ST8106A	800×1000×600	TP20	±(2.2+3.3L/1000)	±2.3	930×1600×800	1000	1400×1850×2660	1270
CMM-ST8106B		TP200B	±(1.9+3.3L/1000)	±2.0				
CMM-ST8106C		SP25M						
CMM-ST10128A	1000×1200×800	TP20	±(2.7+3.3L/1000)	±2.7	1190×1814×1040	1800	1690×2370×3150	2460
CMM-ST10128B		TP200B	±(2.4+3.3L/1000)	±2.4				
CMM-ST10128C		SP25M						
CMM-ST10158A	1000×1500×800	TP20	±(2.7+3.3L/1000)	±2.7	1190×2114×1040	1800	1690×2670×3150	2820
CMM-ST10158B		TP200B	±(2.4+3.3L/1000)	±2.4				
CMM-ST10158C		SP25M						
CMM-ST10208A	1000×2000×800	TP20	±(2.7+3.3L/1000)	±2.7	1190×2614×1040	1800	1690×3270×3150	3410
CMM-ST10208B		TP200B	±(2.4+3.3L/1000)	±2.4				
CMM-ST10208C		SP25M						
CMM-ST121510A	1200×1500×1000	TP20	±(3.0+3.3L/1000)	±3.0	1390×2200×1200	2000	1890×2750×3330	3330
CMM-ST121510B		TP200B	±(2.7+3.3L/1000)	±2.7				
CMM-ST121510C		SP25M						
CMM-ST122010A	1200×2000×1000	TP20	±(3.0+3.3L/1000)	±3.0	1390×2700×1200	2000	1890×3350×3330	3910
CMM-ST122010B		TP200B	±(2.7+3.3L/1000)	±2.7				
CMM-ST122010C		SP25M						

To be continued

Continued from previous page

**SPECIFICATION**

Code	Range (X×Y×Z)	Probe body	MPEE	MPEP	Max. dimension of workpiece	Max. weight of workpiece	Overall dimension	Weight
	mm		µm	µm	mm	kg	mm	kg
CMM-ST152010A	1500×2000×1000	TP20	±(3.3+3.3L/1000)	±3.3	1690×2700×1200	3000	2190×3350×3370	5220
CMM-ST152010B		TP200B	±(3.0+3.3L/1000)	±3.0				
CMM-ST152010C		SP25M						
CMM-ST152510A	1500×2500×1000	TP20	±(3.3+3.3L/1000)	±3.3	1690×3200×1200	3000	2190×3850×3400	6680
CMM-ST152510B		TP200B	±(3.0+3.3L/1000)	±3.0				
CMM-ST152510C		SP25M						
CMM-ST153010A	1500×3000×1000	TP20	±(3.5+4L/1000)	±3.5	1690×3700×1200	3000	2260×3910×3420	8120
CMM-ST153010B		TP200B	±(3.2+4L/1000)	±3.2				
CMM-ST153010C		SP25M						
CMM-ST152512A	1500×2500×1200	TP20	±(3.5+4L/1000)	±3.5	1690×3200×1400	3000	2190×3850×3870	6730
CMM-ST152512B		TP200B	±(3.2+4L/1000)	±3.2				
CMM-ST152512C		SP25M						
CMM-ST152515A	1500×2500×1500	TP20	±(3.8+4L/1000)	±3.8	1680×3330×1700	3000	2190×3980×4500	6950
CMM-ST152515B		TP200B	±(3.5+4L/1000)	±3.5				
CMM-ST152515C		SP25M						
CMM-ST153015A	1500×3000×1500	TP20	±(4.0+4L/1000)	±4.0	1680×3830×1700	3000	2260×4040×4520	8440
CMM-ST153015B		TP200B	±(3.7+4L/1000)	±3.7				
CMM-ST153015C		SP25M						
CMM-ST163515A	1600×3500×1500	TP20	±(4.0+4L/1000)	±4.0	1780×4330×1700	3000	2360×4540×4520	9960
CMM-ST163515B		TP200B	±(3.7+4L/1000)	±3.7				
CMM-ST163515C		SP25M						
CMM-ST203015A	2000×3000×1500	TP20	±(4.5+4L/1000)	±4.5	2180×3930×1700	6000	2760×4240×4520	11200
CMM-ST203015B		TP200B	±(4.0+4L/1000)	±4.0				
CMM-ST203015C		SP25M						
CMM-ST203018A	2000×3000×1800	TP20	±(4.5+4L/1000)	±4.5	2180×3930×2000	6000	2760×4240×5120	11200
CMM-ST203018B		TP200B	±(4.0+4L/1000)	±4.0				
CMM-ST203018C		SP25M						

**STANDARD DELIVERY**

Main unit		1 pc
Probe system	probe head (Renishaw)	1 pc
	probe body (Renishaw)	1 pc
	styli (Renishaw)	1 set
Calibration sphere	Ø19mm	1 pc
Computer		1 pc
Printer		1 pc
Software		1 pc

**OPERATION ENVIRONMENT**

Air pressure	0.5~1.0MPa
Air supply	0.3~0.45m <sup>3</sup> /min
Temperature	20±2°C
Humidity	55%~65%
Power	220V±10%, 50/60Hz

**STYLI INCLUDED IN SP25M**

Material	Ball diameter	Length	Quantity
ruby ball/ stainless steel stem	SØ2mm	21mm	2 pcs
	SØ3mm	21mm	2 pcs
	SØ4mm	21mm	2 pcs
	SØ2mm	30mm	2 pcs
	SØ3mm	40mm	2 pcs
	SØ4mm	50mm	2 pcs
	SØ6mm	75mm	2 pcs
	stainless steel stem	—	20mm

**PROBE HEAD SPECIFICATION**

Probe head (PH10T)	angular movement with horizontal axis	0°~105° in 7.5 steps
	angular movement with vertical axis	±180° in 7.5 steps
	number of positions	720
	probe mounting	M8
	max. output torque	0.45N.m
	max. extension length	300mm
	weight	645g
Probe body	detect direction	±X, ±Y, +Z
	styli mounting	M2
	rating life	>1000,000 times

**STYLI INCLUDED IN TP20 AND TP200B**

Material	Ball diameter	Length	Quantity
ruby ball/ stainless steel stem	SØ1mm	10mm	1 pc
	SØ2mm	20mm	1 pc
	SØ3mm	20mm	1 pc
	SØ3mm	30mm	1 pc
	SØ4mm	10mm	1 pc
	SØ4mm	30mm	1 pc
	SØ4mm	40mm	1 pc
	SØ5mm	20mm	1 pc
stainless steel stem	—	10mm	1 pc
	—	20mm	1 pc
	—	30mm	1 pc

## COORDINATE MEASURING MACHINES



### FEATURES

- Classic bridge structure, integrated workbench
- High precision air bearing
- Unique Z-axis anti torque design to reduce rotation error

### RENISHAW SYSTEMS

- Precision grating system, including grating and data acquisition device
- UCC control system, including control box and manual operator
- Probe system, including probe head, probe body and styli

### VISUAL DMIS CNC CAD+SOFTWARE

- The software is designed and developed based on the DMIS standard, with excellent compatibility and versatility
- Geometric element measurement, evaluation of shape and position
- Bidirectional data transfer with mainstream CAD systems, complete graphical display
- Optional specialized modules, such as gear module, worm module, pipeline module, blade module, SPC data analysis module, etc.



CMM-LM564A

### SPECIFICATION

Code	Range (X×Y×Z)	Probe system		Accuracy		Max. weight of workpiece	Overall dimension (mm)	Weight (kg)
		head	body	MPEE (μm)	MPEP			
CMM-LM564A	500×600×400mm	MH20i	TP20	±(2.3+L/250)	2.4μm	500kg	1420×1135×2350	900
CMM-LM564B		PH10T						
CMM-LM686A	600×800×600mm	MH20i	TP20	±(2.6+L/250)	2.7μm	800kg	1740×1420×2760	1300
CMM-LM686B		PH10T						
CMM-LM686C		PH10M	SP25M	±(2.1+L/250)	2.1μm			
CMM-LM8106A	800×1000×600mm	MH20i	TP20	±(2.7+L/250)	2.8μm	1000kg	1940×1620×2760	1700
CMM-LM8106B		PH10T						
CMM-LM8106C		PH10M	SP25M	±(2.2+L/250)	2.2μm			
CMM-LM8126A	800×1200×600mm	MH20i	TP20	±(2.7+L/250)	2.8μm	1000kg	2140×1620×2760	1900
CMM-LM8126B		PH10T						
CMM-LM8126C		PH10M	SP25M	±(2.2+L/250)	2.2μm			
CMM-LM8156A	800×1500×600mm	MH20i	TP20	±(2.7+L/250)	2.8μm	1000kg	2440×1620×2760	2200
CMM-LM8156B		PH10T						
CMM-LM8156C		PH10M	SP25M	±(2.2+L/250)	2.2μm			

To be continued

Continued from previous page

#### OPERATION ENVIRONMENT

Air pressure	0.6-0.8MPa
Air supply	200L/min
Temperature	20°C±2°C; <0.5°C/h, <1°C/24h
Humidity	30%~70%
Max. power	1000W
Power supply	220V±5%, 50HZ

#### STANDARD DELIVERY

Main unit		1 pc
Probe system	probe head	1 pc
	probe body	1 pc
	styli	1 set
Control system		1 set
Calibration sphere		1 pc
Universal sphere seat		1 pc
Computer		1 pc
Printer		1 pc
Software		1 set
Table and chair		1 set

#### PH10T AND PH10M SPECIFICATION

Angular movement with horizontal axis	0°~105° in 7.5 steps
Angular movement with vertical axis	±180° in 7.5 steps
Number of positions	720
Steering mode	motorized
Max. output torque	0.45N.m
Max. extension length	300mm
Weight	649g

#### MH20i SPECIFICATION

Angular movement with horizontal axis	0°~105° in 15 steps
Angular movement with vertical axis	±180° in 15 steps
Number of positions	168
Steering mode	manual
Max. extension length	75mm
Weight	210g

#### STYLI SET INCLUDED IN TP20

Name	Material	Ball diameter	Length	Stem diameter	Effective working length	Quantity
Styli	ruby ball/ stainless steel stem	SØ2.5mm	20mm	SØ1.4mm	14mm	4 pcs
		SØ4mm		SØ1.5mm	20mm	
		SØ3mm	10mm		7.5mm	1 pc

Name	Material	Diameter	Length	Quantity
Extension	stainless steel	Ø3mm	20mm	1 pc
Center base			30mm	
		Ø7mm	7.5mm	

#### STYLI SET INCLUDED IN SP25M

Name	Material	Ball diameter	Length	Stem diameter	Effective working length	Quantity
Styli	ruby ball/ stainless steel stem	SØ1.5mm	21mm	Ø1mm	14mm	1 pc
		SØ2mm		Ø1.4mm	8mm	1 pc
		SØ3mm		Ø1.5mm	12mm	4 pcs
		SØ4mm	Ø2.5mm	27mm	1 pc	
	ruby ball/ carbon fiber stem	SØ5mm	50mm	Ø3mm	42.5mm	1 pc
		SØ6mm	75mm	Ø4mm	75mm	1 pc

Name	Material	Diameter	Length	Quantity
Extension	stainless steel	Ø5mm	10mm	1 pc
Center base		Ø4mm	20mm	
		Ø10mm	13mm	

## MEASURING ARMS



- In accordance with ISO 10360-12
- Internal balance
- Dual high performance batteries
- Equivalent-arm design
- High-speed WiFi performance
- Aerospace grade carbon-fiber material
- Automatic power off
- U-shaped anti-collision design of the base



CMM-CM30

### HIGH PRECISION, CM SERIES, 6-AXIS

(mm)

Code	Measuring range	Maximum permissible error				
		SPAT	E <sub>UNI</sub>	P <sub>SIZE</sub>	P <sub>FORM</sub>	L <sub>DIA</sub>
CMM-CM15	1500	0.018	0.025	0.009	0.016	0.026
CMM-CM20	2000	0.020	0.028	0.010	0.018	0.032
CMM-CM25	2500	0.023	0.030	0.012	0.022	0.038
CMM-CM30	3000	0.034	0.042	0.016	0.032	0.052
CMM-CM35	3500	0.043	0.056	0.020	0.038	0.066
CMM-CM40	4000	0.052	0.066	0.024	0.044	0.083
CMM-CM45	4500	0.061	0.089	0.038	0.078	0.108

### HIGH PRECISION, CM SERIES, 7-AXIS

(mm)

Code	Measuring range	Maximum permissible error				
		SPAT	E <sub>UNI</sub>	P <sub>SIZE</sub>	P <sub>FORM</sub>	L <sub>DIA</sub>
CMM-CM20S	2000	0.022	0.030	0.012	0.022	0.040
CMM-CM25S	2500	0.027	0.032	0.013	0.025	0.048
CMM-CM30S	3000	0.042	0.053	0.020	0.035	0.078
CMM-CM35S	3500	0.055	0.066	0.024	0.043	0.092
CMM-CM40S	4000	0.065	0.082	0.029	0.048	0.102
CMM-CM45S	4500	0.073	0.099	0.043	0.082	0.132

### STANDARD PRECISION, BE SERIES, 6-AXIS

(mm)

Code	Measuring range	Maximum permissible error				
		SPAT	E <sub>UNI</sub>	P <sub>SIZE</sub>	P <sub>FORM</sub>	L <sub>DIA</sub>
CMM-BE15	1500	0.028	0.036	0.015	0.029	0.038
CMM-BE20	2000	0.030	0.040	0.018	0.035	0.041
CMM-BE25	2500	0.035	0.045	0.020	0.038	0.050
CMM-BE30	3000	0.055	0.065	0.028	0.045	0.080
CMM-BE35	3500	0.075	0.080	0.035	0.058	0.098
CMM-BE40	4000	0.090	0.100	0.044	0.068	0.116
CMM-BE45	4500	0.112	0.120	0.048	0.086	0.128

To be continued

Continued from previous page



Single-point articulation test



Distance measurement error between two points



Sphere form measurement error



Sphere size measurement error



Sphere diameter obtained from performing the articulated location test (diameter of the spherical zone containing the centers of a sphere measured from multiple orientations)

## SPECIFICATION

Temperature rate	3°C/5min
Battery life	5h for one battery; 10h for two batteries
Output	USB, WIFI
Operation temperature	5°C~45°C
Operation humidity	0~95%, non-condensing
Power	100~240VAC, 50/60HZ
Weight	8.8kg~10.6kg



3mm zircon ball probe (included)



6mm zircon ball probe (included)



calibration cone (included)

## STANDARD DELIVERY

Main unit	1 pc
3mm zircon ball probe	1 pc
6mm zircon ball probe	1 pc
Calibration cone	1 pc
Lithium batteries	2 pcs
USB cable	1 pc
Power adapter	1 pc
Dust cover	1 pc



magnetic base (optional)



electric vacuum base (optional)



DELL laptop (optional)

## OPTIONAL ACCESSORY

DELL laptop	CMM-CEM-PCE
Polyworks software	CMM-CEM-PW
Adjustable tripod	CMM-CEM-FAT
Electric vacuum base	CMM-CEM-EVCP
Magnetic base	CMM-CEM-IMM
Magnetic cones	CMM-CEM-MC
Magnetic spheres	CMM-CEM-MS
Point probe	CMM-CEM-PP
2mm ruby ball probe	CMM-CEM-RP2
5mm zircon ball probe	CMM-CEM-ZP5
10mm zircon ball probe	CMM-CEM-ZP10
3" straight probe extension	CMM-CEM-SPE3
4" straight probe extension	CMM-CEM-SPE4
60° probe adapter	CMM-CEM-DP60
90° probe adapter	CMM-CEM-DP90
3mm extended ball probe	CMM-CEM-EPB3
6mm extended ball probe	CMM-CEM-EPB6
Probe adapter	CMM-CEM-PA



adjustable tripod (optional)



## STYLI FOR CMM

**INSIZE PLUS**  
MADE IN EUROPE



ISQ-01-2010-020STR

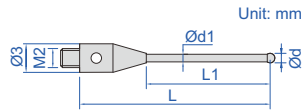

Unit: mm



ISQ-02-2030-040ST

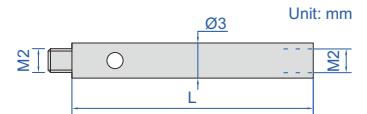

Unit: mm

### M2 styli (stainless steel base) (mm)

Code	Ød	Ød1	L	L1	Material of rod	Material of tip
ISQ-01-2010-010STR	1	0.8	10	4	carbide	ruby
ISQ-01-2010-020LTR	1	0.8	20	7		
ISQ-01-2010-020STR	1	0.8	20	13		
ISQ-01-2010-028STR	1	0.8	27.5	20.5		
ISQ-01-2015-020STR	1.5	1	20	13		
ISQ-01-2015-030STR	1.5	1	30	23		
ISQ-01-2020-020STR	2	1	20	13		
ISQ-01-2020-030STR	2	1.5	30	23		
ISQ-01-2020-040STR	2	1.5	40	33		
ISQ-01-2025-020STR	2.5	1.5	20	13		
ISQ-01-2025-030STR	2.5	2	30	23		
ISQ-01-2025-040STR	2.5	2	40	33		
ISQ-01-2030-020STR	3	1.5	20	13		
ISQ-01-2030-030STR	3	2	30	23		
ISQ-01-2030-040STR	3	2	40	33		
ISQ-01-2030-050STR	3	2	50	43		
ISQ-01-2040-022STR	4	2	22	15		
ISQ-01-2040-030STR	4	2	30	23		
ISQ-01-2040-040STR	4	2	40	33		
ISQ-01-2040-050STR	4	2	50	43		
ISQ-01-2020-020SSR	2	1.5	20	13	stainless steel	
ISQ-01-2030-020SSR	3	1.5	20	13		
ISQ-01-2040-020SSR	4	1.5	20	13	ceramic	
ISQ-01-2030-050SCE	3	2	50	43		

### M2 extension rods of styli (mm)

Code	L	Material
ISQ-02-2030-005ST	5	stainless steel
ISQ-02-2030-010ST	10	
ISQ-02-2030-020ST	20	
ISQ-02-2030-030ST	30	
ISQ-02-2030-040ST	40	

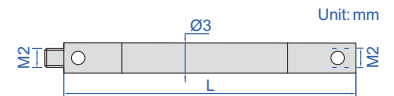

Unit: mm

### M2 extension rods of styli (mm)

Code	L	Material
ISQ-02-2035-030SCF	30	carbon fibre
ISQ-02-2035-040SCF	40	
ISQ-02-2035-050SCF	50	
ISQ-02-2035-060SCF	60	
ISQ-02-2035-070SCF	70	

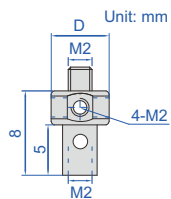

Unit: mm

### M2 multi way bases of styli (mm)

Code	D	Remark	Material
ISQ-03-2075-008ST	7.5	4-way	stainless steel
ISQ-03-2070-008ST	7	5-way	stainless steel

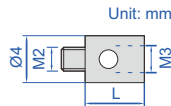

Unit: mm

### M2 thread converters (mm)

Code	L	Material
ISQ-05-2040-005M3	5	stainless steel
ISQ-05-2040-007M3	7	



ISQ-01-3005-020TTR2

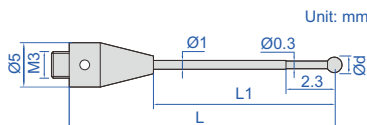

Unit: mm

### M3 styli with step (stainless steel base) (mm)

Code	Ød	L	L1	Material of rod	Material of tip
ISQ-01-3005-018TTR2	0.5	18	9	carbide	ruby
ISQ-01-3005-020TTR2	0.5	20	11		

To be continued

Continued from previous page



ISQ-01-3020-030STR

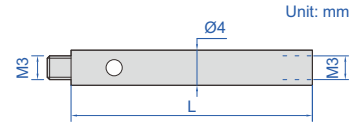
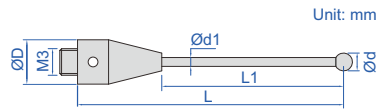

**M3 styli (stainless steel base)**

Code	Ød	Ød1	L	L1	ØD	Material of rod	Material of tip
ISQ-01-3010-020TTR	1	0.8	20	11	5	carbide	ruby
ISQ-01-3010-040TTR	1	0.8	40	31	5		
ISQ-01-3015-020TTR	1.5	1	20	11	5		
ISQ-01-3015-030TTR	1.5	1	30	21	5		
ISQ-01-3015-040TTR	1.5	1	40	31	5		
ISQ-01-3020-014TTR	2	1	14	5	5		
ISQ-01-3020-040TTR	2	1.5	40	31	5		
ISQ-01-3020-050TTR	2	1.5	50	41	5		
ISQ-01-3030-050TTR	3	2	50	41	5		
ISQ-01-3040-030TTR	4	2	30	21	5		
ISQ-01-3040-040TTR	4	2	40	31	5		
ISQ-01-3040-050TTR	4	2	50	41	5		
ISQ-01-3020-030STR	2	1.5	30	22.5	4		
ISQ-01-3030-030STR	3	1.5	30	22.5	4		
ISQ-01-3030-050TCR	3	2	50	41	5		
ISQ-01-3030-075TCR	3	2	75	66	5		
						carbon fibre	

**M3 extension rods of styli**

Code	L	Material
ISQ-02-3040-010ST	10	stainless steel
ISQ-02-3040-020ST	20	
ISQ-02-3040-030ST	30	
ISQ-02-3040-040ST	40	
ISQ-02-3040-050ST	50	

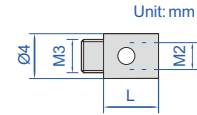

**M3 thread converters**

Code	L	Material
ISQ-05-3040-005M2	5	stainless steel
ISQ-05-3040-010M2	10	
ISQ-05-3040-020M2	20	



ISQ-01-4060-100SCE

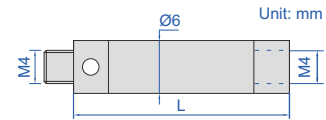
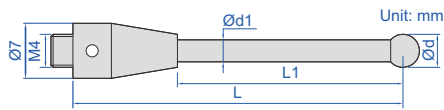

**M4 styli (stainless steel base)**

Code	Ød	Ød1	L	L1	Material of rod	Material of tip
ISQ-01-4010-020STR	1	0.8	20	10	carbide	ruby
ISQ-01-4020-020STR	2	1.5	20	10		
ISQ-01-4020-050STR	2	1.5	50	40		
ISQ-01-4040-050SCE	4	3	50	33.5	ceramic	
ISQ-01-4060-100SCE	6	4.5	100	83.5		

**M4 extension rods of styli**

Code	L	Material
ISQ-02-4070-030SCT	30	ceramic
ISQ-02-4070-050SCT	50	
ISQ-02-4070-100SCT	100	
ISQ-02-4070-200SCT	200	



ISQ-01-5010-032STR

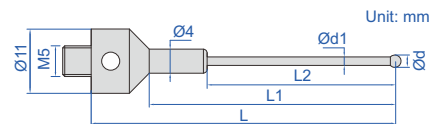
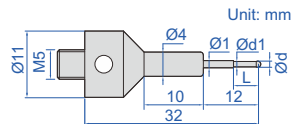

**M5 styli with step (stainless steel base)**

Code	Ød	Ød1	L	Material of rod	Material of tip
ISQ-01-5005-032STR	0.5	0.3	2.5	carbide	ruby
ISQ-01-5008-032STR	0.8	0.6	4.8		
ISQ-01-5010-032STR	1	0.8	5		

**M5 styli with step (stainless steel base)**

Code	Ød	Ød1	L	L1	L2	Material of rod	Material of tip
ISQ-01-5015-044STR	1.5	1	44	34	19	carbide	ruby
ISQ-01-5020-044STR	2	1.5	44	34	19		
ISQ-01-5020-058STR	2	1.5	58	48	33		

To be continued

Continued from previous page

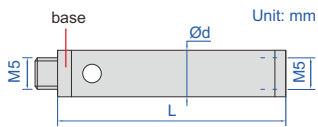

**M5 styli (stainless steel base)**

(mm)

Code	$\varnothing d$	$\varnothing d1$	L	L1	Material of rod	Material of tip
ISQ-01-5015-033STR	1.5	1	33	23	carbide	ruby
ISQ-01-5015-040STR	1.5	1	40	30		
ISQ-01-5020-034STR	2	1.5	33.5	23.5		
ISQ-01-5020-040STR	2	1.5	40	30		
ISQ-01-5030-034STR	3	2	33.5	23.5		
ISQ-01-5030-050STR	3	2	50	40		
ISQ-01-5030-058STR	3	2	58	48		
ISQ-01-5030-075STR	3	2	75	65		
ISQ-01-5050-050STR	5	2.5	50	40		
ISQ-01-5050-075STR	5	2.5	75	65		
ISQ-01-5060-054STR	6	3	54	44		
ISQ-01-5080-115STR	8	4	114.5	101.5		
ISQ-01-5030-058SCR	3	2	58	48	carbon fibre	
ISQ-01-5050-100SCR	5	3.5	100	90		
ISQ-01-5080-100SCR	8	6	100	87		



**ISQ-03-5110-030TI**

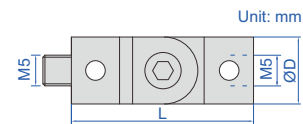

**M5 extension rods of styli**

(mm)

Code	$\varnothing d$	L	Material	Material of base
ISQ-02-5110-040SAL	11	40	aluminium	stainless steel
ISQ-02-5110-060SAL	11	60		
ISQ-02-5110-080SAL	11	80		
ISQ-02-5110-100SAL	11	100		
ISQ-02-5110-020ST	11	20	stainless steel	titanium
ISQ-02-5110-040TCF	11	40	carbon fibre	
ISQ-02-5110-050TCF	11	50		
ISQ-02-5110-060TCF	11	60		
ISQ-02-5110-100TCF	11	100		

**M5 rotating joints**

(mm)

Code	L	$\varnothing D$	Material
ISQ-03-5110-030TI	30	11	titanium
ISQ-03-5180-036TI	36	18	

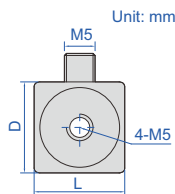

**M5 4-way cubes of styli**

(mm)

Code	D	L	Material
ISQ-03-5150-150TI	15	15	titanium
ISQ-03-5200-200TI	20	20	

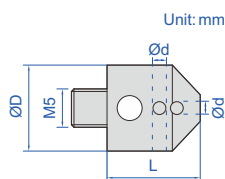

**HOLDERS for pin styli**

(mm)

Code	L	$\varnothing d$	$\varnothing D$	Material
ISQ-03-5110-012H1	12	1	11	stainless steel
ISQ-03-5110-012H1D5	12	1.5	11	
ISQ-03-5110-012H2	12	2	11	

**M5 thread converters**

(mm)

Code	L	$\varnothing D$	Thread (T)	Material
ISQ-05-5110-090M2	10	11	M2	stainless steel
ISQ-05-5110-090M3	10	11	M3	

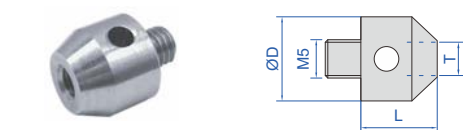

**ISQ-05-5110-090M3**



**ISQ-01-0008-016TR**

**Pin styli**

(mm)

Code	L	$\varnothing d$	L1	$\varnothing d1$	$\varnothing d2$	Material of rod	Material of tip
ISQ-01-0008-016TR	15.8	0.8	4.8	1	0.6	carbide	ruby
ISQ-01-0020-027TR	27	2	-	1.5	-		
ISQ-01-0030-038TR	38	3	-	2	-		

## STYLI FOR CMM

▪ Roundness: 0.25µm



ISQ-20-071



ISQ-25-125

### M2 styli (mm)

Code	Ød	Ød1	L	L1*	Material of rod	Material of tip
ISQ-20-002	1	0.7	10	4.5	stainless steel	ruby
ISQ-20-006	2	1	10	6		
ISQ-20-010	3	1.5	10	10		
ISQ-20-021	2	1.4	20	14		
ISQ-20-025	3	1.5	20	17.5		
ISQ-20-027	4	2	20	20		
ISQ-20-052	0.5	0.3	10	3	carbide	
ISQ-20-071	1	0.7	20	12.5		
ISQ-20-105	2	1.5	30	22.5		
ISQ-20-120	3	2	30	27.5		
ISQ-20-201	4	3	50	50	carbon fibre	

\* L1 is the effective working length, which is the distance from the center of the tip to the section of the stem with the same diameter as the tip

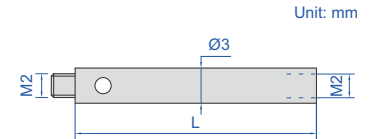

### M2 extension rods of styli (mm)

Code	L	Material
ISQ-25-105	10	stainless steel
ISQ-25-110	20	
ISQ-25-125	30	ceramic



ISQ-30-066

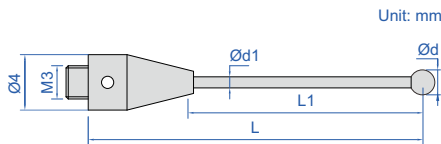

ISQ-35-110

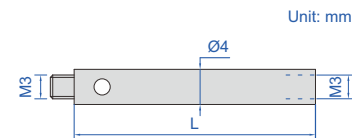

### M3 styli (mm)

Code	Ød	Ød1	L	L1*	Material of rod	Material of tip
ISQ-30-001	1	0.7	21	4	carbide	ruby
ISQ-30-003	2	1.4	21	8		
ISQ-30-005	3	1.5	21	12		
ISQ-30-031	2	1.5	30	22.5		
ISQ-30-066	3	2	50	42.5	ceramic	
ISQ-30-080	6	4	75	75	carbon fibre	

\* L1 is the effective working length, which is the distance from the center of the tip to the section of the stem with the same diameter as the tip

### M3 extension rods of styli (mm)

Code	L	Material
ISQ-35-101	10	stainless steel
ISQ-35-105	20	
ISQ-35-110	35	
ISQ-35-115	50	ceramic

To be continued

Continued from previous page



ISQ-40-195

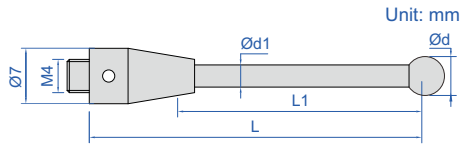

ISQ-45-025

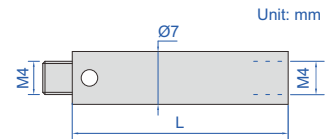

M4 styli (mm)

Code	Ød	Ød1	L	L1*	Material of rod	Material of tip
ISQ-40-113	3	2	18.5	13	stainless steel	ruby
ISQ-40-208	6	4	50	36		
ISQ-40-106	1	0.7	19.5	4	carbide	
ISQ-40-109	2	1.4	19	8		
ISQ-40-141	1	0.7	20	10		
ISQ-40-195	2	1.5	50	40		
ISQ-40-202	4	2	50	38		
ISQ-40-173	5	4	50	34	ceramic	
ISQ-40-179	6	4	50	36		
ISQ-40-222	6	4	75	63		
ISQ-40-240	5	4	100	84		
ISQ-40-245	6	4	100	86		

\*L1 is the effective working length, which is the distance from the center of the tip to the section of the stem with the same diameter as the tip

M4 extension rods of styli (mm)

Code	L	Material
ISQ-45-025	30	ceramic
ISQ-45-028	50	



ISQ-50-059

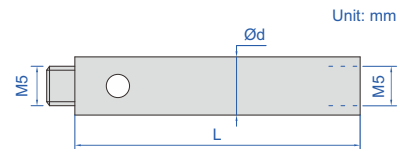
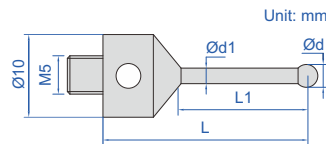

M5 styli (mm)

Code	Ød	Ød1	L	L1*	Material of rod	Material of tip
ISQ-50-051	1	0.7	20	5	carbide	ruby
ISQ-50-059	2	1.5	20	11		
ISQ-50-067	3	2	20	11		
ISQ-50-071	4	2	20	11		
ISQ-50-075	5	3	20	11		

\*L1 is the effective working length, which is the distance from the center of the tip to the section of the stem with the same diameter as the tip

M5 extension rods of styli (mm)

Code	L	Ød	Material
ISQ-55-012	20	10	stainless steel
ISQ-55-014	30	10	
ISQ-55-016	50	10	
ISQ-55-018	100	10	
ISQ-55-031	50	20	aluminum
ISQ-55-035	100	20	
ISQ-55-039	200	20	

REFER TO PAGE 330-331 FOR DETAILS



6882-600



6874-1000

CMM CHECK MASTERS

## GAGE BLOCK STAND FOR CMM

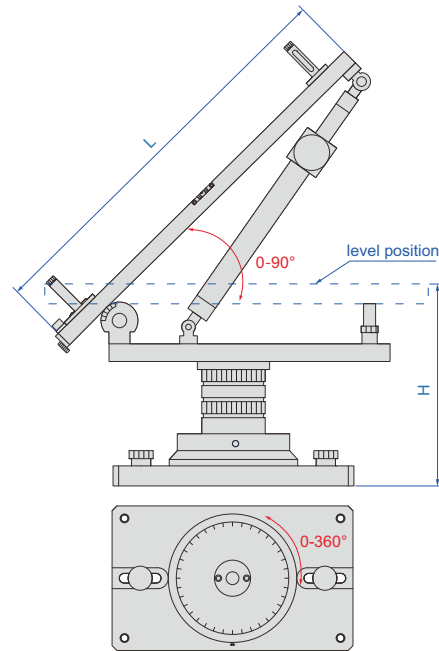

6885-1000

- Made of aluminum
- Used with gage blocks to calibrate CMM
- Optional accessory: gage blocks (4101, 4103 and 4104 series)

(mm)

Code	Length (L)	Height (H)
6885-1000	500, 600, 650, 700, 750, 800, 850, 900, 1000	235, 355, 475



height column (included, 2 pcs)



extension plate (included, 4 pcs)

## CERAMIC BALL GAGES

- To calibrate CMM probes
- Zirconia material, high strength and hardness, extremely wear resistance and corrosion resistance good insulation, antistatic and magnetic resistance
- Mirror surface, with pole
- Supplied with manufacturer inspection certificate

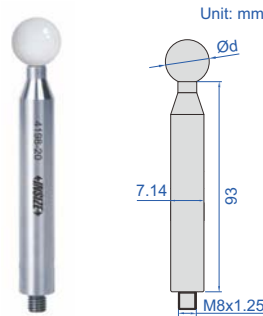

4198-20

### High accuracy

Code	Diameter (Ød)	Accuracy	Roundness
4198-8	8mm	±5µm	0.5µm
4198-10	10mm	±5µm	0.5µm
4198-12D7	12.7mm	±5µm	0.5µm
4198-13	13mm	±5µm	0.5µm
4198-14	14mm	±5µm	0.5µm
4198-15	15mm	±5µm	0.5µm
4198-16	16mm	±5µm	0.5µm
4198-17	17mm	±5µm	0.5µm
4198-20	20mm	±5µm	0.5µm
4198-25D4	25.4mm	±5µm	0.5µm

### Standard accuracy

Code	Diameter (Ød)	Accuracy	Roundness
4198-8A	8mm	±5µm	1µm
4198-10A	10mm	±5µm	1µm
4198-12D7A	12.7mm	±5µm	1µm
4198-13A	13mm	±5µm	1µm
4198-14A	14mm	±5µm	1µm
4198-15A	15mm	±5µm	1µm
4198-16A	16mm	±5µm	1µm
4198-17A	17mm	±5µm	1µm
4198-20A	20mm	±5µm	1µm
4198-25D4A	25.4mm	±5µm	1µm

CAN BE CUSTOMIZED



### JIGS FOR CMM (ANVIL Ø2.5mm)

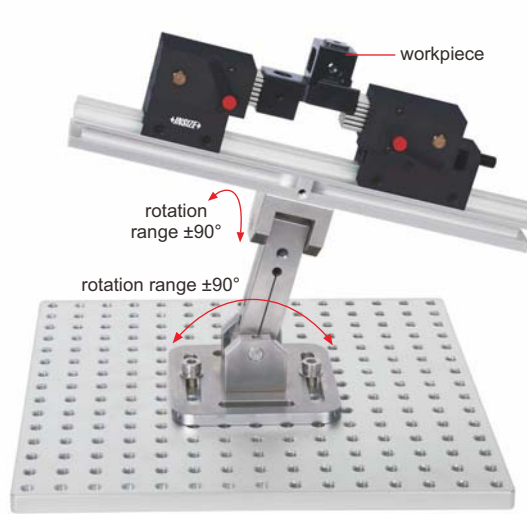

ISY-200



ISY-200-1



ISY-200-2



ISY-200-3



ISY-200-4



ISY-200-5



ISY-200-6

Code	Product	Remark
ISY-200	jig set	including 1 pc ISY-200-1, 1 pc ISY-200-2, 1 pc ISY-200-3, 1 pc ISY-200-4, 1 pc ISY-200-5 and 2 pcs ISY-200-6

Code	Product	Size	Anvil area	Anvil stroke
ISY-200-1	spring anvil	60×40×57	20.5×23	14
ISY-200-2	adjustable spring anvil (range 0-20mm)	70×40×57	20.5×23	14

Code	Product	Size	Hole size
ISY-200-3	base plate	300×300×12mm	M8

Code	Product	Size
ISY-200-4	guide	300×40×27
ISY-200-5	two-way adjustable stand	110×110×142
ISY-200-6	clamp handle	—

**JIGS FOR CMM (ANVIL Ø6mm)**



CAN BE CUSTOMIZED



**ISY-500**



**ISY-500-1**



**ISY-500-2**



**ISY-500-3**



**ISY-500-4**



**ISY-500-5**



**ISY-500-6**



**ISY-500-7**

Code	Product	Remark
ISY-500	jig set	including 1 pc ISY-500-1, 1 pc ISY-500-2, 2 pcs ISY-500-3, 10 pcs ISY-500-4, 2 pcs ISY-500-5, 1 pc ISY-500-6, 2 pcs ISY-500-7

Code	Product	Size	Anvil area	Anvil stroke
ISY-500-1	spring anvil	134×90×90	36×100	24
ISY-500-2	adjustable spring anvil (range 0-40mm)	134×120×130	36×100	24

(mm)

Code	Product	Size
ISY-500-3	base plate	300×240×20
ISY-500-4	block	120×90×20
ISY-500-5	connecting plate	170×90×15
ISY-500-6	connecting block of base plate	80×50×10
ISY-500-7	clamp handle	—



CAN BE CUSTOMIZED



### JIGS FOR CMM (ANVIL Ø2.5mm)



ISY-300-1



ISY-300



ISY-300-2



ISY-300-3



ISY-300-4



ISY-300-5



ISY-300-6



ISY-300-7



ISY-300-8



ISY-300-9



ISY-300-10



ISY-300-11



ISY-300-12



ISY-300-13

Code	Product	Remark
ISY-300	jig set	including 1 pc ISY-300-1, 2 pcs ISY-300-2, 1 pc ISY-300-3, 2 pcs ISY-300-4, 14 pcs ISY-300-5, 2 pcs ISY-300-6, 8 pcs ISY-300-7, 6 pcs ISY-300-8, 2 pcs ISY-300-9, 2 pcs ISY-300-10, 2 pcs ISY-300-11, 2 pcs ISY-300-12, 2 pcs ISY-300-13

Code	Product	Size	Hole size
ISY-300-1	base plate	300×300×12mm	M8

Code	Product	Size	Anvil area	Anvil stroke
ISY-300-2	spring anvil	60×40×75	20.5×23	14
ISY-300-3	spring anvil	Ø26×73	3.1cm <sup>2</sup> (hexagon)	14

Code	Product	Size (mm)
ISY-300-4	block	50×50×50
ISY-300-5	block	50×50×20
ISY-300-6	connecting plate	110×50×10
ISY-300-7	block	Ø26×20
ISY-300-8	block	Ø26×30
ISY-300-9	connecting plate	150×26×10
ISY-300-10	clip	65×11
ISY-300-11	clip	100×11
ISY-300-12	connecting block of clip stand	Ø26×20
ISY-300-13	clip stand	Ø8×75

# JIGS FOR CMM (ANVIL Ø6mm)



CAN BE CUSTOMIZED



ISY-400



ISY-400-1



ISY-400-2



ISY-400-3



ISY-400-4



ISY-400-5



ISY-400-6

Code	Product	Remark
ISY-400	jig set	including 3 pcs ISY-400-1, 9 pcs ISY-400-2, 9 pcs ISY-400-3, 1 pc ISY-400-4, 3 pcs ISY-400-5, 3 pcs ISY-400-6

(mm)

Code	Product	Size
ISY-400-2	block	120×60×20
ISY-400-3	block	120×60×30
ISY-400-4	base plate	500×500×12
ISY-400-5	connecting plate	130×120×12
ISY-400-6	clamp handle	—

(mm)

Code	Product	Size	Anvil area	Anvil stroke
ISY-400-1	spring anvil	135×60×90	36×100	24



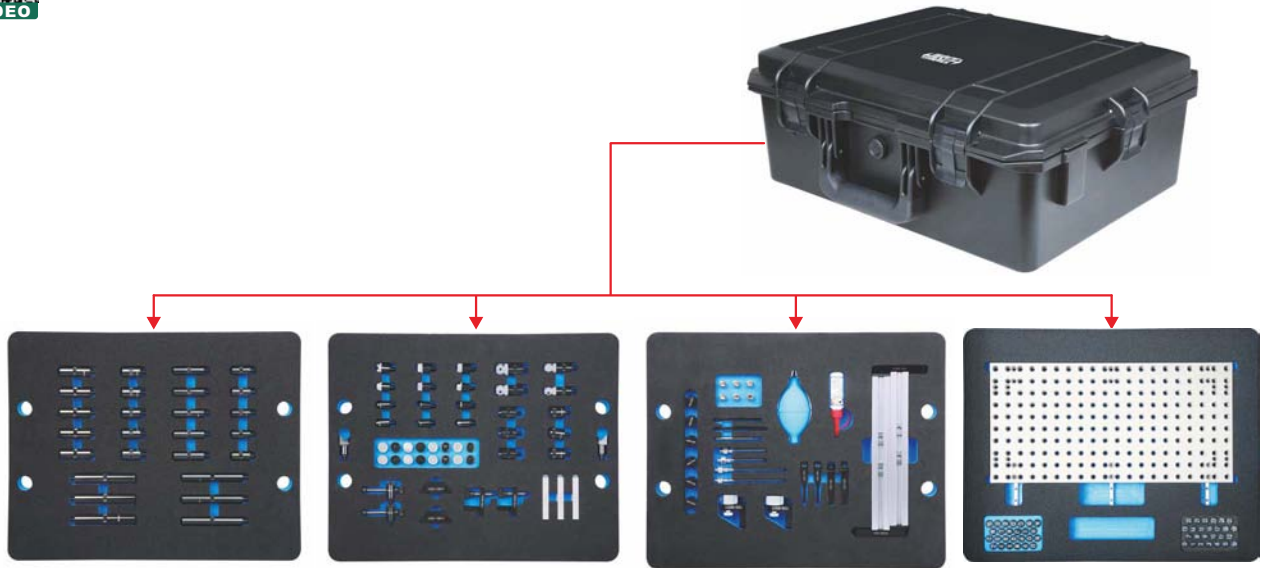

## JIG SET FOR CMM CODE ISY-100

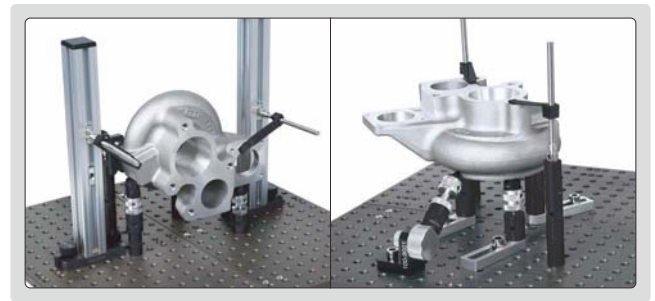

ISY-100

application examples

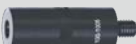

Product	Code	Size (mm)	Quantity	Application
	ISY-100-1001	Ø16×30	5	
	ISY-100-1002	Ø16×50	5	
	ISY-100-1003	Ø16×100	3	
	ISY-100-1004	Ø20×30	5	
	ISY-100-1005	Ø20×50	5	
	ISY-100-1006	Ø20×100	3	
stand with fine adjustment	ISY-100-2001	Ø16×45~60	2	height adjustment: 45~60mm
stand with fine adjustment	ISY-100-2003	Ø20×45~60	2	
horizontal spring stand	ISY-100-4001	—	2	

Product	Code	Size (mm)	Quantity	Application
horizontal screw stand	ISY-100-5001	—	2	
magnetic stand (magnetic top surface)	ISY-100-7001	Ø20×25	3	
stand for slice parts	ISY-100-8001	Ø20×25	2	ISY-100-8001 and ISY-100-8002 use cooperatively 
clamping stand for slice parts	ISY-100-8002		1	









To be continued

Continued from previous page

Product	Code	Size (mm)	Quantity	Application
clip 	ISY-100-1201	—	2	
clip 	ISY-100-1301	—	2	
clip stand 	ISY-100-1401	Ø6×60	2	
	ISY-100-1402	Ø6×100	2	
vertical square column 	ISY-100-3003	30×30×250	2	
sliding support plate 	ISY-100-1801	78×20×10	3	
clamping screw 	ISY-100-2301	Ø8×20	6	
screw 	ISY-100-2302	Ø8×20	6	
base plate 	ISY-600-400200	400×400×12 hole size: M8×1.25 hole center distance: 20	2 pieces	—
wrench 	ISY-100-3701	Ø3.8×70	1	—
wrench 	ISY-100-3801	M2.5	1	—
	ISY-100-3802	M5	1	—
	ISY-100-3803	M6	1	—
45° stand 	ISY-100-9001	—	2	
V shaped support 	ISY-100-1901	—	2	

Product	Code	Quantity	Application
V shaped support 	ISY-100-1902	2	
marker 	ISY-6100-1501	52*	
dust cleaner 	ISY-100-3501	1	—
lubricating oil 	ISY-100-3601	1	—

\* Letter A-Z, number 0-25

Product	Code	Quantity	Material	Application
support head 	ISY-100-27016	2	aluminum	
	ISY-100-27018	2	nylon	
support head 	ISY-100-27026	2	aluminum	
	ISY-100-27028	2	nylon	
support head 	ISY-100-27036	2	aluminum	
	ISY-100-27038	2	nylon	
support head 	ISY-100-27046	2	aluminum	
	ISY-100-27048	2	nylon	
support head 	ISY-100-27056	2	aluminum	
	ISY-100-27058	2	nylon	
support head 	ISY-100-27066	2	aluminum	
	ISY-100-27068	2	nylon	
support head 	ISY-100-27076	2	aluminum	
	ISY-100-27078	2	nylon	



# JIG SET FOR CMM CODE ISY-600



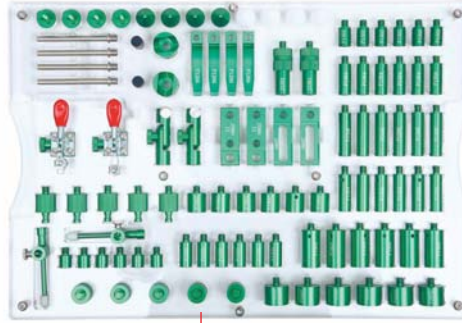



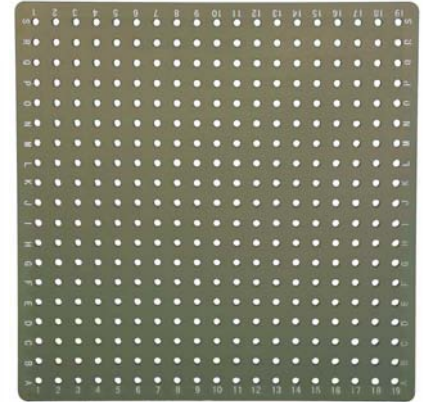



application example











acrylic tray (included)



ISY-600

Product	Code	Size (mm)	Quantity
 stand	ISY-600-P1301	Ø13×13	6
	ISY-600-P1302	Ø13×20	6
	ISY-600-P1303	Ø13×26	6
 stand	ISY-600-P1304	Ø13×32	6
	ISY-600-P1305	Ø13×40	6
	ISY-600-P1306	Ø13×45	6
 stand	ISY-600-P1902	Ø20×20	6
	ISY-600-P1905	Ø20×38	6
	ISY-600-P2602	Ø26×20	6
 spring stand	ISY-600-P1522	—	2
 universal support	ISY-600-J1560	—	2
 stand with fine adjustment	ISY-600-J1501	48~60	2
 magnetic stand (magnetic top surface)	ISY-600-J2020	Ø20×20	4
 adaptor	ISY-600-J2021	Ø20×19	2
 V shaped support	ISY-600-J2520	Ø25×20	2
 clamping screw	ISY-600-P2003	M8x1.25	4

Product	Code	Size (mm)	Quantity
 sliding support plate	ISY-600-J2060	60×20×10	2
 sliding support plate	ISY-600-J2060	60×20×10	2
 clip	ISY-600-P1266	12×66	4
 chuck support	ISY-600-JS201	—	2
 clip stand	ISY-600-P0684	Ø6×74	4
 aluminum support head	ISY-600-P2002	—	4
 nylon support head	ISY-600-P2001	—	4
 base plate	ISY-600-400	400×400×18 hole size: M8X1.25	1



**Profile Projectors**  
Page 559-568



**Quick Measurement Systems**  
Page 569-574



**Horizontal Vision Measuring Systems**  
Page 578-579



**Vision Measuring Systems**  
Page 575-589



**Vision Measuring Softwares**  
Page 590-591



**Jig Sets For Vision Measuring Systems**  
Page 592



**Standard Glass Scales**  
Page 593



ISP-Z3015



ISP-A1000E

digital readout of ISP-A1000E



- touch buttons
- USB data output to Excel and CAD
- show diagram



software flash disk (included, only for ISP-A1000E)

### OPTIONAL ACCESSORY



lens

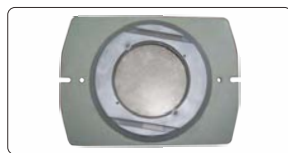

rotary table  
(glass plate diameter 100mm)



overlay chart (protractor with 1°  
graduation, radius with 1mm increment)



holder with clamp



swivel center support



V-block with clamp



50mm reading scale  
(check magnification accuracy)

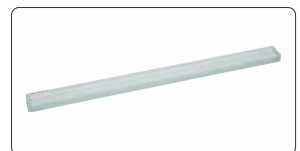

300mm calibration scale (check  
magnification accuracy together  
with 50mm reading scale or  
calibrate measuring accuracy)



blue filter



demo sample

























printer (only for ISP-A1000E)

To be continued

Continued from previous page

**SPECIFICATION**

Code		ISP-Z3015		ISP-A1000E		
Edge detector		not included		included		
Lens	magnification	10X (included)	20X (optional)	50X (optional)	100X (optional)	
	view field	Ø30mm	Ø15mm	Ø6mm	Ø3mm	
	working distance	77.7mm	44.3mm	38.4mm	25.3mm	
Max. workpiece height		90mm	90mm	90mm	90mm	
Magnification accuracy		±0.08%				
Image		erect image				
Projector screen		diameter: Ø300mm rotation range: 0°~360°, resolution: 1" or 0.01° reference lines: cross-hairs				
Stage	metal stage size	340×152mm				
	glass stage size	196×96mm				
	X-Y stage travel	range: 150×50mm				
		resolution: 0.5µm				
	Z (focus) travel range	accuracy: (4+L/25)µm L is the measuring length in mm				
max. load capacity	90mm					
Illumination		contour illumination: 24V/150W halogen lamp, brightness is adjustable surface illumination: 24V/150W halogen lamp				
Data processing unit	display	X-Y stage travel, screen rotation				
	output	RS232C		RS232C, USB (data output to Excel and CAD)		
	function	 measure coordinate of point	 measure coordinate of point		 measure coordinate of point	
		 measure coordinate of line	 measure coordinate of line		 measure coordinate of line	
 measure center coordinate, radius of circle with three points		 measure center coordinate, radius of circle with three points		 measure center coordinate, radius of circle with three points		
 measure distance between two objects		 measure distance between two objects		 measure distance between two objects		
 measure angle with four points or two lines		 measure angle with four points or two lines		 measure angle with four points or two lines		
 set origin of coordinate		 coordinate transform		 coordinate transform		
 coordinate transform		 choose measurement object automatically according to the selective point and display the result		 choose measurement object automatically according to the selective point and display the result		
 set midpoint of coordinate						
advanced function		—		programming for batch measurements		
Power supply		110/220V, 50/60Hz				
Dimension (L×W×H)		550×770×1100mm				
Weight		135kg				

24

**STANDARD DELIVERY**

Main unit	1 pc
10X lens with half-reflection mirror and oblique illuminator mirror	1 pc
Overlay chart clip	4 pcs
Foot-switch	1 pc
Anti-dust cover	1 pc
Software (only for ISP-A1000E) and USB cable	1 pc

**OPTIONAL ACCESSORY**

20X lens with half-reflection mirror and oblique illuminator mirror	ISP-Z3015-LENS20X
50X lens with half-reflection mirror	ISP-Z3015-LENS50X
100X lens with half-reflection mirror	ISP-Z3015-LENS100X
Rotary table	ISP-Z3015-TABLE
Overlay chart	ISP-Z3015-CHART
Holder with clamp	ISP-Z3015-HOLDER

Swivel center support	ISP-Z3015-SUPPORT
V-block with clamp	ISP-Z3015-VBLOCK
50mm reading scale	ISP-Z3015-SCALE50
300mm calibration scale	ISP-Z3015-RULE
Blue filter	ISP-Z3015-FILTER
Demo sample	ISP-Z3015-DEMO
Printer (only for ISP-A1000E)	ISP-A1000-PRINTER



THE STAGE DOESN'T  
MOVE UP AND DOWN

INSPECTION  
CERTIFICATE

## PROFILE PROJECTORS



ISP-AZ3020



ISP-A5000E

edge detector



digital readout of ISP-A5000E

- Adjust the focus by ascending and descending the projector head, the stage doesn't move up and down
- Maximum workpiece weight 50kg

- touch buttons
- USB data output to Excel and CAD
- show diagram

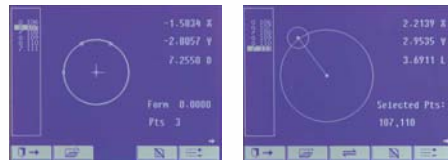

software flash disk  
(included, only for  
ISP-A5000E)

### OPTIONAL ACCESSORY



lens

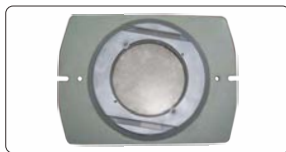

rotary table  
(glass plate diameter 100mm)



overlay chart (protractor with 1°  
graduation, radius with 1mm increment)

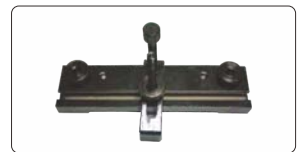

holder with clamp



swivel center support



V-block with clamp



50mm reading scale  
(check magnification accuracy)



300mm calibration scale (check  
magnification accuracy together  
with 50mm reading scale or  
calibrate measuring accuracy)



demo sample

















printer (only for ISP-A5000E)

To be continued

Continued from previous page

**SPECIFICATION**

Code		ISP-AZ3020		ISP-A5000E		
Edge detector		not included		included		
Lens	magnification	10X (included)	20X (optional)	50X (optional)	100X (optional)	
	view field	Ø30mm	Ø15mm	Ø6mm	Ø3mm	
	working distance	77.7mm	44.3mm	38.4mm	25.3mm	
Max. workpiece height		100mm	100mm	100mm	100mm	
Magnification accuracy		±0.08%				
Image		erect image				
Projector screen		diameter: Ø300mm				
		rotation range: 0°~360°, resolution: 1" or 0.01°				
		reference lines: cross-hairs				
Stage	metal stage size	404×228mm				
	glass stage size	260×160mm				
	X-Y stage travel	range: 200×100mm				
		resolution: 0.5µm				
	Z (focus) travel range	accuracy: (3+L/75)µm L is the measuring length in mm				
max. load capacity	100mm					
Illumination		contour illumination: 24V/150W halogen lamp, brightness is adjustable				
		surface illumination: 24V/150W halogen lamp				
Data processing unit	display	X-Y stage travel, screen rotation				
	output	RS232C		RS232C, USB (data output to Excel and CAD)		
	function		measure coordinate of point			measure coordinate of point
			measure coordinate of line			measure coordinate of line
		measure center coordinate, radius of circle with three points			measure center coordinate, radius of circle with three points	
		measure distance between two objects			measure distance between two objects	
		measure angle with four points or two lines			measure angle with four points or two lines	
		set origin of coordinate			coordinate transform	
		coordinate transform			choose measurement object automatically according to the selective point and display the result	
		set midpoint of coordinate				
advanced function		—		programming for batch measurements		
Power supply		110/220V, 50/60Hz				
Dimension (L×W×H)		780×780×1100mm				
Weight		160kg				

**STANDARD DELIVERY**

Main unit	1 pc
10X lens with half-reflection mirror and oblique illuminator mirror	1 pc
Overlay chart clip	4 pcs
Foot-switch	1 pc
Blue filter	1 pc
Anti-dust cover	1 pc
Software (only for ISP-A5000E) and USB cable	1 pc

**OPTIONAL ACCESSORY**

20X lens with half-reflection mirror and oblique illuminator mirror	ISP-A5000-LENS20X
50X lens with half-reflection mirror	ISP-A5000-LENS50X
100X lens with half-reflection mirror	ISP-A5000-LENS100X
Rotary table	ISP-A5000-TABLE
Overlay chart	ISP-A5000-CHART
Holder with clamp	ISP-A5000-HOLDER
Swivel center support	ISP-A5000-SUPPORT
V-block with clamp	ISP-A5000-VBLOCK
50mm reading scale	ISP-A5000-SCALE50
300mm calibration scale	ISP-A5000-RULE
Demo sample	ISP-A5000-DEMO
Printer (only for ISP-A5000E)	ISP-A5000-PRINTER

**HORIZONTAL PROFILE PROJECTORS**



ISP-W3020





ISP-A3000E

digital readout of ISP-A3000E



- touch buttons
- USB data output to Excel and CAD
- show diagram



software flash disk (included, only for ISP-A3000E)

**OPTIONAL ACCESSORY**



lens

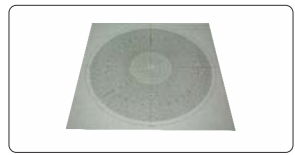

overlay chart (protractor with 1° graduation, radius with 1mm increment)



50mm reading scale (check magnification accuracy)



demo sample

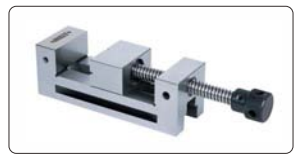

vise



rotary table

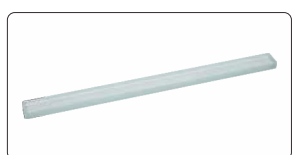















300mm calibration scale (check magnification accuracy together with 50mm reading scale or calibrate measuring accuracy)



printer (only for ISP-A3000E)

Continued from previous page

**SPECIFICATION**

Code		ISP-W3020	ISP-A3000E	
Edge detector		not included	included	
Lens	magnification	10X (included)      20X (optional)	50X (optional)      100X (optional)	
	view field	Ø30mm      Ø15mm	Ø6mm      Ø3mm	
	working distance	77.7mm      44.3mm	38.4mm      25.3mm	
Magnification accuracy		±0.08%		
Projector screen		diameter: Ø300mm		
		rotation range: 0°~360°, resolution: 1' or 0.01°		
		reference lines: cross-hairs		
Stage	metal stage size	400×150mm		
	turning range	±15°		
	X-Z stage travel	range: 200×100mm		
		resolution: 0.5µm		
		accuracy: (4+L/25)µm    L is the measuring length in mm		
Y (focus) travel range	75mm			
max. load capacity		50kg		
Illumination		contour illumination: 24V/150W halogen lamp, brightness is adjustable		
		surface illumination: 12V/150W halogen lamp (with 2 fibers), position is adjustable		
Data processing unit	display	X-Z stage travel, screen rotation		
	output	RS232C	RS232C, USB (data output to Excel and CAD)	
	function		measure coordinate of point	 measure coordinate of point
			measure coordinate of line	 measure coordinate of line
		measure center coordinate, radius of circle with three points	 measure center coordinate, radius of circle with three points	
		measure distance between two objects	 measure distance between two objects	
		measure angle with four points or two lines	 measure angle with four points or two lines	
		set origin of coordinate	 coordinate transform	
		coordinate transform	 choose measurement object automatically according to the selective point and display the result	
		set midpoint of coordinate		
advanced function		—	programming for batch measurements	
Power supply		110/220V, 50/60Hz		
Dimension (L×W×H)		830×1090×1010mm		
Weight		160kg		

**STANDARD DELIVERY**

Main unit	1 pc
10X lens	1 pc
Overlay chart clip	4 pcs
Foot-switch	1 pc
Anti-dust cover	1 pc
Software (only for ISP-A3000E) and USB cable	1 pc

**OPTIONAL ACCESSORY**

20X lens	ISP-A3000-LENS20X
50X lens	ISP-A3000-LENS50X
100X lens	ISP-A3000-LENS100X
Overlay chart	ISP-A3000-CHART
50mm reading scale	ISP-A3000-SCALE50
300mm calibration scale	ISP-A3000-RULE

Demo sample	ISP-A3000-DEMO
V-block with clamp	ISP-A3000-VBLOCK
Rotary table	ISP-A3000-RTABLE
Vise	ISP-A3000-VISE
Printer (only for ISP-A3000E)	ISP-A3000-PRINTER

# HORIZONTAL PROFILE PROJECTORS



ISP-W4025



ISP-A7000E

### digital readout of ISP-A7000E



- touch buttons
- USB data output to Excel and CAD
- show diagram



software flash disk (included, only for ISP-A7000E)

### OPTIONAL ACCESSORY



lens



vise



rotary table



demo sample (need rotary table)



printer (only for ISP-A7000E)



50mm reading scale (check magnification accuracy)



300mm calibration scale (check magnification accuracy together with 50mm reading scale or calibrate measuring accuracy)

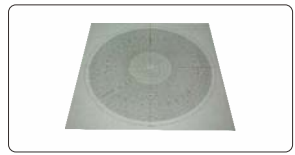

















Ø300mm overlay chart (protractor with 1° graduation, radius with 1mm increment)

To be continued

Continued from previous page

### SPECIFICATION

Code		ISP-W4025			ISP-A7000E			
Edge detector		not included			included			
Lens	magnification	5X (optional)	10X (standard)	20X (optional)	50X (optional)	100X (optional)		
	view field	Ø80mm	Ø40mm	Ø20mm	Ø8mm	Ø4mm		
	working distance	93.7mm	103.9mm	95.1mm	65.7mm	35mm		
Magnification accuracy		±0.08%						
Image		erect image						
Projector screen		diameter: Ø400mm						
		rotation range: 0°~360°, resolution: 1' or 0.01°						
		reference lines: cross-hairs						
Stage	metal stage size	450×200mm						
	turning range	±15°						
	X-Z stage travel	range: 250×150mm						
		resolution: 0.5µm						
	Y (focus) travel range	accuracy: (4+L/25)µm L is the measuring length in mm						
max. load capacity	100mm							
Illumination		contour illumination: 24V/150W halogen lamp, brightness is adjustable						
		surface illumination: 12V/150W halogen lamp (with 2 fibers), position is adjustable						
Data processing unit	display	X-Z stage travel, screen rotation						
	output	RS232C			RS232C, USB (data output to Excel and CAD)			
	function		measure coordinate of point					measure coordinate of point
			measure coordinate of line					measure coordinate of line
		measure center coordinate, radius of circle with three points					measure center coordinate, radius of circle with three points	
		measure distance between two objects					measure distance between two objects	
		measure angle with four points or two lines					measure angle with four points or two lines	
		set origin of coordinate					coordinate transform	
		coordinate transform					coordinate transform	
		set midpoint of coordinate					choose measurement object automatically according to the selective point and display the result	
advanced function		—			programming for batch measurements			
Power supply		110/220V, 50/60Hz						
Dimension (L×W×H)		646×1215×1210mm						
Weight		240kg						

24

### STANDARD DELIVERY

Main unit	1 pc
10X lens	1 pc
Overlay chart clip	4 pcs
Foot-switch	1 pc
Anti-dust cover	1 pc
Software (only for ISP-A7000E) and USB cable	1 pc

### OPTIONAL ACCESSORY

5X lens	ISP-W4025-LENS5X
20X lens	ISP-W4025-LENS20X
50X lens	ISP-W4025-LENS50X
100X lens	ISP-W4025-LENS100X
Ø300mm overlay chart	ISP-A3000-CHART
50mm reading scale	ISP-A3000-SCALE50

300mm calibration scale	ISP-A3000-RULE
Demo sample	ISP-A3000-DEMO
V-block with clamp	ISP-A3000-VBLOCK
Rotary table	ISP-A3000-RTABLE
Vise	ISP-A3000-VISE
Printer (only for ISP-A7000E)	ISP-A3000-PRINTER

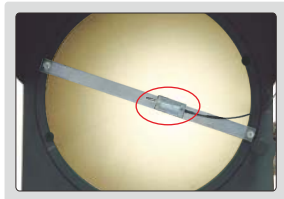

edge detector (for ISP-A6000E)

digital readout

- touch buttons
- USB data output to Excel and CAD
- show diagram

**ISP-A6000 (without edge detector)**



software flash disk (included)

**OPTIONAL ACCESSORY**



lens

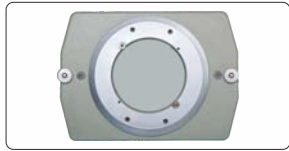

rotary table  
(glass plate diameter 100mm)



holder with clamp



printer



300mm calibration scale (check magnification accuracy together with 50mm reading scale or calibrate measuring accuracy)









50mm reading scale  
(check magnification accuracy)



demo sample

Continued from previous page

### SPECIFICATION

Code		ISP-A6000	ISP-A6000E			
Edge detector		not included	included			
Projector screen		diameter: Ø600mm				
		rotation range: 0°~360°, resolution: 1' or 0.01°				
		reference lines: cross-hairs				
Lens	magnification	5X (optional)	10X (included)	20X (optional)	50X (optional)	100X (optional)
	view field	Ø120mm	Ø60mm	Ø30mm	Ø12mm	Ø6mm
	working distance	242.8mm	143.2mm	85.5mm	92mm	48.5mm
Magnification accuracy		±0.08%				
Image		erect image				
Stage	metal stage size	404×265mm				
	glass stage size	207×170mm				
	X-Y stage travel	range: 200×100mm				
		resolution: 0.5µm				
	Z (focus) travel range	accuracy: (3+L/50)µm L is the measuring length in mm				
max. load capacity	50mm					
Illumination		contour illumination: 24V/150W halogen lamp, brightness is adjustable				
		surface illumination: 12V/150W halogen lamp (with 2 fibers), position is adjustable				
Data processing unit	display	X-Y stage travel, screen rotation				
	output	RS232C, USB (data output to Excel and CAD)				
	function		measure coordinate of point			
			measure coordinate of line			
		measure center coordinate, radius of circle with three points				
		measure distance between two objects				
		measure angle with four points or two lines				
		coordinate transform				
advanced function		choose measurement object automatically according to the selective point and display the result				
Power supply		programming for batch measurements				
Power supply		110/220V, 50/60Hz				
Dimension (L×W×H)		1200×1140×1940mm				
Weight		360kg				

### STANDARD DELIVERY

Main unit	1 pc
10X lens	1 pc
Foot-switch	1 pc
Software and USB cable	1 pc
Overlay chart clip	4 pcs
Anti-dust cover	1 pc

### OPTIONAL ACCESSORY

5X lens	ISP-A6000-LENS5X
20X lens	ISP-A6000-LENS20X
50X lens	ISP-A6000-LENS50X
100X lens	ISP-A6000-LENS100X
Holder with clamp	ISP-A6000-HOLDER

300mm calibration scale	ISP-A6000-RULE
50mm reading scale	ISP-A6000-SCALE50
Rotary table	ISP-A6000-TABLE
Demo sample	ISP-A6000-DEMO
Printer	ISP-A6000-PRINTER





## LARGE SIZE QUICK MEASUREMENT SYSTEM CODE QMS-A450



### SPECIFICATION

<b>Optical lens</b>		dual-field dual-telecentric low-distortion lens	
<b>Measurement range</b>		<b>wide view field</b>	<b>small view field</b>
		500×400mm	430×350mm
<b>Measurement Accuracy</b> *	without stitching	±3μm <sup>①</sup>	±1μm <sup>②</sup>
	with stitching	±(5+0.02L)μm <sup>③</sup>	±(3+0.02L)μm <sup>④</sup>
<b>Repeatability</b>	without stitching	±1μm	±0.5μm
	with stitching	±2μm	±1.5μm
<b>Illumination system</b>	<b>transmission light</b>	telecentric illuminator, green light	
	<b>surface light</b>	vertical illuminator, high angle ring white light vertical illuminator, 4-zone low and medium angle ring white light (electric) vertical illuminator, circular (directional) green light (electric)	
	<b>coaxial light (optional)</b>	vertical illuminator, white light	
<b>Max. weight of workpiece</b>		25kg	
<b>Measurement time</b>		<2s	
<b>Measurement data</b>		2D measurement	
<b>Environmental requirement</b>		temperature: 20°C±2°C, relative humidity: 30%~80%, vibration: <0.002g, less than 15Hz	
<b>Power supply</b>		220V, 50Hz, 1200W	
<b>Dimension (L×W×H)</b>		1060×860×1890mm	
<b>Weight</b>		650kg	

\* The optimum temperature is 20°C±1°C

- ① Within 73×49mm, on focal position and environment temperature at 20°C±1°C
- ② Within 16×12mm, on focal position and environment temperature at 20°C±1°C
- ③ Within 450×360mm, on focal position and environment temperature at 20°C±1°C
- ④ Within 387×315mm, on focal position and environment temperature at 20°C±1°C

Continued from previous page

- One or more workpieces can be measured by one step operation
- Place workpieces at any position
- Focus and measure automatically
- Measurement of 999+dimensions and 200+workpieces
- Suitable for parts with high precision requirements for large, medium, and small sizes

#### STANDARD DELIVERY

Main unit	1 pc
Computer	1 pc
Software	1 pc

#### OPTIONAL ACCESSORY

Coaxial light illumination	QMS-43-A1
Data transmission function of software	QMS-23-D1
CAD import function of software	QMS-23-C1
Laser sensor	QMS-43-SJ1
Foot-switch	QMS-43-FS1

#### Software (included)

- Automatically measure widths, holes, rings, angles at the same time, simple and efficient

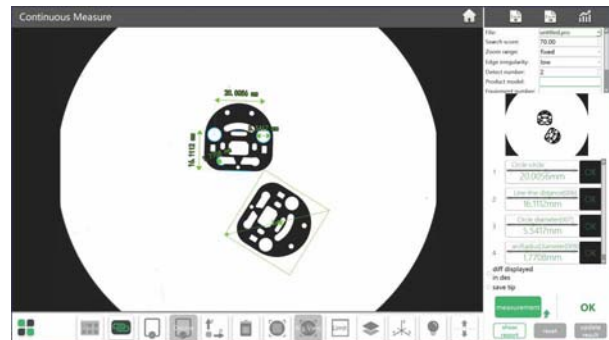
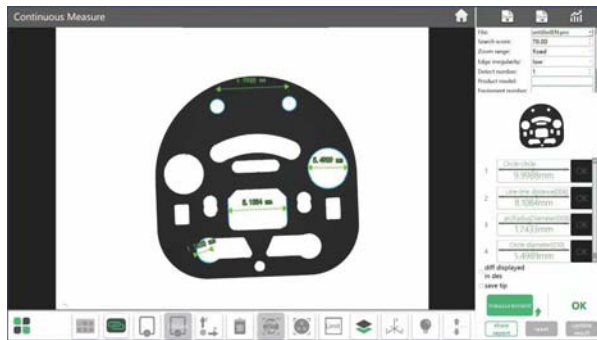

- Measuring result can be stored automatically. OK items and NG items can be counted automatically

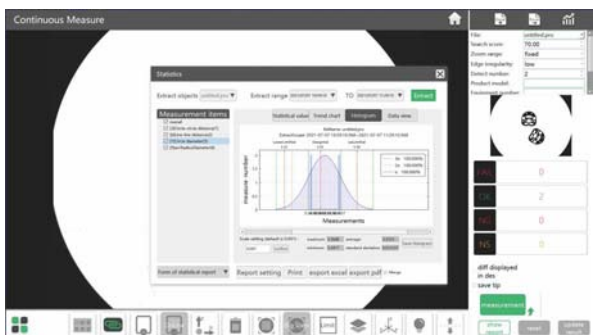

NOTE: NOT SUITABLE FOR SMALL SIZES SUCH AS THREADS, CHAMFERS, ETC

## QUICK MEASUREMENT SYSTEMS (WITH STITCHING)

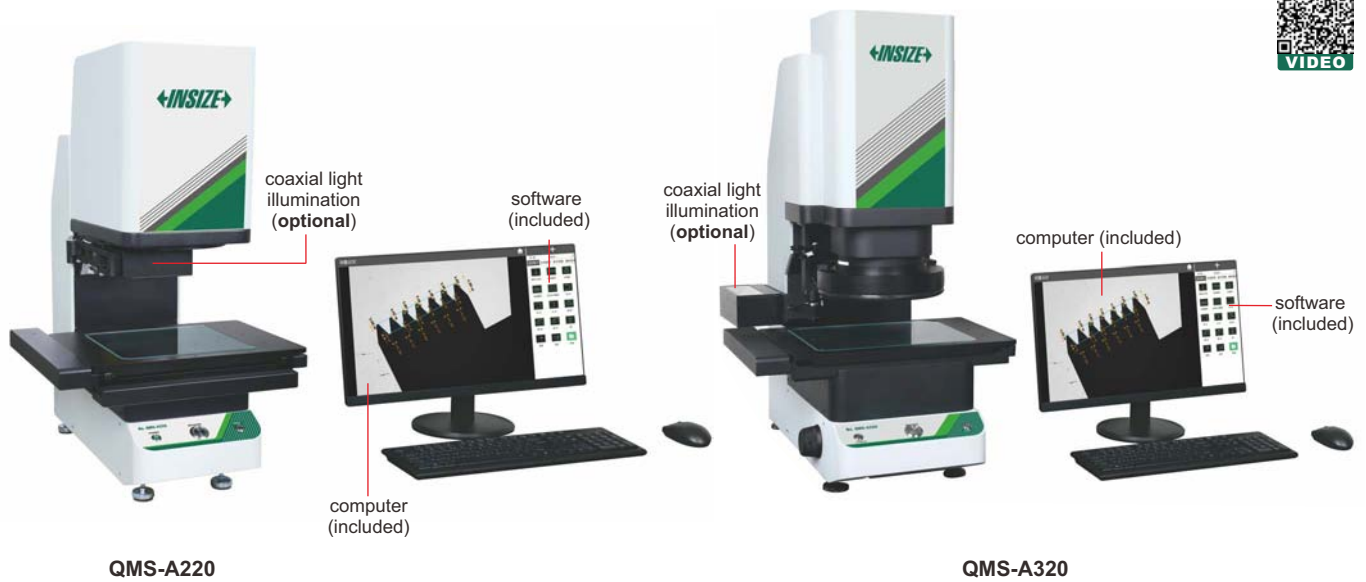

QMS-A220

QMS-A320

### SPECIFICATION

Code		QMS-A220		QMS-A315		QMS-A320	
Optical lens		dual-field dual-telecentric low-distortion lens					
View field range		wide view field: Ø100mm small view field: Ø25mm		wide view field: Ø100mm small view field: Ø25mm		wide view field: Ø150mm small view field: Ø50mm	
Measurement range		200×200mm	130×130mm	300×200mm	230×130mm	300×210mm	200×135mm
Measurement accuracy *	without stitching	±3µm <sup>①</sup>	±1µm <sup>②</sup>	±3µm <sup>①</sup>	±1µm <sup>②</sup>	±5µm <sup>③</sup>	±2µm <sup>④</sup>
	with stitching	±(5+0.02L)µm <sup>⑤</sup>	±(3+0.02L)µm <sup>⑥</sup>	±(5+0.02L)µm <sup>⑦</sup>	±(3+0.02L)µm <sup>⑧</sup>	±(7+0.02L)µm <sup>⑨</sup>	±(4+0.02L)µm <sup>⑩</sup>
Repeatability	without stitching	±1µm	±0.5µm	±1µm	±0.5µm	±1µm	±0.5µm
	with stitching	±2µm	±1.5µm	±2µm	±1.5µm	±2µm	±1.5µm
Max. weight of workpiece		5kg					
Measurement time		<2s					
Measurement data		2D measurement					
Power supply		220V, 50Hz, 600W					
Illumination system	back light	telecentric illuminator, green light					
	ring light	4-zone circular white high light circular (directional) low-angle green light (electric)					
	coaxial light (optional)	vertical illuminator, white light					
Environmental requirement		temperature: 20°C±2°C, relative humidity: 30%~80%, vibration: <0.002g, less than 15Hz					
Dimension (L×W×H)		532×480×766mm		532×497×766mm		669×510×883mm	
Weight		50kg		60kg		68kg	

\* The optimum temperature is 20°C±1°C

- ① Within 80×64mm, on focal position and environment temperature at 20°C±1°C
- ② Within 20×16mm, on focal position and environment temperature at 20°C±1°C
- ③ Within 120×88mm, on focal position and environment temperature at 20°C±1°C
- ④ Within 40×28mm, on focal position and environment temperature at 20°C±1°C
- ⑤ Within 180×180mm, on focal position, environment temperature at 20°C±1°C, and workpiece is less than 2kg, L is the travel of stage
- ⑥ Within 117×117mm, on focal position, environment temperature at 20°C±1°C, and workpiece is less than 2kg, L is the travel of stage
- ⑦ Within 270×180mm, on focal position, environment temperature at 20°C±1°C, and workpiece is less than 2kg, L is the travel of stage
- ⑧ Within 207×117mm, on focal position, environment temperature at 20°C±1°C, and workpiece is less than 2kg, L is the travel of stage
- ⑨ Within 270×189mm, on focal position, environment temperature at 20°C±1°C, and workpiece is less than 2kg, L is the travel of stage
- ⑩ Within 180×121mm, on focal position, environment temperature at 20°C±1°C, and workpiece is less than 2kg, L is the travel of stage

To be continued

Continued from previous page

- One or more workpieces can be measured by one step operation
- Place workpieces at any position
- Focus and measure automatically
- Measurement of 999+dimensions and 200+workpieces
- **QMS-A220** and **QMS-A315** are suitable for small and medium-size parts with high precision requirements
- **QMS-A320** is suitable for medium-size parts with low accuracy requirements and fast efficiency requirements



11.6" LCD (optional)

**STANDARD DELIVERY**

Main unit	1 pc
Computer	1 pc
Software	1 pc

**OPTIONAL ACCESSORY**

Coaxial light illumination	QMS-23-A3 (for QMS-A220, QMS-A315) QMS-23-A4 (for QMS-A320)
Data transmission function of software	QMS-23-D1
CAD import function of software	QMS-23-C1
Laser sensor	QMS-43-SJ1 (for QMS-A315)
Foot-switch	QMS-43-FS1
11.6" LCD	QMS-23-B1 (must be installed in factory)

**Software (included)**

- Automatically measure widths, holes, rings, angles at the same time, simple and efficient

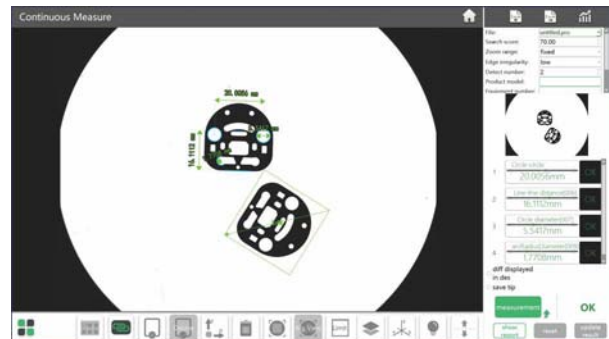
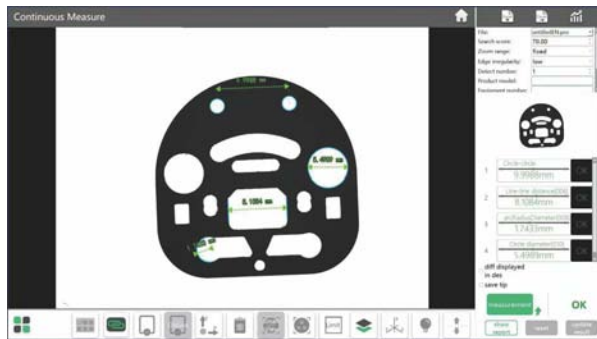

- Measuring result can be stored automatically. OK items and NG items can be counted automatically



NOTE: NOT SUITABLE FOR SMALL SIZES SUCH AS THREADS, CHAMFERS, ETC

## QUICK MEASUREMENT SYSTEMS (WITHOUT STITCHING)

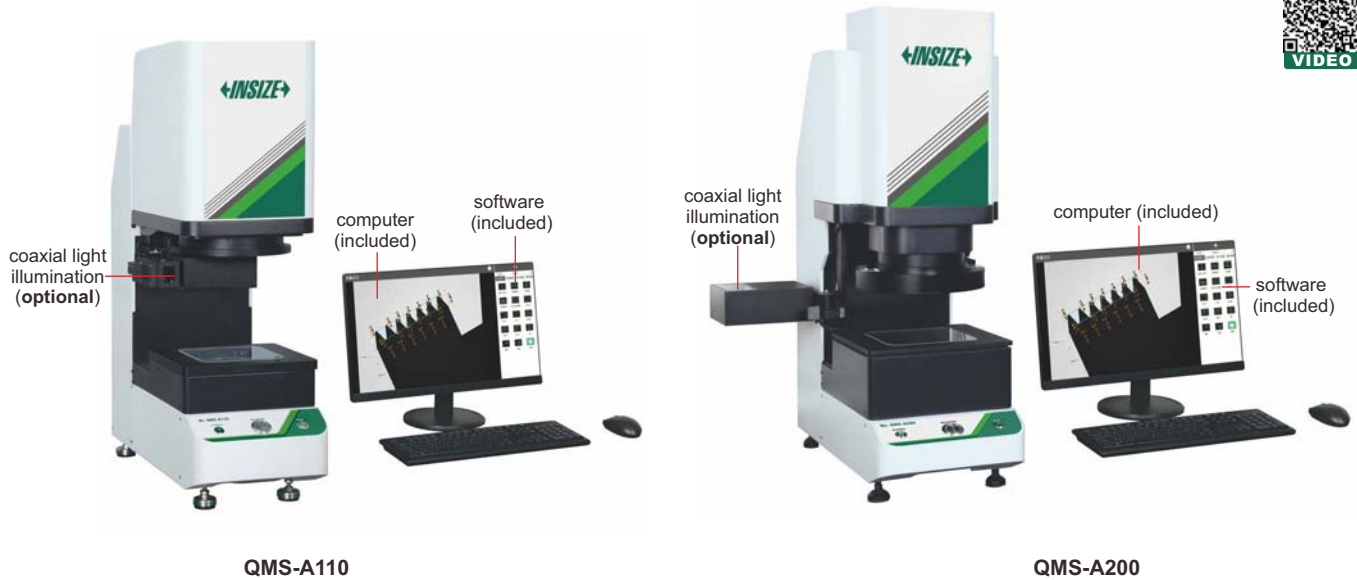

QMS-A110

QMS-A200

### SPECIFICATION

Code	QMS-A110	QMS-A200	
Optical lens	low-distortion lens, single-field telecentric Ø100mm	dual-field dual-telecentric low-distortion lens wide view field: Ø150mm small view field: Ø50mm	
View field range	100×80mm	<b>wide view field</b> 150×110mm	<b>small view field</b> 50×35mm
Measurement range (X×Y)	98×78mm	148×108mm	48×33mm
Measurement accuracy*	±3µm <sup>①</sup>	±5µm <sup>②</sup>	±2µm <sup>③</sup>
Repeatability	±1µm	±1µm	±0.5µm
Max. weight of workpiece	5kg		
Measurement time	<2s		
Measurement data	2D measurement		
Power supply	220V, 50Hz, 600W		
Illumination system	back light	telecentric illuminator, green light	
	ring light	4-zone circular white high light circular (directional) low-angle green light (eletric)	
	coaxial light (optional)	vertical illuminator, white light	
Environmental requirement	temperature: 20°C±2°C, relative humidity: 30%~80%, vibration: <0.002g, less than 15Hz		
Dimension (L×W×H)	580×235×790mm	638×336×885mm	
Weight	40kg	60kg	

\* The optimum temperature is 20°C±1°C

- ① Within 80×64mm, on focal position and environment temperature at 20°C±1°C
- ② Within 120×88mm, on focal position and environment temperature at 20°C±1°C
- ③ Within 40×28mm, on focal position and environment temperature at 20°C±1°C

Continued from previous page

- One or more workpieces can be measured by one step operation
- Place workpieces at any position
- Focus and measure automatically
- Measurement of 999+dimensions and 200+workpieces
- **QMS-A110** is suitable for measuring small flat parts
- **QMS-A200** is suitable for measuring flat parts with low precision requirements and small surface sizes

**STANDARD DELIVERY**

Main unit	1 pc
Computer	1 pc
Software	1 pc



11.6" LCD (optional)

**OPTIONAL ACCESSORY**

Coaxial light illumination	QMS-23-A3 (for QMS-A110) QMS-23-A4 (for QMS-A200)
Data transmission function of software	QMS-23-D1
CAD import function of software	QMS-23-C1
Foot-switch	QMS-43-FS1
11.6" LCD	QMS-23-B1 (must be installed in factory)

**Software (included)**

- Automatically measure widths, holes, rings, angles at the same time, simple and efficient

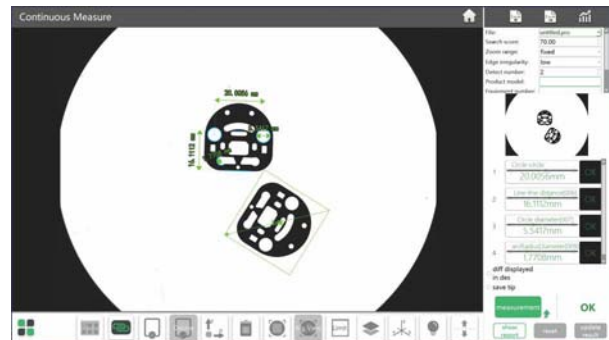
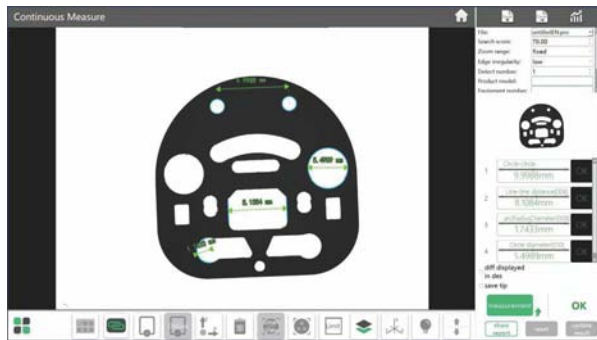

- Measuring result can be stored automatically. OK items and NG items can be counted automatically





## AUTOMATIC CNC VISION MEASURING SYSTEM (PROFESSIONAL TYPE) CODE ISD-F432



- Stable and high-precision measurement under high-speed, silent and stable mode
- Accurately detect the edge of surface size



six-ring eight-zone ring light (included)



vertical light (included)

### SPECIFICATION

Camera	giga-bit network camera	
Measuring range (X×Y×Z)	400×300×200mm (650TVL)	
Granite stage size	827×480mm	
Glass stage size	450×350mm	
Resolution of X/Y/Z axis	0.5μm	
Accuracy of X/Y axis	≤(2+L/250)μm (L is the measuring length in mm)	
Accuracy of Z axis	≤(3+L/150)μm (L is the measuring length in mm)	
Objective	0.7X~5X (zoom)	
Working distance	68mm	
Magnification	28X~155X (on 23.5" monitor)	
Illumination	surface	six-ring eight-zone ring light and vertical light
	contour	bottom horizontal light
Max. height of workpiece	200mm	
Max. weight of workpiece	30kg	
Operation system	Windows 10	
Power supply	220V±10% (AC), 50Hz	
Environment requirement	temperature: 18~24°C, relative humidity: 30~75%	
Dimension (L×W×H)	1270×910×1750mm	
Weight	360kg	

To be continued

Continued from previous page

### STANDARD DELIVERY

Main unit	1 pc
Computer	1 pc
Computer table	1 pc
Calibration glass chart	1 pc
Software	1 pc



laser probe (optional)



plate clamp (optional)

### OPTIONAL ACCESSORY

Advanced probe	probe base*	code <b>ISD-F-BASE1</b> (must be installed before shipment)
	probe*	code <b>ISD-F-TP20</b> (must be installed before shipment)
	ruby probe	optional M2 probe series with <b>ISQ-01</b> , refer to page 545
Standard probe	probe base*	code <b>ISD-F-BASE2</b> (must be installed before shipment)
	ruby probe	code <b>ISD-F-P2</b> code <b>ISD-F-P3</b>
Laser probe** (can measure glass thickness, step height, flatness, height etc.)		code <b>ISD-F-PB</b> (must be installed before shipment)
Special lens for large field navigation		code <b>ISD-F-LENS</b> (must be installed before shipment)
PLC full-angle intelligent programmable lighting system		code <b>ISD-F-LIGHT</b> (must be installed before shipment)
Plate fixture (manual self-locking tempered glass)		code <b>ISD-F-HOLDER</b> glass size: 450×350mm can be customized
Protector		code <b>ISD-F-PROTECTOR</b> (must be installed before shipment)
Contour comparison module		code <b>ISD-F-PROFILE</b>
Office software		code <b>7313-OFFICE</b>



advanced probe (optional)



standard probe (optional)

\* The probe head and probe are Renishaw brand  
\*\* Laser probe is KEYENCE brand

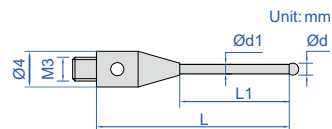

### STYLUS (INCLUDED) SPECIFICATION

Code	Material	Ød	Ød1	L	L1	Quantity
ISD-F-P2	ruby ball/stainles steel stem	Ø2mm	Ø1.4mm	21mm	8mm	1 pc
ISD-F-P3		Ø3mm	Ø1.5mm		12mm	1 pc

To be continued



Continued from previous page

### MEASURING SOFTWARE (INCLUDED)

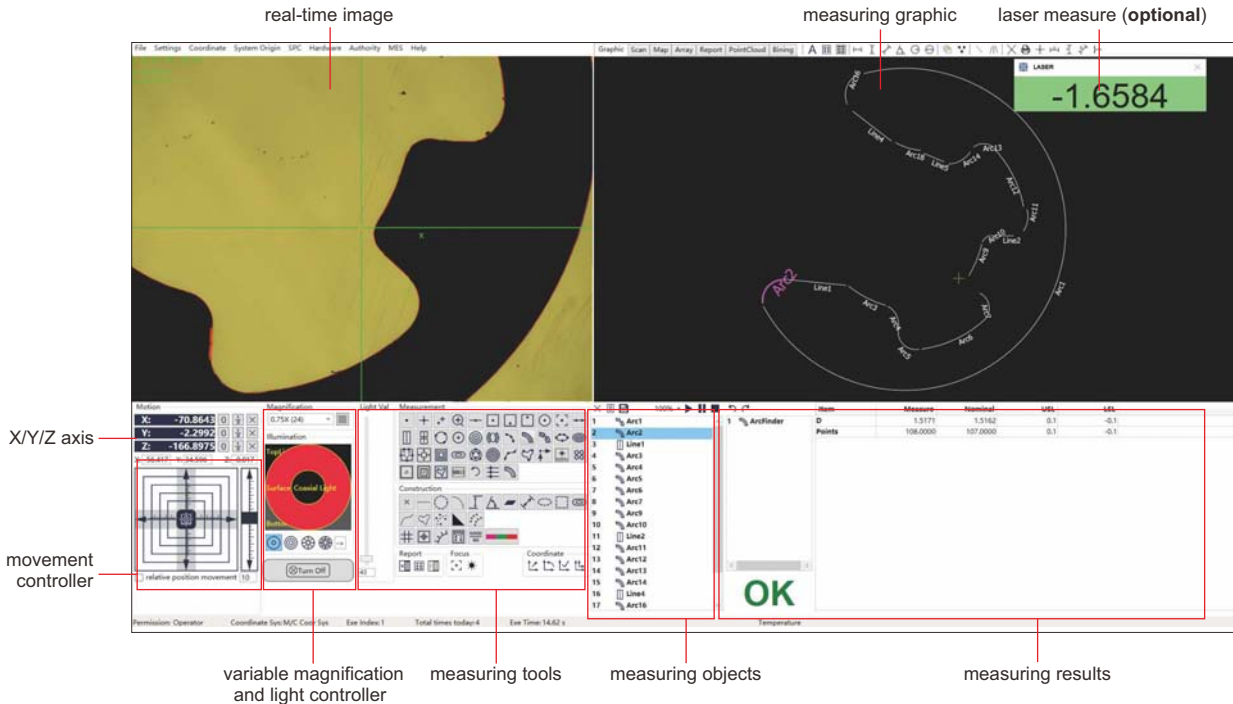

- Operation system: Windows 10
- Language: English
- Image measuring methods: crosshair point, manual point, auto point, zoom in point, line point, center point, lowest point, highest point, closest point, focus point
- Constructable elements: point, line circle, arc, height, angle, plane, distance, ellipse, rectangle, construction ringgroove, spline, closed spline, profile, geometric tolerance
- Geometric tolerance: concentricity, parallelism, verticality, angularity, symmetry, circular, arc profile
- Measurement elements can be translated and rotated
- Measuring data can export to Excel, DXF and other format files. The image area can save BMP image format
- The software includes CAD drawing import module
- The software includes SPC analysis module. The measurement software is seamlessly linked with the SPC module. After the measurement is completed, the measurement software automatically imports the data into the SPC database, allowing simple data analysis
- Dimension measuring tools:

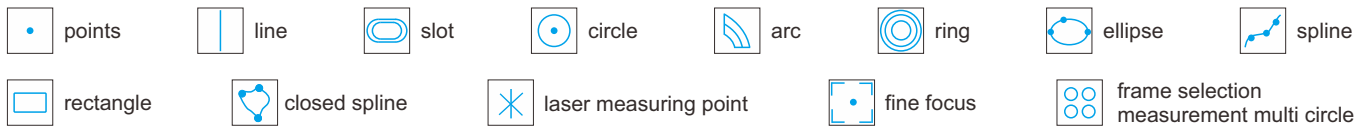

#### Element annotations

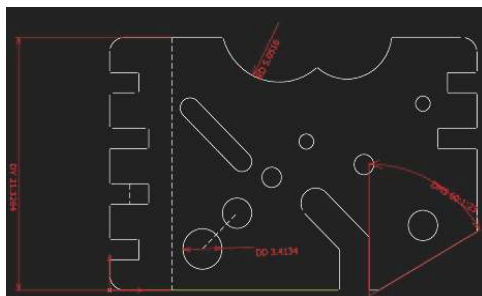

#### Accurately detect the edge of the surface size

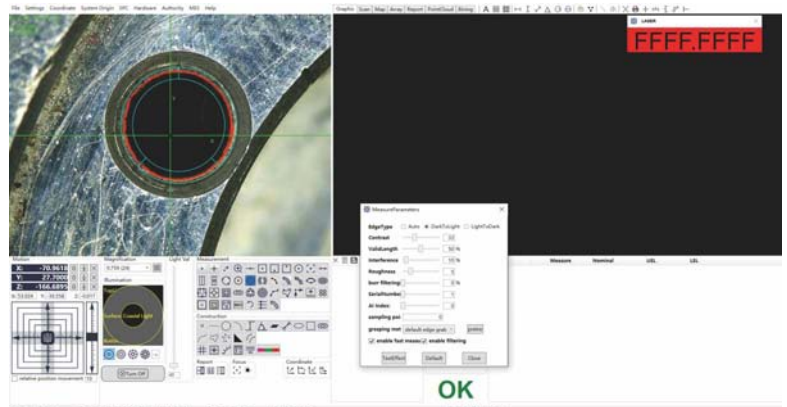

# HORIZONTAL VISION MEASURING SYSTEM CODE ISD-W3150



table (optional)

## SPECIFICATION

Measuring range (X×Z)	300×150mm	
Accuracy	≤(4+L/25)μm L is the measuring length in mm	
Resolution	0.5μm	
Y travel range (focus)	125mm	
Stage	metal stage size	455×126mm
	turning range	±15°
	max. load capacity	30kg
Objective	0.7X~4.5X (zoom)	
Working distance	96mm	
View field (diagonal length)	1.3~8.2mm	
Magnification	34X~213X	
Display	19"	
Camera	1/3" CMOS, 0.8M pixel	
Illumination	surface and contour with adjustable LED	
Operation system	Windows 10	
Drive method	manual	
Power supply	220V, 50Hz	
Dimension (L×W×H)	1164×634×1048mm	
Weight	200kg	



demo sample (optional)



vise (optional)

## STANDARD DELIVERY

Main unit (including computer)	1 pc
Software	1 pc
Calibration glass chart	1 pc
Clay	1 pc
Anti-dust cover	1 pc

## OPTIONAL ACCESSORY

0.5X auxiliary objective	code: ISD-W-OB05X working distance: 175mm magnification: 17~106.5X
2X auxiliary objective	code: ISD-W-OB2X working distance: 32mm magnification: 68~426X
Office software	code: 7313-OFFICE
Table	code: ISD-W-TABLE
Vise	code: ISP-A3000-VISE
Demo sample	code: ISP-A3000-DEMO

To be continued

Continued from previous page

**MEASURING SOFTWARE (INCLUDED)**

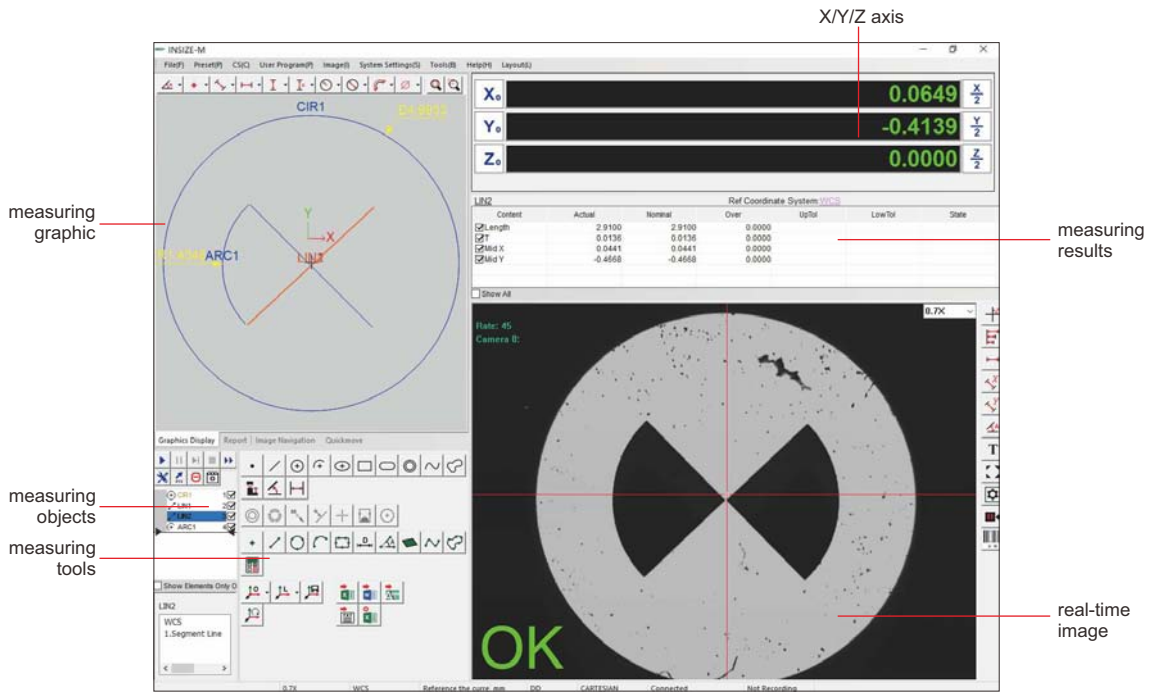

**HIGH-DEFINITION VISION MEASURING SYSTEMS (MANUAL TYPE)**

- High-definition image
- Large view field
- Electronic magnification feedback lens: when the objective lens magnification is changed manually, the software automatically selects the corresponding pre-calibration data and calibration is not needed

**INSPECTION CERTIFICATE**

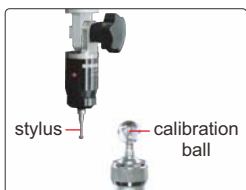

probe (optional), includes Ø2mm and Ø3mm styli, Ø25mm calibration ball, measuring accuracy is 10µm



lens with coaxial light (optional, must be installed in factory)



ISD-H210

computer is included

**STANDARD DELIVERY**

Main unit	1 pc
Computer	1 pc
Calibration glass chart	1 pc
Clay	1 pc
Foot switch	1 pc
Anti-dust cover	1 pc

To be continued

Continued from previous page

**SPECIFICATION**

Code	ISD-H210	ISD-H320	ISD-H430
Measuring range (X*Y*Z)	200×100×150mm	300×200×150mm	400×300×150mm
Stage size	404×228mm	500×330mm	606×466mm
Glass stage size	260×160mm	350×250mm	450×350mm
Resolution of X/Y/Z axis	0.5μm		
Accuracy of X/Y axis	≤(3.5+L/100)μm (L is the measuring length in mm)		
Repeatability of X/Y axis	2μm		
Objective	0.58X~7.5X (zoom)		
View field (diagonal length)	1.4mm~14mm		
Working distance	82mm		
Magnification	27.4X~351X (on 24" monitor)		
Camera	giga-bit network camera		
Illumination	surface and contour with adjustable LED		
Max. height of workpiece	150mm		
Max. weight of workpiece	20kg		
Operation system	Windows 7/8/10		
Drive method	manual		
Power supply	110~240V, 50/60Hz		
Dimension (L*W*H)	540×560×850mm	760×600×900mm	970×670×940mm
Weight	110kg	140kg	240kg

**OPTIONAL ACCESSORY**

0.5X auxiliary objective	code: <b>ISD-H-OB05X</b> working distance: 155mm magnification: 13.7~175.5X (on 24" monitor)
2X auxiliary objective	code: <b>ISD-H-OB2X</b> working distance: 34.5mm magnification: 54.8~702X (on 24" monitor)
Probe	code: <b>ISD-V-PROBE</b> includes Ø2mm and Ø3mm styli, Ø25mm calibration ball
Vision measuring system with coaxial light lens	code: <b>ISD-H210CL, ISD-H320CL, ISD-H430CL</b>
Office software	code: <b>7313-OFFICE</b>

**SOFTWARE (INCLUDED)**

- Refer to page 590~591 for details

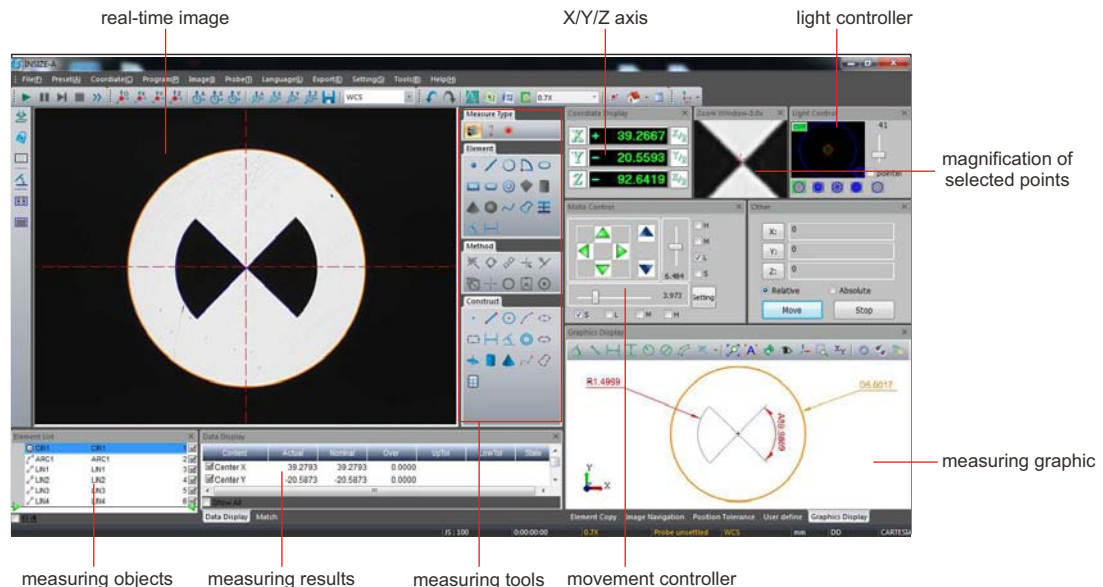

## VISION MEASURING SYSTEMS (MANUAL TYPE)



lens with coaxial light (optional, must be installed in factory)

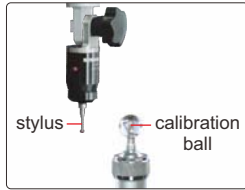

probe (optional), includes Ø2mm and Ø3mm styli, Ø25mm calibration ball, measuring accuracy is 10µm



ISD-V250A

computer is included

### SPECIFICATION

Code	ISD-V150A	ISD-V250A	ISD-V300A	ISD-V400A
Measuring range (X×Y×Z)	150×100×150mm	250×150×150mm	300×200×150mm	400×300×150mm
Stage size	354×228mm	450×280mm	500×330mm	606×466mm
Glass stage size	210×160mm	306×196mm	350×250mm	450×350mm
Resolution of X/Y/Z axis	0.5µm			
Accuracy of X/Y axis	≤(3.5+L/100)µm (L is the measuring length in mm)			
Repeatability of X/Y axis	2µm			
Objective	0.7X~4.5X (zoom)			
Working distance	92mm			
Magnification	33X~195X (on 19" monitor)			
Camera	1/3" color CCD, 0.3M pixel			
Illumination	surface and contour with adjustable LED			
Max. height of workpiece	150mm			
Max. weight of workpiece	20kg			
Operation system	Windows 7/8/10			
Drive method	manual			
Power supply	110/220V, 50/60Hz			
Dimension (L×W×H)	560×540×850mm	760×600×900mm	760×600×900mm	970×670×940mm
Weight	100kg	120kg	140kg	240kg

### STANDARD DELIVERY

Main unit	1 pc
Computer	1 pc
Calibration glass chart	1 pc
Clay	1 pc
Foot switch	1 pc
Anti-dust cover	1 pc

### OPTIONAL ACCESSORY

0.5X auxiliary objective	code: ISD-V-OB05X working distance: 175mm magnification: 16.5~97.5X (on 19" monitor)
2X auxiliary objective	code: ISD-V-OB2X working distance: 36mm magnification: 66~390X (on 19" monitor)
Probe	code: ISD-V-PROBE includes Ø2mm and Ø3mm styli, Ø25mm calibration ball
Vision measuring system with coaxial light lens (with computer)	code: ISD-V150ACL, ISD-V250ACL, ISD-V300ACL, ISD-V400ACL
Office software	code: 7313-OFFICE

To be continued

Continued from previous page

**SOFTWARE (INCLUDED)**

- Refer to page 590~591 for details

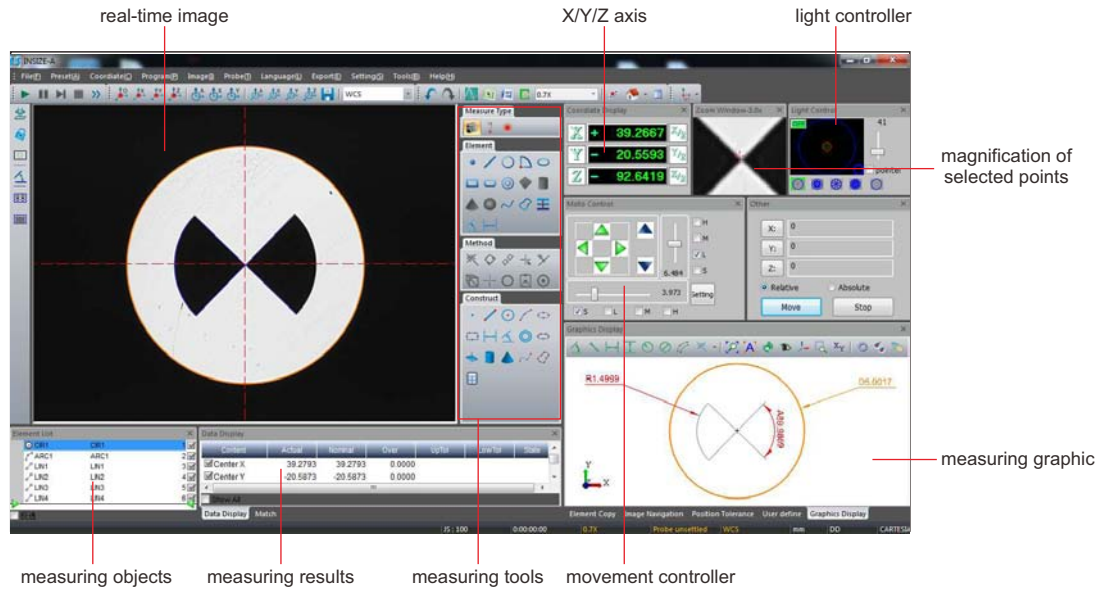

**CNC VISION MEASURING SYSTEMS (WITH STAND)**

MOTORIZED ZOOM OBJECTIVE IS OPTIONAL



lens with coaxial light (included)

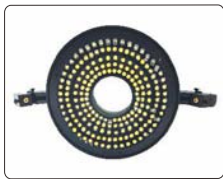

programmable segmented ring light (included)



software flash disk (included)



- Automatic edge-detection, focus, measuring, contour scanning, calibration, etc.
- Servo motors for X, Y, Z axis
- Granite body, more stable
- SPC function for large quantity measurement
- Measuring software is included (page 590~591)

**STANDARD DELIVERY**

Main unit	1 pc
Dongle	1 pc
Software	1 pc
Computer	1 pc
Display	1 pc
Lens with coaxial light	1 pc
Controller	1 pc
Calibration glass chart	1 pc
Laser positioner	1 pc
Clay	1 pc
Anti-dust cover	1 pc



ISD-E320

To be continued

Continued from previous page

**SPECIFICATION**

<b>Code</b>	<b>ISD-E320</b>	<b>ISD-E430</b>
<b>Measuring range (X×Y×Z)</b>	300×200×200mm	400×300×200mm
<b>Stage size</b>	556×406mm	561×556mm
<b>Glass stage size</b>	350×250mm	450×350mm
<b>Resolution of X/Y/Z axis</b>	0.5μm	
<b>Accuracy of X/Y axis</b>	≤(2.5+L/200)μm (L is measuring length in mm)	≤(3.5+L/200)μm (L is measuring length in mm)
<b>Repeatability of X/Y axis</b>	2μm	
<b>Objective (manual zoom)</b>	0.7X~4.5X (zoom)	
<b>Working distance</b>	92mm	
<b>View field (diagonal length)</b>	1.7~11.1mm	
<b>Magnification</b>	33X~208.6X (on 24" monitor)	
<b>Camera</b>	giga-bit network camera	
<b>Illumination</b>	<b>surface</b>	coaxial light, programmable segmented ring light
	<b>contour</b>	adjustable LED light
<b>Max. height of workpieces</b>	200mm	
<b>Max. weight of workpieces</b>	30kg	
<b>Operation system</b>	Windows 7/8/10	
<b>Drive method</b>	automatic	
<b>Power supply</b>	220V, 50/60Hz	
<b>Dimension (L×W×H)</b>	1420×915×1830mm	1650×1170×1900mm
<b>Weight</b>	500kg	700kg

**OPTIONAL ACCESSORY**

<b>0.5X auxiliary objective</b>	code: <b>ISD-V-OB05X</b> working distance: 175mm magnification: 16.5~104.3X (on 24" monitor)
<b>2X auxiliary objective</b>	code: <b>ISD-V-OB2X</b> working distance: 36mm magnification: 66~417.2X (on 24" monitor)
<b>Probe</b>	code: <b>ISD-V-PROBE</b> includes Ø2mm and Ø3mm styli, Ø25mm calibration ball
<b>Office software</b>	code: <b>7313-OFFICE</b>
<b>Laser probe</b>	code: <b>ISD-V-LASER</b>

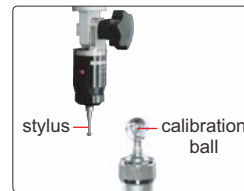

probe (optional), includes Ø2mm and Ø3mm styli, Ø25mm calibration ball, measuring accuracy is 10μm



laser probe (optional) measuring accuracy is 5μm

**SOFTWARE (INCLUDED)**

- Refer to page 590~591 for details

The screenshot shows the INSIZE software interface. Labels point to various parts of the software:

- real-time image**: Points to the main image window showing a circular object with two dark lobes.
- X/Y/Z axis**: Points to the coordinate system display in the top right.
- light controller**: Points to the light control panel in the top right.
- magnification of selected points**: Points to a zoomed-in view of a specific point on the object.
- measuring objects**: Points to the list of measured features in the bottom left table.
- measuring results**: Points to the numerical data for the selected feature.
- measuring tools**: Points to the tool palette in the center.
- movement controller**: Points to the movement control panel in the bottom right.
- measuring graphic**: Points to the graphical representation of the measured feature.

# CNC VISION MEASURING SYSTEMS



- Automatic edge-detection, focus, measuring, contour scanning, calibration, etc.
- Servo motors for X, Y, Z axis
- SPC function for large quantity measurement
- Measuring software is included (page 590~591)

## SPECIFICATION

Code	motorized zoom lens	ISD-V220ZA	ISD-V220ZHN	ISD-V270ZA	ISD-V270ZHN	ISD-V370ZA	ISD-V370ZHN
	manual zoom lens	ISD-V220CNCA	ISD-V220HN	ISD-V270CNCA	ISD-V270HN	ISD-V370CNCA	ISD-V370HN
Measuring range (X×Y×Z)		220×120×150mm	220×120×300mm	270×170×150mm	270×170×300mm	370×270×150mm	370×270×300mm
Stage size		450×280mm	450×280mm	500×330mm	500×330mm	606×466mm	606×466mm
Glass stage size		306×196mm	306×196mm	350×250mm	350×250mm	450×350mm	450×350mm
Resolution of X/Y/Z axis		0.5μm					
Accuracy of X/Y axis		≤(2.5+L/100)μm (L is the measuring length in mm)				≤(3.5+L/100)μm (L is the measuring length in mm)	
Repeatability of X/Y axis		2μm					
Objective		0.7X~4.5X (zoom)					
Working distance		92mm					
Magnification		33.0X~208.6X (with manual zoom lens, on 24" monitor) 31.9X~188.7X (with motorized zoom lens, on 24" monitor)					
Camera		giga-bit network camera					
Illumination	surface	coaxial light, programmable segmented ring light					
	contour	adjustable LED light					
View field (diagonal length)		1.5~10.8mm					
Max. height of workpiece		150mm	300mm	150mm	300mm	150mm	300mm
Max. weight of workpiece		30kg					
Operation system		Windows 7/8/10					
Drive method		automatic					
Power supply		220V, 50/60Hz					
Dimension (L×W×H)		760×600×900mm	760×600×1050mm	760×600×900mm	760×600×1050mm	970×670×940mm	970×670×1090mm
Weight		146kg	156kg	168kg	178kg	266kg	276kg

To be continued



Continued from previous page



software flash disk (included)



laser probe (optional)  
measuring accuracy is 5µm

**STANDARD DELIVERY**

Main unit	1 pc
Software	1 pc
Computer	1 pc
24" display	1 pc
Len with coaxial light	1 pc
Controller	1 pc
Calibration glass chart	1 pc
Laser positioner	1 pc
Clay	1 pc
Anti-dust cover	1 pc

desk (optional)

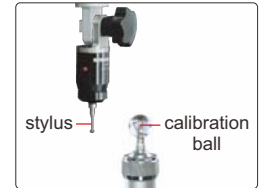

probe (optional), includes Ø2mm and Ø3mm styli, Ø25mm calibration ball, measuring accuracy is 10µm

**OPTIONAL ACCESSORY**

0.5X auxiliary objective	code: <b>ISD-V-OB05X</b> , working distance: 175mm magnification: 16.5~104.3X (with manual zoom lens, on 24" monitor), 16.0~94.4X (with motorized zoom lens, on 24" monitor)
2X auxiliary objective	code: <b>ISD-V-OB2X</b> , working distance: 36mm magnification: 66~417.2X (with manual zoom lens, on 24" monitor), 63.8~377.4X (with motorized zoom lens, on 24" monitor)
Probe	code: <b>ISD-V-PROBE</b> , includes Ø2mm and Ø3mm styli, Ø25mm calibration ball
Laser probe	code: <b>ISD-V-LASER</b>
Office software	code: <b>7313-OFFICE</b>
Desk	code: <b>ISD-V-DESK</b>

**SOFTWARE (INCLUDED)**

- Refer to page 590~591 for details

real-time image

XY/Z axis

light controller

magnification of selected points

measuring objects

measuring results

measuring tools

movement controller

measuring graphic

## CNC VISION MEASURING SYSTEMS



ISD-V500N



computer is included

- Automatic edge-detection, focus, measuring, contour scanning, calibration, etc.
- Servo motors for X, Y, Z axis
- SPC function for large quantity measurement

### SPECIFICATION

Code	ISD-V500N	ISD-V501N	ISD-V500HN	ISD-V501HN
Measuring range (X*Y*Z)	470×370×200mm	500×400×200mm	470×370×400mm	500×400×400mm
Stage size	786×636mm	846×696mm	786×636mm	846×696mm
Glass stage size	570×470mm			
Resolution of X/Y/Z axis	0.5μm			
Accuracy of X/Y axis	≤(2.5+L/200)μm (L is measuring length in mm)			
Repeatability of X/Y axis	2μm			
Objective	0.7X~4.5X (zoom)			
Working distance	92mm			
View field (diagonal length)	1.5~10.8mm			
Magnification	33.0X~208.6X (on 24" monitor)			
Camera	giga-bit network camera			
Illumination	surface	coaxial light, programmable segmented ring light		
	contour	adjustable LED light		
Max. height of workpieces	200mm		400mm	
Max. weight of workpieces	30kg			
Operation system	Windows 7/10			
Drive method	automatic			
Power supply	220V, 50/60Hz			
Dimension (L*W*H)	1270×1200×1870mm	1405×1260×1870mm	1270×1200×2070mm	1405×1260×2070mm
Weight	870kg	1000kg	900kg	1030kg

To be continued

Continued from previous page

**STANDARD DELIVERY**

Main unit	1 pc
Video card with dongle	1 pc
Software disc	1 pc
Lens with coaxial light	1 pc
Controller	1 pc
Computer	1 pc
Calibration glass chart	1 pc
Laser positioner	1 pc
Clay	1 pc
Anti-dust cover	1 pc



lens with coaxial light (included)

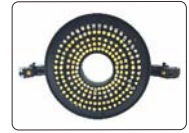

programmable segmented ring light (included)

**OPTIONAL ACCESSORY**

0.5X auxiliary objective	code: <b>ISD-V-OB05X</b> working distance: 175mm magnification: 16.5~104.3X (on 24" monitor)
2X auxiliary objective	code: <b>ISD-V-OB2X</b> working distance: 36mm magnification: 66~417.2X (on 24" monitor)
Probe	code: <b>ISD-V-PROBE</b> includes Ø2mm and Ø3mm styli, Ø25mm calibration ball
Office software	code: <b>7313-OFFICE</b>

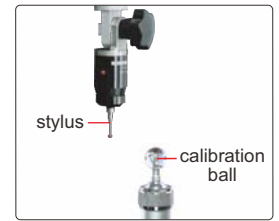

probe (optional), includes Ø2mm and Ø3mm styli, Ø25mm calibration ball, measuring accuracy is 10µm

**SOFTWARE (INCLUDED)**

- Refer to page 590~591 for details

The screenshot shows the INSIZE software interface with several components labeled:

- real-time image:** The main window displays a live video feed of a circular object with a dark, cross-shaped feature.
- XY/Z axis:** A coordinate system is overlaid on the image, with X, Y, and Z axes.
- light controller:** A panel on the right side of the interface allows for adjusting the lighting of the camera.
- magnification of selected points:** A zoomed-in view of a specific point on the object is shown in the bottom right corner.
- measuring objects:** A table at the bottom left lists the measured features and their properties.
- measuring results:** A table at the bottom center displays the numerical results of the measurements.
- measuring tools:** A toolbar on the left side provides various tools for interacting with the image and measurements.
- movement controller:** A panel on the right side of the interface allows for controlling the camera's movement.

## CNC VISION MEASURING SYSTEMS

MOTORIZED ZOOM  
OBJECTIVE IS OPTIONAL



VMM-L1001CN

- Automatic edge-detection, focus, measuring, contour scanning, calibration, etc.
- Servo motors for X, Y, Z axis, X, Y axis adopt linear guide rail structure, without air supply
- Fixed glass table and granite platform base, good stability
- SPC function for large quantity measurement
- Measuring software is included (page 590~591)

### SPECIFICATION

Code	VMM-L600CN	VMM-L601CN	VMM-L800CN
Measuring range (X×Y×Z)	600×600×200mm	600×900×200mm	800×1000×200mm
Glass stage size	765×1238mm	702×1543mm	902×1643mm
Resolution of X/Y/Z axis	0.5μm		
Accuracy of X/Y axis	≤(3.5+L/200)μm (L is measuring length in mm)		
Repeatability of X/Y axis	2μm		
Objective (manual zoom)	0.7X~4.5X (zoom)		
Working distance	92mm		
View field (diagonal length)	1.7~11.1mm		
Magnification	33.0X~208.6X (on 24" monitor)		
Camera	giga-bit network camera		
Illumination	surface	coaxial light, programmable segmented ring light	
	contour	adjustable LED light	
Max. height of workpiece	200mm		
Max. weight of workpiece	35kg		
Operation system	Windows 7/8/10		
Drive method	automatic		
Power supply	AC 220V, 50/60Hz		
Dimension (L×W×H)	1445×1185×1560mm	1745×1220×1720mm	1850×1420×1720mm
Weight	1000kg	1400kg	2200kg

To be continued

Continued from previous page

### SPECIFICATION

Code	VMM-L1000CN	VMM-L1001CN	VMM-L1200CN
Measuring range (X×Y×Z)	1000×1200×200mm	1000×1500×200mm	1200×1500×200mm
Glass stage size	1100×1831mm	1100×2113mm	1300×2113mm
Resolution of X/Y/Z axis	0.5μm		
Accuracy of X/Y axis	≤(3.5+L/200)μm (L is measuring length in mm)		
Repeatability of X/Y axis	2μm		
Objective(manual zoom)	0.7X~4.5X (zoom)		
Working distance	92mm		
View field (diagonal length)	1.7~11.1mm		
Magnification	33.0X~208.6X (on 24" monitor)		
Camera	giga-bit network camera		
Illumination	surface	coaxial light, programmable segmented ring light	
	contour	adjustable LED light	
Max. height of workpiece	200mm		
Max. weight of workpiece	30kg		
Operation system	Windows 7/8/10		
Drive method	automatic		
Power supply	AC 220V, 50/60Hz		
Dimension (L×W×H)	2035×1590×1720mm	2315×1590×1720mm	2315×1790×1720mm
Weight	2900kg	3200kg	4000kg



programmable segmented ring light (included)



lens with coaxial light (included)

### STANDARD DELIVERY

Main unit	1 pc
Dongle	1 pc
Computer	1 pc
Software	1 pc
Display	1 pc
Lens with coaxial light	1 pc
Controller	1 pc
Calibration glass chart	1 pc
Laser positioner	1 pc
Clay	1 pc
Anti-dust cover	1 pc

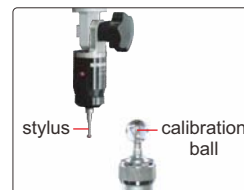

probe (optional), includes Ø2mm and Ø3mm styli, Ø25mm calibration ball, measuring accuracy is 10μm



laser probe (optional) measuring accuracy is 5μm

### OPTIONAL ACCESSORY

0.5X auxiliary objective	code: <b>ISD-V-OB05X</b> working distance: 175mm magnification: 16.5~104.3X (on 24" monitor)
2X auxiliary objective	code: <b>ISD-V-OB2X</b> working distance: 36mm magnification: 66~417.2X (on 24" monitor)
Probe	code: <b>ISD-V-PROBE</b> includes Ø2mm and Ø3mm styli, Ø25mm calibration ball
Laser probe	code: <b>ISD-V-LASER</b>
Office software	code: <b>7313-OFFICE</b>

# VISION MEASURING SOFTWARE

SOFTWARE FOR VISION MEASURING SYSTEMS  
 ISD-V SERIES, ISD-H SERIES, ISD-VMM SERIES,  
 ISD-E SERIES AND VMM-L SERIES

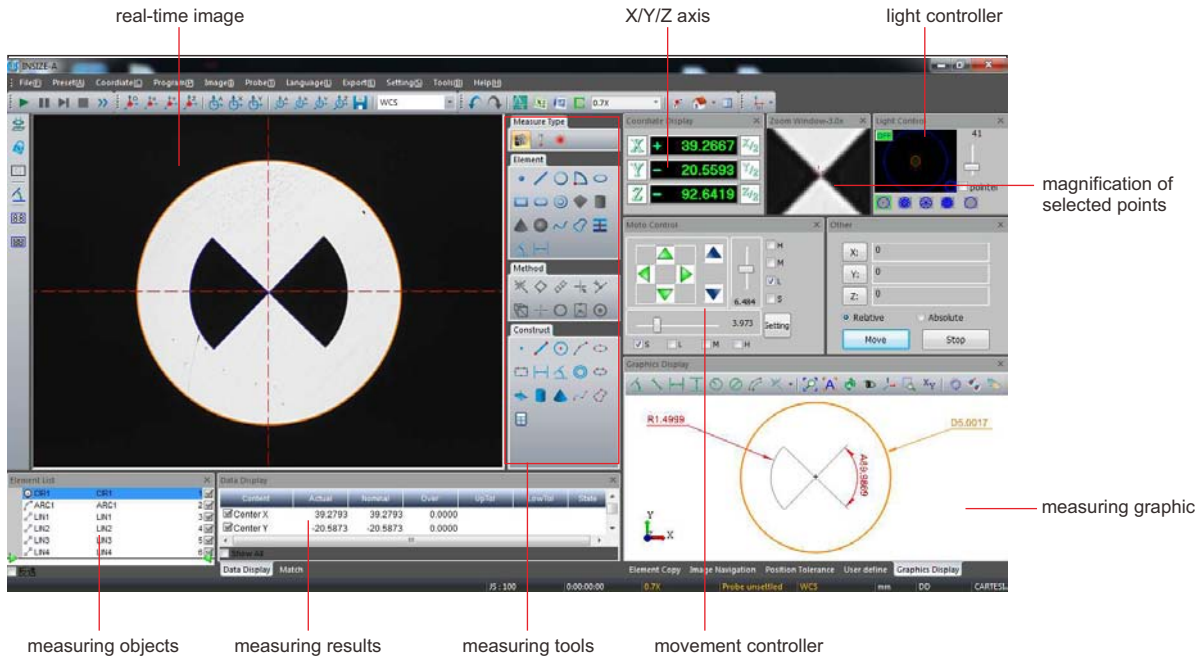

- Operation system: Windows 7/10
- Language: English
- Control features: assistant focus (manual machines), auto focus (CNC machines), auxiliary light control, motion controlled by mouse (CNC machines), auto zoom lens (CNC machines)
- Image measuring methods: intelligent automatic edge detect, select points of an area, select points from multiple parts, select points via mouse, select adjacent points, select points via cross line, magnify to select points, comparatively select points, select points via probe, edge point, contour point
- Constructable elements: point, line, circle, arc, ellipse, rectangle, distance, angle, ring, slot, plane, cone, open curve, closed curve
- Support fixture (CNC machines), scanning, image navigation, user define, pixel calibration
- Measuring by image and probe, image and probe can be synchronized
- Measuring data can be sent to Excel, Word, SPC, measuring elements can be sent to dxf

24

## Dimension measuring tools:

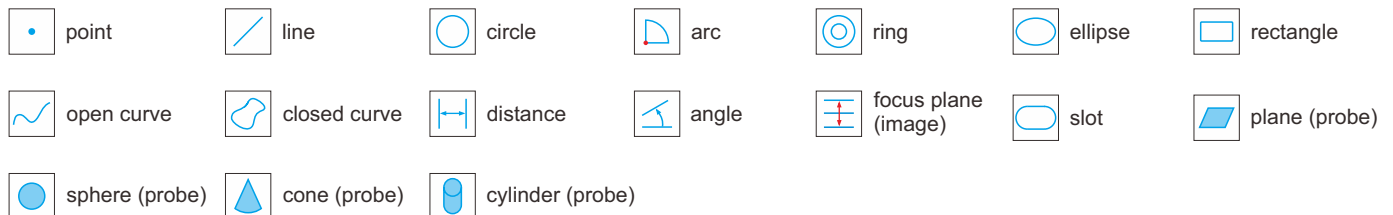

## Geometric measuring tools:



To be continued

Continued from previous page

Measuring and element construct methods:

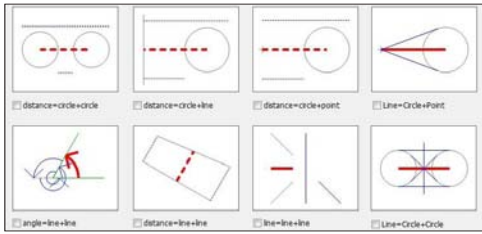

Sent to CAD, EXCEL, WORD

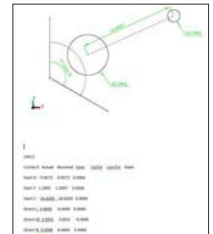
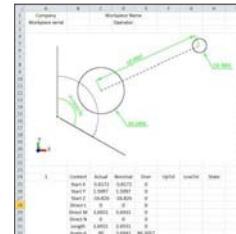
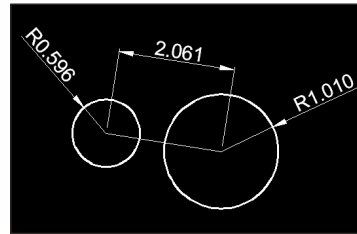

CAD

EXCEL

WORD

Edge-detection:

point tool

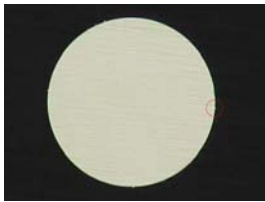

box tool

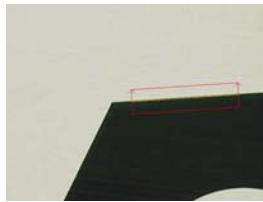

circle tool

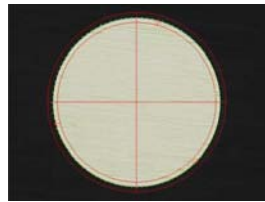

Contour scanning:

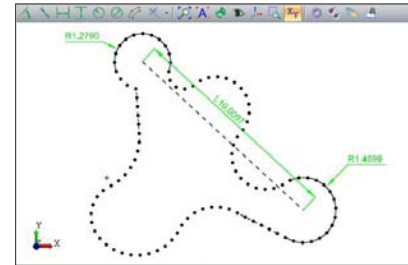

CAD measuring:

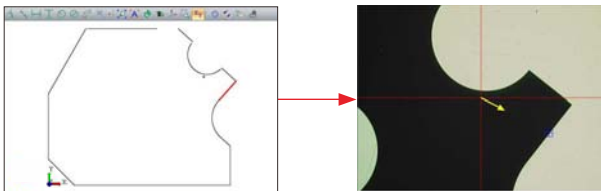

import CAD drawing, set the datum, establish coordinate system, then the software will automatically measure

CAD comparison:

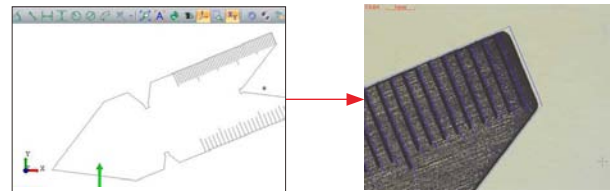

import CAD drawing, then compare with real-time image

Profile scanning:



SPC analysis, import the measuring data to SPC module, generate Xbar-R chart, Xbar-S chart, Mid-R chart, X-Rs chart, Histogram, Sigma A and Sigma S chart, Cpk process chart, Process state analyse chart, Single process advice analyse chart

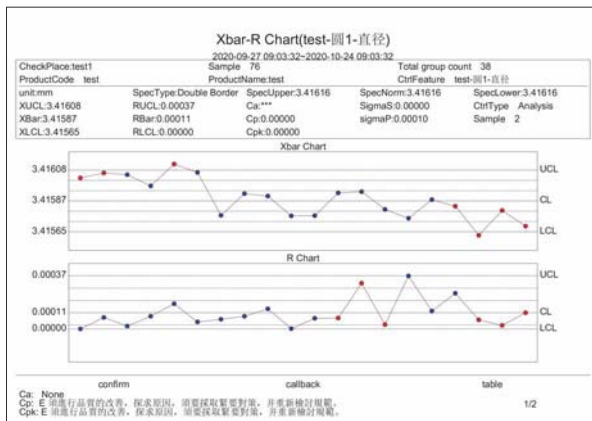

Xbar-R chart

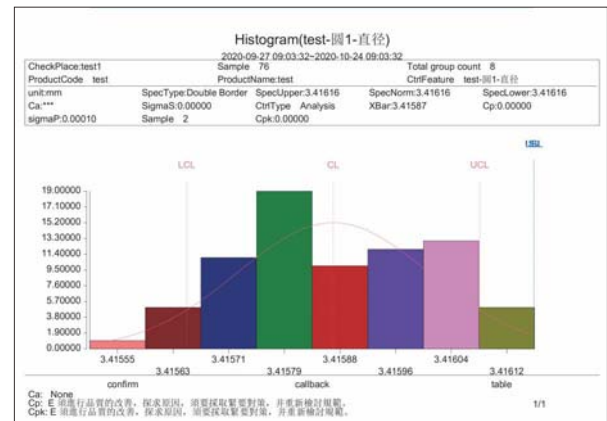

Histogram

# JIG SET FOR VISION MEASURING SYSTEMS CODE ISY-700

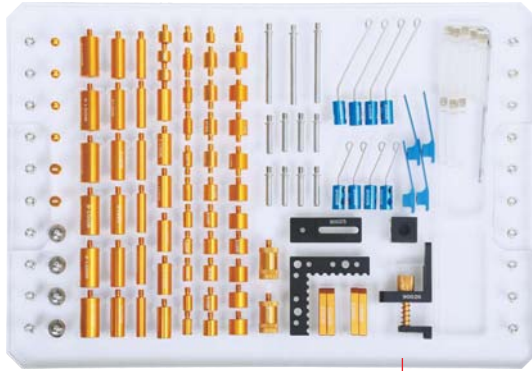

acrylic tray (included)

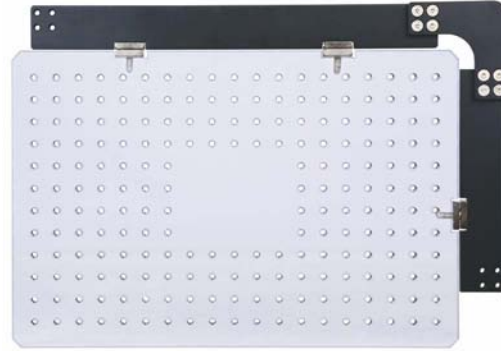

ISY-700

application example

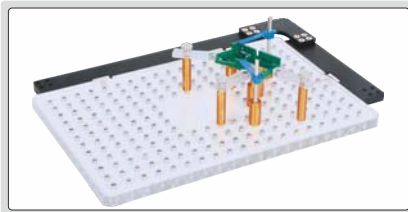

Product	Code	Size (mm)	Quantity
clip 	ISY-700-90001	7×34	4
clip 	ISY-700-90002	∅1.5×24	4
	ISY-700-90003	∅1.5×50	4
clip stand 	ISY-700-90004	∅4×20	8
	ISY-700-90005	∅4×46	3
spherical support head 	ISY-700-90006	—	4
stand 	ISY-700-90007	∅6×10	6
	ISY-700-90008	∅6×25	6
	ISY-700-90019	∅6×6	3
stand 	ISY-700-90009	∅9×7	3
	ISY-700-90010	∅9×10	6
	ISY-700-90011	∅9×20	6
	ISY-700-90012	∅9×25	6
stand 	ISY-700-90013	∅12×10	6
	ISY-700-90014	∅12×25	6
stand for slice parts 	ISY-700-90015	∅6×10	4
	ISY-700-90016	∅9×10	4
	ISY-700-90017	∅12×10	4
stand with fine adjustment 	ISY-700-90018	∅12×20~25	2

Product	Code	Size (mm)	Quantity
adapter for square support 	ISY-700-90020	—	2
clamping screw 	ISY-700-90021	—	4
L-shaped positioning plate 	ISY-700-90022	50×50×6	1
sliding support plate 	ISY-700-90023	30×12×5	4
square support 	ISY-700-90024	20×16×16	1
base for square support 	ISY-700-90025	45×16×6	1
spring stand 	ISY-700-90026	—	1
acrylic sliding support plate 	ISY-700-90028	45×12×5	8
wrench 	ISY-700-90029	M3	1
acrylic base plate 	ISY-700-90030	300×200×12 Hole size: M4X0.7	1



## STANDARD GLASS SCALES



ISD-CL300A

- To calibrate optical measuring instruments, also can be used as optical positioning elements in precision machine tools

### STANDARD TYPE

Code	Measuring range	Graduation	Length	Width	Thickness	Accuracy
ISD-CL100A	100mm	1mm	130mm	30mm	5mm	1 $\mu$ m
ISD-CL200A	200mm	1mm	230mm	30mm	5mm	1 $\mu$ m
ISD-CL300A	300mm	1mm	330mm	30mm	5mm	1 $\mu$ m
ISD-CL400A	400mm	1mm	430mm	30mm	5mm	1 $\mu$ m
ISD-CL500A	500mm	1mm	530mm	30mm	5mm	2 $\mu$ m

### ECONOMIC TYPE

Code	Measuring range	Graduation	Length	Width	Thickness	Accuracy
ISD-CL100B	100mm	1mm	130mm	30mm	5mm	3 $\mu$ m
ISD-CL200B	200mm	1mm	230mm	30mm	5mm	3 $\mu$ m
ISD-CL300B	300mm	1mm	330mm	30mm	5mm	3 $\mu$ m
ISD-CL400B	400mm	1mm	430mm	30mm	5mm	3 $\mu$ m
ISD-CL500B	500mm	1mm	530mm	30mm	5mm	3 $\mu$ m

### PROFESSIONAL TYPE (The scale is between two layers of glass and will not be worn off)

Code	Measuring range	Graduation	Length	Width	Thickness	Accuracy
ISD-CL100S	100mm	1mm	130mm	30mm	10mm	1 $\mu$ m
ISD-CL200S	200mm	1mm	230mm	30mm	10mm	1.5 $\mu$ m
ISD-CL300S	300mm	1mm	330mm	30mm	15mm	2.5 $\mu$ m
ISD-CL400S	400mm	1mm	430mm	30mm	15mm	3 $\mu$ m
ISD-CL500S	500mm	1mm	530mm	30mm	15-25mm	3.5 $\mu$ m



**Toolmaker Microscopes**  
Page 595-596



**Digital Microscopes**  
Page 597-635

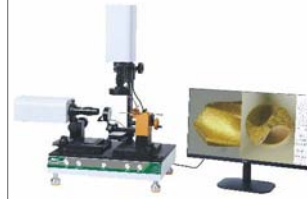

**Cutting Tools Microscopes**  
Page 622



**Industrial Microscopes**  
Page 636-637



**Metallurgical Microscopes**  
Page 638-641



**Zoom Stereo Microscopes**  
Page 642-648



**Polarizing Microscopes**  
Page 649



**Digital Cameras For Microscopes**  
Page 650-658

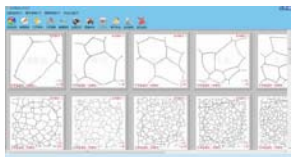

**Metallurgical Analysis Softwares**  
Page 657-658



**Portable Measuring Microscopes**  
Page 659



**Table Magnifiers With Illumination**  
Page 660



**Digital Magnifiers**  
Page 661-662



**Magnifiers**  
Page 663-667



**Telescoping Inspection Mirrors**  
Page 667



**Telescoping Pick-up**  
Page 668



10X dividing eyepiece

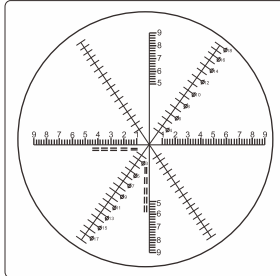

the horizontal and vertical scale lines are used for length measurement, the graduation is 0.2mm. the two diagonals scale lines are used for diameter measurement, the graduation is 1mm (when using 1X objective)

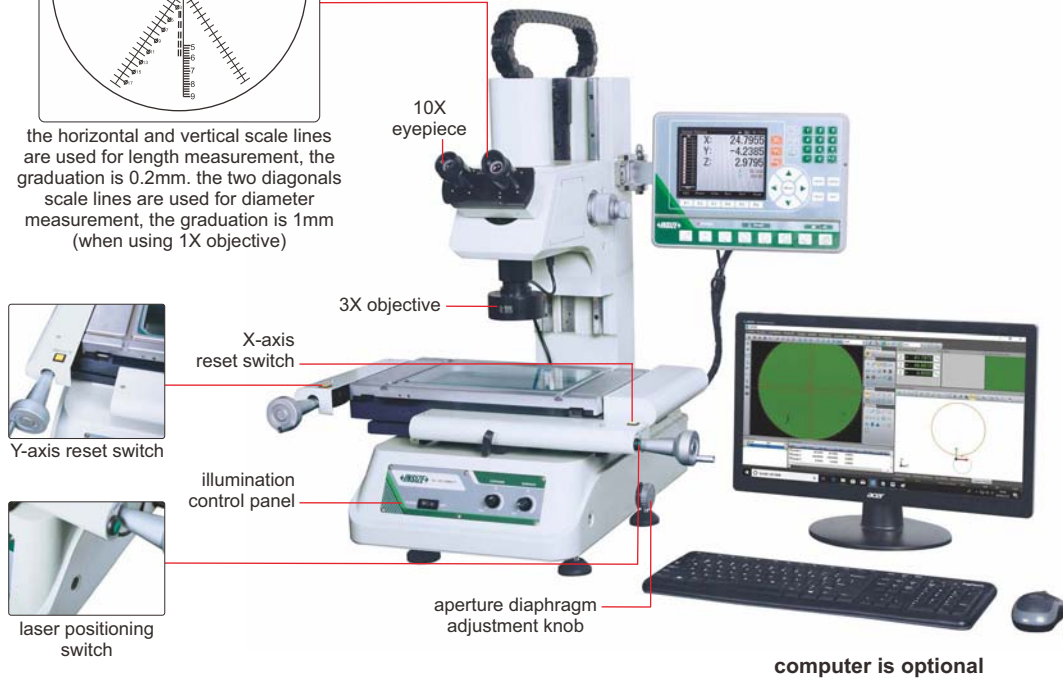

computer is optional

**ISD-VMM215**
**SPECIFICATION**

Code	binocular	ISD-VMM205	ISD-VMM215	ISD-VMM225	ISD-VMM235
	monocular	ISD-VMM205D	ISD-VMM215D	ISD-VMM225D	ISD-VMM235D
X/Y axis travel		150×100mm	200×100mm	250×150mm	300×200mm
Z axis travel		150mm	150mm	200mm	200mm
Metal stage size		354×228mm	404×228mm	450×280mm	500×330mm
Glass stage size		210×160mm	260×160mm	306×196mm	350×250mm
Resolution of X/Y/Z axis		0.5μm			
Accuracy of X/Y axis		≤(3.5+L/100)μm (L is the measuring length in mm)			
Repeatability		2μm			
Camera		1/3" color CCD, 0.3M pixel			
Optical magnification		30X (with 3X objective)			
Image magnification		114X (on 19" monitor)			
Illumination		surface and contour with adjustable LED			
Max. weight of workpiece		25kg			
Power supply		100V~240V, 50/60Hz			
Operation system		Windows 7/8/10			
Drive method		manual			
Dimension (L×W×H)		540×667×850mm	540×667×850mm	800×675×920mm	800×675×920mm
Weight		100kg	110kg	135kg	140kg

Continued from previous page

## DATA PROCESSING UNIT

<b>Output</b>	RS232
<b>Function</b>	simple measuring tools
	measure coordinate of points
	measure lines
	measure center coordinate, radius of circle with three points
	measure distances between two objects
	measure angles
	set origin of coordinate
	skew and calibrate the workpiece
	measure rectangle (including length, width, perimeter and center coordinate)
	measure thread (including thread diameter, screw pitch, screw angle)
measure slot (including center coordinate, length, width)	

## STANDARD DELIVERY

<b>Main unit</b>	1 pc
<b>Video card with dongle</b>	1 pc
<b>Software disc</b>	1 pc
<b>Calibration glass chart</b>	1 pc
<b>Demo sample</b>	1 pc
<b>Foot switch</b>	1 pc
<b>3X objective</b>	1 pc

## OPTIONAL ACCESSORY

<b>1X objective</b>	ISD-VMM-LENS1X
<b>5X objective</b>	ISD-VMM-LENS5X
<b>10X objective</b>	ISD-VMM-LENS10X
<b>Toolmaker microscopes (with computer)</b>	code: ISD-VMM205A (binocular) ISD-VMM215A (binocular) ISD-VMM225A (binocular) ISD-VMM235A (binocular)  code: ISD-VMM205DA (monocular) ISD-VMM215DA (monocular) ISD-VMM225DA (monocular) ISD-VMM235DA (monocular)

## SOFTWARE (INCLUDED)

- Refer to page 590~591 for details

25

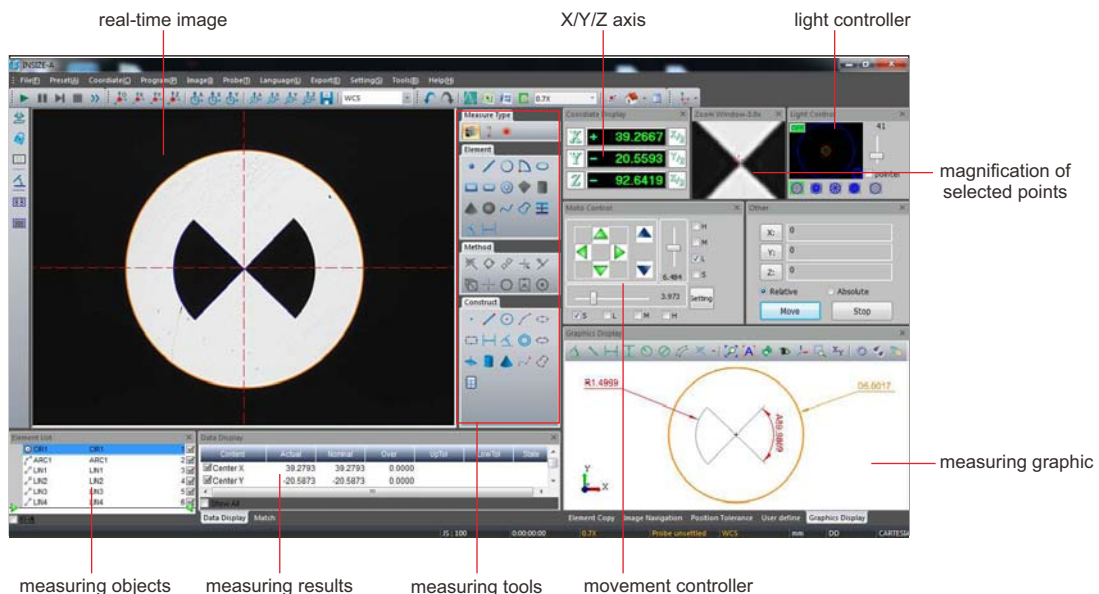

TAKE PICTURES AND VIDEOS

MEASUREMENT

CAN BE CONNECTED TO PC AND TV AT THE SAME TIME

AUTO FOCUS

## AUTO FOCUS DIGITAL MICROSCOPES (LARGE VIEW FIELD)

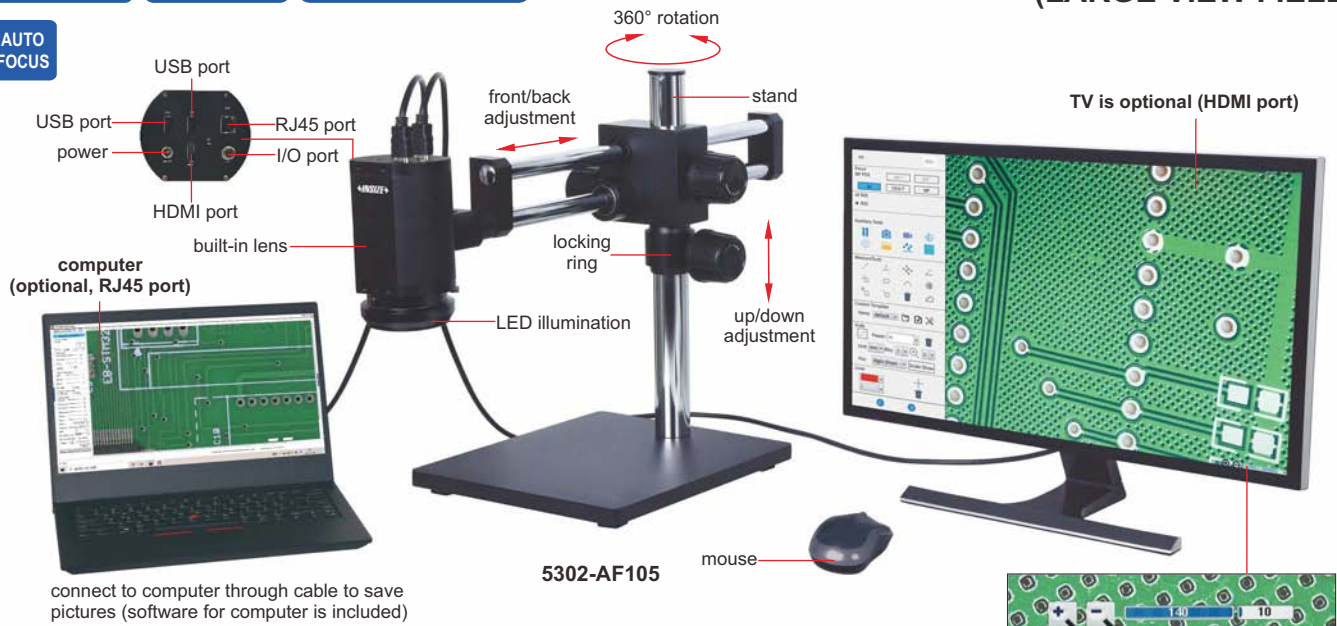

connect to computer through cable to save pictures (software for computer is included)

- Auto focus camera
- Take pictures and videos
- Can be connected to TV (HDMI port) and computer (RJ45 port) at the same time
- Built-in measuring software for TV
- Measuring software for computers is included
- Automatic exposure and white balance
- Brightness, contrast ratio, gain are adjustable
- Display cross hair (blue/green/red /yellow/black/brown colors)

5302-AF105

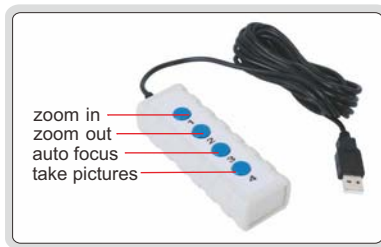

controller (optional, for TV)



optical zoom adjustment

### TV SOFTWARE (INCLUDED)

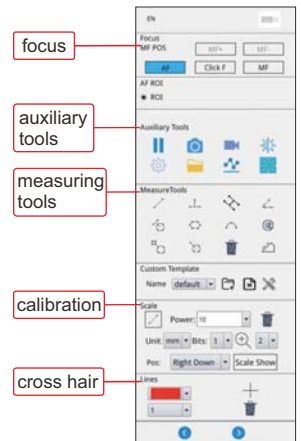

### SPECIFICATION

Code	5302-AF105 (standard type)	5302-AF108 (high-definition type)
Pixel	2M	8M
Resolution	1920×1080	3840×2160
Magnification	1.4X~25.8X (on 28" TV)	1.4X~51.6X (on 28" TV)
Sensor	1/2.8" CMOS	
Auto focus distance	100mm~∞	
Output	HDMI, RJ45	
Frame rate	HDMI: 60fps, RJ45: 50fps	
Power supply	power adapter	
Dimension (L×W×H)	500×280×410mm	
Weight	17kg	

### VIEW FIELD

Focus distance	Adjustable magnification (on 28" TV)	View field
100mm	3.9~25.8X	24×14~168×91mm
150mm	2.6~20X	30×17~240×128mm
200mm	2.1~17X	37×20~315×170mm
250mm	1.7~14.7X	42×24~385×210mm
270mm	1.4~14X	43×25~415×225mm

### MEASURING ACCURACY

Optical magnification (5302-AF105)	Optical magnification (5302-AF108)	Measuring accuracy
2X	2X	±0.1mm
4X	4X	±0.1mm
6X	6X	±0.04mm
8X	8X	±0.02mm
14X	14X	±0.02mm
/	28X	±0.02mm



### STANDARD DELIVERY

Main unit (with stand)	1 pc
LED illumination	1 pc
16G USB flash disk	1 pc
Mouse	1 pc
HDMI cable (for TV)	1 pc
Network cable (for computer)	1 pc
Switch	1 pc
Software for computer	1 pc
Power adapter	2 pcs

### OPTIONAL ACCESSORY

28" 4K TV	5302-AF-TV28
32" 4K TV	5302-AF-TV32
Computer	5302-AF-COMPUTER
Controller	5302-AF-CONTROLLER

# HIGH-DEFINITION AUTO FOCUS DIGITAL MICROSCOPE (LARGE VIEW FIELD) CODE 5320-AF410

AUTO FOCUS

MEASUREMENT

TAKE PICTURES  
AND VIDEOS

LED INDEPENDENT  
ADJUSTMENT

CAN BE CONNECTED TO PC  
AND TV AT THE SAME TIME

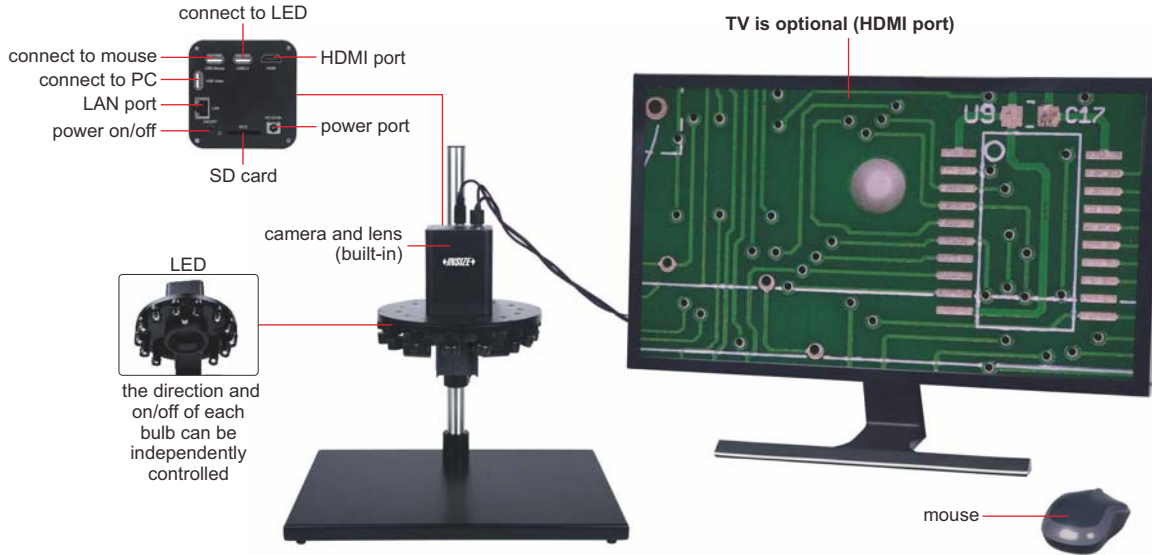

- Auto focus camera
- Take pictures and videos
- Built-in measuring software
- Automatic exposure, sharpening, denoising and white balance
- 4K/1080P automatically switched by display resolution
- Display actual magnification
- Digital magnification
- Motorized light control
- Display cross hair and gridline

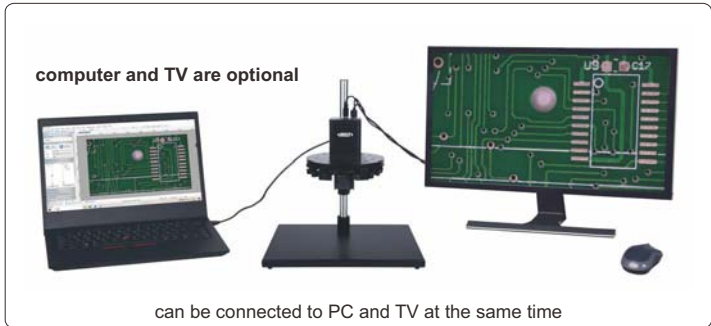

## SPECIFICATION

Magnification (on 28" TV)	2.4X~43.7X
View field	14.2×8~255×145mm
Auto focus distance	200~255mm
Sensor	1/2.8" CMOS
Pixel	8M
Resolution	3840×2160
Frame rate	30fps
Output	HDMI/USB/LAN
Power supply	power adapter
Dimension (L×W×H)	400×300×450mm
Weight	5.8kg

## MEASURING ACCURACY (ON 28" TV)

Optical magnification	Measuring accuracy
2X	±0.1mm
4X	±0.1mm
6X	±0.04mm
10X	±0.02mm
14X	±0.02mm
18X	±0.01mm

## STANDARD DELIVERY

Main unit (with stand)	1 pc
LED illumination	1 pc
32G memory card and holder	1 pc
Mouse	1 pc
HDMI cable	1 pc
USB 2.0 cable	1 pc
Power adapter	1 pc

To be continued

Continued from previous page

**SOFTWARE FOR TV (INCLUDED)**

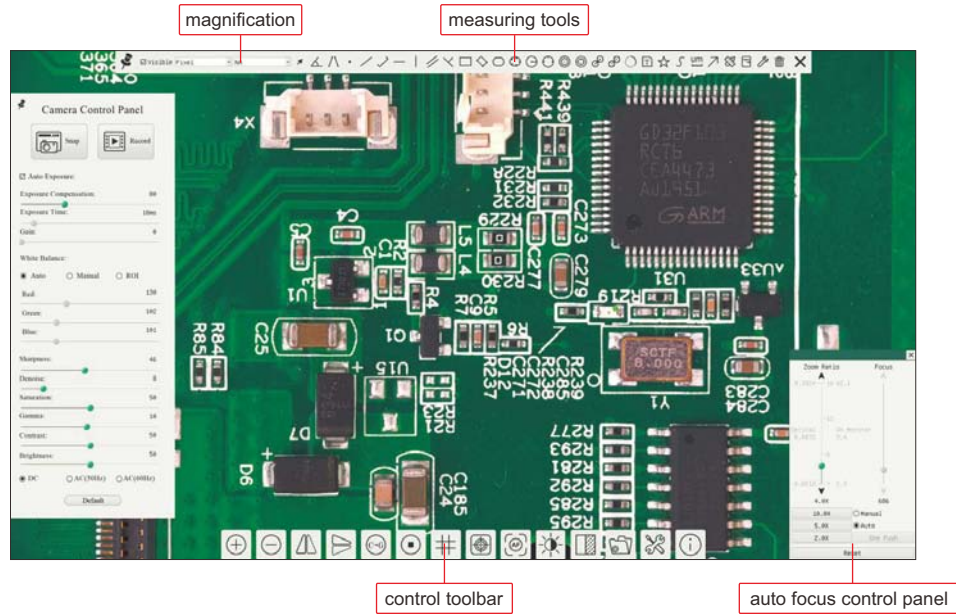

**PROFESSIONAL SOFTWARE (INCLUDED, FOR COMPUTER)**

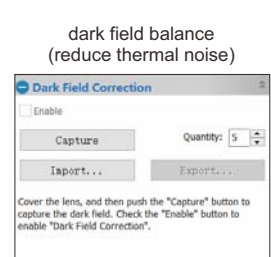
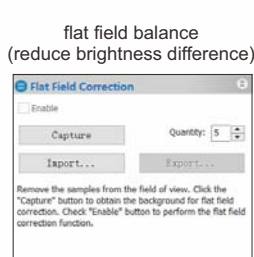
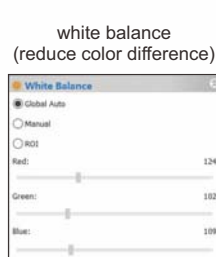
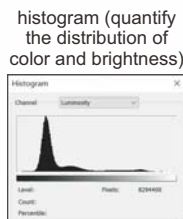
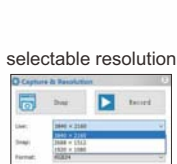
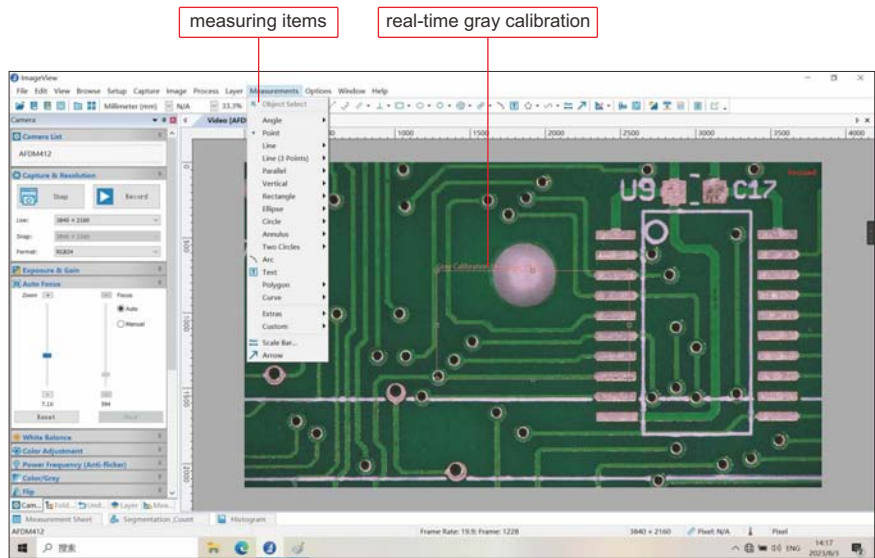
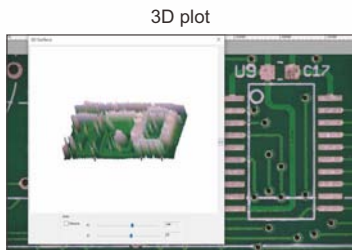
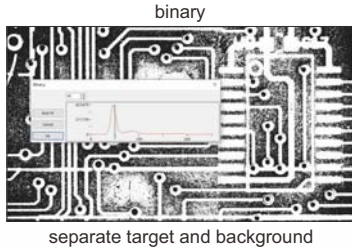

the software can control image completely, including measurement, image stitching, image gray processing, RGB histogram observation, image color sampling, 3D plot (3D representation of image intensity), image exposure, white balance, image bit depth, flat field correction and dark field correction, etc.

# HIGH-DEFINITION AUTO FOCUS MEASURING MICROSCOPE CODE 5315-S710

IMAGE  
STITCHING

DUAL SCREEN  
OPERATION

FOCUS  
STACKING

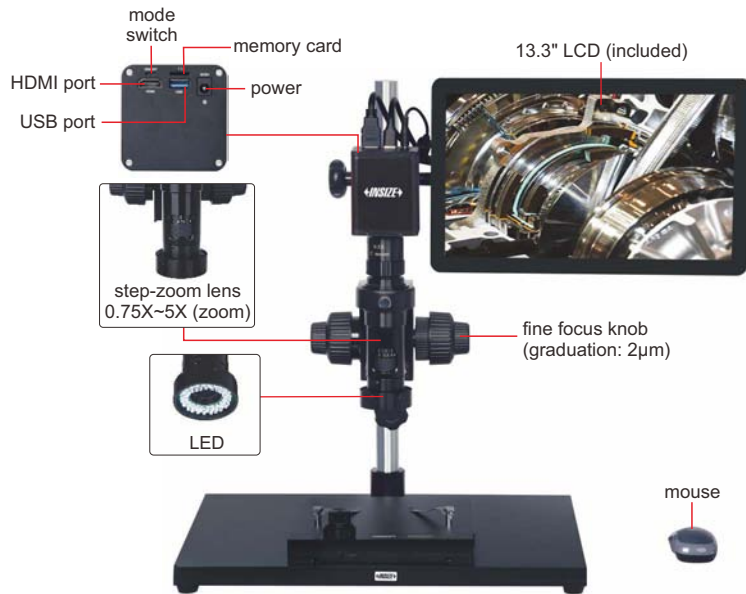

focus stacking



focus on the top



focus on the bottom



clear image of both  
top and bottom

- 12M high-definition image
- Switchable LCD mode and computer mode
- Take pictures or videos, save to memory card
- Measurement results can be sent to Excel
- Auto focus
- Automatic white balance and exposure

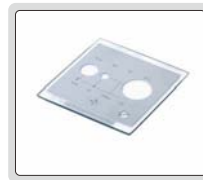

calibration plate  
(included)



1X camera adapter  
(optional)



2X auxiliary objective  
(optional)

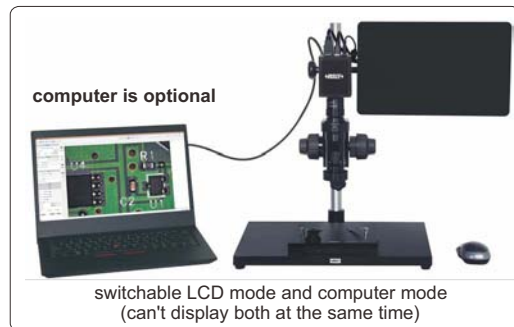

computer is optional

switchable LCD mode and computer mode  
(can't display both at the same time)



stage moving knob  
X-Y metal stage  
(included)  
(X-Y travel: 100×86mm)

image stitching

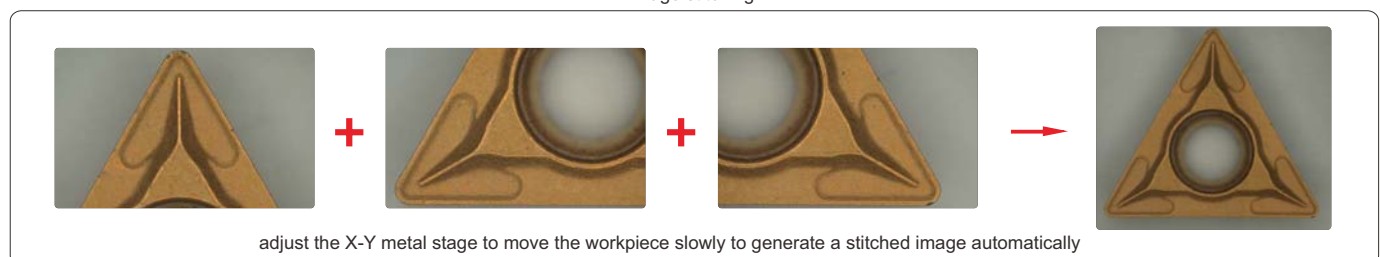

adjust the X-Y metal stage to move the workpiece slowly to generate a stitched image automatically

To be continued





Continued from previous page

**SPECIFICATION**

Magnification	15X~100X (on 13.3" LCD)
Sensor	1/1.7" CMOS
Pixel	12M
Resolution	1920×1080
Frame rate	30fps
Output	HDMI/USB
Power supply	power adapter
Dimension (L×W×H)	570×300×430mm

**STANDARD DELIVERY**

Main unit	1 pc
0.5X camera adapter	1 pc
1X auxiliary objective	1 pc
Calibration plate	1 pc
32G memory card	1 pc
Mouse	1 pc
X-Y metal stage	1 pc

**MAGNIFICATION, FOCUS DISTANCE AND VIEW FIELD (on 13.3" LCD)**

Specification	Camera adapter	
	0.5X (included)	1X (optional)
Magnification	15~100X	30~200X
Focus distance	80±2mm	80±2mm
View field	20.0×11.2~5.5×3.1mm	10.0×5.6~2.7×1.5mm

**OPTIONAL ACCESSORY**

1X camera adapter	ISM-DL-CA1X
2X auxiliary objective	ISM-DL-OB2X
Computer	ISM-DL-COMPUTER
LED light	page 626~627
Auxiliary objective	page 628

**MAGNIFICATION AND MEASURING ACCURACY (on 13.3" LCD)**

Objective magnification	Image magnification	Measuring accuracy
0.75X	15X	±20µm
1X	20X	±20µm
1.5X	30X	±20µm
2X	40X	±20µm
2.5X	50X	±20µm
3X	60X	±20µm
3.5X	70X	±20µm
4X	80X	±10µm
4.5X	90X	±10µm
5X	100X	±10µm

**SOFTWARE FOR LCD (INCLUDED)**

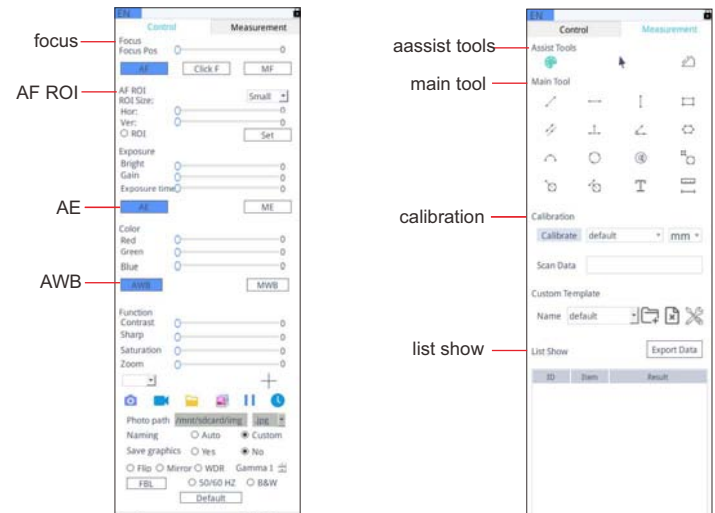

**SOFTWARE FOR COMPUTER (INCLUDED)**

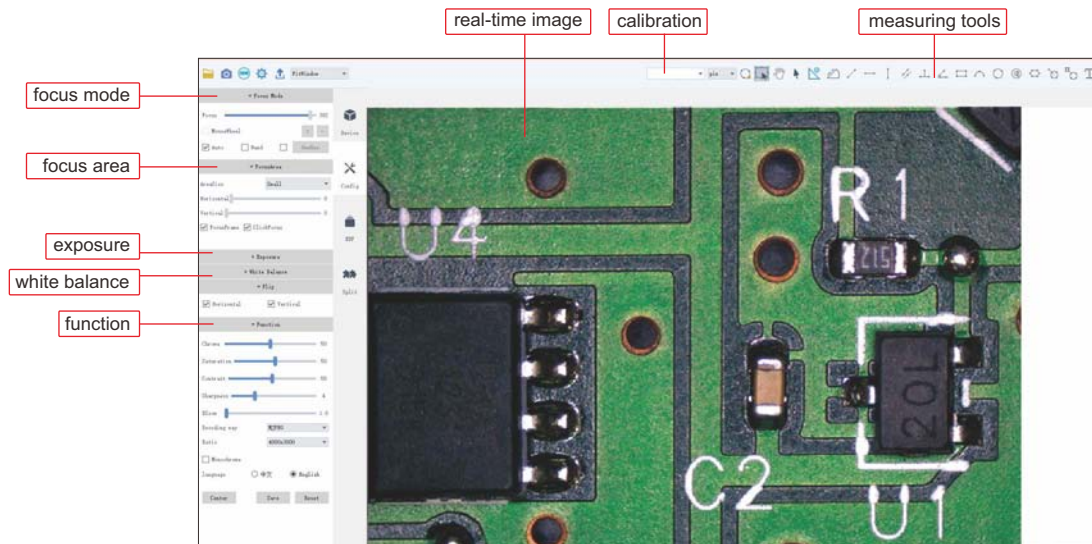

## AUTO FOCUS DIGITAL MICROSCOPE CODE 5303-AF103

AUTO FOCUS

TAKE PICTURES  
AND VIDEOS

MEASUREMENT

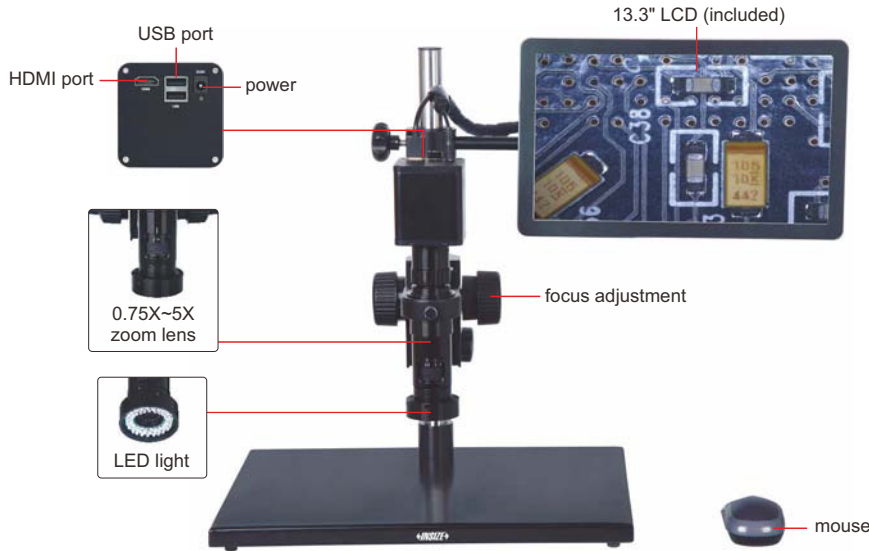

16G USB flash disk (included)



0.5X camera adapter (included)



1X auxiliary objective (included)

- 1080P high-definition image
- Auto focus camera
- Take pictures and videos, saved to USB flash disk
- Picture review, picture compare
- Automatic exposure and white balance
- Brightness, contrast ratio, gain are adjustable
- Display cross hair (blue/green/red/yellow/black/brown colors)
- Built-in software without computer, operation by mouse

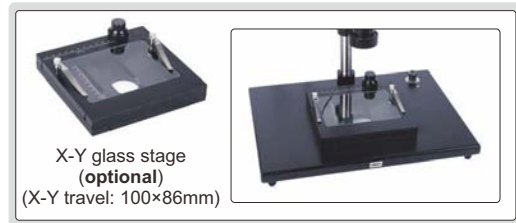

X-Y glass stage (optional)  
(X-Y travel: 100×86mm)

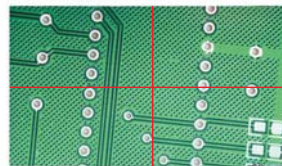

display cross hair  
(blue/green/red/yellow/black/brown colors)



1X camera adapter (optional)



2X auxiliary objective (optional)

### SPECIFICATION

Magnification	20X~123X
Sensor	1/2.8" CMOS
Pixel	2M
Resolution	1920×1080
Frame rate	60fps
Output	HDMI
Power supply	power adapter
Dimension (L×W×H)	570×300×430mm
Weight	6.5kg

### STANDARD DELIVERY

Main unit	1 pc
0.5X camera adapter	1 pc
1X auxiliary objective	1 pc
Calibration plate	1 pc
16G USB flash disk	1 pc
White/black plate	1 pc
Mouse	1 pc
HDMI cable	1 pc
Power adapter	2 pcs

### MAGNIFICATION, FOCUS DISTANCE AND VIEW FIELD

Auxiliary objective	Specification	Camera adapter	
		0.5X (included)	1X (optional)
1X (included)	magnification	20~123X	40~246X
	focus distance	48~84mm	48~84mm
	view field	13×7~2.2×1mm	6.3×3.5~1.1×0.5mm
	measuring accuracy	±0.02mm	±0.02mm
2X (optional)	magnification	40~246X	80~492X
	focus distance	24~42mm	24~42mm
	view field	6.5×3.5~1.1×0.5mm	3.3×1.8~0.6×0.3mm
	measuring accuracy	±0.02mm	±0.02mm

### AUTO FOCUS DISTANCE

Zoom objective scale	0.75X	1X	1.5X	2X	2.5X
Auto focus distance (mm)	48~84	50~78	55~73	62~71	65~70
Zoom objective scale	3X	3.5X	4X	4.5X	5X
Auto focus distance (mm)	66~70	67~70	68~70	68~70	68~70

### OPTIONAL ACCESSORY

1X camera adapter	ISM-DL-CA1X
2X auxiliary objective	ISM-DL-OB2X
X-Y glass stage (travel: 100×86mm)	ISM-DL-STAGE
X-Y metal stage	ISM-DL-STAGE1
LED light	page 626~627
Auxiliary objective	page 628

TAKE PICTURES AND VIDEOS

SUITABLE TO CHECK CONVEX OBJECTS AND WALL OF HOLE

### 3D MOTORIZED ROTATION MICROSCOPE CODE 5301-D400

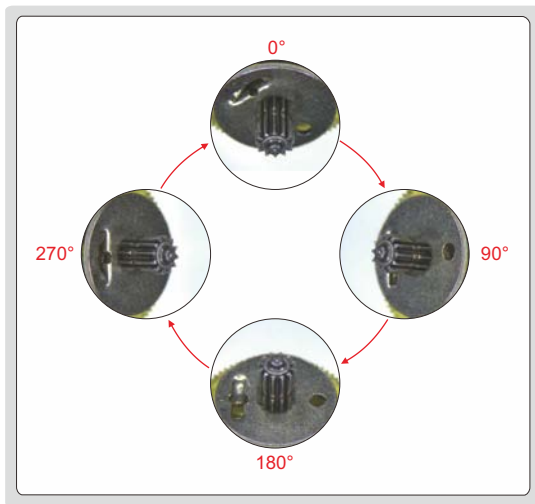
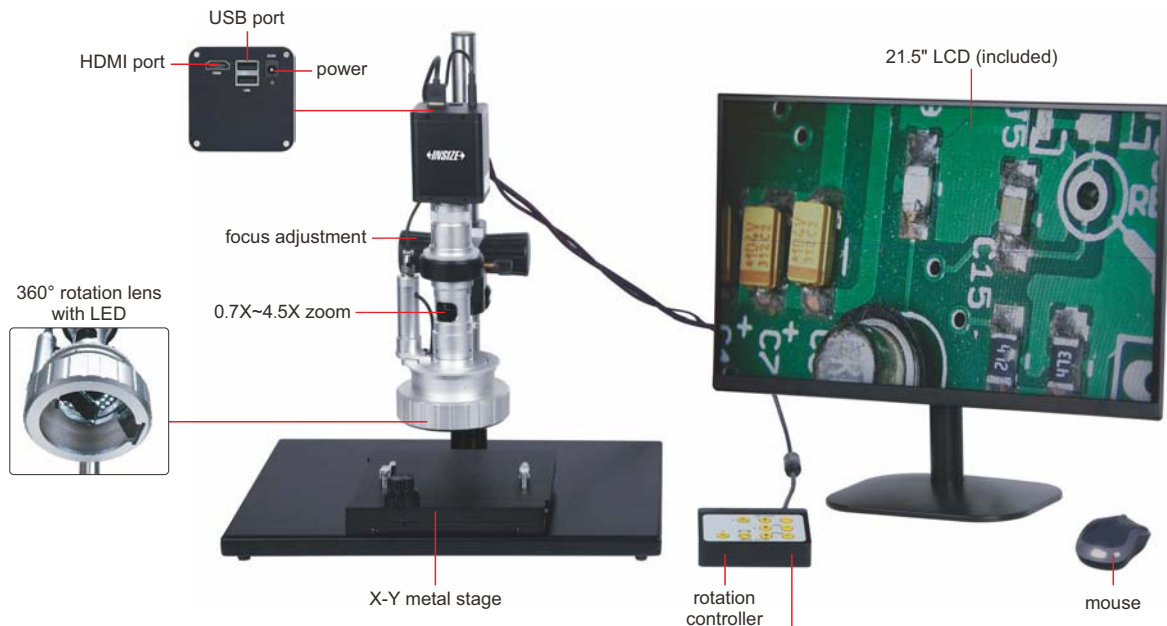

360° rotation observation

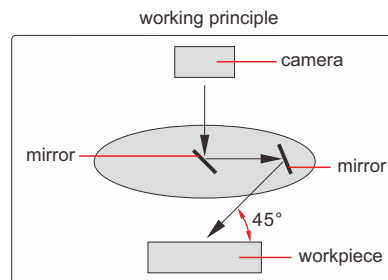
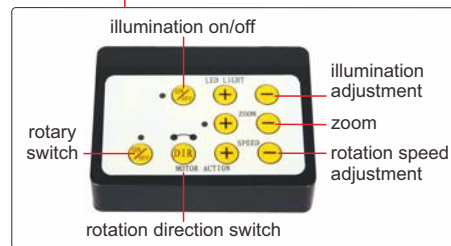

**SPECIFICATION**

Magnification	15X~100X
View field	4.2×2.7mm~28×18mm
Focus distance	40mm
View angle	45°
Sensor	1/2.8" CMOS
Pixel	2M
Resolution	1920×1080
Frame rate	60fps
Output	HDMI
Rotation speed	2~4RPM
Power supply	110/220V, 50/60Hz
Dimension (L×W×H)	570×300×430mm
Weight	10kg

- 1080P high-definition 3D image
- Take pictures and videos, save to USB flash disk
- Automatic white balance and exposure
- Brightness, contrast ratio and gain are adjustable

**STANDARD DELIVERY**

Main unit	1 pc
Rotation controller	1 pc
X-Y metal stage	1 pc
16G USB flash disk	1 pc
White/black plate	1 pc
Mouse	1 pc
Power adapter	2 pcs

# 3D MANUAL ROTATION MICROSCOPE CODE 5313-S407

TAKE PICTURES AND VIDEOS

SUITABLE TO CHECK CONVEX OBJECTS  
AND WALL OF HOLES

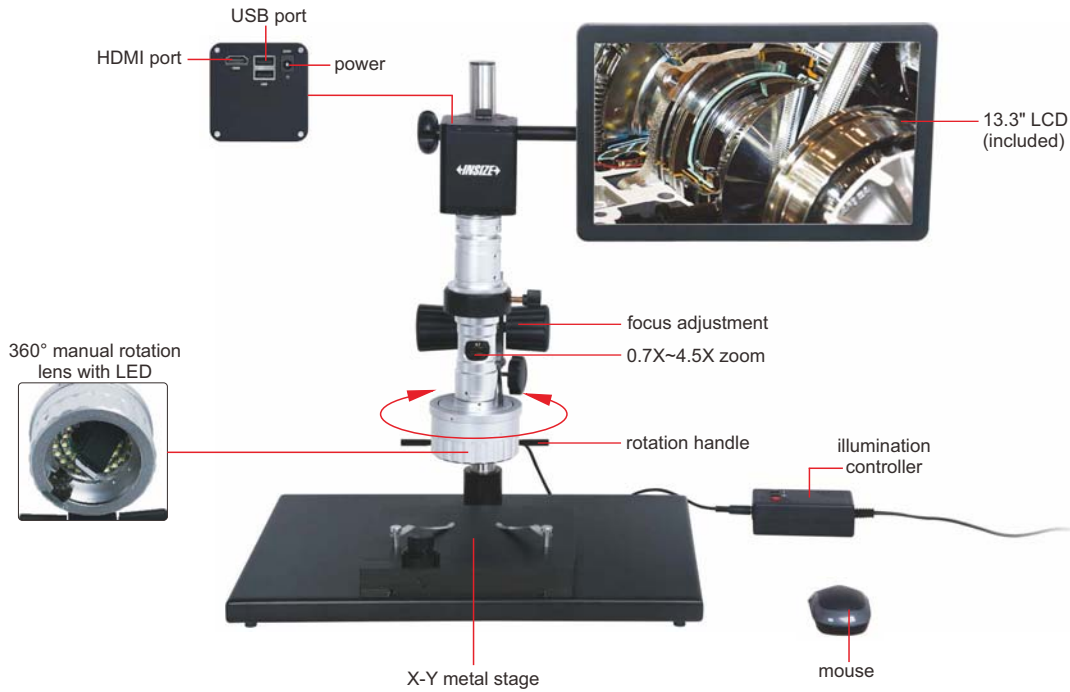

working principle

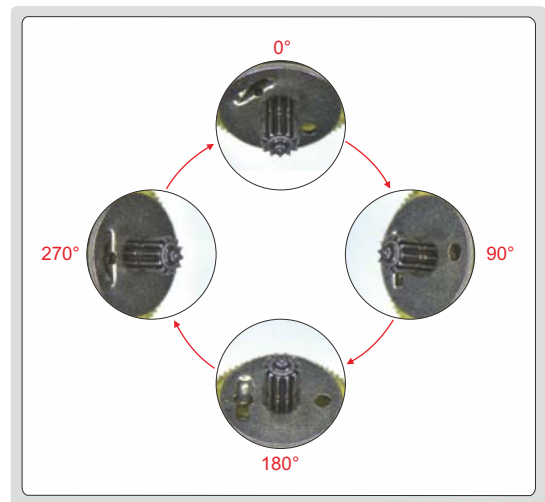
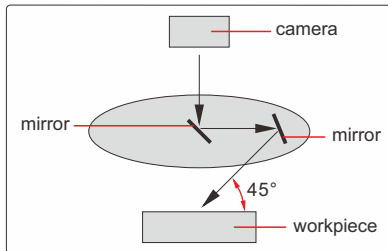

360° rotation observation

### SPECIFICATION

Magnification	18X~120X
View field	2.4×1.5mm~16×9mm
Focus distance	20mm
View angle	45°
Sensor	1/2.8" CMOS
Pixel	2M
Resolution	1920×1080
Frame rate	60fps
Output	HDMI
Power supply	220V, 50/60Hz
Dimension (L×W×H)	570×300×430mm
Weight	10kg

### STANDARD DELIVERY

Main unit	1 pc
X-Y metal stage	1 pc
16G USB flash disk	1 pc
White/black plate	1 pc
Mouse	1 pc
Power adapter	2 pcs

MEASUREMENT

TAKE PICTURES

BUILT-IN SOFTWARE WITHOUT COMPUTER

POPULAR MODEL

## DIGITAL MEASURING MICROSCOPE (BASIC TYPE) CODE 5318-MD60

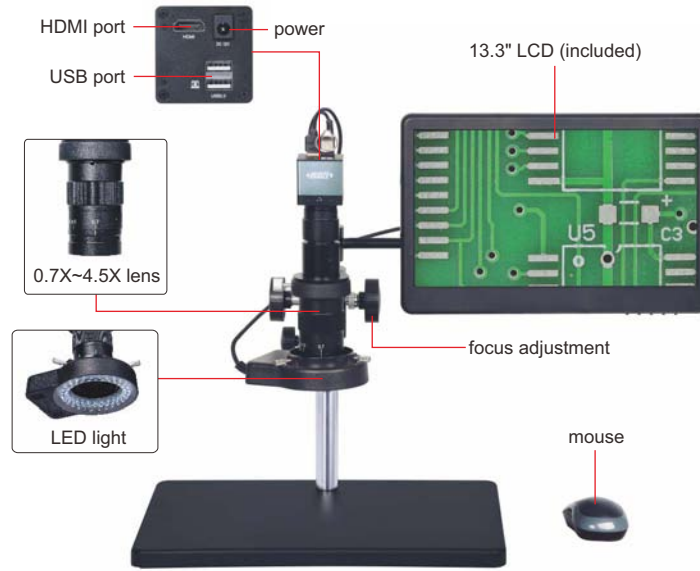

- 1080P high-definition image
- Built-in software without computer, operated by mouse
- Take pictures, save to USB flash disk
- Measurement results can be sent to Excel
- Brightness, contrast ratio, gain are adjustable

### SPECIFICATION

Magnification	12.5X~80X
Sensor	1/2.8" CMOS
Pixel	2M
Resolution	1920×1080
Frame rate	60fps
Measuring accuracy	±0.02mm
Lines	cross lines, scale lines (number, color and position of lines are adjustable)
Output	HDMI
Power supply	power adapter
Dimension (L×W×H)	380×260×350mm
Weight	4.5kg



16G USB flash disk (included)



white/black plate (included)

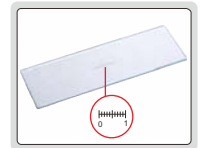

glass calibration rule (graduation 0.1mm, included)

### MAGNIFICATION AND VIEW FIELD

Auxiliary objective	Specification	Camera adapter
		0.5X (included)
0.5X (optional)	magnification	6.2~40X
	view field	47×26~7.4×4mm
1X (included)	magnification	12.5~80X
	view field	23.5×13~3.7×2mm
2X (optional)	magnification	25~160X
	view field	11.8×6.5~1.8×1mm

### STANDARD DELIVERY

Main unit	1 pc
0.5X camera adapter	1 pc
1X auxiliary objective	1 pc
White/black plate	1 pc
Glass calibration rule	1 pc
16G USB flash disk	1 pc
Mouse	1 pc
HDMI cable	1 pc
Power adapter	3 pcs

### OPTIONAL ACCESSORY

0.5X auxiliary objective	5318-OB05X
2X auxiliary objective	5318-OB2X

### MEASURING SOFTWARE (INCLUDED)

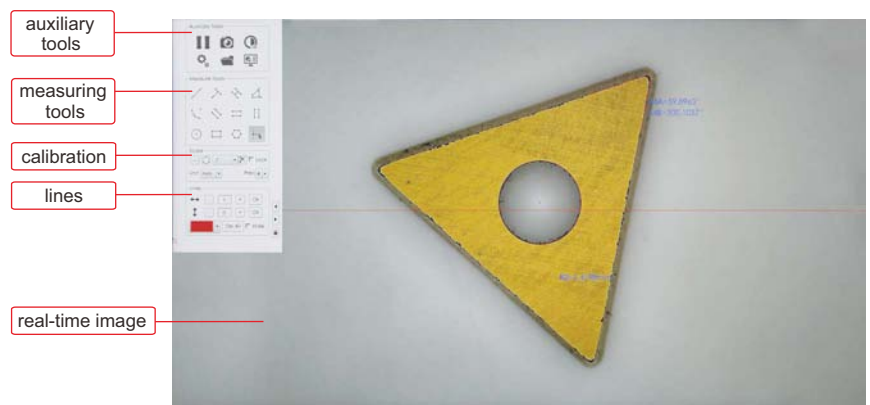

## DIGITAL MEASURING MICROSCOPES

BUILT-IN SOFTWARE  
WITHOUT COMPUTER

MEASUREMENT

TAKE  
PICTURES



0.5X camera adapter  
(included)



1X auxiliary objective  
(included)



calibration plate  
(included)



16G USB flash disk  
(included)



1X camera adapter  
(optional)



2X auxiliary objective  
(optional)

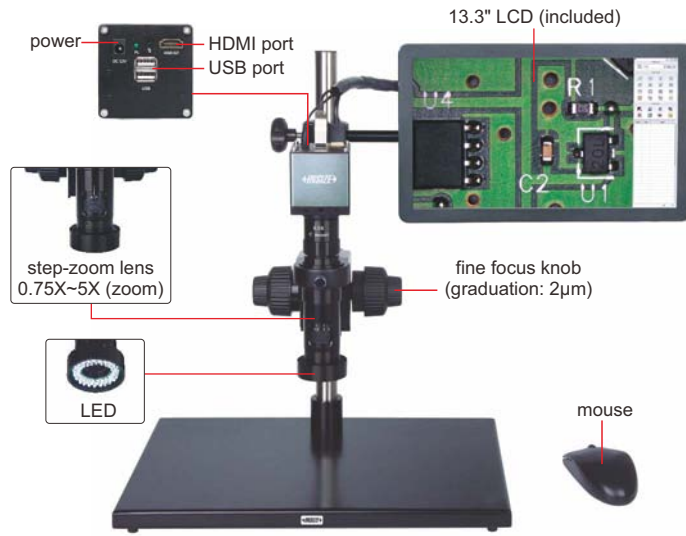

ISM-DL300 (without contour illumination)

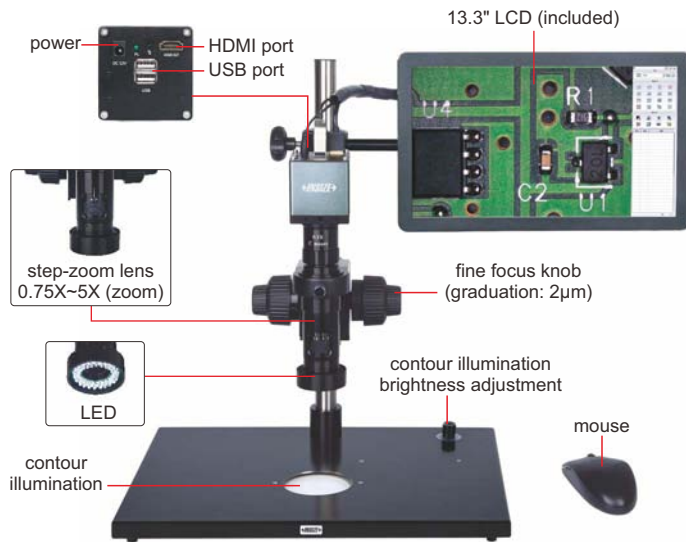

ISM-DL301 (with contour illumination)

- 1080P high-definition image
- Built-in software without computer, operated by mouse
- Take pictures, save to USB flash disk
- Measurement results can be sent to Excel
- Automatic white balance and exposure
- Brightness, contrast ratio, gain are adjustable

### SPECIFICATION

Code	ISM-DL300 (without contour illumination)	ISM-DL301 (with contour illumination)
Magnification	15X-100X	
Sensor	1/2" CMOS	
Pixel	2M	
Resolution	1920×1080	
Frame rate	60fps	
Output	HDMI	
Power supply	power adapter	
Dimension (L×W×H)	570×300×430mm	
Weight	6.5kg	

To be continued

Continued from previous page

**STANDARD DELIVERY**

Code	ISM-DL300	ISM-DL301
Main unit	1 pc	1 pc
0.5X camera adapter	1 pc	1 pc
1X auxiliary objective	1 pc	1 pc
Calibration plate	1 pc	1 pc
16G USB flash disk	1 pc	1 pc
White/black plate	1 pc	1 pc
Mouse	1 pc	1 pc
HDMI cable	1 pc	1 pc
Power adapter	2 pcs	3 pcs

**OPTIONAL ACCESSORY**

1X camera adapter	ISM-DL-CA1X
2X auxiliary objective	ISM-DL-OB2X
X-Y glass stage (travel: 100×86mm)	ISM-DL-STAGE
X-Y metal stage	ISM-DL-STAGE1
LED light	page 626~627
Auxiliary objective	page 628

**MAGNIFICATION AND MEASURING ACCURACY**

Objective magnification	Image magnification	Measuring accuracy *
0.75X	15X	±8μm
1X	20X	±7μm
1.5X	30X	±6μm
2X	40X	±6μm
2.5X	50X	±6μm
3X	60X	±5μm
3.5X	70X	±5μm
4X	80X	±4μm
4.5X	90X	±4μm
5X	100X	±4μm

\* When measuring the contour of workpieces, please use **ISM-DL301** to ensure accuracy.



**MAGNIFICATION, FOCUS DISTANCE AND VIEW FIELD**

Auxiliary objective	Specification	Camera adapter	
		0.5X (included)	1X (optional)
1X (included)	magnification	15~100X	30~200X
	focus distance	70±2mm	70±2mm
	view filed	16×11~2.5×1.6mm	7.8×5.3~1.2×0.8mm
2X (optional)	magnification	30~200X	60~400X
	focus distance	29±2mm	29±2mm
	view filed	7.8×5.3~1.2×0.8mm	3.8×2.7~0.6×0.4mm

**SOFTWARE (INCLUDED)**

- Refer to page 623 for details

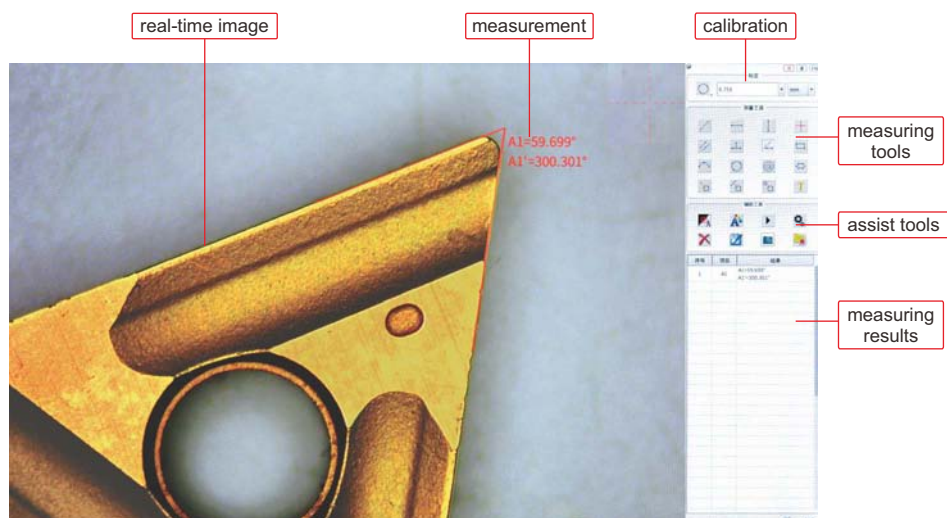

# HIGH MAGNIFICATION MEASURING MICROSCOPE CODE ISM-DL302

SOFTWARE IS INCLUDED,  
REFER TO PAGE 623 FOR DETAILS

OBSERVATION AND MEASUREMENT  
AT HIGH MAGNIFICATION

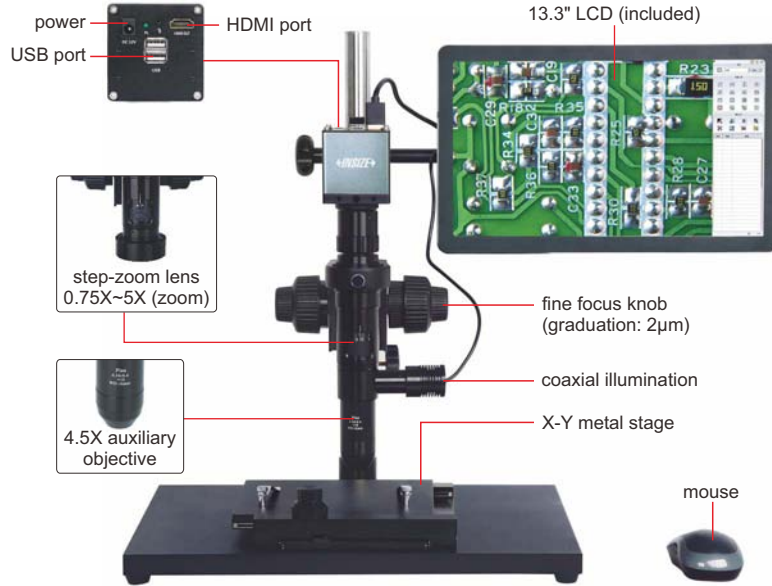

calibration plate  
(included)



step-zoom lens  
0.75X~5X (zoom)



0.5X camera adapter  
(included)



16G USB flash disk  
(included)



4.5X auxiliary  
objective

fine focus knob  
(graduation: 2 $\mu$ m)

coaxial illumination

X-Y metal stage



mouse



1X camera adapter  
(optional)

- 1080P high-definition image
- Maximum 1000X optical magnification (using camera adapter 1X, optional)
- Built-in software without computer, operated by mouse
- Solid base and column to avoid lens shaking during focusing
- Software is included, refer to page 623 for details

## SPECIFICATION

Magnification	78X~504X
Sensor	1/2" CMOS
Pixel	2M
Resolution	1920×1080
Frame rate	60fps
Output	HDMI
Power supply	power adapter
Dimension (L×W×H)	570×300×430mm
Weight	15kg

## MAGNIFICATION AND MEASURING ACCURACY

Objective magnification	Image magnification	Measuring accuracy
0.75X	78X	±5 $\mu$ m
1X	102X	±4 $\mu$ m
1.5X	153X	±4 $\mu$ m
2X	204X	±4 $\mu$ m
2.5X	255X	±4 $\mu$ m
3X	305X	±4 $\mu$ m
3.5X	356X	±4 $\mu$ m
4X	408X	±4 $\mu$ m
4.5X	458X	±4 $\mu$ m
5X	504X	±4 $\mu$ m

## SATNDARD DELIVERY

Main unit	1 pc
0.5X camera adapter	1 pc
4.5X auxiliary objective	1 pc
Calibration plate	1 pc
16G USB flash disk	1 pc
Mouse	1 pc
HDMI cable	1 pc
X-Y metal stage	1 pc

## MAGNIFICATION, FOCUS DISTANCE AND VIEW FIELD

Camera adapter	0.5X (included)	1X (optional)
Magnification	78~504X	156~1008X
Focus distance	14±2mm	14±2mm
View field	2.8×1.7~0.5×0.3mm	1.4×0.9~0.3×0.2mm

## OPTIONAL ACCESSORY

1X camera adapter	ISM-DL-CA1X
LED light	page 626~627



BUILT-IN SOFTWARE  
WITHOUT COMPUTER

TAKE  
PICTURES

MEASUREMENT

# 4K DIGITAL MEASURING MICROSCOPE CODE 5310-DL401

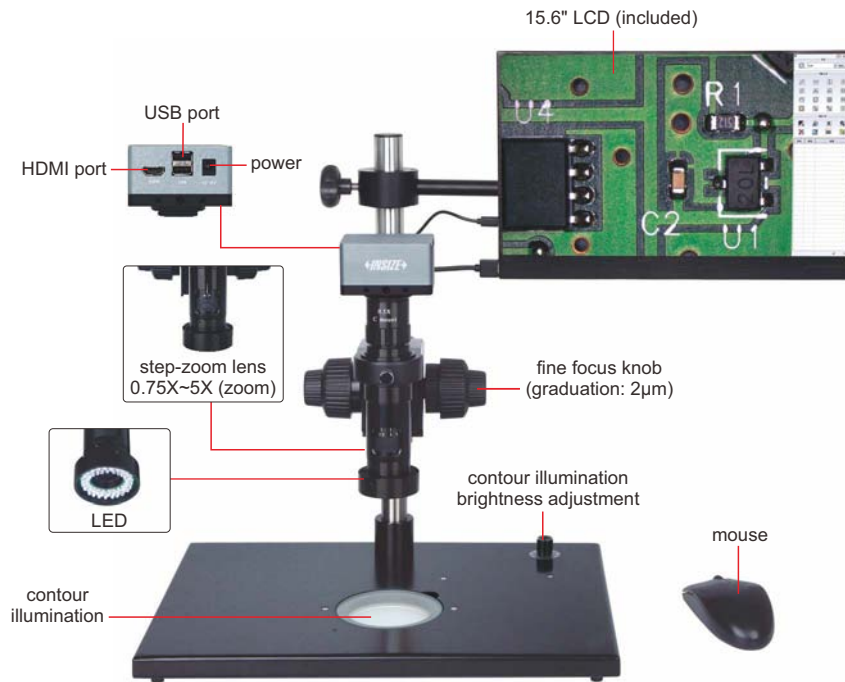

- 4K high-definition image
- Built-in software without computer, operated by mouse
- Take pictures, save to USB flash disk
- Measurement results can be sent to Excel
- Automatic white balance and exposure
- Brightness, contrast ratio, gain are adjustable

### SPECIFICATION

Magnification	17.6X~120X
Sensor	1/2.3" CMOS
Pixel	8M
Resolution	3840×2160
Frame rate	4K: 30fps, 1080P: 60fps
Output	HDMI
Power supply	power adapter
Dimension (L×W×H)	570×300×430mm
Weight	6.5kg



To be continued

Continued from previous page

**MAGNIFICATION, VIEW FIELD AND MEASURING ACCURACY**

Objective magnification	Image magnification	View field	Measuring accuracy
0.75X	17.6X	19.5×11.5mm	±5μm
1X	23.7X	14.0×8.0mm	±5μm
1.5X	36.6X	9.0×5.0mm	±5μm
2X	49X	7.0×4.0mm	±5μm
2.5X	62X	5.5×3.0mm	±4μm
3X	73X	4.5×2.5mm	±4μm
3.5X	85X	4.0×2.2mm	±4μm
4X	97X	3.5×2.0mm	±3μm
4.5X	109X	3.0×1.8mm	±3μm
5X	120X	2.7×1.5mm	±3μm

**STANDARD DELIVERY**

Main unit	1 pc
0.5X camera adapter	1 pc
1X auxiliary objective	1 pc
Calibration plate	1 pc
16G USB flash disk	1 pc
White/black plate	1 pc
Mouse	1 pc
HDMI cable	1 pc
Power adapter	3 pcs

**OPTIONAL ACCESSORY**

1X camera adapter	ISM-DL-CA1X
2X auxiliary objective	ISM-DL-OB2X
X-Y glass stage (travel: 100×86mm)	ISM-DL-STAGE
X-Y metal stage (travel: 100×86mm)	ISM-DL-STAGE1
LED light	page 626~627
Auxiliary objective	page 628

**SOFTWARE (INCLUDED)**

- Refer to page 623 for details

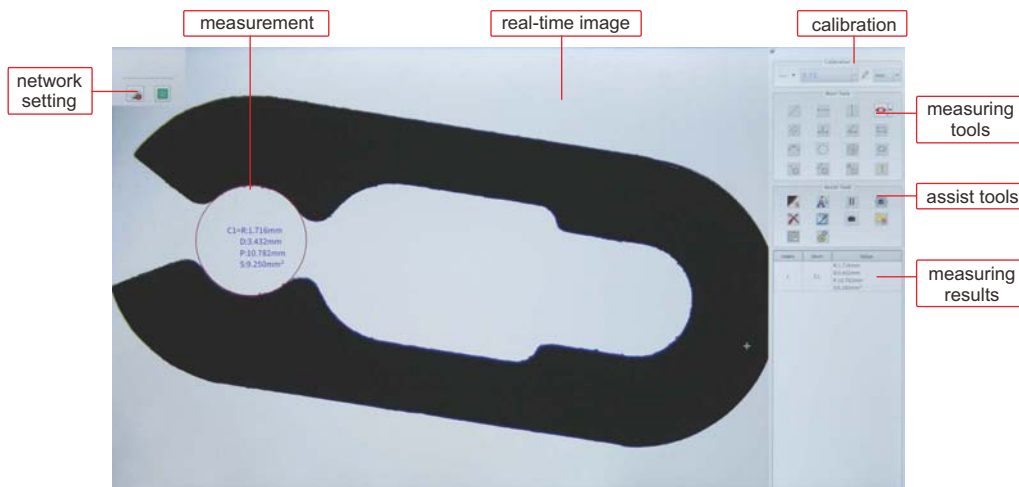

MOTORIZED FOCUS STACKING

BUILT-IN SOFTWARE WITHOUT COMPUTER

## MOTORIZED FOCUS STACKING MICROSCOPE (LARGE DEPTH OF VIEW) CODE ISM-DL520

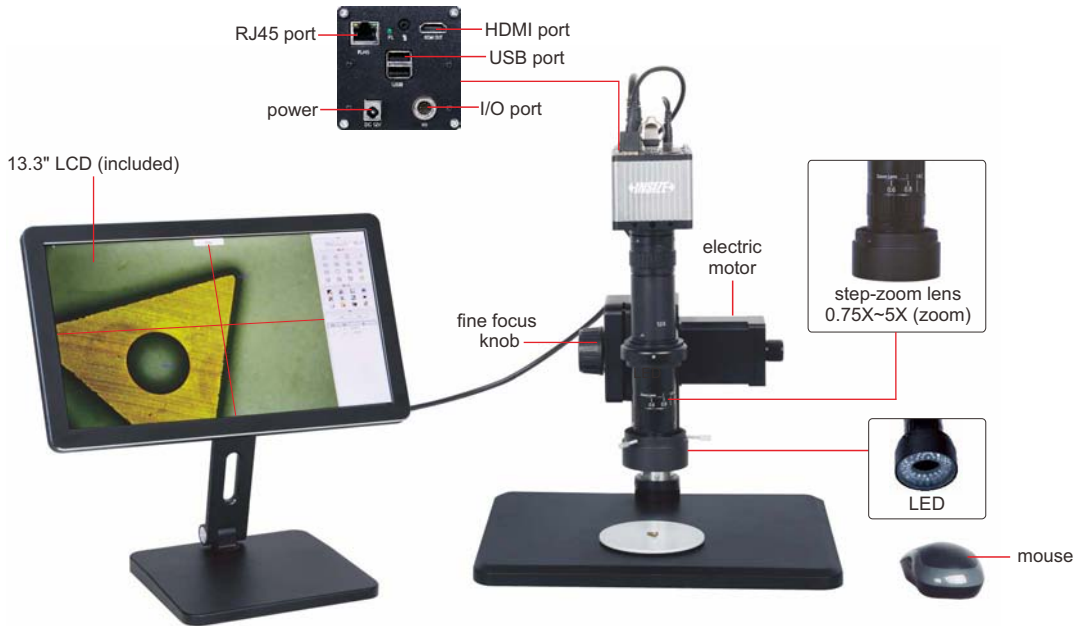

- 1080P high-definition image
- Built-in software without computer, operated by mouse
- Take pictures, save to USB flash disk
- Measurement results can be sent to Excel
- Automatic white balance and exposure
- Motorized focus stacking
- Send photos and measurement data via ethernet (TCP/IP)
- Name photos and measurement data files with serial number of workpieces read by scanner

### SPECIFICATION

Magnification	24.5X~204.5X
View field	2.8×1.6~18×10mm
Focus distance	65mm
Sensor	1/1.2" CMOS
Pixel	2M
Resolution	1920×1080
Frame rate	30fps
Output	RJ45
Power supply	power adapter
Dimension (L×W×H)	320×260×500mm
Weight	7kg

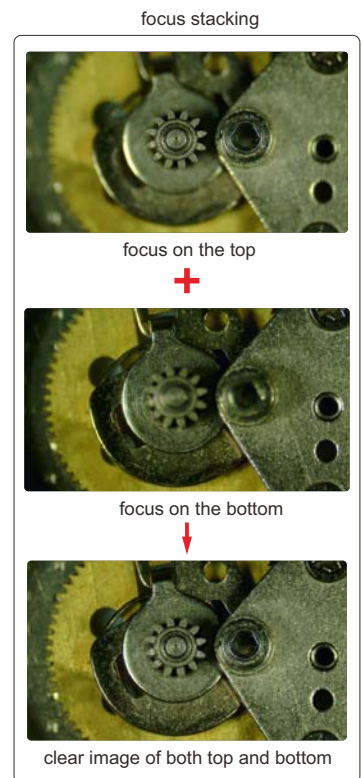

To be continued

Continued from previous page

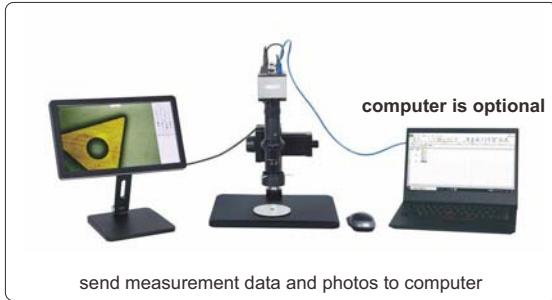

calibration plate  
(included)



16G USB flash disk  
(included)

### STANDARD DELIVERY

Main unit	1 pc
1X camera adapter	1 pc
1X auxiliary objective	1 pc
Calibration plate	1 pc
16G USB flash disk	1 pc
Mouse	1 pc
LED ring light	1 pc
White/black plate	1 pc
Power adapter	3 pcs

### MAGNIFICATION AND MEASURING ACCURACY

Objective magnification	Image magnification	Measuring accuracy
0.6X	24.5X	±8μm
0.8X	32.7X	±7μm
1X	40.9X	±6μm
1.5X	61.3X	±6μm
2X	81.8X	±6μm
2.5X	102.2X	±5μm
3X	122.7X	±5μm
3.5X	143.1X	±4μm
4X	163.6X	±4μm
4.5X	184.0X	±4μm
5X	204.5X	±4μm



### OPTIONAL ACCESSORY

X-Y metal stage (travel: 100×86mm)	ISM-DL-STAGE1
------------------------------------	---------------

### SOFTWARE (INCLUDED)

- Refer to page 623 for details

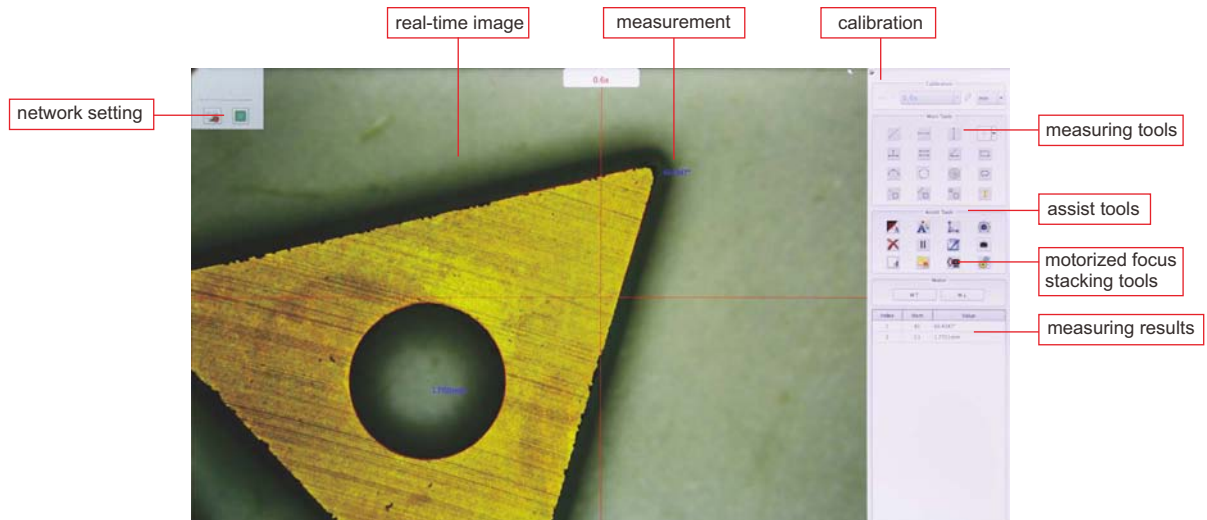

BUILT-IN SOFTWARE  
WITHOUT COMPUTER

## MANUAL FOCUS STACKING MICROSCOPE (LARGE DEPTH OF VIEW) CODE ISM-DL510

FOCUS  
STACKING

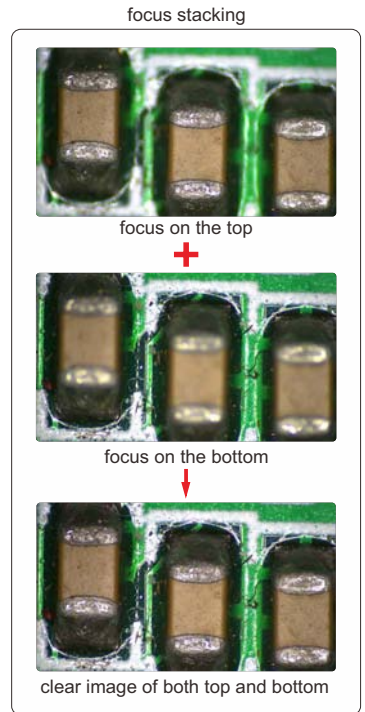
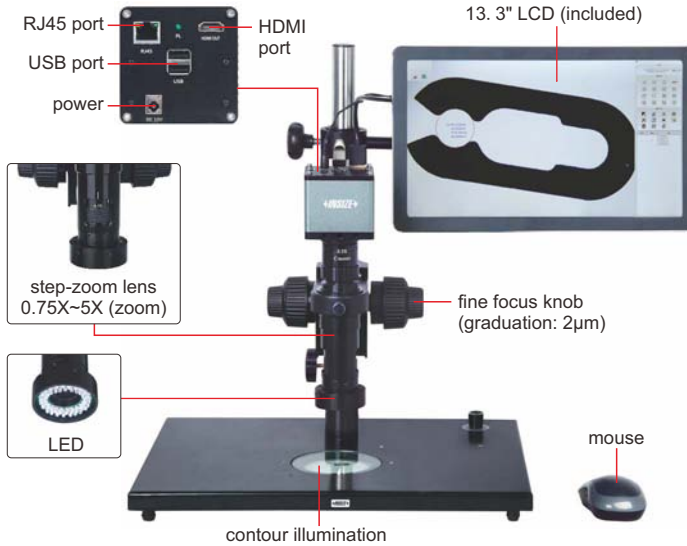

- 1080P high-definition image
- Built-in software without computer, operated by mouse
- Take pictures, save to USB flash disk
- Measurement results can be sent to Excel
- Automatic white balance and exposure
- Focus stacking
- Send photos and measurement data via ethernet (TCP/IP)
- Name photos and measurement data files with serial number of workpieces read by scanner

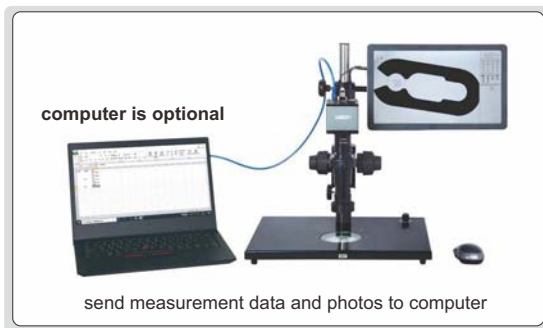

### SPECIFICATION

Magnification	15X~100X
Sensor	1/2" CMOS
Pixel	2M
Resolution	1920×1080
Frame rate	60fps
Output	HDMI
Power supply	power adapter
Dimension (L×W×H)	570×300×430mm

To be continued

Continued from previous page

**STANDARD DELIVERY**

Main unit	1 pc
0.5X camera adapter	1 pc
1X auxiliary objective	1 pc
Calibration plate	1 pc
16G USB flash disk	1 pc
White/black plate	1 pc
Mouse	1 pc
Power adapter	3 pcs

**OPTIONAL ACCESSORY**

1X camera adapter	ISM-DL-CA1X
2X auxiliary objective	ISM-DL-OB2X
X-Y glass stage (travel: 100×86mm)	ISM-DL-STAGE
Scanner and hub	7328-SCAN
LED light	page 626~627
Auxiliary objective	page 628

**MAGNIFICATION AND MEASURING ACCURACY**

Objective magnification	Image magnification	Measuring accuracy
0.75X	15X	±8μm
1X	20X	±7μm
1.5X	30X	±6μm
2X	40X	±6μm
2.5X	50X	±6μm
3X	60X	±5μm
3.5X	70X	±5μm
4X	80X	±4μm
4.5X	90X	±4μm
5X	100X	±4μm



**MAGNIFICATION, FOCUS DISTANCE AND VIEW FIELD**

Auxiliary objective	Specification	Camera adapter	
		0.5X (included)	1X (optional)
1X (included)	magnification	15~100X	30~200X
	focus distance	70±2mm	70±2mm
	view filed	16×11~2.5×1.6mm	7.8×5.3~1.2×0.8mm
2X (optional)	magnification	30~200X	60~400X
	focus distance	29±2mm	29±2mm
	view filed	7.8×5.3~1.2×0.8mm	3.8×2.7~0.6×0.4mm

**25**

**SOFTWARE (INCLUDED)**

■ Refer to page 623 for details

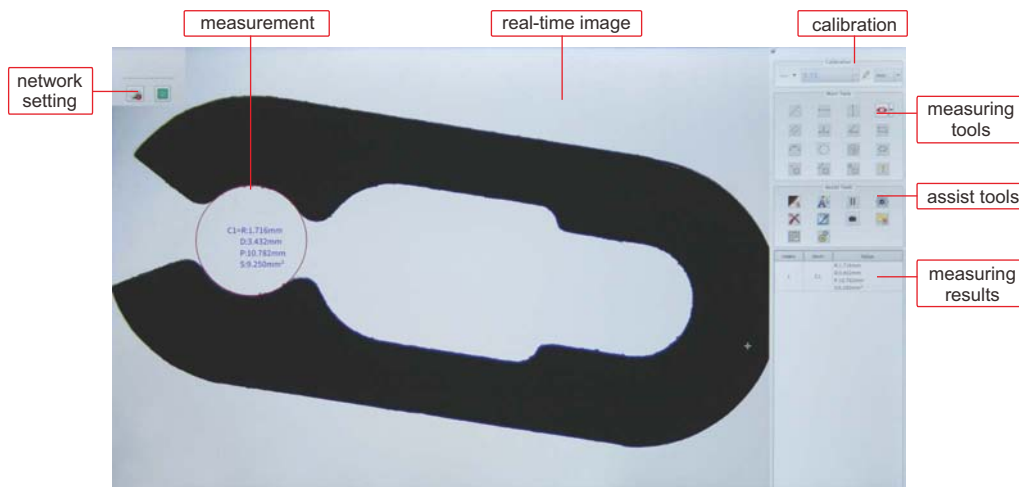



BUILT-IN SOFTWARE  
WITHOUT COMPUTER

TAKE  
PICTURES

## HORIZONTAL MICROSCOPE CODE 5316-HM810

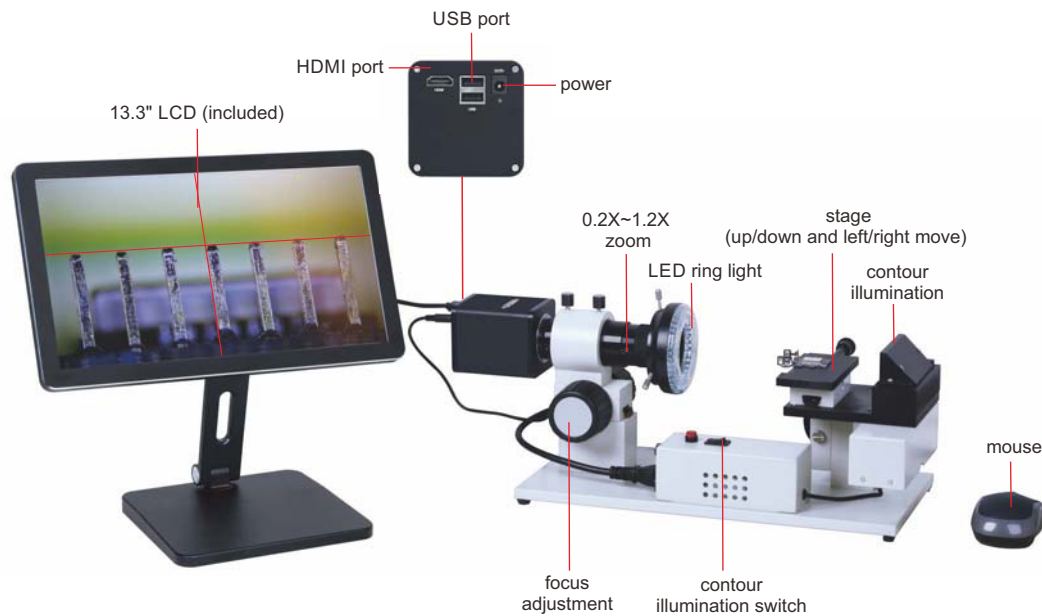

- 1080P high-definition image
- Built-in software without computer, operated by mouse
- Take pictures, save to USB flash disk
- Automatic white balance and exposure
- Brightness, contrast ratio, gain are adjustable
- Display cross hair (blue/green/red/yellow/black/brown colors)



plastic calibration rule  
(included, graduation 1mm)



16G USB flash disk  
(included)

### SPECIFICATION

Magnification	10.5X~62.5X
View field	4.5×2.5~28×12.3mm
Focus distance	115mm
Measuring accuracy	±0.02mm
Sensor	1/2.8" CMOS
Pixel	2M
Resolution	1920×1080
Frame rate	1080P: 60fps/50fps
Output	HDMI
Power supply	110/220V, 50/60Hz
Dimension (L×W×H)	500×200×200mm
Weight	7kg

### STANDARD DELIVERY

Main unit	1 pc
1X camera adapter	1 pc
1X auxiliary adapter	1 pc
Plastic calibration rule	1 pc
16G USB flash disk	1 pc
Mouse	1 pc
LED ring light	1 pc

### SOFTWARE (INCLUDED)

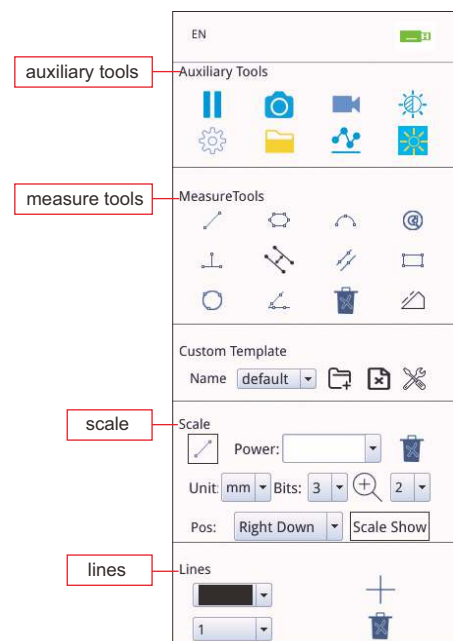

**FLEXIBLE ARM AUTO FOCUS DIGITAL MICROSCOPES**

AUTO FOCUS

TAKE PICTURES AND VIDEOS

MEASUREMENT

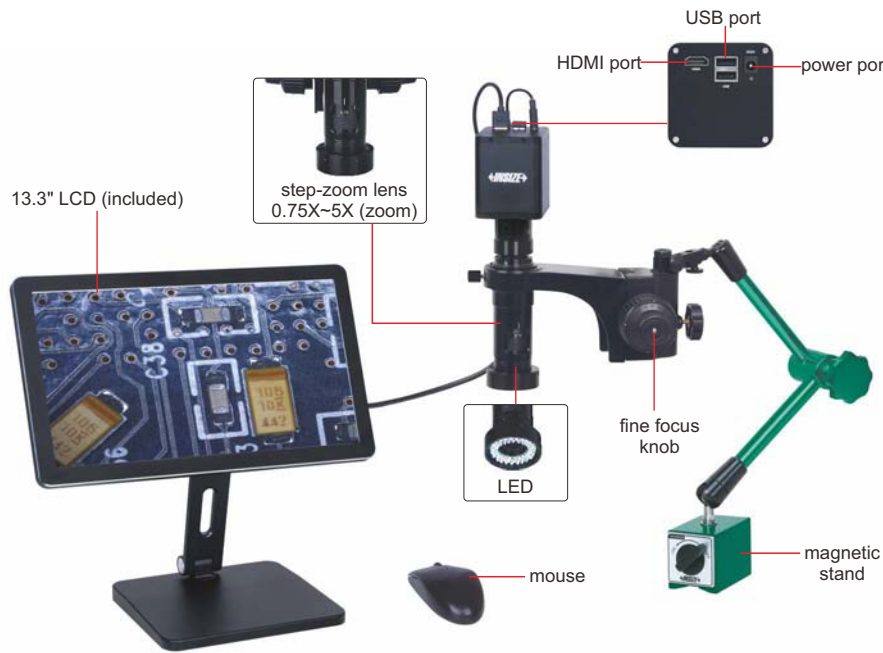

**5317-AF109**



**5317-AF110**

- 1080P high-definition image
- Auto focus camera
- Take pictures and videos, saved to USB flash disk
- Picture review, picture compare
- Automatic exposure and white balance
- Brightness, contrast ratio, gain are adjustable
- Display cross hair (blue/green/red/yellow/black/brown colors)
- Built-in software without computer, operation by mouse
- Flexible arm

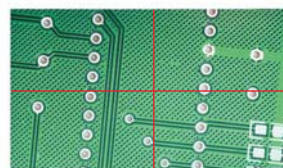

display cross hair (blue/green/red/yellow/black/brown colors)

To be continued



Continued from previous page

**SPECIFICATION**

<b>Code</b>	<b>5317-AF109</b> (with magnetic stand)	<b>5317-AF110</b> (with desktop clamp)
<b>Magnification</b>	20X~123X	
<b>Sensor</b>	1/2.8" CMOS	
<b>Pixel</b>	2M	
<b>Resolution</b>	1920×1080	
<b>Frame rate</b>	60fps	
<b>Power supply</b>	power adapter	
<b>Dimension (height)</b>	480mm	600mm
<b>Weight</b>	5.6kg	8.5kg



calibration plate  
(included)



16G USB flash disk  
(included)



0.5X camera adapter  
(included)



1X auxiliary objective  
(included)

**MAGNIFICATION, FOCUS DISTANCE AND VIEW FIELD**

Auxiliary objective	Specification	Camera adapter	
		0.5X (included)	1X (optional)
1X (included)	magnification	20~123X	40~246X
	focus distance	48~84mm	48~84mm
	view field	13×7~2.2×1mm	6.3×3.5~1.1×0.5mm
	measuring accuracy	±0.02mm	±0.02mm
2X (optional)	magnification	40~246X	80~492X
	focus distance	24~42mm	24~42mm
	view field	6.5×3.5~1.1×0.5mm	3.3×1.8~0.6×0.3mm
	measuring accuracy	±0.02mm	±0.02mm

**STANDARD DELIVERY**

Main unit	1 pc
0.5X camera adapter	1 pc
1X auxiliary objective	1 pc
Calibration plate	1 pc
16G USB flash disk	1 pc
White/black plate	1 pc
Mouse	1 pc
HDMI cable	1 pc
Power adapter	2 pcs

**AUTO FOCUS DISTANCE**

<b>Zoom objective scale</b>	0.75X	1X	1.5X	2X	2.5X
<b>Auto focus distance</b>	48~84mm	50~78mm	55~73mm	62~71mm	65~70mm
<b>Zoom objective scale</b>	3X	3.5X	4X	4.5X	5X
<b>Auto focus distance</b>	66~70mm	67~70mm	68~70mm	68~70mm	68~70mm

**OPTIONAL ACCESSORY**

1X camera adapter	ISM-DL-CA1X
2X auxiliary objective	ISM-DL-OB2X
Auxiliary objective	page 628

**MEASURING SOFTWARE (INCLUDED)**

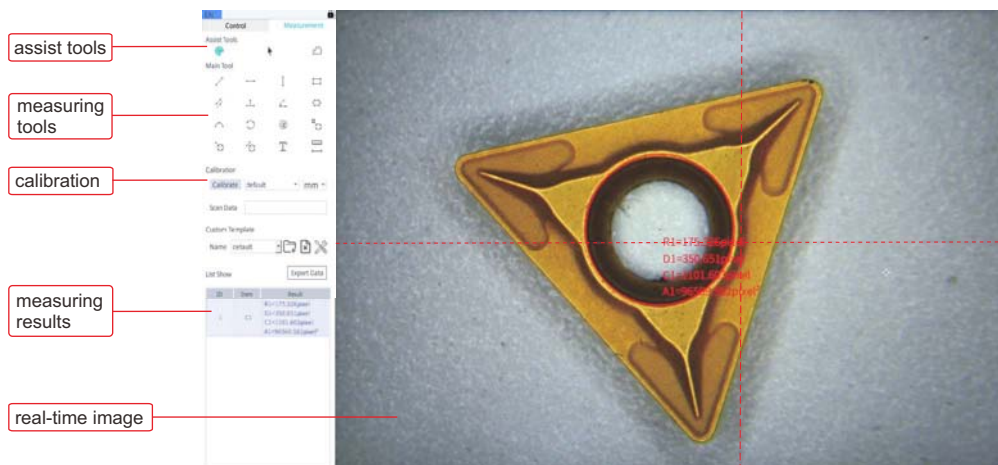

- assist tools
- measuring tools
- calibration
- measuring results
- real-time image

# DIGITAL MEASURING MICROSCOPE (BASIC TYPE) CODE 5307-ID100A

ELECTRONIC MAGNIFICATION  
FEEDBACK LENS

BUILT-IN SOFTWARE  
WITHOUT COMPUTER



- Electronic magnification feedback lens: when the objective lens magnification is changed manually, the software automatically selects the corresponding pre-calibration data and calibration is not needed
- Two methods of LED brightness adjustment, knob adjustment and software adjustment
- Built-in software without computer, operated by mouse
- Take pictures, save to USB flash disk
- Measuring results can be sent to Excel

adjustable display angle

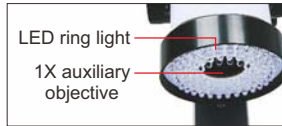

LED ring light  
1X auxiliary objective



11.6" LCD (included)

USB ports  
objective magnification adjustment (0.7X~4.5X)  
focus adjustment  
illumination brightness adjustment  
power on/off

mouse

### SPECIFICATION

Sensor	1/2" CMOS
Pixel	2M
Resolution	1920×1080
Magnification	12~77X
Focus distance	65mm
View field	3.2×1.8~20.9×11.7mm
Max. workpiece height	60mm
Frame rate	60fps
Output	USB/HDMI
Power supply	power adapter
Dimension (L×W×H)	260×320×500mm
Weight	5.2kg

### STANDARD DELIVERY

Main unit	1 pc
Calibration plate	1 pc
Power adapter	1 pc
Mouse	1 pc
16G USB flash disk	1 pc

### MAGNIFICATION AND MEASURING ACCURACY

Objective magnification	Magnification	Measuring accuracy
0.7X	12X	±9μm
1X	17X	±9μm
1.5X	26X	±8μm
2X	35X	±7μm
2.5X	43X	±7μm
3X	51X	±7μm
3.5X	60X	±6μm
4X	68X	±6μm
4.5X	77X	±5μm

### OPTIONAL ACCESSORY

0.5X auxiliary objective	5307-ID100A-OB05X
0.75X auxiliary objective	5307-ID100A-OB075X
2X auxiliary objective	5307-ID100A-OB2X

### SOFTWARE (INCLUDED)

- Refer to page 623 for details

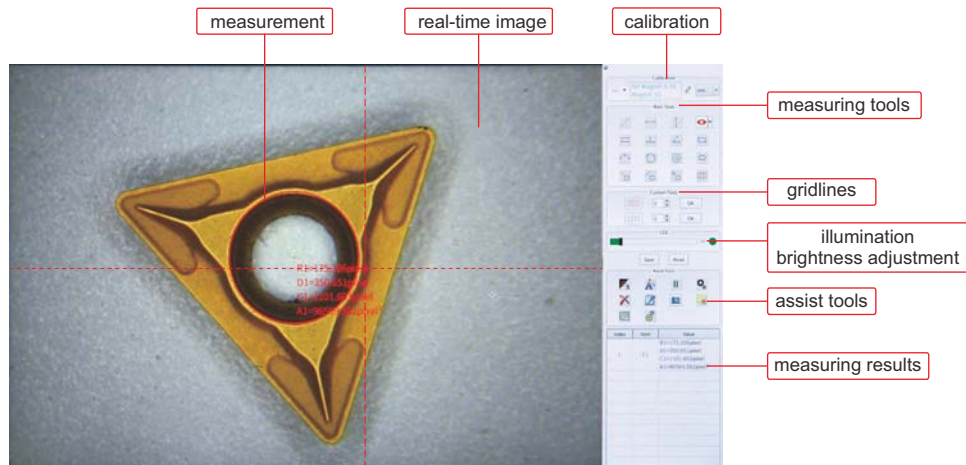

measurement

real-time image

calibration

measuring tools

gridlines

illumination brightness adjustment

assist tools

measuring results

## LARGE DEPTH OF VIEW DIGITAL MEASURING MICROSCOPE (ADVANCED TYPE) CODE 5322-ID250A

DUAL SCREEN  
OPERATION

FOCUS  
STACKING

ELECTRONIC MAGNIFICATION  
FEEDBACK LENS

PROGRAMMABLE  
SEGMENTED RING LIGHT



adjustable display angle



eight-zone LED ring light



1X auxiliary  
objective



11.6" LCD (included)

USB ports  
objective magnification  
adjustment (0.7X~4.5X)

focus adjustment

power on/off

mouse

- Electronic magnification feedback lens: when the objective lens magnification is changed manually, the software automatically selects the corresponding pre-calibration data and calibration is not needed
- Send photos and measurement data via ethernet (TCP/IP)
- Digital magnification
- Can be connected to display and computer at the same time
- Take pictures, save to USB flash disk
- Measuring results can be sent to Excel



16G USB flash disk (included)



calibration plate (included)

### SPECIFICATION

Sensor	1/2" CMOS
Pixel	2M
Resolution	1920×1080
Magnification	12~77X
Focus distance	60mm
View field	3.2×1.8~20.9×11.7mm
Max. workpiece height	53mm
Frame rate	60fps
Output	USB/HDMI/LAN
Power supply	power adapter
Dimension (L×W×H)	260×320×500mm
Weight	5.2kg

### MAGNIFICATION AND MEASURING ACCURACY

Objective magnification	Magnification	Measuring accuracy
0.7X	12X	±9μm
1X	17X	±9μm
1.5X	26X	±8μm
2X	35X	±7μm
2.5X	43X	±7μm
3X	51X	±7μm
3.5X	60X	±6μm
4X	68X	±6μm
4.5X	77X	±5μm

focus stacking



focus on the top



focus on the bottom



clear image of both top and bottom

Continued from previous page

### STANDARD DELIVERY

Main unit	1 pc
Calibration plate	1 pc
Power adapter	1 pc
Mouse	1 pc
16G USB flash disk	1 pc

### OPTIONAL ACCESSORY

0.5X auxiliary objective	5307-ID100A-OB05X
0.75X auxiliary objective	5307-ID100A-OB075X
2X auxiliary objective	5307-ID100A-OB2X

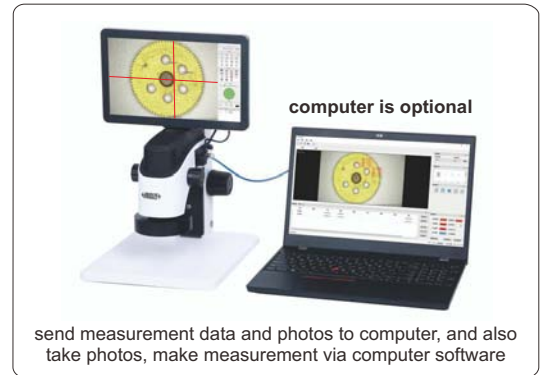

### SOFTWARE FOR LCD (INCLUDED)

Refer to page 623 for details

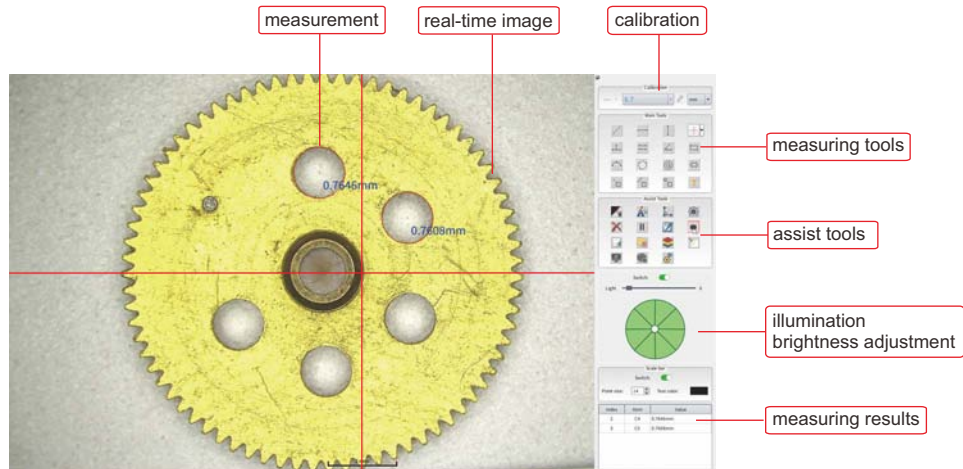

### SOFTWARE FOR COMPUTER (INCLUDED)

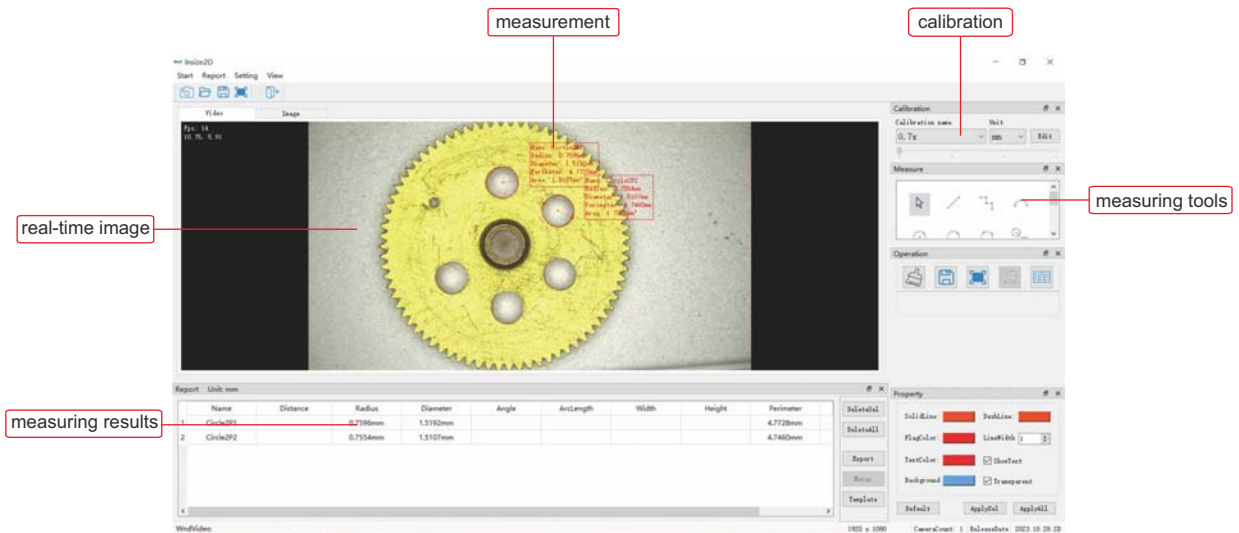

NO CALIBRATION  
AFTER ZOOM

TAKE PICTURES  
AND VIDEOS

MEASUREMENT

MOTORIZED  
ZOOM

MOTORIZED  
LIGHT CONTROL

AUTO  
FOCUS

## AUTO FOCUS DIGITAL MICROSCOPE (PROFESSIONAL TYPE) CODE 5319-AF290



16G USB flash disk  
(included)



calibration plate  
(included)

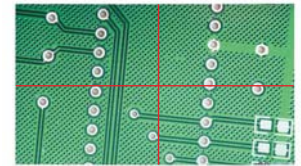

display cross hair and gridline  
(blue/green/red/yellow/  
black/white colors)

- Auto focus camera
- Take pictures and videos
- Built-in measuring software
- Automatic exposure and white balance
- Brightness, contrast ratio, gain are adjustable
- Display actual magnification
- Digital magnification
- Shortcut keyboard operation
- Display cross hair and gridline (blue/green/red/yellow/black/white colors)

### SPECIFICATION

Magnification	27.4X~163X
Sensor	1/2.8" CMOS
Pixel	2M
Measuring accuracy	±0.02mm
Resolution	1920×1080
Frame rate	50/60fps
Output	HDMI
Power supply	power adapter
Dimension (L×W×H)	600×280×390mm
Weight	6.5kg

### STANDARD DELIVERY

Main unit (with stand)	1 pc
21.5" LCD	1 pc
16G USB flash disk	1 pc
Mouse	1 pc
HDMI cable	1 pc
Calibration plate	1 pc
White/black plate	1 pc
Shortcut keyboard	1 pc
Power adapter	2 pcs

### FOCUS DISTANCE AND VIEW FIELD

Optical magnification*	0.8X	1X	2X	3X	4X	4.76X
Focus distance	88~133mm	88~133mm	98~123mm	103~115mm	108~111mm	108~111mm
View field (mm)	19.4×11~15.8×8.8	15×8.3~12.7×7.2	7.1×4~6.7×3.8	4.8×2.7~4.5×2.5	3.6×2~3.3×1.8	3×1.7~2.8×1.6

\* The optical zoom lens can be arbitrarily zoomed between 0.8X and 4.76X

#### Shortcut keyboard function

- Take picture: take a picture and save it
- Video: record a video
- Freeze: the image can be frozen
- Manual focus-: reduce the manual focus value
- Manual focus+: increase the manual focus value
- Zoom+: increase the magnification
- Zoom-: reduce the magnification
- AF/MF: switch to auto focus or manual focus
- FBL: center the camera motor
- Mirror: image horizontal flipover
- Flip: image vertical flipover
- Focus: achieve one-key focus
- Zoom 1, 2, 3, 4: save the current magnification
- Brightness+: increase the brightness of the light
- Brightness-: reduce the brightness of the light

### SOFTWARE (INCLUDED)

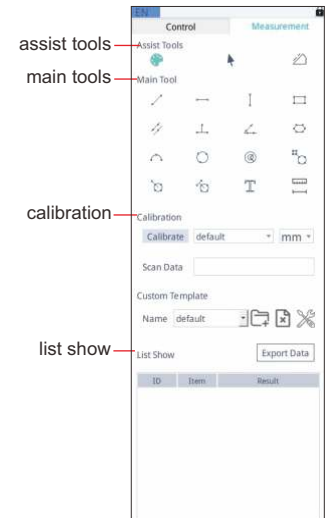
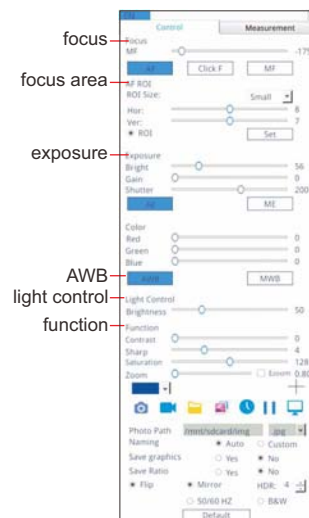

# CUTTING TOOLS MICROSCOPE CODE ISM-CT820

TAKE PICTURES  
AND VIDEOS

BUILT-IN SOFTWARE  
WITHOUT COMPUTER

SPLIT SCREEN  
DESIGN

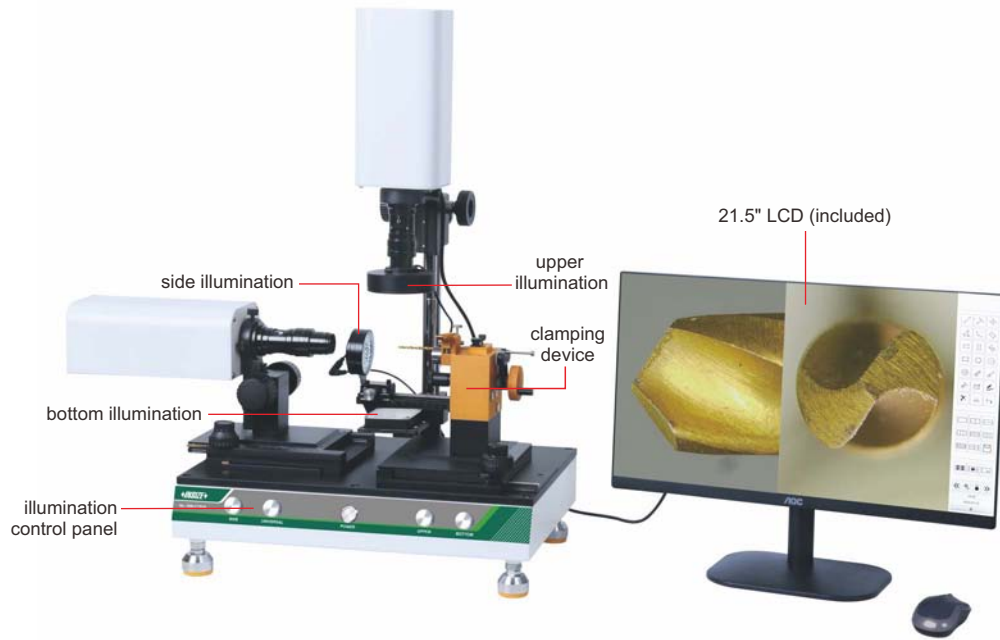

glass calibration plate (included)

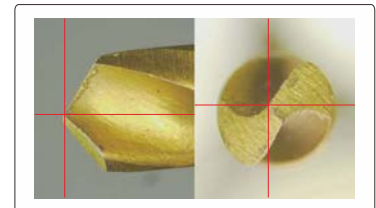

display cross hairs separately (movable)

- Split screen design, zoom in and out independently
- One mouse can operate two cameras
- Display cross hairs
- Brightness, contrast ratio, white balance are adjustable
- Basic measuring tools including point to point, point to line, line to line, angle, three-point circle, etc.

## SOFTWARE (INCLUDED)

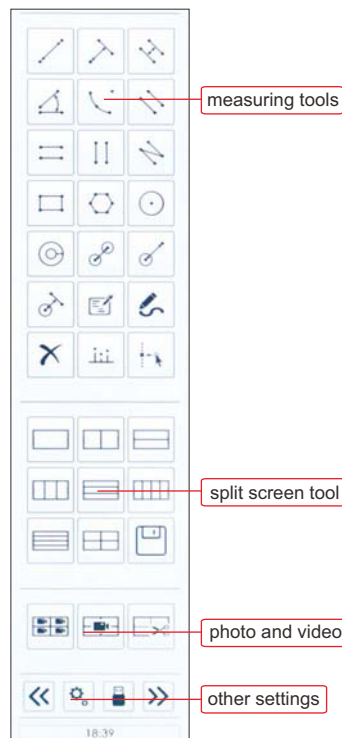

screen display

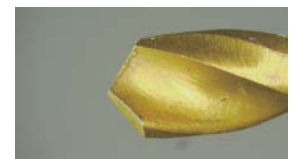

single screen display

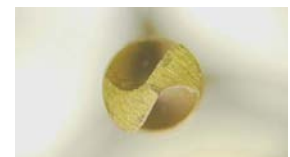

single screen display

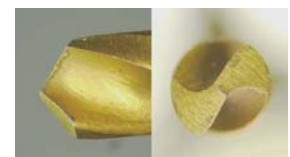

split screen display

## SPECIFICATION

Cutting tools range	Ø4~12mm, length 30-75mm
Lens	step-zoom lens
Output	HDMI
Resolution	1920×1080
Frame rate	60fps
Focus distance	85mm
View field	2×3.5~13.2×23.9mm
Magnification	20-132X
Power supply	AC 100-240V
Dimension (L×W×H)	450×300×700mm
Weight	20kg

## STANDARD DELIVERY

Main unit	1 pc
Display	1 pc
32G USB flash disk	1 pc
Mouse	1 pc
HDMI cable	1 pc
Glass calibration plate	1 pc
Anti-dust cover	1 pc

SOFTWARE CAN BE CUSTOMIZED

## MEASURING SOFTWARE OF DIGITAL MICROSCOPES



- **Included in digital microscopes (ISM-DL300, ISM-DL301, 5310-DL401, ISM-DL302, ISM-DL510, ISM-DL520, 5307-ID100A)**
- **Language:** Simplified Chinese, Traditional Chinese, English, Korean
- **Calibration:**

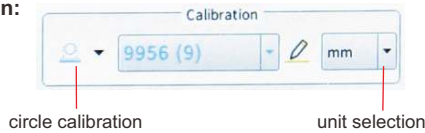

- **Edge-detection:**

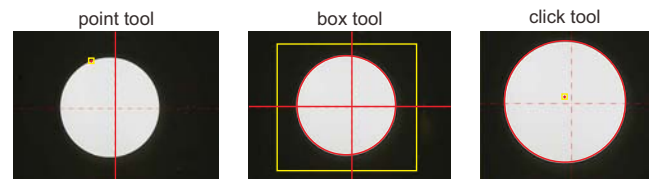

- **Measurement tools:**

- |  |   |   |
|--|---|---|
| measure length of line or distance between two points                | measure length of line or distance between two points in horizontal direction | measure length of line or distance between two points in vertical direction |
| measure angle from horizontal line                                   | measure angle from vertical line  | measure angle of two lines  |
| measure distance between two parallel lines                          | measure distance between two parallel lines                                   | measure distance between multiple parallel lines                            |
| measure distance between point and line                              | measure radius, length and angle of arc                                       | measure girth and area of polygon   |
| measure radius, diameter, girth and area of circle with three points | measure radius, diameter, girth and area concentric of circles                | measure length, width, girth and area of rectangle                          |
| measure minimum distance between point and circle                    | measure distance between point and center of circle                           | measure maximum distance between point and circle                           |
| measure minimum distance between line and circle                     | measure distance between line and center of circle                            | measure maximum distance between line and circle                            |
| measure minimum distance between two circles                         | measure center distance between two circles                                   | measure maximum distance between two circles                                |
| add text   | measure radius, diameter, girth and area of circle with two points            | cross hair and graduated cross hair   |

- **Assist tools:**

- |                                      |                                   |
|--------------------------------------|-----------------------------------|
| manual/automatic point selection     | delete images                     |
| line width and color settings        | export measurement data to U disk |
| freeze screen                        | take pictures and save            |
| camera parameter settings            | review pictures                   |
| layout settings of measurement items | system settings                   |

- **Cross hair:**

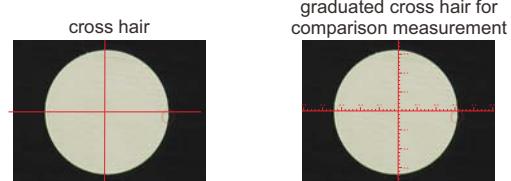

- **Grid comparison measurement:**



full-screen grid for comparison measurement, adjustable grid number

- **Output to Excel:**

1	A1	A1=59.699°
		A1=300.301°

## SMART MICROSCOPE CODE ISM-DL400

**AUTOMATICALLY LOCATE WORKPIECES  
REGARDLESS OF POSITION AND DIRECTION**

**BUILT-IN SOFTWARE  
WITHOUT COMPUTER**

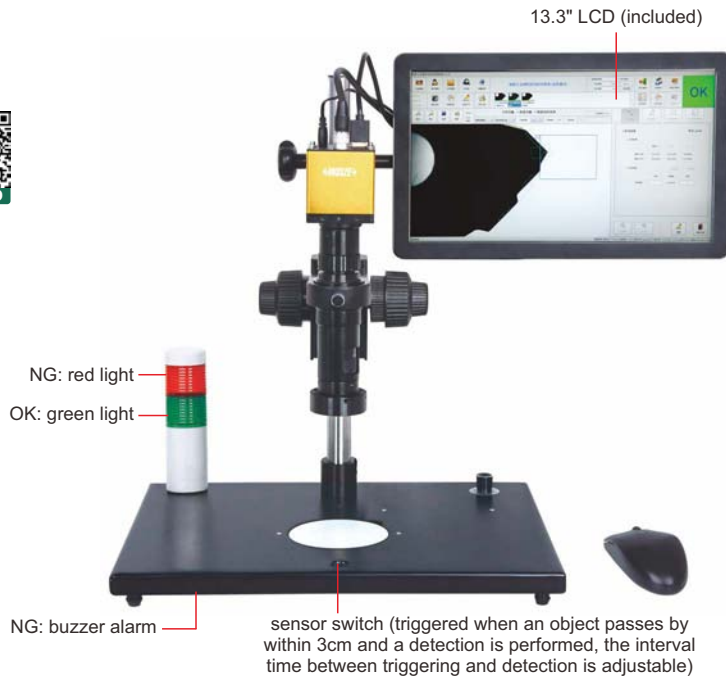

### camera function

- surface defect detection
- dimension measurement
- read barcode
- burr detection
- contour matching
- character recognition
- color detection
- read QR code
- object counting
- thread measurement

### detect different workpieces at one time

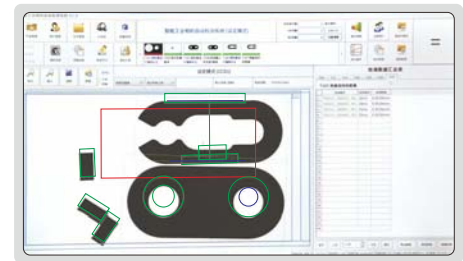

- Automatically identify different workpieces
- Automatically locate workpieces regardless of position and direction
- Built-in software, PLC control input and output interface
- Including multiple detection tools
- Automatically calculate, store the test results and sent to Excel

report showing the perform times of each tool, quantity of OK and NG, the report can be saved

report of each detection is automatically created and saved

### SPECIFICATION

Magnification	15X~100X
Resolution	1920×1080
Pixel	2M
Single pixel size	3.75×3.75µm
Frame rate	60fps
Sensor	1/2" CMOS
Chip structure	FPGA+ARM
Operation system	Linux 3.10
Power supply	power adapter
Dimension (L×W×H)	570×300×430mm
Weight	6.5kg

### STANDARD DELIVERY

Main unit	1 pc
0.5X camera adapter	1 pc
1X auxiliary objective	1 pc
Calibration plate	1 pc
16G USB flash disk	1 pc
White/black plate	1 pc
HDMI cable	1 pc
Power adapter	3 pcs

### MAGNIFICATION, FOCUS DISTANCE AND VIEW FIELD

Auxiliary objective	Specification	Camera adapter	
		0.5X (included)	1X (optional)
1X (included)	magnification	15~100X	30~200X
	focus distance	70±2mm	70±2mm
	view filed	16×11~2.5×1.6mm	7.8×5.3~1.2×0.8mm
2X (optional)	magnification	30~200X	60~400X
	focus distance	29±2mm	29±2mm
	view filed	7.8×5.3~1.2×0.8mm	3.8×2.7~0.6×0.4mm

### OPTIONAL ACCESSORY

1X camera adapter	ISM-DL-CA1X
2X auxiliary objective	ISM-DL-OB2X
LED light	page 626~627
Auxiliary objective	page 628

To be continued



Continued from previous page

■ APPLICATION EXAMPLES:

dimension measurement

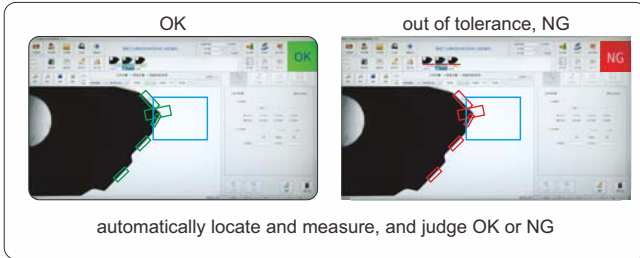

thread measurement

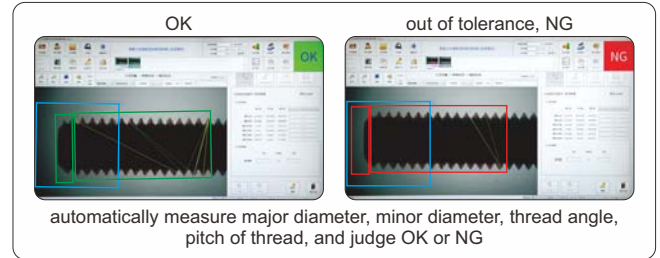

cutting tools measurement

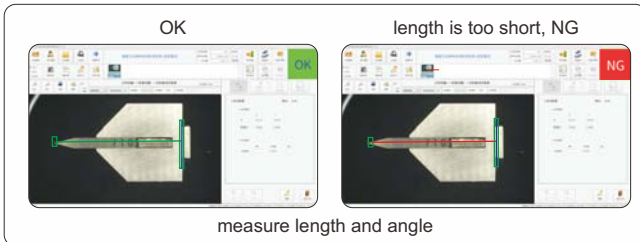

counting

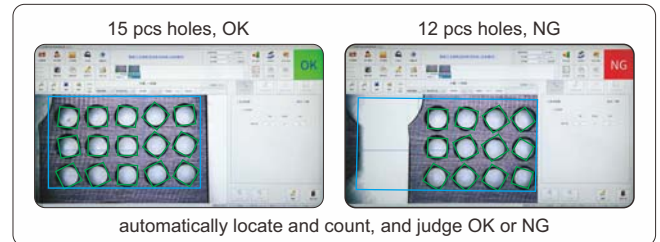

existence or absence

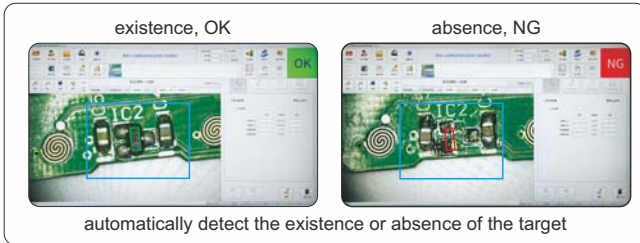

character recognition

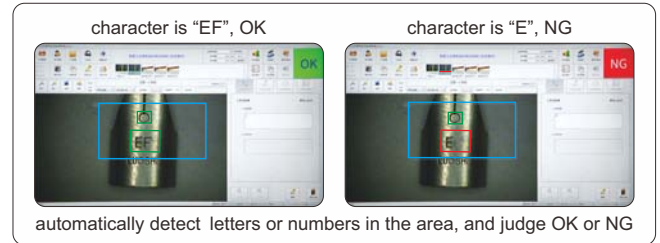

color detection



location detection

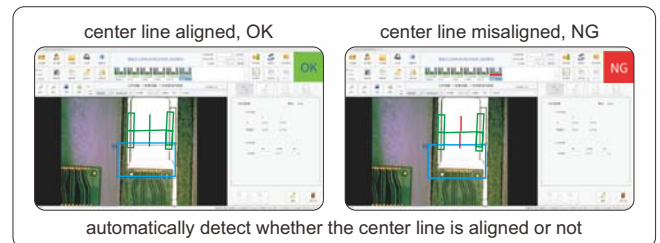

surface defect detection

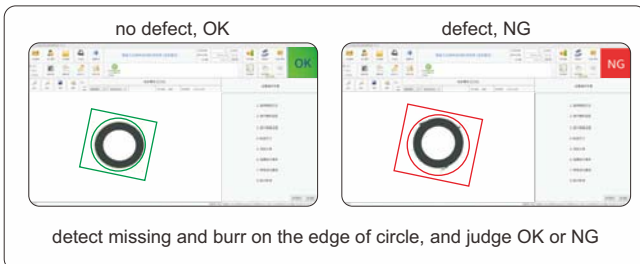

glue detection

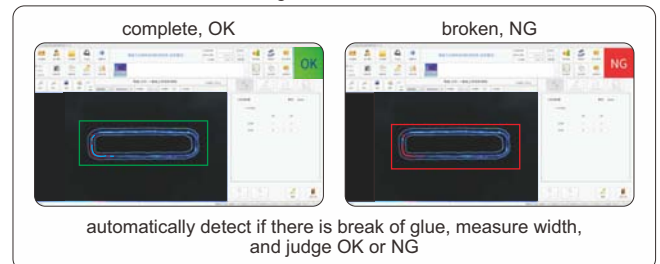

## X-Y METAL STAGE CODE ISM-DL-STAGE1

- Suitable for digital microscopes 5315-S710, 5301-D400, 5313-S407, 5310-DL401, 5303-AF103, ISM-DL300, ISM-DL301, ISM-DL302, ISM-DL520

### SPECIFICATION

X-Y travel range	100×86mm
Dimension (L×W×H)	180×180×50mm
Weight	2.3kg



## LED RING LIGHT CODE ISM-LED-9245R

- Diffuser plate is included to reduce the reflective effect on workpieces
- Suitable for digital microscopes 5303-AF103, 5310-DL401, ISM-DL300, ISM-DL301, ISM-DL302, ISM-DL400, ISM-DL510, 5315-S710

### SPECIFICATION

Light color	white
Power supply	24V
Power	5.5W
Angle	45°
Outside/inside diameter	92/52mm

RED, GREEN, BLUE, INFRARED AND UV LIGHT CAN BE CUSTOMIZED

ATTENTION: MUST BE USED WITH LIGHT BRACKET AND LIGHT CONTROLLER



## LED SQUARE LIGHT CODE ISM-LED-100L4

- Diffuser plate is included to reduce the reflective effect on workpieces
- Angle and brightness can be adjusted independently
- Suitable for digital microscopes 5303-AF103, 5310-DL401, ISM-DL300, ISM-DL301, ISM-DL302, ISM-DL400, ISM-DL510, 5315-S710

### SPECIFICATION

Light color	white
Power supply	24V
Power	10.36W
Angle	0~90°
Dimension (L×W×H)	154×154×30mm

RED, GREEN, BLUE, INFRARED AND UV LIGHT CAN BE CUSTOMIZED

ATTENTION: MUST BE USED WITH LIGHT BRACKET AND LIGHT CONTROLLER

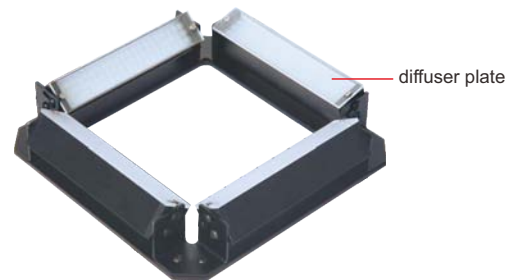

## DIGITAL LIGHT CONTROLLER CODE ISM-LED-CTRL

- 256 (0-255) steps of brightness adjustment
- With power off memory function and short circuit protection function
- Suitable for ISM-LED-100L4, ISM-LED-9245R

### SPECIFICATION

Power supply	100~240V, 50/60HZ
Output power (rated)	60W
Output voltage (rated)	24V
Dimension (L×W×H)	145×118×83mm



## BRACKET FOR LIGHTS CODE ISM-LED-BRACKET

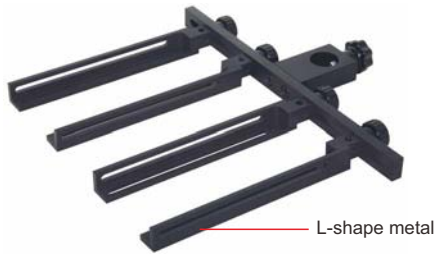

L-shape metal

- 4 pcs L-shape bars are included, multiple combinations can be realized
- Suitable for ISM-LED-100L4, ISM-LED-9245R

application



### SPECIFICATION

Size (L×W×H)	260×300×20mm
Weight	0.7kg

## DUAL HEAD LED LIGHT CODE ISM-ZS-LED

- Adjustable illumination
- For digital and stereo microscopes

### SPECIFICATION

Power	3W
Power supply	100~240V
Working	10000h
Illumination	10000lux



application



## LED AUXILIARY LIGHT CODE ISM-DL-LED

- Suitable for digital microscopes 5303-AF103, 5310-DL401, ISM-DL300, ISM-DL301, ISM-DL302, ISM-DL400, ISM-DL510, 5315-S710

### SPECIFICATION

Power	8W
Diameter of mounting hole	Ø25mm
Power supply	10~12V, 0~300mA



brightness adjustment knob



illumination direction and brightness are adjustable

## COAXIAL LIGHT CODE ISM-DL-COAXIAL

- Suitable for digital microscopes 5303-AF103, 5310-DL401, ISM-DL300, ISM-DL301, ISM-DL302, ISM-DL400, ISM-DL510, 5315-S710

### SPECIFICATION

Power	1W
Power supply	0~3.4V, 0~400mA



brightness adjustment knob



for smooth surfaces and small holes, brightness is adjustable

## AUXILIARY OBJECTIVES



**0.3X auxiliary objective\***  
ISM-DL-OB03X



**0.5X auxiliary objective\***  
ISM-DL-OB05X



**0.75X auxiliary objective\***  
ISM-DL-OB075X



**1X auxiliary objective**  
ISM-DL-OB1X



**1.5X auxiliary objective**  
ISM-DL-OB1D5X



**2X auxiliary objective**  
ISM-DL-OB2X

- Suitable for digital microscopes 5303-AF103, 5310-DL401, ISM-DL300, ISM-DL301, ISM-DL302, ISM-DL400, ISM-DL510, 5315-S710, 5317-AF109, 5317-AF110

### MAGNIFICATION, FOCUS DISTANCE AND VIEW FIELD (5303-AF103)

Auxiliary objective	Specification	Camera adapter	
		0.5X (included)	1X (optional)
0.3X (optional)	magnification	6~37X	12~74X
	focus distance	120~310mm	120~310mm
	view field	52×30~8×5mm	26×15~4×2.5mm
0.5X (optional)	magnification	10~61X	20~123X
	focus distance	78~230mm	78~230mm
	view field	37×20~5×3mm	18×10~2.5×1.5mm
0.75X (optional)	magnification	15~92X	30~184X
	focus distance	60~125mm	60~125mm
	view field	21×13~3.4×2mm	10×6.5~1.7×1mm
1X (included)	magnification	20~123X	40~246X
	focus distance	48~84mm	48~84mm
	view field	15×8~2.5×1.5mm	7.5×4~1.3×0.7mm
1.5X (optional)	magnification	30~184X	60~368X
	focus distance	36~63mm	36~63mm
	view field	10×6~1.7×1mm	5×3~0.9×0.5mm
2X (optional)	magnification	40~246X	80~492X
	focus distance	24~42mm	24~42mm
	view field	7.5×4~1.3×0.7mm	3.8×2~0.7×0.4mm

### MAGNIFICATION, FOCUS DISTANCE AND VIEW FIELD (ISM-DL300, ISM-DL301, ISM-DL510)

Auxiliary objective	Specification	Camera adapter	
		0.5X (included)	1X (optional)
0.3X (optional)	magnification	5~34X	10~68X
	focus distance	287±2mm	287±2mm
	view field	42×26~6.5×4.5mm	21×13~3.3×2.3mm
0.5X (optional)	magnification	9~56X	18~112X
	focus distance	166±2mm	166±2mm
	view field	25.6×16.8~5×3.5mm	12.8×8.4~2×1.3mm
0.75X (optional)	magnification	13~84X	26~168X
	focus distance	105±2mm	105±2mm
	view field	17×10.5~2.6×1.7mm	8.5×5.3~1.3×0.9mm
1X (included)	magnification	15~100X	30~200X
	focus distance	70±2mm	70±2mm
	view field	16×11~2.5×1.6mm	7.8×5.3~1.2×0.8mm
1.5X (optional)	magnification	26~168X	52~336X
	focus distance	42±2mm	42±2mm
	view field	8.5×5.2~1.3×0.9mm	4.3×2.6~0.7×0.5mm
2X (optional)	magnification	30~200X	60~400X
	focus distance	29±2mm	29±2mm
	view field	7.8×5.3~1.2×0.8mm	3.8×2.7~0.6×0.4mm

\*For auxiliary objectives 0.3X, 0.5X, 0.75X, use contour illumination of ISM-DL301, ISM-DL400, ISM-DL510, 5310-DL401 or LED light

**MEASUREMENT**

**TAKE PICTURES AND VIDEOS**

**DIGITAL MICROSCOPES**



**5309-DM50**

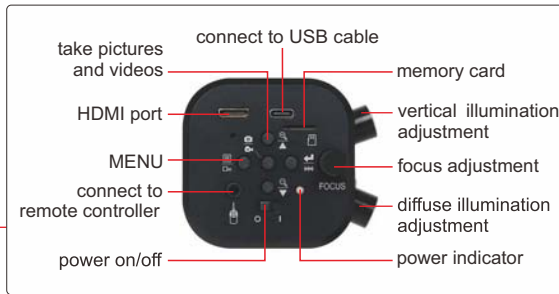

**5309-DM51**

- Independent control of vertical illumination and diffuse illumination
- Back focus adjustment extends working distance
- Take pictures and videos, save to memory card



**SPECIFICATION**

Code	5309-DM50	5309-DM51
Arm type	straight	universal
Sensor	1/2.8" CMOS	
Pixel	2M	
Resolution	1920×1080	
Exposure	real-time auto, single auto, manual adjustment	
White balance	real-time auto, single auto, manual RGB adjustment	
Record format	pictures: JPG videos: MOV	
Record media	memory card	
Working distance	45~169mm	42~195mm
Magnification	9~41X	7.6~49.4X
View field	7.6×4~38.5×21.7mm	7×4~45×25mm
Power supply	DC12V 3A	

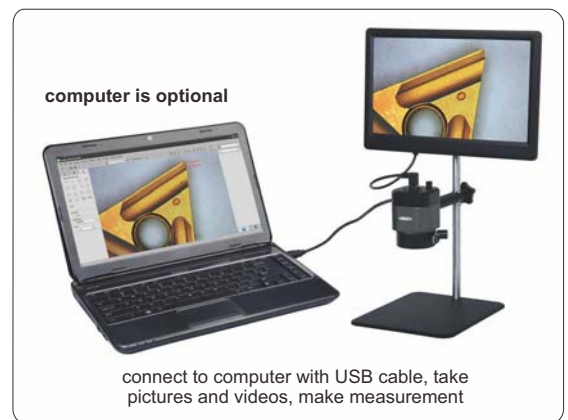

**USE COMPUTERS, OPTIONAL**

Image magnification	View field	Measuring accuracy
9.0X	38.5×21.7mm	±0.02mm
13.0X	26.6×15.0mm	±0.02mm
17.0X	20.5×11.7mm	±0.02mm
22.0X	16.0×9.0mm	±0.02mm
28.5X	11.9×6.3mm	±0.02mm
34.0X	9.8×5.5mm	±0.01mm
41.0X	7.6×4.1mm	±0.01mm

**STANDARD DELIVERY**

Main unit	1 pc
Memory card and holder	1 pc
Plastic calibration rule (graduation 1mm)	1 pc
White/black plate	1 pc
Remote controller	1 pc
USB cable	1 pc
Measuring software	1 pc
Power adapter	1 pc

To be continued

Continued from previous page



remote controller  
(included)



white/black plate  
(included)



plastic calibration rule  
(graduation 1mm, included)

## SOFTWARE FOR COMPUTER

- **Language:** Chinese (Simplified), English, French, Chinese (Traditional), Portuguese, Korean, Japanese
- **Operation system:** Windows 7/8/8.1/10 (64bit)

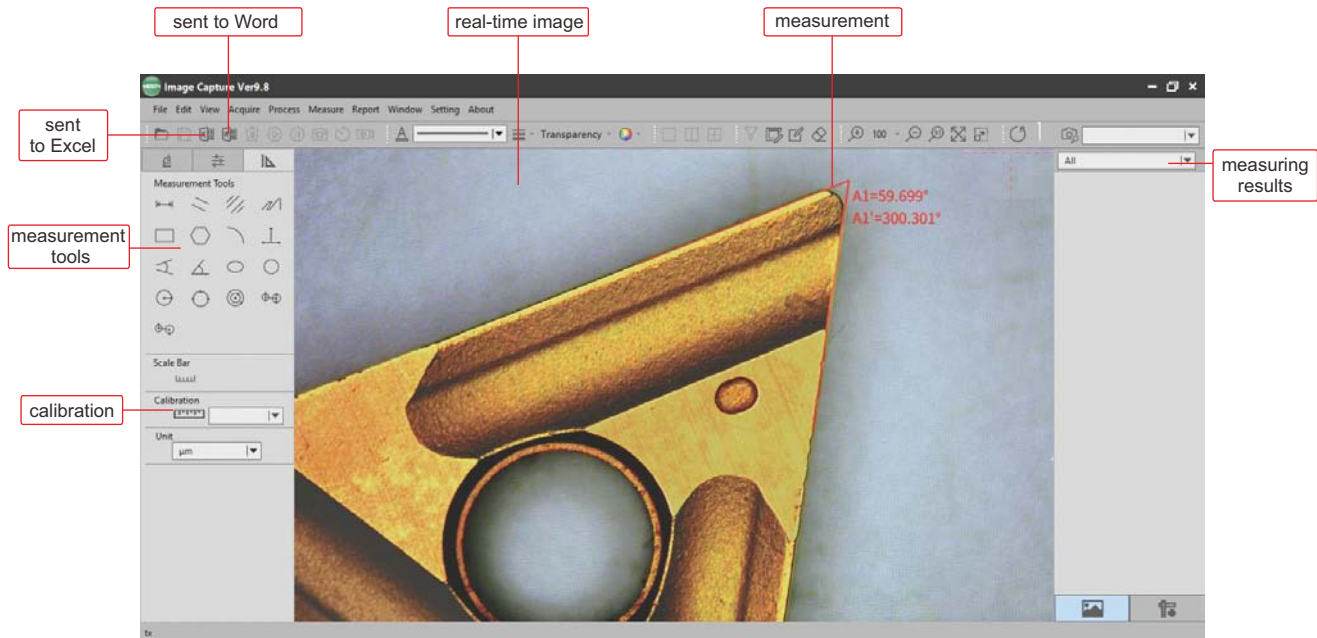

### Measurement tools:

- |  |                                     |  |                                       |
|--|-------------------------------------|--|---------------------------------------|
| straight line distance measurement     | parallel lines distance measurement | centre distance between parallel lines measurement | polyline line measurement             |
| rectangular measurement                | polygon measurement                 | arc measurement                                    | three-vertical-line measurement       |
| four-point perspective measurement     | angle measurement                   | ellipse measurement                                | round measurement                     |
| circle measurement by radius           | circle measurement by 3-point       | torus measurement                                  | center distance measurement by radius |
| center distance measurement by 3-point |                                     |  |                                       |

### Data is sent to Word or Excel:

sent to word

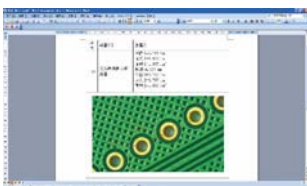

sent to excel

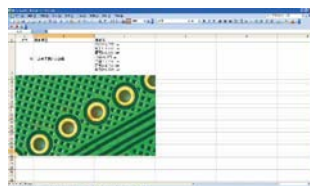

TAKE PICTURES AND VIDEOS

BUILT-IN LITHIUM BATTERY

# MINI DIGITAL MICROSCOPE (ECONOMIC TYPE) CODE 5311-M710

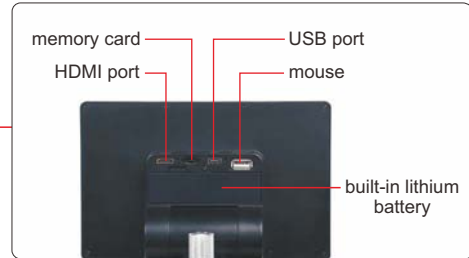

8G memory card and holder (included)



infrared ray remote controller (included)

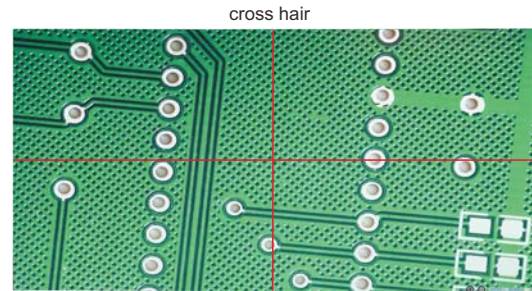

cross hair

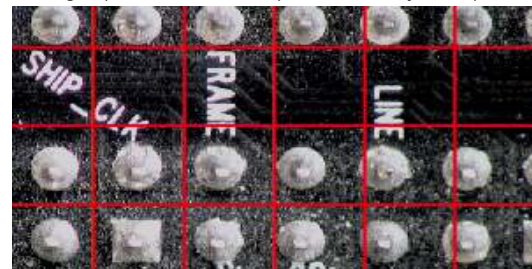

grid (color, line width and positions are adjustable)

## SPECIFICATION

Display resolution	1024×600
Sensor	1/3" CMOS
Sensor resolution	1280×960
Single pixel size	2μm×2μm
Frame rate	60fps/30fps
Magnification	1X~16X
White balance	auto/manual (10 levels RGB)/calibration
Exposure control	AE lock/exposure compensation (10 levels)
Image control	contrast/saturation/sharpness
Record media	memory card
Output	HDMI
Power supply	built-in lithium battery/power adapter
Dimension (L×W×H)	174×200×350mm
Weight	1.5kg

## STANDARD DELIVERY

Main unit	1 pc
USB cable	1 pc
HDMI cable	1 pc
IR remote controller	1 pc
8G memory card and holder	1 pc
Plastic calibration rule	1 pc
Power adapter	1 pc

To be continued

Continued from previous page

■ **Screen freezing:**

full screen

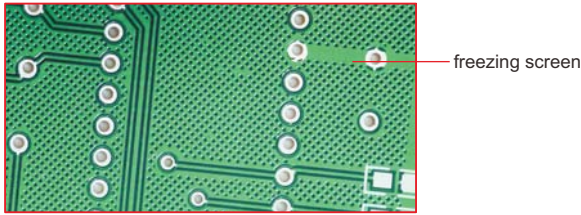

up-down split screen

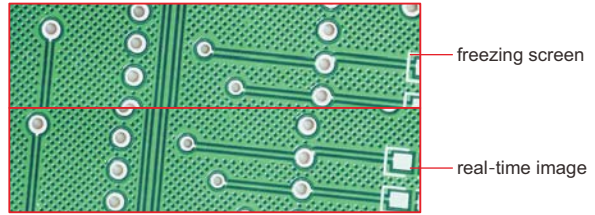

left-right split screen

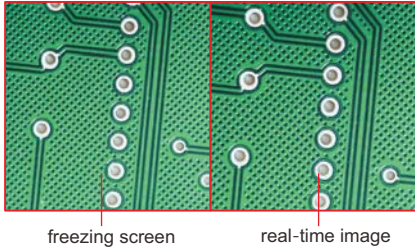

1/4 split screen

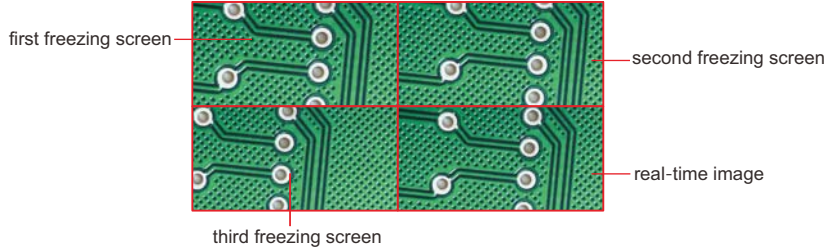

**SOFTWARE FOR COMPUTER (included)**

- **Language:** Chinese (Simplified), English
- **Operation system:** Windows 7/8/8.1/10 (64bit)
- **Port:** USB2.0 or above
- **Measuring accuracy:** 0.02mm

- |                              |                                      |                                 |   |
|------------------------------|--------------------------------------|---------------------------------|---|
| point counting               | straight line length                 | continuous line length          | area of a rectangle                           |
| area of a polygon            | distance between 2 lines             | distance between parallel lines | distance between line and first parallel line |
| point-line distance          | cross line                           | double cross line               | angle   |
| arc                          | radius of a circle                   | radius of a 2-point circle      | radius of a 3-point circle                    |
| center distance of 2 circles | center distance of concentric circle |                                 |   |

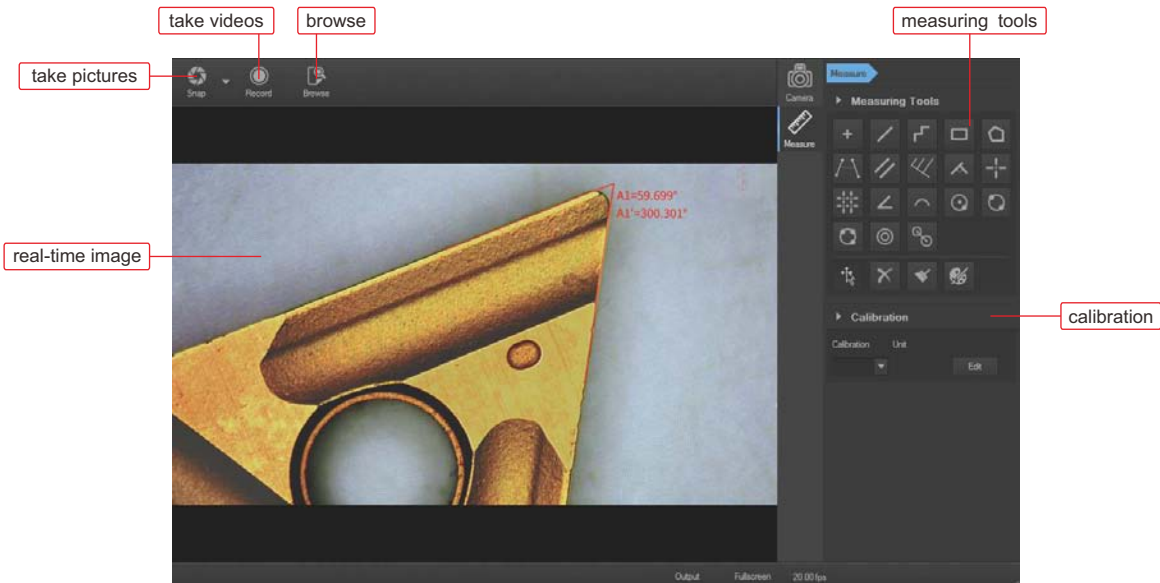



## DIGITAL MEASURING MICROSCOPES

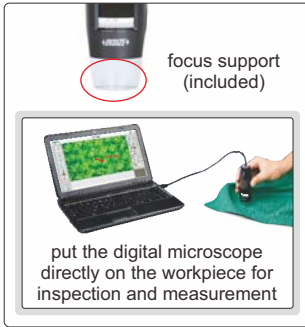

- Can take pictures and videos
- Supplied with software
- Calibration rules (graduation 0.1 and 1mm) are included
- With focus support

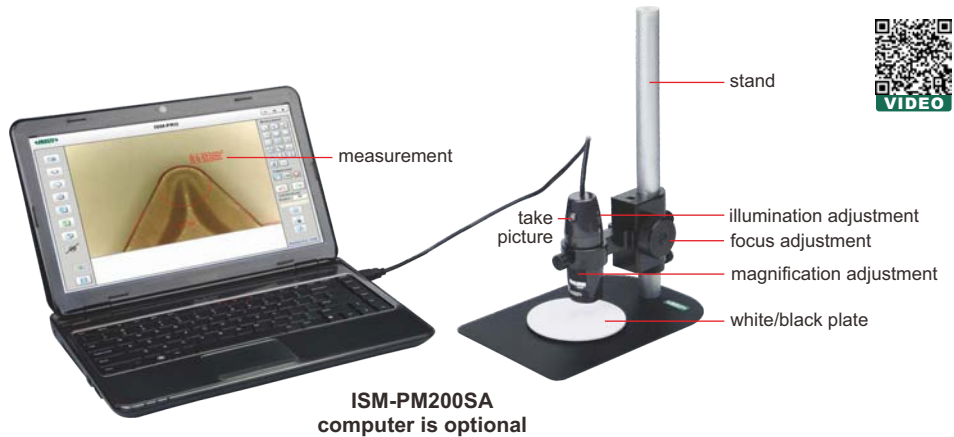

### SPECIFICATION

Code	ISM-PM200SA	ISM-PM200SB
Magnification	10X~200X	10X~200X
Stand	standard	universal
Pixel	2M (resolution: 1600×1200)	
Illumination	built-in adjustable LED	
Power supply	USB 2.0 cable (voltage required: 5±0.1V)	

### OPTIONAL ACCESSORY

Green filter	ISM-PM-GREEN
Yellow filter	ISM-PM-YELLOW
Blue filter	ISM-PM-BLUE



software flash disk (included)

### SOFTWARE

- Language:** English, Japanese, Korean, German, Turkey, Portuguese, Chinese
- Operation system:** Windows 7/8/XP/Vista
- Measuring tools:**

- |   |  |
|---|--|
| measure length of line or distance between two points | measure radius, length and angle of arc  |
| measure area of rectangle                             | add number with circle                   |
| measure distance between two circles                  | measure length of continuous line        |
| measure distance between two parallel lines           | measure angle with three points          |
| measure angle with two lines                          | measure radius, girth and area of circle |
| measure distance between point and line               | add text                                 |

### Edge detection measurement tools:

- detect two parallel lines automatically and calculate distance
- detect circle automatically, and calculate radius, girth and area
- detect arc automatically, and calculate radius, angle and arc length
- detect two lines automatically, and calculate angle
- detect line automatically, and calculate length

### universal stand (included in ISM-PM200SB)

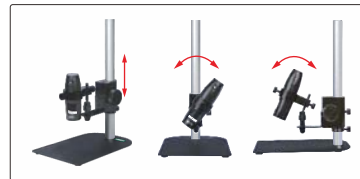

### filter (optional)



### MAGNIFICATION, FOCUS DISTANCE, VIEW FIELD AND ACCURACY

Magnification	Focus distance	View field	Accuracy
50X	21mm	8.1×6.4mm	30µm
100X	13mm	3.9×3.1mm	15µm
150X	16mm	2.6×2.1mm	10µm
200X	19mm	1.8×1.5mm	8µm

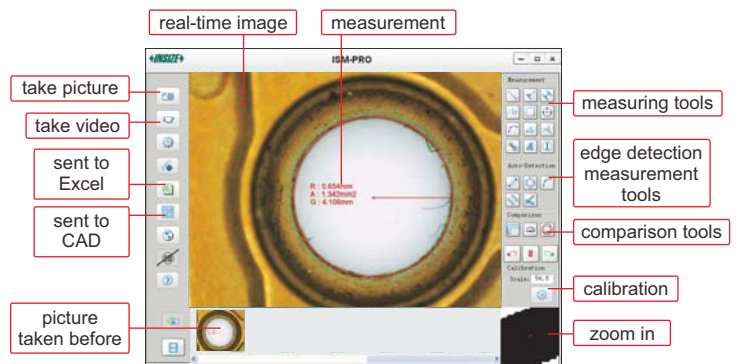

### Comparison tools:

- Create line, angle or circle with desired size, to compare with workpieces

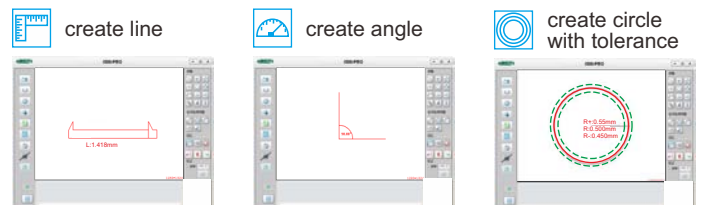

### Data is sent to CAD or Excel:



## WIFI DIGITAL MEASURING MICROSCOPE CODE ISM-WF200



- Maximum working distance is 5m under WIFI mode
- Can be connected to multiple iPads, Android devices or computers together under WIFI mode
- Take pictures and videos
- Supplied with software



software flash disk (included)

stand (code ISM-PM-STAND, optional)



plastic calibration rule (graduation 1mm, included)

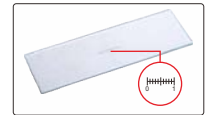

glass calibration rule (graduation 0.1mm, included)

### SPECIFICATION

Magnification	10X~200X
Pixel	1.3M (resolution: 1280×1024)
Illumination	built-in adjustable LED
Power supply	built-in rechargeable battery



connected to iPad by WIFI

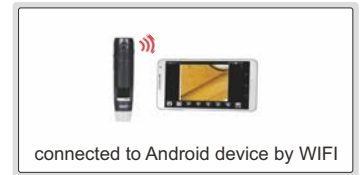

connected to Android device by WIFI

### STANDARD DELIVERY

Microscope	1 pc
Focus support ring for 80X/150X	1 pc
Focus support ring for 60X/200X	1 pc
Glass calibration rule (graduation 0.1mm)	1 pc
Plastic calibration rule (graduation 1mm)	1 pc
Software and USB cable	1 pc
AC/DC adapter	1 pc



connected to computer by WIFI

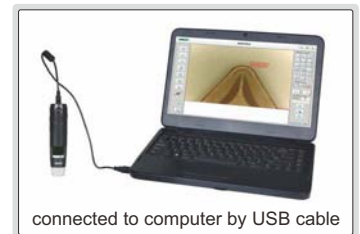

connected to computer by USB cable

### OPTIONAL ACCESSORY

Stand	ISM-PM-STAND
Green filter	ISM-PM-GREEN
Yellow filter	ISM-PM-YELLOW
Blue filter	ISM-PM-BLUE

### MAGNIFICATION, FOCUS DISTANCE, VIEW FIELD AND ACCURACY

Magnification	Focus distance	View field	Accuracy
50X	21mm	8.1×6.4mm	30μm
100X	13mm	3.9×3.1mm	15μm
150X	16mm	2.6×2.1mm	10μm
200X	19mm	1.8×1.5mm	8μm

### 1 Software ISM-PAD (for iPad by WIFI)

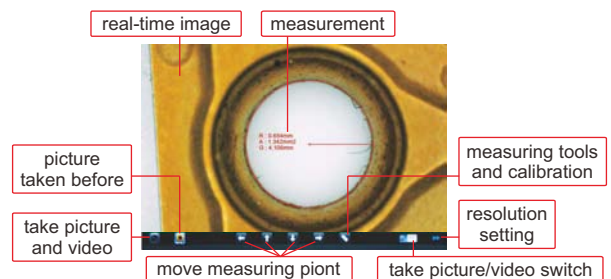

- measure length of line or distance between two points
- measure radius, girth and area of circle with three points
- measure angle



To be continued







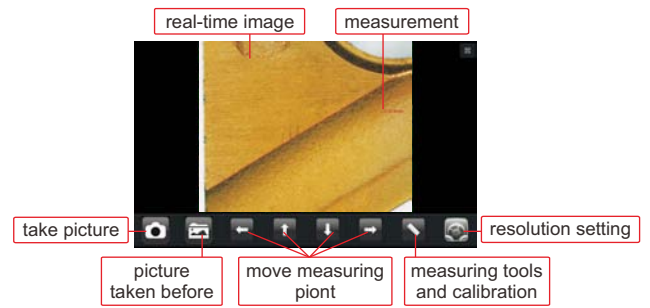



Continued from previous page

## 2 Software ISM-APK (for Android devices by WIFI)

-  measure length of line or distance between two points
-  measure radius, girth and area of circle with three points
-  measure angle







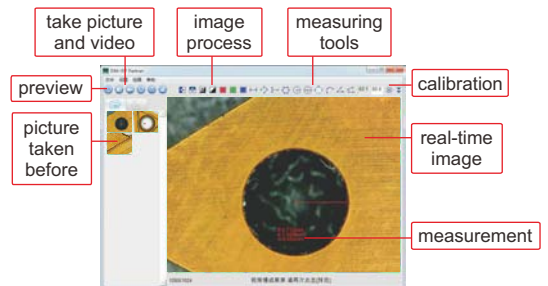







## 3 Software ISM-WF Partner (for computer by WIFI)

- |   |  |
|---|--|
|  measure length of line or distance between two points       |  measure angle with two lines                             |
|  measure area of polygon                                     |  measure radius, girth and area of circle with two points |
|  measure angle with three points                             |  measure distance between point and line                  |
|  measure radius, girth and area of circle with center point  |  measure radius, length and angle of arc                  |
|  measure length of continuous line                           |  measure area of rectangle                                |
|  measure radius, girth and area of circle with three points |  |



## 4 Software ISM-PRO (for computer by USB cable)

### Measuring tools:

- |   |   |
|---|---|
|  measure length of line or distance between two points |  measure distance between point and line |
|  measure length of continuous line                     |  measure area of rectangle               |
|  measure radius, length and angle of arc               |  measure angle with two lines            |
|  measure distance between two circles                  |  add number with circle                  |
|  measure distance between two parallel lines           |  measure angle with three points         |
|  measure radius, girth and area of circle              |  add text                                |

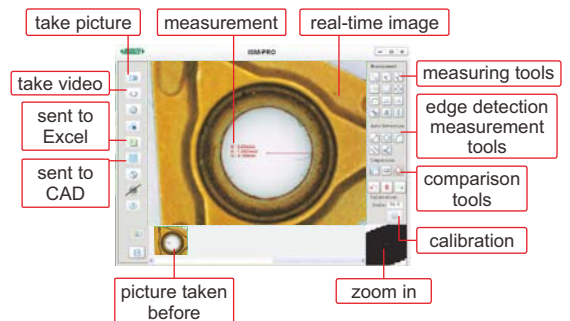

### Edge detection measurement tools:

- |  |  |
|--|--|
|  detect line automatically, and calculate length                      |  detect two lines automatically, and calculate angle            |
|  detect arc automatically, and calculate radius, angle and arc length |  detect two parallel lines automatically and calculate distance |
|  detect circle automatically, and calculate radius, girth and area    |  |

### Comparison tools:

Create line, angle or circle with desired size, to compare with workpieces

-  create line
-  create angle
-  create circle with tolerance

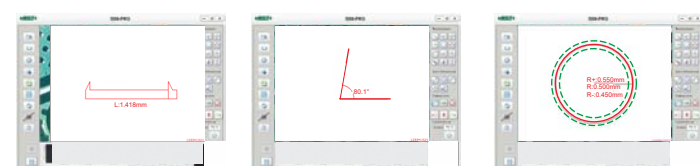

### Data is sent to CAD or Excel:

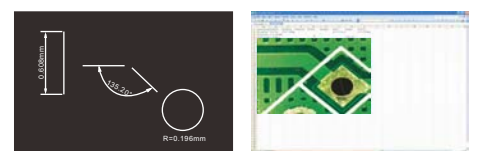

## INDUSTRIAL MICROSCOPES



5101-M500

- Infinite optical system, polarization observation, dark field observation
- Kohler illumination system provides uniform illumination field
- Objective 50X is spring type

### SPECIFICATION

Code	5101-M500 (bright field objectives)				5101-M500BD (bright & dark field objectives)			
Illumination	6V/30W halogen lamp, brightness is adjustable				12V/50W halogen lamp, brightness is adjustable			
Objective (infinite plan achromatic)	bright field objectives				bright & dark field objectives			
	5X	10X	20X	50X	5X	10X	20X	50X
Working distance	26.1mm	20.2mm	8.80mm	3.68mm	9.70mm	9.30mm	7.23mm	2.50mm
Numerical aperture	0.12	0.25	0.40	0.70	0.12	0.25	0.40	0.70
Magnification	50X~500X							
Eyepiece (wide field)	10X (view field: Ø22mm)							
Stage	double layer							
	size: 160×140mm							
	travel: 35x30mm							
Pupil distance	53~75mm							
Diopter adjustment	±5 diopter (one eyepiece)							
Power supply	220V, 50/60Hz							
Dimension (L×W×H)	415×345×380mm							
Weight	14kg							

### STANDARD DELIVERY

Main unit	1 pc
Anti-dust cover	1 pc

### OPTIONAL ACCESSORY

Bright & dark field objective (for 5101-M500BD)	PL40X	5101-M-BD40X
	PL60X	5101-M-BD60X
	PL80X	5101-M-BD80X
	PL100X	5101-M-BD100X
10X dividing eyepiece (0.1mm/div.)		5101-M-EPD10X
Bright field objective (for 5101-M500)	PL40X	5101-M-OB40X
	PL60X	5101-M-OB60X
	PL80X	5101-M-OB80X
	PL100X	5101-M-OB100X
Digital camera		ISM-CM20, ISM-CM63, ISM-ZS70-S
Camera adapter *		5101-M-ADAPTER

\* Digital camera must be used with camera adapter



## INDUSTRIAL INSPECTION MICROSCOPE (LARGE STAGE) CODE 5104-M700



- For observation and inspection of large IC and chip in IT industry

### SPECIFICATION

<b>Magnification</b>	40X~400X			
<b>Eyepiece (wide field)</b>	10X (view field: Ø22mm)			
<b>Objective (plan achromatic)</b>	4X	10X	20X	40X
<b>Numerical aperture</b>	0.10	0.25	0.40	0.60
<b>Working distance</b>	17.8mm	10mm	5.8mm	2.9mm
<b>Stage</b>	double layer, size: 300×268mm, travel: 250×200mm			
<b>Kohler illumination</b>	6V/20W halogen lamp, brightness is adjustable built-in green, blue, yellow and frosted glasses			
<b>Pupil distance</b>	48~75mm			
<b>Diopter adjustment</b>	±5 diopter (two eyepieces)			
<b>Power supply</b>	220V, 50/60Hz			
<b>Dimension (L×W×H)</b>	647×268×376mm			
<b>Weight</b>	12kg			

### STANDARD DELIVERY

<b>Main unit</b>	1 pc
<b>Camera connector</b>	1 pc
<b>Anti-dust cover</b>	1 pc

### OPTIONAL ACCESSORY

<b>Bright field objective</b>	5X plan achromatic objective (focus distance: 15.5mm)	5104-M700-OB5X
	50X plan achromatic objective (focus distance: 0.32mm)	5104-M700-OB50X
	100X plan achromatic objective (focus distance: 2mm)	5104-M700-OB100X
<b>Polarizer and analyzer</b>		5104-M700-AP
<b>Digital camera</b>		ISM-CM20, ISM-CM63, ISM-ZS70-S
<b>Camera adapter 0.5X *</b>		ISM-MAS-ADAPTER

\*Digital camera must be used with camera adapter

## METALLURGICAL MICROSCOPES



5102-M600

- Infinite optical system, observation in reflected or transmitted illumination, polarizing observation
- Kohler illumination system provides uniform illumination field
- Objectives 40X, 60X are spring type

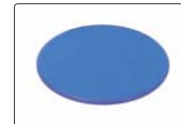

blue filter (included)



frosted glass filter (included)

### SPECIFICATION

Code	5102-M600 (bright field objectives)				5102-M600BD (bright & dark field objectives)			
Illumination	6V/30W (transmitted)		6V/30W (reflected)		12V/30W (transmitted)		12V/50W (reflected)	
Objective (infinite plan achromatic)	bright field objectives				bright & dark field objectives			
	5X	10X	40X	60X	5X	10X	20X	40X
Working distance	26.1mm	20.2mm	3.98mm	3.18mm	9.70mm	9.30mm	7.20mm	3.00mm
Numerical aperture	0.12	0.25	0.60	0.70	0.12	0.25	0.40	0.70
Magnification	50X~600X				50X~400X			
Eyepiece (wide field)	10X (view field: Ø22mm)							
Stage	double layer							
	size: 210×140mm							
	travel: 75×50mm							
Pupil distance	53~75mm							
Diopter adjustment	±5 diopter (one eyepiece)							
Power supply	220V, 50/60Hz							
Dimension (L×W×H)	456×260×498mm							
Weight	11kg							

### STANDARD DELIVERY

Main unit	1 pc
Anti-dust cover	1 pc
Filter (blue/frosted glass)	1 pc of each

### OPTIONAL ACCESSORY

Bright & dark field objective (for 5102-M600BD)	PL50X	5101-M-BD50X
	PL60X	5101-M-BD60X
	PL80X	5101-M-BD80X
	PL100X	5101-M-BD100X
10X dividing eyepiece (0.1mm/div.)		5101-M-EPD10X
Bright field objective (for 5102-M600)	PL20X	5101-M-OB20X
	PL50X	5101-M-OB50X
	PL80X	5101-M-OB80X
	PL100X	5101-M-OB100X
Digital camera		ISM-CM20, ISM-CM63, ISM-ZS70-S
Camera adapter *		5101-M-ADAPTER

\* Digital camera must be used with camera adapter

## METALLURGICAL MICROSCOPES (PROFESSIONAL TYPE)

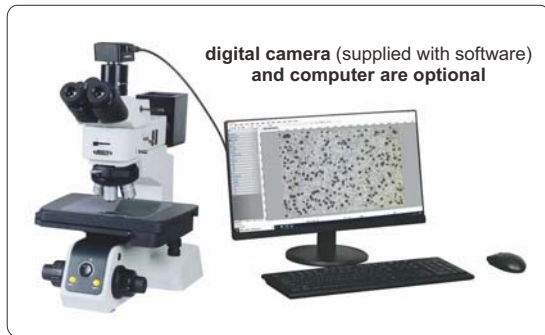

- Infinite chromatic aberration correction optical system
- Three way observation tube with infinite hinge
- Translucent and reflective frame, front low-hand position coarse and fine coaxial focus adjustment mechanism, with adjustment elastic device to prevent sliding and random upper limit device
- Bright and dark field five-hole converter with DIC slot
- Adopt digital dimming, with light intensity reset and setting function
- With polarizer insert plate and 360° rotating analyzer insert slot

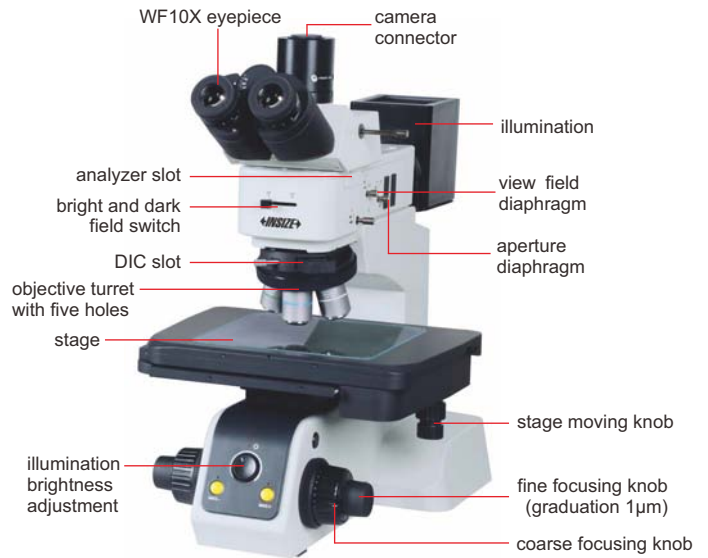

5108-M3000

### SPECIFICATION

Code	5108-M3000 (standard type)				5108-M3000H (high-definition type)			
Eyepiece	high eye point large field SWH10X-H (view field: Ø25mm, adjustable visibility)							
Objective (infinite long working distance bright and dark field semi achromatic)	5X	10X	20X	50X	5X	10X	20X	50X
Working distance	15mm	8.4mm	10.3mm	3.0mm	20mm	11mm	3.0mm	1.0mm
Numerical aperture	0.15	0.30	0.40	0.75	0.15	0.30	0.45	0.80
Optical magnification	50X~500X (up to 1000X with optional 100X objective)							
Digital magnification	170X~1700X (on 21.5" monitor), up to 3400X with optional 100X objective							
Stage	double layer							
	size: 310×240mm							
	travel: 150×100mm							
Condenser	roll-out achromatic condenser (numerical aperture 0.9)							
Illumination	5W LED, transmitted and reflected							
Observation tube	inverse image, distance adjustment: 50~76mm, two grade spectral ratio binocular: trinocular=100:0							
Diopter adjustment	±5 diopter (two eyepieces)							
Power supply	AC 100-240V							
Dimension (L×W×H)	310×600×500mm							
Weight	27kg							

### STANDARD DELIVERY

Main unit	1 pc
Anti-dust cover	1 pc
0.65X camera adapter (adjustable focus)	1 pc
Polarizer and analyzer	1 pc of each

### OPTIONAL ACCESSORY

Camera and software	ISM-CM63
Glass calibration rule	ISM-MAS-SCALE
Computer	5108-M-COMPUTER
2.5X infinite long working distance bright field semi achromatic objective	5108-M-OB2D5X
100X infinite long working distance bright and dark field semi achromatic objective	5108-M-BD100X
50X infinite long working distance bright and dark field achromatic objective	5108-M-APO50X
100X infinite long working distance bright and dark field achromatic objective	5108-M-APO100X
Differential interference module (DIC)	5108-M-DIC

## METALLURGICAL MICROSCOPES



5103-M1000

- Infinite optical system, polarization observation
- Kohler illumination system provides uniform illumination field
- Objectives 50X, 100X are spring type

### SPECIFICATION

Code	5103-M1000 (bright field objectives)				5103-M1000BD (bright & dark field objectives)			
Illumination	6V/30W halogen lamp, brightness is adjustable				12V/50W halogen lamp, brightness is adjustable			
Objective (infinite plan achromatic)	bright field objectives				bright & dark field objectives			
	10X	20X	50X	100X	5X	10X	20X	50X
Working distance	20.2mm	8.80mm	3.68mm	0.40mm	9.70mm	9.30mm	7.23mm	2.50mm
Numerical aperture	0.25	0.40	0.70	0.85	0.12	0.25	0.40	0.70
Magnification	100X~1000X				50X~500X			
Eyepiece (wide field)	10X (view field: Ø22mm)							
Stage	double layer							
	size: 242×200mm							
	travel: 30x30mm							
Pupil distance	53~75mm							
Diopter adjustment	±5 diopter (one eyepiece)							
Power supply	220V, 50/60Hz							
Dimension (L×W×H)	614×250×394mm							
Weight	13kg							

### STANDARD DELIVERY

Main unit	1 pc
Polarizer and analyzer	1 pc of each
Anti-dust cover	1 pc

### OPTIONAL ACCESSORY

Bright & dark field objective (for 5103-M1000BD)	PL40X	5101-M-BD40X
	PL60X	5101-M-BD60X
	PL80X	5101-M-BD80X
	PL100X	5101-M-BD100X
10X dividing eyepiece (0.1mm/div.)		5103-M-EPD10X
Bright field objective (for 5103-M1000)	PL5X	5101-M-OB5X
	PL40X	5101-M-OB40X
	PL60X	5101-M-OB60X
	PL80X	5101-M-OB80X
Digital camera		ISM-CM63
Camera adapter *		5101-M-ADAPTER

\* Digital camera must be used with camera adapter





## PORTABLE METALLURGICAL MICROSCOPE CODE 5109-PM500

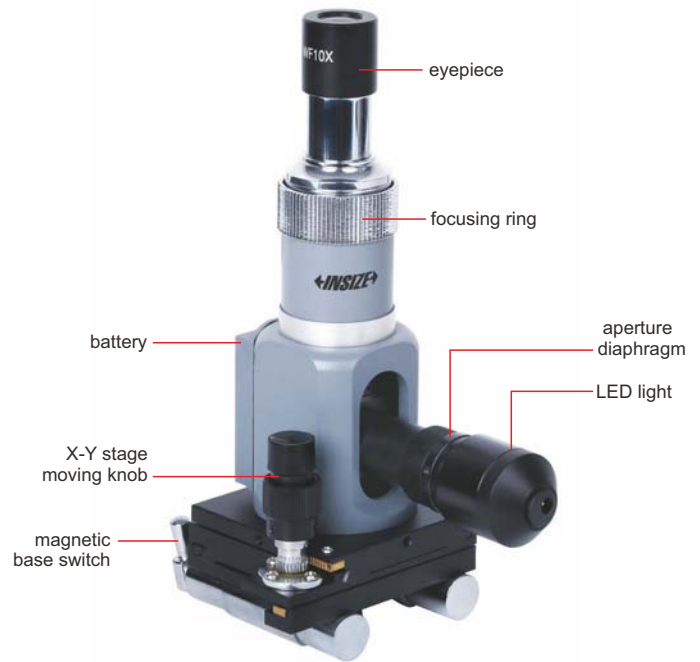
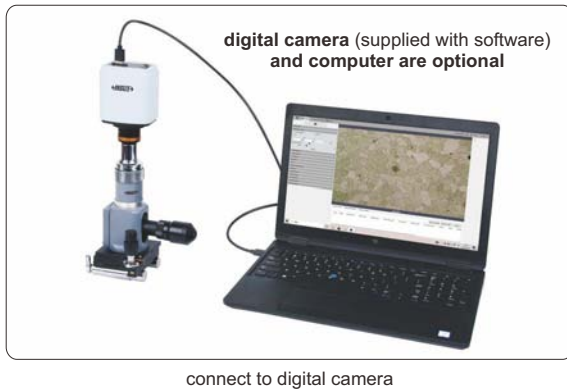

- Illumination is powered by batteries
- Aperture diaphragm improves image quality and increases depth of field
- Magnetic base with on/off switch can adhere on metal workpieces
- Can be connected to digital cameras

### SPECIFICATION

Magnification	100X~500X	
Eyepiece (wide field)	10X/12.5X	
Objective (plan achromatic)	10X (included)	40X (included)
Numerical aperture	0.25	0.64
Illumination	3W LED, built-in batteries	
Stage	double layer, size: 15×12mm	
Dimension (L×W×H)	210×160×95mm	
Weight	1.5kg	

### STANDARD DELIVERY

Main unit	1 pc
Eyepiece	2 pcs
Objective	2 pcs
Battery (AAA)	3 pcs

### OPTIONAL ACCESSORY

Objective	5X plan achromatic	5109-PM500-OB5X
	20X plan achromatic	5109-PM500-OB20X
	100X plan achromatic	5109-PM500-OB100X
Eyepiece	5X	5109-PM500-EP5X
	15X	5109-PM500-EP15X
Digital camera*		ISM-CM20, ISM-CM63, ISM-ZS70-S
Camera adapter 0.5X		ISM-MAS-ADAPTER

\*Digital camera must be used with camera adapter

## ZOOM STEREO MICROSCOPE (PROFESSIONAL TYPE) CODE 5107-S70T



LED ring light (optional)



- Greenough optical system, clear observation, real color
- High working distance is convenient for operation
- Excellent flat image and large depth of field, make observation comfortable
- 6.7:1 large zoom ratio, allow quick observation adjustment

### SPECIFICATION

Optical tube	trinocular
Eyepiece (wide field)	10X (view field: Ø22mm)
Objective	0.67X~4.5X (zoom)
Observation tube	45° trinocular tube inclination angle, built-in 0.5X adapter
Zoom ratio	6.7:1
Pupil distance	50~75mm
Diopter adjustment	-8~+5 diopter (both eyepieces)
Working distance of objective	110mm
Max. workpiece height	106mm
Illumination	adjustable LED light
Power supply	110/220V, 50/60HZ
Dimension (L*W*H)	330×300×368mm
Weight	3.5kg



frosted glass filter  
(included)



white/black plate  
(included)

### STANDARD DELIVERY

Main unit	1 pc
10X eyepiece	2 pcs
Ø100mm glass plate	1 pc
Ø100mm white/black plate	1 pc
Anti-dust cover	1 pc

### OPTIONAL ACCESSORY

Auxiliary objective	0.5X	5107-S70T-OB05X
	1.5X	5107-S70T-OB15X
	2X	5107-S70T-OB20X
Eyepiece	15X (view field: Ø16mm)	5107-S70T-EP15X
	20X (view field: Ø12.5mm)	5107-S70T-EP20X
LED ring light		ISM-ZS-RL
Digital camera		ISM-CM20, ISM-CM63, ISM-ZS70-S

PARALLEL LIGHT PATH: REDUCE FATIGUE,  
ACCESSORIES CAN BE ADDED INTO LIGHT PATH

## PARALLEL LIGHT STEREO MICROSCOPE CODE ISM-ZS200



VIDEO

coaxial illumination (optional)



optical path splitter (optional)



iris diaphragm (optional)



- Infinity parallel optical system and 20° inclined optical tube reduce fatigue
- Coaxial illumination is optional for deep holes which cannot be observed by ring light
- Aperture diaphragm is optional for large depth of field and high quality image

### SPECIFICATION

Optical tube	binocular (20° inclined)
Eyepiece (wide field)	10X (view field: Ø22mm)
Objective	0.8X~8X (zoom)
Zoom ratio	1:10
Pupil distance	55~75mm
Diopter adjustment	±5 diopter (both eyepieces)
Working distance of objective	78mm
Max. workpiece height	72mm
Illumination	adjustable reflected and transmitted LED light
Power supply	110/220V, 50/60HZ
Dimension (L×W×H)	240×280×440mm
Weight	4.3kg

### STANDARD DELIVERY

Main unit	1 pc
WF10X eyepiece	2 pcs
Ø100mm glass plate	1 pc
Ø100mm white/black plate	1 pc
Anti-dust cover	1 pc

### OPTIONAL ACCESSORY

Objective	0.5X achromatic objective (focus distance: 186mm)	ISM-ZS200-OB05X *
	2X plan achromatic objective (focus distance: 32.5mm)	ISM-ZS200-OB2X
	0.5X plan apochromatic objective (focus distance: 126mm)	ISM-ZS200-APO05X *
Eyepiece	WF15X (view field: Ø16mm)	ISM-ZS200-EP15X
	WF20X (view field: Ø12mm)	ISM-ZS200-EP20X
	WF30X (view field: Ø20mm)	ISM-ZS200-EP30X
Sleeve for objective		ISM-ZS200-ADAPTER
Iris diaphragm		ISM-ZS200-IRD
Optical path splitter		ISM-ZS200-OBS
Coaxial illumination		ISM-ZS200-COAXIAL
Digital camera **		ISM-CM20, ISM-CM63

\* 0.5X auxiliary objective must be used with ISM-ZS200-ADAPTER

\*\* Digital camera must be used with optical path splitter

## ZOOM STEREO MICROSCOPES (ADVANCED TYPE)

LARGE ZOOM RATIO

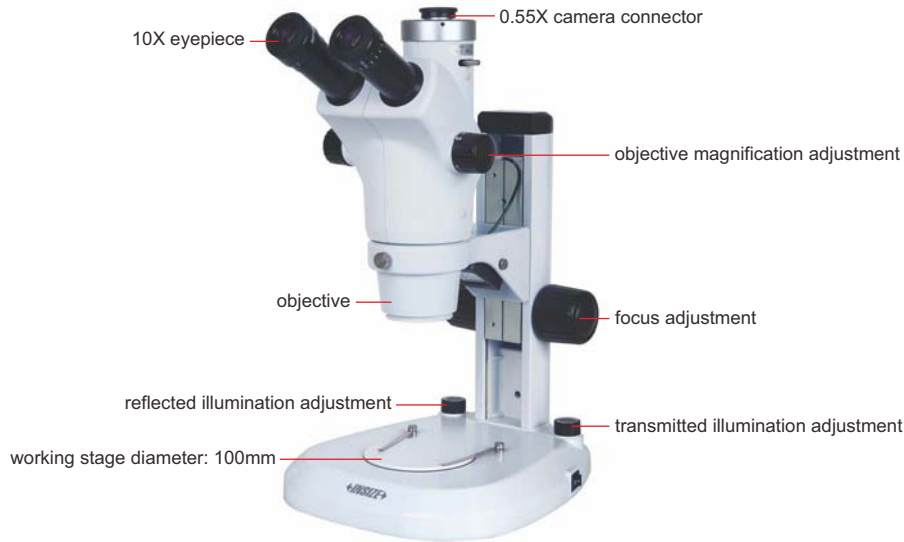

ISM-ZS100T

connect to digital camera (for ISM-ZS100T)



LED ring light (optional)

### SPECIFICATION

Code	ISM-ZS100	ISM-ZS100T
Optical tube	binocular	trinocular
Eyepiece (wide field)	10X (view field: Ø23mm)	
Objective	0.6X~5X (zoom)	
Zoom ratio	1:8.3	
Pupil distance	55~75mm	
Diopter adjustment	±5 diopter (two eyepieces)	
Working distance of objective	115mm	
Max. workpiece height	75mm	
Illumination	adjustable reflected and transmitted LED light	
Power supply	110/220V, 50/60HZ	
Dimension (L×W×H)	260×310×490mm	
Weight	4.9kg	

### STANDARD DELIVERY

Main unit	1 pc
Camera connector 0.55X for ISM-ZS100T	1 pc
Digital camera adapter 1X for ISM-ZS100T	1 pc
WF10X eyepiece	2 pcs
Ø100mm glass plate	1 pc
Ø100mm white/black plate	1 pc
Anti-dust cover	1 pc

### OPTIONAL ACCESSORY

Auxiliary objective	0.5X (focus distance: 220mm)	ISM-ZS100-OB05X *
	0.7X (focus distance: 125mm)	ISM-ZS100-OB07X
	2X (focus distance: 45mm)	ISM-ZS100-OB2X
Eyepiece	WF15X (view field: Ø16mm)	ISM-ZS100-EP15X
	WF20X (view field: Ø12mm)	ISM-ZS100-EP20X
	WF30X (view field: Ø8mm)	ISM-ZS100-EP30X
Sleeve for auxiliary objective		ISM-ZS200-ADAPTER
LED ring light		ISM-ZS-RL
Digital camera for ISM-ZS100T		ISM-CM20, ISM-CM63, ISM-ZS70-S

\*0.5X auxiliary objective must be used with ISM-ZS200-ADAPTER



## ZOOM STEREO MICROSCOPES (STANDARD TYPE)



LED ring light (optional)

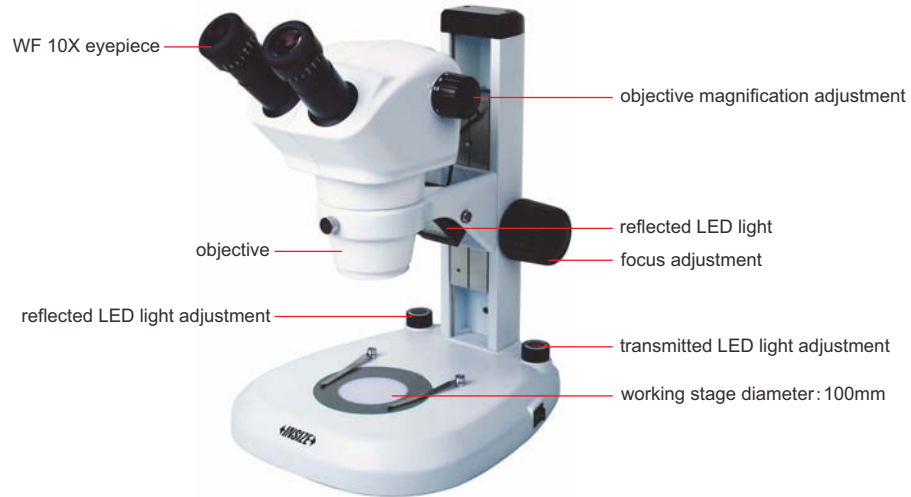

ISM-ZS50

### SPECIFICATION

Code	ISM-ZS50	ISM-ZS50T
Optical tube	binocular	trinocular
Eyepiece (wide field)	10X (view field: Ø22mm)	
Objective	0.8X~5X (zoom)	
Zoom ratio	1: 6.3	
Pupil distance	55~75mm (adjustable)	
Diopter adjustment	±5 diopter (two eyepieces)	
Working distance of objective	115mm	
Max. workpiece height	75mm	
Illumination	adjustable reflected and transmitted LED light	
Power supply	110/220V, 50/60HZ	
Dimension (L×W×H)	290×260×480mm	
Weight	4.9kg	

### STANDARD DELIVERY

Main unit	1 pc
WF 10X eyepiece	2 pcs
Ø100mm glass plate	1 pc
Ø100mm white/black plate	1 pc
Anti-dust cover	1 pc

### OPTIONAL ACCESSORY

Auxiliary objective	0.5X	ISM-ZS50-OB05X*
	2X	ISM-ZS50-OB2X
Eyepiece	10X dividing eyepiece (graduation 0.1mm/div.)	ISM-ZS50-EPD10X
	WF15X (view field: Ø16mm)	ISM-ZS50-EP15X
	WF20X (view field: Ø12mm)	ISM-ZS50-EP20X
LED ring light		ISM-ZS-RL
Sleeve for auxiliary objective		ISM-ZS200-ADAPTER
Digital camera for ISM-ZS50T		ISM-CM20, ISM-CM63, ISM-ZS70-S
Camera adapter 0.5X for ISM-ZS50T**		ISM-MAS-ADAPTER

\* 0.5X auxiliary objective must be used with ISM-ZS200-ADAPTER

\*\* Digital camera must be used with camera adapter 0.5X

## ZOOM STEREO MICROSCOPES (WITH UNIVERSAL STAND)



5106-M40 (with stand type A)

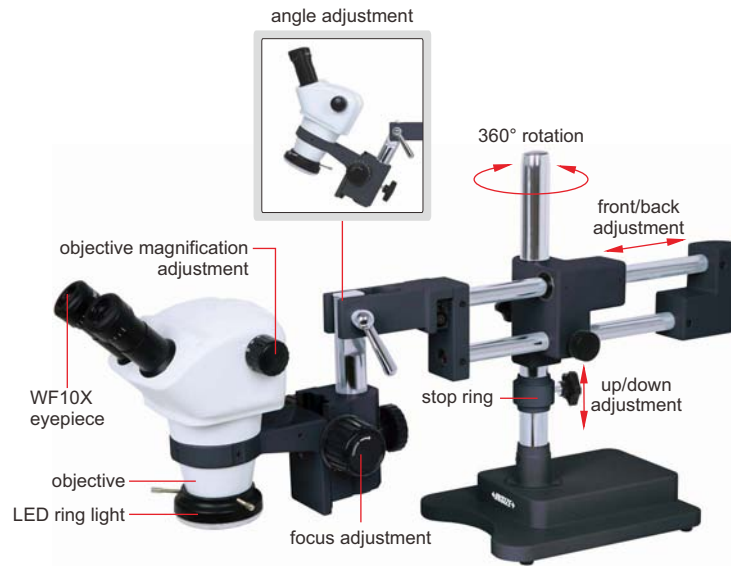

5106-M50 (with stand type B)

### SPECIFICATION

Code	5106-M40	5106-M40T	5106-M50	5106-M50T
Stand	type A		type B	
Optical tube	binocular	trinocular	binocular	trinocular
Eyepiece (wide field)	10X (view field: Ø22mm)			
Objective	0.8X~5X (zoom)			
Zoom ratio	1:6.3			
Pupil distance	55~75mm			
Diopter adjustment	±5 diopter (two eyepieces)			
Working distance of objective	115mm			
Max. workpiece height	300mm			
Illumination	adjustable reflected LED ring light			
Power supply	power adapter			
Dimension (L×W×H)	610×220×430mm		790×230×430mm	
Weight	13.7kg		20kg	

### STANDARD DELIVERY

Main unit (with stand)	1 pc
WF10X eyepiece	2 pcs
LED ring light	1 pc
Anti-dust cover	1 pc

### OPTIONAL ACCESSORY

Auxiliary objective	0.5X	ISM-ZS50-OB05X*
	2X	ISM-ZS50-OB2X
Eyepiece	10X dividing eyepiece (0.1mm/div.)	ISM-ZS50-EPD10X
	WF15X (view field: Ø16mm)	ISM-ZS50-EP15X
	WF20X (view field: Ø12mm)	ISM-ZS50-EP20X
Adapter sleeve		ISM-ZS30-ADAPTER
0.5X adapter for 5106-M40T/M50T		ISM-MAS-ADAPTER
Digital camera for 5106-M40T/M50T**		ISM-CM20, ISM-CM63

\* 0.5X auxiliary objective must be used with ISM-ZS30-ADAPTER

\*\* Digital camera must be used with 0.5X adapter ISM-MAS-ADAPTER



## ZOOM STEREO MICROSCOPE (BASIC TYPE) CODE ISM-ZS30



### SPECIFICATION

Optical tube	binocular
Eyepiece (wide field)	10X (view field: Ø20mm)
Objective	1X~4.5X (zoom)
Zoom ratio	1:4.5
Pupil distance	55~75mm (adjustable)
Diopter adjustment	±5 diopter (two eyepieces)
Working distance of objective	97mm
Max. workpiece height	60mm
Illumination	adjustable reflected and transmitted LED light
Power supply	110/220V, 50/60HZ
Dimension (L×W×H)	260×190×400mm
Weight	4.3kg



LED ring light (optional)

### STANDARD DELIVERY

Main unit	1 pc
WF 10X eyepiece	2 pcs
Ø95mm glass plate	1 pc
Ø95mm white/black plate	1 pc
Anti-dust cover	1 pc

### OPTIONAL ACCESSORY

Auxiliary objective	0.5X	ISM-ZS30-OB05X *
	0.63X	ISM-ZS30-OB06X *
	0.75X	ISM-ZS30-OB07X *
	2X	ISM-ZS30-OB2X
Eyepiece	10X dividing eyepiece (graduation 0.1mm/div.)	ISM-ZS30-EPD10X
	WF15X (view field: Ø16mm)	ISM-ZS50-EP15X
	WF20X (view field: Ø12mm)	ISM-ZS50-EP20X
LED ring light		ISM-ZS-RL
Sleeve for auxiliary objective		ISM-ZS30-ADAPTER
Digital camera		ISM-CM63
Camera adapter 0.75X **		ISM-AD-0D75

\*0.5X, 0.63X and 0.75X auxiliary objectives must be used with ISM-ZS30-ADAPTER

\*\* Digital camera must be used with camera adapter 0.75X

## LONG WORKING DISTANCE STEREO MICROSCOPES (LOW MAGNIFICATION)



5305-ZS80



5305-ZS90

### SPECIFICATION

Code	5305-ZS80 (with metal base)	5305-ZS90 (with magnetic base)
Magnification	8X	
Eyepiece (wide field)	10X (view field: Ø20mm)	
Objective	0.8X	
Pupil distance	55~75mm	
Diopter adjustment	±5 diopter (one eyepiece)	
Working distance of objective	115mm	
Max. workpiece height	100mm	140mm
Dimension (L×W×H)	280x160x370mm	280x180x410mm
Weight	3.7kg	2.1kg

### STANDARD DELIVERY

Main unit	1 pc
10X eyepieces	1 pair
0.8X objective	1 pc
Anti-dust cover	1 pc

### OPTIONAL ACCESSORY

Eyepiece	WF5X (view field: Ø20mm)	5305-ZS80-EP5X
	WF15X (view field: Ø15mm)	5305-ZS80-EP15X
	WF20X (view field: Ø10mm)	5305-ZS80-EP20X
LED ring light	ISM-ZS-RL	



LED ring light (optional)





## POLARIZING MICROSCOPE CODE ISM-POL1000



- Widely used in geology, mineralogy, fossil fuel exploration
- Single polarization, orthogonal polarization or conoscopic observation are available

### SPECIFICATION

<b>Magnification</b>	40X~600X				
<b>Eyepiece</b>	10X (view field: Ø20mm)				
<b>Infinite strain free plan achromatic objective</b>	4X (transmitted/reflected)	10X (transmitted/reflected)	20X (transmitted)	40X (transmitted)	60X (transmitted)
<b>Working distance</b>	22.2mm	6.1mm	6.4mm	0.6mm	0.3mm
<b>Numerical aperture</b>	0.1	0.25	0.4	0.65	0.8
<b>Stage</b>	revolving round stage diameter: Ø160mm graduation: 1°, resolution: 6'				
<b>Pupil distance</b>	53~75mm				
<b>Diopter adjustment</b>	±5 diopter (one eyepiece)				
<b>Illumination</b>	12V/50W halogen lamp, brightness is adjustable (reflected illumination) 12V/20W halogen lamp, brightness is adjustable (transmitted illumination)				
<b>Power supply</b>	110/220V, 50/60HZ				
<b>Dimension (L×W×H)</b>	614×250×394mm				
<b>Weight</b>	13kg				

### STANDARD DELIVERY

<b>Main unit</b>	1 pc
<b>Micrometer</b>	1 pc
<b>Grid plate</b>	1 pc
<b>10X crossing eyepiece (view field: Ø20mm)</b>	1 pc
<b>10X dividing eyepiece (view field: Ø20mm, graduation 0.1mm)</b>	1 pc
<b>λ slip (first class red) and 1/4λ slip</b>	1 pc
<b>Quartz wedge</b>	1 pc

### OPTIONAL ACCESSORY

<b>Objective for reflected system</b>	PL20X	ISM-POL1000-OBR20X
	PL40X	ISM-POL1000-OBR40X
	PL60X	ISM-POL1000-OBR60X
	PL100X	ISM-POL1000-OBR100X
<b>Objective for transmitted system</b>	PL100X	ISM-POL1000-OBT100X
<b>Specimen presser</b>		ISM-POL1000-SP

# DIGITAL CAMERA FOR MICROSCOPES (WITH PAD) CODE ISM-ZS70-S

ATTENTION: CAMERA CONNECTOR AND ADAPTER ARE NEEDED ACCORDING TO MICROSCOPES

MEASUREMENT, TAKE PICTURES AND VIDEOS

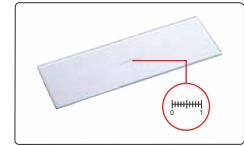
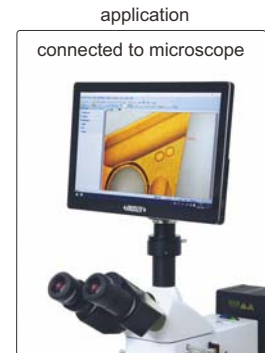
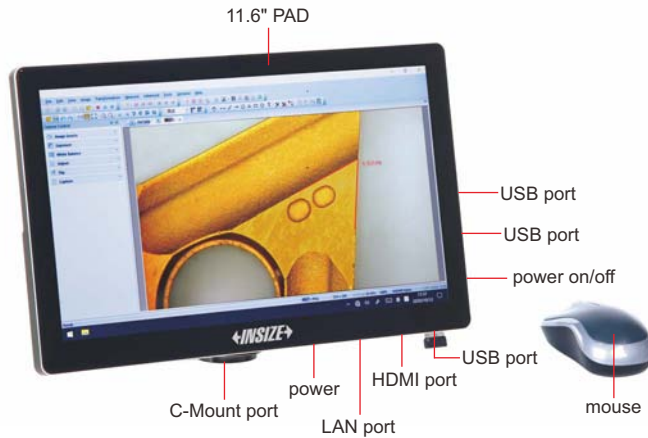

glass calibration rule (included, graduation 0.1mm)

- Windows 10 operation system
- Built-in software, can take pictures and videos, can measure
- Language: Chinese, English, French, Japanese, German, Polish, Arabic
- Automatic exposure, white balance, brightness, contrast ratio, saturation are adjustable
- Image process feature: zoom in/out, flip, mirror, stitching and so on
- Output to Excel or CSV file

software (included)

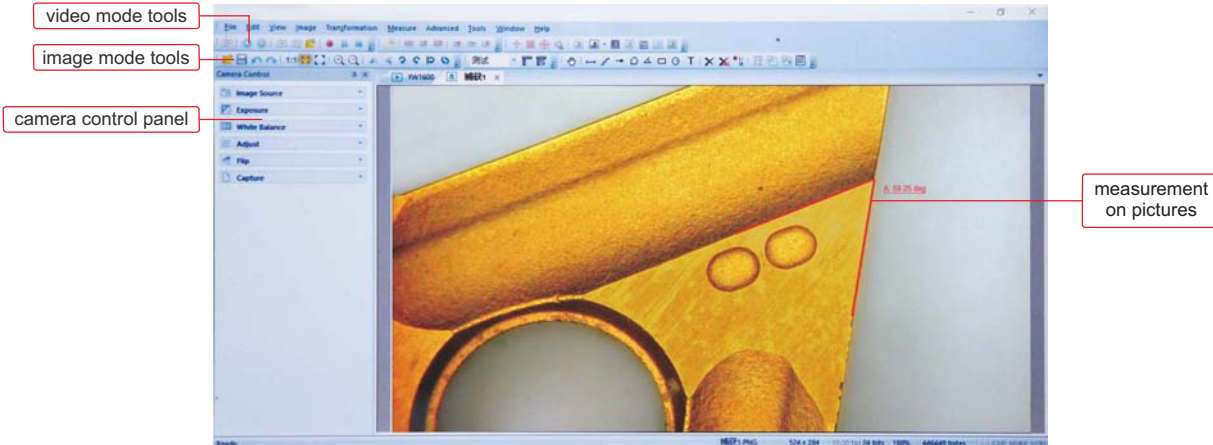

25

### Measuring tools

- measure line
- measure meander line
- arrow mark
- measure polygon
- calibration
- measure angle
- measure rectangle
- measure circle
- text mark
- show/hide scale

### SPECIFICATION

Sensor	1/2.3" CMOS
Pixel	16M
Resolution	800×600, 1600×1200, 1920×1080, 2048×1536, 2304×1728, 2592×1944, 4608×3456
Frame rate	30fps (1920×1080)
Output	HDMI, USB 3.0
Power supply	power adapter
Dimension (L×W×H)	280.3×177.4×12.5mm
Weight	0.9kg

### STANDARD DELIVERY

Main unit	1 pc
Mouse	1 pc
Glass calibration rule (graduation 0.1mm)	1 pc
AC/DC adapter	1 pc

**ATTENTION: ADAPTERS ARE NEEDED ACCORDING TO MICROSCOPES**

## DIGITAL CAMERA FOR MICROSCOPES CODE ISM-CM63

- To be used with computers
- Sony Exmor back-illuminated CMOS sensor
- USB3.0 transmission
- Automatic exposure, gain adjustment, white balance, chrominance adjustment, saturation adjustment, gamma correction, luminance adjustment, contrast adjustment



C-mount port

adapter 0.75X (optional)



application



glass calibration rule (included, graduation 0.1mm)

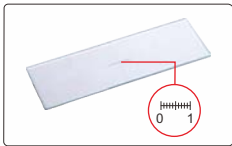

software (included)

selectable resolution



histogram (quantify the distribution of color and brightness)

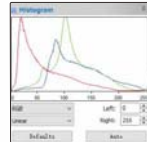

measurement items

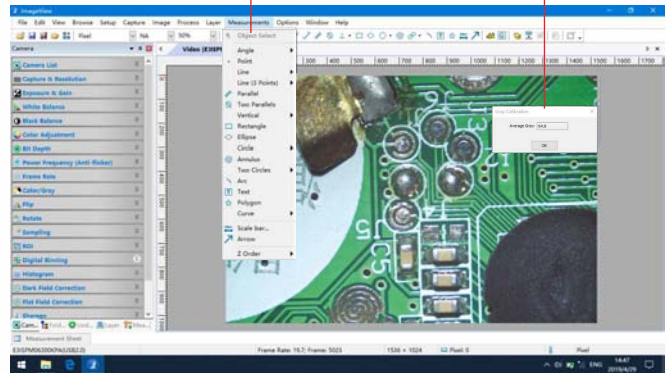

real time gray calibration

automatic image stitching (expand field of view)

left side

right side

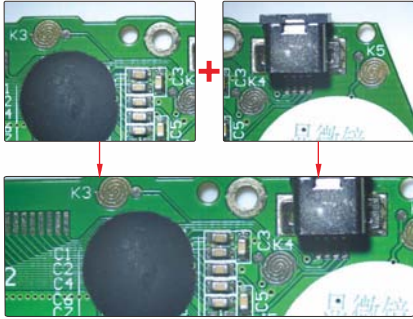

after stitching

counting

select counting tool

automatic counting



black balance (reduce color difference)



flat field correction (reduce brightness difference)

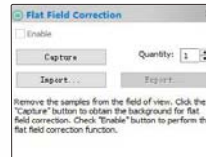

dark field correction (reduce thermal noise)

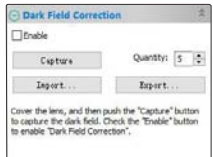

The software can control image completely, including measurement, image stitching, extend focus depth, image gray processing, RGB histogram observation, image color sampling, 3D plot (3D representation of image intensity), image exposure, white balance, black balance, image bit depth, flat field correction and dark field correction, etc.

### Measuring tools:

- |  |   |  |  |
|--|---|--|--|
|  | measure length of line or distance between two points |  | measure rectangle                                |
|  | measure distance between two parallel lines           |  | measure width and diameter of ring               |
|  | measure angle   |  | measure diameter, length, perimeter angle of arc |
|  | measure radius, girth and area of circle              |  | measure area of polygon                          |
|  | measure axis lengths, girth and area of ellipse       |  | measure center distance between two circles      |
|  | calibration   |  | measure length of open curve                     |

focus stacking



binary

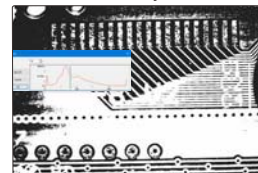

separate target and background

3D plot

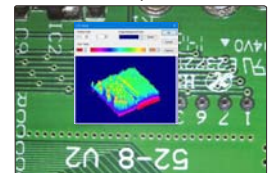

visualize the distribution of image brightness and color

To be continued

Continued from previous page

**SPECIFICATION**

Sensor (back-up)	1/1.8" CMOS
Resolution	3072×2048
Pixel	6.3M
Single pixel size	2.4×2.4μm
Spectral range	380-650nm (with infrared cut filter)
Frame rate	30fps
Sampling average	1×1
Exposure time	0.1ms~15s
Power supply	USB port
Weight	400g

**COMPUTER REQUIREMENT**

Operation system	Windows 7/8/10
CPU	Intel Core 2 2.8Hz or above
Memory	2GB or above
USB port	USB3.0 (recommand) or USB2.0
Display	17" or above

**STANDAER DELIVERY**

Camera (USB cable included)	1 pc
Software	1 pc
Glass calibration rule (graduation 0.1mm)	1 pc

**OPTIONAL ACCESSORY**

Adapter 0.75X	ISM-AD-0D75
---------------	-------------

**SMART CAMERA  
CODE ISM-MV10**



- Built-in software, operated by mouse.
- Automatically calculate, store the test results and sent to Excel
- Camera with PLC control input and output interface, can be integrated with automation equipment
- Functions: presence or absence of objects, position tilt correction, object counting, color detection, stain detection, dimension measurement, position guide, etc.

**SPECIFICATION**

Chip structure	FPGA+ARM
Operation system	Linux 3.10
Kernel structure	dual-core Cortex-A9
Frequency	1GHZ
I/O port	3 sets of input and output (can be connected to photoelectric switch, wire switch, PLC, etc.)
Operation temperature	-10~70°C
Sensor	1/2" CMOS
Single pixel size	3.75×3.75μm
Resolution	1920×1080
Frame rate	60fps
Video output	HDMI port
Lens connection	standard C port

**SOFTWARE**

presence or absence of objects



select the area and specify the target, the camera will automatically detect the presence or absence of the target.

automatic counting



select the area and specify the target, the camera will automatically calculate the number of targets.

dimension measurement

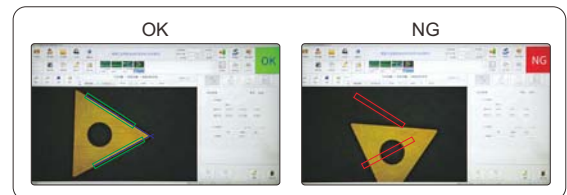

measuring angle, distance, radius, center distance, etc.

**STANDAER DELIVERY**

Camera (with HDMI cable)	1 pc
Software	1 pc



**ATTENTION: ADAPTERS ARE NEEDED ACCORDING TO MICROSCOPES**

**FOCUS STACKING**

**AUTOMATIC IMAGE STITCHING**

# DIGITAL CAMERA FOR MICROSCOPES CODE ISM-CM20

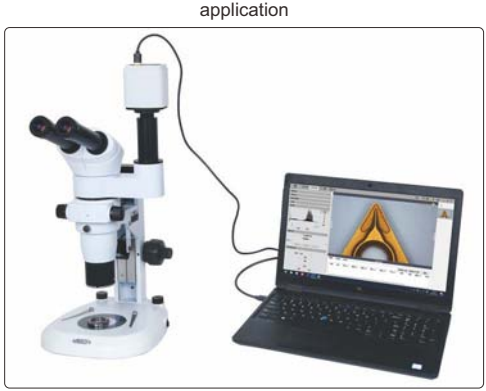
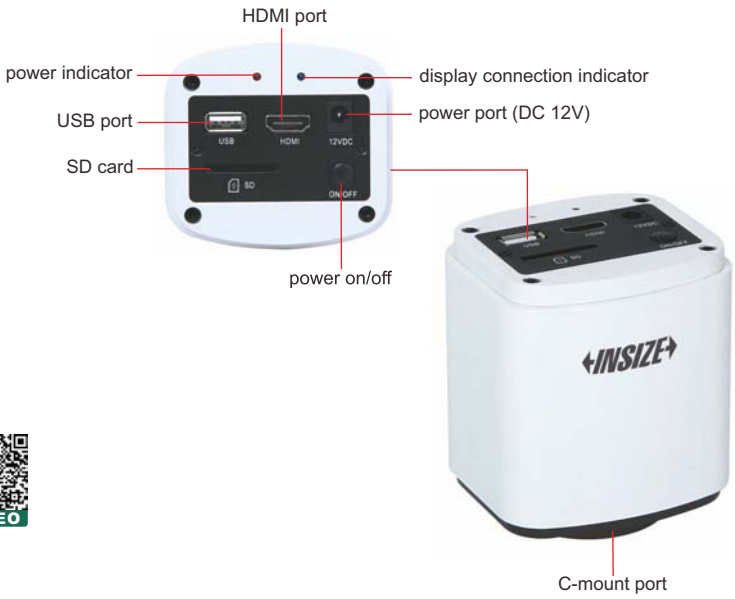

- 1080P high-definition image
- Can be connected with displays or computers
- Built-in simple measuring software for displays, without computer
- Professional measuring software for computers is included
- For bright field, dark field or fluorescent field
- Automatic exposure, white balance, gain adjustment, gamma correction, brightness contrast adjustment, saturation adjustment, chroma sharpness adjustment
- Focus stacking, automatic image stitching

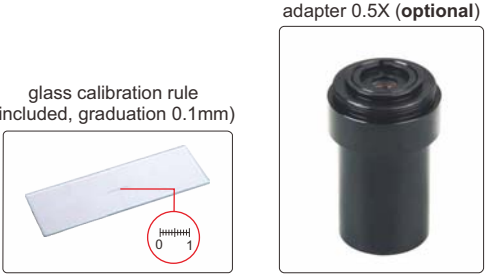

## SIMPLE MEASURING SOFTWARE (BUILT-IN, FOR DISPLAYS)

- **Measuring tools:**
  - measure length of line or distance between two points
  - measure distance between point and line
  - measure rectangle
  - measure concentric circles
  - measure circle
  - measure curve
  - measure polygon
  - measure center distance of two circles
  - measure angle of two lines

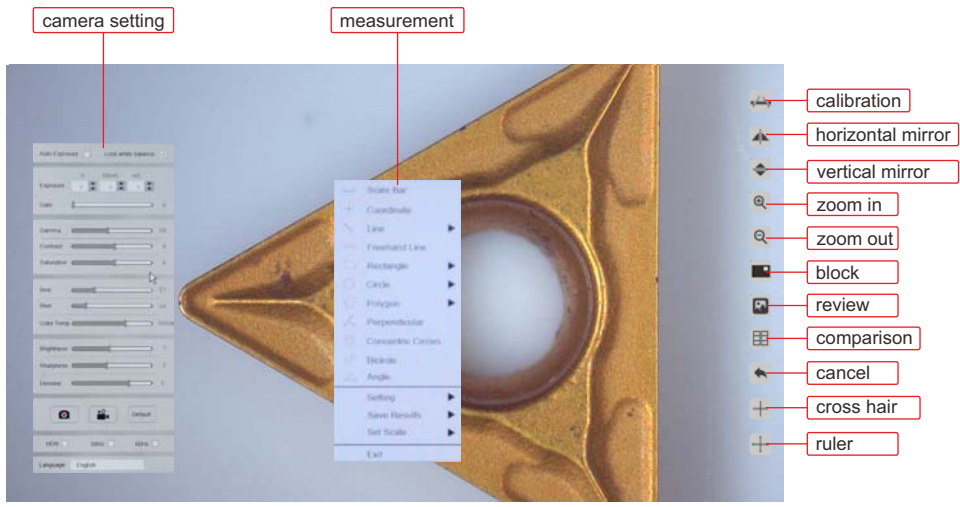

auto exposure, white balance, gain adjustment, gamma, chroma contrast adjustment, brightness sharpness adjustment, size measurement

To be continued

Continued from previous page

## PROFESSIONAL MEASURING SOFTWARE (INCLUDED, FOR COMPUTERS)

**selectable resolution**



**white balance**  
(balance color based on actual light source)

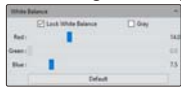

**histogram**  
(quantify the distribution of color and brightness)



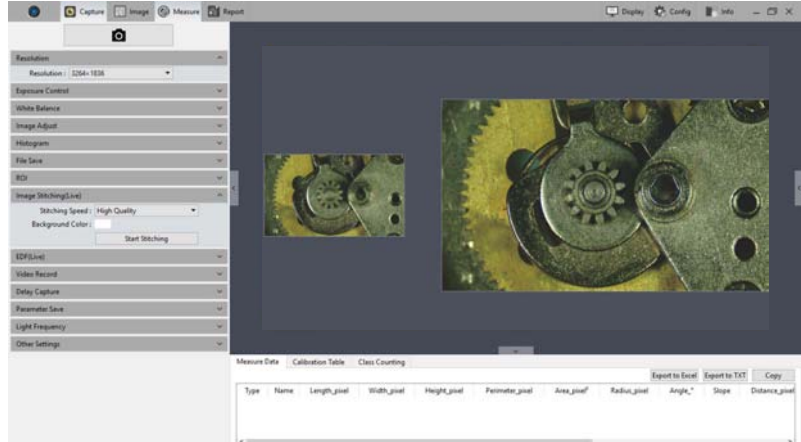

**flat field correction**



**metrics flow**  
(create templates, set tolerances and build metrics flow)

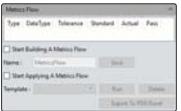

**manual counting**  
(class counting)





image coloring, fluorescence synthesis, binary, image smoothing, color filter/color extraction/color inversion, delay capture, focus stacking, automatic image stitching, metrics flow, manual counting, dynamic and static measurement, layered measurement, report generation and printing, delay record, flat field correction, image adjustment, histogram.

**focus stacking**



focus on the top

+



focus on the bottom

→



clear image of both top and bottom

**automatic image stitching**



+



→



slowly move the workpiece to generate a stitched image automatically (this image can not be used for size measurement)

### SPECIFICATION

Sensor	1/2.8" CMOS
Pixel	2M
Resolution	1920×1080
Frame rate	30fps
Power supply	power adapter
Output	HDMI/USB
Lens connection	C-mount

### COMPUTER (optional) REQUIREMENT

Operation system	Windows 7/8/10 (64 bit)
CPU	Intel Core i5 or above
Memory	8GB or above
USB port	USB 3.0

### DISPLAY (optional) REQUIREMENT

Size	13" or above
Resolution	1080P or above
HDMI port	type A

### STANDARD DELIVERY

Main unit	1 pc
16G memory card and holder	1 pc
Glass calibration rule (graduation 0.1mm)	1 pc
Mouse	1 pc
HDMI cable	1 pc
USB cable	1 pc
Power supply	1 pc

### OPTIONAL ACCESSORY

Adapter 0.5X	ISM-MAS-ADAPTER
--------------	-----------------

WIRELESS AD-HOC NETWORK

AUTOMATIC IMAGE STITCHING

FOCUS STACKING

## WIFI 4K CAMERA FOR MICROSCOPES CODE ISM-MP8B

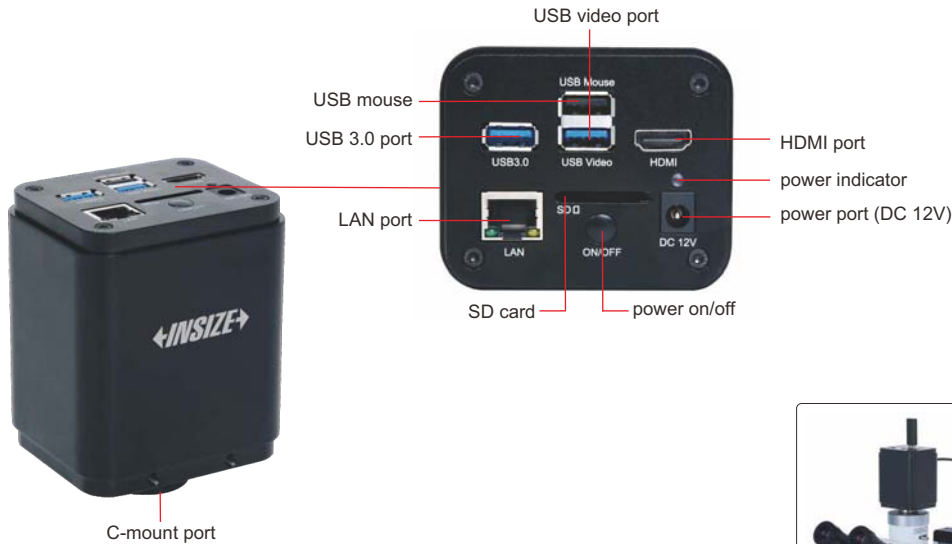

application



- 4K high-definition image
- Can be connected with displays or computers
- Built-in simple measuring software for display, without computer
- Professional measuring software for computers is included
- 4K HDMI/LAN/USB multiple video outputs
- 4K/1080P automatically switched by display resolution
- Focus stacking, automatic image stitching
- Wireless network or wired network



simple measuring software (built-in, for displays)

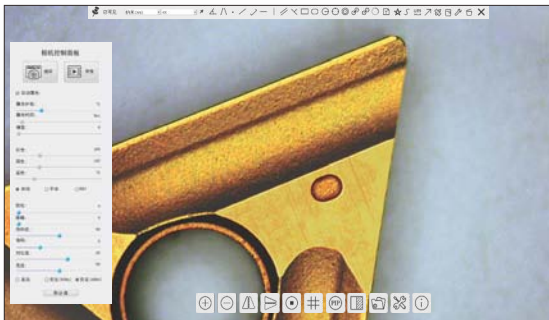

professional measuring software (included, for computers)

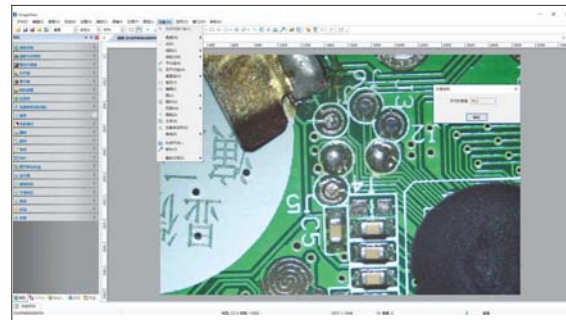

### SPECIFICATION

Sensor	1/1.2" CMOS
Pixel	8M
Resolution	3840×2160, 1920×1080
Single pixel	2.9×2.9μm
Frame rate	60fps@3840×2160 (HDMI) 30fps@3840×2160 (LAN) 30fps@3840×2160 (USB)
Binning	1×1
Exposure	0.04~1000ms
Output	HDMI/USB/LAN
Lens connection	C-mount
Power supply	DC 12V 1A
Dimension (L×W×H)	80×65×105mm
Weight	700g

### CONNECTION

HDMI	comply with HDMI 2.0 standard 4K/1080P automatically switched by display resolution
LAN	H264 encoded video bandwidth adjustment in real time DHCP configuration or manual configuration unicast/multicast configuration
WLAN	connecting 5G WLAN adapter (USB 3.0 interface) in AP/STA mode
COMPUTER	connecting USB video port of PC for video transfer H264/MJPEG format video

To be continued

Continued from previous page

### STANDARD DELIVERY

Main unit	1 pc
32G SD card	1 pc
USB mouse	1 pc
HDMI2.0 cable	1 pc
USB3.0 cable	1 pc
USB wlan adapter	1 pc
Wlan cable	1 pc
Glass calibration ruler	1 pc
Calibration plate	1 pc
Software	1 pc
Power adapter	1 pc

### OPTIONAL ACCESSORY













16G USB flash disk		IS-USBDISK-16G
Adjustable lens adapter	Ø23.2mm eyepiece tube	ISM-MP-2A075
	Ø31.75mm eyepiece tube	ISM-MP-3A075
Fixed lens adapter	Ø23.2mm eyepiece tube	ISM-MP-2F075
	Ø31.75mm eyepiece tube	ISM-MP-3F075
Adapter ring for Ø30.0mm eyepiece tube		ISM-MP-300R
Adapter ring for Ø30.5mm eyepiece tube		ISM-MP-305R

### COMPUTER

Operation system	Windows 7/8/10/11
CPU	Intel Core 2 2.8Hz
Memory	2GB
USB port	USB 3.0 or USB 2.0 port
Display	17"

### PROFESSIONAL MEASURING SOFTWARE (INCLUDED, FOR COMPUTERS)

#### Measuring tools:

-  measure length of line or distance between two points
-  measure rectangle
-  measure distance between two parallel lines
-  measure width and diameter of ring
-  measure angle
-  measure diameter, length, perimeter angle of arc
-  measure radius, girth and area of circle
-  measure area of polygon
-  measure axis lengths, girth and area of ellipse
-  measure center distance between two circles
-  calibration
-  measure length of open curve

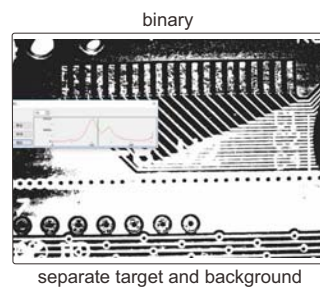
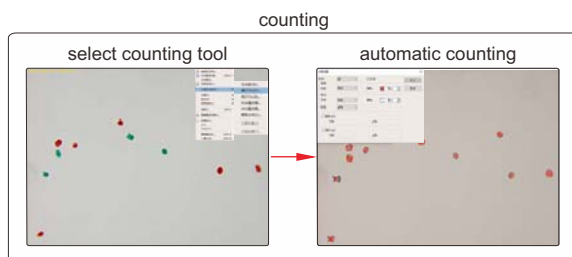
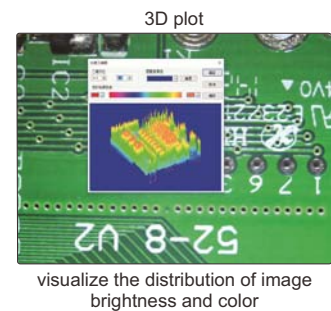
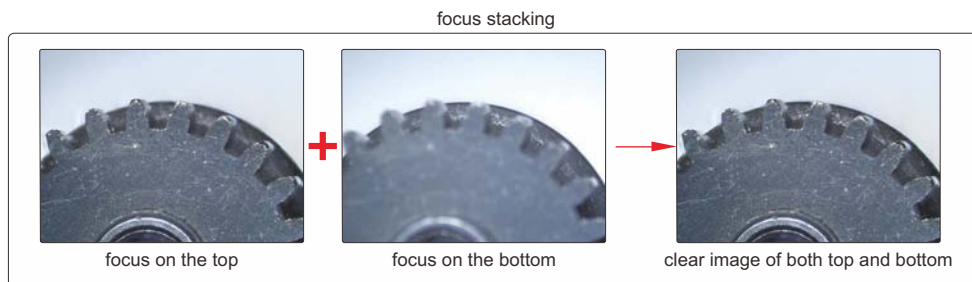
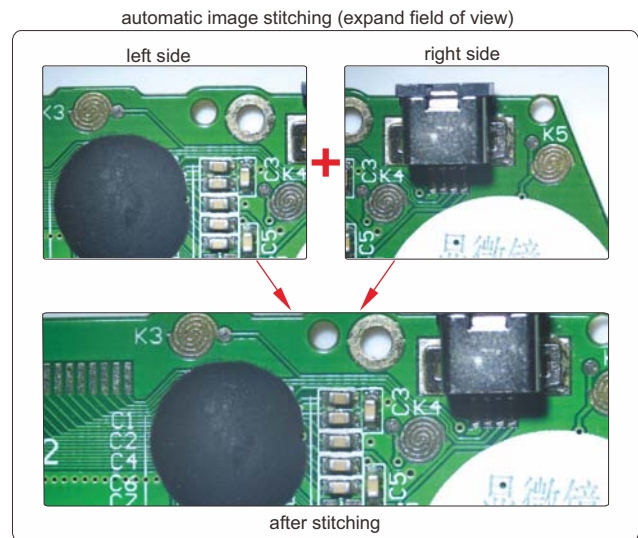



# METALLURGICAL ANALYSIS SOFTWARE AND CAMERA CODE ISM-MAS100

- More than 100 standards (ISO, ASTM, JIS, etc.)
- For metallurgical microscopes
- The camera can be inserted into the eyepiece tube or camera connector of microscopes
- Metallurgical analysis software is included, which can make comparative analysis, measurement and evaluation of various materials



application



software flash disk (included)



glass calibration rule (included)

metallurgical analysis software (included)

tool bar

gallery

this software can be used with variety of metallographic microscopes for acquisition, processing, analysis, report generation of metallurgical images

metallurgical module list

Select autoAnalysis Item

- [001] METHOD OF AVERAGE GRAIN SIZE AREA OF METAL
- [002] METAL AVERAGE GRAIN SIZE CUTTING POINT METHOD
- [003] Details of Average Grain Size Testing for Other Metals and Alloys
- [004] Standard for Dual Grain Size Characterization Test Method Area Fraction Evaluation Comparison Chart
- [005] Standard for Dual Grain Size Characterization Test Method 21. Micrographs of Dual Grain Size Types
- [006] Standard for Dual Grain Size Characterization Test Method 22. Application of Statistical Program for Determining Grain Size Distribution
- [007] Steel apparent grain size of micrographic estimating(planimetry) IN
- [008] Steel apparent grain size of micrographic estimating(transversal method) IN
- [009] Determination of nonmetallic inclusion content in steel by standard grading diagram
- [010] Evaluation Method of Inclusion Content in Steel (Hurst field of view method)
- [011] Evaluation Method of Inclusion Content in Steel (Low Inclusion Content Method)
- [012] Evaluation Method of Inclusion Content in Steel (Method)
- [013] Metallurgical examination of precious metal cuprous oxide
- [014] Determination of decarburization depth of steel
- [015] DETERMINATION OF FERRITE GRAIN SIZE OF LOW CARBON STEEL COIL ROLLED SHEET GRAIN LENGTHENING
- [016] Determination of Phase Area Content of Stainless Steel
- [017] Metallurgical Examination of Gray Cast Iron Graphite Distribution Shape
- [018] Metallurgical Examination of Gray Cast Iron Graphite Length (Manual Analysis)
- [019] Metallurgical Inspection of Gray Cast Iron Number of Pearlite
- [020] Metallurgical Examination of Gray Cast Iron Number of Ferrite
- [021] Metallurgical Examination of Gray Cast Iron Number of Phosphorus Eutectic
- [022] Metallurgical Examination of Gray Cast Iron Determination of the Number of Eutectic Groups of Cast Iron
- [023] Metallurgical examination of gray cast iron Phosphorus eutectic type etc.
- [024] Quantitative metallographic determination
- [025] Free cementite
- [026] Pearlite in Low Carbon Deformed Steel
- [027] Zonal tissue
- [028] Widmanstatten tissue
- [029] Microstructure Assessment of Steel Calculation of Fraustite Content
- [030] Metallurgical Martensite Needle Length Rating of Carburized Gear for Automobile
- [031] Metallurgical Carbide Rating of Carburized Gears for Automobile
- [032] Metallurgical Retained Austenite Rating of Carburized Gears for Automobile

[Multi-module grad] [Clear All] [OK] [Cancel]

To be continued

Continued from previous page

examples of metallurgical analysis

**metallurgical analysis of ductile cast iron-spheroidizing grading**

**metallurgical analysis of ductile cast iron-pearlite quantity**

**dimension measurement**

**report**

(Report name)

Sample Name	Sample Reference	Sample Date	Sample Size
Operator	Operator	Operator	Operator
Material	Material	Material	Material
Analysis Date	Analysis Date	Analysis Date	Analysis Date

**focus stacking**

**image stitch**

**three dimension map**

**SPECIFICATION**

Sensor	1/1.8" CMOS
Pixel	6.3M
Resolution	3072×2048
Frame rate	30fps
Exposure time	0.1ms~15s
Power supply	USB port
Weight	400g

**STANDARD DELIVERY**

Camera (USB cable included)	1 pc
Software	1 pc
Glass calibration rule	1 pc

## CAMERA ADAPTERS

- Ø23.2/30mm eyepiece adapter is included
- Suitable for digital cameras ISM-CM20, ISM-CM63, ISM-ZS70-S



Ø23.2/30mm eyepiece adapter (included)



0.5X camera adapter (fixed focus distance) ISM-AD-0D5



0.75X camera adapter (fixed focus distance) ISM-AD-0D75



0.5X camera adapter (adjustable focus distance) ISM-AD-A0D5



0.75X camera adapter (adjustable focus distance) ISM-AD-A0D75



### SPECIFICATION

Code	ISM-AD-0D5	ISM-AD-A0D5 *	ISM-AD-0D75	ISM-AD-A0D75
Type	fixed focus distance	adjustable focus distance	fixed focus distance	adjustable focus distance
Magnification	0.5X	0.41X~0.58X	0.75X	0.64X~0.86X

\* There may be shadows on the edge of image when ISM-AD-A0D5 is used

## PORTABLE MEASURING MICROSCOPES



ISM-PM100

### SPECIFICATION

Code	ISM-PM20	ISM-PM40	ISM-PM50	ISM-PM100
Total magnification	20X	40X	50X	100X
Eyepiece	10X with graduation	10X with graduation	10X with graduation	10X with graduation
Objective (achromatic)	2X (numerical aperture: 0.05)	4X (numerical aperture: 0.1)	5X (numerical aperture: 0.12)	10X (numerical aperture: 0.25)
Working distance	17.2mm	18mm	17.6mm	7mm
Graduation	0.05mm	0.025mm	0.02mm	0.01mm
Viewing field	Ø9mm	Ø4.5mm	Ø3.6mm	Ø1.8mm
Focus range	30mm			
Illumination	LED light			
Diameter of base	Ø63mm			
Height	210mm			
Weight	650g			

### STANDARD DELIVERY

Main unit	1 pc
Pen light	1 pc
Battery (AAA)	2 pcs

## TABLE MAGNIFIER WITH ILLUMINATION CODE 7517-3D

- Four steps brightness adjustment
- LED illumination, working life 20000h
- Resin lens

### SPECIFICATION

<b>Magnification</b>	1.75X
<b>Diopter</b>	3D
<b>Lens diameter</b>	Ø125mm
<b>Illumination</b>	power: 3W, illumination: 260lm
<b>Power supply</b>	power adapter 12V, 1A



## TABLE MAGNIFIERS WITH ILLUMINATION

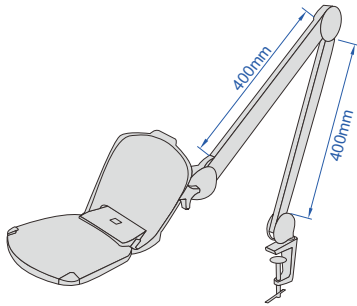

- LED illumination, working life 20000h
- Resin lens

### SPECIFICATION

Code	7520-320D	7521-3D
<b>Magnification</b>	two magnifications 1.75X/6X	1.75X
<b>Diopter</b>	3D/20D	3D
<b>Lens dimension</b>	160×127mm	Ø126mm
<b>Illumination</b>	power: 6W, illumination: 550lm	
<b>Power supply</b>	power adapter 12V, 1A	



## TABLE MAGNIFIER WITH ILLUMINATION CODE 7516-5D

- LED illumination, working life 20000h

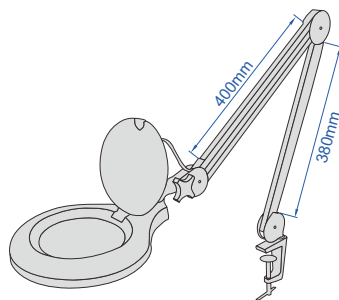

### SPECIFICATION

<b>Magnification</b>	2.25X
<b>Diopter</b>	5D
<b>Lens diameter</b>	Ø122mm
<b>Illumination</b>	power: 7W, illumination: 420lm
<b>Power supply</b>	100~240V, 50~60Hz





## DIGITAL MAGNIFIER CODE 7525-D4



- 720P60 camera
- Auto focus
- With screen freezing function
- 26 color modes can be switched to meet the needs of different people
- Port to TV
- Automatic shutdown after 3 minutes

after the handle is folded, the magnifier can be directly placed on the object for observation



### SPECIFICATION

Screen size	4.3 inch
Screen resolution	480x272
Magnification	2X-32X
Pixel	8M
Focus	manual/automatic
Color mode (26 modes)	color mode, color enhancement mode, negative mode, monochrome mode, black on white, white on black, blue on white, white on blue, yellow on black, black on yellow, yellow on blue, blue on yellow, green on white, white on green, orange on white, white on orange, red on black, black on red, orange on black, black on orange, yellow on green, green on yellow, red on white, white on red, yellow on white, white on yellow
Output	TV
Charging port	Type-C
Lithium battery	1600mAH (for 4 hours working)
Dimension (LxWxH)	123x39x76mm (when the handle is folded)
Weight	210g

side and back

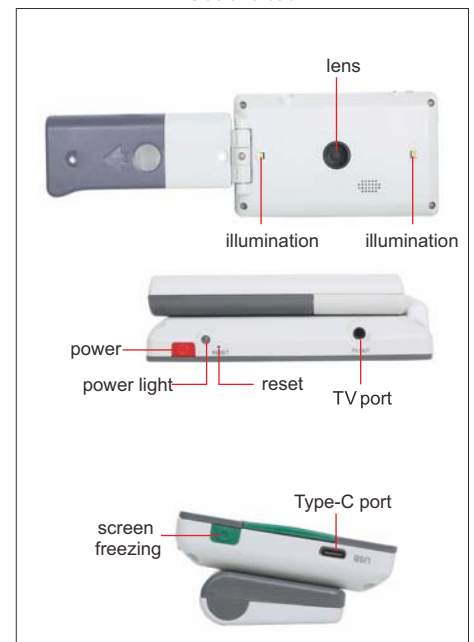

### STANDARD DELIVERY

Main unit	1 pc
Video output cable	1 pc
USB charging cable	1 pc
Power adapter	1 pc

# DIGITAL MAGNIFIER CODE 7526-D5



- 720P60 (close view) and 1080P30 (far view) cameras
- Double autofocus
- 26 color modes can be switched to meet the needs of different people
- Adopt folding bracket
- Detachable handle design, suitable for left-handed or right-handed use
- TV and HDMI ports to TV and display
- Automatic shutdown after 3 minutes

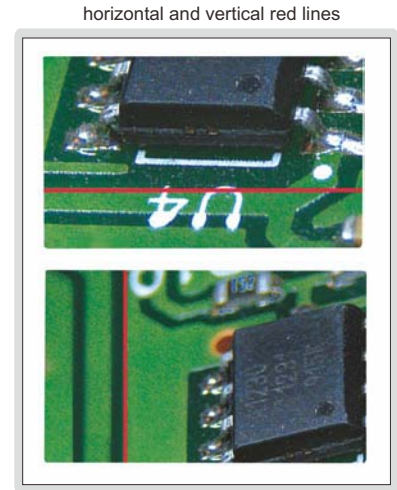

## SPECIFICATION

Screen size	5 inch
Screen resolution	800x480
Magnification	2X-32X
Close view pixel	8M
Far view pixel	8M
Focus	manual/automatic
Color mode (26 modes)	color mode, color enhancement mode, negative mode, monochrome mode, black on white, white on black, blue on white, white on blue, yellow on black, black on yellow, yellow on blue, blue on yellow, green on white, white on green, orange on white, white on orange, red on black, black on red, orange on black, black on orange, yellow on green, green on yellow, red on white, white on red, yellow on white, white on yellow
Line	horizontal and vertical red lines
Function	screen freezing, image moving, photo playback, and high definition storage
Output	TV and HDMI
Storage	supports up to 32G TF card
Charging port	Type-C
Lithium battery	2500mAH (for 4 hours working)
Dimension (LxWxH)	145x30x85mm (when the handle is folded)
Weight	275g

after the handle is folded, the magnifier can be directly placed on the object for observation



side and back

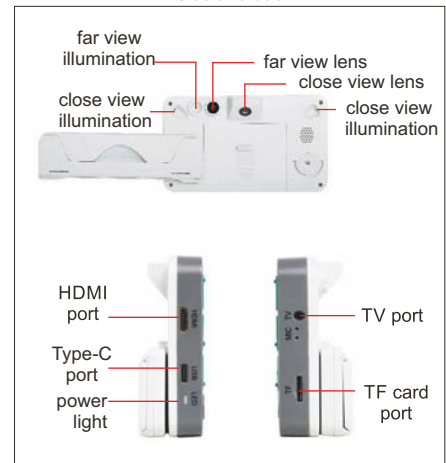

## STANDARD DELIVERY

Main unit	1 pc
HDMI cable	1 pc
Video output cable	1 pc
USB charging cable	1 pc
Power adapter	1 pc

## FOLDING MAGNIFIER

- Glass lens



7511-8

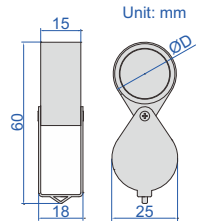

Code	Magnification	Lens diameter (ØD)
7511-8	10X	Ø21mm

## FOLDING MAGNIFIER WITH ILLUMINATION

- Resin lens
- Powered by 3xLR927 batteries (included)



2 pcs  
LED



7515-10

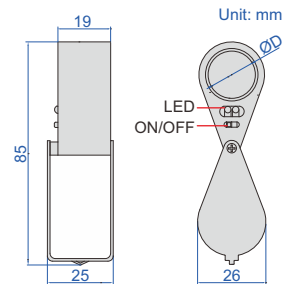

Code	Magnification	Lens diameter (ØD)
7515-10	10X	Ø21mm

## FOLDING MAGNIFIER WITH ILLUMINATION

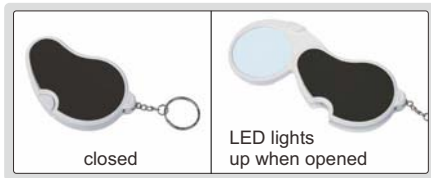

closed

LED lights  
up when opened

- Resin lens
- Powered by 2xCR1620 batteries (included)
- LED lights up automatically when opened



7514-1

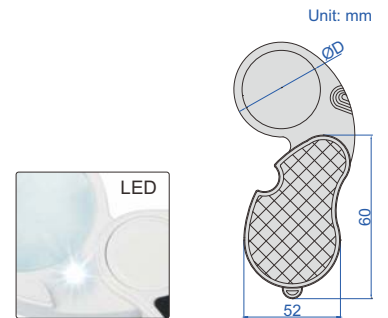

Code	Magnification	Lens diameter (ØD)
7514-1	2.5X	Ø45mm

## MAGNIFIER WITH ILLUMINATION

- Glass lens
- Powered by 3xAG7 batteries
- 3 pcs LED and 3 pcs UV
- Base with scale, graduation: 0.5mm, 1/16"

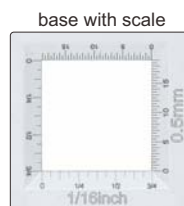

base with scale



rotate lens to adjust focus

ON/OFF

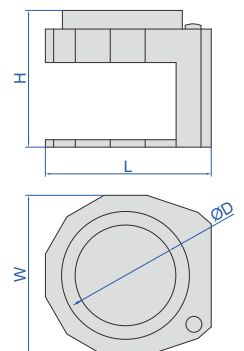

Code	Magnification	Lens diameter (ØD)	L	H	W
7524-10	10X	Ø30mm	60mm	50mm	56mm

7524-10

## MEASURING MAGNIFIERS (WITH ILLUMINATION)

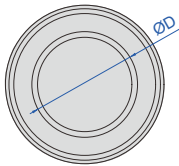
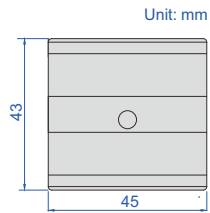

7527-D1

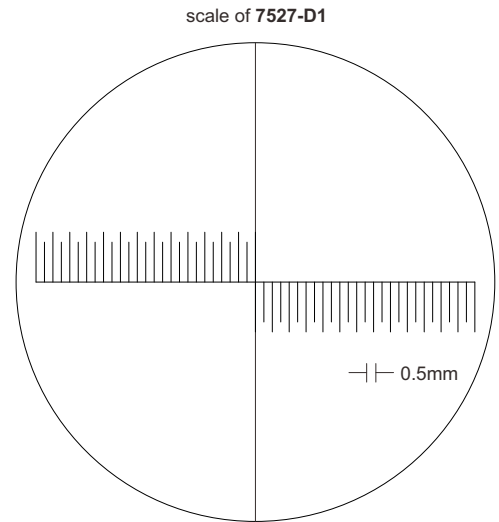

scale of 7527-D2  
(0-5mm graduation: 0.1mm, 5-10mm graduation: 0.5mm)

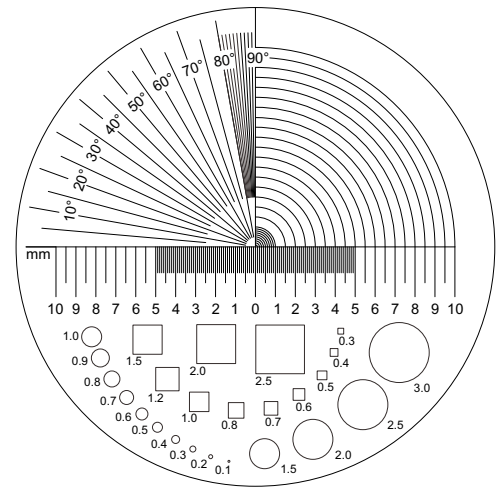

base with scale



- Base with scale
- With 5 white LED and 5 UV LED
- Charging port: Type-C
- Work for 1.5h after fully charged

Code	Magnification	Lens diameter (ØD)
7527-D1	10X	Ø30mm
7527-D2	10X	Ø30mm

## MAGNIFIER WITH ILLUMINATION

- Glass lens
- With 4 white LED, three levels brightness adjustment
- Charging port: Type-C



7528-3

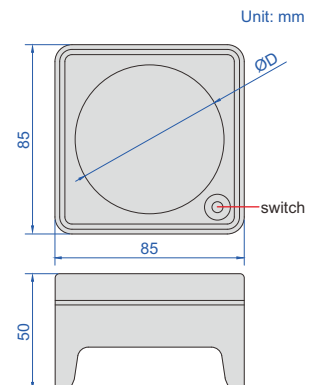

Code	Magnification	Lens diameter (ØD)
7528-3	3X	Ø70mm



## MAGNIFIERS WITH ILLUMINATION



- Glass lens
- Powered by 3xAAA batteries (included)



7513-2

7513-4

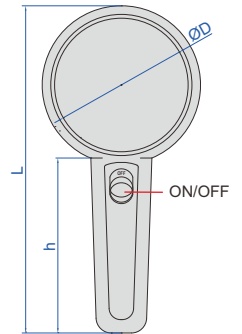

Code	Magnification	Lens diameter (ØD)	L	h
7513-2	2X	Ø75mm	170mm	90mm
7513-4	4X	Ø50mm	145mm	90mm

## MAGNIFIER WITH ILLUMINATION

- Resin lens
- With 20 white LED, three levels brightness adjustment
- Charging port: Type-C



7529-24

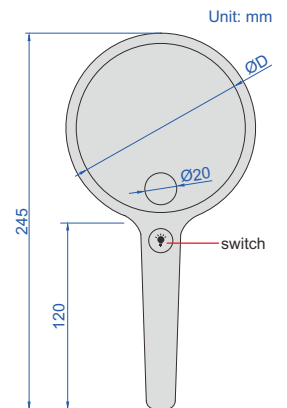

Code	Magnification	Lens diameter (ØD)
7529-24	2X/4X	Ø105mm

## MAGNIFIER WITH TWO LENSES

- Resin lens
- Interchangeable lenses
- Powered by 3 pcs AAA batteries (included)



7522-610

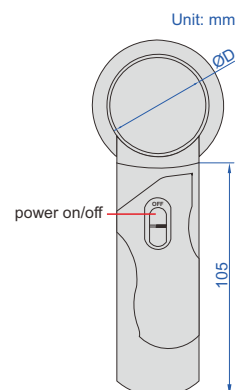

Code	Lens number	Magnification	Lens diameter (ØD)
7522-610	2 pcs	6X	50mm
		10X	37mm

### THREE WAYS MAGNIFIER WITH ILLUMINATION



three ways use



7512-1

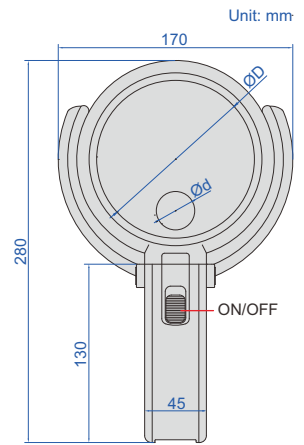

- Resin lens
- Powered by 2xAA batteries (included) or power adapter (110~240V, 50~60Hz)

Code	Magnification	Lens diameter (ØD/Ød)
7512-1	2X/4X	Ø120mm/Ø28mm

### MAGNIFICATION GLASSES



7523-3D5

- Resin lens
- Interchangeable lenses
- Powered by 3 pcs AAA batteries (included)

interchangeable lenses



adjustable lens and LED angle

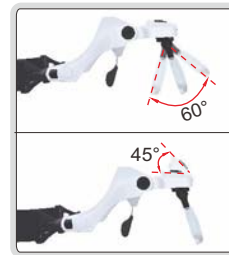

head band (included)



adjustable holder angle



moveable lens for focus



2 pcs LED



Code	Lens number	Magnification
7523-3D5	5 pcs	1X
		1.5X
		2X
		2.5X
		3.5X

MAGNIFIER

using on table



hanging around neck



- Resin lens
- Silicone hose can be shaped according to needs
- Can be used on table or hanging around neck



7530-1D8

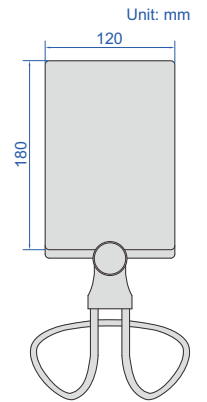

Code	Magnification	Lens size
7530-1D8	1.8X	180x120mm

TELESCOPING INSPECTION MIRRORS

- Inspect hidden areas
- Rotation of the mirror: 360°
- Length of handle is adjustable, handle is made of stainless steel

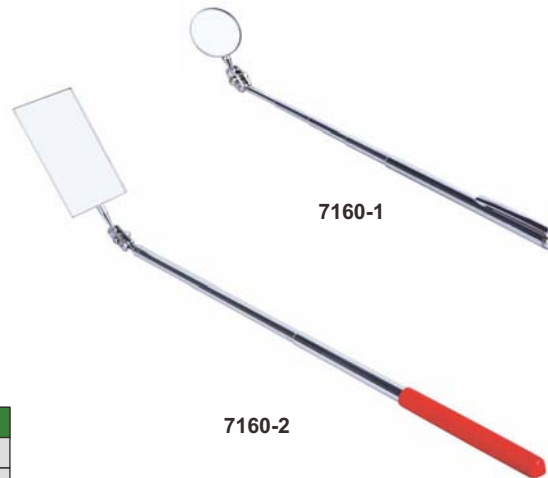

7160-1

7160-2

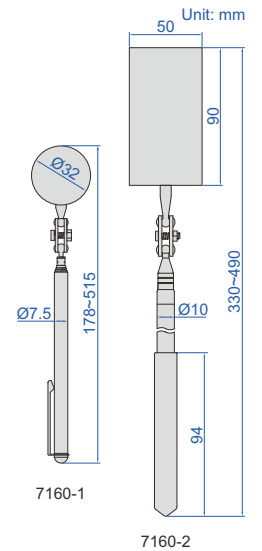

Code	Size of mirror	Length
7160-1	Ø32mm	178~515mm
7160-2	50x90mm	330~490mm

TELESCOPING INSPECTION MIRROR (WITH ILLUMINATION)

- Inspect hidden areas
- Head can bend and rotate
- Telescoping handle, made of stainless steel
- With two CR2032 batteries

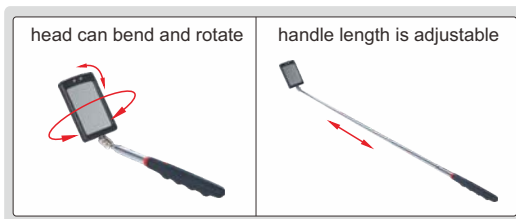

7162-1

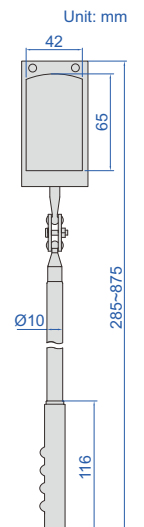

Code	Size of mirror	Length
7162-1	65x42mm	285~875mm

## TELESCOPING MAGNETIC PICK-UP AND FLASHLIGHT

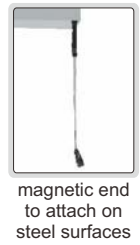

- For illumination and pick up steel parts in hidden areas
- Head can bend
- Telescoping handle, made of stainless steel
- Magnetic head and end
- With four LR44 batteries

7163-1

Code	Magnetic force of the end	Magnetic force of the head	Flashlight range	Battery life	Length
7163-1	4kgf	2kgf	3m	8h	172~568mm

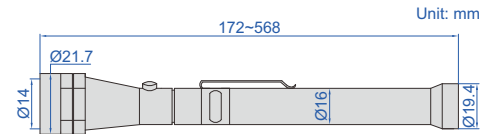

## FLEXIBLE PICK-UP AND FLASHLIGHT

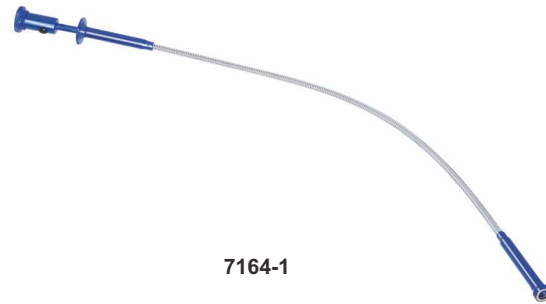
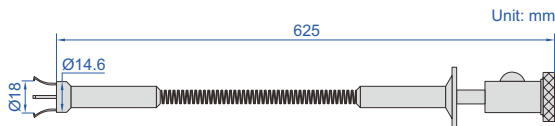

7164-1

- For illumination and pick up steel parts in hidden areas
- Flexible spring rod, made of stainless steel
- Three LR44 batteries

Code	Magnetic force	Flashlight range	Battery life
7164-1	0.9kgf	1m	24h

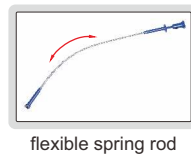

## TELESCOPING MAGNETIC PICK-UP

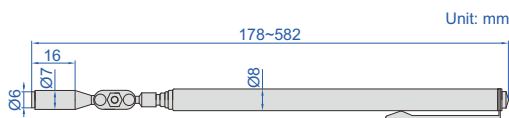

7161-1

- Pick up steel parts from hidden areas
- Rotation of magnetic head: 360°
- Length of handle is adjustable, handle is made of stainless steel

Code	Size of magnetic tip	Magnetic force	Length
7161-1	Ø6mm	0.45kgf	178~582mm



Videoscopes  
Page 670-682



Pipe Videoscopes  
Page 683



Rigid Borescopes  
Page 684

## VIDEOSCOPE (DESK TYPE)

REAR FIBER ILLUMINATION

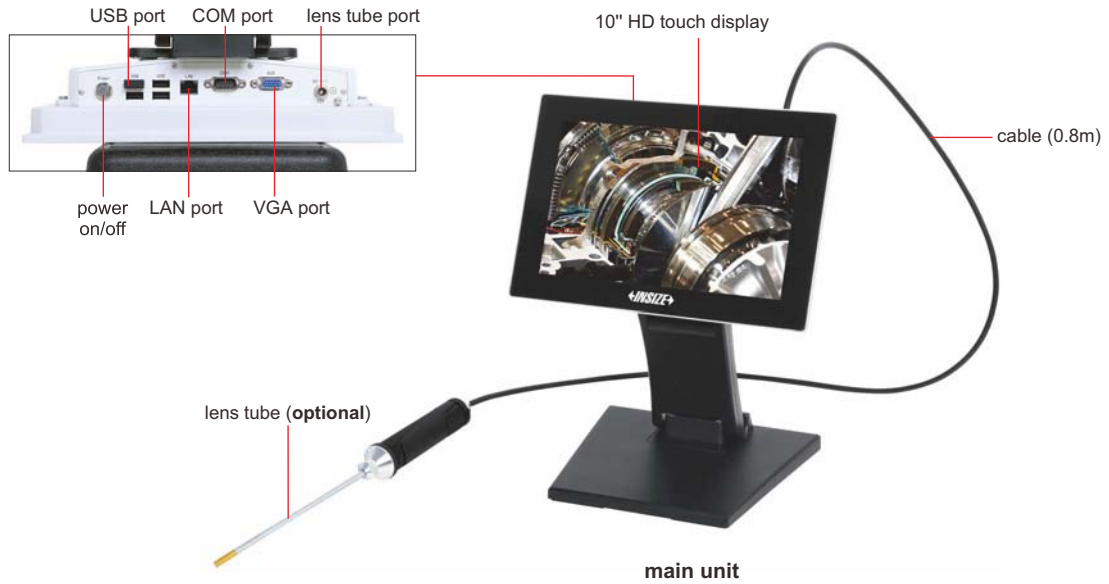

### MAIN UNIT (WITHOUT LENS TUBE)

Code	ISV-Y
Display	10" HD touch display
Function	take picture, take video
File format	picture: JPG, video: MP4
Memory	built-in hard disk or USB flash disk
Image process	image zoom (1X, 2X, 3X)
Image control	noise reduction, negative film, flip over, freeze, on-line edit
Illumination	stepless adjustment
Additional function	real-time dynamic annotation, real-time watermark, rapid defect mark
Output	USB, HDMI
Power supply	AC/DC adapter (for continuous working)
Weight	1000g

### STANDARD DELIVERY

Main unit	1 pc
USB disk	1 pc
Mouse	1 pc
AC/DC adapter	1 pc

### OPTIONAL ACCESSORY

Lens tube	refer to below details
Software for automatic defect identification	can be customized

26

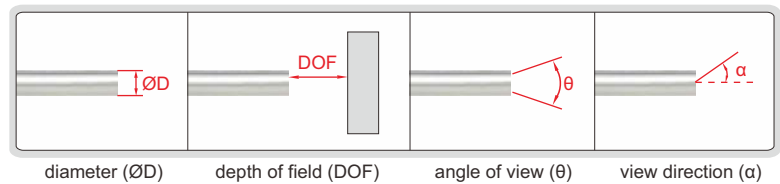

### RIGID STRAIGHT LENS TUBE, FRONT VIEW

Code	Lens tube			Lens				
	diameter (ØD)	length (L)	pixel	illumination	angle of view (θ)	depth of field (DOF)	view direction (α)	dust/ waterproof
ISV-Y1210	1.2mm	90mm	0.04M	rear optical fiber	120°	3~70mm	0°	IP67
ISV-Y1810	1.8mm	120mm (optional 90-150mm)	0.16M			3~70mm	0°	
ISV-Y2010	2.0mm	120mm (optional 90-150mm)	0.16M			3~70mm	0°	
ISV-Y2410	2.4mm	150mm (optional 90-300mm)	0.16M			3~70mm	0°	
ISV-Y2810	2.8mm	150mm (optional 90-300mm)	0.16M			3~70mm	0°	
ISV-Y3910	3.9mm	200mm (optional 90-500mm)	1M			8~150mm	0° (optional 30°, 70°)	
ISV-Y6010	6.0mm	300mm (optional 90-1000mm)	1M			12~200mm	0° (optional 30°, 70°)	

To be continued

Continued from previous page

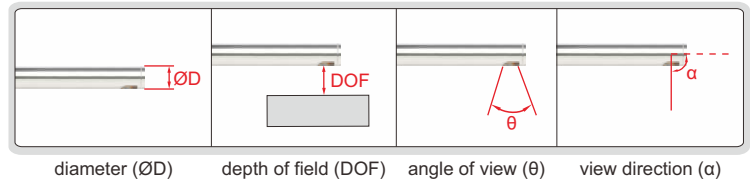

**RIGID STRAIGHT LENS TUBE, SIDE VIEW**

Code	Lens tube		Lens					
	diameter (ØD)	length (L)	pixel	illumination	angle of view (θ)	depth of field (DOF)	view direction (α)	dust/ waterproof
ISV-Y2810C	2.8mm	150mm (optional 90-300mm)	0.16M	rear optical fiber	120°	3~70mm	90°	IP67
ISV-Y3910C	3.9mm	200mm (optional 90-500mm)	1M			8~150mm		
ISV-Y4510C	4.5mm	250mm (optional 90-800mm)	1M			8~150mm		
ISV-Y6010C	6.0mm	300mm (optional 90-1000mm)	1M			12~200mm		

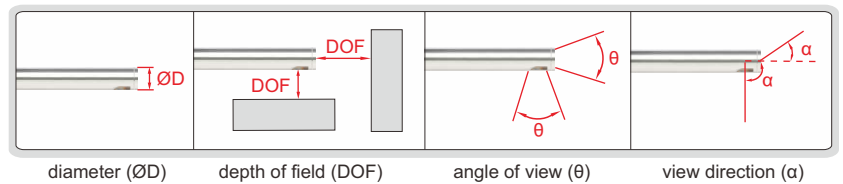

**RIGID STRAIGHT LENS TUBE, FRONT VIEW & SIDE VIEW**

Code	Lens tube		Lens					
	diameter (ØD)	length (L)	pixel	illumination	angle of view (θ)	depth of field (DOF)	view direction (α)	dust/ waterproof
ISV-Y6010S	6.0mm	300mm (optional 90-1000mm)	1M	rear optical fiber	120°	front view: 12~200mm side view: 8~150mm	front view: 0° side view: 90°	IP67

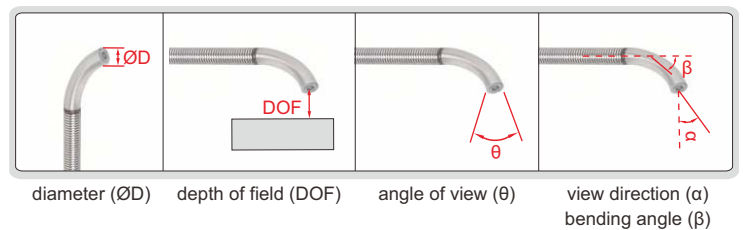

**BENDING SPRING LENS TUBE**

Code	Lens tube		Lens						
	diameter (ØD)	length (L)	pixel	illumination	angle of view (θ)	depth of field (DOF)	view direction (α)	bending angle (β)	dust/ waterproof
ISV-Y3010W	3.0mm	1000mm	0.16M	rear optical fiber	120°	8~150mm	0°	75° (can be customized)	IP65
ISV-Y5010W	5.0mm		1M			8~150mm			
ISV-Y7010W	7.0mm		1M			12~200mm			

## VIDEOSCOPE

REAR FIBER ILLUMINATION

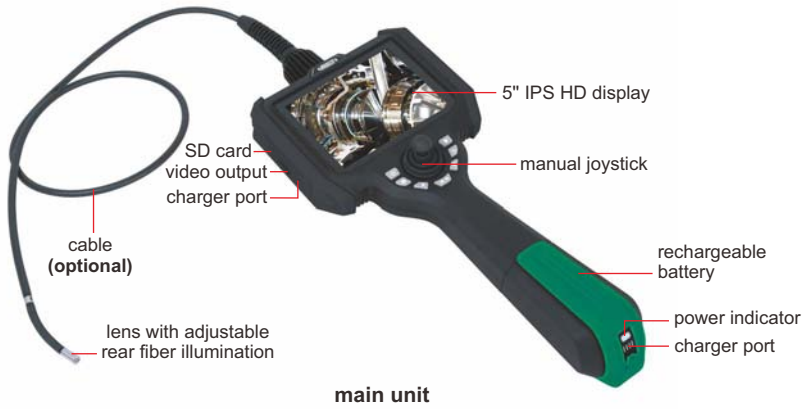

main unit



changeable lens cable



tripod (included)



ISV-L-HOOK (optional)



ISV-L-MAGNET (optional)

### MAIN UNIT (WITHOUT CABLE)

<b>Code</b>	ISV-L
<b>Display</b>	5" high definition LCD
<b>Resolution</b>	1024×720
<b>Function</b>	take pictures, take videos
<b>File format</b>	picture: JPG, video: MP4
<b>Image process</b>	image zoom (1X, 2X, 3X, 4X)
<b>Image control</b>	freeze, flip over, playback and analog ruler
<b>Memory</b>	memory card
<b>Output</b>	USB, HDMI
<b>Power supply</b>	rechargeable lithium battery (working time ≥ 4hours) AC/DC adapter (for continuous working)
<b>Weight</b>	1000g



ISV-L-CLAMP (optional)

### OPERATION ENVIRONMENT

<b>Main unit</b>	-10~50°C, no preheat
<b>Operation temperature</b>	-20~70°C
<b>Storage temperature</b>	-20~60°C
<b>Relative humidity</b>	maximum 90%, no condensation

### STANDARD DELIEVERY

<b>Main unit</b>	1 pc
<b>32G SD card</b>	1 pc
<b>Card reader</b>	1 pc
<b>USB cable</b>	1 pc
<b>Tripod</b>	1 pc
<b>AC/DC adapter</b>	1 pc

### OPTIONAL ACCESSORY

<b>Cable</b>	please refer to details
<b>WIFI output</b>	ISV-L-WIFI (must be installed in factory, only for Android OS)
<b>Temperature alarm</b>	ISV-L-HTALARM (must be installed in factory, for Ø3.9mm, Ø4.5mm and Ø6.0mm)
<b>Hook</b>	ISV-L-HOOK (must be installed in factory, for Ø3.9mm, Ø4.5mm and Ø6.0mm)
<b>Magnet</b>	ISV-L-MAGNET (must be installed in factory, for Ø3.9mm, Ø4.5mm and Ø6.0mm)
<b>Clamp</b>	ISV-L-CLAMP

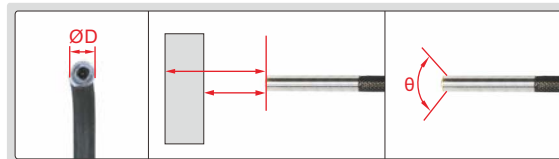

diameter (ØD)      depth of field (DOF)      angle of view (θ)

### ONE-DIRECTION CABLE (NO BENDING), FRONT VIEW

Code	Cable		Lens							
	length	type	view direction	diameter (ØD)	depth of field (DOF)	angle of view (θ)	illumination	pixel	resolution	dust/ waterproof
ISV-L09505	0.5m	spring tube	front view	0.95mm	3~30mm	>120°	rear fiber	0.16M	400×400	IP65
ISV-L09510	1m			1.2mm	3~30mm					
ISV-L1210	1m			1.5mm	3~70mm					
ISV-L1510	1m	tungsten wire weaved cable		1.5mm	3~70mm					
ISV-L1515	1.5m									

To be continued



Continued from previous page

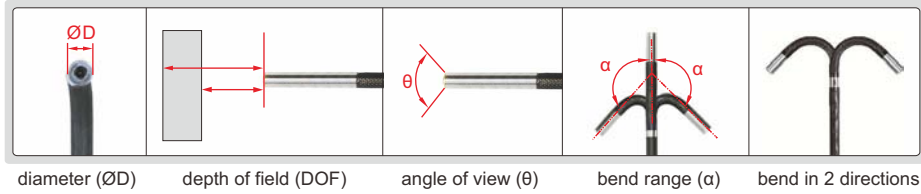

**TWO-DIRECTION BENDING CABLE, FRONT VIEW**

Code	Cable		Lens									
	length	type	view direction	bend direction	diameter (ØD)	depth of field (DOF)	bend range (α)	angle of view (θ)	illumination	pixel	resolution	dust/ waterproof
ISV-L1810	1m	tungsten wire weaved cable	front view	two directions	1.8mm	3~30mm	±160°	>120°	rear fiber	0.16M	400×400	IP65
ISV-L2010	1m				2.0mm	3~30mm						
ISV-L2410	1m				2.4mm	3~70mm (optional 5~100mm)						
ISV-L2415	1.5m											
ISV-L2420	2m											

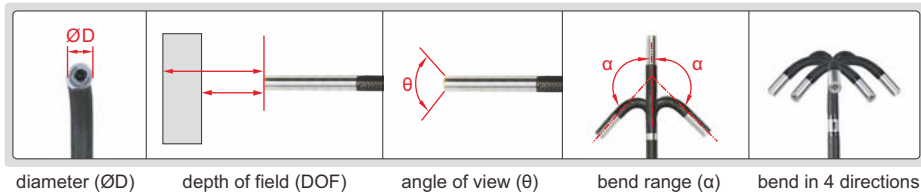

**FOUR-DIRECTION BENDING CABLE, FRONT VIEW**

Code	Cable		Lens									
	length	type	view direction	bend direction	diameter (ØD)	depth of field (DOF)	bend range (α)	angle of view (θ)	illumination	pixel	resolution	dust/ waterproof
ISV-L2810	1m	tungsten wire weaved cable	front view	four directions	2.8mm	3~70mm (optional 5~100mm)	±160°	>120°	rear fiber	0.16M	400×400	IP65
ISV-L2815	1.5m											
ISV-L2820	2m											
ISV-L2830	3m				3.9mm	8~150mm (optional 3~70mm)				0.92M	1280×720	IP67
ISV-L3910	1m											
ISV-L3915	1.5m											
ISV-L3920	2m				6.0mm	12~200mm (optional 3~70mm, 8~150mm)				0.92M	1280×720	IP67
ISV-L3930	3m											
ISV-L3940	4m											
ISV-L3950	5m											
ISV-L6010	1m											
ISV-L6015	1.5m											
ISV-L6020	2m											
ISV-L6030	3m											
ISV-L6040	4m											
ISV-L6050	5m											
ISV-L6060	6m											
ISV-L6070	7m											

To be continued

Continued from previous page

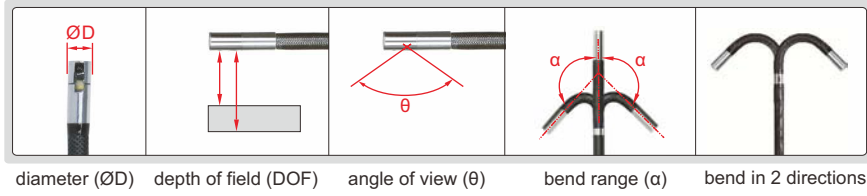

**TWO-DIRECTION BENDING CABLE, SIDE VIEW**

Code	Cable		Lens									
	length	type	view direction	bend direction	diameter ( $\varnothing D$ )	depth of field (DOF)	bend range ( $\alpha$ )	angle of view ( $\theta$ )	illumination	pixel	resolution	dust/ waterproof
ISV-L1810C	1m	tungsten wire weaved cable	side view	two directions	1.8mm	3~30mm	$\pm 160^\circ$	$> 120^\circ$	rear fiber	0.16M	400×400	IP65
ISV-L1815C	1.5m											

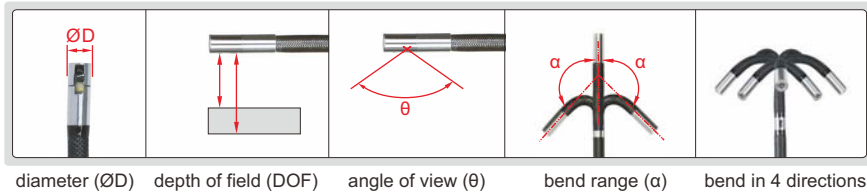

26

**FOUR-DIRECTION BENDING CABLE, SIDE VIEW**

Code	Cable		Lens									
	length	type	view direction	bend direction	diameter ( $\varnothing D$ )	depth of field (DOF)	bend range ( $\alpha$ )	angle of view ( $\theta$ )	illumination	pixel	resolution	dust/ waterproof
ISV-L2810C	1m	tungsten wire weaved cable	side view	four directions	2.8mm	3~70mm	$\pm 160^\circ$	$> 120^\circ$	rear fiber	0.16M	400×400	IP65
ISV-L2815C	1.5m											
ISV-L2820C	2m											
ISV-L2830C	3m				4.5mm	5~100mm (optional 8~150mm)						
ISV-L4510C	1m											
ISV-L4515C	1.5m											
ISV-L4520C	2m				6.0mm	8~150mm (optional 5~100mm)				0.92M	960×720	IP67
ISV-L4530C	3m											
ISV-L6010C	1m											
ISV-L6015C	1.5m											
ISV-L6020C	2m											
ISV-L6030C	3m											
ISV-L6040C	4m											
ISV-L6050C	5m											

## FRONT AND SIDE VIEW VIDEOSCOPE

REAR FIBER ILLUMINATION

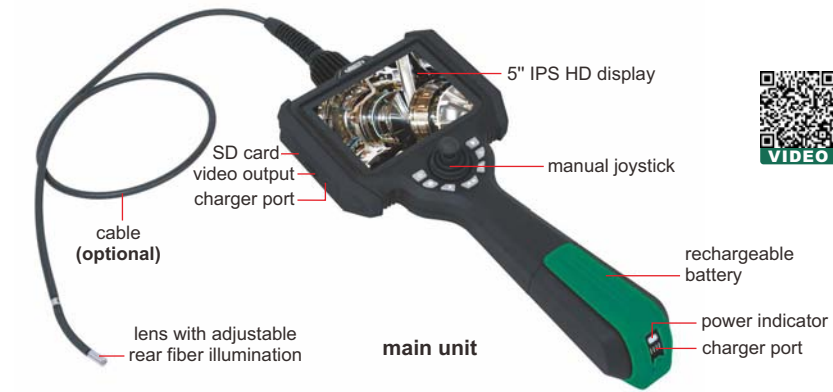

### MAIN UNIT (WITHOUT CABLE)

Code	ISV-S
Display	5" high definition LCD
Resolution	1024×720
Function	take pictures, take videos
File format	picture: JPG, video: MP4
Image process	image zoom (1X, 2X, 3X, 4X)
Image control	freeze, flip over, playback and analog ruler
Memory	memory card
Output	USB, HDMI
Power supply	rechargeable lithium battery (working time ≥ 4hours) AC/DC adapter (for continuous working)
Weight	1000g



changeable lens cable



tripod (included)

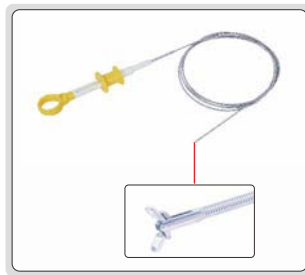

ISV-S-CLAMP (optional)



ISV-S-HOOK (optional)



ISV-S-MAGNET (optional)

### STANDARD DELIEVERY

Main unit	1 pc
32G SD card	1 pc
Card reader	1 pc
USB cable	1 pc
Tripod	1 pc
AC/DC adapter	1 pc

### OPTIONAL ACCESSORY

Cable	please refer to details
WIFI output	ISV-S-WIFI (must be installed in factory, only for Android OS)
Temperature alarm	ISV-S-HTALARM (must be installed in factory)
Hook	ISV-S-HOOK (must be installed in factory)
Magnet	ISV-S-MAGNET (must be installed in factory)
Clamp	ISV-S-CLAMP

### OPERATION ENVIRONMENT

Main unit	-10~50°C, no preheat
Operation temperature	-20~70°C
Storage temperature	-20~60°C
Relative humidity	maximum 90%, no condensation

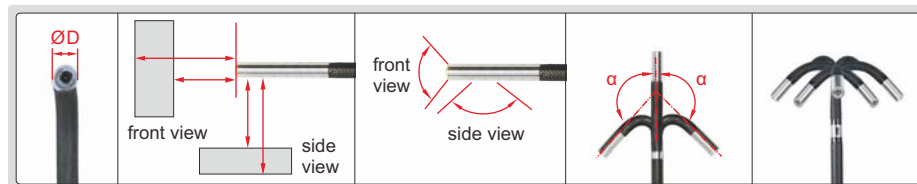

diameter (ØD) depth of field (DOF) angle of view (θ) bend range (α) bend in 4 directions

### FOUR-DIRECTION BENDING CABLE, FRONT VIEW&SIDE VIEW

Code	Cable		Lens									
	length	type	view direction	bend direction	diameter (ØD)	depth of field (DOF)	bend range (α)	angle of view (θ)	illumination	pixel	resolution	dust/ waterproof
ISV-S6010	1m	tungsten wire weaved cable	front view and side view	four directions	6.0mm	front view: 12~200mm (optional 3~70mm) side view: 8~150mm (optional 3~70mm)	±160°	>120°	rear fiber	0.92M	1280×720	IP67
ISV-S6015	1.5m											
ISV-S6020	2m											
ISV-S6030	3m											
ISV-S6040	4m											
ISV-S6050	5m											

## VIDEOSCOPIES

REAR FIBER ILLUMINATION

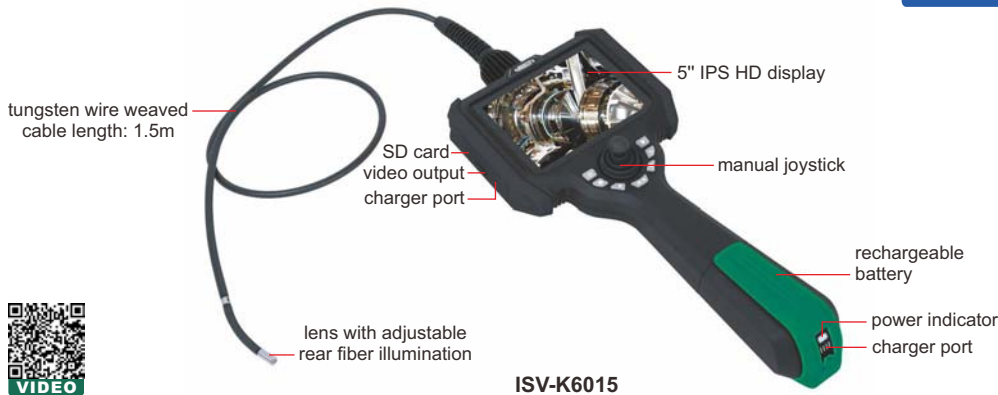

ISV-K6015



changeable lens cable

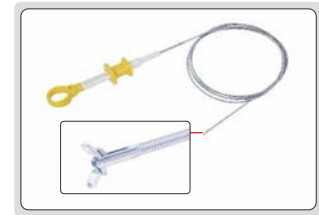

ISV-K-CLAMP (optional)



ISV-K-HOOK (optional)



ISV-K-MAGNET (optional)

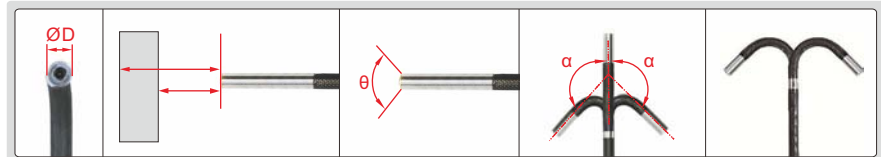

diameter (ØD)

depth of field (DOF)

angle of view (θ)

bend range (α)

bend

### SPECIFICATION

Code		ISV-K1810	ISV-K2410	ISV-K2810	ISV-K3915	ISV-K6015
Lens	diameter (ØD)	1.8mm	2.4mm	2.8mm	3.9mm	6.0mm
	pixel	0.16M			0.92M	
	resolution	400×400			1280×720	
	depth of field	3-30mm	3-70mm	3-70mm	8-150mm	12-200mm
	bending direction	two directions	two directions	four directions	four directions	four directions
	bending range (α)	±160°				
	angle of view (θ)	120°				
	illumination	rear fiber				
	lens	sapphire glass lens				
	dust/waterproof	IP65			IP67	
Cable	bend control	manual joystick				
	length	1m	1m	1m	1.5m	1.5m
Main unit	type	tungsten wire weaved cable				
	display	5" high definition LCD				
	function	take pictures, take videos				
	file format	picture: JPG, video: MP4				
	image process	image zoom (1X, 2X, 3X, 4X)				
	image control	freeze, flip over, playback and analog ruler				
	memory	memory card				
	output	USB, HDMI				
power supply	rechargeable lithium battery (working time ≥ 4 hours), AC/DC adapter (for continuous working)					
Weight	1000g					

### STANDARD DELIEVERY

Main unit	1 pc
32G SD card	1 pc
Card reader	1 pc
USB cable	1 pc
Tripod	1 pc
AC/DC adapter	1 pc

### OPERATION ENVIRONMENT

Main unit	-10~50°C, no preheat
Operation temperature	-20~70°C
Storage temperature	-20~60°C
Relative humidity	maximum 90%, no condensation

### OPTIONAL ACCESSORY

WIFI output	ISV-K-WIFI (must be installed in factory, only for Android OS)
Temperature alarm	ISV-K-HTALARM (must be installed in factory, for ISV-K3915 and ISV-K6015)
Hook	ISV-K-HOOK (must be installed in factory, for ISV-K3915 and ISV-K6015)
Magnet	ISV-K-MAGNET (must be installed in factory, for ISV-K3915 and ISV-K6015)
Clamp	ISV-K-CLAMP



## MOBILE PHONE VIDEOSCOPE CODE ISV-P6



the clamping range of mobile phone bracket L=56-95mm

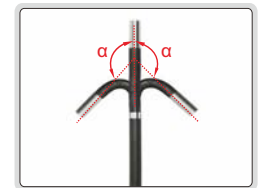

bending of lens up to 180°

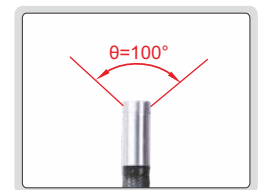

angle of view

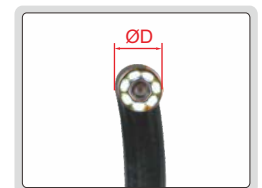

lens with LED



bend in any direction

- For Android and IOS mobile phones

### SPECIFICATION

Diameter of lens (ØD)	6±0.2mm
Length of cable	1m
Resolution	960×720, 1280×720 (switchable)
Depth of field	20mm~∞
Angle of view (θ)	100°
Bending range (α)	0~180°
Illumination	LED with 3 levels control
Cable type	wear resistant
Interface	USB, Type-C
Mobile phone system	Android, IOS
Power supply	rechargeable battery (for 2 hours working)
Dimension (L×W×H)	195×57×105mm
Weight	450g

### STANDARD DELIVERY

Main unit (with cable)	1 pc
Type-C cable	1 pc
Micro USB cable	1 pc
Iphone cable	1 pc
Charging cable	1 pc

## VIDEOSCOPIES (BASIC TYPE)

TUNGSTEN WIRE WEAVED CABLE  
BREAK AND WEAR RESISTANCE



ISV-S106

### SPECIFICATION

Code		ISV-T105	ISV-S106
Lens	diameter (ØD)	6mm	
	pixel	1M	
	resolution	1280×720	
	depth of field	20~150mm	
	bending direction	360°	
	bending range (α)	0°~220°	
	angle of view (θ)	120°	
	illumination	7 pcs LED, with 6 levels control	
	illuminance	25000 Lux	
	lens	sapphire glass lens	
	dust/waterproof	IP67	
	bend control	manual joystick	
Cable	length	1m	1.5m
	type	tungsten wire weaved cable	
Main unit	display	3.5" IPS full-view display	
	display resolution	640×480	
	function	take pictures, take videos	
	file format	picture: JPG, video: MP4	
	image process	image zoom (1X, 2X, 3X, 4X, 5X)	
	memory	memory card (Maximum: 64G)	
	output	USB, HDMI, WIFI (optional)	
	dust/waterproof	IP65	
power supply	rechargeable lithium battery (working time ≥ 3 hours; optional: additional battery, working time ≥ 9 hours) AC/DC adapter (for continuous working)		
Weight	1000g		

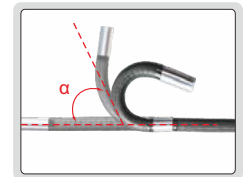

220° bending angle

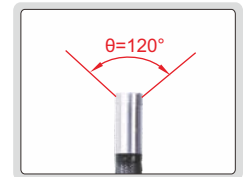

120° view angle



LED 6 levels control



360° bending direction

26

### STANDARD DELIVERY

Main unit (with cable & lens)	1 pc
16G SD card	1 pc
Card reader	1 pc
USB cable	1 pc
Battery	1 pc
AC/DC adapter	1 pc

### OPTIONAL ACCESSORY

Additional battery	ISV-S106-BATTERY (must be installed in factory)
WIFI output	ISV-S106-WIFI
Temperature alarm	ISV-S106-HT-ALARM

MEMORY CABLE CAN BE FIXED AT ANY SHAPE

**IP67**  
WATERPROOF

**VIDEOSCOPE (BASIC TYPE)**  
**CODE ISV-E40**



magnet pick up (included)



hook (included)



45° mirror (included)

**SPECIFICATION**

<b>Lens</b>	diameter (ØD)	8mm
	pixel	0.92M
	resolution	1280x720
	depth of field	30~80mm
	angle of view	77°
	illumination	3 levels
	dust/waterproof	IP67
<b>Cable</b>	length	1180mm
	type	memory (can be set at any shape)
<b>Main unit</b>	display	5" IPS LCD
	function	take picture, take video
	file format	picture: JPG, video: MOV
	image process	image zoom (1.5X, 2X, 3X, 4X)
	memory	memory card (optional)
	output	Type-C
	power supply	rechargeable lithium battery (for 5 hours working)
dimension	217×155×131mm	
<b>Weight</b>		506g

**STANDARD DELIVERY**

Main unit	1 pc
45° mirror	1 pc
Hook	1 pc
Magnet pick up	1 pc

**OPTIONAL ACCESSORY**

32G memory card	ISV-E40-CARD
Card reader	ISV-E40-READER

**OPERATION ENVIRONMENT**

Operation temperature	-10~50°C
Storage temperature	-20~60°C
Operation humidity	15%~85%

# VIDEOSCOPE (ECONOMIC TYPE) CODE ISV-E30

MEMORY CABLE CAN  
BE FIXED AT ANY SHAPE

**IP67**  
WATERPROOF

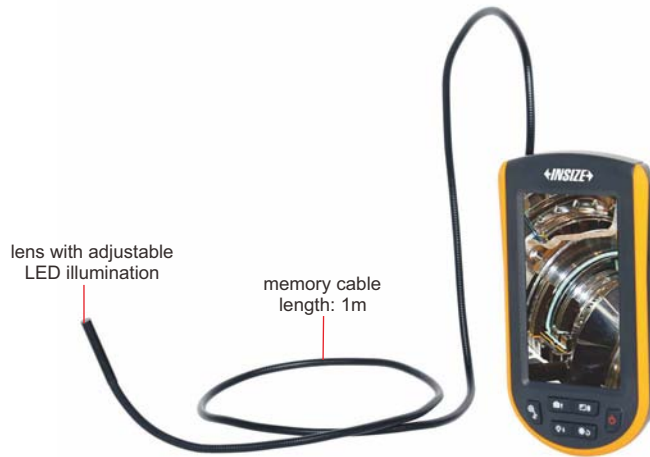

magnet pick up (included)



hook (included)



cable can be wrapped around  
the main unit

26

## SPECIFICATION

Lens	diameter	5.2mm
	pixel	0.4M
	depth of field	30~80mm
	angle of view	72°
	illumination	8 levels
Cable	dust/waterproof	IP67
	length	1m
	type	memory (can be set at any shape)
Main unit	display	4.3" LCD
	function	take picture, take video
	file format	picture: JPG, video: AVI
	image zoom	2X
	memory card	memory card (optional)
	output	micro USB
	power supply	AA battery
dimension	154×32.5×87.5mm	
Weight		280g

## STANDARD DELIVERY

Main unit	1 pc
Hook	1 pc
Magnet pick up	1 pc
AA battery	4 pcs

## OPTIONAL ACCESSORY

32G memory card	ISV-E40-CARD
Card reader	ISV-E40-READER

## OPERATION ENVIRONMENT

Operation temperature	-10~50°C
Storage temperature	-20~60°C
Operation humidity	15%~85%



## MULTIPURPOSE VIDEOSCOPE

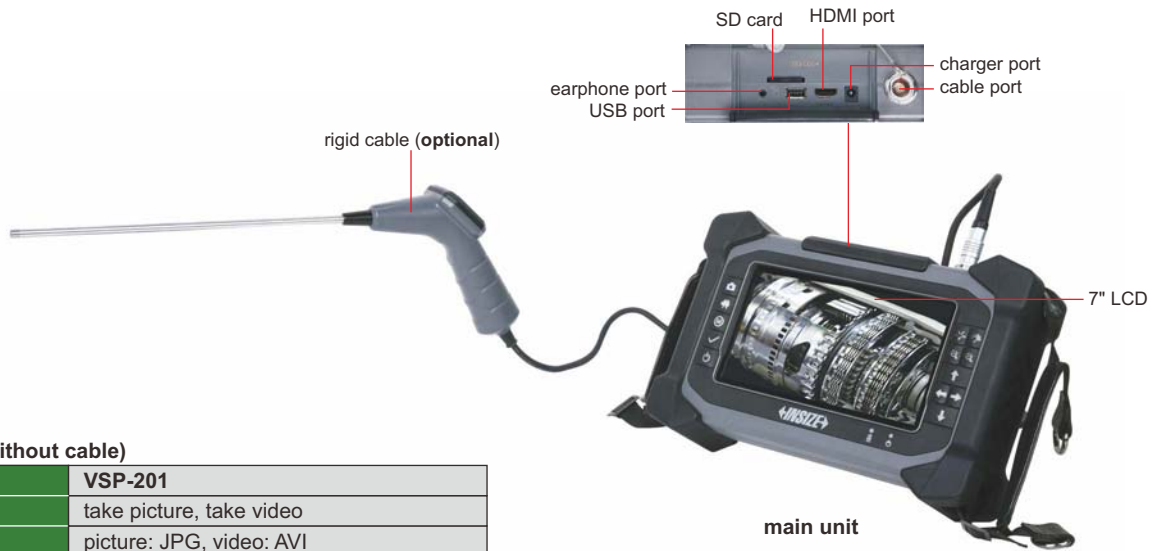

### MAIN UNIT (without cable)

<b>Code</b>	<b>VSP-201</b>
<b>Function</b>	take picture, take video
<b>File format</b>	picture: JPG, video: AVI
<b>Image process</b>	brightness, contrast
<b>Memory</b>	64GB
<b>Output</b>	HDMI, USB
<b>Power supply</b>	rechargeable battery (for 4 hours working)
<b>Dimension</b>	260×170×65mm
<b>Weight</b>	1.2kg

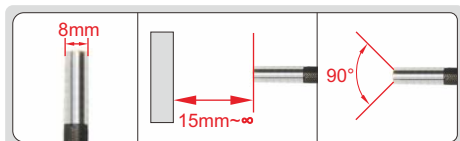

diameter (ØD)    focus distance (F)    angle of view (θ)



bend in any direction    360° swivel in clockwise and counter-clockwise    bend within 120°



### FOUR-DIRECTION BENDING CABLE (FRONT VIEW)

<b>Code</b>	<b>VSP-201D</b>	
<b>Cable</b>	length	3m
	type	tungsten wire weaved cable
<b>Lens</b>	diameter (ØD)	8mm
	focus distance (F)	15mm~∞
	angle of view (θ)	90°
	illumination	6 pcs LED
	pixel	1M
	resolution	1280×720
<b>dust/waterproof</b>		IP67



To be continued

Continued from previous page



### RIGID CABLE

<b>Code</b>	<b>VSP-201H</b>	
<b>Cable</b>	length (L)	250mm
	type	stainless steel
<b>Lens</b>	diameter (ØD)	6.4mm
	focus distance (F)	15mm~∞
	angle of view (θ)	90°
	illumination	6 pcs LED
	pixel	1M
	resolution	1280×720
	dust/waterproof	IP64

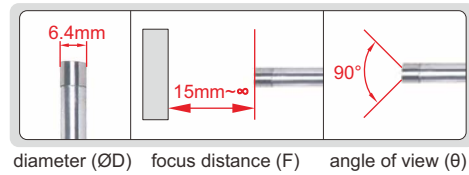

### ROTATING LENS CABLE

<b>Code</b>	<b>VSP-201R</b>	
<b>Cable</b>	length	30m
	type	high strength glass fibre
<b>Lens</b>	diameter (ØD)	40mm
	focus distance (F)	3mm~∞
	angle of view (θ)	100°
	illumination	12 pcs LED
	pixel	1M
	resolution	1280×720
	dust/waterproof	IP67
lens control	motorized	

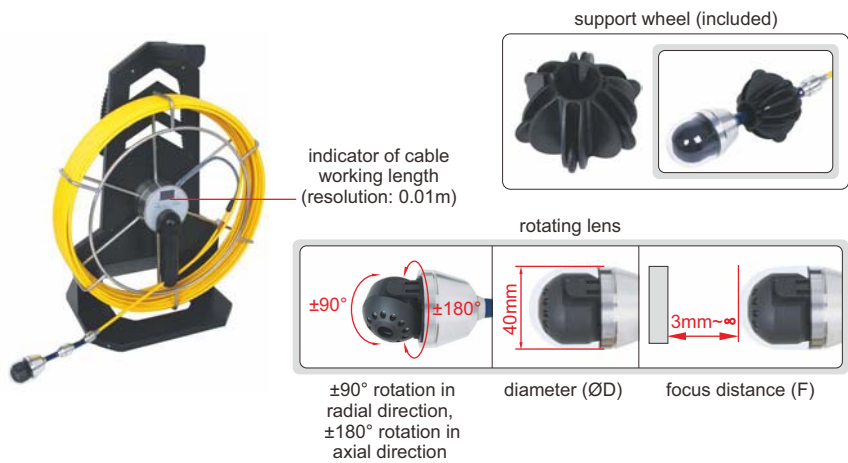

### WIDE-ANGLE LENS CABLE

<b>Code</b>	<b>VSP-201W</b>	
<b>Cable</b>	length	30m
	type	high strength glass fibre
<b>Lens</b>	diameter (ØD)	24mm
	focus distance (F)	25mm~∞
	angle of view (θ)	100°
	illumination	12 pcs LED
	pixel	1M
	resolution	1280×720
	dust/waterproof	IP67

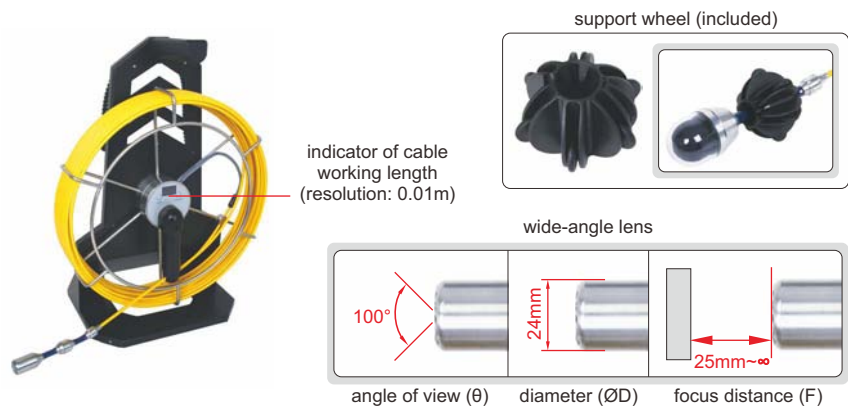

### ADJUSTABLE SUPPORT

Code	Working diameter (ØD)	Remark
VSP-201-R200	60~200mm	for VSP-201R or VSP-201W

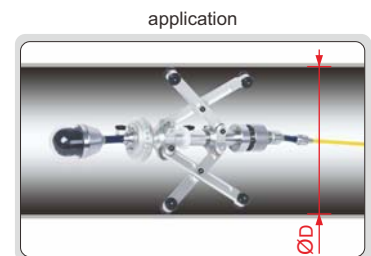

**IP68**  
WATERPROOF

ATTENTION: RESISTANCE TO ACID AND ALKALI LIQUID (CONSULT IS NEEDED)

**PIPE VIDEOSCOPE  
CODE ISV-VP280**



lens with adjustable LED illumination

stand

3.5" LCD

take picture  
take video  
power on/off

cable length: 30m

indicator of cable working length

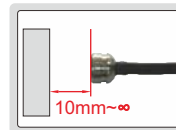

focus distance

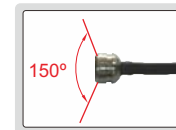

angle of view

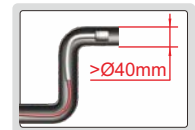

can turn at least two times in the pipe (>Ø40mm)



vertical use

horizontal use



Ø50mm centering ring (optional) fixed on the lens to center lens in the pipe

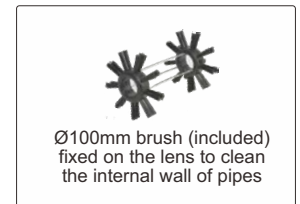

Ø100mm brush (included) fixed on the lens to clean the internal wall of pipes

**SPECIFICATION**

Lens	diameter	28mm
	dust/waterproof	IP68
	pixel	0.3M
	resolution	640×480
Cable	frame	30fps
	length	30m
	dust/waterproof	IP68
Main unit	type	semi-rigid
	function	take picture and video
	file format	picture: JPG, video: ASF
	image process	mirror, rotate, zoom (1.5X, 2X)
	memory	4G SD card
	output	TV, USB
	power supply	4×AA batteries
Weight		5kg

**STANDARD DELIVERY**

Main unit	1 pc
Cable with lens	1 pc
Stand	1 pc
Indicator of cable working length	1 pc
4G SD card	1 pc
Ø100mm brush	1 pc
AA battery	4 pcs
AAA battery	2 pcs
Video output cable	1 pc
USB cable	1 pc

**OPTIONAL ACCESSORY**

Ø50mm centering ring	ISV-VP280-R50
Ø150mm brush	ISV-VP280-B150

# RIGID BORESCOPIES

**IP67**  
WATERPROOF

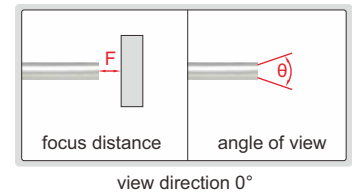
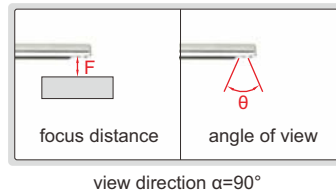
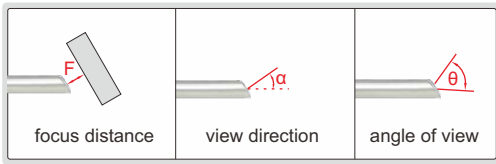
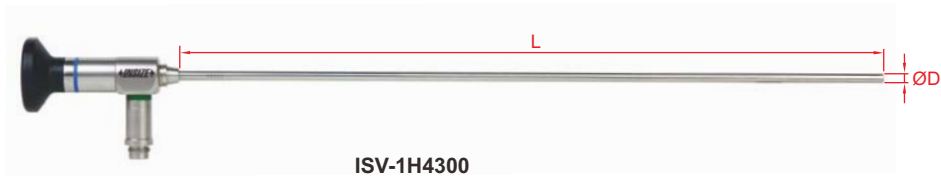

- Focus distance: 2mm, depth of view: 5~100mm
- Dust/waterproof level: IP67
- Can be used in liquid with temperature  $-10^\circ\text{C}\sim 85^\circ\text{C}$



LED light handle  
(optional)



adjustable LED light source  
(optional)



camera and display  
(optional)

## SPECIFICATION

Code	Length (L)	View direction ( $\alpha$ )	Diameter ( $\varnothing D$ )	Angle of view ( $\theta$ )
ISV-1H4170	174mm	$0^\circ$	4mm	$\geq 60^\circ$
ISV-1H4173	174mm	$30^\circ$		
ISV-1H4177	174mm	$70^\circ$		
ISV-1H4179	166mm	$90^\circ$		
ISV-1H4300	302mm	$0^\circ$		
ISV-1H4303	302mm	$30^\circ$		
ISV-1H4307	302mm	$70^\circ$		

## OPTIONAL ACCESSORY

LED light handle	ISV-1HLED
Adjustable LED light source	ISV-1LED1
Camera and display	ISV-2CAM

## LED LIGHT HANDLE CODE ISV-1HLED

- For rigid borescopes



battery (included)



charger (included)



### SPECIFICATION

<b>Power</b>	3W
<b>Battery</b>	3.7V rechargeable battery (for 2 hours working)
<b>Dimension</b>	120×27×27mm
<b>Weight</b>	300g

### STANDARD DELIVERY

<b>Main unit</b>	1 pc
<b>Battery</b>	1 pc
<b>Charger</b>	1 pc

## ADJUSTABLE LED LIGHT SOURCE CODE ISV-1LED1

- For rigid borescopes
- High LED illumination and brightness is adjustable
- For long time work with low noise

### SPECIFICATION

<b>Color temperature</b>	5600K
<b>Cooling</b>	fan cooling
<b>Power</b>	AC110~220V, 50/60Hz
<b>Dimension</b>	400×300×112mm
<b>Weight</b>	7kg



### STANDARD DELIVERY

<b>Main unit</b>	1 pc
<b>1.8m optical fiber cable</b>	1 pc



TAKE PICTURES  
AND VIDEOS

AUTO FOCUS

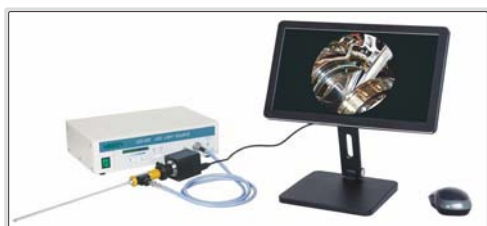

- For rigid borescopes
- 1080P high-definition image
- Auto-focus camera
- Take pictures and videos, saved to USB flash disk
- Automatic white balance and exposure
- Brightness, contrast ratio, gain are adjustable

### SPECIFICATION

<b>Sensor</b>	1/2.8" CMOS
<b>Pixel</b>	2M
<b>Resolution</b>	1920×1080
<b>Frame rate</b>	60fps
<b>Output</b>	HDMI
<b>Power supply</b>	power adapter
<b>Dimension (L×W×H)</b>	350×100×430mm
<b>Weight</b>	2kg



### STANDARD DELIVERY

<b>Camera</b>	1 pc
<b>Connector</b>	1 pc
<b>13.3" LCD (with stand)</b>	1 pc
<b>16G USB flash disk</b>	1 pc
<b>Mouse</b>	1 pc
<b>HDMI cable</b>	1 pc
<b>Power adapter</b>	2 pcs



16G USB flash disk  
(included)



**Coating Thickness Gages**  
Page 687-690



**Coating Thickness Gages**  
Page 691



**Surface Profile Gages**  
Page 691-692



**Wet Film Gages**  
Page 693



**Holiday Detectors**  
Page 693



**Gloss Meters**  
Page 694-695



**Colorimeters**  
Page 696-698



**Pencil Hardness Testers**  
Page 699



**Cross Cut Adhesion Testers**  
Page 699



**Digital Adhesion Testers**  
Page 700



**Rotational Abrasion Testers**  
Page 701



**Paint Film Flexibility Testers**  
Page 701



**Impact Testers**  
Page 702

SUITABLE FOR THIN COATING  
BELOW 10 $\mu$ m

FOR MAGNETIC AND  
NON-MAGNETIC SUBSTRATES

## COATING THICKNESS GAGE (HIGH PRECISION) CODE ISO-8000FN



calibration foils (included)



zero calibration plate  
(included)



stand  
(optional)



eddy current probe N2000  
(optional)



eddy current probe N1500  
(optional)



magnetic induction  
probe  
(included)



- Can measure thickness of thin coating below 10 $\mu$ m
- High repeatability
- Magnetic induction probe measures the thickness of non-magnetic coating and non-metallic coating on magnetic metal substrate  
Substrate: iron, steel, magnetic stainless steel (not for non-magnetic stainless steel)  
Coating: zinc, aluminum, copper, chrome, tin, plastic, powder, paint (not for nickel)
- Eddy current probe measures the thickness of non-conductive coating on non-magnetic metal substrate  
Substrate: copper, aluminum, zinc, non-magnetic stainless steel  
Coating: plastic, powder, paint, anodizing (not for chrome and zinc plating)
- Maximum, minimum, average and variance values can be calculated automatically

### SPECIFICATION

Probe	Magnetic induction probe (included)	Eddy current probe* (optional)	
Measuring range	0~500 $\mu$ m	0~1500 $\mu$ m	0~2000 $\mu$ m
Resolution	0.1 $\mu$ m (range<100 $\mu$ m) 1 $\mu$ m (100 $\mu$ m $\leq$ range $\leq$ 500 $\mu$ m)	0.1 $\mu$ m (range<100 $\mu$ m) 1 $\mu$ m (100 $\mu$ m $\leq$ range<1000 $\mu$ m) 0.01mm (1.00mm $\leq$ range $\leq$ 1.50mm)	0.1 $\mu$ m (range<100 $\mu$ m) 1 $\mu$ m (100 $\mu$ m $\leq$ range<1000 $\mu$ m) 0.01mm (1.00mm $\leq$ range $\leq$ 2.00mm)
Accuracy	$\pm(0.5+2\%L)\mu$ m L is measuring thickness in $\mu$ m		
Repeatability	$\leq(0.2+0.8\%L)\mu$ m L is measuring thickness in $\mu$ m		$\leq(0.2+1\%L)\mu$ m L is measuring thickness in $\mu$ m
Measuring mode	single and continuous		
Measuring interval	single mode	1.5s	0.8s
	continuous mode	0.4s	0.4s
Calibration mode	zero calibration and multi-points calibration (1~5 points)		
Minimum substrate thickness	0.1mm	0.05mm	
Minimum measuring area	$\varnothing$ 7mm		$\varnothing$ 25mm
Minimum radius of curvature workpieces	convex surface	1.5mm	
	concave surface	10mm	
Unit	$\mu$ m/mil		
Power supply	4 $\times$ 1.5V AAA batteries		
Dimension	148 $\times$ 76 $\times$ 26mm		
Weight	148g		

### STANDARD DELIVERY

Main unit	1 pc
Magnetic induction probe	1 pc
Zero calibration plate	1 pc
Calibration foils (5.6 $\mu$ m, 11.6 $\mu$ m, 24.6 $\mu$ m, 50.0 $\mu$ m, 100 $\mu$ m, 252 $\mu$ m, 390 $\mu$ m)	1 set
1.5V AAA battery	4 pcs

### OPTIONAL ACCESSORY

Eddy current probe (with zero calibration plate)	ISO-8000FN-N1500*
	ISO-8000FN-N2000
Stand	ISO-8000FN-STAND

\*For precision measurement of thin coating below 10 $\mu$ m, please use the stand for eddy current probe

## COATING THICKNESS GAGE CODE 9501-1200

POPULAR  
MODEL

BLUETOOTH

FOR MAGNETIC AND  
NON-MAGNETIC SUBSTRATES

DATA  
OUTPUT



eddy current probe  
NFE (optional) with  
zero calibration block



magnetic induction  
probe FE90 for bores  
and grooves (optional)



calibration foils  
(included)



magnetic induction  
probe FE10 for large  
range (optional)



zero calibration block  
for FE (included)



receiver (optional)



- Magnetic induction probe (FE) measures the thickness of non-magnetic coating and non-metallic coating on magnetic metal substrate.  
Substrate: iron, steel, magnetic stainless steel (not for non-magnetic stainless steel)  
Coating: zinc, copper, chrome, tin, plastic, powder, paint (not for nickel)
- Eddy current probe (NFE) measures the thickness of non-conductive coating on non-magnetic metal substrate.  
Substrate: copper, aluminum, zinc, non-magnetic stainless steel  
Coating: plastic, powder, paint, anodizing (not for chrome and zinc plating)
- Tolerance measurement
- Data statistic, including average, variance, maximum and minimum values
- Data can be sent to Excel by connecting to computers via bluetooth or cable of receiver
- Support bluetooth printer
- Automatic power off

### SPECIFICATION

Probe type	FE (included) magnetic induction probe	NFE (optional) eddy current probe	FE90 (optional) magnetic induction probe for bores and grooves	FE10 (optional) magnetic induction probe for large range
Measuring range	0~1250μm	0~1250μm	0~1250μm	500~10000μm
Accuracy	$\pm(3\%L+1)\mu\text{m}$ (range $\leq 1250\mu\text{m}$ ) $\pm(3\%L+10)\mu\text{m}$ (range $> 1250\mu\text{m}$ ) L is measuring thickness in μm			
Resolution	0.1μm (range $< 100\mu\text{m}$ ) 1μm (range $\geq 100\mu\text{m}$ )			
Measuring mode	continuous and single			
Minimum substrate thickness	0.5mm	0.3mm	0.5mm	2mm
Minimum measuring area	Ø7mm	Ø5mm	Ø7mm	Ø40mm
Minimum curvature radius of convex workpiece	1.5mm	3mm	—	10mm
Memory	600			
Output	USB			
Power supply	2×1.5V AA batteries			
Dimension	135×77×32mm			
Weight	172g			

### STANDARD DELIVERY

Main unit	1 pc
Magnetic induction probe (FE)	1 pc
Zero calibration block for FE probe	1 pc
Calibration foils (50/100/250/500/1000μm)	1 set
1.5V AA battery	2 pcs
Software and USB cable	1 pc

### OPTIONAL ACCESSORY

Receiver	ISR-C300-RECEIVER
Cable of receiver	9501-1200-CABLE
Bluetooth printer	ISR-C002-PRINTER
Eddy current probe (NFE) with zero calibration block	9501-1200-NFE
Magnetic induction probe (FE90) for bores and grooves	9501-1200-FE90
Magnetic induction probe (FE10) for large range	9501-1200-FE10



FOR MAGNETIC AND  
NON-MAGNETIC SUBSTRATES

## COATING THICKNESS GAGE (BASIC TYPE) CODE ISO-1200FN

- Probe is suitable for both magnetic and non-magnetic metal substrates
- Can measure the thickness of non-magnetic coating and non-metallic coating on magnetic metal substrate  
Substrate: iron, steel, magnetic stainless steel (not for non-magnetic stainless steel)  
Coating: zinc, aluminum, copper, chrome, tin, plastic, powder, paint (not for nickel)
- Can measure the thickness of non-conductive coating on non-magnetic metal substrate  
Substrate: copper, aluminum, zinc, non-magnetic stainless steel  
Coating: plastic, powder, paint, anodizing (not for chrome and zinc plating)
- 3 measuring modes: Fe, NFe, Fe/NFe
- Store 9 measuring records
- Small and portable, easy for operation



### SPECIFICATION

Measuring range	0~2000μm	
Resolution	0.1μm (range<100μm)	
	1μm (100μm≤range<1000μm)	
	0.01mm (1mm≤range≤2mm)	
Accuracy	±(2μm+3%L) L is measuring thickness in μm	
Measure interval	0.5s	
Calibration mode	zero calibration	
Measuring mode	Fe, NFe, Fe/NFe	
Minimum substrate thickness	Fe	0.2mm
	NFe	0.05mm
Minimum measuring area	Ø25mm	
Minimum radius of curvature workpieces	convex surface	5mm
	concave surface	25mm
Unit	μm/mil	
Power supply	2×1.5V AAA batteries	
Main unit dimension	101×62×28mm	
Probe dimension	71×26×22mm	
Weight	114g	



Fe zero calibration plate  
(included)



NFe zero calibration plate  
(included)



standard foil (included)

### STANDARD DELIVERY

Main unit	1 pc
Fe zero calibration plate	1 pc
NFe zero calibration plate	1 pc
Standard foil (100μm)	1 pc
1.5V AAA battery	2 pcs

## COATING THICKNESS GAGE (BASIC TYPE) CODE ISO-1000FN

FOR MAGNETIC AND  
NON-MAGNETIC SUBSTRATES

- Probe is suitable for both magnetic and non-magnetic metal substrates
- Can measure the thickness of non-magnetic coating and non-metallic coating on magnetic metal substrate  
Substrate: iron, steel, magnetic stainless steel (not for non-magnetic stainless steel)  
Coating: zinc, aluminum, copper, chrome, tin, plastic, powder, paint (not for nickel)
- Can measure the thickness of non-conductive coating on non-magnetic metal substrate  
Substrate: copper, aluminum, zinc, non-magnetic stainless steel  
Coating: plastic, powder, paint, anodizing (not for chrome and zinc plating)
- 3 measuring modes: Fe, NFe, Fe/NFe
- Store 9 measuring records
- Small and portable, easy for operation



ruby contact point

### SPECIFICATION

Measuring range	0~2000 $\mu$ m	
Resolution	0.1 $\mu$ m (range<100 $\mu$ m)	
	1 $\mu$ m (100 $\mu$ m $\le$ range<1000 $\mu$ m)	
	0.01mm (1mm $\le$ range $\le$ 2mm)	
Accuracy	$\pm(2\mu\text{m}+3\%L)$ L is measuring thickness in $\mu$ m	
Measure interval	0.5s	
Calibration mode	zero calibration	
Measuring mode	Fe, NFe, Fe/NFe	
Minimum substrate thickness	Fe	0.2mm
	NFe	0.05mm
Minimum measuring area	$\varnothing$ 25mm	
Minimum radius of curvature workpieces	convex surface	5mm
	concave surface	25mm
Unit	$\mu$ m/mil	
Power supply	2 $\times$ 1.5V AAA batteries	
Dimension	101 $\times$ 62 $\times$ 28mm	
Weight	79g	



standard foil (included)



Fe zero calibration plate (included)



NFe zero calibration plate (included)

### STANDARD DELIVERY

Main unit	1 pc
Fe zero calibration plate	1 pc
NFe zero calibration plate	1 pc
Standard foil (100 $\mu$ m)	1 pc
1.5V AAA battery	2 pcs

## CALIBRATION FOILS FOR COATING THICKNESS GAGES



- To calibrate or check the accuracy of coating thickness gages
- Increase the measurement accuracy after foil calibration
- Uniformity:  $\pm 0.3\mu\text{m}$  ( $\leq 50\mu\text{m}$ ),  $\pm 0.6\%$  ( $> 50\mu\text{m}$ )
- Dimension: 45 $\times$ 30mm (thickness $\leq$ 2000 $\mu\text{m}$ ), 50 $\times$ 30mm (thickness $>$ 2000 $\mu\text{m}$ )
- Supplied with manufacturer inspection certificate

Code	Thickness	Deviation*	Uniformity
9503-FL1	11.5 $\mu$ m	$\pm 5\%$	$\pm 0.3\mu\text{m}$
9503-FL2	23 $\mu$ m	$\pm 5\%$	$\pm 0.3\mu\text{m}$
9503-FL3	50.5 $\mu$ m	$\pm 5\%$	$\pm 0.6\%$
9503-FL4	102 $\mu$ m	$\pm 5\%$	$\pm 0.6\%$
9503-FL5	250 $\mu$ m	$\pm 5\%$	$\pm 0.6\%$
9503-FL6	495 $\mu$ m	$\pm 3\%$	$\pm 0.6\%$
9503-FL7	995 $\mu$ m	$\pm 2\%$	$\pm 0.6\%$
9503-FL8	1780 $\mu$ m	$\pm 5\%$	$\pm 0.6\%$
9503-FL9	3725 $\mu$ m	$\pm 4\%$	$\pm 0.6\%$
9503-FL10	7650 $\mu$ m	$\pm 2\%$	$\pm 0.6\%$



9503-FL6

\* Deviation between the ordered thickness and the thickness marked on the calibration foils when supplied



## X RAY FLUORESCENCE SPECTROMETER (RoHS DETECTOR/ALLOY COMPOSITION ANALYZER/COATING THICKNESS GAGE) CODE XRF-B210

REFER TO PAGE  
524-525 FOR DETAILS

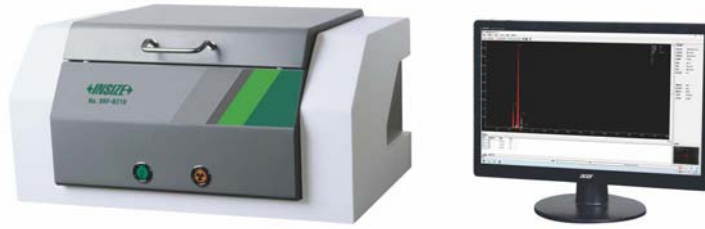

DATA  
OUTPUT

DISPLAY MAXIMUM, MINIMUM, DIFFERENCE  
VALUE BETWEEN MAXIMUM AND MINIMUM

## DIGITAL SURFACE PROFILE GAGE



measure peak-to-valley height  
of blast cleaned surfaces

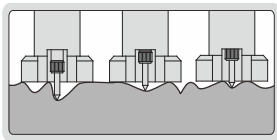

2844-10

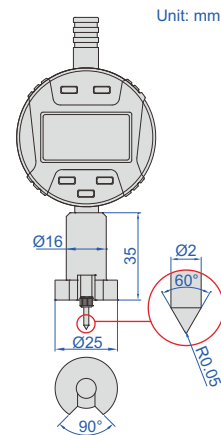

- Measure peak-to-valley height of blast cleaned surface.  
If the profile is too low, the adhesion of the coating to the surface will be reduced.  
If the profile is too high, there is the danger that the profile peaks will remain uncoated, allowing rust spots to occur.
- Meet ASTM D 4417-B
- Zero set block is included, set zero before measurement
- Button function: tolerance Go and No-Go display, data preset, measuring direction change, max./min./TIR measurement, inch/metric conversion, absolute/incremental measurement
- CR2032 battery
- Automatic power off (time is adjustable)
- Data output
- Stainless steel base
- Optional accessory: data output cable  
(code **7315-50M** need receiver page 5, **7302-40M** page 13)

set zero



Code	Range	Digital indicator stroke	Digital indicator resolution	Accuracy
<b>2844-10</b>	0-12.7mm/0-0.5"	12.7mm/0.5"	0.001mm/0.00005"	±0.005mm

## SURFACE PROFILE GAGE



measure peak-to-valley height of blast cleaned surfaces

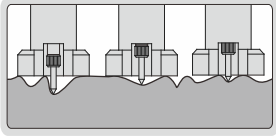

2344-1

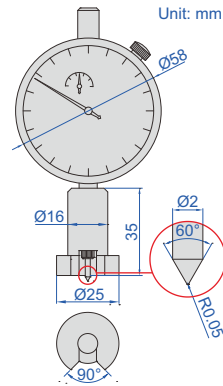

- Measure peak-to-valley height of blast cleaned surface. If the profile is too low, the adhesion of the coating to the surface will be reduced. If the profile is too high, there is the danger that the profile peaks will remain uncoated, allowing rust spots to occur.
- Meet ASTM D 4417-B
- Zero set block is included, set zero before measurement
- Stainless steel base

Code	Range	Dial indicator stroke	Dial indicator graduation	Accuracy
2344-1	0-1mm	1mm	0.001mm	±0.005mm

set zero



zero set block (included)

## DIGITAL SURFACE PROFILE GAGE

DATA OUTPUT

27

measure peak-to-valley height of blast cleaned surfaces

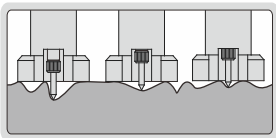

2843-10

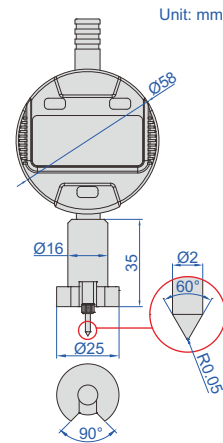

- Measure peak-to-valley height of blast cleaned surface. If the profile is too low, the adhesion of the coating to the surface will be reduced. If the profile is too high, there is the danger that the profile peaks will remain uncoated, allowing rust spots to occur.
- Meet ASTM D 4417-B
- Zero set block is included, set zero before measurement
- Button function: on/off, zero, mm/inch, absolute/incremental measurement
- CR2032 battery, automatic power off (time is adjustable)
- Data output
- Stainless steel base
- Optional accessory: data output cable (code 7315-50M need receiver page 5, 7302-40M page 13)

Code	Range	Digital indicator stroke	Digital indicator resolution	Accuracy
2843-10	0-12.7mm/0-0.5"	12.7mm/0.5"	0.001mm/0.00005"	±0.005mm



set zero



zero set block (included)

## WET FILM GAGES

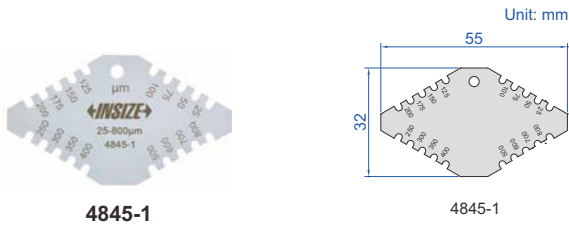

4845-1

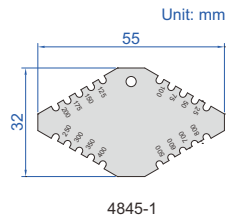

4845-1

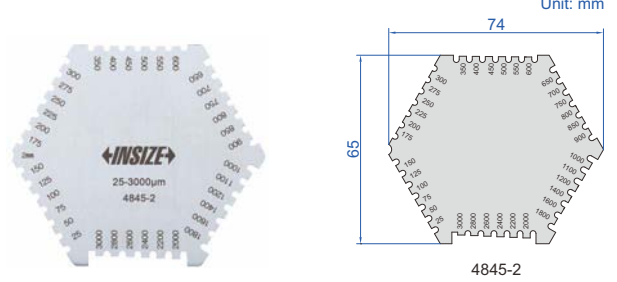

4845-2

4845-2

- Made of stainless steel

Code	Range	Accuracy	Thickness
4845-1	25-800μm	±5μm	1.8mm
4845-2	25-3000μm	25-100μm: ±5μm 100μm-3000μm: ±5%	1mm



VIDEO

## HOLIDAY DETECTOR CODE 9511-HA30



strip brush (included)

- Inspect anti-corrosion coating status of different thickness with adjustable pulse high-voltage, coating includes insulating paint, glass lining, rubber lining, glass fiber reinforced plastic, coal tar epoxy, etc.
- When the brush with pulse high-voltage moves near the crack, pinhole or thin area on the coating surface, which results in gap gas breakdown and discharge spark, sound and light alarm will appear on the probe and the alarm sound can be heard with the headphone
- LCD display with light-control backlight
- Built-in rechargeable battery, easy to carry and suitable for outdoor inspection
- Automatic power off



headphone (included)



flat brush (included)

### SPECIFICATION

Measuring range	0.05~10mm (customization for inspecting coating thicker than 10mm is available)
Output voltage	0.6~30.0kV (stepless adjustable)
Resolution	0.1kV
Power	≤5W
Power supply	12V rechargeable Ni-MH battery
Dimension	220×130×88mm
Weight	2.5kg

### STANDARD DELIVERY

Main unit	1 pc
Probe	1 pc
Strip brush*	1 pc
Flat brush	1 pc
Ground wire	1 pc
Ground rod	1 pc
Headphone	1 pc
AC/DC adapter	1 pc

\* Arc brush and circular probe can be customized

## 60° GLOSS METER (BASIC TYPE) CODE 5702-DG6

- To test the gloss of coating, such as painting, varnish, printing ink, etc.
- To test the material surfaces, such as metal, granite, ceramic, plastic, paper, etc.
- According to ISO 2813, ISO 7668, ASTM D523, ASTM D2457, DIN 67530
- Automatic judgement after setting high and low limits
- Automatic power off

### SPECIFICATION

Incidence angle	60°
Measuring range	0~200GU
Resolution	0.1GU
Accuracy	±1.5GU (range<120GU) ±1.5% (range≥120GU)
Repeatability	0.2GU (range<120GU) 0.2% (range≥120GU)
Zero error	0.1GU
Measuring area	20×10mm
Power supply	rechargeable battery
Data port	USB
Dimension	135×45×75mm
Weight	237g

### STANDARD DELIVERY

Main unit	1 pc
Base with calibration block	1 pc
U disk	1 pc
AC/DC adapter	1 pc
USB data cable	1 pc
Cleaning cloth	1 pc



base with calibration block  
(included)



software (included), test can be controlled from the software,  
display test data and report

report

software

measurement data is sent to Excel

## 60° GLOSS METER CODE ISQ-DG6

- To test the gloss of coating, such as painting, varnish, printing ink, etc.
- To test the material surfaces, such as metal, granite, ceramic, plastic, paper, etc.
- According to ISO 2813, ASTM D2457, ASTM D523
- Automatic power off

### SPECIFICATION

Incidence angle	60°
Measuring range	0~150GU
Resolution	0.1GU
Accuracy	±1.2GU
Repeatability	0.4GU
Zero set error	0.2GU
Measuring area	20×10mm
Output	bluetooth
Power supply	1×1.5V AA battery
Dimension	123×38×65mm
Weight	300g

### STANDARD DELIVERY

Main unit	1 pc
Base with calibration block	1 pc
Spare calibration block	1 pc



base with calibration block  
(included)



connect mobile phone via bluetooth  
(only Android system)

operate and output data by mobile phone





DATA OUTPUT

BLUETOOTH

CAN BE OPERATED BY COMPUTERS OR MOBILE PHONES

## 20°/60°/85° GLOSS METER CODE ISQ-DG8



base with calibration block (included)



software flash disk (included)

- To test the gloss of coating, such as painting, varnish, printing ink, etc.
- To test the material surfaces, such as metal, granite, ceramic, plastic, paper, etc.
- According to ISO 2813, ASTM D2457, ASTM D523
- Memory of 10000 measurement results for browsing and output
- Automatic power off

connect to mobile phone via bluetooth (only Android system)



operate and output data by mobile phone

connect to computer via bluetooth or USB cable



bluetooth receiver (included)

### SPECIFICATION

Incidence angle	20°	60°	85°
Measuring range	0~2000GU	0~1000GU	0~160GU
Resolution	0.1GU (range≤119.9GU) 1GU (range>119.9GU)		
Accuracy	±1.5GU (range≤119.9GU) ±1.5% (range>119.9GU)		
Repeatability	0.2GU (range≤119.9GU) 0.2% (range>119.9GU)		
Zero set error	0.2GU		
Measuring area	10×9mm	16×9mm	39×5mm
Output	USB and bluetooth		
Power supply	1×1.5V AA battery		
Dimension	155×48×75mm		
Weight	400g		

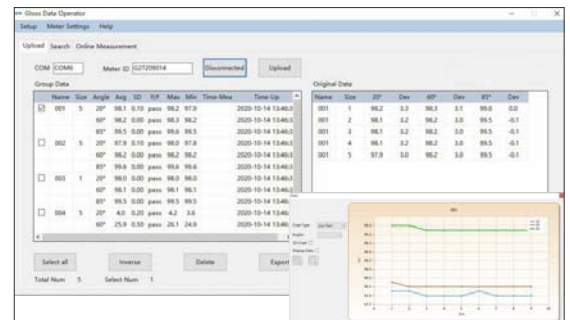

software (included), test can be controlled from the software, display test data, output to Excel

### STANDARD DELIVERY

Main unit	1 pc
Base with calibration block	1 pc
Software and USB cable	1 pc
Bluetooth receiver	1 pc

# SPECTROPHOTOMETER CODE 9710-30

DATA  
OUTPUT

CONCAVE GRATING  
SPECTROPHOTOMETRIC

Ø8/4mm DUAL APERTURE

BLUETOOTH

- Concave grating spectrophotometric
- 3.5 inch TFT color LCD, capacitive touch screen, 256 image element double arrays CMOS image sensor
- D/8 geometrical optics, conforms with CIE No.15, ISO7724/1, ASTM E1164, DIN5033 Teil 7
- Use long life and low power consumption combined LED light source
- Camera locating function, switchable 8mm/4mm aperture, support both SCI and SCE at the same time
- Large capacity storage space, over 20,000 measurement data
- USB port and Bluetooth 4.0
- Two standard observer angles, a variety of illuminant, a variety of color indexes, conforms with a variety of standard colorimetric data
- Measure sample spectra, accurate Lab data, can be used in color matching and accurate color transmission



## SPECIFICATION

<b>Optical geometry</b>	reflect: di: 8°, de: 8° (diffused illumination, 8-degree viewing angle)	
<b>Integrating sphere size</b>	Ø48mm	
<b>Light source</b>	combined LED light, UV light	
<b>Spectrophotometric mode</b>	concave grating	
<b>Sensor</b>	256 image element double array CMOS image sensor	
<b>Wavelength range</b>	400~700nm	
<b>Wavelength interval</b>	10nm	
<b>Semiband width</b>	10nm	
<b>Measured reflectance range</b>	0~200%	
<b>Measuring aperture</b>	dual aperture: MAV: Ø8mm; SAV: Ø4mm	
<b>Specular component</b>	SCI&SCE	
<b>Color space</b>	CIE LAB, XYZ, Yxy, LCh, CIE LUV, hunter LAB	
<b>Color difference formula</b>	$\Delta E^*ab$ , $\Delta E^*uv$ , $\Delta E^*94$ , $\Delta E^*cmc$ (2:1), $\Delta E^*cmc$ (1:1), $\Delta E^*00v$ , $\Delta E$ (Hunter)	
<b>Other colorimetric index</b>	WI (ASTM E313, CIE/ISO, AATCC, hunter), YI (ASTM D1925, ASTM 313), metamerism index MI, staining fastness, color fastness, color strength, opacity	
<b>Observer angle</b>	2°/10°	
<b>Illuminant</b>	A, C, D50, D55, D65, D75, F1, F2, F3, F4, F5, F6, F7, F8, F9, F10, F11, F12, CWF, U30, T183, T184, U35	
<b>Displayed data</b>	spectrogram/values, samples chromaticity values, color difference values/graph, PASS/FAIL result, color offset	
<b>Measuring time</b>	2.6s	
<b>Repeatability</b>	<b>spectral reflectance</b>	MAV/SCI, within 0.08% of standard deviation (400~700nm: 0.18%)
	<b>colorimetric values</b>	MAV/SCI: $\Delta E^* \leq 0.03$
<b>Inter-instrument error</b>	MAV/SCI: $\Delta E^* \leq 0.15$	
<b>Measurement mode</b>	single measurement, average measurement	
<b>Data port</b>	USB, bluetooth 4.0	
<b>Data storage</b>	standard 1000 pcs, sample 28000 pcs	
<b>Illuminant life span</b>	5 years, more than 3 million times measurements	
<b>Battery</b>	Li-ion battery, 5000 measurements within 8 hours	
<b>Dimension</b>	184×77×105mm	
<b>Weight</b>	600g	



software flash disk (included)



white and black calibration cavity (included)



printer (optional)

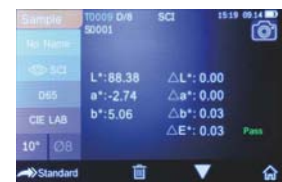

measurement



reflectivity

software

report

measurement data is sent to Excel

software (included), test can be controlled from the software, display test data, report

## STANDARD DELIVERY

Main unit	1 pc
White and black calibration cavity	1 pc
Software and USB cable	1 pc
AC/DC adapter	1 pc

## OPTIONAL ACCESSORY

Printer	9710-PRINTER
Powder test box	9710-POWDERBOX
Universal test kit	9710-TESTKIT



- Conforms with CIE No.15, ISO7724-1, ASTM E1164 and DIN5033 Teil7 standards
- Grating spectrophotometric, 3.5" IPS full color screen, dual optical path high precise CMOS array sensor
- Use long life and low power consumption combined LED light source, include UV and exclude UV measurement
- Camera locating function, switchable 11mm/6mm/1×3mm aperture
- Large capacity storage space, over 20000 measurement data
- Two standard observer angles, a variety of illuminant, a variety of color indexes, conforms with a variety of standard colorimetric data
- Measure sample spectra, accurate Lab data, can be used in color matching and accurate color transmission



## SPECTROPHOTOMETER CODE 5701-D40

FOUR KINDS OF APERTURE

GRATING  
SPECTROPHOTOMETRIC

DATA  
OUTPUT

MATCHING COLOR  
CARD QUICKLY



### SPECIFICATION

Optical geometry	D/8 (diffused illumination/8° direction reception), SCI+SCE (specular component included+specular component excluded)	
Integrating sphere size	Ø40mm	
Light source	LED (full band balanced LED)+UV	
Spectrophotometric mode	grating	
Sensor	dual optical path high precise CMOS array sensor	
Wavelength range	400~700nm	
Wavelength interval	10nm	
Reflectance measurement range	0~200%	
Reflectance resolution	0.01%	
Display resolution	0.01	
Illumination area/aperture	MAV: Ø11mm; SAV: Ø6mm, Ø3mm; MINI: 1×3mm	
Color space	CIE-Lab, CIE-LCh, HunterLab, CIE Luv, XYZ, Yxy, RGB	
Color difference formula	$\Delta E^*ab$ , $\Delta E^*cmc$ , $\Delta E^*94$ , $\Delta E^*00$	
Other colorimetric index	whiteness (ASTM E313-00, ASTM E313-73, CIE/ISO, AATCC, hunter, taube berger stensby), yellowness (ASTM D1925, ASTM 313-00, ASTM E313-73), blackness (My, dM), color fastness, tint (ASTM E313-73) color density CMYK (A, T, E, M), milm, munsell, opacity, color strength	
Observer angle	2°/10°	
Illuminant	A, B, C, D50, D55, D65, D75, F1, F2, F3, F4, F5, F6, F7, F8, F9, F10, F11, F12, CWF, U30, U35, DLF, NBF, T183, T184, Id50, Id65, LED-B1, LED-B2, LED-B3, LED-B4, LED-B5, LED-BH1, LED-RGB1, LED-V1, LED-V2	
Measuring time	about 1.5s	
Repeatability	spectral reflectance	within 0.08% of standard deviation
	colorimetric values	$\Delta E^*ab \leq 0.025$ (after whiteboard correction, measuring the whiteboard 30 times at 5s interval)
Inter-instrument error	$\Delta E^*ab \leq 0.25$ (BCRA series II, average value of 12 color plates)	
Data port	USB, bluetooth	
Light source lifetime	10 years, more than 1 million times measurements	
Battery	3.7V/3000mAh, rechargeable 8000 times continuous tests	
Dimension	95×129×231mm	
Weight	750g	



software (included), test can be controlled from the software, display test data, report



software

pure data report

graphic report

To be continued

Continued from previous page

**STANDARD DELIVERY**

Main unit	1 pc
White calibration cavity	1 pc
Measuring aperture	3 pcs
USB cable	1 pc
USB disk	1 pc
AC/DC adapter	1 pc



white calibration cavity (included)

connect to computer

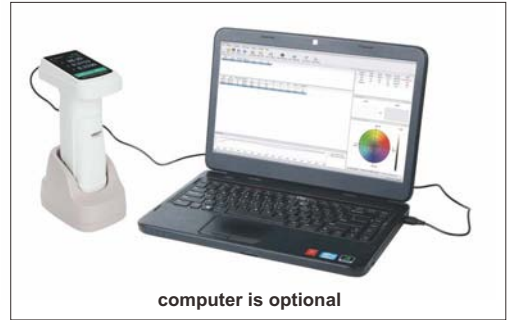

computer is optional

**COLORIMETER (BASIC TYPE)  
CODE 5700-LS35**

- Conforms with CIE 15, CIE S 005, ISO 7724-1 and ISO 13655 standards
- 3.5-inch IPS display and capacity touch panel
- Contains multiple color cards and can match the closest color code quickly
- QC testing function, can set color difference threshold
- Able to store 1000 colors and 1000 color comparison
- 3.7V/4000mAh battery, 10000 continuous measurements



white calibration cavity (included)



**SPECIFICATION**

<b>Illumination geometry</b>	D/8, specular component include (SCI)
<b>Illumination light source</b>	full spectrum LED light source
<b>Measurement conditions</b>	light source D65, field of view 10°
<b>Measuring time</b>	about 1s
<b>Color space</b>	CIE Lab, Luv, LCh, Yxy, CMYK, RGB, Hex
<b>Color difference formula</b>	$\Delta E^*ab$ , $\Delta E^*uv$ , $\Delta E^*94$ , $\Delta E^*cmc (2:1)$ , $\Delta E^*cmc (1:1)$ , $\Delta E^*00$
<b>Repeatability</b>	standard deviation $\Delta E^*ab$ is within 0.03 (measurement condition: the average value of 30 measurements on the whiteboard at an interval of 3s after calibration)
<b>Charging interface</b>	USB (Type-C)
<b>Dimension</b>	86×63×158mm
<b>Weight</b>	245g

**STANDARD DELIVERY**

Main unit	1 pc
White calibration cavity	1 pc
USB cable	1 pc
AC/DC adapter	1 pc
Cleaning cloth	1 pc
Locating plate	1 pc

27

**STANDARD COLOR PLATES  
CODE 5704-CP01**

- To calibrate color measuring instruments
- Made of ceramic
- Wear resistance, corrosion resistance, high optical stability
- Supplied with ISO17025 calibration certificate from National Institute of Metrology, China

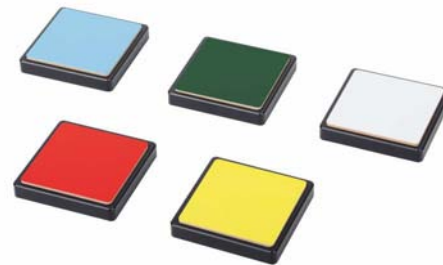

**SPECIFICATION**

<b>Spectral reflectance factor</b>	spectral reflectance factor in the wavelength range of 380nm to 780nm
<b>Standard illuminant</b>	A, D65, etc
<b>Viewing angle</b>	2°, 10°
<b>Color space</b>	CIE-Lab, XYZ, etc
<b>Annual variation</b>	$\Delta x, \Delta y \leq 0.005$
<b>Dimension</b>	50×50mm

**STANDARD DELIVERY**

Protective gloves	1 pair
Calibration certificate	1 pc



calibration certificate (included)



- For flat coating surfaces
- Conform to ASTM D3363, ISO 15184, BS3900-E19 and ECCA-T4/1

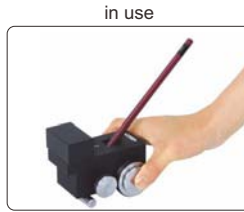

## PENCIL HARDNESS TESTER CODE PHT-C751



### SPECIFICATION

Pressure of pencil on coating	500g, 750g, 1000g (main unit is 500g, one weight is 750g, two weights are 1000g)
Angle between pencil and measured surface	45°
Dimension (L×W×H)	95×80×110mm
Weight	2kg

### STANDARD DELIVERY

Main unit	1 pc
Weights	2 pcs
Leveling rod	1 pc
Level	1 pc
Pencil	12 pcs (4B, 3B, 2B, B, HB, F, H, 2H, 3H, 4H, 5H, 6H)
Pencil sharpener	1 pc

### OPTIONAL ACCESSORY

Pencil (12 pcs: 4B-6H)	PHT-C751-P
400 grade abrasive paper	PHT-C751-S



level (included)



pencils (included)



leveling rod (included)



weights (included)



- To test the adhesion of paint coating on metal, wood, plastic, etc.
- According to ISO 2409, ASTM D3359, DIN53151



## CROSS CUT ADHESION TESTER CODE ISQ-PK100



3mm pitch blade (included)



2X magnifier (included)

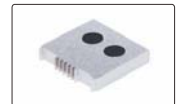

2mm pitch blade (included)

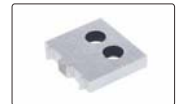

1mm pitch blade (included)



brush (included)



test tape (included)  
ISQ-PK100-1

### SPECIFICATION

Blade		1mm pitch	2mm pitch	3mm pitch
Applied paint thickness	on hard substrate (like metal)	0~60µm	61~120µm	121~250µm
	on soft substrate (like wood, plaster)	—	0~120µm	121~250µm
Minimum substrate thickness	hard substrate (like metal)	0.25mm	0.25mm	0.25mm
	soft substrate (like wood, plaster)	—	10mm	10mm
Minimum size of test sample		150×100mm	150×100mm	150×100mm
Dimension		170×28×40mm		
Weight		430g		

### STANDARD DELIVERY

Handle	1 pc
1mm pitch blade	1 pc
2mm pitch blade	1 pc
3mm pitch blade	1 pc
Test tape (ISQ-PK100-1)	1 pc
2X magnifier	1 pc
Brush	1 pc



step 1: make grid cutting on surface



step 2: paste and remove the tape

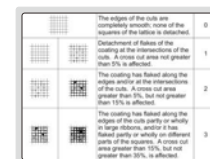

step 3: according to the shedding status, judge the adhesion grade

## DIGITAL ADHESION TESTER CODE SPT-AD21

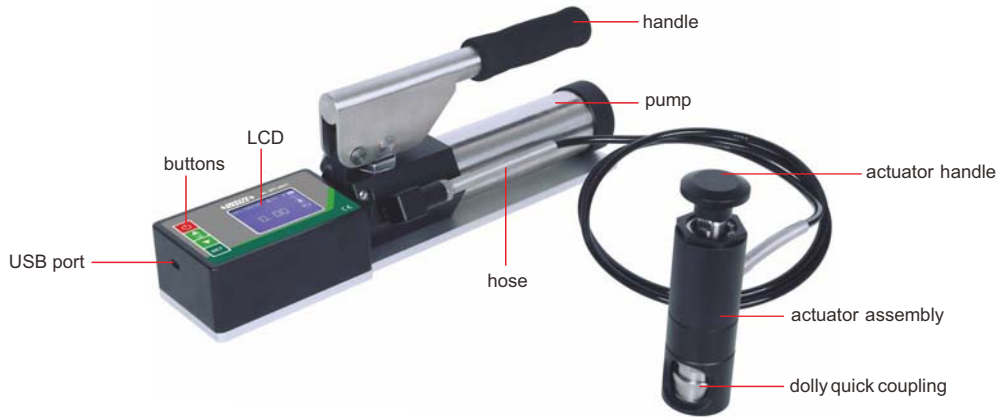

Ø20mm dolly (included)



glue gun and glue (included)



cutting tool (included) for Ø10mm, Ø14mm, Ø20mm dolly

- Pull-off test
- Built-in rechargeable lithium battery, no need external power source
- Portable design, can be used anywhere
- Standard USB interface, can directly transmit the stored data to computer, no need to install software
- Conforms to GB/T 5210, ASTM D4541/D7234, ISO 4624/16276-1
- Store all test results, includes maximum pull-off force, pull-off rate, dolly size and time
- Built in real-time clock, all saved data have corresponding date and time
- Selectable four different sizes dolly for different resolution and testing range
- No need conversion, the instrument can calculate pull-off force according to the dolly size
- Get the testing results from LCD directly
- Two units MPa and psi for selection and can be converted automatically

27

### SPECIFICATION

Range	0~20MPa
Dolly diameter	Ø20mm
Resolution	0.01MPa (1psi)
Accuracy	±1% full scale
Pull-off force	0.7~20MPa
Power	built-in rechargeable lithium battery
Dimension (LxWxH)	360x75x115mm
Weight	3kg

### STANDARD DELIVERY

Main unit	1 pc
Ø20mm dolly	20 pcs
Cutting tool	1 pc
Charger	1 pc
USB cable	1 pc
Glue gun	1 pc
3M glue	1 pc

### OPTIONAL ACCESSORY

Ø10mm dolly	SPT-AD21-10	10 pcs/package pull-off force: 2.8~80MPa
Ø14mm dolly	SPT-AD21-14	10 pcs/package pull-off force: 1.4~40MPa
Ø20mm dolly	SPT-AD21-20	10 pcs/package pull-off force: 0.7~20MPa
Ø50mm dolly	SPT-AD21-50*	10 pcs/package pull-off force: 0.4~3.5MPa
Cutting tool	SPT-AD21-CUTTER1	for Ø10mm, Ø14mm, Ø20mm dolly
Cutting tool	SPT-AD21-CUTTER2*	for Ø50mm dolly
Sleeve	SPT-AD21-SLEEVE*	for Ø50mm dolly
Glue	SPT-AD21-GLUE	3M DP420 epoxy glue/50ml

\* Ø50mm dolly requires corresponding cutter and sleeve

## ROTATIONAL ABRASION TESTER CODE QMY-AP32

- To test flat paint film
- Comply with ISO 7784-2, ISO 9352, GB/T1768, ASTM D3884, ASTM D1175 standards

### SPECIFICATION

Platform rotary speed	60±2 r/min, 72±2 r/min (selectable)
Load weight	500g, 750g, 1000g
Sample size	Ø100mm
Grinding wheel	external diameter (51.6±0.1)mm, thickness (12.7±0.1)mm
Counting range of platform rotation	0~9999 times
Motor power	25W
Power supply	220V, 50Hz
Dimension	260×410×280mm
Weight	14kg



### STANDARD DELIVERY

Main unit	1 pc
Vacuum cleaner	1 pc
1000g weight	2 pcs
750g weight	2 pcs
500g weight	2 pcs
TABER CS-10 grinding wheel	1 pair
Sandpaper	10 pcs
Glass plate	5 pcs

### OPTIONAL ACCESSORY

TABER CS17 grinding wheel (1 pair)	QMY-AP32-CS17
Glass plate (Ø100mm with a 9mm center hole, 100 pcs/box)	QMY-AP32-GP
Aluminum plate (Ø100mm with a 9mm center hole, 100 pcs/box)	QMY-AP32-AP
180# emery cloth strip (100 pcs/box)	QMY-AP32-EC

## PAINT FILM FLEXIBILITY TESTER CODE PPF-BF62

- To test the flexibility of paint and varnish
- Bend the coated test plates on the shaft rods with different diameter, the minimum shaft rod diameter that does not cause damage to the film is the film flexibility



### SPECIFICATION

Shaft rod length	35mm
Shaft rod 1	Ø15mm
Shaft rod 2	Ø10mm
Shaft rod 3	Ø5mm
Shaft rod 4	Ø4mm
Shaft rod 5	cross section 3×10mm, radius of curved surface 1.5mm
Shaft rod 6	cross section 2×10mm, radius of curved surface 1.0mm
Shaft rod 7	cross section 1×10mm, radius of curved surface 0.5mm
Dimension	450×75×100mm
Weight	3.1kg



### STANDARD DELIVERY

Main unit	1 pc
Test plate	1 box (500 pcs)
4X magnifier	1 pc

### OPTIONAL ACCESSORY

Test plate (dimension: 120×25×0.28mm, 500 pcs/box)	PPF-BF62-TP
--	-------------

**IMPACT TESTER  
CODE THD-PF34**



300g main weight (included)



1000g main weight (included)



2lb main weight (included)



2lb additional weight (included)



1000g additional weight (included)



Ø16.3mm die base (included)



Ø12.7mm indenter (included)



Ø15.9mm indenter (included)

- For paint and varnish dry coating. To test the ability to resist cracking or peeling from the substrate when deformation is caused by weights impact under standard conditions
- Indenter, base and weight can be replaced quickly
- Conform to ISO 6272-2:2002, ASTM D 2794

**SPCIFICATION**

Impact height range	0-100cm (0-40inch)
Graduation	1cm
Impact depth	2.5cm
Weight	1000g (2 pcs), 300g (1 pc), 2lb (2 pcs)
Indenter diameter	Ø12.7mm (1/2 inch DIA), Ø15.9mm (5/8 inch DIA)
Die base diameter	Ø16.3mm

**OPTIONAL ACCESSORY**

Base plate (120×70×0.5mm, 180 pcs/box) *	THD-PF34-T
--	------------

\*Can be customized according to the needs of different thickness, size and processing



**STANDARD DELIVERY**

Main unit	1 pc
1000g main weight	1 pc
300g main weight	1 pc
2lb main weight	1 pc
1000g additional weight	1 pc
2lb additional weight	1 pc
Ø12.7mm indenter	1 pc
Ø15.9mm indenter	1 pc
Ø16.3mm die base	1 pc



**Electromagnetic Ultrasonic Thickness Gages**  
Page 705



**Ultrasonic Thickness Gages**  
Page 706-714



**Tachometers**  
Page 715-716



**Stroboscopes**  
Page 716



**Vibration Meters**  
Page 717-718



**Laser Distance Meters**  
Page 719



**Portable Conductivity/TDS Meters**  
Page 719-720



**Portable pH Meters**  
Page 721-722



**Online Refractivity Sensors**  
Page 723



**Refractometers**  
Page 723-725



**Digital Stopwatches**  
Page 725



**Stroke Counters**  
Page 725



**Digital Moisture Meters**  
Page 726



**Differential Pressure Manometers**  
Page 727



**Anemometers**  
Page 728



**Bourdon Tube Pressure Gages**  
Page 728



**Digital Sound Level Meters**  
Page 729-731



**Light Meters**  
Page 731-732



**UV Light Meters**  
Page 732-733



**Gas Detectors**  
Page 733-734



**Teslameters**  
Page 735



**Laser Belt Tension Meters**  
Page 735



**Light Transmittance Meters**  
Page 736



**Digital Glass Thickness Meters**  
Page 736





## ELECTROMAGNETIC ULTRASONIC THICKNESS GAGE CODE EMU-S340

- No surface polishing required, can penetrate anti-corrosion coating and rust (maximum 4mm), no coupling agent required
- Normal temperature permanent magnetic probe and high temperature permanent magnetic probe are using weak permanent magnet, to replace the strong permanent magnet commonly used nowadays. Completely solve the problem that EMAT transducer suction force is too large and difficult to move, so that the manual inspection is more simple, convenient and safe
- Temperature compensation function, can input the actual temperature of high-temperature components to automatically compensate the speed of sound, making the thickness measurement value more accurate
- Measurement of non verticality up to  $\pm 25^\circ$ , low verticality requirements for probe placement
- Scanning mode: A-scan format, B-scan image format display of thickness measurement values
- 50000 thickness values and 4000 A-scan or B-scan data can be stored
- Integrated high-brightness LEDs on the back for easy on-site illumination



### SPECIFICATION

Measuring range	1.5~200mm (steel, stainless steel)
Resolution	0.02mm
Accuracy	$\pm 0.04\text{mm} + H/1000$ ( $H \leq 50\text{mm}$ ) $\pm 0.2\text{mm}$ ( $50 \geq H \geq 100\text{mm}$ ) $\pm 0.3\text{mm}$ ( $100 \geq H \geq 200\text{mm}$ )
Working gap (the distance between the probe and the measured object)	normal temperature permanent magnetic probe $\leq 4\text{mm}$ high temperature permanent magnetic probe $\leq 2\text{mm}$
Minimum required diameter	$\geq 8\text{mm}$
Non-perpendicularity	$\pm 25^\circ$
Excitation frequency	3.0MHz~3.9MHz
Material velocity	1000~9999m/s
Adjustment increments	1m/s
Gate function	automatic gate, manual single gate, manual double gate
Display	color LCD, 3.5 inch/320×480 pixel
Interface	USB2.0
Power supply	rechargeable lithium battery, working time $\geq 8$ hours
Dimension	195×90×40mm
Weight	820g



normal temperature permanent magnetic probe sweep support EMU-S52 (optional)



high temperature permanent magnetic probe EMU-S51 (optional)

### STANDARD DELIVERY

Main unit	1 pc
Transducer EMU-S50	1 pc
Calibration block (diameter $\varnothing 36 \times$ wall thickness 10mm)	1 pc
4G USB flash disk	1 pc
USB cable	1 pc

### OPTIONAL ACCESSORY

High temperature permanent magnetic probe	EMU-S51
Normal temperature permanent magnetic probe sweep support	EMU-S52

### SPECIFICATION OF TRANSDUCERS

Code	Magnetism	Magnetic force	Diameter ( $\varnothing d$ )	Applicable temperature	Application
EMU-S50 (included)	weak permanent magnet	$\leq 15\text{N}$	$\varnothing 30\text{mm}$	$-10 \sim 60^\circ\text{C}$	general use
EMU-S51 (optional)	weak permanent magnet	$\leq 20\text{N}$	$\varnothing 45\text{mm}$	$-50 \sim 800^\circ\text{C}$	for high temperature

# ULTRASONIC THICKNESS GAGE (ADVANCED TYPE) CODE ISU-800D

PENETRATE COATING AND MEASURE  
THE THICKNESS OF SUBSTRATE

BLUETOOTH

REAL-TIME TEMPERATURE  
COMPENSATION

DATA  
OUTPUT

- Real-time temperature compensation eliminates the error caused by temperature variation
- Support both single element transducers and dual element transducers
- Measure the thickness of substrate through coating
- Measuring mode: standard mode (dual element transducer: P-E mode, single element transducer: I-E mode), penetrate coating mode (dual element transducer: I-E mode, single element transducer: E-E mode or auto mode)
- Measure method: single point, scanning, deviation
- Set upper and lower limits for alarm when out-of-tolerance
- Single point and 2 points calibration
- Keyboard lock function avoids parameter setting change caused by unintended press during measurement
- Memory 1000 measurement values
- Data can be transferred to PC by Bluetooth connection or Mini-USB cable



## SPECIFICATION

Measuring range	refer to the specification of transducers
Resolution	0.01mm/0.001mm
Accuracy	refer to the specification of transducers
Data output	bluetooth and USB
Velocity	1~19999m/s
Power supply	3.7V rechargeable lithium battery
Dimension	157×78×37mm
Weight	260g

## STANDARD DELIVERY

Main unit	1 pc
Transducer ISU-S15-P06	1 pc
Power adaptor	1 pc
USB cable	1 pc
Couplant	1 bottle

## OPTIONAL ACCESSORY

Transducer	refer to the specification of transducers
Couplant (for ISU-H3M-P12)	ISU-HT5-COULPLANT
Thermal printer (with cable)	ISU-800D-PRINTER

## SPECIFICATION OF TRANSDUCERS (ON STEEL)

Code	Type	Freq	Diameter (Ød)	Measuring range	Min. size of pipes (diameter x wall thickness)	Accuracy	Applicable temperature	Application
<b>ISU-S15-P06 (included)</b>	single element	15MHz	8mm	I-E: 0.9~28mm E-E: 0.15~14mm	Ø10x1.5mm Ø15x0.35mm	±0.02mm/0.3%H* (take the larger one)	-10~60°C	high precision or thin workpieces
<b>ISU-S15-P06-CB (optional)**</b>	-	-	5mm	I-E: 0.9~10mm E-E: 0.15~5mm	Ø10x1.2mm Ø15x0.35mm			high precision or irregular surface
<b>ISU-S15-P06-CB1 (optional)**</b>	-	-	8mm	I-E: 0.9~38mm E-E: 0.3~19mm	-			high precision or thick workpieces
<b>ISU-S2M-P14 (optional)</b>	single element	2MHz	19mm	I-E: 30~2000mm E-E: 30~1000mm	-	±0.5%H*	-10~310°C	ultra-thick workpieces
<b>ISU-G5M-P10 (optional)</b>	dual element	5MHz	13mm	0.8~300mm	Ø25x3mm	±0.04mm (range: <10mm) ±H/333mm* (range: ≥10mm)	-10~60°C	normal workpieces
<b>ISU-G5M-P08 (optional)</b>	dual element	5MHz	11mm	0.8~225mm	Ø20x1.2mm			curved surface and normal workpieces
<b>ISU-G7M-P06 (optional)</b>	dual element	7.5MHz	9mm	0.8~50mm	Ø15x1.2mm			curved surface and small workpieces
<b>ISU-G2M-P12 (optional)</b>	dual element	2MHz	17mm	3~700mm	Ø30x4mm			castings and thick workpieces
<b>ISU-H3M-P12 (optional)</b>	dual element	3MHz	15mm	2~200mm	Ø25x3mm	±0.05mm/0.5%H* (take the larger one)	-10~310°C	workpieces with high temperature

\* H is the measured thickness in mm

\*\* Delay blockers, suitable for transducer ISU-S15-P06

**PENETRATE COATING AND MEASURE THE THICKNESS OF SUBSTRATES**

**WITH A AND B SCAN**

**DATA OUTPUT**

## ULTRASONIC THICKNESS GAGE CODE ISU-810D



- Measure the thickness of substrate through coating
- Measuring mode: standard mode (dual element transducer: P-E), penetrate coating mode (dual element transducer: E-E)
- Display mode: real-time color A-scan waveform mode, real-time color B-scan waveform mode, thickness value mode, Min/Max capture mode, difference or reduction rate mode
- Can measure gray cast iron, ductile iron, PE, PVC pipe, fiberglass, 3PE anticorrosive layer pipes, metal pipes, pressure vessels, shaped parts, wall thickness of small pipes etc
- Set the upper and lower limits, and the reading color will change when the limit is exceeded
- One-point calibration and two-point calibration
- Can compensate the non-linearity of the twin-crystal probe by automatic V path correction
- Can store 100000 thickness values and 1000 waveforms
- USB 2.0 port connected to computer for statistics
- Languages: Chinese, English, German, French, Japanese
- Power off: automatic/manual



### SPECIFICATION

Measuring range	refer to the specification of transducers
Resolution	0.1/0.01mm
Accuracy	±0.05mm (H<10mm) ±(0.05%H+0.01)mm (H≥100mm) H is the thickness to be measured in mm
Display	320×240, color screen display
Measuring frequency	4Hz, 8Hz, 16Hz
Velocity	500~9999m/s
Applicable temperature	-20~50°C
Output	USB
Measuring unit	mm/inch
Power supply	2×1.5V AA batteries
Dimension	153×76×37mm
Weight	280g (including batteries)

### STANDARD DELIVERY

Main unit	1 pc
Transducer ISU-810D-TC510	1 pc
Battery (AA)	2 pcs
Couplant	1 bottle
USB cable	1 pc

### SPECIFICATION OF TRANSDUCERS

Code	Frequency	Diameter (Ød)	Measuring range	Applicable temperature	Application
ISU-810D-TC510 (included)	5MHz	13.5mm	1.2~400mm	-10~70°C	normal workpieces
ISU-810D-TC550 (optional)	5MHz	13.5mm	1~200mm	-10~70°C	fiberglass and organic material
ISU-810D-PT04 (optional)	10MHz	7mm	0.7~12mm	-10~70°C	small diameter workpieces
ISU-810D-PT06 (optional)	7.5MHz	8.7mm	0.8~30mm	-10~70°C	curved surface and small workpieces
ISU-810D-PT08 (optional)	5MHz	11mm	0.8~100mm	-10~60°C	normal workpieces
ISU-810D-ZT12 (optional)	2MHz	17mm	4~508mm	-10~70°C	cast iron (coarse grain) and thick workpieces
ISU-810D-GT12 (optional)	3MHz	15mm	2~80mm	-20~480°C	workpieces with high temperature



VIDEO

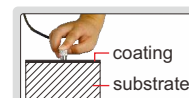

Echo-Echo mode (E-E)

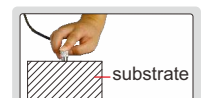

Transmit-Echo mode (T-E)

transducer ISU-810D-TC550 (optional)



transducer ISU-810D-P04 (optional)



transducer ISU-810D-P06 (optional)



transducer ISU-810D-PT08 (optional)



transducer ISU-810D-ZT12 (optional)



transducer ISU-810D-GT12 (optional)



### OPTIONAL ACCESSORY

Transducer	refer to the specification of transducers
Couplant (for ISU-810D-GT12)	ISU-HT5-COULPLANT

# ULTRASONIC THICKNESS GAGE CODE ISU-720D

DATA  
OUTPUT

WITH A AND B SCAN

PENETRATE NON-METALLIC COATING AND  
MEASURE THE THICKNESS OF METAL SUBSTRATES

- Two measuring modes, Echo-Echo (E-E) and Transmit-Echo (T-E):
  - E-E is applicable for non-metallic coating (such as paint, plastic resin, etc.) on metal substrates, can penetrate coating and measure the thickness of substrates
  - T-E is to measure the thickness of material without coating, such as metal, plastic, glass, nylon, resin, ceramics, ice, etc.
- A scan, through the waveform, judges whether there are impurities, pores, cracks and so on inside, in order to avoid wrong measurement
- B scan, measures continuously, displays the thickness change on the screen
- Transducers can be automatically identified and zeroed
- Memory 10000 measurement values
- Data can be input to Excel and Word as keyboard signal
- Automatic or manual measurement
- When transducers are removed from workpieces, the measurement data are held on screen for easy viewing
- Set upper and lower limits for alarm when out-of-tolerance
- Automatic power off



## SPECIFICATION (ON STEEL)

Measuring range	refer to specification of transducers
Resolution	0.1/0.01mm
Accuracy	±0.04mm (H<10mm) ±(0.04+H/1000)mm (10≤H<100mm) ±H/333mm (H≥100mm) H is the thickness to be measured in mm
Frequency	refer to specification of transducers
Display	320×240, color screen display
Velocity	1000~9999m/s
Measuring frequency	2 times/second and 10 times/second
Operation temperature of main unit	-20~50°C
Output	USB
Measuring unit	mm/inch
Power supply	2×1.5V AA batteries
Dimension	133×75×29mm
Weight	260g (including batteries)

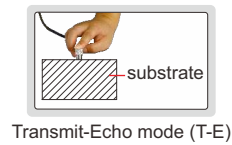
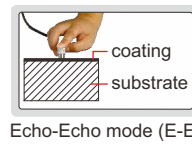

transducer ISU-T04 (optional)



transducer ISU-T06 (optional)



transducer ISU-T08 (optional)



transducer ISU-T12 (optional)



transducer ISU-T13 (optional)



transducer ISU-T25 (optional)



## STANDARD DELIVERY

Main unit	1 pc
Bicrystal transducer ISU-T07	1 pc
Battery (AA)	2 pcs
Couplant	1 bottle
USB cable	1 pc

## OPTIONAL ACCESSORY

Transducer	ISU-T04, ISU-T06, ISU-T08, ISU-T12, ISU-T13, ISU-T25
Couplant (for ISU-T13)	ISU-HT5-COULPLANT

## SPECIFICATION OF TRANSDUCERS (ON STEEL)

Code	Mode	Frequency	Diameter (Ød)	Measuring range	Minimum size of pipes for measurement (diameter × wall thickness)	Applicable temperature	Application
ISU-T07 (included)	T-E E-E	5.0MHz	13.2mm	T-E mode: 1.5~200mm E-E mode: 3~25mm	T-E mode: Ø25×3mm	-20~60°C	general use
ISU-T04 (optional)	T-E	10.0MHz	6mm	0.7~20mm	Ø15×1mm	-20~60°C	for small tubes
ISU-T06 (optional)	T-E	7.5MHz	9mm	0.7~50mm	Ø15×1.2mm	-20~60°C	for thin workpieces
ISU-T08 (optional)	T-E	5.0MHz	11mm	0.8~300mm	Ø25×1.2mm	-20~60°C	general use
ISU-T12 (optional)	T-E	2.0MHz	17mm	2~400mm	Ø40×3mm	-20~60°C	for casting iron
ISU-T13 (optional)	T-E	5.0MHz	15mm	3~100mm	Ø25×2mm	0~350°C	for high temperature
ISU-T25 (optional)	T-E	1.0MHz	26mm	3~200mm	—	-20~60°C	for fiberglass and organic material

DATA  
OUTPUT

WITH A AND B SCAN

## ULTRASONIC THICKNESS GAGE (FOR THICK WORKPIECES MADE OF ORGANIC MATERIALS) CODE ISU-710D



- For thick workpieces made of organic materials
- A scan, through the waveform, judges whether there are impurities, pores, cracks and so on inside, in order to avoid wrong measurement
- B scan, measures continuously, displays the thickness change on the screen
- Transducers can be automatically identified and zeroed
- Memory 10000 measurement values
- Data can be input to Excel and Word as keyboard signal
- Automatic or manual measurement
- When transducers are removed from workpieces, the measurement data are held on screen for easy viewing
- Set upper and lower limits for alarm when out-of-tolerance
- Automatic power off

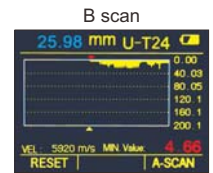
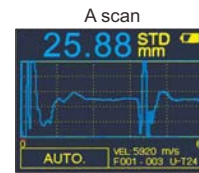

### SPECIFICATION (ON STEEL)

Measuring range		20~590mm
Resolution		0.1/0.01mm
Accuracy		$\pm(0.04+H/1000)$ mm (H<100mm) $\pm H/333$ mm (H $\geq$ 100mm) H is the thickness to be measured in mm
Transducer	type	single element transducer
	frequency	1.0MHz
	diameter (Ød)	26mm
Display		320×240, color screen display
Velocity		1000~9999m/s
Measuring frequency		2 times/second and 10 times/second
Operation temperature		main unit: -20~50°C transducer: -20~60°C
Output		USB
Measuring unit		mm/inch
Power supply		2×1.5V AA batteries
Dimension		133×75×29mm
Weight		260g (including batteries)

### STANDARD DELIVERY

Main unit	1 pc
Transducer	1 pc
Battery (AA)	2 pcs
Couplant	1 bottle
USB cable	1 pc

# ULTRASONIC THICKNESS GAGE (FOR THIN WORKPIECES) CODE ISU-700D

DATA  
OUTPUT

WITH A AND B SCAN



- For thin workpieces
- A scan, through the waveform, judges whether there are impurities, pores, cracks and so on inside, in order to avoid wrong measurement
- B scan, measures continuously, displays the thickness change on the screen
- Transducers can be automatically identified and zeroed
- Memory 10000 measurement values
- Data can be input to Excel and Word as keyboard signal
- Automatic or manual measurement
- When transducers are removed from workpieces, the measurement data are held on screen for easy viewing
- Set upper and lower limits for alarm when out-of-tolerance
- Automatic power off

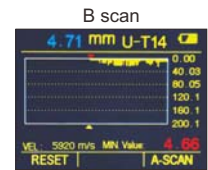
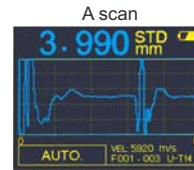

## SPECIFICATION (ON STEEL)

<b>Measuring range</b>		Transmit-echo (T-E) mode: 1.5~20mm Echo-echo (E-E) mode: 0.2~10mm
<b>Resolution</b>		0.1/0.01/0.001mm
<b>Accuracy</b>		±0.04mm (H<10mm) ±(0.04+H/1000)mm (H≥10mm) H is the thickness to be measured in mm
<b>Transducer</b>	<b>type</b>	single element transducer
	<b>frequency</b>	15.0MHz
	<b>diameter (Ød)</b>	7.5mm
<b>Display</b>		320×240, color screen display
<b>Velocity</b>		1000~9999m/s
<b>Measuring frequency</b>		2 times/second and 10 times/second
<b>Operation temperature</b>		main unit: -20~50°C transducer: -20~60°C
<b>Output</b>		USB
<b>Measuring unit</b>		mm/inch
<b>Power supply</b>		2×1.5V AA batteries
<b>Dimension</b>		133×75×29mm
<b>Weight</b>		260g (including batteries)

transducer protective sleeve (included)



## STANDARD DELIVERY

<b>Main unit</b>	1 pc
<b>Transducer</b>	1 pc
<b>Transducer protective sleeve</b>	1 pc
<b>Battery (AA)</b>	2 pcs
<b>Couplant</b>	1 bottle
<b>USB cable</b>	1 pc

PENETRATE NON-METALLIC COATING AND MEASURE THE THICKNESS OF METAL SUBSTRATE



DATA OUTPUT



## ULTRASONIC THICKNESS GAGE (THROUGH COATING) CODE ISU-300D

- Two measuring modes, Echo-Echo (E-E) and Transmit-Echo (T-E):
  - E-E is applicable for non-metallic coating (such as paint, plastic resin, etc.) on metal substrates, can penetrate coating and measure the thickness of substrates
  - T-E is to measure the thickness of material without coating, such as metal, plastic, glass, nylon, resin, ceramics, ice, etc.
- Tolerance measurement
- Average calculation of maximum 9 readings
- Data can be input to Excel and Word as keyboard signal



### SPECIFICATION (ON STEEL)

Measuring range	refer to specification of transducers
Resolution	0.1/0.01mm
Accuracy	±0.04mm (H<10mm) ±(0.04+H/1000)mm (10≤H<100mm) ±H/333mm (H≥100mm) H is the thickness to be measured in mm
Velocity	1000~9999m/s
Operation temperature of main unit	-20~50°C
Output	USB
Measuring unit	mm/inch
Power supply	2×1.5V AAA batteries
Dimension	116×64×27mm
Weight	220g

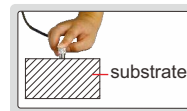

Transmit-Echo mode (T-E)



transducer ISU-T04 (optional)



transducer ISU-T06 (optional)

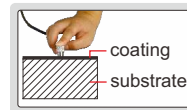

Echo-Echo mode (E-E)



transducer ISU-T12 (optional)



transducer ISU-T13 (optional)

### STANDARD DELIVERY

Main unit	1 pc
Transducer ISU-T07	1 pc
Battery (AAA)	2 pcs
Couplant (for ISU-T04, ISU-T06, ISU-T07, ISU-T12)	1 bottle
USB cable	1 pc

### OPTIONAL ACCESSORY

Transducer	ISU-T04, ISU-T06, ISU-T12, ISU-T13
Couplant (for ISU-T13)	ISU-HT5-COUPPLANT

### SPECIFICATION OF TRANSDUCERS (ON STEEL)

Code	Mode	Frequency	Diameter (Ød)	Measuring range	Minimum size of pipes for measurement (diameter × wall thickness)	Applicable temperature	Application
ISU-T07 (included)	T-E E-E	5.0MHz	13.2mm	T-E mode: 1.5~200mm E-E mode: 3~25mm	T-E mode: Ø25×3mm	-20~60°C	general use
ISU-T04 (optional)	T-E	10.0MHz	6mm	0.7~20mm	Ø15×1mm	-20~60°C	for small tubes
ISU-T06 (optional)	T-E	7.5MHz	9mm	0.7~50mm	Ø15×1.2mm	-20~60°C	for thin workpieces
ISU-T12 (optional)	T-E	2.0MHz	17mm	2~400mm	Ø40×3mm	-20~60°C	for casting iron
ISU-T13 (optional)	T-E	5.0MHz	15mm	3~100mm	Ø25×2mm	0~350°C	for high temperature

# ULTRASONIC THICKNESS GAGE CODE ISU-250C



DATA  
OUTPUT



- Measure the thickness from one side of objects, suitable for pipes, tanks, etc.
- Applicable material: metal, plastic, glass, nylon, resin, ceramic, ice
- Tolerance measurement
- Average calculation of 9 readings
- Data can be input to Excel and Word as keyboard signal



## SPECIFICATION (ON STEEL)

Measuring range	refer to specification of transducers
Resolution	0.1/0.01mm
Accuracy	±0.04mm (H<10mm) ±(0.04+H/1000)mm (10≤H<100mm) ±H/333mm (H≥100mm) H is the thickness to be measured in mm
Velocity	1000-9999m/s
Operation temperature of main unit	-20~50°C
Output	USB
Measuring unit	mm/inch
Power supply	2×1.5V AAA batteries
Dimension	64×116×27mm
Weight	220g



transducer ISU-T06 (optional)



transducer ISU-T13 (optional)



transducer ISU-T04 (optional)



transducer ISU-T12 (optional)

## STANDARD DELIVERY

Main unit	1 pc
Transducer ISU-T08	1 pc
Battery (AAA)	2 pcs
Couplant (for ISU-T04, ISU-T06, ISU-T08, ISU-T12)	1 bottle
USB cable	1 pc

## OPTIONAL ACCESSORY

Transducer	ISU-T04, ISU-T06, ISU-T12, ISU-T13
Couplant (for ISU-T13)	ISU-HT5-COUPPLANT

## SPECIFICATION OF TRANSDUCERS (ON STEEL)

Code	Frequency	Diameter (Ød)	Measuring range	Minimum size of pipes for measurement (diameter × wall thickness)	Applicable temperature	Application
ISU-T08 (included)	5.0MHz	11mm	0.8~300mm	Ø25×1.2mm	-20~60°C	general use
ISU-T04 (optional)	10.0MHz	6mm	0.7~20mm	Ø15×1mm	-20~60°C	for small tubes
ISU-T06 (optional)	7.5MHz	9mm	0.7~50mm	Ø15×1.2mm	-20~60°C	for thin workpieces
ISU-T12 (optional)	2.0MHz	17mm	2~400mm	Ø40×3mm	-20~60°C	for casting iron
ISU-T13 (optional)	5.0MHz	15mm	3~100mm	Ø25×2mm	0~350°C	for high temperature



ATTENTION: NOT SUITABLE FOR CASTINGS AND ALUMINUM WORKPIECES

## ULTRASONIC THICKNESS GAGE (BASIC TYPE) CODE ISU-100D

INSPECTION  
CERTIFICATE

POPULAR  
MODEL



- Measure the thickness from one side of objects, suitable for pipes, tanks, etc.
- Applicable material: steel, stainless steel, glass, copper, brass, polystyrene, titanium, etc.



### SPECIFICATION (ON STEEL)

Measuring range		0.8~300mm
Resolution		0.1/0.01mm
Accuracy		±0.05mm (H<10mm) ±(0.05+H/1000)mm (10≤H<100mm) ±H/333mm (H≥100mm) H is the thickness to be measured in mm
Transducer	frequency	5MHz
	diameter (Ød)	10.8mm
Minimum size of pipes		20×1.2mm (diameter×wall thickness)
Velocity		1000-9999m/s
Operation temperature		main unit: -20~50°C transducer: -20~60°C
Measuring unit		mm/inch
Power supply		2×AAA batteries
Dimension		114×64×28mm
Weight		200g

### STANDARD DELIVERY

Main unit	1 pc
Transducer	1 pc
Couplant	1 bottle
Battery (AAA)	2 pcs

# STANDARD TEST BLOCKS FOR ULTRASONIC THICKNESS GAGES

STEP WEDGE BLOCKS  
CAN BE CUSTOMIZED



cylinder block

- Supplied with manufacturer inspection certificate
- Material of step wedge blocks can be customized

Cylinder block set (17 blocks are included) (mm)

Code	Material	Diameter	Thickness	Accuracy	QTY	
ISU-ST	45#	20	0.5	±0.01	1 pc	
	45#	20	1		1 pc	
	45#	20	1.2		1 pc	
	45#	20	1.5		1 pc	
	45#	20	2		1 pc	
	45#	20	3.3		1 pc	
	45#	20	5.5		1 pc	
	45#	20	7.7		1 pc	
	45#	20	10		1 pc	
	45#	20	15		1 pc	
	45#	20	20	±0.02	1 pc	
	45#	20	25		1 pc	
	45#	20	50		1 pc	
	45#	20	75		1 pc	
	45#	20	100		1 pc	
	45#	20	150		±0.05	1 pc
	45#	20	200			1 pc



round tube block

Round tube block set (2 blocks are included) (mm)

Code	Material	Outer diameter	Wall thickness	Accuracy	Length	QTY
ISU-SWT	45#	30	2	±0.02	40	1 pc
	45#	40	3	±0.02	40	1 pc



step wedge block

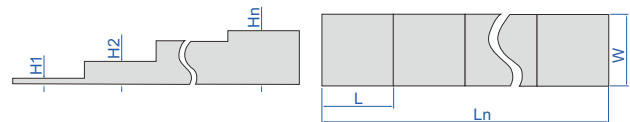

Step wedge blocks (mm)

Code	Material	QTY of steps (n)	Thickness							Accuracy	Width (W)	Length of each step (L)	Total length (Ln)
			H1	H2	H3	H4	H5	H6	H7				
ISU-S4A	45#	4	6.25	12.5	18.75	25	-	-	-	±0.02	20	20	80
ISU-S4B	45#	4	5	10	15	20	-	-	-	±0.02	20	20	80
ISU-S5A	45#	5	2.5	5	7.5	10	12.5	-	-	±0.02	20	20	100
ISU-S5B	45#	5	2	4	6	8	10	-	-	±0.02	20	20	100
ISU-S7A	45#	7	3	12.5	24	30	36	42	48	±0.02	40	40	280
ISU-S7B	45#	7	1	1.5	2	4	6	8	10	±0.02	40	40	280

## CONTACT/NON-CONTACT TACHOMETER CODE 9225-405

- 2 measuring method, contact and non-contact
- Can measure rotary speed and line speed
- Automatically save the maximum value, minimum value and the last value, 500 data can be stored during continuous measurement
- Automatic power off



cone head  
(included)



cone cavity  
head (included)



reflection sticker  
(included)



wheel with 0.1m  
perimeter (included)



small cone head  
(included)



clamping sleeve  
(included)



### SPECIFICATION

Measuring method		Non-contact	Contact
Measuring range	rotary speed	2.5~99999RPM	0.5~19999RPM
	line speed	—	0.05~500m/min
Resolution	rotary speed	0.1RPM (range 2.5~999.9RPM) 1RPM (range 1000~99999RPM)	0.1RPM (range 0.5~999.9RPM) 1RPM (range 1000~19999RPM)
	line speed	—	0.01m/min (range 0.05~99.99m/min) 0.1m/min (range 100~500m/min)
Accuracy	rotary speed	$\pm(0.05\%n+1d)$ RPM n is rotary speed, d is resolution	$\pm(0.4\%n+1d)$ RPM (n<300RPM) $\pm(0.05\%n+1d)$ RPM (n≥300RPM) n is rotary speed, d is resolution
	line speed	—	$\pm(1\%+1d)$ m/min d is resolution
Laser power		CLASS 3R, 3mW~4mW	—
Sampling time		0.6s (above 100RPM)	
Measuring distance		50~500mm	—
Operation temperature		0~40°C	
Power supply		3×AA batteries	
Dimension		206×71×36mm	
Weight		170g	

### STANDARD DELIVERY

Main unit	1 pc
Reflection sticker	3 pcs
Wheel with 0.1m perimeter	1 pc
Clamping sleeve	1 pc
Cone head	1 pc
Small cone head	1 pc
Cone cavity head	1 pc
Battery (AA)	3 pcs

## NON-CONTACT TACHOMETER CODE 9223-120

- Accurately measure the rotary speed without contact
- Automatically save the maximum value, minimum value and the last value, 500 data can be stored during continuous measurement

### SPECIFICATION

Measuring range	2.5~99999RPM
Resolution	0.1RPM (range 2.5~999.9RPM) 1RPM (range 1000~99999RPM)
Accuracy	$\pm(0.05\%n+1d)$ RPM n is rotary speed, d is resolution
Laser power	CLASS 3R, 3mW~4mW
Sampling time	0.6 second (above 100RPM)
Measuring distance	50~500mm
Operation temperature	0~40°C
Power supply	3×AA batteries
Dimension	180×71×29.9mm
Weight	145g



reflection sticker  
(included)



### STANDARD DELIVERY

Main unit	1 pc
Reflection sticker	3 pcs
Battery (AA)	3 pcs

## CONTACT TACHOMETER CODE 9224-213

- Can measure rotary speed, line speed and line length
- Automatically save the maximum value, minimum value and the last value, 96 data can be stored during continuous measurement
- With backlight display

### SPECIFICATION

Measuring range	rotary speed	0.5~19999RPM
	line speed	0.05~500m/min
	line length	0.05~99999m
Resolution	rotary speed	0.1RPM (range 0.5~999.9RPM) 1RPM (range 1000~19999RPM)
	line speed	0.01m/min (range 0.05~99.99m/min) 0.1m/min (range 100~500m/min)
	line length	0.02m
Accuracy	rotary speed	$\pm(0.4\%n+1d)$ RPM ( $n<300$ RPM) $\pm(0.05\%n+1d)$ RPM ( $n\geq 300$ RPM) n is rotary speed, d is resolution
	line speed	$\pm(1\%+1d)$ m/min d is resolution
	line length	$\pm(1\%+1d)$ m d is resolution
Sampling time		0.8s (above 60RPM)
Operation temperature		0~40°C
Power supply		3×AA batteries
Dimension		171×71×35mm
Weight		162g



cone cavity head (included)



clamping sleeve (included)



cone head (included)



small cone head (included)

### STANDARD DELIVERY

Main unit	1 pc
Wheel with 0.1m perimeter	1 pc
Clamping sleeve	1 pc
Cone head	1 pc
Small cone head	1 pc
Cone cavity head	1 pc
Battery (AA)	3 pcs



wheel with 0.1m perimeter (included)

## 28 DIGITAL LED TACHOMETER/STROBOSCOPE CODE ISQ-TS120K

- Make cyclical motion (rotation, vibration, etc.) objects to appear slow-moving or stationary
- On-line inspection or observation for moving objects
- Measure the rotation or vibration speed and frequency
- Can be triggered from outside by moving objects, make LED flash frequency same as the rotation or vibration

### SPECIFICATION

Flash frequency range		60~120000FPM (flash per minute), 1~2000Hz
Resolution	FPM	0.1FPM (<100000FPM), 1FPM ( $\geq 100000$ FPM)
	HZ	0.01Hz (<200Hz), 0.1Hz ( $\geq 200$ Hz)
Setting accuracy		$\pm 0.01\%$
Phase shift increment		3°
Flash pulse duration time		0.1~2.5°
LED light		3 pcs CREE 10W lamp
LED life		3~5 years
Trigger mode		internal and external
Power supply		built-in rechargeable battery or AC/DC adapter
Dimension		208×70×60mm
Weight		380g

### STANDARD DELIVERY

Main unit	1 pc
AC/DC adapter	1 pc
Proximity trigger	1 pc



VIDEO

proximity trigger (included)



make LED flash frequency same as the rotation or vibration (power supply from AC/DC adapter when external trigger is used)

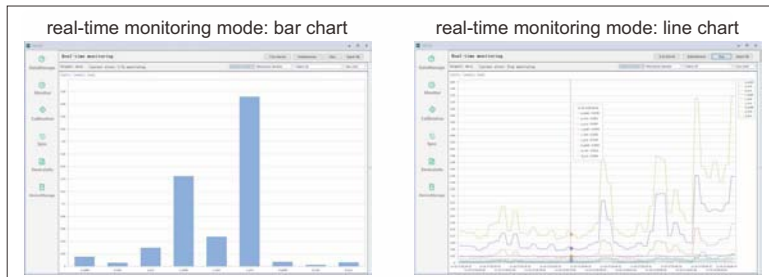

software (included), monitor and collect data to PC software via USB cable,  
data can sent to Excel



- Can measure vibration frequency
- Can measure virtual value/peak value/peak-peak value of acceleration, velocity and displacement
- Suitable for factory inspection, status monitoring and fault diagnosis of mechanical equipments such as motors, pumps, fans, household appliances, compressors, smoke machines, generators, gearboxes, etc
- Software is included: on-line monitoring, data storage

**SPECIFICATION**

Measuring parameter	acceleration (virtual/peak/peak-peak value) $a_{RMS,1}$ , $a_{Peak,1}$ , $a_{P-P,1}$ , $a_{Peak}$ , $a_{P-P}$	velocity (virtual/peak/peak-peak value) $V_{RMS,1}$ , $V_{Peak,1}$ , $V_{P-P,1}$ , $V_{Peak}$ , $V_{P-P}$	displacement (virtual/peak/peak-peak value) $d_{RMS,1}$ , $d_{Peak,1}$ , $d_{P-P,1}$ , $d_{Peak}$ , $d_{P-P}$
Measuring range	0.01~200m/s <sup>2</sup> (peak value)	0.1~200mm/s (virtual value)	0.01~2mm (peak-peak value)
Frequency range	10Hz~5kHz	10Hz~1kHz	10Hz~500Hz
Amplitude frequency reponse	±5%		
Amplitude linearity	±5%		
Frequency accuracy	±0.5%		
Cut-off frequency (second-order high-pass filtering)	8kHz sampling frequency: 3.16Hz、10.00Hz、31.60Hz、N/A (adjustable) 32kHz sampling frequency: 12.64Hz、40.00Hz、126.4Hz、N/A (adjustable)		
Display	1.96" 128×64 dot matrix OLED screen		
Language	Chinese, English, Portuguese		
Power	<80mA/5V		
Power supply	4×AAA batteries: 6.0V/1000mAh; AC/DC adapter: 5V/2A		
Operation condition	temperature: -10°C~50°C; humidity: 25%RH~90%RH, non-condensing; pressure: 65kPa~108kPa		
Dimension	172×69×26mm		
Weight	240g		

**STANDARD DELIVERY**

Main unit	1 pc
Software	1 pc
Accelerometer (including cable)	1 pc
Magnetic base	1 pc
M5 screw	1 pc
Battery (AAA)	4 pcs
AC/DC adapter	1 pc

## VIBRATION PEN (THREE PARAMETERS) CODE 0020-A199

### SPECIFICATION

Parameter	acceleration	velocity	displacement
Measuring range	0.01~199.9m/s <sup>2</sup> (peak value)	0.01~199.9mm/s (virtual value)	0.001~1.999mm (peak~peak value)
Frequency	10Hz~1kHz	10Hz~1kHz	10Hz~500Hz
Frequency response	±5% (≥20Hz) -20%~+10% (<20Hz)		
Linearity	±(5%+2unit)		
Indeterminacy of sensitivity	≤3%		
Operation temperature	0°C~40°C/32°F~104°F		
Operation humidity	<85%		
Power supply	2×LR44 battery (for 10 hours working)		
Dimension	150x22x18mm		
Weight	55g		



- Acceleration, velocity and displacement can be tested
- Automatic power off

### STANDARD DELIVERY

Main unit	1 pc
LR44 battery	2 pcs

## VIBRATION PEN CODE 9720-199



### STANDARD DELIVERY

Main unit	1 pc
LR44 battery	2 pcs

### SPECIFICATION

Measured parameter	speed
Measuring range	0.1~199.9mm/s
Frequency	10Hz~1KHz
Accuracy	±(5%±2)mm/s
Operation temperature	0°C~40°C
Operation humidity	<85%
Power supply	2×LR44 batteries (for 10 hours wroking)
Dimension	150x22x18mm
Weight	55g



- Measure vibration of motors, fans, pumps, compressors and machine tools to prevent mechanical failure
- Small size, light weight, low energy consumption, easy operation, easy to carry
- One key control
- Automatic power off

## PORTABLE VIBRATION CALIBRATOR CODE 0021-AS159

- Quick, easy calibration and checking of vibration measurement, monitoring and recording system

### SPECIFICATION

Frequency	159.2Hz±1%
Acceleration	10m/s <sup>2</sup> ±3% (RMS)
Distortion	<5%
Transverse vibration	<5%
Warm-up time	<20s
Maximum load	70g
Mounting thread	M5×0.8mm
Operation temperature	0°C~40°C
Operation humidity	10%RH~90%RH, non-condensing
Power supply	rechargeable lithium battery, working time≥5h
Dimension	Ø54.5×147mm
Weight	620g



### STANDARD DELIVERY

Main unit	1 pc
Power adapter	1 pc



## LASER DISTANCE METERS

- High accuracy models: **9561-50B, 9561-70B**  
Low accuracy models: **9561-50B-F, 9561-70B-F**
- Large display with backlight
- Unit: m, ft, in, ft+in
- Distance, area, volume and height measurement
- Continuous measuring mode to track maximum and minimum value
- Memory of 30 measurement values
- Automatic power off: laser 30s, main unit 180s

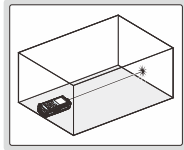

distance measurement

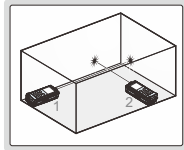

area measurement

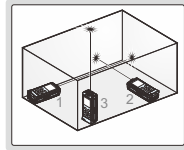

volume measurement

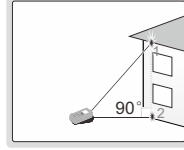

height measurement



9561-50B

### SPECIFICATION

Code	9561-50B	9561-70B	9561-50B-F	9561-70B-F
Measuring range	0.2~50m	0.2~70m	0.2~50m	0.2~70m
Resolution	0.001m, .001ft, 1/16"			
Accuracy	±(3+D/20)mm D: measured distance, unit: m		±(5+D/20)mm D: measured distance, unit: m	
Laser type	630~670nm, class II, <1mW			
Power supply	2×AAA batteries			
Dimension (L×W×H)	115×50×28mm			
Weight	95g			

### STANDARD DELIVERY

Main unit	1 pc
Battery (AAA)	2 pcs

**IP67**  
WATERPROOF

## PEN-TYPE CONDUCTIVITY/TDS/SALINITY TESTER CODE 0412-EB32

- Can measure the conductivity, TDS and salinity
- Suitable for water quality testing, aquaculture, food processing, scientific research, etc.
- The same series of electrodes can be replaced with each other
- Automatic temperature compensation
- With the stabilizing and locking functions of the reading
- Can be used normally in any environment with the background light
- Auto power off
- Protection level: IP67
- Lightweight, easy to carry and operate

"platinum black needle"  
electrode (included)



IP67 waterproof



electrodes can be replaced



VIDEO

### SPECIFICATION

Measuring range	conductivity 0~200.0μS/cm, 0~2000μS/cm, 0~20.00mS/cm
	TDS 0~100.0ppm, 0~1000ppm, 0~10.00ppt
	salinity 0~10.00ppt
	temperature 0~50°C
Resolution	conductivity 0.1μS/cm, 1μS/cm, 0.01mS/cm
	TDS 0.1ppm, 1ppm, 0.01ppt
	salinity 0.01ppt
	temperature 0.1°C
Accuracy	conductivity ±1%FS
	temperature ±0.5°C
Calibration mode	1~3 points
Power supply	4×1.5V AAA batteries
Dimension	178×40×40mm
Weight	133g

### STANDARD DELIVERY

Main unit	1 pc
Standard solution	2 bottles
Test cup	2 pcs
1.5V AAA battery	4 pcs

# PORTABLE CONDUCTIVITY/TDS METER CODE 0411-0200

**IP65**  
WATERPROOF



- Reading mode: auto-read and continuous-read
- Automatic/manual temperature compensation
- Auto-hold feature senses and locks the measurement endpoint
- Cell constant is settable
- 1 point calibration with standard recognition
- Data capacity up to 200 sets for each parameter
- IP65 dust/waterproof
- Auto power off



standard solution (included)



wristband (included)

## SPECIFICATION

Conductivity	range	0.00 $\mu$ S/cm~200mS/cm
	resolution	0.01 $\mu$ S/cm minimum
	electronic unit accuracy	$\pm$ 1.0%FS
	measurement accuracy	$\pm$ 1.5%FS
	reference temperature	25°C/77°F
	calibration point	1
	standard recognition	84 $\mu$ S/cm, 1413 $\mu$ S/cm, 12.88mS/cm
TDS	range	0.00mg/L~300g/L
	resolution	0.01mg/L minimum
	accuracy	$\pm$ 1.0%FS
Temperature	range	-5~110°C/23~230°F
	resolution	0.1°C/0.2°F
	accuracy	$\pm$ 0.4°C/ $\pm$ 0.7°F
Input	electrode with 5-pin aviation connector	
Power supply	rechargeable battery	
Dimension	80×225×35mm	
Weight	400g	

## STANDARD DELIVERY

Main unit	1 pc
Electrode	1 pc
Electrode holder	2 pcs
Wristband	1 pc
Silicone rubber case	1 pc
AC/DC adapter and charging cable	1 pc
Standard solution	1 bottle



**IP67**  
WATERPROOF

**PEN-TYPE pH TESTER**  
**CODE 0432-HB22**



pH "bulb type"  
electrode (included)

- 3 types of pH electrodes: bulb type, plane type and puncture type
- Suitable for water quality testing, sewage treatment, food and cosmetics testing, agriculture and scientific research, etc.
- Can measure the ORP, the same series of electrodes can be replaced with each other
- Automatic temperature compensation
- Alarm function: the red backlight displays alarm mode
- With the stabilizing and locking functions of the reading
- Protection level: IP67
- Can be used normally in any environment with three colors of backlight
- Auto power off
- Lightweight, easy to carry and operate



ORP "platinum needle"  
electrode (optional)



pH "plane type" electrode  
(optional)



pH "puncture type"  
electrode (optional)

**SPECIFICATION**

<b>Measuring range</b>	-2.00~16.00pH
	temperature 0~50°C
	ORP -1000mV~+1000mV
<b>Resolution</b>	0.01pH
	temperature 0.1°C
	ORP 1mV
<b>Accuracy</b>	±0.02pH
	temperature ±0.5°C
	ORP ±0.2%FS
<b>Calibration mode</b>	1~3 points
<b>Standard solution</b>	USA (pH buffers: 4.00, 7.00, 10.01)
	NIST (pH buffers: 4.01, 6.86, 9.18)
<b>Power supply</b>	4×1.5V AAA batteries
<b>Dimension</b>	178×40×40mm
<b>Weight</b>	133g

**STANDARD DELIVERY**

<b>Main unit</b>	1 pc
<b>Standard solution</b>	3 bottles (USA)
<b>Test cup</b>	3 pcs
<b>KCl powder</b>	1 bottle
<b>1.5V AAA battery</b>	4 pcs

**OPTIONAL ACCESSORY**

<b>pH plane type electrode</b>	0432-HB-F
<b>pH puncture type electrode</b>	0432-HB-P
<b>ORP electrode</b>	0432-HB-O

**PORTABLE pH METER  
CODE 0431-0018**



**IP65  
WATERPROOF**



wristband (included)



KCl powder (included)



standard solution (included)

28

- Reading mode: auto-read and continuous-read
- Automatic/manual temperature compensation
- Auto-hold feature senses and locks the measurement endpoint
- 1 or 2 points calibration with standard recognition
- Data capacity up to 200 sets for each parameter
- IP65 dust/waterproof
- Auto power off

**SPECIFICATION**

pH	range	-2.00~18.00pH
	resolution	0.01pH
	electronic unit accuracy	±0.01pH
	measurement accuracy	±0.02pH
	calibration point	1 or 2
	standard recognition	NIST pH buffers: 4.01, 7.00, 10.01
Voltage	range	-1999~1999mV
	resolution	1mV
	accuracy	±0.1%FS
Temperature	range	-5~110°C/23~230°F
	resolution	0.1°C/0.2°F
	accuracy	±0.4°C/±0.7°F
Inputs	pH electrode: BNC (Q9) temp. probe: 4-pin aviation connector	
Power supply	rechargeable battery	
Dimension	80×225×35mm	
Weight	400g	

**STANDARD DELIVERY**

Main unit	1 pc
Electrode	1 pc
Electrode holder	2 pcs
Wristband	1 pc
Silicone rubber case	1 pc
AC/DC adapter and charging cable	1 pc
Standard solution	3 bottles
KCl powder	1 bottle



## ONLINE REFRACTIVITY SENSORS

**IP67**  
WATERPROOF

- Based on the principle of light refraction and total reflection, measure the concentration of coolant, sugar liquid and other liquids in real time
- High measuring accuracy and wide measuring range
- Automatic temperature compensation
- Screw thread, flange, chuck and other installation methods can be customized
- Use sapphire prism, high hardness and wear-resistant
- Resistance to dirty, easy to clean
- Protection level of probe part: IP67



### SPECIFICATION

Code	5806-ZX10	5806-ZX20
Type	flat-top	round-top
Measuring range	Brix 0.00~90.00%	
	refractivity 1.33299~1.51782	
	temperature 0~60°C	
Accuracy	Brix ±0.20%	
	refractivity ±0.00030	
	temperature ±0.5°C	
Resolution	Brix 0.01%	
	refractivity 0.00001	
	temperature 0.1°C	
Measuring mode	immersion	
Pressure resistance	≤1MPa	
Measuring speed	1 time/5s	
Output (customizable)	analog output: (4~20)mA for Brix (0.00~90.00)%	
	digital output: RS485	
Power supply	DC 24V±10%, working current <100mA	
Dimension	Ø88×109mm	Ø88×133mm
Weight	827g	882g



5806-ZX10



5806-ZX20

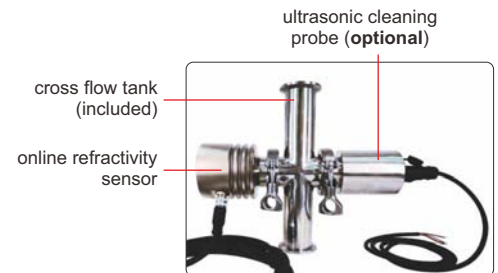

### STANDARD DELIVERY

Main unit	1 pc
Cross flow tank	1 pc
Clamp	4 pcs
Polytef gasket	6 pcs
Connector	2 pcs
Wall piece	1 pc

### OPTIONAL ACCESSORY

Ultrasonic cleaning probe	5806-ZX-UCP
High pressure water/air cleaning device	5806-ZX-HPC
Automatic brush cleaning system	5806-ZX-AC

28

SUITABLE FOR WATER  
BASED COOLANT

## DIGITAL REFRACTOMETER CODE ISQ-DRM31

- Quickly measure the concentration of coolant, sugar solution, juice and drinks
- Two measurement modes:  
single measurement and automatic average multiple measurement
- Two units: brix and refractive index
- Refer to the refraction factor of coolant, for example:  
the refraction factor of grinding emulsion is 2.1,  
the reading value is 6%, so the actual concentration is  $(2.1 \times 6\%) = 12.6\%$
- Automatic power off



### SPECIFICATION

Measuring range	0~50% (1.3330~1.4200RI)
Accuracy	±0.2% (±0.0003RI)
Resolution	0.1% (0.0001RI)
Power supply	1×AAA battery
Dimension	121×58×25mm
Weight	90g

### STANDARD DELIVERY

Main unit	1 pc
Dropper	1 pc
Battery (AAA)	1 pc

dropper (included)

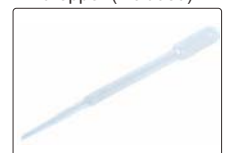

## MINI DIGITAL REFRACTOMETER CODE 5801-A55

SUITABLE FOR WATER  
BASED COOLANT

- Quickly measure the concentration of coolant
- Automatic temperature compensation
- Brix and refractive index can be displayed
- Refer to the refraction coefficient of coolant, for example: the refraction coefficient of grinding emulsion is 2.1, the reading value is 6%, so the actual concentration is  $(2.1 \times 6\%) = 12.6\%$
- Automatic power off



dropper (included)



### SPECIFICATION

Measuring range	0~50% (1.3330~1.4200RI)
Accuracy	±0.2% (±0.0003RI)
Resolution	0.1% (0.0001RI)
Power supply	built-in 3.7V rechargeable lithium battery
Dimension	147×46×27mm
Weight	115g (including battery)

### STANDARD DELIVERY

Main unit	1 pc
Dropper	1 pc

## PORTABLE REFRACTOMETER CODE ISQ-RM30

SUITABLE FOR WATER  
BASED COOLANT

- Quickly measure the concentration of coolant
- Refer to the refraction factor of coolant, for example: the refraction factor of grinding emulsion is 2.1, the reading value is 6%, so the actual concentration is  $(2.1 \times 6\%) = 12.6\%$

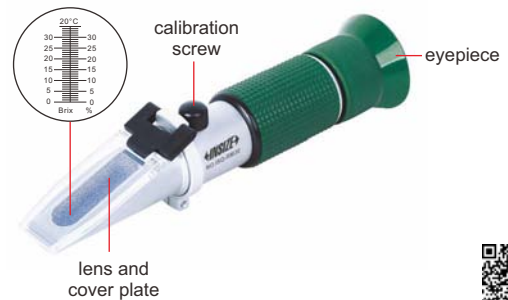

### SPECIFICATION

Measuring range	0~32%
Graduation	0.2%
Dimension	27×40×160mm
Weight	175g

## PORTABLE REFRACTOMETER FOR AUTOMOTIVE LIQUID CODE 5802-A510

- Measure the freezing point of the antifreeze and the concentration of urea in diesel exhaust fluid
- Measure the specific gravity of battery fluid

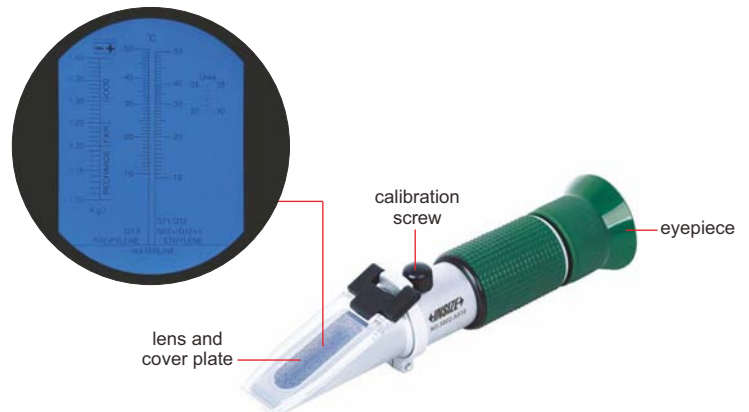

### SPECIFICATION

Measuring object	ethylene glycol	propylene glycol	urea	battery fluid
Measuring range	-50~0°C	-50~0°C	30~35%	1.10~1.40kg/l
Accuracy	±5°C	±5°C	±1%	±0.02kg/l
Resolution	1°C	1°C	1%	0.01kg/l
Dimension	27×40×160mm			
Weight	172g			

## PORTABLE REFRACTOMETER FOR DIESEL EXHAUST FLUID CODE 5803-B40

- Measure the concentration of urea in diesel exhaust fluid
- Wide measuring range

### SPECIFICATION

Measuring range	0~40%
Accuracy	±0.2% (20°C)
Resolution	0.2%
Dimension	27×40×160mm
Weight	170g

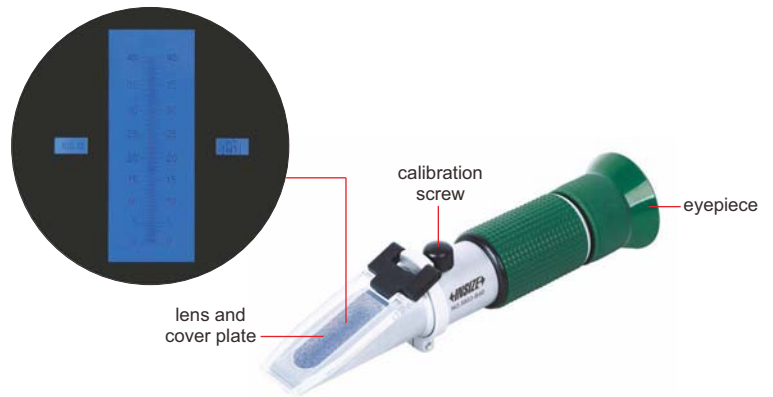

## DIGITAL STOPWATCH CODE DSW-A010

- Split time, total time and continuous time can be displayed
- 10 groups of results can be read out from memory after resetting
- Scroll back and forth to read out the memory digits
- The fastest, slowest and average time can be displayed
- Able to record the split times (00-199)

### SPECIFICATION

Measuring range	0~9 hours, 59 minutes, 59.99 seconds	
Resolution	0.01s	
Accuracy	±0.5s	
Function	memory	10 groups
	timer	up to 10 hours
	time	12-hour or 24-hour time display, alarm can be set
Power supply	LR44 battery	
Screen dimension	33.6×13.6mm	
Dimension	76×63×16mm (metal case)	

### STANDARD DELIVERY

Main unit	1 pc
String	1 pc



## STROKE COUNTER CODE 7600-6

- Accumulate and record the number of mechanical movements
- Rotate back to zero



### SPECIFICATION

Code	Number of digits	Range
7600-6	6	0-999999

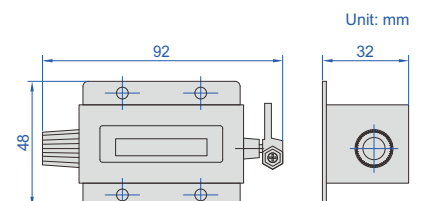

## DIGITAL MOISTURE METER CODE 9341-50

- Suitable for wood, smooth cement, hard gypsum, mixed mortar, brick, etc.
- Measure moisture, temperature and relative humidity
- Temperature type: ambient, dew point, wet bulb
- Maximum and minimum modes
- Automatic power off

### SPECIFICATION

Measuring depth		0~50mm
Measuring range	moisture	0~60%
	temperature	-10~50°C/14~122°F
	relative humidity	0~100%RH
Accuracy	moisture	±2%
	temperature	±2%
	relative humidity	±5%RH
Resolution	moisture	0.1%
	temperature	0.1°C/0.1°F
	relative humidity	0.1%RH
Sampling time		0.5s for moisture 1s for temperature and relative humidity
Power supply		2×AAA batteries
Dimension		130×56×29mm
Weight		206g



### STANDARD DELIVERY

Main unit	1 pc
Battery (AAA)	2 pcs

## INDUCTIVE MOISTURE METER CODE 0120-IM24

- Suitable for wood, gypsum and cement
- MAX/MIN/HOLD mode
- Alarm function
- Low battery indication
- Auto power off

### SPECIFICATION

Measuring range	0~100%
Resolution	1%
Accuracy	±4%
Detection depth	20~40mm
Sampling time	0.5s
Battery	9V
Dimension	185×55×38mm
Weight	193g



### STANDARD DELIVERY

Main unit	1 pc
Battery	1 pc

# DIFFERENTIAL PRESSURE MANOMETER CODE 0140-DP05

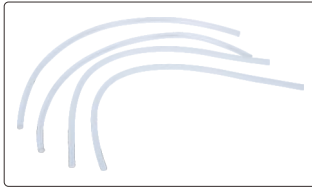

soft tubes (included)

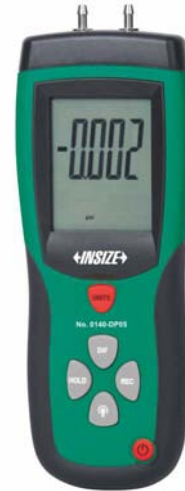

- Offset and differential measurement
- Record maximum/minimum/average value with relative timestamp
- Built-in USB interface for data transmission
- Unit: psi, inH<sub>2</sub>O, bar, mbar, kPa, inHg, mmHg, oz/in<sup>2</sup>, ftH<sub>2</sub>O, cmH<sub>2</sub>O, kg/cm<sup>2</sup>
- Zero adjust
- Data hold
- Display with backlight
- Low battery indication
- Automatic power off
- Safety rating: CAT III 600V

## SPECIFICATION

<b>Pressure range</b>	-5~5psi											
<b>Maximum pressure</b>	20psi											
<b>Unit</b>	psi	inH <sub>2</sub> O	bar	mbar	kPa	inHg	mmHg	oz/in <sup>2</sup>	ftH <sub>2</sub> O	cmH <sub>2</sub> O	kg/cm <sup>2</sup>	
<b>Range</b>	5	138.3	0.344	344.7	34.47	10.18	258.5	80	11.53	351.5	0.351	
<b>Resolution</b>	0.001	0.1	0.001	0.1	0.01	0.01	0.1	0.01	0.01	0.1	0.001	
<b>Accuracy</b>	±0.3%FSO (25°C)											
<b>Repeatability</b>	±0.2% (Max. ±0.5%FSO)											
<b>Linearity/hysteresis</b>	±0.29%FSO											
<b>Response time</b>	0.5s typical											
<b>Operation temperature</b>	0°C~50°C											
<b>Power supply</b>	1×9V 6F22 battery or AC/DC adapter											
<b>Dimension (LxWxH)</b>	165×90×40mm											
<b>Weight</b>	350g											

## STANDARD DELIVERY

<b>Main unit</b>	1 pc
<b>AC/DC adapter</b>	1 pc
<b>9V battery</b>	1 pc
<b>Software flash disk</b>	1 pc
<b>USB cable</b>	1 pc
<b>Soft tubes</b>	4 pcs

software (included), connect to PC via USB cable

export data

display realtime value and curve

export data to Excel

## ANEMOMETER CODE 0110-1125

- Measure air velocity and temperature
- Min/Max, data hold function
- Bluetooth 4.0
- Auto power off
- Supplied with APP for Apple and Android

App measurement

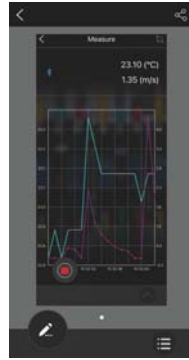

App record

No.	Data Value (°C)	Data Value (m/s)
1	23.10	0.22
2	23.10	0.00
3	23.00	0.00
4	23.10	4.39
5	23.10	1.85
6	23.00	1.06
7	23.00	0.72
8	23.00	0.44



### SPECIFICATION

	Unit	Measuring range	Resolution	Accuracy
Air velocity	m/s	1.1~25.0	0.01	±(3%+0.3)
	km/h	4~90	0.1	±(3%+1)
	ft/min	220~4920	1	±(3%+40)
	MPH	2.5~56.0	0.1	±(3%+0.4)
	knots	2.2~48.0	0.1	
Air temperature	°C	0~50	0.1	±2
	°F	32~122	0.1	±4
Sensors	air velocity sensor, NTC-type precision thermistor			
Sampling time	0.5s			
Operation altitude	max 2000m			
Operation environment	0~50°C, 0~80%RH			
Storage environment	-10~60°C, 0~80%RH			
Auto power off	10 minutes			
Data port	bluetooth 4.0			
Power supply	9V			
Dimension	213×54×36mm			
Weight	172g			

### STANDARD DELIVERY

Main unit	1 pc
Battery	1 pc

## BOURDON TUBE PRESSURE GAGES (LIQUID FILLED)

CAN BE  
CUSTOMIZED

- Stainless steel case and bezel, copper alloy internals
- Shock-proof and pulse-proof
- Suitable for pneumatic systems, hydraulic systems and compressed air systems

Dial size	Ø63mm		
Process connection	1/4BSP	1/4ZG	1/4NPT
Connector location	bottom	bottom	bottom
Range (0~10bar/0~150psi)	5201-63B2Y10	5201-63Z2Y10	5201-63N2Y10

### SPECIFICATION

Accuracy class	1.6
Ambient temperature	-20~60°C
Medium temperature	≤60°C



5201-63B2Y10



## SOUND LEVEL METER (PROFESSIONAL TYPE) CODE 0011-FA25

software (included), monitor and collect data to PC software via USB cable,  
data can sent to Excel

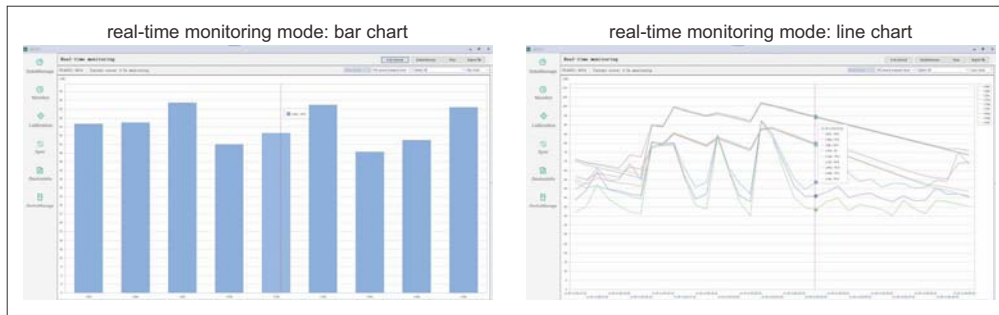

- Integral function: 1s~24h (adjustable)
- Wide frequency range, large dynamic range, low background noise
- Parallel time weight and frequency weight
- Single range without shifting
- Software is included: on-line monitoring, data storage



### SPECIFICATION

Accuracy	IEC 61672-1:2013 class 2
Microphone	1/2 inch prepolarized condenser microphone
Measuring range	25dB (A)~141dB (A); 35dB (C)~141dB (C); 50dB (Z)~141dB (Z) other frequency linear ranges: 31.5Hz: 26dB (A)~101dB (A); 12.5kHz: 25dB (A)~136dB (A)
Frequency	20Hz~12.5kHz
Self-generated electrical noise	<17dB (A), <23dB (C), <33dB (Z)
Frequency weighting	parallel A, C, Z weightings
Time weighting	parallel F (Fast), S (Slow), I (Impulse) weightings
Measuring function	Lp, Leq,t, Leq,T, Lmax, Lmin, Lpeak, SEL
Integral time	1s-24h (adjustable)
Start mode	button/clock/limit/interval
Power setting	power on or off regularly
Data storage	4MB FLash RAM 4 sets of parameter templates, 128 measurement point names; 64 calibration records
Language	Chinese, English, Portuguese
Power	<80mA/5V
Power supply	4×AAA batteries (for 10 hours working) AC/DC adapter: 5V/2A
Operation condition	temperature: -10°C~50°C humidity: 25%RH~90%RH, non-condensing pressure: 65kPa~108kPa
Dimension	230×69×26mm
Weight	180g

### STANDARD DELIVERY

Main unit	1 pc
Software	1 pc
Windscreen	1 pc
Battery (AAA)	4 pcs
AC/DC adapter	1 pc

## DIGITAL SOUND LEVEL METER (ADVANCED TYPE) CODE 9353-413

- Automatic range conversion
- Over range indicator
- Maximum mode
- Data hold
- AC signal output: 0.707Vrms, impedance approx.100Ω
- DC signal output: 20mV/dB, impedance approx.1kΩ

### SPECIFICATION

Measuring range	40dB~130dB (ref.20μPa)
Frequency	20Hz~12.5kHz
Resolution	0.1dB
Accuracy	IEC 61672-1:2013 class 2
Frequency weighting	A weighting
Response time	fast (125ms), slow (1s)
Microphone	pre polarization condenser microphone
Refercner direction	axial direction of condenser microphone
Power supply	4×1.5V AAA batteries
Dimension	210×68×27mm
Weight	240g



### STANDARD DELIVERY

Main unit	1 pc
Battery (AAA)	4 pcs
Precision screwdriver	1 pc

## SOUND LEVEL METER (BASIC TYPE) CODE 0010-A35

- Auto range selection
- Over range indication
- Display backlight
- Min/Max, data hold function
- Bluetooth 4.0
- Auto power off
- Supplied with APP for Apple and Android

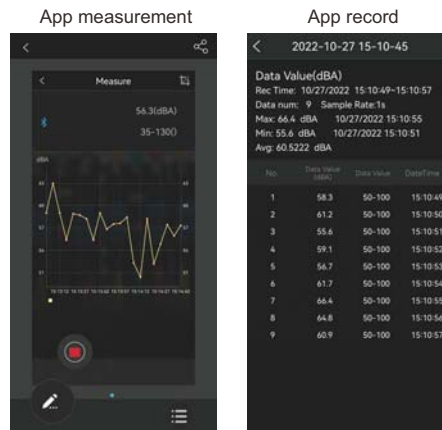

### SPECIFICATION

Frequency	31.5Hz~8KHz
Measuring range	35dB~130dB
Accuracy	±3.0dB (ref 94dB@1kHz)
Resolution	0.1dB
Frequency weighting	A and C
Display update	2 times/sec
Microphone	1/2 inch electret condenser microphone
Power supply	9V battery
Operation temperature and humidity	0°C~40°C/32°F~104°F, 10%RH~90%RH
Dimension	185×54×36mm
Weight	184g



### STANDARD DELIVERY

Main unit	1 pc
Battery	1 pc
Windscreen	1 pc

**DATA OUTPUT**

**DIGITAL SOUND LEVEL METER  
CODE 9351-130**

- Automatically select best range: 30~80dB, 40~90dB, 50~100dB, 60~110dB, 70~120dB, 80~130dB
- Over range indicator
- Real time, average, maximum modes
- Memory 16000 measurement values
- AC signal output: 0.707 Vrms at FS, impedance approx. 600Ω
- DC signal output: 10mV/dB, impedance approx.100Ω
- Automatic power off

**SPECIFICATION**

Measuring range	30~130dB
Accuracy	±2dB
Resolution	0.1dB
Sampling time	0.5s for digital, 0.05s for analogue
Response time	fast: 125ms, slow: 1s
Frequency	30Hz~8KHz
Frequency weighting	A/C
Microphone	electret condenser type
Output	RS232, AC/DC
Power supply	6×AAA batteries
Dimension	265×80×69mm
Weight	317g

**STANDARD DELIVERY**

Main unit	1 pc
Software and RS232 cable	1 pc
Output connector	1 pc
Battery (AAA)	6 pcs



software flash disk (included)



VIDEO

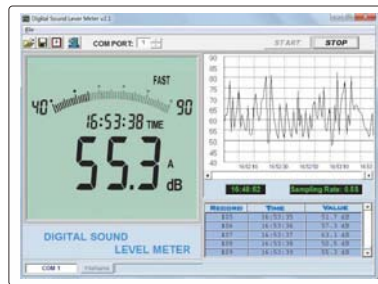

software (included), display measurement values and graph, save and output data

**LIGHT METER  
CODE 0131-A120**

- Photosensor can rotate 90° clockwise and 180° counterclockwise
- Build-in calibration filters ensure the accuracy when working in different colors
- Data hold function
- Lux/FC unit switch
- Low battery alarm

**SPECIFICATION**

Measuring range	0.1~199.9Lux	1~1999Lux	10~19990Lux	100~199900Lux
Resolution	0.1Lux	1Lux	10Lux	100Lux
Measuring range	0.01~19.99FC	0.1~199.9FC	1~1999FC	10~19990FC
Resolution	0.01FC	0.1FC	1FC	10FC
Accuracy	±(4%+10d), range<20000Lux/2000FC ±(5%+10d), range≥20000Lux/2000FC (d is resolution, calibrated with standard incandescent lamp at color temperature 2856K)			
Repeatability	±2%			
Sampling time	0.5s			
Operation environment	0~40°C, 0~70%RH			
Storage environment	-10~50°C, 0~80%RH			
Battery	9V			
Dimension	185×68×38mm			
Weight	130g			

rotate 90° clockwise      rotate 180° counterclockwise



**STANDARD DELIVERY**

Main unit	1 pc
Battery	1 pc

## LIGHT METER (BASIC TYPE) CODE 0130-L110

- Suitable for measuring illuminance in various occasions
- Data hold function
- Fast switching of measuring range, easy to operate

### SPECIFICATION

Measuring range	1~1999Lux	10~19990Lux	100~100000Lux
Resolution	1Lux	10Lux	100Lux
Accuracy	±(4%+10d), range<10000Lux ±(5%+10d), range≥10000Lux (d is resolution, calibrated with standard incandescent lamp at color temperature 2856K)		
Repeatability	±2%		
Sampling time	0.5s		
Operation environment	0~40°C, 0~70%RH		
Storage environment	-10~50°C, 0~80%RH		
Battery	9V		
Photodetector dimension	105×58×28mm		
Main unit dimension	130×72×30mm		
Weight	170g		



### STANDARD DELIVERY

Main unit	1 pc
Battery	1 pc

## UV LIGHT METER CODE 0132-UV199

- Self-recognize probes
- Real-time value, maximum value, minimum value, average value, time, energy value are displayed at the same time



### MAIN UNIT SPECIFICATION

Display	240×160 LCD
Power supply	4 AAA alkaline batteries
Dimension	148×76×26mm
Weight	194g

### STANDARD DELIVERY

Main unit	1 pc
Probe 0132-UVA1	1 pc
Battery	4 pcs



probe  
0132-UVA1  
(included)

### PROBE SPECIFICATION

Probe code	0132-UVA1 (included)	0132-UVC0 (optional)	0132-UVCWP1 (optional)
Application	general purpose low power UVA intensity and energy measurement	intensity and energy measurement of 254nm UV sterilization mercury lamp	intensity and energy measurement of 254nm UV sterilization mercury lamp
Spectral response	$\lambda_p=365\text{nm}$ 315nm-400nm	$\lambda_p=254\text{nm}$ 230nm-280nm	
Power measuring range	0~200000 $\mu\text{W}/\text{cm}^2$		
Resolution	0.1 $\mu\text{W}/\text{cm}^2$		
Energy measuring range	0-9999999 $\mu\text{J}/\text{cm}^2$		
Measuring accuracy	±10%		
Record time	0-99999s		
Sampling speed	6 times/second		
Measuring unit	$\mu\text{W}/\text{cm}^2$ (default), $\text{mW}/\text{cm}^2$ , $\text{W}/\text{m}^2$		
Test hole diameter	Ø10mm		
Probe size	39×32×15mm	Ø39×15mm	Ø50×20mm
Waterproof depth	—	—	1m

To be continued

Continued from previous page

Probe code	0132-UVLED0 (optional)	0132-UVB0 (optional)	0132-UVA0 (optional)
Application	measurement of 260nm-285nm UV LED sterilization lamp	general purpose UVB intensity and energy measurement	intensity and energy measurement of light source of high pressure mercury lamp in UV curing industry
Spectral response	280nm-315nm *	$\lambda_p=310nm$ ** 280nm-315nm	$\lambda_p=365nm$ 315nm-400nm
Power measuring range	0~200000 $\mu W/cm^2$		0~2000mW/cm <sup>2</sup>
Resolution	0.1 $\mu W/cm^2$		0.1mW/cm <sup>2</sup>
Energy measuring range	0-9999999 $\mu J/cm^2$		
Measuring accuracy	±10%		
Record time	0-99999s		
Sampling speed	6 times/second		2048 times/second
Measuring unit	$\mu W/cm^2$ (default), mW/cm <sup>2</sup> , W/m <sup>2</sup>		mW/cm <sup>2</sup> (default), W/m <sup>2</sup>
Test hole diameter	Ø10mm		
Probe size	Ø39×15mm		39×32×15mm

\*Wide spectral range, avoid using in strong light

\*\* Suitable for measuring UVB light source with wavelength 297nm, 308nm, and 313nm

Probe code	0132-UVALED0 (optional)	0132-UVALED1 (optional)	0132-UVALED3 (optional)
Application	intensity and energy measurement of area light source of UV LED in UV curing industry	intensity and energy measurement of point light source of UV LED in UV curing industry	general purpose UVA+UVV LED intensity and energy measurement, low power measuring range
Spectral response	calibrated with 395nm UV LED 340nm-420nm		
Power measuring range	0~20000mW/cm <sup>2</sup>		0~200000 $\mu W/cm^2$
Resolution	1mW/cm <sup>2</sup>		0.1 $\mu W/cm^2$
Energy measuring range	0-9999999 $\mu J/cm^2$		
Measuring accuracy	±10%		
Record time	0-99999s		
Sampling speed	2048 times/second		6 times/second
Measuring unit	mW/cm <sup>2</sup> (default), W/cm <sup>2</sup> , W/m <sup>2</sup>		$\mu W/cm^2$ (default), mW/cm <sup>2</sup> , W/m <sup>2</sup>
Test hole diameter	Ø10mm	Ø1mm	Ø10mm
Probe size	39×32×15mm		

- Detect combustible gas (EX, including CH<sub>4</sub>, C<sub>3</sub>H<sub>8</sub>, H<sub>2</sub>, etc), O<sub>2</sub>, CO or H<sub>2</sub>S, support more than 30 types of gas sensors, customization for detecting toxic gases (such as NO, NH<sub>3</sub>, PH<sub>3</sub>, etc) available
- Adjustable alarm level, alarm mode: sound, light, vibration
- Adjustable calibration level
- Sampling method: natural diffusion
- High concentration protection for sensor
- Up to 500 alarm records storage capacity
- Self-test on startup
- Display with backlight
- Language: English, Chinese
- Low battery indication
- Explosion proof level: Ex ib IIB T3 Gb

**IP65**  
WATERPROOF



calibration cap (included)

## SINGLE GAS DETECTORS



0611-SG01

### SPECIFICATION

Code	0611-SG01	0611-SG02	0611-SG03	0611-SG04
Gas	combustible gas/EX	O <sub>2</sub>	CO	H <sub>2</sub> S
Range	0-100%LEL	0-30%vol	0-1000ppm	0-100ppm
Resolution	1%LEL	0.1%vol	1ppm	1ppm
Accuracy	±5%FS			
Response time	T <sub>90</sub> <60s			
Operation environment	temperature: -10°C~55°C; humidity: <95%RH, no condensation			
Sensor lifetime	2 years (depending on working environment)			
Power supply	3.7V rechargeable Li-ion battery, working time>8h			
Dimension (LxWxH)	124×60×46mm			
Weight	205g			

### STANDARD DELIVERY

Main unit	1 pc
Calibration cap	1 pc
AC/DC adapter and charging cable	1 pc

## MULTI GAS DETECTOR CODE 0612-MG04

DATA  
OUTPUT

IP66  
WATERPROOF



software flash disk  
(included)



charging cable (included)



calibration cap (included)



charging and data transmission  
interface on the back

- Detect combustible gas (EX, including CH<sub>4</sub>, C<sub>3</sub>H<sub>8</sub>, H<sub>2</sub>, etc), oxygen (O<sub>2</sub>), carbon monoxide (CO) and hydrogen sulfide (H<sub>2</sub>S), optional configuration includes other toxic gases such as NO, NH<sub>3</sub>, PH<sub>3</sub>, etc; support more than 30 types of gas sensors, flexible sensor combination and customization available
- Adjustable alarm level, alarm mode: sound, light, vibration and screen display
- Adjustable calibration level
- Sampling method: natural diffusion
- High concentration protection for sensor
- Data transmission via charging interface
- Up to 1000 alarm records storage capacity
- Self-test on startup
- Display with backlight
- Language: English, Chinese and Spanish (Portuguese and Russian customizable)
- Low battery indication
- Explosion proof level: Ex ib IIC T4 Gb

28

### SPECIFICATION

Gas	combustible gas (EX)	O <sub>2</sub>	CO	H <sub>2</sub> S
Range	0-100%LEL	0-30%vol	0-1000ppm	0-100ppm
Resolution	1%LEL	0.1%vol	1ppm	1ppm
Accuracy	±5%FS			
Response time	T <sub>90</sub> <60s			
Operation environment	temperature: -10°C~50°C; humidity: <95%RH, no condensation			
Sensor lifetime	2 years (depending on working environment)			
Power supply	3.7V rechargeable Li-ion battery, working time>8h			
Dimension (LxWxH)	150×72×48mm			
Weight	310g			

### STANDARD DELIVERY

Main unit	1 pc
Calibration cap	1 pc
Software and USB cable	1 pc
AC/DC adapter	1 pc

software (included), connect to PC via USB cable, display test data and export record

display real-time data and alarm record

export history data and alarm record

DATA  
OUTPUT



## TESLAMETERS (GAUSSMETERS)

- Measure magnetic induction of DC magnetic field
- Directly display the N/S polarity of the measured magnetic field
- One-key zero function: eliminate the influence of zero drift before measurement
- Maximum value hold: record the maximum value of the changing magnetic field
- Unit switch between mT or G (1mT=10G)
- Auto ranging
- Built-in USB interface for data transmission
- Display with backlight
- Auto power off

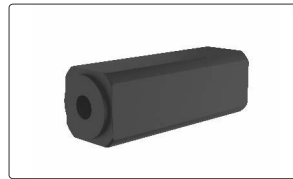

magnetic shielding cavity  
(optional)



axial probe (optional)



0501-MA01

radial probe  
(included)

### SPECIFICATION

Code	0501-MA01	0501-MA05
Range	2000mT	
Resolution	0.01mT (0~200mT) 0.1mT (200~2000mT)	
Accuracy	±1.0%	±2.0% (≤1000mT) ±5.0% (1000mT~2000mT)
Temperature coefficient	±0.1%/K	
Zero drift	±0.5mT/h	
Interface	USB	
Power supply	3×1.5V AA batteries or USB	
Dimension (L×W×H)	165×90×40mm	
Weight	350g	

### STANDARD DELIVERY

Main unit	1 pc
Radial probe	1 pc
Battery (AA)	3 pcs

### OPTIONAL ACCESSORY

Axial probe	0501-PA
Magnetic shielding cavity	0501-SHIELD

- Laser sensor, direct measurement, easy to use
- Two sensors: internal and external, external sensor is suitable for measurement in narrow spaces
- Automatic power off

### SPECIFICATION

Measuring range	10~800Hz	
Input parameter range	maximum free belt length: 99.99m maximum belt weight: 9.999kg/m	
Accuracy	±5%	
Unit	N, lbf	
Measuring distance	3~20mm	
Operation temperature	10~50°C	
Power supply	4×1.5V AAA batteries	
Dimension	main unit	178×72×34mm
	external sensor	124×21×12mm
Weight	180g	

### STANDARD DELIVERY

Main unit	1 pc
External sensor	1 pc

## LASER BELT TENSION METER CODE 5900-HZ18



external sensor

internal sensor

## LIGHT TRANSMITTANCE METER CODE 5804-LT21



- Suitable for light transmittance testing of various "regular transmission materials", such as building glasses, auto glasses, transparent films, plastic products, etc.
- With the design of parallel optical path of the light source and condensed light of the receiver, it can measure up to 100mm thickness
- Can measure the high transparent materials such as K9 glasses
- Two measuring modes, fixed base and handheld
- Conforming to CIE photopic luminosity function

### SPECIFICATION

Optical source	380nm~760nm, conforming to CIE photopic luminosity function
Measuring range	0.001%~99.8%
Accuracy	±1%
Resolution	0.001% (0%~10%), 0.01% (10%~100%)
Thickness to be measured	<100mm
Diameter to be measured	>10mm
Power supply	4×1.5V AAA batteries
Dimension	75×140×25mm
Weight	634g



regular transmission

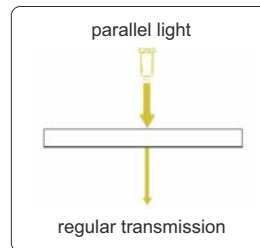

when the light penetrates a flat and evenly textured transparent material, the light does not change its direction

diffused transmission

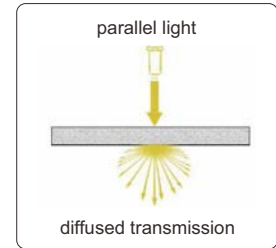

when the light penetrates a material with a rough surface or uneven texture, the light spreads out

### STANDARD DELIVERY

Main unit	1 pc
Transmitter	1 pc (connect to main unit)
Receiver	1 pc (connect to main unit)
Fixed base	1 pc
1.5V AAA battery	4 pcs

## DIGITAL GLASS THICKNESS METER CODE 5805-GT22



- Laser reflection principle to measure the thickness of glass and internal air layer. Especially suitable for building laminated glasses, hollow glass windows, etc.
- To test the thickness of single layer glasses, multi-layer glasses, two glasses with one cavity, three glasses with two cavities, laminated glasses, laminated insulating glasses, etc.

### SPECIFICATION

Measuring range	glass thickness (0~70mm), air layer (0~45mm)
Accuracy	±0.1mm (measuring range≤63mm), ±0.2mm (measuring range>63mm)
Resolution	0.01mm
Display	LCD
Power supply	4×1.5V AAA batteries
Dimension	130×72×33mm
Weight	330g



### STANDARD DELIVERY

Main unit	1 pc
Cross screwdriver	1 pc
1.5V AAA battery	4 pcs





DC Resistance Testers  
Page 738



DC Power Supplies  
Page 739



Digital Multimeters  
Page 739-743



Digital AC/DC Clamp Meters  
Page 744



Voltage Testers  
Page 745

# DC RESISTANCE TESTER CODE 9651-RM20



- Maximum reading: 220000
- Basic accuracy: 0.05%
- 3.5 inch LCD screen
- Temperature compensation function
- Short-circuit zeroing calibration
- Bad contact detection
- Comparator: pass or fail judge
- Keyboard lock function



temperature probe (included)



test clip (included)



RS232 communication cable (included)

## SPECIFICATION

Function	Range	Resolution	Accuracy ("d" is the least reading)
Slow test	20mΩ	0.001mΩ	±(0.1%+3d)
	200mΩ/2Ω/20Ω/200Ω/ 2kΩ/20kΩ/200kΩ	0.001mΩ/0.00001Ω/0.0001Ω/0.001Ω/ 0.00001kΩ/0.0001kΩ/0.001kΩ	±(0.05%+2d)
	2MΩ	0.0001MΩ	±(0.1%+5d)
Medium test	20mΩ	0.001mΩ	±(0.2%+5d)
	200mΩ/2Ω/20Ω/200Ω/ 2kΩ/20kΩ/200kΩ	0.001mΩ/0.00001Ω/0.0001Ω/0.001Ω/ 0.00001kΩ/0.0001kΩ/0.001kΩ	±(0.1%+3d)
	2MΩ	0.0001MΩ	±(0.2%+5d)
Fast test	20mΩ	0.01mΩ	±(0.8%+5d)
	200mΩ/2Ω/20Ω/200Ω/ 2kΩ/20kΩ/200kΩ	0.01mΩ/0.0001Ω/0.001Ω/0.01Ω/ 0.0001kΩ/0.001kΩ/0.01kΩ	±(0.5%+5d)
	2MΩ	0.001MΩ	±(0.8%+5d)
Range mode	auto range, manual range and nominal range		
Test speed	slow: 3t/s, medium: 18t/s, fast: 60t/s		
Trigger	internal trigger, manual trigger, external trigger		
Interface	handler interface, RS232 interface, RS485 interface, USB interface and temperature compensation interface		
Power supply	AC: 100V~240V, 50Hz/60Hz		
Dimension (L×W×H)	307×264×107mm		
Weight	2.5kg		

## STANDARD DELIVERY

Main unit	1 pc
RS232 communication cable	1 pc
Temperature probe	1 pc
Test clip	1 pc

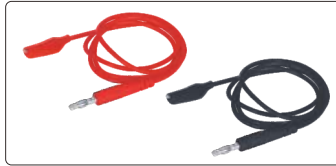

test leads (included)

## DC POWER SUPPLY CODE 9911-PS305



### SPECIFICATION

Voltage	range	30V
	setting resolution	10mV
	setting accuracy	$\leq 0.1\% + 10\text{mV}$
	readback resolution	10mV
	readback accuracy	$\leq 0.1\% + 10\text{mV}$
	load regulation	$\leq 0.1\% + 5\text{mV}$
	line regulation	$\leq 0.01\% + 5\text{mV}$
	ripple	10mVrms
Current	range	5A
	setting resolution	1mA
	setting accuracy	$\leq 0.2\% + 10\text{mA}$
	readback resolution	1mA
	readback accuracy	$\leq 0.2\% + 10\text{mA}$
	load regulation	$\leq 0.2\% + 3\text{mA}$
	line regulation	$\leq 0.2\% + 3\text{mA}$
ripple	8mArms	
OVP	0~33V	
OCP	0~5.5A	
Work condition	temperature: 0~40°C, humidity: $\leq 80\%$ RH	
Storage condition	temperature: -20~60°C, humidity: $\leq 80\%$ RH	
Cool system	fan cool	
Power supply	AC 220V $\pm 10\%$ , 50Hz/60Hz	
Dimension (L×W×H)	230×80×150mm	
Weight	1.45kg	

- Four-digit LED display
- Output power display
- Output switch control
- 10mV/1mA high accuracy and resolution
- Panel locking function to prevent misoperation
- USB interface for power supply
- OVP/OCP protection
- 3 shortcut keys for presetting

### STANDARD DELIVERY

Main unit	1 pc
Test lead	2 pcs

- Auto/manual ranging
- Maximum mode
- Data hold
- NCV detection
- Low battery indication
- Auto power off
- Safety rating: CAT III 600V

### STANDARD DELIVERY

Main unit	1 pc
Test lead	1 pc
Clip	2 pcs
Battery (AAA)	2 pcs



clips (included)



test lead (included)

### SPECIFICATION

Function	Range	Resolution	Accuracy
DC Voltage	200mV/2V/20V/200V/600V	0.1mV/1mV/10mV/0.1V/1V	$\pm(0.7\%+2)$
AC Voltage	200mV/2V/20V/200V	0.1mV/1mV/10mV/0.1V	$\pm(0.8\%+3)$
	600V	1V	$\pm(1.0\%+3)$
DC Current	20mA/200mA	10 $\mu$ A/0.1mA	$\pm(1.5\%+3)$
AC Current	20mA/200mA	10 $\mu$ A/0.1mA	$\pm(2.0\%+3)$
Resistance	200 $\Omega$	0.1 $\Omega$	$\pm(1.0\%+3)$
	2k $\Omega$ /20k $\Omega$ /200k $\Omega$ /2M $\Omega$	1 $\Omega$ /10 $\Omega$ /0.1k $\Omega$ /1k $\Omega$	$\pm(1.0\%+1)$
	20M $\Omega$	10k $\Omega$	$\pm(1.0\%+5)$
Logic level test	<1.5V (green LED on); 1.5~3.5V (green & red LED off); >3.5V (red LED on)		
Diode	open circuit voltage 1.5V		
Continuity buzzer	<50 $\Omega$		
Power supply	2×1.5V AAA batteries		

## PEN-TYPE DIGITAL MULTIMETER CODE 9241-ML200



## DIGITAL MULTIMETER CODE 9216-F520



test leads (included)

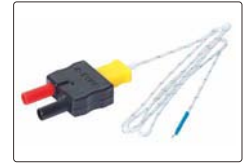

temperature probe and  
adapter (included)

- 2000 counts digital display
- Auto ranging (except 200mV AC)
- Data hold
- Max hold
- Display with backlight
- Low battery indication
- Auto power off
- Safety rating: CAT III 600V

### SPECIFICATION

Function	Range	Resolution	Accuracy ("d" is the least reading)
DC Voltage	200mV	0.1mV	$\pm(0.5\%+2d)$
	2V/20V/200V	0.001V/0.01V/0.1V	$\pm(1.0\%+2d)$
	600V	1V	$\pm(1.2\%+2d)$
AC Voltage (50~60Hz)	200mV	0.1mV	$\pm(1.5\%+30d)$
	2V	0.001V	$\pm(1.2\%+3d)$
	20V/200V	0.01V/0.1V	$\pm(1.5\%+3d)$
DC Current	600V	1V	$\pm(2.0\%+4d)$
	200μA	0.1μA	$\pm(1.0\%+3d)$
	2000μA/20mA/200mA	1μA/0.01mA/0.1mA	$\pm(1.5\%+3d)$
AC Current (50~60Hz)	10A	0.01A	$\pm(2.5\%+5d)$
	200μA	0.1μA	$\pm(1.5\%+5d)$
	2000μA/20mA/200mA	1μA/0.01mA/0.1mA	$\pm(1.8\%+5d)$
Resistance	10A	0.01A	$\pm(3.0\%+7d)$
	200Ω	0.1Ω	$\pm(1.2\%+4d)$
	2kΩ	0.001kΩ	$\pm(1.0\%+2d)$
	20kΩ/200kΩ/2MΩ	0.01kΩ/0.1kΩ/0.001MΩ	$\pm(1.2\%+2d)$
Temperature (type-K)	20MΩ	0.01MΩ	$\pm(2.0\%+3d)$
	-50°C to 1000°C	1°C	$\pm(3.0\%+5°C)$
Diode test	-58°F to 1832°F	1°F	$\pm(3.0\%+8°F)$
	test current: 0.3mA typical	1mV	$\pm(10\%+5d)$
Continuity check	less than 100Ω		
Power supply	9V battery		
Dimension (L×W×H)	150×70×48mm		
Weight	255g		

### STANDARD DELIVERY

Main unit	1 pc
Thermocouple adapter	1 pc
Temperature probe	1 pc
9V battery	1 pc
Test lead	2 pcs

## MINI DIGITAL MULTIMETER (BASIC TYPE) CODE 9242-ML100A

- Portable size with protective case
- 1999 counts digital display
- Data hold
- Display with backlight
- Low battery indication
- Auto power off
- Safety rating: CAT II 600V

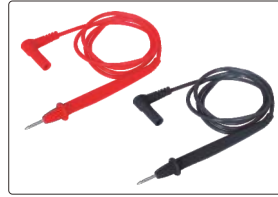

test leads (included)

POPULAR  
MODEL



VIDEO



### SPECIFICATION

Function	Range	Resolution	Accuracy ("d" is the least reading)
DC Voltage	200.0mV	0.1mV	$\pm(0.7\%+3d)$
	2000mV	1mV	$\pm(0.5\%+2d)$
	20.00V/200.0V/600V	0.01V/0.1V/1V	$\pm(0.7\%+3d)$
AC Voltage (40~400Hz)	200.0V/600V	0.1V/1V	$\pm(1.2\%+3d)$
DC Current	200.0μA/200.0mA	0.1μA/0.1mA	$\pm(1.0\%+2d)$
	10.00A	0.01A	$\pm(1.2\%+5d)$
Resistance	200.0Ω	0.1Ω	$\pm(1.0\%+2d)$
	2000Ω/20.00kΩ/200.0kΩ	1Ω/0.01kΩ/0.1kΩ	$\pm(0.8\%+2d)$
	20.00MΩ	0.01MΩ	$\pm(1.2\%+3d)$
Battery test	1.5V/9V/12V battery check		
Diode test	open circuit voltage: 2.1V DC		
Continuity test	<50Ω		
Power supply	2×1.5V AAA batteries		
Dimension (L×W×H)	134×77×47mm		
Weight	206g		

### STANDARD DELIVERY

Main unit	1 pc
Battery (AAA)	2 pcs
Test lead	2 pcs

29

## SMART DIGITAL MULTIMETER CODE 9247-190



test leads (included)



VIDEO



- Automatically identify test modes for AC voltage/DC voltage/resistance/continuity
- NCV detection and judge the strength by light and buzzer
- Self-calibration when power on to ensure accuracy
- LIVE firewire recognition
- Display with backlight
- True RMS measurement
- Data hold
- Low battery indication
- Auto power off
- Safety rating: CAT III 600V

### STANDARD DELIVERY

Main unit	1 pc
Test lead	2 pcs
Battery (CR2032)	2 pcs

### SPECIFICATION

Function	Range	Resolution	Accuracy
DC Voltage	60mV/600mV/6V/60V/600V	0.01mV/0.1mV/0.001V/0.01V/0.1V	$\pm(0.5\%+3)$
AC Voltage	60mV/600mV/6V/60V/600V	0.01mV/0.1mV/0.001V/0.01V/0.1V	$\pm(1.0\%+3)$
DC Current	6000μA/60mA/600mA	1μA/0.01mA/0.1mA	$\pm(1.2\%+5)$
AC Current	6000μA/60mA/600mA	1μA/0.01mA/0.1mA	$\pm(1.5\%+5)$
Resistance	600Ω/6kΩ/60kΩ/600kΩ	0.1Ω/0.001kΩ/0.01kΩ/0.1kΩ	$\pm(1.0\%+5)$
	6MΩ/60MΩ	0.001MΩ/0.01MΩ	$\pm(1.5\%+3)$
Capacitance	6nF/60nF/600nF/6μF/60μF/600μF	0.001nF/0.01nF/0.1nF/0.001μF/0.01μF/0.1μF	$\pm(4.0\%+5)$
	6mF/60mF	0.001mF/0.01mF	$\pm(5.0\%+5)$
Frequency	10Hz/100Hz/1000Hz/10kHz/100kHz/1000kHz	0.001Hz/0.01Hz/0.1Hz/0.001kHz/0.01kHz/0.1kHz	$\pm(1.0\%+5)$
	10MHz	0.001MHz	$\pm(3.0\%+5)$
Duty cycle	1~99%	0.1%	$\pm(3.0\%+5)$
Diode measurement	open circuit voltage 2.0V		
Continuity measurement	<50Ω		
Power	2×3V CR2032 batteries		
Dimension (L×W×H)	133×68×18mm		
Weight	178g		

## DIGITAL MULTIMETER (WITH JACK INDICATOR LIGHT) CODE 9246-180



- Jack indicator light: jacks flash green to indicate the corresponding jacks for test leads
- NCV detection and judge the strength by light and buzzer
- Self-calibration when power on to ensure accuracy
- LIVE firewire recognition
- Double color backlight (orange backlight prompts high voltage or current: the orange backlight automatically lights up when voltage is higher than 80V or the current is higher than 1A)
- Large range capacitance meter 100mF
- True RMS measurement
- Battery test function
- Max/Min mode
- Data hold
- Low battery indication
- Auto power off
- Safety rating: CAT III 1000V, CAT IV 600V



test leads (included)

### STANDARD DELIVERY

Main unit	1 pc
Test lead	2 pcs
Battery (AA)	2 pcs

### SPECIFICATION

Function	Range	Resolution	Accuracy
DC Voltage	600mV/6V/60V/600V/1000V	0.1mV/0.001V/0.01V/0.1V/1V	±(0.5%+3)
AC Voltage	6V/60V/600V/750V	0.001V/0.01V/0.1V/1V	±(0.8%+5)
DC Current	60μA/60mA/600mA/10A	0.01μA/0.01mA/0.1mA/0.01A	±(1.2%+3)
AC Current	60mA/600mA/10A	0.01mA/0.1mA/0.01A	±(1.5%+3)
Resistance	600Ω/6kΩ/60kΩ/600kΩ	0.1Ω/0.001kΩ/0.01kΩ/0.1kΩ	±(1.0%+3)
	6MΩ/60MΩ	0.001MΩ/0.01MΩ	±(1.5%+3)
Capacitance	10nF/100nF/1000nF/10μF/100μF/1000μF	0.001nF/0.01nF/0.1nF/0.001μF/0.01μF/0.1μF	±(4.0%+5)
	10mF/100mF	0.001mF/0.01mF	±(5.0%+5)
Frequency	10Hz/100Hz/1000Hz/10kHz/100kHz/1000kHz	0.001Hz/0.01Hz/0.1Hz/0.001kHz/0.01kHz/0.1kHz	±(1.0%+3)
	10MHz	0.001MHz	±(3.0%+3)
Duty cycle	1~99%	0.1%	±(3.0%+3)
Diode measurement	forward DC current 2.5mA, reverse DC voltage 3.0V		
Continuity measurement	<30Ω		
Power	2x1.5V AA batteries		
Dimension (L×W×H)	188×88×50mm		
Weight	424g		



DATA  
OUTPUT



## BLUETOOTH DIGITAL MULTIMETER CODE 9219-KV220

data acquisition app  
(included)



- Built-in bluetooth
- Mobile app included
- 9999 counts digital display
- True RMS measurement
- Display with backlight
- Relative measurement mode
- Auto/manual ranging
- Auto power off
- Data hold
- NCV detection
- Low battery indication
- Safety rating: CAT III 600V

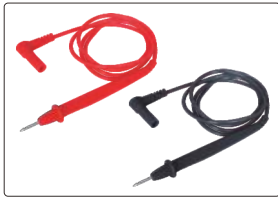

test leads (included)

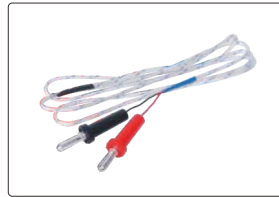

temperature probe (included)

### STANDARD DELIVERY

Main unit	1 pc
Test lead	2 pcs
Temperature probe	1 pc
Battery (AAA)	3 pcs

### SPECIFICATION

Function	Range	Resolution	Accuracy ("d" is the resolution)
DC Voltage	9.999mV/99.99mV	0.001mV/0.01mV	±(0.7%+8d)
	999.9mV/9.999V/99.99V/999.9V	0.1mV/0.001V/0.01V/0.1V	±(0.5%+3d)
AC Voltage (40~400Hz)	9.999mV/99.99mV	0.001mV/0.01mV	±(1.0%+3d)
	999.9mV/9.999V/99.99V/999.9V	0.1mV/0.001V/0.01V/0.1V	±(0.8%+3d)
DC Current	999.9µA	0.1µA	±(0.8%+3d)
	999.9mA/9.999A	0.1mA/0.001A	±(1.0%+3d)
AC Current (40~400Hz)	999.9µA	0.1µA	±(1.0%+3d)
	999.9mA/9.999A	0.1mA/0.001A	±(1.2%+3d)
Resistance	999.9Ω/9.999kΩ/99.99kΩ/999.9kΩ	0.1Ω/0.001kΩ/0.01kΩ/0.1kΩ	±(0.8%+2d)
	9.999MΩ	0.001MΩ	±(1.5%+3d)
	99.99MΩ	0.01MΩ	±(2.0%+5d)
Capacitance	9.999nF	0.001nF	±(4.0%+10d)
	9.999nF/99.99nF/999.9nF/9.999µF /99.99µF/999.9µF	0.001nF/0.01nF/0.1nF/0.001µF /0.01µF/0.1µF	±(4.0%+5d)
	9.999mF	0.001mF	±(10.0%)
Frequency	99.99Hz~9.999MHz	0.01Hz~0.001MHz	±(0.1%+5d)
Temperature	-40~1000°C	-40~0°C	1°C ±4°C
		>0~100°C	1°C ±(1.0%+5d)
		>100~1000°C	1°C ±(2.0%+5d)
	-40~1832°F	-40~32°F	1°F ±5°F
		>32~212°F	1°F ±(1.5%+5d)
		>212~1832°F	1°F ±(2.5%+5d)
Duty cycle	0.1%~99.9%	0.1%	±(3%+5d)
Diode test	open circuit voltage 3.3V, test current 1.5mA		
Continuity check	<30Ω		
Power supply	3x1.5V AAA batteries		
Dimension (L×W×H)	187×88×56mm		
Weight	400g		

# DIGITAL AC/DC CLAMP METER

## CODE 9315-CF210

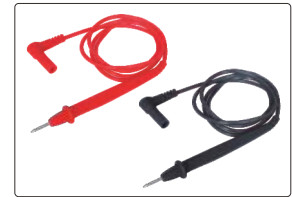

test leads (included)

- 4000 counts display
- 28mm jaw opening
- NCV detection with light and sound alarm
- True RMS measurement
- Auto ranging
- REL (zero) function
- Data hold
- Polarity indication
- LCD screen with backlight
- Low battery indication
- Auto power off
- Safety rating: CAT III 300V/CAT II 600V

### STANDARD DELIVERY

Main unit	1 pc
Battery (AAA)	2 pcs
Test lead	2 pcs

### SPECIFICATION

Function	Range	Resolution	Accuracy ("d" is the least reading)
DC Current	40.00A/400.0A	0.01A/0.1A	±(2.0%+5d)
AC Current *	40.00A/400.0A	0.01A/0.1A	±(2.0%+5d)
DC Voltage	400.0mV	0.1mV	±(0.7%+3d)
	4.000V/40.00V/400.0V/600V	0.001V/0.01V/0.1V/1V	±(0.5%+2d)
AC Voltage *	4.000V	0.001V	±(1.0%+5d)
	40.00V/400.0V/600V	0.01V/0.1V/1V	±(0.8%+5d)
AC Voltage frequency	10Hz~60kHz	0.01Hz~0.01kHz	±(0.5%+2d)
Resistance	400.0Ω	0.1Ω	±(1.0%+2d)
	4.000kΩ/40.00kΩ/400.0kΩ	0.001kΩ/0.01kΩ/0.1kΩ	±(0.8%+2d)
	4MΩ/40MΩ	0.001MΩ/0.01MΩ	±(2.5%+5d)
Capacitance	40.00nF/400.0nF/4.000μF/ 40.00μF/400.0μF	0.01nF/0.1nF/0.001μF/ 0.01μF/0.1μF	±(4.0%+5d)
	4.000mF/40.00mF	0.001mF/0.01mF	±10.0%
Frequency	10Hz~10MHz	0.01Hz~0.01MHz	±(0.1%+4d)
Duty cycle	0.1%~99.0%	0.1%	±(3.0%+5d)
Diode test	open circuit voltage: 4V		
Continuity check	<30Ω		
Power supply	2×1.5V AAA batteries		
Dimension (L×W×H)	215×75×37mm		
Weight	235g		

\* AC voltage/current frequency response: 45Hz~400Hz, true RMS display



## AC PHASE AND VOLTAGE DETECTOR CODE 9723-400

- Non-contact detection of phase sequence, high and low voltage, wire distinction
- Low battery indication
- Auto power off
- Flashlight

### SPECIFICATION

Phase sequence detection	screen shows clockwise or counterclockwise
High and low voltage detection	beep: slow~fast backlight: green~red analog bar: low~high
Wire distinction	green backlight indicates neutral wire red backlight indicates live wire
Power supply	2×1.5V AAA batteries
Dimension	157×27×23mm
Weight	32g



## DIGITAL VOLTAGE TESTER CODE 9721-250

- Direct AC test (contact): 12-250V  
two way display: voltage displays on LCD screen and neon lamp lights up (when voltage>80V)
- Induction AC test (non-contact): 12-250V  
to detect power source or recognize the phase line, ground line and break point
- Direct DC test (contact): 6-36V  
instant sense and display
- Work without battery
- Tester tip: CRV material

### SPECIFICATION

Range	AC: 12-250V; DC: 6-36V
Neon lamp life	30000 times
Dimension	133×21×19mm
Weight	22g



29

## VOLTAGE TESTER CODE 9722-250

- Tester tip: CRV material

### SPECIFICATION

Range	AC: 100-250V
Neon lamp life	30000 times
Dimension	145×Ø15mm
Weight	21g



# 30

## TEMPERATURE AND HUMIDITY MEASUREMENT



**Infrared Thermal Imaging Cameras**  
Page 747-749



**Infrared Thermometers**  
Page 749-750



**Dual-Cavity Blackbody Radiation Sources**  
Page 751



**Infrared And Penetration Thermometers**  
Page 751



**Data Loggers For Temperature And Humidity**  
Page 752



**Thermohygrometers**  
Page 753-755



**Large Screen Temperature And Humidity Meters**  
Page 755



**Temperature And Humidity Data Loggers**  
Page 756-757



**Portable Medium Temperature Dry Block Calibrators**  
Page 757

NON-CONTACT  
TEMPERATURE MEASUREMENT

DATA  
OUTPUT

IP54  
WATERPROOF

## INFRARED THERMAL IMAGING CAMERA (BASIC TYPE) CODE 9132-T400

- IR/visible/laser indicator
- Trigger button for photo taking
- 2-meter drop test, IP54 protection

### STANDARD DELIVERY

Main unit	1 pc
Power supply adapter	1 pc
TYPE-C cable	1 pc
16G TF card	1 pc



### SPECIFICATION

IR image	IR resolution	120×90@17μm
	detector type	VOx/7.5~14μm
	frame rate	25Hz/9Hz
	thermal sensitivity/NETD	60mk
	focal length	2.28mm/F1.13
	field of view (FOV)	50°×38°
	spatial resolution (IFOV)	7.6mrad
	focus	focus-free
Visible camera	visible camera resolution	320×240, focus-free
	flashlight	yes
Image display	display	2.4 inch IPS technology TFT display
	display resolution	320×240
	image model	IR/visible/picture-in-picture
	color palettes	6: white hot, iron red, hot iron, arctic, rainbow 1, rainbow 2
Temperature measurement	temperature range	-20~150°C, 100~400°C (auto switching)
	accuracy	±2°C or ±3%, whichever is greater (target temp ≥0°C, ambient temp is 15~30°C)
	measurement spot	center spot
	measurement area	3 (incl. max & min temp)
	auto max & min spot tracking	yes
Image storage	alarm	full screen max & min spot alarm
	storage media	TF card (16G)
	IR image format	full radiometric (JPG) (120 x 90)
	visible image	yes, 320x240
Connections & communications	USB	TYPE-C, TF card slot
	tripod interface	yes
	mobile APP	yes
Power system	PC IR analysis software	yes
	battery type	rechargeable li ion battery
	battery operation time	>5 hours
Environmental parameters	charging time	internal charge, ≤2.5 hours
	operation temperature	-10~50°C
	storage temperature	-40~70°C
	protection	IP54, 2-meter drop test
	certification	CE/ROHS/FCC
dimension (LxWxH)	194×61.5×76mm	
weight	350g	

front view



# INFRARED THERMAL IMAGING CAMERA CODE 0231-IC650

DATA  
OUTPUT

IP54  
WATERPROOF

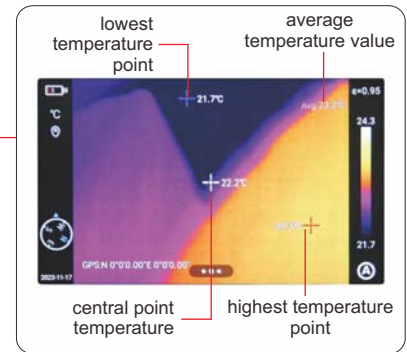

30

- Suitable for electric power, metallurgy, petrochemical, scientific research and teaching, manufacturing, rail transit, building testing, electronic equipment overhaul, mechanical equipment maintenance, etc.
- Four image presentation: IR, VIS, MIF, PIP
- Real-time image can be photographed and video recorded
- Software is included: image browsing, image parameter editing, infrared image analysis, batch report generation, video editing, etc.
- WIFI real-time sharing, one-click connection to mobile device

### STANDARD DELIVERY

Main unit	1 pc
64G SD card	1 pc
Lithium-ion battery	2 pcs
Desktop charger	1 pc
Power adapter	1 pc
Software	1 pc

### SPECIFICATION

Imaging and optics	detector type	unrefrigerated vanadium oxide/7.5μm~14μm
	infrared resolution	256×192@12μm
	super resolution	upgrade to 512×384
	thermal sensitivity/NETD	<45mK
	infrared frame rate	30Hz/9Hz
	focal length	10.5mm
	field of view	25°×19°
	spatial resolution (IFOV)	1.7mrad
	minimum object distance	0.1m
	distance to spot size (D:S)	588:1
	focusing mode	manual/automatic/continuous autofocus
	digital zoom	1.1X~8X
	shot recognition	auto
Measurement and analysis	laser ranging	indication/ranging: 0.1m~40m
	measurement range	support auto-switching: -40°C~150°C, 0°C~650°C
	measurement accuracy	±2°C or ±2%, whichever is greater
	analyzed target	spot×5, line×5, area×5
	tracking/alarm	full screen maximum, minimum and average temperature tracking; the maxium, minimum and average temperature tracking of analyzed target; full screen temperature threshold alarm (image, voice and flash)
Measurement and analysis	temperature measuring parameter	emissivity, reflected temperature, target distance, humidity, atmospheric transmittance, optical transmittance, dew point
	other	isothermals, smart stroke, intelligently calculate the area

To be continued

Continued from previous page

Image display	display screen	4.3", 800×480 pixel touch screen LCD
	digital camera	5MP
	image mode	IR, VIS, MIF, PIP
	image adjustment	level span mode: automatic, semi-automatic, manual
	color palettes	white hot, iron red, arctic, rainbow 2, hot iron, rainbow 1, fulgurite, medical, tint, black hot, blue hot, sepia, green hot, ice and fire, amber, customized
Function	recording function	photo and video (infrared & visible light)
	cloud service	available
	other	customized physical button, intelligent diagnosis, OTA update
Storage and transmission	storage	local storage (64GB) and external 64GB SD
	image storage	JPG with temperature information
	video storage	MP4 (without temperature information), can be used to record audio synchronously; irgd (with temperature information), up to 30Hz for temperature analysis
	external interface	TYPE-C, SD card slot
	WIFI	can be connected to the mobile terminal for image and real-time video transmission
	bluetooth	bluetooth 5.0, support image transmission (only for Android)
Power system	battery type	lithium-ion rechargeable battery, working time≥5 hours
	charging mode	TYPE-C charging; PC/portable charger; capable of charging while using
	charging time	90% of full charge in 2.5 hours
Environmental parameter	operation temperature	-20°C~50°C
	storage temperature	-40°C~60°C
	protection	IP54, 2-meter drop test
	certification	CE, FCC, ROHS
Physical parameter	hardware	illuminator, microphone, speaker, electronic compass, GPS
	dimension	292×125×125mm
	weight	1.15kg

## INFRARED THERMOMETER (BASIC TYPE) CODE 0222-C520

- Unit: °C, °F
- Automatic data hold
- MAX/MIN/AVG/DIF mode
- High and low alarm
- Adjustable emissivity
- Low battery display
- Over range indicator
- Automatic power off

### SPECIFICATION

Temperature range	-50°C~500°C/-58°F~932°F
Temperature accuracy	±3.0°C (at -50°C~0°C), ±2.0°C or ±2% (at 0°C~500°C) ±5.4°F (at -58°F~32°F), ±4.0°F or ±2% (at 32°F~932°F)
Temperature resolution	0.1°C/0.2°F
Distance to spot size (D:S)	12:1
Emissivity	0.10~1.00 (adjustable)
Repeatability	±0.5°C or ±0.5%; ±1.0°F or ±0.5%
Response time	≤500ms (95% of reading)
Spectral response	8μm~14μm
Diode laser	output<1mW, wavelength 630nm~670nm, class 2 laser product
Power supply	2×AAA batteries, working time≥6h
Automatic power off	about in 15 seconds
Operation environment	temperature: 0°C~50°C/32°F~122°F; humidity: <90%RH (non-condensing)
Storage environment	temperature: -20°C~60°C/-4°F~140°F; humidity: <90%RH (non-condensing)
Dimension	148×85×46mm
Weight	160g



### STANDARD DELIVERY

Main unit	1 pc
Battery (AAA)	2 pcs

## INFRARED THERMOMETER (STANDARD TYPE) CODE 0213-A500

- Unit: °C, °F
- Dual laser sighting
- Negativity display
- Automatic power off
- Automatic data hold
- Over range indicator
- Max/Min display

### SPECIFICATION

Temperature range	-20°C~380°C/-4°F~716°F
Temperature accuracy	±2.5°C (at -20°C~20°C), ±2% or ±2.0°C (at 20°C~380°C) ±4.5°F (at -4°F~68°F), ±2% or ±3.6°F (at 68°F~716°F)
Temperature resolution	0.1°C/0.1°F
Distance to spot size (D:S)	12:1
Emissivity	0.95 (fixed)
Repeatability	±1°C/1.8°F
Response time	150ms
Spectral response	8~14μm
Diode laser	output<1mW, wavelength 630~670nm class 2 laser product
Operation temperature	0°C~50°C/32°F~122°F
Operation humidity	10%RH~90%RH
Storage temperature	-10°C~60°C/14°F~140°F
Storage humidity	<80%RH
Power supply	1×9V battery
Dimension	137×73×38mm
Weight	135g



### STANDARD DELIVERY

Main unit	1 pc
Battery	1 pc

30

## INFRARED THERMOMETER (ADVANCED TYPE) CODE 0215-A900

- Ambient temperature, dew point temperature and humidity detection
- Unit: °C, °F
- Circular laser sighting
- Display backlight
- Automatic power off
- Automatic data hold
- Adjustable emissivity
- High and low alarm

### SPECIFICATION

Infrared sensor	temperature range	-30°C~800°C/-22°F~1472°F
	temperature resolution	0.1°C 0.1°F (-22°F~1000°F), other range 1°F
	temperature accuracy	±3.0°C (at -30°C~20°C) ±(1% of reading +1)°C (at 20°C~450°C) ±(2% of reading )°C (at 450°C~800°C)
	distance to spot size (D:S)	20:1
	emissivity	adjustable 0.10~1.00
	response time	<150ms
	spectral response	8~14μm
	diode laser	output<1mW, wavelength 630~670nm class 2 laser product
Temperature and humidity sensor	ambient temperature range	0°C~50°C/32°F~122°F
	dew point temperature range	0°C~50°C/32°F~122°F
	temperature resolution	0.1°C/0.1°F
	temperature accuracy	±1.0°C/±1.8°F
	humidity range	0%RH~100%RH
	humidity resolution	0.1%RH
humidity accuracy	±5%RH (20%RH~80%RH), other range ±7%RH	
Automatic power off	about in 10 seconds	
Power supply	1×9V battery	
Dimension	170×45×85mm	
Weight	196g	

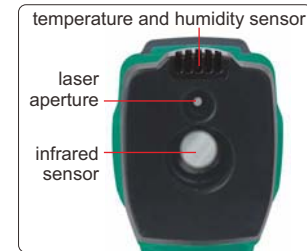

### STANDARD DELIVERY

Main unit	1 pc
Battery	1 pc

## DUAL-CAVITY BLACKBODY RADIATION SOURCE CODE PIC-D155

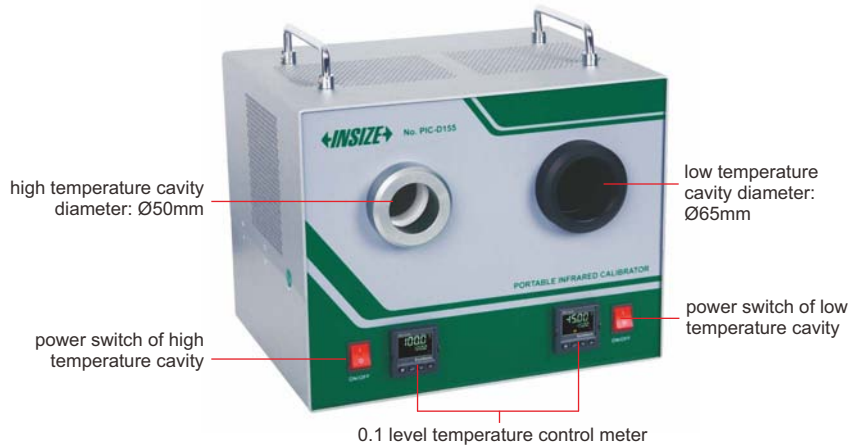

VIDEO

### SPECIFICATION

Temperature range	low range: -15°C~100°C; high range: 50°C~500°C
Resolution	0.01°C (at -15°C~100°C), 0.1°C (at 100°C~500°C)
Stability	≤(0.1°C or 0.1% t , whichever is greater)/10min*
Uniformity	≤(0.15°C or 0.15% t , whichever is greater)*
Emissivity	>0.995
Cavity size	low range: Ø65mm; high range: Ø50mm
Cavity depth	low range: 110mm; high range: 160mm
Cool down time	30 minutes from ambient to -15°C
Heat up time	60 minutes from ambient to 500°C
Power supply	220V/50Hz
Power	850W
Dimension	380×295×320mm
Weight	17.1kg

- Large target sizes of 50mm and 65mm for calibrating of infrared thermometers and infrared thermal imagers
- Contain two independent blackbody cavities
- The emissivity of blackbody radiation is better than 0.995
- 0.1 level temperature control meter with high accuracy
- Multi-point temperature correction function

### STANDARD DELIVERY

Main unit	1 pc
-----------	------

\*|t| is the absolute temperature value of blackbody radiation source

30

## INFRARED AND PENETRATION THERMOMETER CODE 0321-IT42

- Can measure the surface and inside temperature of objects
- Low battery display
- Display backlight
- High and low alarm
- Automatic data hold (infrared system)
- Automatic power off (infrared system)
- Unit: °C/°F



IP65  
WATERPROOF

### SPECIFICATION

Infrared system	temperature range	-15°C~280°C/5°F~536°F
	temperature resolution	0.1°C/0.1°F
	temperature accuracy	±3.0°C (at -15°C~20°C), other range ±(1%+1.0)°C ±5.4°F (at 5°F~68°F), other range ±(1%+1.8)°F
	distance to spot size (D:S)	4:1
	emissivity	0.95 (fixed)
Penetration system	spectral response	8~14μm
	temperature range	-40°C~200°C/-40°F~392°F
	temperature resolution	0.1°C/0.1°F
	temperature accuracy	±2.0°C (at -40°C~0°C), other range ±(1%+1.0)°C ±3.6°F (at -40°F~32°F), other range ±(1%+1.8)°F
Repeatability		<1.0°C
Measurement response time		<500ms
Power supply		2×1.5V AAA batteries
Dimension		140×39×24mm
Weight		140g



VIDEO

### STANDARD DELIVERY

Main unit	1 pc
Battery (AAA)	2 pcs

# DATA LOGGER FOR TEMPERATURE AND HUMIDITY (BUILT-IN SENSOR) CODE 0311-3070

**IP54**  
WATERPROOF

**DATA**  
OUTPUT



stand (included)

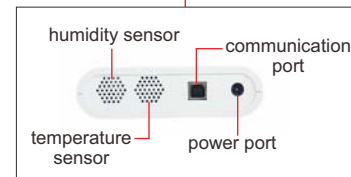

- Signal acquisition, display, storage, analysis function
- Low power consumption
- Built-in high-precision temperature and humidity sensor
- Software is included

## SPECIFICATION

Temperature range	-30°C~70°C/-22°F~158°F
Temperature accuracy	±0.3°C (at 23°C±2°C), other range ±0.5°C ±0.6°F (at 73.4°F±3.6°F), other range ±0.9°F
Temperature resolution	0.1°C/0.2°F
Humidity range	0%RH~100%RH
Humidity accuracy	±3%RH (at 10%RH~85%RH), other range ±5%RH
Humidity resolution	0.1%RH
Memory capacity	10918
Alarm	function: alarm when over high or low limit method: display+buzz+backlight
Sampling interval	2s, 5s, 10s, 30s, 60s, 255s (adjustable)
Logging interval	2 seconds~24 hours (adjustable)
Start with delay	1~120 seconds (adjustable)
Start mode	start immediately/delay start/timing start
End mode	Full/FIFO/preset/timing end
Timing start/end	random start/end with format YYMMDD HHMMSS
Interface	USB
Time battery	CR2032
Power supply	3.6V lithium battery (ER14505) or 5~24V DC
Dimension	123×117×33mm
Weight	260g

## STANDARD DELIVERY

Main unit	1 pc
Software and USB cable	1 pc
Power adapter	1 pc
Time battery	1 pc
Lithium battery	1 pc

software (included), record and download data to PC software via USB cable





**IP50**  
DUSTPROOF

## DIGITAL THERMOHYGROMETER (PROFESSIONAL TYPE) CODE 9362-TH27

- Measure humidity, ambient temperature and dew-point temperature
- Max/Min/Average mode
- Alarm function
- IP50 protection grade

### SPECIFICATION

Sensor model	NTC thermistor/humidity capacitance/digital sensor
Temperature range	-20°C~70°C/-4°F~158°F
Temperature accuracy	±0.5°C/±0.9°F
Temperature resolution	0.1°C/0.2°F (minimum adjustable unit is 0.2°F in setting mode)
Humidity range	0~100%RH
Humidity accuracy	±5%RH
Humidity resolution	0.1%RH
Sampling interval	5s
Battery	1.5V AAA
Dimension	95×107×18mm
Weight	105g



### STANDARD DELIVERY

Main unit	1 pc
Battery (AAA)	1 pc

30

## THERMOHYGROMETER (EXTERNAL SENSOR) CODE 0313-TH48

- External sensor, 3m cable
- Time/temperature/humidity display
- Temperature and humidity upper and lower limit alarm function
- Unit: °C/°F
- Low battery alarm



### SPECIFICATION

Temperature range	-40°C~80°C/-40°F~176°F
Temperature accuracy	±0.5°C (at -20°C~60°C), ±1.0°C (at 60°C~80°C), ±2°C (at -40°C~-20°C), ±2°F (at -20°F~176°F), ±3°F (at -40°F~-20°F)
Temperature resolution	0.1°C (at -20°C~80°C), other range 1°C 0.1°F (at -20°F~100°F), other range 1°F
Humidity range	0%RH~99.9%RH
Humidity accuracy	±5%RH (at 10°C~60°C), other range ±7% ±5%RH (at 50°F~140°F), other range ±7%
Humidity resolution	0.1%RH
Sensitivity attenuation value	temperature: <0.1°C/year (<0.2°F/year) humidity: <1%RH/year
Sampling interval	5 seconds
Power supply	built-in rechargeable lithium battery (USB 5V charging) working time at least one month
Dimension	88×88×21mm
Weight	174g

### STANDARD DELIVERY

Main unit	1 pc
USB charging cable	1 pc

## K-TYPE THERMOCOUPLE THERMOMETER (ECONOMIC TYPE) CODE 0320-K230

- Contact K-type thermocouple
- Unit: °C/°F
- Data hold function
- Low battery display
- Display backlight

### SPECIFICATION

Temperature range	-50°C~200°C/-58°F~392°F
Temperature accuracy	±2.0°C/±3.6°F
Temperature resolution	0.1°C (at -50°C~199.9°C), 1°C (at -50°C~200°C) 0.1°F (at -58°F~199.9°F), 1°F (at -58°F~392°F)
Sampling rate	2.5 times/sec
Power supply	3×3V CR2450 batteries (for 300 hours working)
Operation voltage	6.8V~10V
Dimension	149×76×34mm
Weight	220g

### STANDARD DELIVERY

Main unit	1 pc
Thermocouple (K-type)	1 pc
CR2450 battery	3 pcs



## THERMOHYGROMETER CODE 0310-H26

- Measure humidity, ambient temperature, dew point temperature and wet bulb temperature
- Min/Max, data hold function
- Bluetooth 4.0
- Auto power off
- Supplied with APP for Apple and Android

App measurement

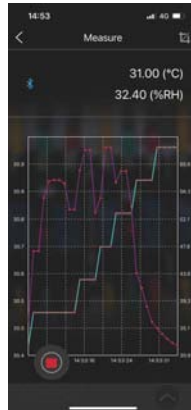

App record

No.	Data Value (°C)	Data Value (%RH)
1	30.90	41.40
2	30.90	38.50
3	30.90	36.10
4	31.00	35.10
5	31.00	34.20
6	31.00	33.40
7	31.00	32.80
8	31.00	32.40
9	31.00	32.10
10	31.00	32.00
11	31.00	31.70

### SPECIFICATION

Function	Measuring range	Resolution	Accuracy
Ambient temperature	0°C~50°C 32°F~122°F	0.1°C/0.1°F	±1.0°C/±1.8°F
Wet bulb temperature	0°C~50°C 32°F~122°F		
Dew point temperature	0°C~50°C 32°F~122°F		
Humidity	0%RH~80%RH	0.1%RH	±5.0%RH
Auto power off	30 minutes		
Data port	Bluetooth 4.0		
Power supply	9V battery		
Dimension	204×54×36mm		
Weight	172g		



### STANDARD DELIVERY

Main unit	1 pc
Battery	1 pc

- Environment comfort display: COMFORT, WET, DRY
- Time/temperature/humidity display
- Highest/lowest temperature and humidity memory function
- Alarm clock function
- Unit: °C, °F

## THERMOHYGROMETER (ECONOMIC TYPE) CODE 0312-TH50



### SPECIFICATION

Temperature range	0°C~50°C/32°F~122°F
Temperature accuracy	±1.0°C (at 5°C~40°C), other range ±1.5°C ±1.8°F (at 41°F~104°F), other range ±2.7°F
Temperature resolution	0.1°C/0.1°F
Humidity range	10%RH~90%RH
Humidity accuracy	±5%RH (at 40%RH~80%RH), other range ±8%RH
Humidity resolution	1%RH
Power supply	1×AAA 1.5V battery
Dimension	108×60×15mm
Weight	74g

### STANDARD DELIVERY

Main unit	1 pc
Battery	1 pc

## LARGE SCREEN TEMPERATURES AND HUMIDITY METERS



0314-H533A



0314-H533B

- High definition LED large screen display: temperature, humidity, time
- Exceeding limit alarm: buzzer alarm, digit/light flash alarm
- Installation method: wall mounted or ring type

### STANDARD DELIVERY

Main unit (including sensor)	1 pc
------------------------------	------

### SPECIFICATION

Code	0314-H323A	0314-H323B	0314-H423A	0314-H423B	0314-H533A	0314-H533B	0314-H643A	0314-H643B
Dimension	300×200×36mm		400×265×36mm		500×300×36mm		600×400×36mm	
Sensor type	integrated	separated	integrated	separated	integrated	separated	integrated	separated
Power consumption	5W		5W		9W		10W	
Weight	1.3kg		2kg		3kg		4kg	
Sensor	integrated: plastic probe case (not dustproof, not waterproof) separated: metal probe case (dustproof, waterproof), cable length 1m (can be customized, within 20m)							
Temperature range	integrated: -20°C~60°C; separated: -40°C~85°C							
Temperature resolution	integrated: 0.1°C (at 0°C~60°C), other range 1°C separated: 0.1°C (at 0°C~85°C), other range 1°C							
Temperature accuracy	integrated: ±0.5°C (at 0°C~60°C), other range ±2°C separated: ±0.5°C (at 0°C~85°C), other range ±2°C							
Humidity range	5%RH~95%RH							
Humidity resolution	0.1%RH							
Humidity accuracy	±3%RH (@25°C)							
Long-term stability	temperature≤0.1°C/year; humidity≤1%RH/year							
Repeatability	temperature≤0.1°C; humidity≤0.5%RH							
Sampling speed	1s							
Response time	3 minutes to reach 90% of the final value							
Time accuracy	±15s/month (@25°C±2°C)							
Power supply	AC100~240V (50/60Hz)							
Power cable length	1m (can be customized, 2m/5m)							
Operation condition	temperature: -20°C~60°C; humidity: 5%~95% (non-condensing)							

## TEMPERATURE AND HUMIDITY DATA LOGGER CODE THL-A01



- Suitable for testing the temperature field, humidity field, uniformity and volatility of various temperature (humidity) environment experimental equipment, industrial furnaces and verification furnaces
- 24 channels can be independently configured as thermocouple, platinum resistance, humidity sensor and analog input mode
- Each channel provides an accuracy advantage over 0.15°C thermocouple for cold-end compensation
- Support voltage, resistance, temperature, humidity and other data formats display, storage and output
- Support Wireless Network, RS232 communication mode: Wireless Network can remotely browse real-time data and download stored data, RS232 communication protocol based on RSCII code for encoding and reading data
- Built-in 8G large capacity memory, data can be exported via USB port

### SPECIFICATION OF TEMPERATURE AND HUMIDITY DATA LOGGER

	Type (electrical signal)	Range	Resolution	Accuracy
Temperature	PT100	-200 ~950°C	0.001°C	0.05°C at 0°C 0.08°C at 300°C 0.12°C at 600°C
	K	-200°C~1300°C	0.01°C	0.5°C
	J	-200°C~900°C		0.5°C
	T	-200°C~400°C		0.5°C
	E	-200°C~1000°C		0.5°C
	N	-200°C~1300°C		0.5°C
	B	250°C~1820°C		0.8°C at 1000°C
	R	0°C~1768°C		0.7°C at 1000°C
	S	0°C~1768°C		0.9°C at 1000°C
Humidity	-	0%RH~100%RH	0.01%RH	0.1%RH
Voltage	range: 100mV	-10mV~100mV	0.1μV	0.01% of reading+0.008% of full scall
	range: 1V	0V~1V	0.1mV	0.01% of reading+0.008% of full scall
Resistance	range: 400Ω	0Ω~400Ω	0.1mΩ	0.004% of reading+0.004% of full scall
Sampling mode	24-channel synchronous sampling			
Sampling speed	0.2s/24 channel			
Memory	8G			
Output	USB, wireless, RS232			
Operation environment	temperature: 5°C~35°C			
	humidity: 0%RH~85%RH (non-condensing)			
Storage environment	temperature: 5°C~35°C			
	humidity: 0%RH~85%RH (non-condensing)			
Power supply	power adapter			
Dimension	250×180×75mm			
Weight	1.7kg			

To be continued

Continued from previous page



K-type thermocouple (optional)



humidity sensor (optional)



platinum resistance PT100 (optional)

**STANDARD DELIVERY**

Main unit	1 pc
Power adapter	1 pc
16G USB flash disk	1 pc

**OPTIONAL ACCESSORY**

Platinum resistance PT100	THL-A01-PT100
K-type thermocouple	THL-A01-K
Humidity sensor	THL-A01-H

**SPECIFICATION OF SENSOR (OPTIONAL)**

Product	Code	Range	Accuracy
platinum resistance PT100	<b>THL-A01-PT100</b>	-80~300°C	class A: $\pm(0.150^{\circ}\text{C}+0.002 \cdot  t )$
K-type thermocouple	<b>THL-A01-K</b>	300~1000°C	class 1: $\pm 1.5^{\circ}\text{C}$ (at 300°C~375°C), $\pm 0.004 \cdot t$ (at 375°C~1000°C)
humidity sensor	<b>THL-A01-H</b>	0%RH~100%RH	0.8%RH (at 23°C)



**PORTABLE MEDIUM TEMPERATURE DRY BLOCK CALIBRATOR  
CODE DBC-M660**

- Used for temperature calibration in industrial or laboratory
- Unit: °C, °F
- Language: English, Chinese
- Overheat protection
- Multi-point temperature correction function
- Automatic tuning of temperature control parameters
- Segmented PID control, one-button heating, full-automatic temperature control



**SPECIFICATION**

Temperature range	50°C~660°C	
Horizontal temperature field	≤0.2°C	
Vertical temperature field	within 40mm from the bottom of the well	≤0.5°C (at 50°C~300°C)
		≤1.0°C (at 300°C~660°C)
Temperature fluctuation	±0.15°C	
Temperature resolution	0.01°C	
Control method	touch screen	
Soaking block	insertion aperture: Ø4.5mm, Ø6.5mm, Ø8mm, Ø10mm (can be customized)	
Well depth	170mm	
Power	600W	
Power supply	220V/50Hz	
Dimension	285×170×335mm	
Weight	9.4kg	

real-time display of curve

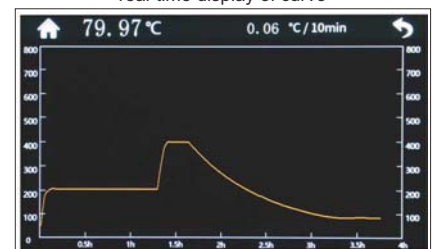

**STANDARD DELIVERY**

Main unit	1 pc
Soaking block	1 pc



**Roundness/Cylindricity Testers**  
Page 759-760



**Roundness Measuring Machines**  
Page 761-762



**Precision Air Floating Rotary Tables**  
Page 763



**Surface Profile Measuring Machines**  
Page 764-771



**Roughness Measuring Machines**  
Page 772-773



**Roughness Testers**  
Page 774-784



**Surface Roughness Specimens**  
Page 784-785



**Surface Roughness Reference  
Specimens**  
Page 786



## ROUNDNESS/CYLINDRICITY TESTER CODE RCT-300



- Automatic centering and leveling
- Evaluation items
  - Cylindricity module: cylindricity, radial full run, coaxiality, taper, radius
  - Roundness module: roundness, concentricity, radial single jump, wall thickness difference
  - Straightness module: straightness, parallelism, squareness
  - Single section flatness module: single section flatness, axial single hop, perpendicularity, parallelism
  - Multi-section flatness module: multi-section flatness, parallelism, axial full runout, perpendicularity
  - Commutator module: monolithic bounce, immediate bounce, interval difference
- Analytical ability
  - Cylindricity function: 2-10 sections, 3 evaluation methods
  - Reference benchmarks for cylindricity evaluation: LSCY, MZCY, MICY, MCCY, OSCY
  - Reference circle for roundness evaluation: LSC, MZC, MIC, MCC
  - Measurement band: 1-15upr, 1-50upr, 1-150upr, 1-250upr, 1-500upr, 15-100upr, 15-500upr, 2-15upr, 1-1500upr, custom
  - Notched measurement

### SPECIFICATION

Probe	measuring range	±500µm
	resolution	1:262144
	linear accuracy	0.1%
Ruby stylus	size	Ø2x10mm
	direction	two directions
	adjustable angle	±45°
X axis	travel	165mm
	excess range	25mm
	drive mode	motor
	moving speed	0.1~50mm/s
Z axis	measuring range	480mm
	straightness	0.3µm/100mm
	movement speed	0.1~10mm/s
	movement mode	motor
Detector	acquisition device	circular grating
	circumferential sampling points	14400
Granite stage		900×500mm
Rotary stage	rotation accuracy	(0.025+6H/10000)µm, H is the measuring height in mm
	rotation speed	6rpm, 8rpm, 10rpm
	max. measuring diameter	300mm
	max. workpiece diameter (rotation diameter)	450mm
Automatic adjustment stage	workbench diameter	280mm
	adjustment range of center	±3mm
	adjustment range of level	±1°
	weight capacity	30kg
Precision chuck	external grip diameter	Ø1~Ø81mm
	internal grip diameter	Ø31~Ø70mm
Air filter	pressure range	0~0.8MPa
	oil mist removal accuracy	0.01µm
	export oil mist concentration	0.5mg/m <sup>3</sup>
Dimension (LxWxH)		1680×862×1685mm
Power supply		220±10%V, 50Hz
Power		500W
Weight		350kg

To be continued

Continued from previous page



air filter (included)



standard block (included)



column adjusting rod (included)



precision chuck (included)

### STANDARD DELIVERY

Main unit	1 pc
Probe (with ruby stylus)	1 pc each
Standard block	1 pc
Column adjusting rod	1 set
Precision chuck	1 pc
Automatic adjustment stage	1 pc
Roundness cylindricity acquisition and analysis system	1 set
Air filter	1 set
Computer	1 pc
Printer	1 pc
Installation tools	1 set

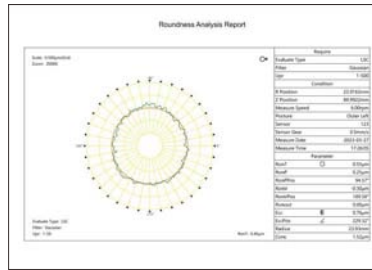

roundness analysis

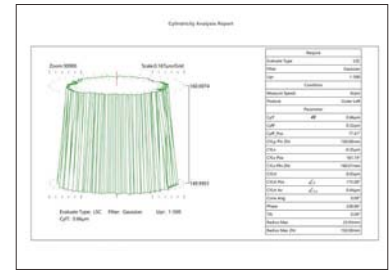

cylindricity analysis

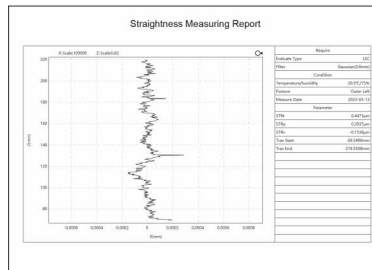

straightness analysis

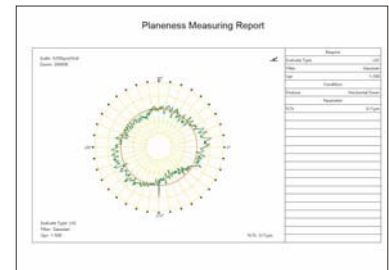

planeness analysis

### OPTIONAL ACCESSORY

Probes	see below details
Precision chucks	see below details
Dryer	ISC-DRY

### SPECIFICATION OF PROBES

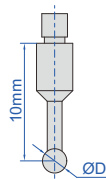

Code	Diameter (ØD)	Remark
RCT-RA260-T1	2mm	included
RCT-RA260-T2	0.5mm	optional
RCT-RA260-T3	1mm	optional
RCT-RA260-T4	4mm	optional
RCT-RA260-T5	8mm	optional

### SPECIFICATION OF PRECISION CHUCKS

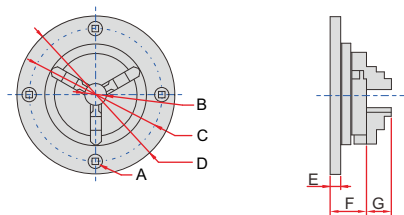

(mm)

Code	A	B	C	D	E	F	G	Clamping range		Remark
								external grip dia.	internal grip dia.	
RCT-RA260-C1	M5x0.8	16	100	118	8	28	13	Ø0.8~63	Ø23~58	optional
RCT-RA260-C2	M6x1.0	20	116	143	10.5	37	15	Ø1~81	Ø31~70	included
RCT-RA260-C3	M6x1.0	26	140	168	10	39	19	Ø1~100	Ø36~90	optional



## ROUNDNESS MEASURING MACHINE CODE RCT-RA260



- Air-floating spindle
- Can measure roundness, coaxiality, concentricity, flatness, radial runout, axial runout, parallelism and perpendicularity
- Spectrum analysis, automatic gap/burr removal, waveform analysis
- 4 roundness evaluation methods: smallest area method, least square method, smallest circumscribed circle method, largest inscribed circle method
- Measuring filer: 1-15 $\mu$ r, 1-50 $\mu$ r, 1-150 $\mu$ r, 1-250 $\mu$ r, 1-500 $\mu$ r, 15-100 $\mu$ r, 15-500 $\mu$ r, 2-15 $\mu$ r
- Filter form: gauss (ISO standard)
- Software is included, for measurement, analysis, data output, etc.

31

### SPECIFICATION

Probe	measuring range	$\pm 300\mu\text{m}$
	resolution	$0.001\mu\text{m}$
	linear accuracy	0.25%
Ruby stylus	size	$\varnothing 2 \times 10\text{mm}$
	direction	two directions
	adjustable angle	$\pm 45^\circ$
X axis	travel	165mm
	excess range	25mm
	drive mode	by hand
Z axis	drive mode	motor
	travel	320mm
	movement speed	0.5~10mm/s
Rotary stage	rotation accuracy	$(0.025+6H/10000)\mu\text{m}$ for $H \leq 20\text{mm}$ , H is the measuring height in mm
	rotation speed	6rpm
	max. measuring diameter	260mm
	max. workpiece diameter (rotation diameter)	400mm
Rotary axis	radial rotation accuracy	$\pm 0.0125\mu\text{m}$
	axial runout accuracy	$\pm 0.05\mu\text{m}$
Adjustable 3D stage	diameter	180mm
	adjustment range of center	$\pm 3\text{mm}$
	adjustment range of level	$\pm 2^\circ$
	weight capacity	20kg
Granite stage		700×500mm
Precision chuck	external grip diameter	$\varnothing 1 \sim \varnothing 81\text{mm}$
	internal grip diameter	$\varnothing 31 \sim \varnothing 70\text{mm}$
Air filter	pressure range	0~0.8MPa
	oil mist removal accuracy	$0.01\mu\text{m}$
	export oil mist concentration	$0.5\text{mg}/\text{m}^3$
Dimension (L×W×H)		1300×795×1715mm
Power supply		220±10%V, 50Hz
Power		500W
Weight		320kg

To be continued

Continued from previous page

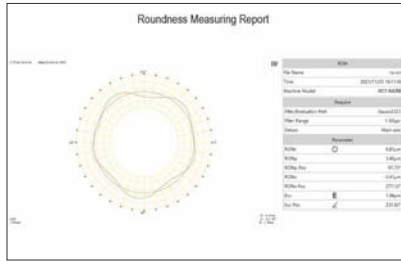

measurement

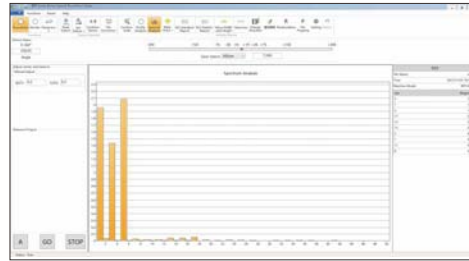

spectrum analysis

**STANDARD DELIVERY**

Main unit	1 pc
Probe (with ruby stylus)	1 pc each
Standard block	1 pc
Precision chuck	1 pc
Adjustable 3D stage	1 pc
Rotary stage	1 pc
Computer	1 pc
Software	1 set
Printer	1 pc
Air filter	1 set
Installation tools	1 set



standard block (included)

**OPTIONAL ACCESSORY**

Probes	refer to details
Precision chucks	refer to details
Dryer	ISC-DRY

**SPECIFICATION OF PROBES**

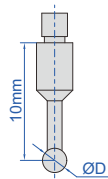

Code	Diameter (ØD)	Remark
RCT-RA260-T1	2mm	included
RCT-RA260-T2	0.5mm	optional
RCT-RA260-T3	1mm	optional
RCT-RA260-T4	4mm	optional
RCT-RA260-T5	8mm	optional

**SPECIFICATION OF PRECISION CHUCKS**

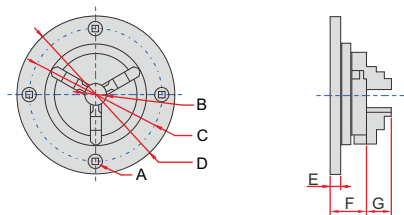

(mm)

Code	A	B	C	D	E	F	G	Clamping range		Remark
								external grip dia.	internal grip dia.	
RCT-RA260-C1	M5x0.8	16	100	118	8	28	13	Ø0.8~63	Ø23~58	optional
RCT-RA260-C2	M6x1.0	20	116	143	10.5	37	15	Ø1~81	Ø31~70	included
RCT-RA260-C3	M6x1.0	26	140	168	10	39	19	Ø1~100	Ø36~90	optional



# PRECISION AIR FLOATING ROTARY TABLES



6875-320

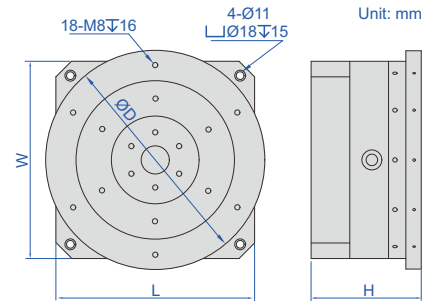

- Manual rotation
- Optional accessory:  
high precision digital indicators (code 2133 series),  
hydraulic universal magnetic stands (code 6274 series)

air filter (included)



Code	Stage size ØD	Max. RPM	Air supply pressure	Max. load	Radial stiffness	Axial stiffness	Radial runout	Axial runout	L×W×H
6875-320	320mm	500rpm	5-6bar	100kg	250N/μm	500N/μm	<0.3μm	<0.3μm	272x272x161mm
6875-400	400mm	500rpm	5-6bar	100kg	250N/μm	500N/μm	<0.3μm	<0.3μm	272x272x161mm
6875-500	500mm	500rpm	5-6bar	100kg	250N/μm	500N/μm	<0.3μm	<0.3μm	272x272x191mm

Standard glass hemisphere (optional)

Code	Roundness
6875-BALL*	0.05μm

\*To check the accuracy of rotary table



6875-BALL



6875-CLAMP

Clamp for glass hemisphere (optional)

Code
6875-CLAMP

application



# SURFACE PROFILE MEASURING MACHINE CODE SPM-1000

- Software is included, for surface profile measurement and data output
- Probe compensation
- Output as format txt, csv, etc.
- Large range design, the leverage ratio is 1:2.2, maintain the original accuracy of the sensor
- The overall structure of the Z-axis sensor does not have any elastic components, ensuring the measuring force is constant regardless the position of probe

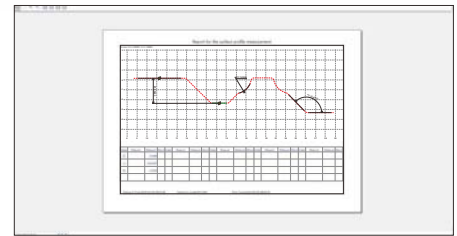
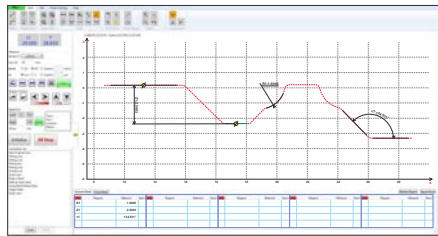
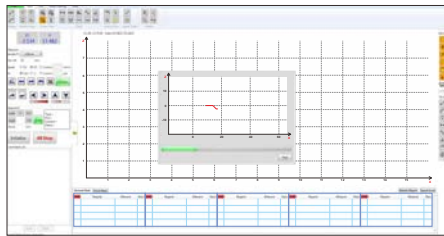
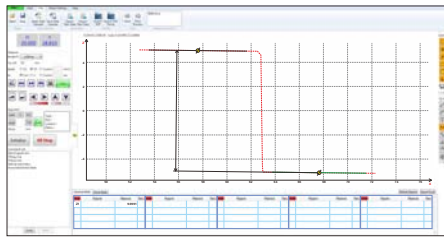

## SPECIFICATION

<b>X axis measuring range</b>	140mm
<b>X axis resolution</b>	0.2 $\mu$ m
<b>X axis straightness</b>	0.8 $\mu$ m/100mm
<b>X axis moving speed</b>	0.1~10mm/s
<b>Z axis measuring range</b>	$\pm$ 20mm
<b>Z axis resolution</b>	0.05 $\mu$ m
<b>Z axis moving speed</b>	0.5~10mm/s
<b>Linear accuracy</b>	$\pm(1.5+ 0.2H )\mu$ m, H is measuring height in mm
<b>Angular measuring accuracy</b>	$\pm 2'$
<b>Arc measuring accuracy</b>	$\pm(2+R/8)\mu$ m, R is 2~10mm standard ball
<b>Radius of probe tip</b>	25 $\mu$ m
<b>Moving direction</b>	backward
<b>Measuring force</b>	6.86~9.8mN
<b>Measuring unit</b>	mm/inch
<b>Traceable angle</b>	72° (upward), 87° (downward)
<b>Drive mode</b>	motor
<b>Travel of Z axis</b>	430mm
<b>Dimension (L*W*H)</b>	1200*700*1780mm
<b>Power supply</b>	220 $\pm$ 5%V, 50Hz
<b>Weight</b>	320kg

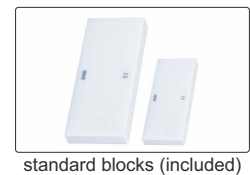
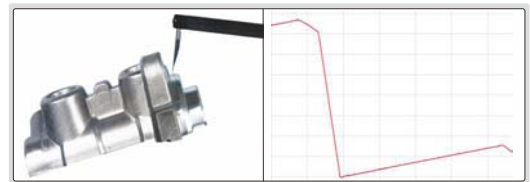

To be continued

Continued from previous page

**STANDARD DELIVERY**

Main unit	1 pc
Standard probe and arm	1 pc of each
Standard block	2 pcs
Standard ball	2 pcs
Standard shaft	1 pc
Stage	1 pc
Vise	1 pc
Measuring arm	1 pc
Computer	1 pc
Measurement software	1 pc
Printer	1 pc
Installation tools	1 set

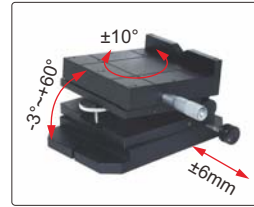

stage (included)



vise (included)

**OPTIONAL ACCESSORY**

Probe	refer to details
-------	------------------

**SPECIFICATION OF PROFILE PROBES**

Unit: mm

**chisel stylus**

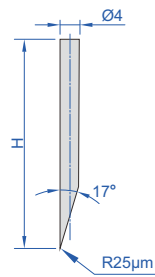

code **SPM-1000-T01** (H=32mm, included)  
 code **SPM-1000-T02** (H=48mm, optional)  
 code **SPM-1000-T03** (H=68mm, optional)

**cone stylus**

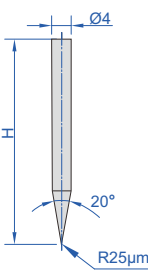

code **SPM-1000-Z01** (H=32mm, optional)  
 code **SPM-1000-Z02** (H=48mm, optional)  
 code **SPM-1000-Z03** (H=68mm, optional)

**ball stylus**

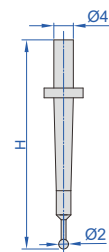

code **SPM-1000-R01** (H=32mm, optional)  
 code **SPM-1000-R02** (H=48mm, optional)  
 code **SPM-1000-R03** (H=68mm, optional)

**standard arm, code SPM-1000-SP (included), stylus is not included**

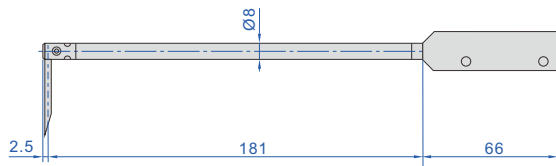

**probe for small holes, code SPM-1000-SBP (optional), stylus is included**

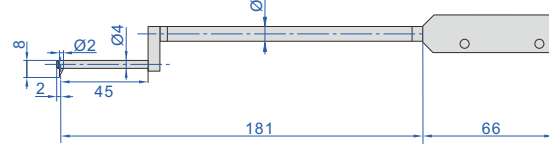

measure the contour of holes with diameter > Ø8mm

**transverse probe, code SPM-1000-LP (optional), stylus is included**

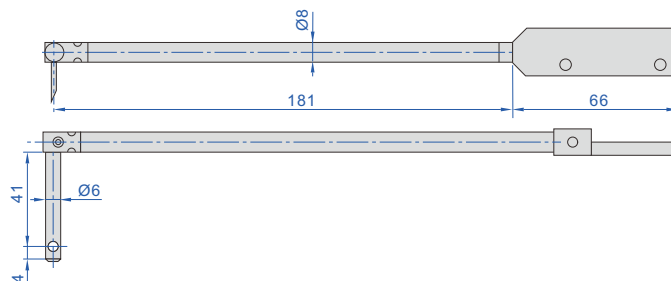

measure the contour of holes in radial direction

# ROUGHNESS AND PROFILE MEASURING MACHINE CODE SPM-2000

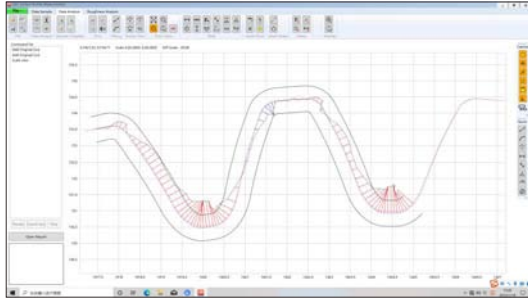

CAD profile comparison

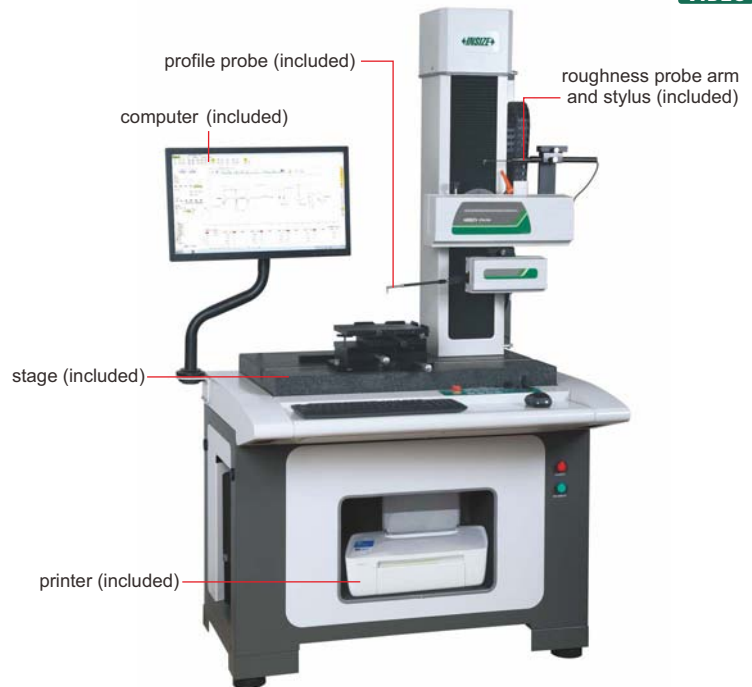

31

- Software is included, for measurement and data output
- Profile sensor with low noise
- Wide range roughness sensor without skid
- Meet ISO1997, ISO1984, BS1988, DIN1990, ASME1995, JIS1982, JIS1994 standards
- 65 roughness parameters

### PROFILE MEASUREMENT SPECIFICATION

X axis measuring range	140mm
X axis resolution	0.2 $\mu$ m
X axis traverse speed	0.05~15mm/s
Z axis measuring range	50mm
Z axis resolution	0.05 $\mu$ m
Z axis traverse speed	0.2~15mm/s
Straightness	0.5 $\mu$ m/100mm
Linear accuracy	$\pm(0.8+ 0.15H )\mu$ m, H is measuring height in mm
Angular measuring accuracy	$\pm 1'$
Arc measuring accuracy	$\pm(1.5+R/12)\mu$ m, R is 2~10mm standard ball
Measuring unit	$\mu$ m/ $\mu$ in
Measuring speed	0.05~1mm/s
Traceable angle	72° (upward), 88° (downward)
Travel of Z axis	430mm
Power supply	220 $\pm$ 5%V, 50Hz
Dimension (L×W×H)	1400×850×1780mm
Weight	350kg

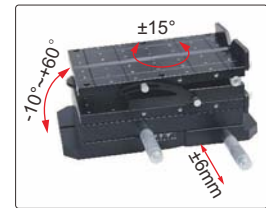

stage (included)



vise (included)



standard shaft (included)



standard blocks (included)



standard balls (included)

### ROUGHNESS MEASUREMENT SPECIFICATION

Roughness parameters	Ra, Rp, Rv, Rz, Rz (JIS), R3z, Rz (DIN), Rzj, Rmax, Rc, Rt, Rq, Rsk, Rku, Rsm, Rs, PΔq, Rk, Rpk, Rvk, Mr1, Mr2, Rmr
Waviness parameters	Wa, Wt, Wp, Wv, Wz, Wq, Wsm, Wsk, Wku, Wmr
Primary profile parameters	Pa, Pt, Pp, Pv, Pz, Pq, Psm, Psk, Pku, Pmr
Measuring range	$\pm 420\mu$ m
Resolution	0.001 $\mu$ m
Linear accuracy	$\leq \pm(5nm+2.8\%)$
Probe radius/angle	5 $\mu$ m/90°
Cut off	0.025/0.08/0.25/0.8/2.5/8mm
Number of cut-offs	2~7
Measuring unit	$\mu$ m
Measuring speed	0.05~0.25mm/s

To be continued

Continued from previous page

**STANDARD DELIVERY**

Main unit	1 pc
Calibration block	1 set
Roughness probe arm	1 pc
Roughness stylus	1 pc
Profile probe arm	1 pc
Profile chisel stylus	1 pc
Stage	1 set
Vise	1 set
Computer	1 pc
Software	1 set
Printer	1 pc
Installation tools	1 set

**OPTIONAL ACCESSORY**

Probe	refer to details
-------	------------------

**SPECIFICATION OF ROUGHNESS PROBE**

**standard probe, code SPM-2000-P (included), stylus is included**

**small roughness probe, code SPM-2000-P1 (optional), stylus is included**

**SPECIFICATION OF PROFILE PROBES**

Unit: mm

<p><b>chisel stylus</b></p> <p>code <b>SPM-1000-T01</b> (H=32mm, included) code <b>SPM-1000-T02</b> (H=48mm, optional) code <b>SPM-1000-T03</b> (H=68mm, optional)</p>	<p><b>cone stylus</b></p> <p>code <b>SPM-1000-Z01</b> (H=32mm, optional) code <b>SPM-1000-Z02</b> (H=48mm, optional) code <b>SPM-1000-Z03</b> (H=68mm, optional)</p>	<p><b>ball stylus</b></p> <p>code <b>SPM-1000-R01</b> (H=32mm, optional) code <b>SPM-1000-R02</b> (H=48mm, optional) code <b>SPM-1000-R03</b> (H=68mm, optional)</p>
<p><b>standard arm, code SPM-1000-SP (included), stylus is not included</b></p>	<p><b>probe for small holes, code SPM-1000-SBP (optional), stylus is included</b></p> <p>measure the contour of holes with diameter &gt;Ø8mm</p>	
<p><b>transverse probe, code SPM-1000-LP (optional), stylus is included</b></p> <p>measure the contour of holes in radial direction</p>		

# ROUGHNESS AND PROFILE MEASURING MACHINE (ONE PROBE TYPE) CODE SPM-5000



- Roughness, waviness, and profile analysis can be achieved with just one measurement
- Can measure all roughness and waviness parameters
- Can be used for automatic measurement system
- Air flotation and shockproof system to reduce measurement deviation
- Free to edit measurement reports

## PROFILE MEASUREMENT SPECIFICATION

<b>X axis measuring range</b>	100mm
<b>X axis resolution</b>	0.2μm
<b>X axis traverse speed</b>	0.05~50mm/s
<b>X axis linear accuracy</b>	±(0.8+ 0.015L )μm, L is measuring length in mm
<b>Z axis measuring range</b>	±10mm
<b>Z axis resolution</b>	0.01μm
<b>Z axis traverse speed</b>	0.2~50mm/s
<b>Z axis linear accuracy</b>	±(0.5+ 0.08H )μm, H is measuring height in mm
<b>Angular measuring accuracy</b>	±1'
<b>Arc measuring accuracy</b>	±(1+R/12)μm, R is 2~10mm standard ball
<b>Straightness</b>	0.3μm/100mm,
<b>Measuring unit</b>	mm/inch
<b>Travel of Z axis</b>	320mm
<b>Power supply</b>	220±5%V, 50Hz
<b>Dimension (L×W×H)</b>	1700×820×1900mm
<b>Weight</b>	500kg

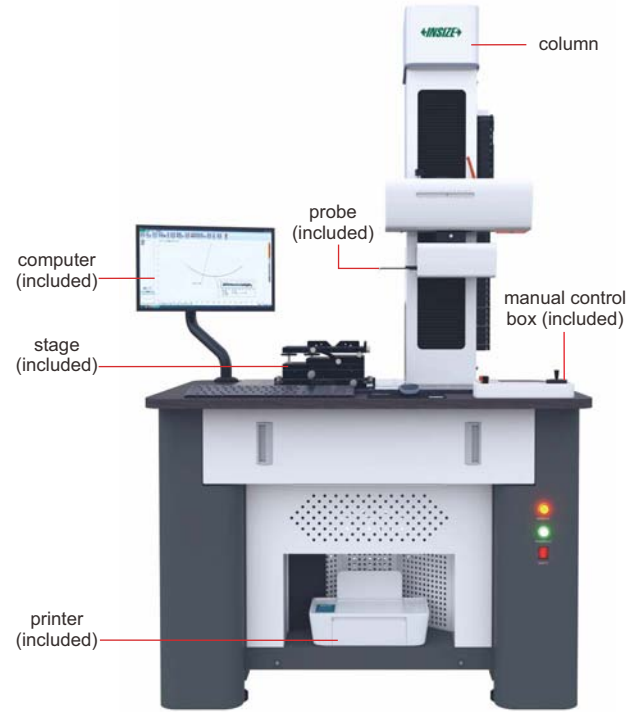

standard balls (included)



standard shaft (included)

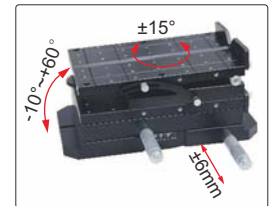

stage (included)



vise (included)



standard blocks (included)

## ROUGHNESS MEASUREMENT SPECIFICATION

<b>Roughness parameters</b>	Ra, Ramax, Ramin, Rasd, Rp, Rpmax, Rpmin, Rpsd, Rv, Rvmax, Rvmin, Rvzd, Rz, Rzmax, Rzmin, Rzs, R3z, Rc, Rcmax, Rcmin, Rcsd, Rt, Rq, Rqmax, Rqmin, Rdsd, Rsk, Rskmax, Rskmin, Rsksd, Rku, Rkumax, Rkumin, Rkusd, Rsm, Rsmmax, Rsmmin, Rsmsd, Rs, RΔa, RΔamax, RΔamin, RΔasd, RΔq, RΔqmax, RΔqmin, RΔqsd, Rk, Rpk, Rvk, Mr1, Mr2, RLa, Rlamax, Rlamin, Rlasd, Rlq, Rlqmax, Rlqmin, Rlqsd, Rδc, Rpc, Rmr
<b>Waviness parameters</b>	Wa, Wamax, Wamin, Wasd, Wsa, Wca, Wa08, Wc, Wcmax, Wcmin, Wcsd, Wt, Wz, Wzmax, Wzmin, Wzsd, Wp, Wpmax, Wv, Wvmax, Wvmin, Wvzd, Wq, Wqmax, Wqmin, Wqsd, Wsm, Wsmmax, Wsmmin, Wsmsd, Wsk, Wskmax, Wskmin, Wksd, Wku, Wkumax, Wkumin, Wkud, WΔq, WΔqmax, WΔqmin, WΔqsd, Wδc, Wmr, Wpsd, Wpmin
<b>Original profile parameters</b>	Pa, Pt, Pp, Pc, Pv, Pz, Pq, Psm, Psk, Pku, RzJ, Rpq, Rvq, Rmq, Pmr, PΔq, Avh, Hmax, Hmin, Area, Pδc, Tilt
<b>Motif parameters</b>	Ncrx, R, Rx, AR, Nr, Cpm, Sr, Sar, W, Wx, Aw, Wte, Nw, Sw, Saw
<b>Measuring range</b>	±10mm
<b>Resolution</b>	0.01μm
<b>Linear accuracy</b>	±(4nm+2.5%)
<b>Probe radius/angle</b>	5μm/90°
<b>Cut off</b>	0.025/0.08/0.25/0.8/2.5/8mm
<b>Number of cut-offs</b>	2~7
<b>Measuring unit</b>	μm
<b>Measuring speed</b>	0.1~2mm/s

To be continued



Continued from previous page

**STANDARD DELIVERY**

Main unit (including workbench, controller, driver, sensor)	1 pc
Calibration block	1 set
Probe arm	1 pc
Stylus	1 pc
Air flotation and shockproof system	1 set
Stage	1 set
Vise	1 set
Computer	1 pc
Software	1 set
Printer	1 pc
Installation tools	1 set

**OPTIONAL ACCESSORY**

Probe	refer to details
-------	------------------

**SPECIFICATION OF STANDARD PROBE**

Unit: mm

standard stylus , code SPM-5000-R1 (included)

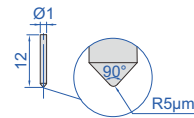

**SPECIFICATION OF PROFILE PROBES**

Unit: mm

chisel stylus

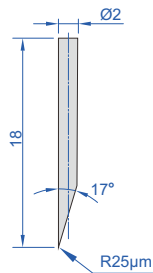

code **SPM-5000-T01** (optional)

standard arm, code SPM-5000-P1 (included), stylus is not included

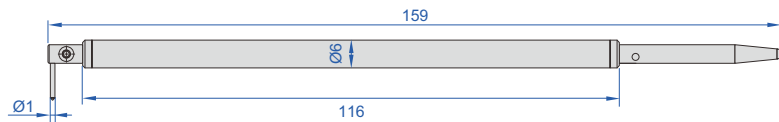

cone stylus

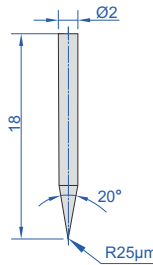

code **SPM-5000-Z01** (optional)

profile arm, code SPM-5000-P2 (optional), stylus is not included

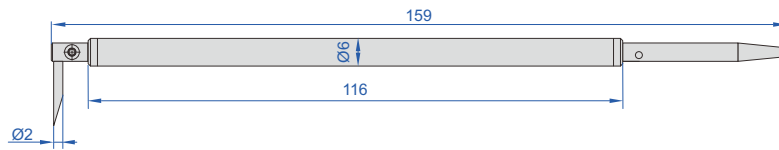

ball stylus

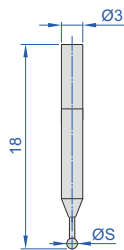

code **SPM-5000-S01** (ØS=1mm, optional)  
code **SPM-5000-S02** (ØS=2mm, optional)

profile arm, code SPM-5000-P3 (optional), stylus is not included

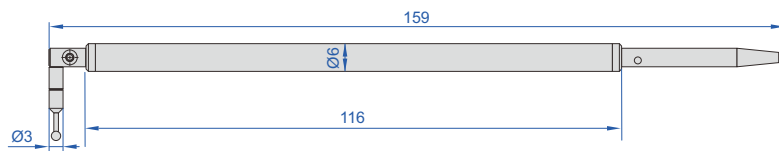

# BIDIRECTIONAL ROUGHNESS AND PROFILE MEASURING MACHINE CODE SPM-6000



- Intelligent tracking control system, real-time scanning measurement
- Bidirectional probe measurement
- Constant measuring force
- Can be used to measure absolute diameters
- Real time variable speed measurement, high-speed measurement can also ensure accuracy
- The trajectory of the probe is vertical, with more realistic Z-axis coordinate point and large range
- The profile data point cloud spacing is consistent, enabling high accuracy measurement



### PROFILE MEASUREMENT SPECIFICATION

X axis measuring range	325mm
X axis resolution	0.01μm
X axis traverse speed	0.1~10mm/s
X axis straightness	0.5μm/100mm
X axis linear accuracy	±(1.5+ 0.15L )μm, L is measuring length in mm
X axis measuring speed	0.1~2mm/s
Z axis measuring range	325mm
Z axis resolution	0.05μm
Z axis traverse speed	0.1~10mm/s
Z axis straightness	0.5μm/100mm
Z axis linear accuracy	±(1.5+ 0.15H )μm, H is measuring height in mm
Z axis measuring speed	0.1~2mm/s
Angular measuring accuracy	±2'
Arc measuring accuracy	±(2+R/8)μm
Measuring unit	mm/inch
Traceable angle	72° (upward), 89° (downward)
Power supply	220±5%V, 50Hz
Dimension (L×W×H)	1700×820×1900mm
Weight	500kg

### ROUGHNESS MEASUREMENT SPECIFICATION

Roughness parameters	Ra, Ramax, Ramin, Rasd, Rp, Rpm <sub>ax</sub> , Rpm <sub>in</sub> , Rpsd, Rv, Rvmax, Rvmin, Rv <sub>sd</sub> , Rz, Rzmax, Rzmin, Rzsd, R3z, Rc, Rcmax, Rcmin, Rcsd, Rt, Rq, Rqmax, Rqmin, Rdsd, Rsk, Rskmax, Rskmin, Rsksd, Rku, Rkumax, Rkumin, Rkusd, Rsm, Rsmmax, Rsmmin, Rsmsd, Rs, RΔa, RΔamax, RΔamin, RΔasd, RΔq, RΔqmax, RΔqmin, RΔqsd, Rk, Rpk, Rvk, Mr1, Mr2, Rλα, Rλαmax, Rλαmin, Rλasd, Rλq, Rλqmax, Rλqmin, Rλqsd, Rδc, Rpc, Rmr
Waviness parameters	Wa, Wamax, Wamin, Wasd, Wsa, Wca, Wa08, Wc, Wcmax, Wcmin, Wcsd, Wt, Wz, Wzmax, Wzmin, Wzsd, Wp, Wpmax, Wv, Wvmax, Wvmin, Wv <sub>sd</sub> , Wq, Wqmax, Wqmin, Wqsd, Wsm, Wsmmax, Wsmmin, Wsmsd, Wsk, Wskmax, Wskmin, Wksd, Wku, Wkumax, Wkumin, Wkusd, WΔq, WΔqmax, WΔqmin, WΔqsd, Wδc, Wmr, Wpsd, Wpmin
Original profile parameters	Pa, Pt, Pp, Pc, Pv, Pz, Pq, Psm, Psk, Pku, RzJ, Rpq, Rvq, Rmq, Pmr, PΔq, Avh, Hmax, Hmin, Area, Pδc, Tiltα
Motif parameters	Ncrx, R, Rx, AR, Nr, Cpm, Sr, Sar, W, Wx, Aw, Wte, Nw, Sw, Saw
Resolution	0.01μm
Linear accuracy	≤±(20nm+5%)
Probe radius/angle	5μm/90°
Cut off	0.025/0.08/0.25/0.8/2.5/8mm
Number of cut-offs	2~7
Measuring unit	μm
Measuring speed	0.1~2mm/s

To be continued

Continued from previous page

**STANDARD DELIVERY**

Main unit (including workbench, controller, driver, sensor)	1 set
Calibration block	1 set
Profile arm	1 pc
Bidirectional profile stylus	1 pc
Roughness arm	1 pc
Unidirectional roughness stylus	1 pc
Stage	1 pc
Vise	1 pc
Computer	1 pc
Software	1 set
Printer	1 pc
Installation tools	1 set



standard balls (included)



standard shaft (included)



vise (included)

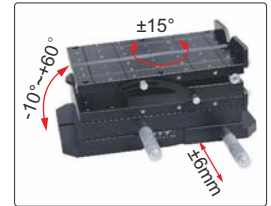

stage (included)



standard blocks (included)

**APPLICATION EXAMPLES**

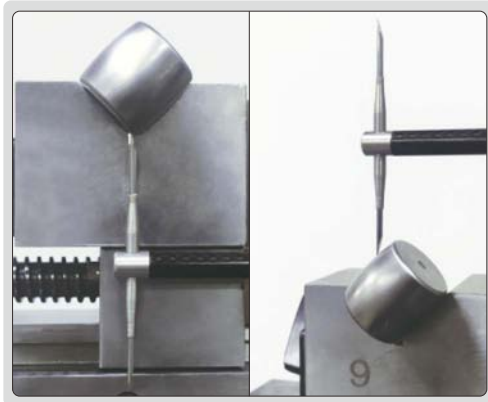

roller bearing

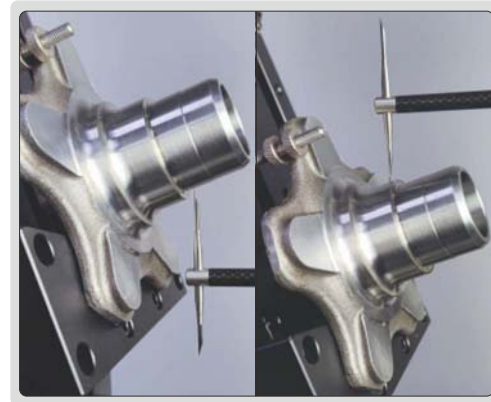

hub bearing

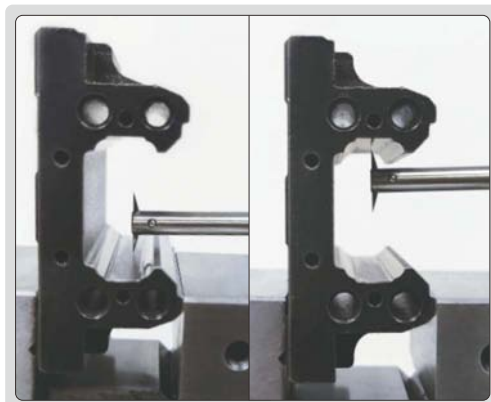

slider

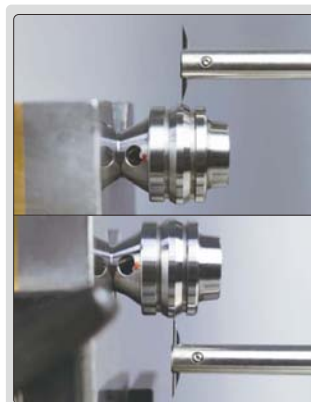

valve spool

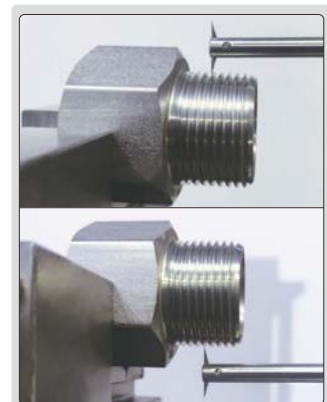

thread

To be continued

Continued from previous page

## SPECIFICATION OF PROBES

Unit: mm

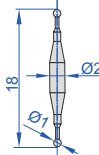
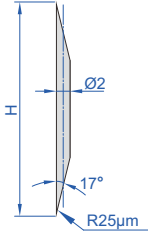
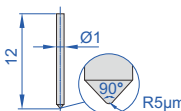
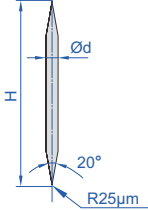
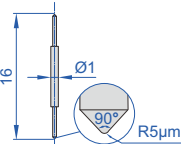
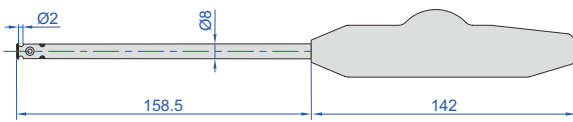
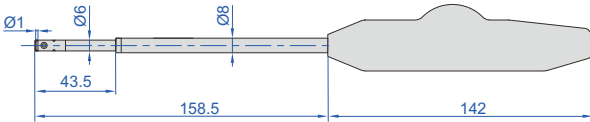
<p><b>bidirectional spherical stylus</b> code <b>SPM-6000-R01</b> (optional)</p> 	<p><b>bidirectional chisel stylus</b> code <b>SPM-6000-T01</b> (H=16mm, included) code <b>SPM-6000-T02</b> (H=24mm, optional) code <b>SPM-6000-T03</b> (H=30mm, optional)</p> 
<p><b>unidirectional roughness stylus</b> code <b>SPM-6000-S01</b> (included)</p> 	<p><b>bidirectional cone stylus</b> code <b>SPM-6000-Z01</b> (H=12mm, Ød=2mm, optional) code <b>SPM-6000-Z02</b> (H=24mm, Ød=2mm, optional) code <b>SPM-6000-Z03</b> (H=10mm, Ød=1mm, optional)</p> 
<p><b>bidirectional roughness stylus</b> code <b>SPM-6000-S02</b> (optional)</p> 	<p><b>profile arm,</b> code <b>SPM-6000-ARM1</b> (included)</p> 
	<p><b>roughness arm,</b> code <b>SPM-6000-ARM2</b> (included)</p> 

31

## ROUGHNESS MEASURING MACHINE CODE SPM-4000



- Skidless probe
- Hundreds of parameters can be evaluated, such as roughness profile, waviness profile, primary profile, etc.
- Software is included, for measurement and data output

### STANDARD DELIVERY

Main unit	1 pc
Roughness probe (with stylus)	1 pc
Calibration block	1 pc
Stage	1 pc
Vise	1 pc
Computer	1 pc
Software	1 set
Printer	1 pc
Installation tools	1 set



To be continued

Continued from previous page

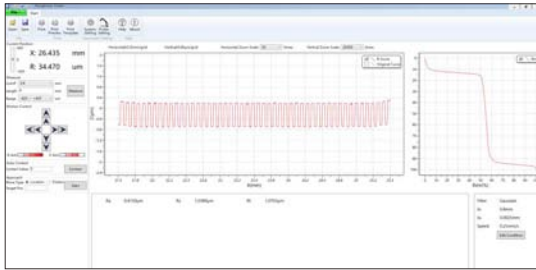

calibration

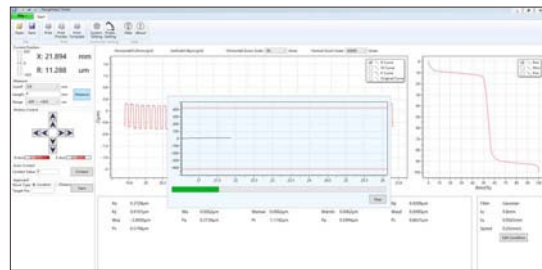

measurement

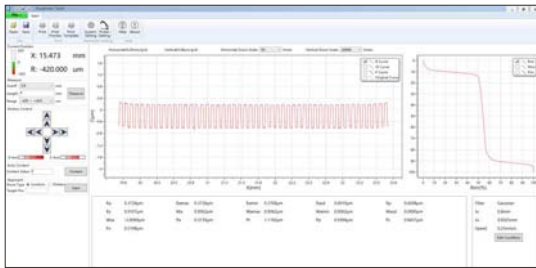

parameter measurement

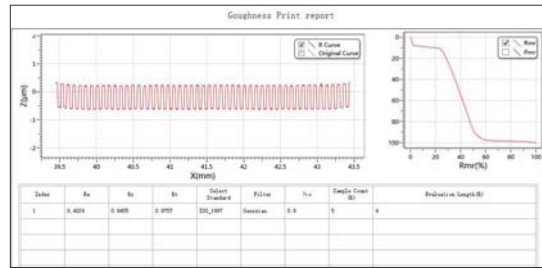

data output

**SPECIFICATION**

<b>Roughness parameters</b>	Ra, Rp, Rv, Rz, Rz (JIS), R3z, Rz (DIN), Rzj, Rmax, Rc, Rt, Rq, Rsk, Rku, Rsm, Rs, RΔq, Rk, Rpk, Rvk, Mr1, Mr2, Rmr
<b>Waviness parameters</b>	Wa, Wt, Wp, Wv, Wz, Wq, Wsm, Wsk, Wku, Wmr
<b>Primary profile parameters</b>	Pa, Pt, Pp, Pv, Pz, Pq, Psm, Psk, Pku, Pmr
<b>X axis measuring range</b>	100mm
<b>X axis resolution</b>	0.2μm
<b>X axis straightness</b>	0.5μm/100mm
<b>X axis moving speed</b>	0.1~10mm/s
<b>Z axis measuring range</b>	±420μm
<b>Z axis resolution</b>	0.001μm
<b>Z axis linear accuracy</b>	≤±(7nm+3.5%)
<b>Z axis moving speed</b>	0.5~10mm/s
<b>Z axis repeatability</b>	1σ≤2nm
<b>Radius/angle of stylus</b>	5μm/90°
<b>Cut off length</b>	0.025/0.08/0.25/0.8/2.5/8mm
<b>Number of cut-offs</b>	2~7
<b>Measuring unit</b>	μm
<b>Drive mode</b>	motor
<b>Travel of Z axis</b>	320mm
<b>Dimension (LxWxH)</b>	1200×700×1780mm
<b>Power supply</b>	220±5%V, 50Hz
<b>Weight</b>	320kg



calibration block (included)



vise (included)

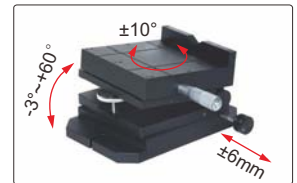

stage (included)

**OPTIONAL ACCESSORY**

<b>Small roughness probe</b>	refer to details
------------------------------	------------------

**SPECIFICATION OF ROUGHNESS PROBE**

Unit: mm

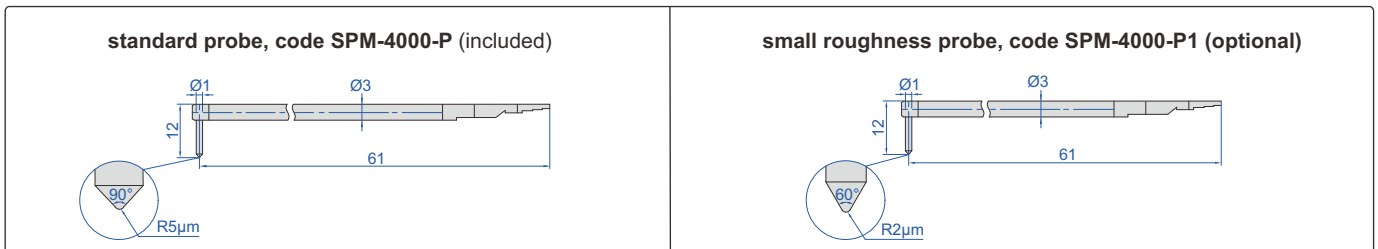

# ROUGHNESS TESTER (COMPACT TYPE) CODE ISR-C200

BLUETOOTH

DATA  
OUTPUT

PROBE CAN BE CHANGED

**INSIZE PLUS**  
MADE IN EUROPE



- The product is light, reliable and durable
- 13 roughness parameters
- Can be operated by mobile phones (only Android system) or computers
- Measurement results can be exported in Excel and PDF format
- Memory of 18000 measurements with only parameters or 30 measurements with graph
- Automatic power off

31



probe can be set at 90°, for transverse measurement



probe cover (included)



adjustable stand (included)

The software interface displays measurement settings for ISO 4287 with a cutoff length of 0.8 mm and a cutoff number of 5. The results table is as follows:

Parameter	Value	Tol.
Ra	1.423 µm	
Rq	3.932 µm	
Rt	13.277 µm	
Rz	13.090 µm	
Rc	12.463 µm	
Rmax	13.277 µm	
RSm	95.4 µm	
RPc_min	105 /cm	

The interface also shows a graph of the surface profile and an export screen with fields for Logo, Description, Notes, Operator, Customer, Drawing number, Lot, and Data to print (P, R, Rk).

measuring software (included), connect to mobile phones via bluetooth (only Android system) to control roughness tester, or connect to computers via USB cable or bluetooth to control roughness tester, display roughness values and curve, results can be exported in Excel and PDF format

To be continued

Continued from previous page

magnetic stand adapter (included)



dial test indicator holder (optional)

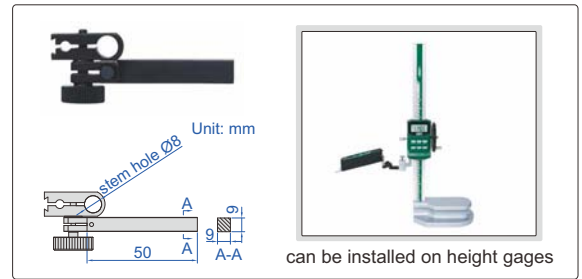

**SPECIFICATION**

<b>Parameters</b>		Ra, Rq, Rt, Rz, Rc, Rmax, RSm, Rpc, Pt, R, AR, Rx, Ppc
<b>Range</b>	X axis	17.5mm
	Z axis	250µm
<b>Accuracy</b>		±(5%+0.025)µm
<b>Resolution (Ra)</b>		0.001µm
<b>Probe</b>	type	inductive
	stylus radius/angle	2µm/90°
	stylus material	diamond
<b>Measuring unit</b>		µm/µin
<b>Cut off</b>		0.25/0.8/2.5mm
<b>Number of cut-off</b>		1~5
<b>Moving speed</b>		0.5mm/s, 1mm/s
<b>Memory</b>		18000 measurements with only parameters, 30 measurements with graph
<b>Power</b>		built-in rechargeable battery
<b>Dimension (L×W×H)</b>		160×34×33.5mm
<b>Weight</b>		200g

**STANDARD DELIVERY**

Main unit	1 pc
Standard probe	1 pc
Calibration block	1 pc
Adjustable stand	1 pc
Probe cover	1 pc
Magnetic stand adapter	1 pc
Software and USB cable	1 pc
AC/DC adapter	1 pc

**OPTIONAL ACCESSORY**

Dial test indicator holder	6293-6
Groove probe	ISR-C200-SB21
Small hole probe	ISR-C200-SB31
Deep groove probe	ISR-C200-SB121
Extension rod	ISR-C200-ER50
Extension rod	ISR-C200-ER100

**SPECIFICATION OF PROBES**

Unit: mm

<p><b>standard probe (included)</b></p> <p>measurement for plane surfaces, also transverse measurement for plane surfaces, cylinders and grooves</p>	<p><b>groove probe (optional), code ISR-C200-SB21</b></p> <p>measure plane surfaces and grooves</p>
<p><b>small hole probe (optional), code ISR-C200-SB31</b></p> <p>measure holes with diameter &gt; Ø4mm and depth &lt; 20mm</p>	<p><b>deep groove probe (optional), code ISR-C200-SB121</b></p> <p>measure grooves with depth &lt; 20mm</p>
<p><b>extension rod (optional), code ISR-C200-ER50</b></p> <p>for long holes</p>	<p><b>extension rod (optional), code ISR-C200-ER100</b></p> <p>for long holes</p>

# ROUGHNESS TESTER CODE ISR-C002

BLUETOOTH

DATA  
OUTPUT

CAN BE OPERATED BY  
MOBILE PHONES OR COMPUTERS



- Roughness tester can be operated by mobile phones (only Android system) or computers
- Data can be sent to Excel by connecting to computers via bluetooth or SPC cable
- Support bluetooth printer
- 21 roughness parameters
- Display roughness value, profile and curve
- Memory of maximum 100 results
- Automatic power off



software flash disk (included)

31

screen display

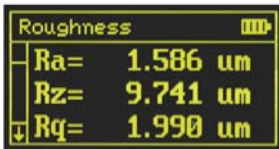

measurement result

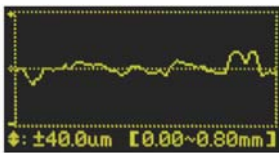

roughness profile



Rmr analysis

probe cover (included)



put the small workpieces directly under the probe for measurement



adjustable stand (included)



operate roughness tester by mobile phones



connect to mobile phones via bluetooth (only Android system), display roughness values, profile and curve

operate roughness tester by computers



connect to computers via USB cable (software is included), display roughness values, profile and curve

data can be sent to Excel by connecting to computer via bluetooth or SPC cable

via bluetooth

receiver (optional)



via SPC cable

SPC cable (optional)



receiver (optional)



bluetooth printer (optional)



To be continued



Continued from previous page

Unit: mm

light duty test stand (optional)



heavy duty test stand (optional)



<p><b>extension rod (optional), code ISR-C002-ER</b></p>	<p><b>transverse rod (optional), code ISR-C002-TR</b></p>
<p><b>tiny hole probe (optional), code ISR-C002-SBP</b></p>	<p><b>deep groove probe (optional), code ISR-C002-DGP</b></p>
<p><b>deep groove probe (optional), code ISR-C002-DGP1</b></p>	

**SPECIFICATION**

<b>Parameters</b>	Ra, Rz, Rq, Rv, Rp, RS, R3z, R3y, Rt, Rz (JIS), Rk, Rku, Rsm, Rpc, Rpk, Rvk, Rsk, Mr1, Mr2, Ry (JIS), Rmax	
<b>Range</b>	320µm (-160µm~160µm)	
<b>Accuracy</b>	±10%	
<b>Resolution (Ra)</b>	0.001µm	
<b>Probe</b>	type	inductive
	stylus radius/angle	5µm/90°
	stylus material	diamond
<b>Measuring force</b>	4mN	
<b>Measuring unit</b>	µm/µin	
<b>Cut off</b>	0.25/0.8/2.5mm	
<b>Number of cut-off</b>	1 to 5	
<b>Moving speed</b>	0.5mm/s, 1mm/s	
<b>Memory</b>	100 measurement results	
<b>Output</b>	bluetooth and USB	
<b>Power</b>	built-in rechargeable battery	
<b>Dimension (L×W×H)</b>	141×55×40mm	
<b>Weight</b>	400g	

**STANDARD DELIVERY**

<b>Main unit</b>	1 pc
<b>Standard probe</b>	1 pc
<b>Calibration block and support</b>	1 pc of each
<b>Adjustable stand</b>	1 pc
<b>Probe cover</b>	1 pc
<b>Software and USB cable</b>	1 pc
<b>AC/DC adapter</b>	1 pc

**OPTIONAL ACCESSORY**

<b>Extension rod</b>	ISR-C002-ER
<b>Transverse rod</b>	ISR-C002-TR
<b>Tiny hole probe</b>	ISR-C002-SBP
<b>Deep groove probe</b>	ISR-C002-DGP
<b>Deep groove probe</b>	ISR-C002-DGP1*
<b>Light duty test stand</b>	ISR-C002-STAND1
<b>Heavy duty test stand</b>	ISR-C002-STAND
<b>Bluetooth printer</b>	ISR-C002-PRINTER
<b>Receiver</b>	ISR-C300-RECEIVER
<b>SPC cable</b>	ISR-C300-SPC

\*Need to be delivered with roughness tester ISR-C002

## ROUGHNESS TESTER (SEPARABLE TYPE) CODE ISR-C300

BLUETOOTH

TOUCH SCREEN

CAN BE OPERATED BY  
COMPUTERS OR MOBILE PHONES

DATA  
OUTPUT

POPULAR  
MODEL

- Roughness tester can be operated by mobile phones (only Android system) or computers
- Data can be sent to Excel by connecting to computers via bluetooth or SPC cable
- Support bluetooth printer
- 22 roughness parameters
- Meet ISO, DIN, ANSI, JIS standards
- Display roughness values, profile and curve
- Memory of maximum 100 data and waveform
- Built-in lithium battery, working time more than 50 hours
- Touch screen
- Automatic power off

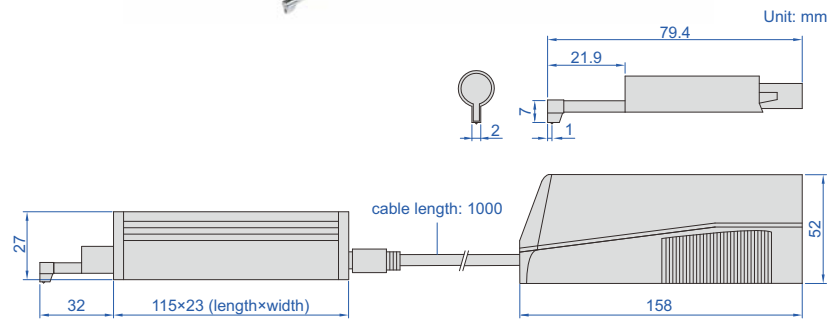

roughness tester screen display

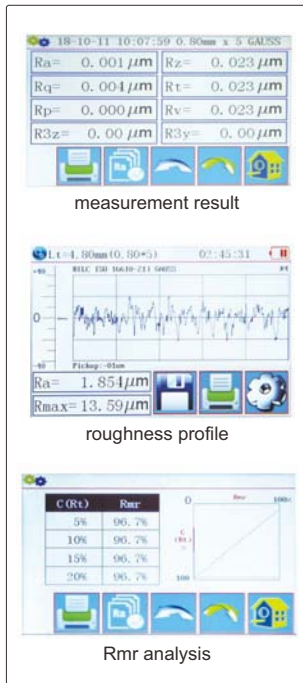

probe and main unit can be combined together



operate roughness tester by mobile phones



operate roughness tester by computers

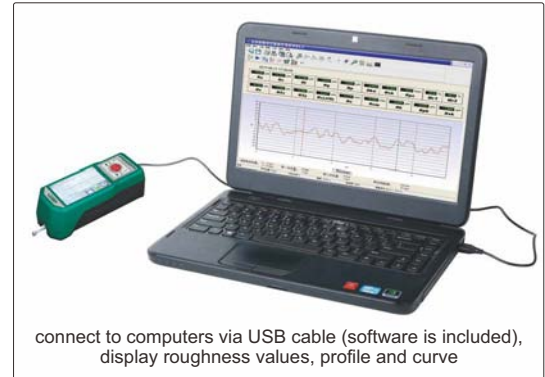

To be continued

Continued from previous page

data can be sent to Excel by connecting to computer via bluetooth or SPC cable

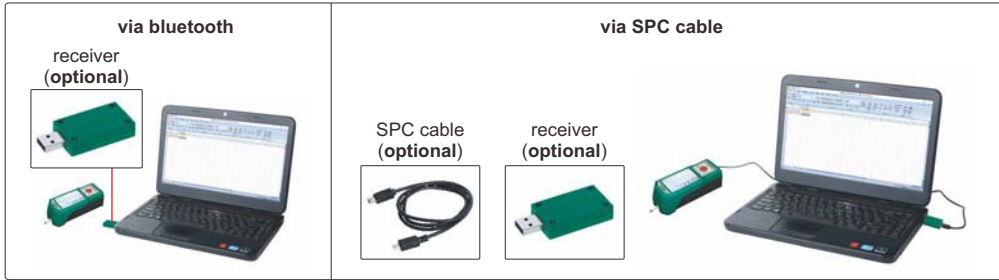

bluetooth printer (optional)



probe support (optional)

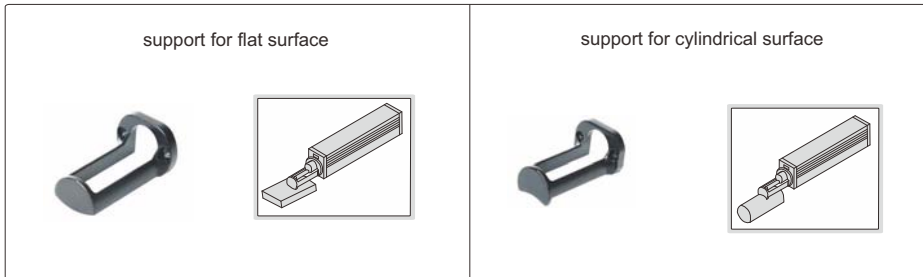

adjustable stand (included)



magnetic stand adapter (included)

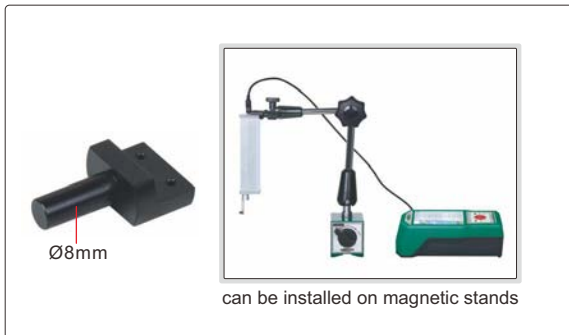

height gage adapter (optional)



**NOTE:** Please check whether the adapter can fit your height gages. When using **INSIZE** height gages, please use the dial test indicator holder of height gages

light duty test stand (optional)



heavy duty test stand (optional)



To be continued

Continued from previous page

optional probes

Unit: mm

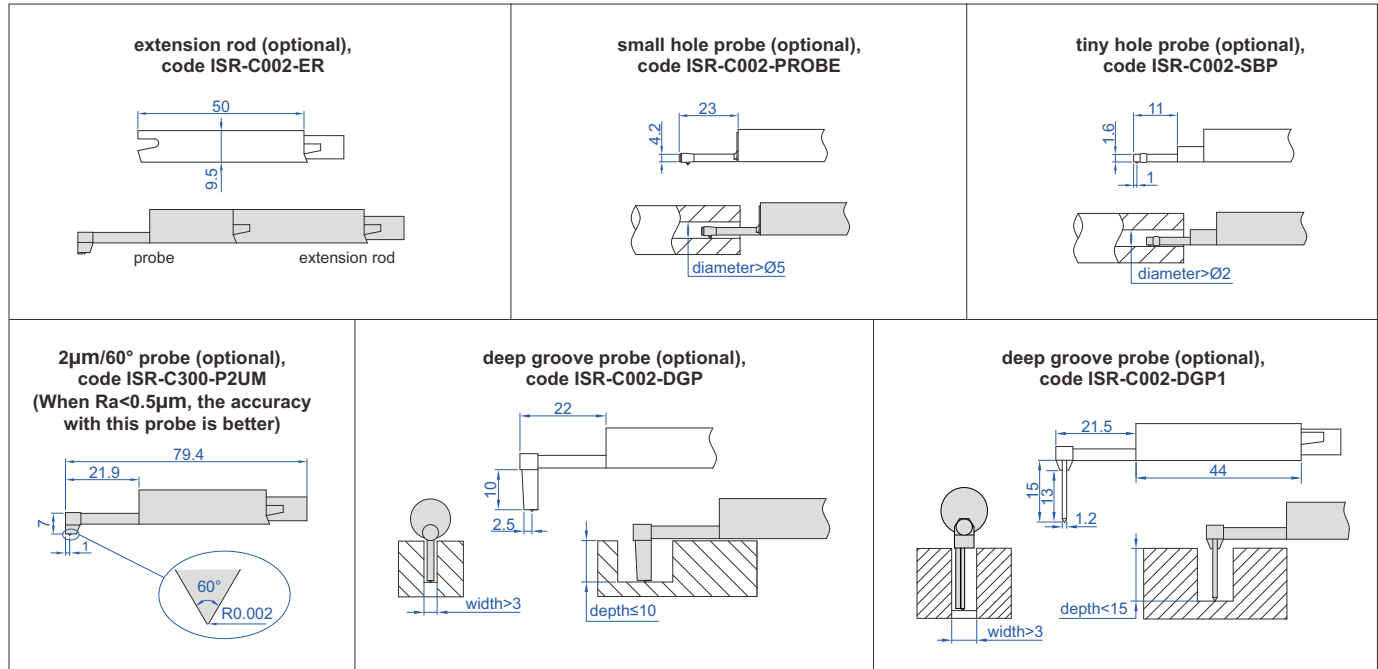

31

## SPECIFICATION

<b>Parameters</b>		Ra, Rz, Rq, Rv, Rp, Rs, R3z, R3y, Rt, Rc, Rz (JIS), Rk, Rku, Rsm, Rpc, Rpk, Rvk, Rsk, Mr1, Mr2, Ry, Rmax
<b>Range</b>	<b>X axis</b>	17.5mm
	<b>Z axis</b>	320µm (-160µm~160µm)
<b>Accuracy</b>		±10%
<b>Resolution (Ra)</b>		0.001µm
<b>Probe</b>	<b>type</b>	inductive
	<b>stylus radius/angle</b>	5µm/90°
	<b>stylus material</b>	diamond
<b>Measuring force</b>		4mN
<b>Measuring unit</b>		µm/µin
<b>Cut off</b>		0.25/0.8/2.5mm
<b>Number of cut-offs</b>		1~5
<b>Moving speed</b>		0.135mm/s, 0.5mm/s, 1mm/s
<b>Memory</b>		100 measurement results
<b>Output</b>		USB and bluetooth
<b>Power</b>		built-in rechargeable battery
<b>Dimension (L×W×H)</b>		158×64×52mm
<b>Weight</b>		400g

## STANDARD DELIVERY

<b>Main unit</b>	1 pc
<b>Standard probe</b>	1 pc
<b>Calibration block and support</b>	1 pc of each
<b>Connecting cable (long and short)</b>	1 pc of each
<b>Magnetic stand adapter</b>	1 pc
<b>Adjustable stand</b>	1 pc
<b>Touch pen</b>	1 pc
<b>Software and USB cable</b>	1 pc
<b>AC/DC adapter</b>	1 pc

## OPTIONAL ACCESSORY

<b>Extension rod</b>	ISR-C002-ER
<b>Small hole probe</b>	ISR-C002-PROBE
<b>Tiny hole probe</b>	ISR-C002-SBP
<b>Deep groove probe</b>	ISR-C002-DGP
<b>Deep groove probe</b>	ISR-C002-DGP1*
<b>2µm/60° probe</b>	ISR-C300-P2UM
<b>Bluetooth printer</b>	ISR-C002-PRINTER
<b>Height gage adapter</b>	ISR-C300-LB1
<b>Receiver</b>	ISR-C300-RECEIVER
<b>SPC cable</b>	ISR-C300-SPC
<b>Support for flat surface</b>	ISR-C300-COVER1
<b>Support for cylindrical surface</b>	ISR-C300-COVER2
<b>Light duty test stand</b>	ISR-C002-STAND1
<b>Heavy duty test stand</b>	ISR-C002-STAND

\*Need to be delivered with roughness tester ISR-C300



DATA OUTPUT

BLUETOOTH

TOUCH SCREEN

CAN BE OPERATED BY MOBILE PHONES OR COMPUTERS

# ROUGHNESS TESTER CODE ISR-T120



31

- Roughness tester can be operated by mobile phones (only Android system) or computers
- Data can be sent to Excel by connecting to computers via bluetooth or SPC cable
- Built-in printer can print measurement results and graphics
- 22 roughness parameters
- Meet ISO, DIN, ANSI, JIS standards
- Display roughness values, profile and curve
- Memory of maximum 100 data and waveform
- Built-in lithium battery, working time more than 50 hours
- Automatic power off

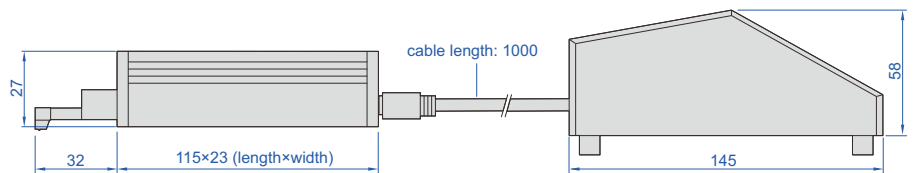
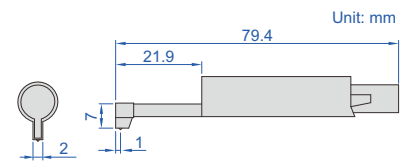

roughness tester screen display

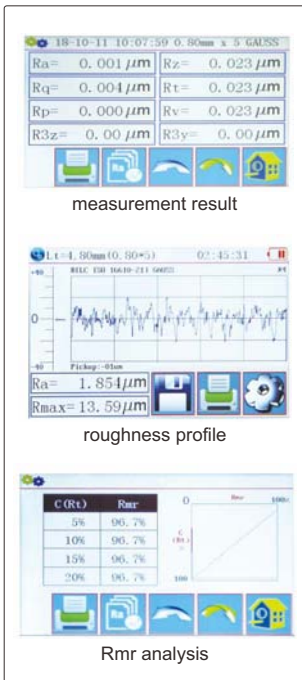

operate roughness tester by mobile phones



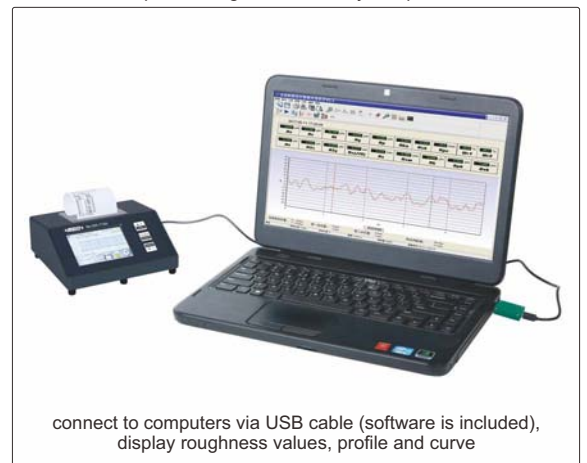

operate roughness tester by computers



To be continued

Continued from previous page

data can be sent to Excel by connecting to computer via bluetooth or SPC cable

<p><b>via bluetooth</b></p> <p>receiver (optional)</p> 	<p><b>via SPC cable</b></p> <p>SPC cable (optional)</p>  <p>receiver (optional)</p> 
--	---

probe support (optional)

support for cylindrical surface

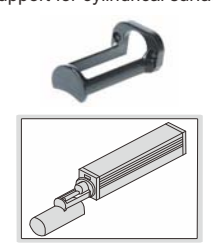

support for flat surface

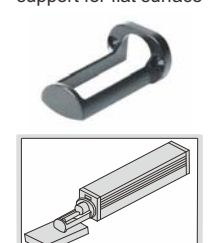

height gage adapter (optional)



9×9mm

can be installed on height gages

magnetic stand adapter (included)



Ø8mm

can be installed on magnetic stands

**NOTE:** Please check whether the adapter can fit your height gages. When using **INSIZE** height gages, please use the dial test indicator holder of height gages

optional probes

Unit: mm

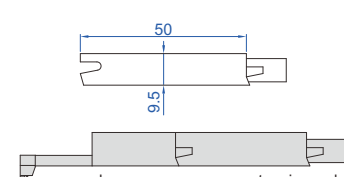
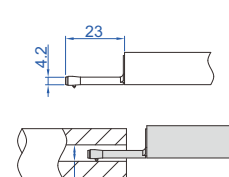
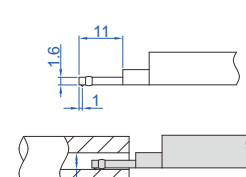
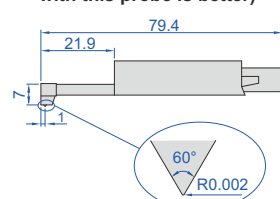
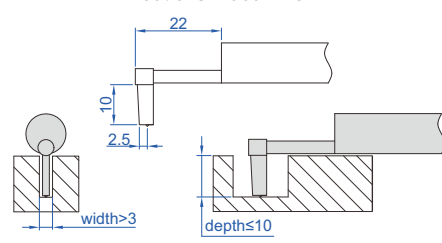
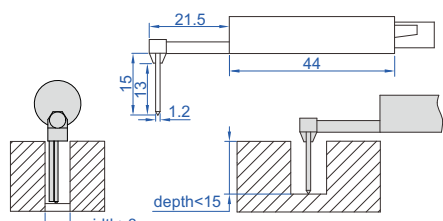
<p><b>extension rod (optional), code ISR-C002-ER</b></p>  <p>probe      extension rod</p>	<p><b>small hole probe (optional), code ISR-C002-PROBE</b></p>  <p>diameter &gt; Ø5</p>	<p><b>tiny hole probe (optional), code ISR-C002-SBP</b></p>  <p>diameter &gt; Ø2</p>
<p><b>2µm/60° probe (optional), code ISR-C300-P2UM</b> (When Ra &lt; 0.5µm, the accuracy with this probe is better)</p> 	<p><b>deep groove probe (optional), code ISR-C002-DGP</b></p>  <p>width &gt; 3      depth ≤ 10</p>	<p><b>deep groove probe (optional), code ISR-C002-DGP1</b></p>  <p>width &gt; 3      depth &lt; 15</p>

To be continued

Continued from previous page

light duty test stand (optional)



heavy duty test stand (optional)



**SPECIFICATION**

<b>Parameters</b>		Ra, Rz, Rq, Rv, Rp, Rs, R3z, R3y, Rt, Rc, Rz (JIS), Rk, Rku, Rsm, Rpc, Rpk, Rvk, Rsk, Mr1, Mr2, Ry, Rmax
<b>Range</b>	<b>X axis</b>	17.5mm
	<b>Z axis</b>	640µm (-320µm~320µm)
<b>Accuracy</b>		±10%
<b>Resolution (Ra)</b>		0.001µm
<b>Probe</b>	<b>type</b>	inductive
	<b>stylus radius/angle</b>	5µm/90°
	<b>stylus material</b>	diamond
<b>Measuring force</b>		4mN
<b>Measuring unit</b>		µm/µin
<b>Cut off</b>		0.25/0.8/2.5mm
<b>Number of cut-offs</b>		1~5
<b>Traverse speed</b>		0.135mm/s, 0.5mm/s, 1mm/s
<b>Memory</b>		100 measurement results
<b>Output</b>		bluetooth and USB
<b>Power</b>		built-in rechargeable battery
<b>Dimension (L×W×H)</b>		155×145×58mm
<b>Weight</b>		1000g

**STANDARD DELIVERY**

<b>Main unit</b>	1 pc
<b>Standard probe</b>	1 pc
<b>Calibration block and support</b>	1 pc of each
<b>Magnetic stand adapter</b>	1 pc
<b>Adjustable stand</b>	1 pc
<b>Touch pen</b>	1 pc
<b>Software and USB cable</b>	1 pc
<b>AC/DC adapter</b>	1 pc

**OPTIONAL ACCESSORY**

<b>Extension rod</b>	ISR-C002-ER
<b>Small hole probe</b>	ISR-C002-PROBE
<b>Tiny hole probe</b>	ISR-C002-SBP
<b>2µm/60° probe</b>	ISR-C300-P2UM
<b>Deep groove probe</b>	ISR-C002-DGP
<b>Deep groove probe</b>	ISR-C002-DGP1 *
<b>Height gage adapter</b>	ISR-C300-LB1
<b>Receiver</b>	ISR-C300-RECEIVER
<b>SPC cable</b>	ISR-C300-SPC
<b>Support for flat surface</b>	ISR-C300-COVER1
<b>Support for cylindrical surface</b>	ISR-C300-COVER2
<b>Light duty test stand</b>	ISR-C002-STAND1
<b>Heavy duty test stand</b>	ISR-C002-STAND

\*Need to be delivered with roughness tester ISR-T120

## ROUGHNESS TESTER (BASIC TYPE) CODE ISR-C003

ATTENTION: THIS ROUGHNESS TESTER IS NOT SUITABLE FOR ROUGH TURNING, MILLING AND PLANING WORKPIECES

- Unit:  $\mu\text{m}$ ,  $\mu\text{in}$
- Automatic power off

### SPECIFICATION

Parameters		Ra, Rz, Rq, Rt
Range		Ra, Rq: 0.05~15 $\mu\text{m}$ Rz, Rt: 0.1~50 $\mu\text{m}$
Accuracy		$\pm 10\%$
Resolution (Ra)		0.01 $\mu\text{m}$
Probe	type	piezoelectric
	stylus radius/angle	10 $\mu\text{m}/90^\circ$
	stylus material	diamond
Measuring force		5mN
Measuring unit		$\mu\text{m}/\mu\text{in}$
Cut off		0.25/0.8/2.5mm
Evaluation length		1.25mm for cut off 0.25mm 4mm for cut off 0.8mm 5mm for cut off 2.5mm
Moving speed		0.75mm/s
Power		built-in rechargeable battery
Dimension (L×W×H)		106×70×24mm
Weight		200g



fixture for small shafts (optional)



application



calibration block (included)

### STANDARD DELIVERY

Main unit	1 pc
Calibration block	1 pc
AC/DC adapter	1 pc

### OPTIONAL ACCESSORY

Fixture for small shafts	ISR-C003-FIXTURE
--------------------------	------------------

## SURFACE ROUGHNESS SPECIMEN SET CODE ISR-CS130-W

**INSIZE PLUS**  
MADE IN EUROPE

- For checking, identifying and specifying the roughness by symbol
- Rust-proof, made of pure Nickel



Machining method	Roughness (Ra) *	Roughness (Rz) *	Quantity
Flat lapping	0.05, 0.1, 0.2 $\mu\text{m}$	0.55, 1, 1.6 $\mu\text{m}$	3 pcs
	2, 4, 8 $\mu\text{in}$		
Reaming	0.4, 0.8, 1.6 $\mu\text{m}$	3, 6, 10 $\mu\text{m}$	3 pcs
	16, 32, 63 $\mu\text{in}$		
Plain grinding	0.05, 0.1, 0.2, 0.4, 0.8, 1.6 $\mu\text{m}$	0.55, 1, 1.6, 3, 6, 10 $\mu\text{m}$	6 pcs
	2, 4, 8, 16, 32, 63 $\mu\text{in}$		
Horizontal milling	0.4, 0.8, 1.6, 3.2, 6.3, 12.5 $\mu\text{m}$	2.5, 4, 8, 16, 32, 50 $\mu\text{m}$	6 pcs
	16, 32, 63, 125, 250, 500 $\mu\text{in}$		
Vertical milling	0.4, 0.8, 1.6, 3.2, 6.3, 12.5 $\mu\text{m}$	2.5, 4, 8, 16, 32, 50 $\mu\text{m}$	6 pcs
	16, 32, 63, 125, 250, 500 $\mu\text{in}$		
Turning	0.4, 0.8, 1.6, 3.2, 6.3, 12.5 $\mu\text{m}$	2.5, 4, 8, 16, 32, 50 $\mu\text{m}$	6 pcs
	16, 32, 63, 125, 250, 500 $\mu\text{in}$		

\* The actual value is the value to be calibrated



## SURFACE ROUGHNESS SPECIMENS

**INSIZE PLUS**  
MADE IN EUROPE

- For checking, identifying and specifying the roughness by symbol
- Rust-proof, made of pure Nickel



ISR-CS315

Code	Machining method	Roughness (Ra) *	Roughness (Rz) *	Quantity
ISR-CS315	surface grinding	0.025, 0.05, 0.1, 0.2, 0.4, 0.8, 1.6, 3.2µm	0.29, 0.55, 0.91, 1.74, 2.6, 4.65, 7.87, 15.6µm	8 pcs
ISR-CS316	cylindrical grinding	0.025, 0.05, 0.1, 0.2, 0.4, 0.8, 1.6, 3.2µm	0.3, 0.53, 0.88, 1.56, 2.64, 4.4, 7.71, 15.3µm	8 pcs
ISR-CS317	flat lapping	criss-cross	0.025, 0.05, 0.1, 0.2µm	0.4, 0.6, 0.74, 1.26µm
		parallel	0.025, 0.05, 0.1, 0.2µm	0.34, 0.56, 1.12, 1.5µm
ISR-CS318	cylindrical lapping	0.025, 0.05, 0.1, 0.2µm	0.46, 0.54, 0.63, 1.23µm	4 pcs
	superfinishing	0.025, 0.05, 0.1, 0.2µm	0.36, 0.7, 1, 1.4µm	4 pcs
ISR-CS319	face turning	0.4, 0.8, 1.6, 3.2, 6.3, 12.5, 25, 50µm	1.92, 3.2, 6.15, 12.5, 23.7, 48.7, 102, 185µm	8 pcs
ISR-CS320	cylindrical turning	0.4, 0.8, 1.6, 3.2, 6.3, 12.5, 25, 50µm	1.7, 3.2, 6.1, 12.2, 23.7, 47.5, 95, 190µm	8 pcs
ISR-CS321	end milling	0.4, 0.8, 1.6, 3.2, 6.3, 12.5, 25, 50µm	1.92, 3.82, 6.45, 12.2, 25.2, 49.8, 92.6, 191µm	8 pcs
ISR-CS322	reaming	0.4, 0.8, 1.6, 3.2µm	1.7, 3.2, 6.4, 12.8µm	4 pcs
	drilling	1.6, 3.2, 6.3, 12.5µm	7.5, 15.5, 31, 60µm	4 pcs
ISR-CS323	horizontal milling	0.4, 0.8, 1.6, 3.2, 6.3, 12.5, 25, 50µm	1.8, 3.68, 6.63, 12.8, 25.6, 53, 97.5, 197µm	8 pcs
ISR-CS325	shaping (planing)	0.8, 1.6, 3.2, 6.3, 12.5, 25, 50, 100µm	3.84, 6.7, 12.2, 25.2, 48.7, 99.9, 190, 361µm	8 pcs
ISR-CS326	linishing (belt sanding)	0.1, 0.2, 0.4, 0.8, 1.6, 3.2µm	0.9, 1.55, 3.37, 7.42, 18.5, 31µm	6 pcs
ISR-CS328	vertical grinding	0.2, 0.4, 0.8, 1.6, 3.2, 6.3µm	1.1, 3.5, 6.15, 8.78, 22.19, 40.8µm	6 pcs
ISR-CS329	grit blasting	3.2, 10.5, 18, 25µm	19.2, 63, 108, 150µm	4 pcs
	shot blasting	3.2, 8, 13, 18µm	19.2, 48, 78, 108µm	4 pcs
ISR-CS331	spark erosion (EDM)	0.4, 0.8, 1.6, 3.2, 6.3, 12.5, 25, 50µm	2.5, 4.5, 7.2, 14.2, 24.7, 51.2, 105, 196µm	8 pcs
ISR-CS333	hand filing	0.4, 0.8, 1.6, 3.2, 6.3µm	3, 5.6, 12.4, 22.5, 61µm	5 pcs
ISR-CS334	castings	0.8, 1.6, 3.2, 6.3, 12.5, 25, 50µm	3.2, 8, 16, 32, 56, 112, 225µm	7 pcs
ISR-CS335	honing	0.05, 0.1, 0.2, 0.4, 0.8, 1.6µm	0.31, 0.56, 1, 2, 4.2, 9µm	6 pcs
ISR-CS336	polishing	0.0125, 0.025, 0.05, 0.1, 0.2µm	0.29, 0.35, 0.67, 0.72, 1.52µm	5 pcs

\* The actual value is the value to be calibrated

## SHOT AND GRIT BLASTING SURFACE ROUGHNESS SPECIMENS

**INSIZE PLUS**  
MADE IN EUROPE

- To check the roughness of steel surfaces which have been blast cleaned before painting
- Meets ISO 8503/1
- Rust-proof, made of pure Nickel
- Each piece contains 4 parts



ISR-CS017

Code	Machining method	Roughness (Ra) *	Roughness (Rz) *
ISR-CS017	shot blasting	3.2, 8, 13, 18µm	19.2, 48, 78, 108µm
ISR-CS018	grit blasting	3.2, 10.5, 18, 25µm	19.2, 63, 108, 150µm

\* The actual value is the value to be calibrated

## SURFACE ROUGHNESS REFERENCE SPECIMENS

**INSIZE PLUS**  
MADE IN EUROPE

MEASURING ACCURACY OF ROUGHNESS TESTERS CAN BE IMPROVED, IF THE CALIBRATION IS MADE ON A REFERENCE SPECIMEN WITH THE ROUGHNESS VALUE CLOSE TO THE WORKPIECE TO BE MEASURED

- To calibrate roughness testers
- Meets ISO 5436-1: 2000
- Rust proof, made of pure Nickel

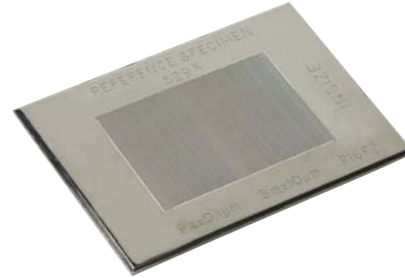

ISR-RS529X

Code	Roughness (Ra)
ISR-RS525X	6.25µm *
ISR-RS526X	3.15µm *
ISR-RS527X	3.0µm *
ISR-RS528X	0.5µm *
ISR-RS529X	0.1µm *
ISR-RS530X	1.0µm *
ISR-RS531X	0.3µm *

\*The actual value may be slightly different

## SURFACE ROUGHNESS REFERENCE SPECIMENS

MEASURING ACCURACY OF ROUGHNESS TESTERS CAN BE IMPROVED, IF THE CALIBRATION IS MADE ON A REFERENCE SPECIMEN WITH THE ROUGHNESS VALUE CLOSE TO THE WORKPIECE TO BE MEASURED

- To calibrate roughness testers
- Made of glass



ISR-LS603

Code	Roughness (Ra)	Deviation *	Uniformity
ISR-LS601	0.1µm	-20% ~ +10%	3%
ISR-LS602	0.2µm	±10%	3%
ISR-LS603	0.4µm	±10%	3%
ISR-LS604	0.8µm	±10%	3%
ISR-LS605	1.6µm	±10%	3%
ISR-LS606	3.2µm	±10%	2%
ISR-LS607	6.4µm	±10%	2%

\*Deviation between the actual value when supply and the nominal value



Rockwell Hardness Testers  
Page 789-803



Micro-Vickers Hardness Testers  
Page 804-809



Vickers Hardness Testers  
Page 810-813



Brinell Hardness Testers  
Page 814-815



Brinell Indentation Measuring  
Systems  
Page 816



Brinell/Rockwell/Vickers Hardness  
Testers  
Page 817



Brackets  
Page 818



Leeb Hardness Testers  
Page 819-828



Magnetic Rockwell Hardness Testers  
Page 829-830



Magnetic Brinell/Rockwell Hardness  
Testers  
Page 830-831



Portable Rockwell Hardness Testers  
Page 831



Pin Brinell Hardness Testers  
Page 832



Hydraulic Brinell Hardness Testers  
Page 833



Chain Type Hydraulic Brinell  
Hardness Testers  
Page 833



Aluminum Hardness Testers  
Page 834-835



Aluminum Hardness Testers  
Page 835



Shore Durometers  
Page 836-839



Fruit Hardness Testers  
Page 839

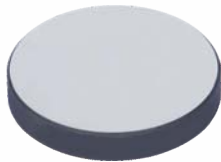

Hardness Test Blocks  
Page 840-841



Concrete Strength Testers  
Page 842



# AUTOMATIC DIGITAL ROCKWELL/SUPERFICIAL ROCKWELL HARDNESS TESTERS CODE HDT-CRS200

BUILT-IN  
BLUETOOTH

AUTOMATIC  
OPERATION

FORCE LOADING BY ELECTRIC  
MOTOR (WITHOUT WEIGHTS)

TOUCH  
SCREEN

HIGH  
ACCURACY

HIGH  
EFFICIENCY

INSPECTION  
CERTIFICATE



8" touch screen

test scale: HRC  
standard selection: ASTM E140 Table1  
setting: testing, display, chart  
load dwell time: 5 5  
converted scale: HRC  
hardness value correction: 0.5  
program setting: testing, display, chart

start  
emergency stop  
control up and down movement of the indenter

- One click operation can obtain measurement results, enabling large-scale hardness measurement of workpieces
- CNC system, close-loop electronic control system applies test force
- Touch screen operation and display
- Cantilevered structure, achieving full automation of hardness measurement
- The big flat stage is convenient for testing and can work in conjunction with robotic arms and automation equipment to step up online hardness testing and achieve completely unmanned testing
- Bluetooth, RS232 data transmission to computer, data management using hardness management software
- According to ISO 6508, ASTM E18, JIS Z2245

test interface

indenter type: Diamond  
test force: 150 Kg  
load dwell time  
test force curve

test result display interface

test scale  
converted scale  
standard selection  
indentation depth: 158.9 μm  
test result: 59.7 HRC  
Pass

chart interface

test information  
maximum value  
chart data  
test scale  
converted scale

SEL	NUM	MEAS	CONV	RANG	MAX
1	58.7	80.5	0.0	60.1	MIN
2	59.6	81.0	0.0	58.7	AVE
3	60.1	81.3	0.0	59.5	RANGE
4	59.5	80.9	0.0	1.4	
5	59.6	81.0	0.0		

To be continued

Continued from previous page



Ø58mm flat anvil  
(included)



V-type anvil  
(included)



bluetooth printer  
(included)

## SPECIFICATION

<b>Measurement range</b>		Rockwell: 20~88HRA, 20~100HRB, 20~70HRC Superficial RockWell: 70~91HR15N, 42~80HR30N, 42~70HR45N, 73~93HR15T, 43~82HR30T, 12~72HR45T
<b>Hardness scale</b>	<b>with indenter included</b>	HRA, HRB, HRC, HRD, HRF, HRG, HR15N, HR30N, HR45N, HR15T, HR30T, HR45T
	<b>with optional indenter</b>	HRE, HRH, HRK, HRL, HRM, HRP, HRR, HRS, HRV, HR15W, HR30W, HR45W, HR15X, HR30X, HR45X, HR15Y, HR30Y, HR45Y
<b>Preliminary test force</b>		Superficial Rockwell: 29.4N (3kgf) Rockwell: 98N (10kgf)
<b>Test force</b>		Superficial Rockwell: 147N (15kg), 294N (30kg), 441N (45kg) Rockwell: 588N (60kg), 980N (100kg), 1471N (150kg)
<b>Test force accuracy</b>		±1%
<b>Operational mode</b>		automatic
<b>Load control</b>		automatic (load/dwell/unload)
<b>Resolution</b>		0.05HR
<b>Load dwell time</b>		0~99 second
<b>Max. workpiece height</b>		300mm
<b>Max. testing width</b>		200mm (from the center of indenter to the wall of main body)
<b>Output</b>		bluetooth printer, RS232
<b>Power supply</b>		220V, 50/60HZ
<b>Dimension</b>		555×400×1250mm
<b>Weight</b>		130kg

## STANDARD DELIVERY

Main unit	1 pc
Diamond indenter	1 pc
Ø1.588mm carbide ball indenter	1 pc
Ø58mm flat anvil	1 pc
V-type anvil	1 pc
Hardness test block HRB20~30	1 pc
Hardness test block HRC60~70	1 pc
Hardness test block HRBW80~100	1 pc
Hardness test block HR30N60~85	1 pc
Hardness test block HR30TW70~85	1 pc
Bluetooth printer	1 pc
Hardness analysis software	1 pc

## OPTIONAL ACCESSORY

Hardness test block HRC20~30	HDT-B-HRC1
Hardness test block HRC60~70	HDT-B-HRC3
Hardness test block HRB80~100	HDT-B-HRB
Hardness test block HR15N78~88	HDT-B-HR15N2
Hardness test block HR30N55~73	HDT-B-HR30N2
Hardness test block HR30T73~82	HDT-B-HR30T
Desk	HDT-DESK1

DATA  
OUTPUT

FORCE LOADING BY ELECTRIC  
MOTOR (WITHOUT WEIGHTS)

# MOTORIZED DIGITAL ROCKWELL HARDNESS TESTERS (DOLPHIN-NOSE TYPE)

INSPECTION  
CERTIFICATE

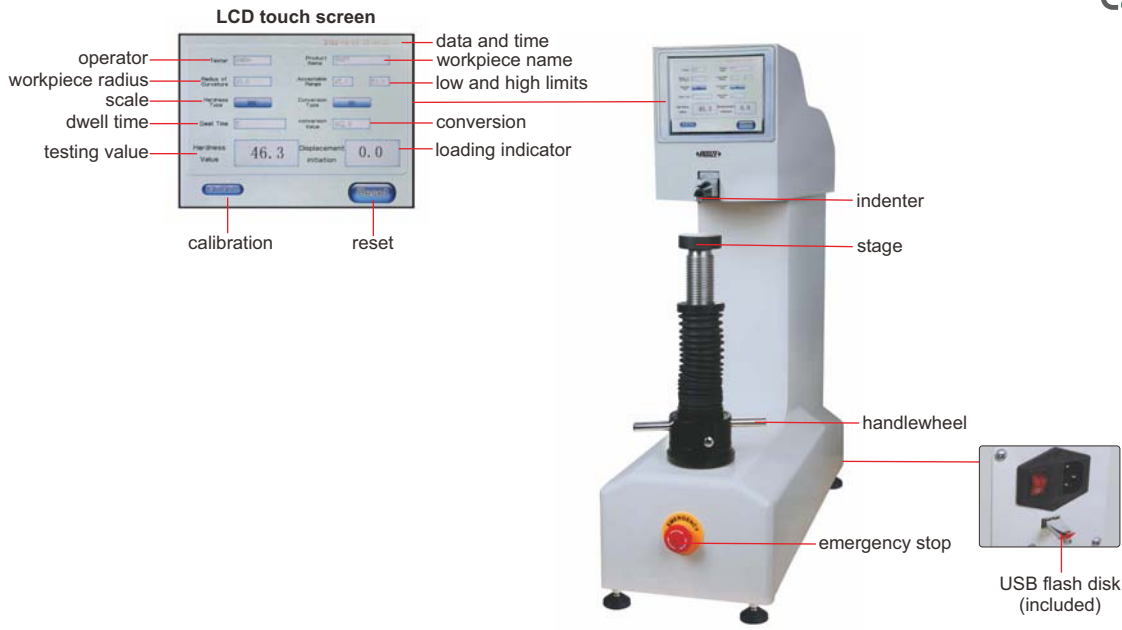

ISHR-T100



Ø63mm flat anvil (included)



Ø150mm flat anvil (included)



level (included)



touch pen (included)



V-type anvil (included) for cylinders with diameter Ø4~60mm



desk (optional)



small V-type anvil (optional) for cylinders with diameter Ø2~4mm

- Dolphin-nose indenter to reach interior of pipe and groove
- Automatic testing after preliminary test force is loaded by hand
- LCD touch screen, easy operation
- Convert to other Rockwell scales, HV or HB automatically
- Tolerance testing
- Insert USB disk, save the testing results as Excel
- Self-compensation of the hardness value for curved workpiece
- Force loading by electric motor (without weights)
- The test force is selected automatically according to hardness scale
- According to ISO 6508

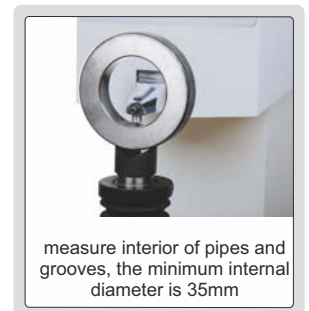

To be continued

Continued from previous page

### SPECIFICATION

Code		ISHR-T100	ISHR-T200	ISHR-T300
Type		Rockwell	Superficial Rockwell	Rockwell and Superficial Rockwell
Hardness scale	with standard indenter	HRA, HRB, HRC, HRD, HRF, HRG	HR15N, HR30N, HR45N, HR15T, HR30T, HR45T	HRA, HRB, HRC, HRD, HRF, HRG, HR15N, HR30N, HR45N, HR15T, HR30T, HR45T
	with optional indenter	HRE, HRH, HRK, HRL, HRM, HRP, HRR, HRS, HRV	HR15W, HR30W, HR45W, HR15X, HR30X, HR45X, HR15Y, HR30Y, HR45Y	HRE, HRH, HRK, HRL, HRM, HRP, HRR, HRS, HRV, HR15W, HR30W, HR45W, HR15X, HR30X, HR45X, HR15Y, HR30Y, HR45Y
Preliminary test force		98N/10kgf for Rockwell	29.4N/3kgf for Superficial Rockwell	98N/10kgf for Rockwell 29.4N/3kgf for Superficial Rockwell
Test force		588N (60kg), 980N (100kg), 1471N (150kg)	147.1N (15kg), 294.2N (30kg), 441.3N (45kg)	147.1N (15kg), 294.2N (30kg), 441.3N (45kg), 588N (60kg), 980N (100kg), 1471N (150kg)
Stage elevation		manual		
Load control		automatic (load/dwell/unload)		
Load dwell time		0~99 second		
Resolution		0.1HR		
Output		USB		
Max. workpiece height		300mm		
Max. testing width		250mm (from the center of indenter to the wall of main body)		
Power supply		220V, 50/60Hz		
Dimension		720×260×840mm		
Weight		80kg		

### STANDARD DELIVERY

Code	ISHR-T100	ISHR-T200	ISHR-T300
Main unit	1 pc	1 pc	1 pc
Ø63mm flat anvil	1 pc	1 pc	1 pc
Ø150mm flat anvil	1 pc	1 pc	1 pc
V-type anvil	1 pc	1 pc	1 pc
Diamond indenter	1 pc	1 pc	1 pc
Ø1.5875mm carbide ball indenter	1 pc	1 pc	1 pc
Hardness test block HRB88~95	1 pc	—	1 pc
Hardness test block HRC60~65	1 pc	—	1 pc
Hardness test block HRC20~30	1 pc	—	1 pc
Hardness test block 78~88HR15N	—	1 pc	1 pc
Hardness test block 55~73HR30N	—	1 pc	1 pc
Hardness test block 57~69HR30T	—	1 pc	1 pc
USB disk	1 pc	1 pc	1 pc
Level	1 pc	1 pc	1 pc
Touch pen	1 pc	1 pc	1 pc
Anti-dust cover	1 pc	1 pc	1 pc

### OPTIONAL ACCESSORY

Hardness test block HRB88~100	HDT-B-HRB
Hardness test block HRC60~70	HDT-B-HRC3
Hardness test block HRC20~30	HDT-B-HRC1
Hardness test block 78~88HR15N	HDT-B-HR15N2
Hardness test block 55~73HR30N	HDT-B-HR30N2
Hardness test block 73~82HR30T	HDT-B-HR30T
Small V-type anvil	ISH-SMALLANVIL
Desk	HDT-DESK



# MOTORIZED DIGITAL ROCKWELL/SUPERFICIAL ROCKWELL HARDNESS TESTERS

**POPULAR MODEL**

**INSPECTION CERTIFICATE**

FORCE LOADING BY ELECTRIC MOTOR (WITHOUT WEIGHTS)

TOUCH SCREEN

BUILT-IN BLUETOOTH



Ø58mm flat anvil (included)



Ø150mm flat anvil (included)



V-type anvil (included)



bluetooth printer (included)

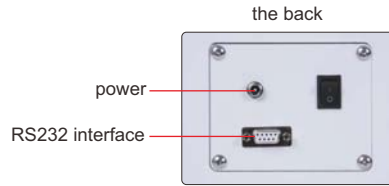
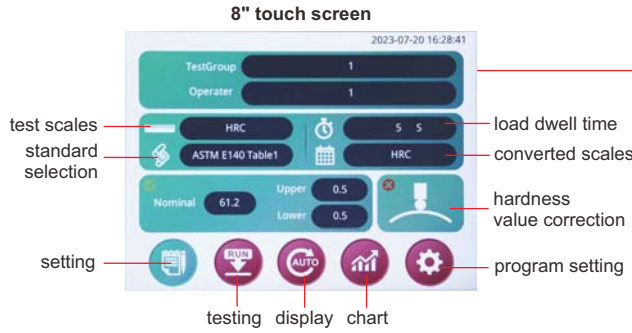

**HDT-RT151**

- Electronic loading test force, high accuracy of force value, and stable measurement value
- Touch screen operation and display, simple operation interface
- 15 types of Rockwell hardness scales can be tested
- Convertible to various hardness standards such as HB and HV
- 500 sets of storage
- With correction function, the hardness value can be corrected based on the size of the cylinders
- According to ISO 6508

test interface

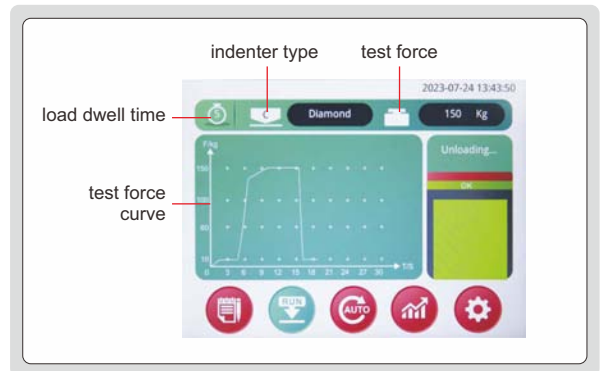

test result display interface

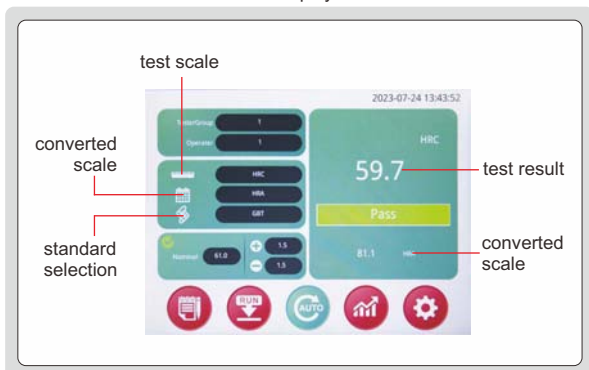
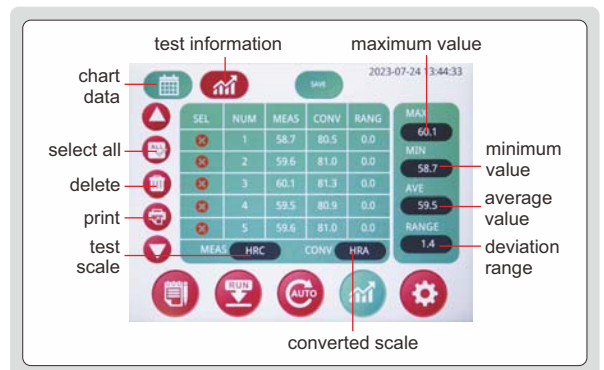

chart interface



To be continued

Continued from previous page

### SPECIFICATION

Code		HDT-RT151	HDT-RT152	HDT-RT153
Type		Rockwell	Superficial Rockwell	Rockwell and Superficial Rockwell
Measurement range		20~88HRA, 20~100HRB, 20~70HRC	70~91HR15N, 42~80HR30N, 42~70HR45N, 73~93HR15T, 43~82HR30T, 12~72HR45T	Rockwell: 20~88HRA, 20~100HRB, 20~70HRC; Superficial Rockwell: 70~91HR15N, 42~80HR30N, 42~70HR45N, 73~93HR15T, 43~82HR30T, 12~72HR45T
Hardness scale	with indenter included	HRA, HRB, HRC, HRD, HRF, HRG	HR15N, HR30N, HR45N, HR15T, HR30T, HR45T	HRA, HRB, HRC, HRD, HRF, HRG, HR15N, HR30N, HR45N, HR15T, HR30T, HR45T
	with optional indenter	HRE, HRH, HRK, HRL, HRM, HRP, HRR, HRS, HRV	HR15W, HR30W, HR45W, HR15X, HR30X, HR45X, HR15Y, HR30Y, HR45Y	HRE, HRH, HRK, HRL, HRM, HRP, HRR, HRS, HRV, HR15W, HR30W, HR45W, HR15X, HR30X, HR45X, HR15Y, HR30Y, HR45Y
Preliminary test force		98N/10kgf for Rockwell	29.4N/3kgf for Superficial Rockwell	98N/10kgf for Rockwell 29.4N/3kgf for Superficial Rockwell
Test force		588N (60kg), 980N (100kg), 1471N (150kg)	147N (15kg), 294N (30kg), 441N (45kg)	147N (15kg), 294N (30kg), 441N (45kg), 588N (60kg), 980N (100kg), 1471N (150kg)
Stage elevation		manual		
Load control		automatic (load/dwell/unload)		
Load dwell time		2~60 second		
Resolution		0.1HR		
Max. workpiece height		230mm		
Max. testing width		170mm		
Power supply		100~240V, 50/60Hz		
Dimension		475×200×700mm		
Weight		70kg		

### STANDARD DELIVERY

Code	HDT-RT151	HDT-RT152	HDT-RT153
Main unit	1 pc	1 pc	1 pc
Diamond indenter	1 pc	1 pc	1 pc
Ø1.5875mm carbide ball indenter	1 pc	1 pc	1 pc
Ø58mm flat anvil	1 pc	1 pc	1 pc
Ø150mm flat anvil	1 pc	1 pc	1 pc
V-type anvil	1 pc	1 pc	1 pc
Hardness test block HRC20~30	1 pc	—	1 pc
Hardness test block HRC40~50	1 pc	—	—
Hardness test block HRC60~70	1 pc	—	1 pc
Hardness test block HRB80~100	1 pc	—	1 pc
Hardness test block HRA80~90	1 pc	—	—
Hardness test block HR15N80~90	—	1 pc	—
Hardness test block HR30N60~85	—	1 pc	1 pc
Hardness test block HR30TW70~85	—	1 pc	1 pc
Bluetooth printer	1 pc	1 pc	1 pc
Anti-dust cover	1 pc	1 pc	1 pc

### OPTIONAL ACCESSORY

Hardness test block HRC20~30	HDT-B-HRC1
Hardness test block HRC60~70	HDT-B-HRC3
Hardness test block HRB80~100	HDT-B-HRB
Hardness test block HR15N78~88	HDT-B-HR15N2
Hardness test block HR30N55~73	HDT-B-HR30N2
Hardness test block HR30T73~82	HDT-B-HR30T

# MOTORIZED DIGITAL ROCKWELL HARDNESS TESTER CODE ISH-MRD200

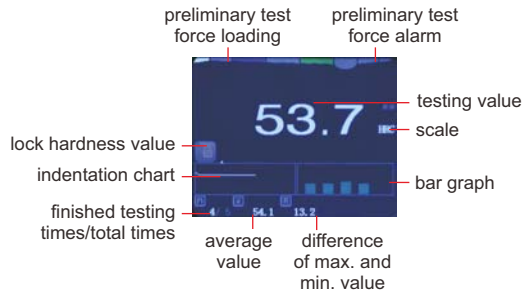

software flash disk (included)

- Tolerance testing
- Set testing times (2~10) to have average value and the difference of max. and min. value
- Convert to other Rockwell scales, HV or HB
- Memory of 500 testing values for browsing and output
- Testing value can be sent to wireless printer automatically
- Calibration function compensates the testing value for high accuracy
- The hardness value of soft materials like plastic is not stable, the lock function can obtain the value automatically
- Display unit is automatic power off
- According to ISO 6508
- Keyboard signal, can be transmitted to Excel



Ø60mm flat anvil (included)



Ø150mm flat anvil (included)



V-type anvil (included) for cylinders with diameter Ø4~60mm



small V-type anvil (optional) for cylinders with diameter Ø2~4mm



wireless printer (optional)



desk (optional)

## SPECIFICATION

Hardness scale	HRA, HRB, HRC, HRD HRF, HRG (with standard indenters) HRE, HRH, HRK (with optional indenter)
Preliminary test force	98N
Test force	588N, 980N, 1471N
Stage elevation	manual
Load control	automatic (load/dwell/unload)
Load dwell time	1~99 second
Resolution	0.1HR
Output	wireless and USB
Memory	500
Max. workpiece height	170mm
Max. testing width	165mm (from the center of indenter to the wall of main body)
Power supply of the display unit	built-in rechargeable battery
Power supply	220V, 50/60Hz
Dimension	520×160×700mm
Weight	60kg

## STANDARD DELIVERY

Main unit	1 pc
Ø60mm flat anvil	1 pc
Ø150mm flat anvil	1 pc
V-type anvil	1 pc
Diamond indenter	1 pc
Ø1.5875mm carbide ball indenter	1 pc
Hardness test block HRB88~95	1 pc
Hardness test block HRC60~65	1 pc
Hardness test block HRC20~30	1 pc
Anti-dust cover	1 pc
Software and USB cable	1 pc
AC/DC adapter	1 pc

## OPTIONAL ACCESSORY

Wireless printer	ISH-DS-PRINTER
Ø3.175mm carbide ball indenter	ISH-EHK-INDENTER
Hardness test block HRB88~100	HDT-B-HRB
Hardness test block HRC60~70	HDT-B-HRC3
Hardness test block HRC20~30	HDT-B-HRC1
Small V-type anvil	ISH-SMALLANVIL
Desk	HDT-DESK

# MANUAL DIGITAL ROCKWELL HARDNESS TESTER CODE ISH-RD200

DATA  
OUTPUT

INSPECTION  
CERTIFICATE

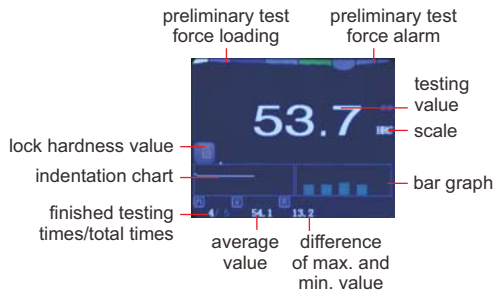

- Tolerance testing
- Set testing times (2~10) to have average value and the difference of max. and min. value
- Convert to other Rockwell scales, HV or HB
- Memory of 500 testing values for browsing and output
- Testing value can be sent to wireless printer automatically
- Calibration function compensates the testing value for high accuracy
- The hardness value of soft materials like plastic is not stable, the lock function can obtain the value automatically
- Automatic power off
- According to ISO 6508
- Keyboard signal, can be transmitted to Excel



software flash disk (included)



Ø60mm flat anvil (included)



Ø150mm flat anvil (included)



V-type anvil (included) for cylinders with diameter Ø4~60mm



small V-type anvil (optional) for cylinders with diameter Ø2~4mm



wireless printer (optional)



desk (optional)

## SPECIFICATION

<b>Hardness scale</b>	HRA, HRB, HRC, HRD HRF, HRG (with standard indenters) HRE, HRH, HRK (with optional indenter)
<b>Preliminary test force</b>	98N
<b>Test force</b>	588N, 980N, 1471N
<b>Stage elevation</b>	manual
<b>Load control</b>	manual
<b>Resolution</b>	0.1HR
<b>Output</b>	wireless and USB
<b>Memory</b>	500
<b>Max. workpiece height</b>	170mm
<b>Max. testing width</b>	165mm (from the center of indenter to the wall of main body)
<b>Power supply</b>	built-in rechargeable battery
<b>Dimension</b>	520×160×700mm
<b>Weight</b>	60kg

## STANDARD DELIVERY

<b>Main unit</b>	1 pc
<b>Ø60mm flat anvil</b>	1 pc
<b>Ø150mm flat anvil</b>	1 pc
<b>V-type anvil</b>	1 pc
<b>Diamond indenter</b>	1 pc
<b>Ø1.5875mm carbide ball indenter</b>	1 pc
<b>Hardness test block HRB88~95</b>	1 pc
<b>Hardness test block HRC60~65</b>	1 pc
<b>Hardness test block HRC20~30</b>	1 pc
<b>Anti-dust cover</b>	1 pc
<b>Software and USB cable</b>	1 pc
<b>AC/DC adapter</b>	1 pc

## OPTIONAL ACCESSORY

<b>Wireless printer</b>	ISH-DS-PRINTER
<b>Ø3.175mm carbide ball indenter</b>	ISH-EHK-INDENTER
<b>Hardness test block HRB88~100</b>	HDT-B-HRB
<b>Hardness test block HRC60~70</b>	HDT-B-HRC3
<b>Hardness test block HRC20~30</b>	HDT-B-HRC1
<b>Small V-type anvil</b>	ISH-SMALLANVIL
<b>Desk</b>	HDT-DESK

# MOTORIZED HIGH ROCKWELL HARDNESS TESTER CODE HDT-RM421



level (included)



V-type anvil (included)  
for cylinders with diameter Ø4~60mm



Ø150mm flat anvil (included)



Ø58mm flat anvil (included)



small V-type anvil (optional)  
for cylinders with diameter Ø2~4mm

■ According to ISO 6508

### SPECIFICATION

Hardness scale	HRA, HRB, HRC, HRD, HRF, HRG
Preliminary test force	98N (10kg)
Test force	588N (60kg), 980N (100kg), 1471N (150kg)
Display	analogue
Stage elevation	manual
Load control	automatic (load/dwell/unload)
Load dwell time	1~60 second
Min. reading	0.5HR
Max. workpiece height	400mm
Max. testing width	160mm (form the center of indenter to the wall of main body)
Power supply	220V, 50/60Hz
Dimension	540×300×1030mm
Weight	140kg

### STANDARD DELIVERY

Main unit	1 pc
Ø58mm flat anvil	1 pc
Ø150mm flat anvil	1 pc
V-type anvil	1 pc
Diamond indenter	1 pc
Ø1.5875mm steel ball indenter	1 pc
Ø1.5875mm steel ball	5 pcs
Level	1 pc
Hardness test block HRA80~84	1 pc
Hardness test block HRB88~100	1 pc
Hardness test block HRC20~30	1 pc
Hardness test block HRC35~55	1 pc
Hardness test block HRC60~70	1 pc
Anti-dust cover	1 pc

### OPTIONAL ACCESSORY

Hardness test block HRA80~84	HDT-B-HRA
Hardness test block HRB88~100	HDT-B-HRB
Hardness test block HRC20~30	HDT-B-HRC1
Hardness test block HRC35~55	HDT-B-HRC2
Hardness test block HRC60~70	HDT-B-HRC3
Small V-type anvil	HDT-RW160-SV

**MANUAL HIGH ROCKWELL HARDNESS TESTER  
CODE HDT-RH411**

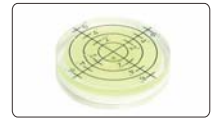

level (included)



V-type anvil (included)  
for cylinders with  
diameter Ø4-60mm



Ø150mm flat anvil  
(included)



Ø58mm flat anvil  
(included)



small V-type anvil  
(optional) for  
cylinders with  
diameter Ø2-4mm

■ According to ISO 6508

**SPECIFICATION**

<b>Hardness scale</b>	HRA, HRB, HRC, HRD, HRF, HRG
<b>Preliminary test force</b>	98N (10kg)
<b>Test force</b>	588N (60kg), 980N (100kg), 1471N (150kg)
<b>Display</b>	analogue
<b>Stage elevation</b>	manual
<b>Load control</b>	manual
<b>Min. reading</b>	0.5HR
<b>Max. workpiece height</b>	400mm
<b>Max. testing width</b>	160mm (form the center of indenter to the wall of main body)
<b>Dimension</b>	540×300×1030mm
<b>Weight</b>	140kg

**STANDARD DELIVERY**

<b>Main unit</b>	1 pc
<b>Ø58mm flat anvil</b>	1 pc
<b>Ø150mm flat anvil</b>	1 pc
<b>V-type anvil</b>	1 pc
<b>Diamond indenter</b>	1 pc
<b>Ø1.5875mm steel ball indenter</b>	1 pc
<b>Ø1.5875mm steel ball</b>	5 pcs
<b>Level</b>	1 pc
<b>Hardness test block HRA80~84</b>	1 pc
<b>Hardness test block HRB88~100</b>	1 pc
<b>Hardness test block HRC20~30</b>	1 pc
<b>Hardness test block HRC35~55</b>	1 pc
<b>Hardness test block HRC60~70</b>	1 pc
<b>Anti-dust cover</b>	1 pc

**OPTIONAL ACCESSORY**

<b>Hardness test block HRA80~84</b>	HDT-B-HRA
<b>Hardness test block HRB88~100</b>	HDT-B-HRB
<b>Hardness test block HRC20~30</b>	HDT-B-HRC1
<b>Hardness test block HRC35~55</b>	HDT-B-HRC2
<b>Hardness test block HRC60~70</b>	HDT-B-HRC3
<b>Small V-type anvil</b>	HDT-RW160-SV

# MOTORIZED ROCKWELL HARDNESS TESTER CODE ISH-MR150

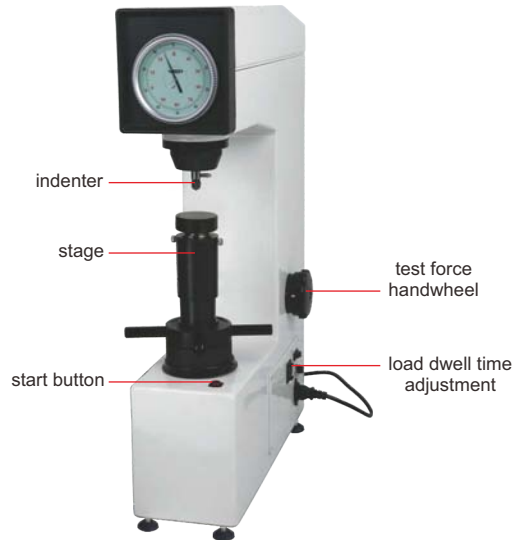

■ According to ISO 6508



Ø60mm flat anvil  
(included)



Ø150mm flat anvil  
(included)



V-type anvil (included)  
for cylinders with  
diameter Ø4~60mm



small V-type anvil  
(optional)  
for cylinders with  
diameter Ø2~4mm



desk (optional)

## SPECIFICATION

Hardness scale	HRA, HRB, HRC, HRD, HRF, HRG
Preliminary test force	98N
Test force	588N, 980N, 1471N
Display	analogue
Stage elevation	manual
Load control	automatic (load/dwell/unload)
Load dwell time	1~99 second
Min. reading	0.5HR
Max. workpiece height	170mm
Max. testing width	165mm (from the center of indenter to the wall of main body)
Power supply	220V, 50/60Hz
Dimension	520×160×700mm
Weight	60kg

## STANDARD DELIVERY

Main unit	1 pc
Ø60mm flat anvil	1 pc
Ø150mm flat anvil	1 pc
V-type anvil	1 pc
Diamond indenter	1 pc
Ø1.5875mm carbide ball indenter	1 pc
Hardness test block HRB88~95	1 pc
Hardness test block HRC60~65	1 pc
Hardness test block HRC20~30	1 pc
Anti-dust cover	1 pc

## OPTIONAL ACCESSORY

Hardness test block HRB88~100	HDT-B-HRB
Hardness test block HRC60~70	HDT-B-HRC3
Hardness test block HRC20~30	HDT-B-HRC1
Small V-type anvil	ISH-SMALLANVIL
Desk	HDT-DESK

**MOTORIZED ROCKWELL HARDNESS TESTER (BASIC TYPE)  
CODE HDT-RA151**



32

■ According to ISO 6508



Ø58mm flat anvil (included)



Ø150mm flat anvil (included)



V-type anvil (included) for cylinders with diameter Ø4~60mm



level (included)



small V-type anvil (optional) for cylinders with diameter Ø2~4mm



desk (optional)

**SPECIFICATION**

Hardness scale	HRA, HRB, HRC, HRD, HRF, HRG
Preliminary test force	98N
Test force	588N, 980N, 1471N
Display	analogue
Stage elevation	manual
Load control	automatic (load/dwell/unload)
Load dwell time	1~60 second
Min. reading	0.5HR
Max. workpiece height	170mm
Max. testing width	128mm (from the center of indenter to the wall of main body)
Power supply	220V, 50/60Hz
Dimension	500×225×640mm
Weight	65kg

**STANDARD DELIVERY**

Main unit	1 pc
Ø58mm flat anvil	1 pc
Ø150mm flat anvil	1 pc
V-type anvil	1 pc
Diamond indenter	1 pc
Ø1.5875mm steel ball indenter	1 pc
Level	1 pc
Hardness test block HRA80~88	1 pc
Hardness test block HRB85~95	1 pc
Hardness test block HRC20~30	1 pc
Hardness test block HRC35~55	1 pc
Hardness test block HRC60~70	1 pc
Anti-dust cover	1 pc

**OPTIONAL ACCESSORY**

Hardness test block HRA80~84	HDT-B-HRA
Hardness test block HRB88~100	HDT-B-HRB
Hardness test block HRC20~30	HDT-B-HRC1
Hardness test block HRC35~55	HDT-B-HRC2
Hardness test block HRC60~70	HDT-B-HRC3
Small V-type anvil	HDT-RW160-SV
Desk	HDT-DESK



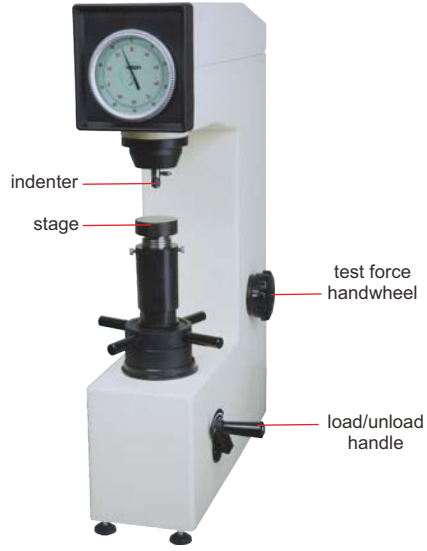

▪ According to ISO 6508



Ø60mm flat anvil (included)



Ø150mm flat anvil (included)



V-type anvil (included) for cylinders with diameter Ø4~60mm



small V-type anvil (optional) for cylinders with diameter Ø2~4mm



desk (optional)

**SPECIFICATION**

Hardness scale	HRA, HRB, HRC, HRD, HRF, HRG
Preliminary test force	98N
Test force	588N, 980N, 1471N
Display	analogue
Stage elevation	manual
Load control	manual
Min. reading	0.5HR
Max. workpiece height	170mm
Max. testing width	165mm (from the center of indenter to the wall of main body)
Dimension	520×160×700mm
Weight	60kg

**STANDARD DELIVERY**

Main unit	1 pc
Ø60mm flat anvil	1 pc
Ø150mm flat anvil	1 pc
V-type anvil	1 pc
Diamond indenter	1 pc
Ø1.5875mm carbide ball indenter	1 pc
Hardness test block HRB88~95	1 pc
Hardness test block HRC60~65	1 pc
Hardness test block HRC20~30	1 pc
Anti-dust cover	1 pc

**OPTIONAL ACCESSORY**

Hardness test block HRB88~100	HDT-B-HRB
Hardness test block HRC60~70	HDT-B-HRC3
Hardness test block HRC20~30	HDT-B-HRC1
Small V-type anvil	ISH-SMALLANVIL
Desk	HDT-DESK

# MANUAL ROCKWELL HARDNESS TESTER (BASIC TYPE) CODE HDT-RW160



POPULAR MODEL

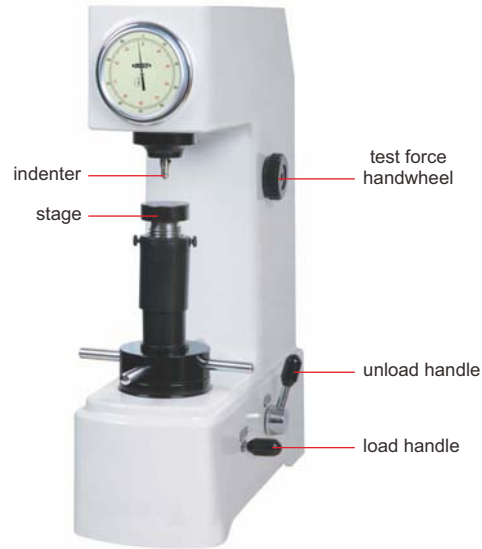

■ According to ISO 6508



Ø58mm flat anvil (included)



Ø150mm flat anvil (included)



V-type anvil (included) for cylinders with diameter Ø4~60mm

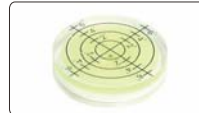

level (included)



small V-type anvil (optional) for cylinders with diameter Ø2~4mm



desk (optional)

## SPECIFICATION

Hardness scale	HRA, HRB, HRC, HRD, HRF, HRG
Preliminary test force	98N (10kg)
Test force	588N (60kg), 980N (100kg), 1471N (150kg)
Display	analogue
Stage elevation	manual
Load control	manual
Min. reading	0.5HR
Max. workpiece height	170mm
Max. testing width	135mm (from the center of indenter to the wall of main body)
Dimension	466×238×630mm
Weight	70kg

## STANDARD DELIVERY

Main unit	1 pc
Ø58mm flat anvil	1 pc
Ø150mm flat anvil	1 pc
V-type anvil	1 pc
Diamond indenter	1 pc
Ø1.5875mm steel ball indenter	1 pc
Ø1.5875mm steel ball	5 pcs
Level	1 pc
Hardness test block HRA80~88	1 pc
Hardness test block HRB85~95	1 pc
Hardness test block HRC20~30	1 pc
Hardness test block HRC35~55	1 pc
Hardness test block HRC60~70	1 pc
Anti-dust cover	1 pc

## OPTIONAL ACCESSORY

Hardness test block HRA80~84	HDT-B-HRA
Hardness test block HRB88~100	HDT-B-HRB
Hardness test block HRC20~30	HDT-B-HRC1
Hardness test block HRC35~55	HDT-B-HRC2
Hardness test block HRC60~70	HDT-B-HRC3
Small V-type anvil	HDT-RW160-SV
Desk	HDT-DESK

# MANUAL ROCKWELL AND SUPERFICIAL ROCKWELL HARDNESS TESTER CODE HDT-RSR100

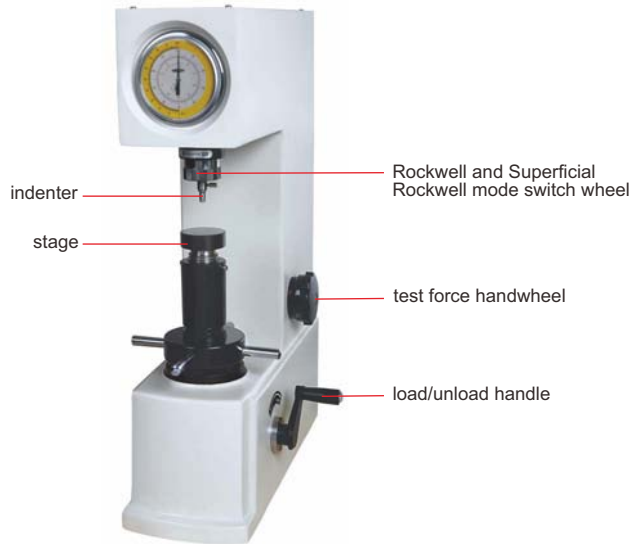

Ø60mm flat anvil (included)



Ø150mm flat anvil (included)



V-type anvil (included) for cylinders with diameter Ø4-60mm



small V-type anvil (optional) for cylinders with diameter Ø2-4mm



desk (optional)

■ According to ISO 6508

## SPECIFICATION

Hardness scale	HRA, HRB, HRC, HRD, HRF, HRG, HR15N, HR30N, HR45N, HR15T, HR30T, HR45T
Preliminary test force	29.4N/3kgf for Superficial Rockwell 98N/10kgf for Rockwell
Test force	147N/15kgf, 294N/30kgf, 441N/45kgf, 588N/60kgf, 980N/100kgf, 1471N/150kgf
Display	analogue
Stage elevation	manual
Load control	manual
Min. reading	0.5HR
Max. workpiece height	160mm
Max. testing width	140mm (from the center of indenter to the wall of main body)
Dimension	460×240×660mm
Weight	75kg

## STANDARD DELIVERY

Main unit	1 pc
Ø60mm flat anvil	1 pc
Ø150mm flat anvil	1 pc
V-type anvil	1 pc
Diamond indenter	1 pc
Ø1.5875mm carbide ball indenter	1 pc
Hardness test block HRB88-95	1 pc
Hardness test block HRC60-65	1 pc
Hardness test block HRC20-30	1 pc
Hardness test block HR15N	1 pc
Hardness test block HR30N	1 pc
Hardness test block HR30T	1 pc
Anti-dust cover	1 pc

## OPTIONAL ACCESSORY

Hardness test block HRB88~100	HDT-B-HRB
Hardness test block HRC60~70	HDT-B-HRC3
Hardness test block HRC20~30	HDT-B-HRC1
Hardness test block 78~88HR15N	HDT-B-HR15N2
Hardness test block 55~73HR30N	HDT-B-HR30N2
Hardness test block 57~69HR30T	HDT-B-HR30T
Small V-type anvil	ISH-SMALLANVIL
Desk	HDT-DESK

## DIGITAL MICRO-VICKERS HARDNESS TESTER (BASIC TYPE) CODE HDT-MVE1300

MOTOR DRIVEN  
TURRET

TOUCH  
SCREEN

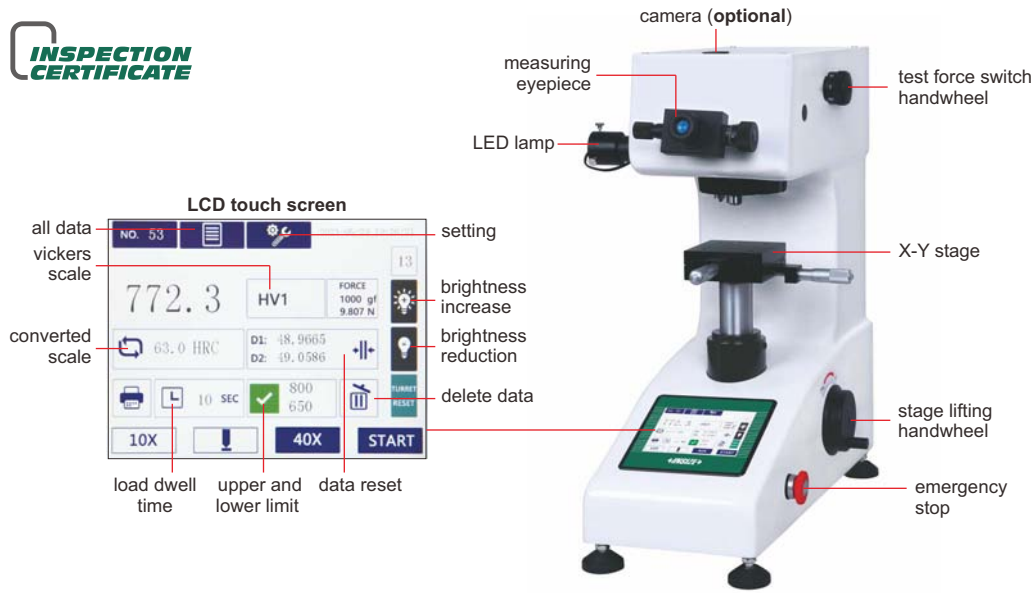

step: 1



measure indentation diagonal lengths by measuring microscope

step: 2



input the indentation diagonal lengths, the hardness value is shown on screen automatically

- Touch screen color LCD display
- Data storage and average value calculation
- Automatic switch between the indenter and objective lens
- According to ISO 6507



cylinder holder (included)



slice holder (included)



vice (included)



desk (optional)



camera (optional)

camera and measuring system (optional)



### SPECIFICATION

<b>Test force</b>	0.098N (10gf), 0.245N (25gf), 0.49N (50gf), 0.98N (100gf), 1.96N (200gf), 2.94N (300gf), 4.9N (500gf), 9.8N (1kgf)
<b>Vickers scales</b>	HV0.01, HV0.025, HV0.05, HV0.1, HV0.2, HV0.3, HV0.5, HV1
<b>Converted scales</b>	HRA, HRB, HRC, HRD, HRF, HV, HK, HBW, HR15N, HR30N, HR45N, HR15T, HR30T, HR45T
<b>Range</b>	5~3000HV
<b>Length measurement resolution</b>	0.5µm
<b>Objective/indenter switch</b>	motor driven turret
<b>Stage lifting</b>	manual
<b>Load control</b>	automatic (load/dwell/unload)
<b>Load dwell time</b>	1~60 second
<b>Objective</b>	10X, 40X
<b>Eyepiece</b>	10X
<b>Total magnification</b>	100X (for measurement or observation), 400X (for measurement)
<b>Max. workpiece height</b>	90mm
<b>Max. testing width</b>	95mm (from the center of indenter to the wall of main body)
<b>X-Y stage</b>	dimension: 100×100mm, travel range: 25×25mm
<b>Power supply</b>	220V, 50/60Hz
<b>Dimension</b>	510×290×570mm
<b>Weight</b>	40kg



### STANDARD DELIVERY

<b>Main unit</b>	1 pc
<b>10X, 40X objective</b>	1 pc of each
<b>Micro vickers indenter</b>	1 pc
<b>Hardness test block 400~500HV0.2</b>	1 pc
<b>Hardness test block 700~750HV1</b>	1 pc
<b>Slice holder</b>	1 pc
<b>Vice</b>	1 pc
<b>Cylinder holder</b>	1 pc
<b>Anti-dust cover</b>	1 pc

### OPTIONAL ACCESSORY

<b>Hardness test block 400~500HV0.2</b>	HDT-B-HV02C
<b>Hardness test block 700~750HV1</b>	HDT-B-HV1F
<b>Camera</b>	HDT-MVH-CM
<b>Measuring system (manual)</b>	HDT-MVH-SW
<b>Measuring system (automatic)</b>	HDT-MVH-AW
<b>Desk</b>	HDT-DESK



# DIGITAL MICRO-VICKERS HARDNESS TESTER (STANDARD TYPE) CODE HDT-MVH1100

PRESS INPUT BUTTON TO HAVE DIRECT READING OF HARDNESS

TOUCH SCREEN

MOTOR DRIVEN TURRET

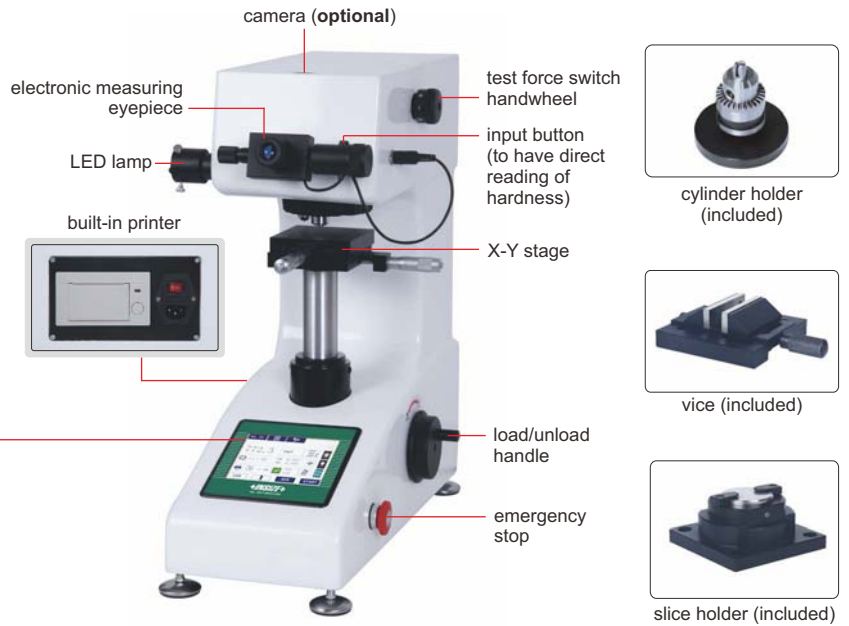
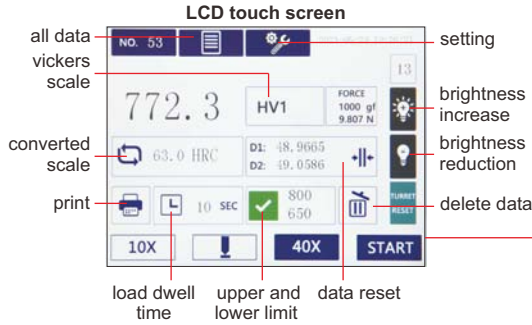

- Touch screen color LCD display
- Data storage and average value calculation
- Automatic switch between the indenter and objective lens
- According to ISO 6507



camera and measuring system (optional)



## SPECIFICATION

Test force	0.098N (10gf), 0.245N (25gf), 0.49N (50gf), 0.98N (100gf), 1.96N (200gf), 2.94N (300gf), 4.9N (500gf), 9.8N (1kgf)
Vickers scales	HV0.01, HV0.025, HV0.05, HV0.1, HV0.2, HV0.3, HV0.5, HV1
Converted scales	HRA, HRB, HRC, HRD, HRF, HV, HK, HBW, HR15N, HR30N, HR45N, HR15T, HR30T, HR45T
Range	5~3000HV
Length measurement resolution	0.025µm
Objective/indenter switch	motor driven turret
Stage lifting	manual
Load control	automatic (load/dwell/unload)
Load dwell time	1~60 second
Objective	10X, 40X
Eyepiece	10X
Total magnification	10X (for measurement or observation), 400X (for measurement)
Max. workpiece height	90mm
Max. testing width	95mm (from the center of indenter to the wall of main body)
X-Y stage	dimension: 100×100mm, travel range: 25×25mm
Data output	built-in printer
Power supply	220V, 50/60Hz
Dimension	510×290×570mm
Weight	40kg

## STANDARD DELIVERY

Main unit	1 pc
10X, 40X objective	1 pc of each
Micro vickers indenter	1 pc
Hardness test block 400~500HV0.2	1 pc
Hardness test block 700~750HV1	1 pc
Slice holder	1 pc
Vice	1 pc
Cylinder holder	1 pc
Anti-dust cover	1 pc

## OPTIONAL ACCESSORY

Hardness test block 400~500HV0.2	HDT-B-HV02C
Hardness test block 700~750HV1	HDT-B-HV1F
Camera	HDT-MVH-CM
Measuring system (manual)	HDT-MVH-SW
Measuring system (automatic)	HDT-MVH-AW

**DUAL TOUCH SCREEN DIGITAL MICRO-VICKERS HARDNESS TESTER (ADVANCED TYPE) CODE HDT-DMV90**



MOTOR DRIVEN TURRET

AUTOMATIC MEASUREMENT



32

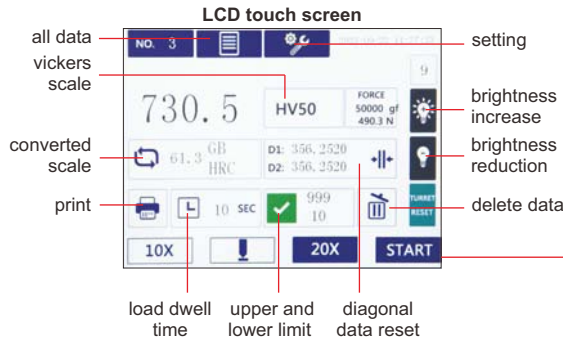
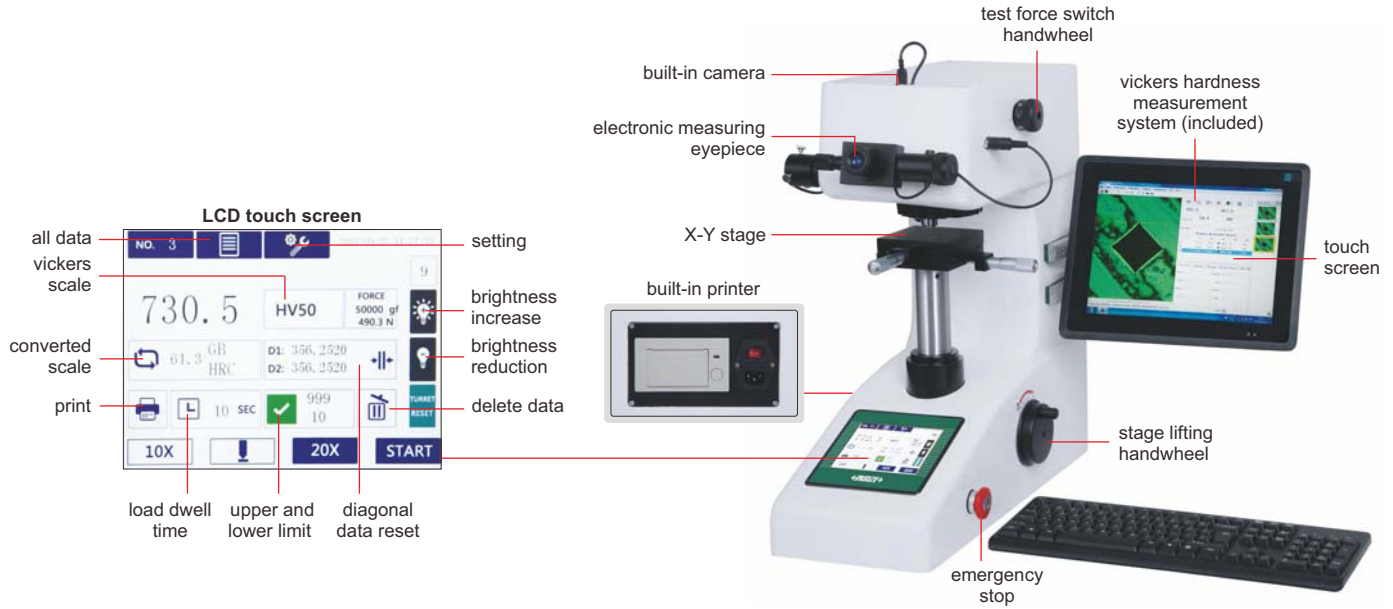

vickers hardness measurement system (included)

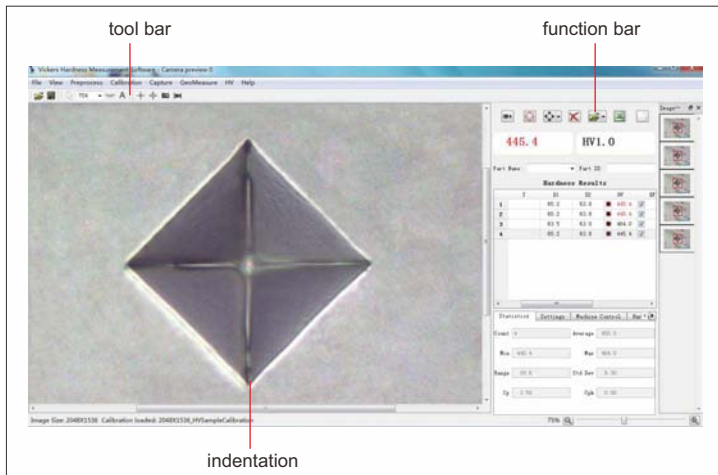

- Dual touch screen control, high-definition image measurement and analysis
- One click start, automatic pressing and automatic measurement
- The host and vickers hardness measurement system can be operated independently
- Automatic switch between the indenter and objective lens
- Data storage and average value calculation
- Can connect with wired and wireless networks to transmit data
- According to ISO 6507

To be continued



Continued from previous page

**SPECIFICATION**

<b>Test force</b>	0.098N (10gf), 0.245N (25gf), 0.49N (50gf), 0.98N (100gf), 1.96N (200gf), 2.94N (300gf), 4.9N (500gf), 9.8N (1kgf)
<b>Vickers scales</b>	HV0.01, HV0.025, HV0.05, HV0.1, HV0.2, HV0.3, HV0.5, HV1
<b>Converted scales</b>	HRA, HRB, HRC, HRD, HRF, HV, HK, HBW, HR15N, HR30N, HR45N, HR15T, HR30T, HR45T
<b>Range</b>	5~3000HV
<b>Length measurement resolution</b>	0.01µm
<b>Objective/indenter switch</b>	motor driven turret
<b>Stage lifting</b>	manual
<b>Load control</b>	automatic (load/dwell/unload)
<b>Load dwell time</b>	1~60 second
<b>Objective</b>	10X, 40X
<b>Eyepiece</b>	10X
<b>Total magnification</b>	100X (for measurement or observation), 400X (for measurement)
<b>Max. workpiece height</b>	90mm
<b>Max. testing width</b>	95mm (from the center of indenter to the wall of main body)
<b>X-Y stage</b>	dimensions: 100×100mm, travel range: 25×25mm
<b>Data output</b>	built-in printer, USB
<b>Power supply</b>	220V, 50/60HZ
<b>Dimension</b>	500×420×480mm
<b>Weight</b>	42kg

**STANDARD DELIVERY**

<b>Main unit</b>	1 pc
<b>Vickers hardness measurement system</b>	1 pc
<b>10X, 40X objective</b>	1 pc of each
<b>Micro vickers indenter</b>	1 pc
<b>Hardness test block 400~500HV0.2</b>	1 pc
<b>Hardness test block 700~750HV1</b>	1 pc
<b>Wireless keyboard</b>	1 pc
<b>Wireless mouse</b>	1 pc
<b>Vice</b>	1 pc
<b>Slice holder</b>	1 pc
<b>Cylinder holder</b>	1 pc
<b>Anti-dust cover</b>	1 pc

**OPTIONAL ACCESSORY**

<b>Hardness test block 400~500HV0.2</b>	HDT-B-HV02C
<b>Hardness test block 700~750HV1</b>	HDT-B-HV1F
<b>Desk</b>	HDT-DESK
<b>OFFICE software</b>	7313-OFFICE

**AUTOMATIC MICRO-VICKERS HARDNESS TESTER  
CODE HDT-AMV338**

MOTOR DRIVEN  
TURRET

AUTOMATIC  
MEASUREMENT

Z-AXIS  
AUTOFOCUS

INSPECTION  
CERTIFICATE

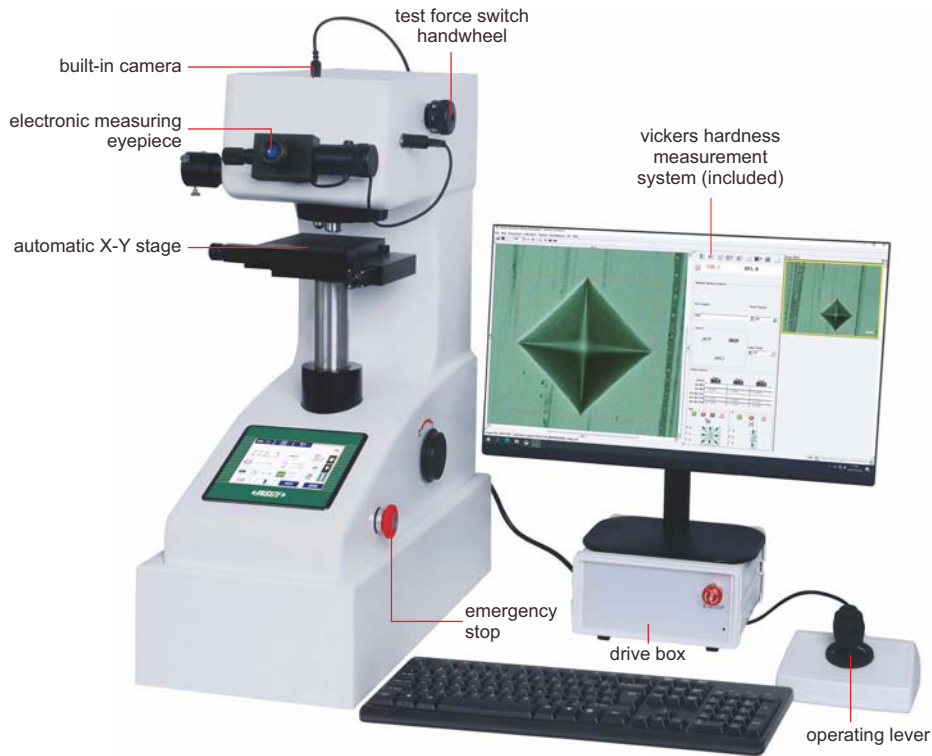

automatic X-Y stage



cylinder holder (included)



vice (included)



slice holder (included)



desk (optional)

- Suitable for micro-hardness determination of various metals and non-metal materials, effective depth and heat affected area measurement, especially suitable for measuring workpieces hardness gradient distribution curve and surface hardness after heat treatment, effective hardening layer depth
- Automatic switch between the indenter and objective lens
- Z-axis automatic focus, X, Y axis automatic movement, can be for multi-point continuous measurement
- Automatic moving table by built-in step motor, high positioning accuracy, good repeatability, fast moving speed, high efficiency
- Automatic moving table bidirectional movement, equipped with safety devices to avoid misoperation
- The software can control the hardness tester hardware operation, two-way communication with each other
- The image acquisition device has fast reaction speed, high automatic measurement accuracy and good repeatability
- The system can automatically generate Word or Excel test report, and the report template can be modified
- According to ISO 6507

vickers hardness measurement system (included)

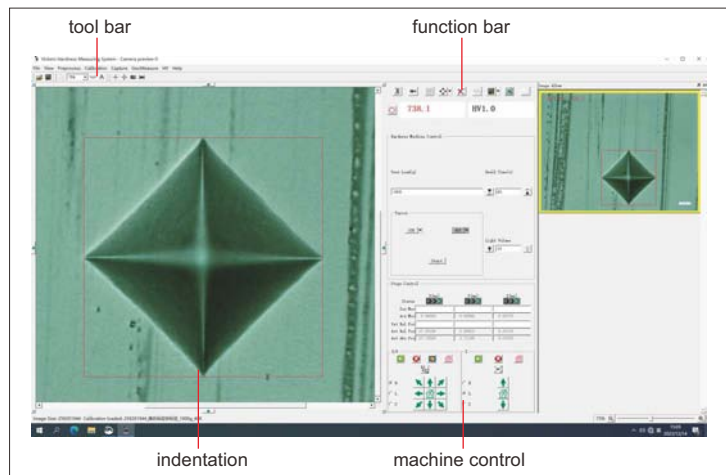

To be continued





Continued from previous page

#### AUTOMATIC MEASUREMENT, CONTROL SYSTEM

<b>Hardness tester control</b>	1. automatic turret, automatic loading, automatic measurement 2. automatic display of test force, load dwell time, illumination brightness
<b>Control automatic X-Y stage</b>	software system controls automatic X-Y stage movement
<b>Measurement mode</b>	1. automatic mode: automatic loading, automatic measurement, automatic display of measurement results 2. manual measurement mode can be selected
<b>Automatic measurement</b>	about 0.3sec of one indentation
<b>Measurement repeatability</b>	±1% (700HV/500gf)
<b>The smallest indentation that can be measured</b>	about 5µm (automatic measurement)
<b>Data output format/edit functions</b>	1. inspection reports can be customized according to customer requirements 2. the depth of hardened layer is shown in table form 3. output various measurement data, hardness table, hardening layer depth, maximum value, average value, minimum value, image with hardness value

#### AUTOMATIC X-Y STAGE

<b>Drive motor</b>	step motor
<b>Drive control</b>	movement control by software, speed is adjustable
<b>Dimension</b>	110×110mm
<b>Maximum travel distance</b>	50×50mm
<b>Minimum travel distance</b>	1µm
<b>Movement speed</b>	1~10mm/sec, speed can be adjusted
<b>Displacement repetition accuracy</b>	within 1µm

#### SPECIFICATION

<b>Test force</b>	0.098N (10gf), 0.245N (25gf), 0.49N (50gf), 0.98N (100gf), 1.96N (200gf), 2.94N (300gf), 4.9N (500gf), 9.8N (1kgf)
<b>Vickers scales</b>	HV0.01, HV0.025, HV0.05, HV0.1, HV0.2, HV0.3, HV0.5, HV1
<b>Converted scales</b>	HRA, HRB, HRC, HRD, HRF, HV, HK, HBW, HR15N, HR30N, HR45N, HR15T, HR30T, HR45T
<b>Range</b>	5~3000HV
<b>Length measurement resolution</b>	0.01µm
<b>Objective/indenter switch</b>	motor driven turret
<b>Stage lifting</b>	manual
<b>Focus mode</b>	Z-axis autofocus
<b>Load control</b>	automatic (load/dwell/unload)
<b>Load dwell time</b>	1~60 second
<b>Objective</b>	10X, 40X
<b>Eyepiece</b>	10X
<b>Total magnification</b>	100X (for measurement or observation), 400X (for measurement)
<b>Max. workpiece height</b>	80mm
<b>Max. testing width</b>	110mm (from the center of indenter to the wall of main body)
<b>Pixel</b>	5M
<b>Communication interface</b>	RS232
<b>Power supply</b>	220V, 50/60HZ
<b>Dimension</b>	520×290×680mm
<b>Weight</b>	42kg

#### STANDARD DELIVERY

<b>Main unit</b>	1 pc
<b>10X, 40X objective</b>	1 pc of each
<b>Micro vickers indenter</b>	1 pc
<b>Hardness test block 400~500HV0.2</b>	1 pc
<b>Hardness test block 700~750HV1</b>	1 pc
<b>Automatic X-Y stage drive box</b>	1 pc
<b>Vickers hardness measurement system</b>	1 pc
<b>Computer</b>	1 pc
<b>Vice</b>	1 pc
<b>Slice holder</b>	1 pc
<b>Cylinder holder</b>	1 pc
<b>Anti-dust cover</b>	1 pc

#### OPTIONAL ACCESSORY

<b>Hardness test block 400~500HV0.2</b>	HDT-B-HV02C
<b>Hardness test block 700~750HV1</b>	HDT-B-HV1F
<b>Desk</b>	HDT-DESK
<b>OFFICE software</b>	7313-OFFICE

DIGITAL VICKERS HARDNESS TESTERS (BASIC TYPE)



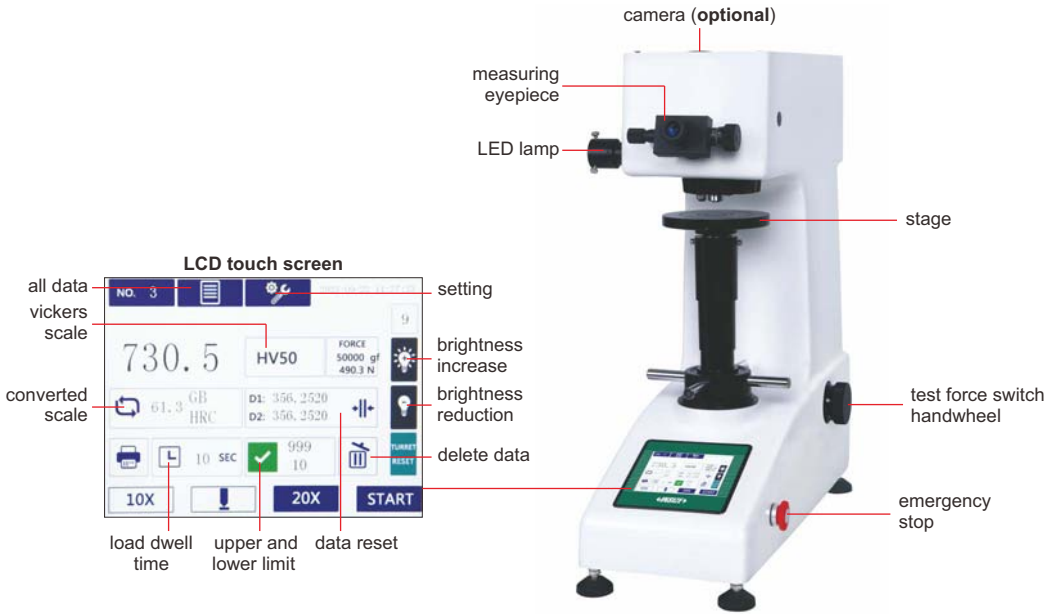

MOTOR DRIVEN TURRET

TOUCH SCREEN



HDT-VE56

<p>step: 1</p>  <p>measure indentation diagonal lengths by measuring microscope</p>	<p>step: 2</p>  <p>input the indentation diagonal lengths, the hardness value is shown on screen automatically</p>
---	---

- Touch screen color LCD display
- Data storage and average value calculation
- Automatic switch between the indenter and objective lens
- According to ISO 6507



Ø58mm flat anvil (included)



Ø150mm flat anvil (included)



V-type anvil (included)



desk (optional)



camera (optional)

camera and measuring system (optional)

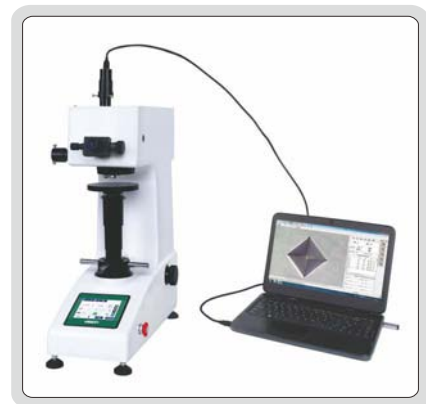

To be continued

Continued from previous page

vickers hardness measurement system (optional)

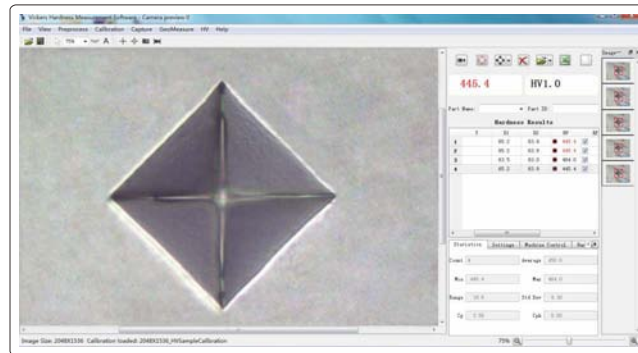

### SPECIFICATION

Code	HDT-VE03	HDT-VE14	HDT-VE35	HDT-VE56
Test force	0.3kgf, 0.5kgf, 1kgf, 2kgf, 3kgf, 5kgf	0.3kgf, 0.5kgf, 1kgf, 3kgf, 5kgf, 10kgf	1kgf, 3kgf, 5kgf, 10kgf, 20kgf, 30kgf	1kgf, 5kgf, 10kgf, 20kgf, 30kgf, 50kgf
Vickers scales	HV0.3, HV0.5, HV1, HV2, HV3, HV5	HV0.3, HV0.5, HV1, HV3, HV5, HV10	HV1, HV3, HV5, HV10, HV20, HV30	HV1, HV5, HV10, HV20, HV30, HV50
Converted scales	HRA, HRB, HRC, HRD, HRF, HV, HK, HBW, HR15N, HR30N, HR45N, HR15T, HR30T, HR45T			
Range	8~3000HV			
Length measurement resolution	0.5μm			
Objective/indenter switch	motor driven turret			
Stage lifting	manual			
Load control	automatic (load/dwell/unload)			
Load dwell time	1~60 second			
Objective	10X, 20X			
Eyepiece	10X			
Total magnification	100X (for measurement or observation), 200X (for measurement)			
Max. workpiece height	175mm			
Max. testing width	135mm (form the center of indenter to the wall of main body)			
Power supply	220V, 50/60HZ			
Dimension	580×320×660mm			
Weight	55kg			

### STANDARD DELIVERY

Main unit	1 pc
10X, 20X objective	1 pc of each
Vickers indenter	1 pc
Hardness test block 400~500HV10	1 pc
Hardness test block 700~750HV50	1 pc
Ø58mm flat anvil	1 pc
Ø150mm flat anvil	1 pc
V-type anvil	1 pc
Anti-dust cover	1 pc

### OPTIONAL ACCESSORY

Hardness test block 400~500HV10	HDT-B-HV10D
Hardness test block 700~750HV50	HDT-B-HV50G
Desk	HDT-DESK
Vickers hardness tester camera	HDT-MVH-CM1
Measuring system (manual)	HDT-MVH-SW
Measuring system (automatic)	HDT-MVH-AW

# DIGITAL VICKERS HARDNESS TESTERS (STANDARD TYPE)



MOTOR DRIVEN  
TURRET

PRESS INPUT BUTTON TO HAVE  
DIRECT READING OF HARDNESS

TOUCH  
SCREEN



32

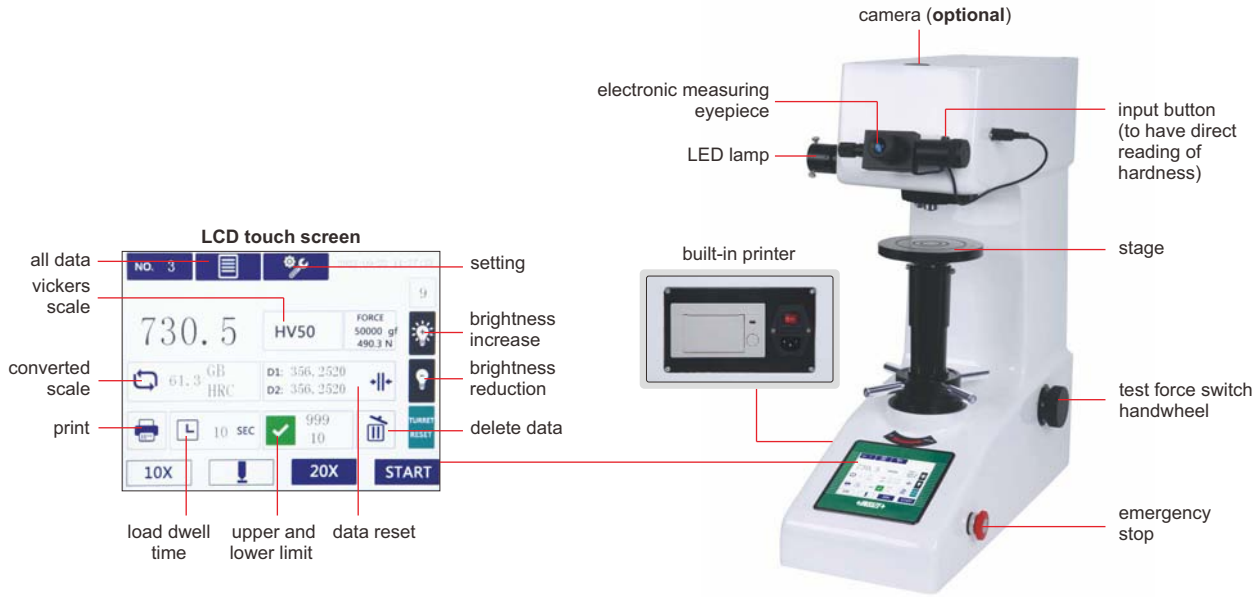

HDT-VH51

- Touch screen color LCD display
- Data storage and average value calculation
- Automatic switch between the indenter and objective lens
- According to ISO 6507



Ø58mm flat anvil (included)



Ø150mm flat anvil (included)



V-type anvil (included)



desk (optional)



camera (optional)

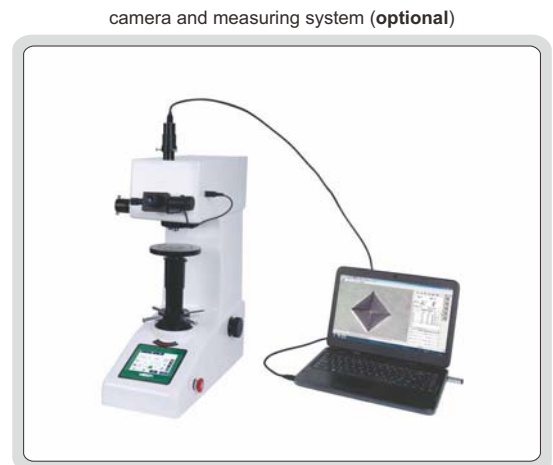

To be continued

Continued from previous page

vickers hardness measurement system (optional)

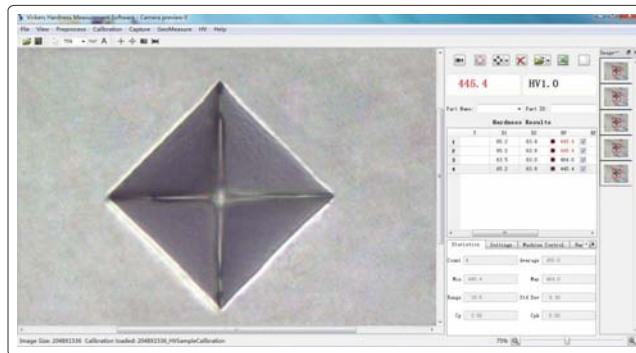

### SPECIFICATION

Code	HDT-VH05	HDT-VH11	HDT-VH31	HDT-VH51
Test force	0.3kgf, 0.5kgf, 1kgf, 2kgf, 3kgf, 5kgf	0.3kgf, 0.5kgf, 1kgf, 3kgf, 5kgf, 10kgf	1kgf, 3kgf, 5kgf, 10kgf, 20kgf, 30kgf	1kgf, 5kgf, 10kgf, 20kgf, 30kgf, 50kgf
Vickers scales	HV0.3, HV0.5, HV1, HV2, HV3, HV5	HV0.3, HV0.5, HV1, HV3, HV5, HV10	Hv1, HV3, HV5, HV10, HV20, Hv30	Hv1, HV5, HV10, HV20, HV30, Hv50
Converted scales	HRA, HRB, HRC, HRD, HRF, HV, HK, HBW, HR15N, HR30N, HR45N, HR15T, HR30T, HR45T			
Range	8~3000HV			
Length measurement resolution	0.125μm			
Objective/indenter switch	motor driven turret			
Stage lifting	manual			
Load control	automatic (load/dwell/unload)			
Load dwell time	1~60 second			
Objective	10X, 20X			
Eyepiece	10X			
Total magnification	100X (for measurement or observation), 200X (for measurement)			
Max. workpiece height	175mm			
Max. testing width	135mm (form the center of indenter to the wall of main body)			
Output	built-in printer			
Power supply	220V, 50/60HZ			
Dimension	580×320×660mm			
Weight	55kg			

### STANDARD DELIVERY

Main unit	1 pc
10X, 20X objective	1 pc of each
Vickers indenter	1 pc
Hardness test block	2 pcs
Ø58mm flat anvil	1 pc
Ø150mm flat anvil	1 pc
V-type anvil	1 pc
Anti-dust cover	1 pc

### OPTIONAL ACCESSORY

Hardness test block	page 840~841
Desk	HDT-DESK
Vickers hardness tester camera	HDT-MVH-CM1
Measuring system (manual)	HDT-MVH-SW
Measuring system (automatic)	HDT-MVH-AW

## MOTORIZED DIGITAL BRINELL HARDNESS TESTER (BASIC TYPE) CODE HDT-MBE320



TOUCH SCREEN

FORCE LOADING BY ELECTRIC MOTOR (WITHOUT WEIGHT)

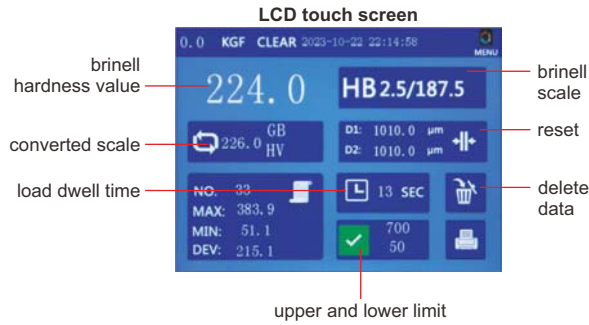

**step: 1**

measure indentation diameter by measuring microscope

**step: 2**

input the diameters, the hardness value is shown on screen automatically

- Touch screen color LCD display
- Measure indentation diameter by measuring microscope, then input the diameters, the hardness value is shown on screen automatically
- Electric loading test force, without weights
- Casting case, structurally stable and not deformed
- According to ISO 6506



### SPECIFICATION

Test force	62.5kgf, 100kgf, 125kgf, 187.5kgf, 250kgf, 500kgf, 750kgf, 1000kgf, 1500kgf, 3000kgf	
Brinell scale	HBW2.5/62.5, HBW2.5/187.5, HBW5/62.5, HBW5/125, HBW5/250, HBW5/750, HBW10/100, HBW10/250, HBW10/500, HBW10/1000, HBW10/1500, HBW10/3000	
Range	8~650HBW	
Hardness resolution	0.1HBW	
Stage elevation	manual	
Load control	automatic (load/dwell/unload)	
Load dwell time	0~60 second	
Measuring microscope	magnification	20X
	resolution	0.01mm
Max. workpiece height	230mm	
Max. testing width	140mm (form the center of indenter to the wall of main body)	
Power supply	220V, 50/60Hz	
Dimension	510×210×750mm	
Weight	130kg	

### STANDARD DELIVERY

Main unit	1 pc
Ø78mm flat anvil	1 pc
Ø200mm flat anvil	1 pc
V-type anvil	1 pc
Ø2.5mm carbide ball indenter	1 pc
Ø5mm carbide ball indenter	1 pc
Ø10mm carbide ball indenter	1 pc
Hardness test block 100~200HBW2.5/187.5	1 pc
Hardness test block 90~200HBW10/1000	1 pc
Hardness test block 100~200HBW10/3000	1 pc
Measuring microscope	1 pc

### OPTIONAL ACCESSORY

Hardness test block 100~200HBW2.5/187.5	HDT-B-HB25A1
Hardness test block 90~200HBW10/1000	HDT-B-HB10C1
Hardness test block 100~200HBW10/3000	HDT-B-HB10A1
Desk	HDT-DESK

TOUCH SCREEN

FORCE LOADING BY ELECTRIC MOTOR (WITHUOT WEIGHT)

## MOTORIZED DIGITAL BRINELL HARDNESS TESTERS (STANDARD TYPE)

**INSPECTION CERTIFICATE**

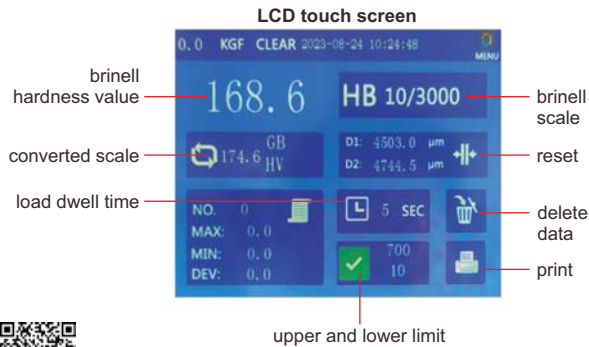

- Touch screen color LCD display
- Measure the indentation with microscope, automatically calculate the hardness value and display it on the screen
- Electric loading test force, without weights
- Casting case, structurally stable and not deformed
- According to ISO 6506



Ø78mm flat anvil (included)



Ø200mm flat anvil (included)



V-type anvil (included)



desk (optional)

32

### SPECIFICATION

Code	HDT-MB610	HDT-MB710
Turret rotation	manual	automatic
Test force	62.5kgf, 100kgf, 125kgf, 187.5kgf, 250kgf, 500kgf, 750kgf, 1000kgf, 1500kgf, 3000kgf	
Brinell scale	HBW2.5/62.5, HBW2.5/187.5, HBW5/125, HBW5/750, HBW10/100, HBW10/250, HBW10/500, HBW10/1000, HBW10/1500, HBW10/3000	
Range	8~650HBW	
Hardness resolution	0.1HBW	
Stage elevation	manual	
Load control	automatic (load/dwell/unload)	
Load dwell time	0~60 second	
Measuring microscope	magnification	20X
	resolution	0.1µm
Max. workpiece height	200mm	
Max. testing width	135mm (form the center of indenter to the wall of main body)	
Data output	built-in printer, RS232	
Power supply	220V, 50/60Hz	
Dimension	510×210×750mm	
Weight	130kg	

### STANDARD DELIVERY

Main unit	1 pc
Ø78mm flat anvil	1 pc
Ø200mm flat anvil	1 pc
V-type anvil	1 pc
Ø2.5mm carbide ball indenter	1 pc
Ø5mm carbide ball indenter	1 pc
Ø10mm carbide ball indenter	1 pc
Hardness test block 100~200HBW2.5/187.5	1 pc
Hardness test block 90~200HBW10/1000	1 pc
Hardness test block 100~200HBW10/3000	1 pc

### OPTIONAL ACCESSORY

Hardness test block 100~200HBW2.5/187.5	HDT-B-HB25A1
Hardness test block 90~200HBW10/1000	HDT-B-HB10C1
Hardness test block 100~200HBW10/3000	HDT-B-HB10A1
Desk	HDT-DESK

# BRINELL INDENTATION MEASURING SYSTEM CODE ISHB-MSA



application



software flash disk  
(included)

software (included)

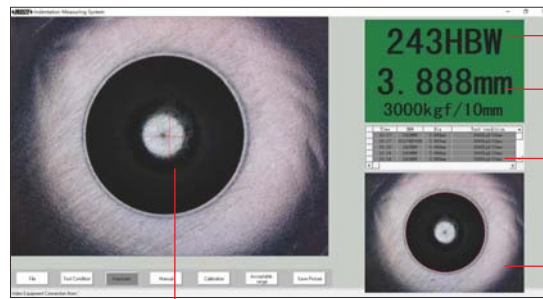

- result and scale
- diameter of indentation
- result list
- picture

- Connected to computer USB port
- Automatically measure the indentation
- Result saved to Excel automatically
- Tolerance testing
- Calibration with standard hardness blocks or standard indentation blocks

indentation

## SPECIFICATION

Applicable Brinell indenter	Ø10mm, Ø7.26mm, Ø5mm, Ø4mm, Ø2.5mm	
Hardness range	16~650HB	
Range of indentation diameter	Ø0.6~6mm	
Test force	62.5, 100, 125, 187.5, 250, 500, 750, 1000, 1500, 3000kgf	
Hardness resolution	1HB	
Diameter measuring resolution	0.001mm	
Diameter measuring accuracy	Ø10mm ball indenter	±0.4% (indentation diameter)
	Ø5mm ball indenter	±0.8% (indentation diameter)
	Ø2.5mm ball indenter	±1.2% (indentation diameter)
Camera	sensor	1/3.2" CMOS
	pixel	2M (resolution 1600×1200)
	view filed	8×6mm
Dimension	170×54×54mm	
Weight	385g	



standard blocks for Ø5mm and Ø10mm indenters (included)

## STANDARD DELIVERY

Main unit	1 pc
Software	1 pc
Ø5mm standard indentation block	1 pc
Ø10mm standard indentation block	1 pc

## OPTIONAL ACCESSORY

Ø2.5mm standard indentation block	ISHB-MSA-BLOCK25
-----------------------------------	------------------



# BRINELL/ROCKWELL/VICKERS HARDNESS TESTER CODE ISH-BRV



Ø60mm flat anvil for Rockwell (included)



Ø150mm flat anvil for Rockwell (included)



Ø60mm flat anvil for Vickers and Brinell (included)



V-type anvil for Rockwell (included), for cylinders with diameter Ø4~60mm



V-type anvil for Vickers and Brinell (included)



small V-type anvil for Rockwell (optional), for cylinders with diameter Ø2~4mm



desk (optional)



VIDEO



- According to ISO 6506, ISO 6507, ISO 6508

## SPECIFICATION

Rockwell test load	98N preload, 588, 980, 1471N total load
Min. Rockwell reading	0.5HR
Brinell test load	306, 613, 1839N
Vickers test load	294N
Stage elevation	manual
Load control	manual
Magnification of microscope	37.5X/75X
Max. workpiece height	180mm
Max. testing width	200mm (from the center of indenter to the wall of main body)
Power supply	220V, 50/60Hz
Dimension	546×300×767mm
Weight	90kg

## STANDARD DELIVERY

Main unit	1 pc
Ø1.5875mm carbide ball indenter	1 pc
Diamond Rockwell indenter	1 pc
Ø5mm Brinell indenter	1 pc
Ø2.5mm Brinell indenter	1 pc
Vickers indenter	1 pc
Ø60mm flat anvil for Rockwell	1 pc
Ø150mm flat anvil for Rockwell	1 pc
V-type anvil for Rockwell	1 pc
Ø60mm flat anvil for Vickers and Brinell	1 pc
V-type anvil for Vickers and Brinell	1 pc
Hardness test block HRB88~95	1 pc
Hardness test block HRC60~65	1 pc
Hardness test block HRC20~30	1 pc
Hardness test block 400~500HV30	1 pc
Hardness test block 180~300HBW2.5/187.5	1 pc
Anti-dust cover	1 pc

## OPTIONAL ACCESSORY

Hardness test block HRB88~100	HDT-B-HRB
Hardness test block HRC60~70	HDT-B-HRC3
Hardness test block HRC20~30	HDT-B-HRC1
Hardness test block 400-500HV30	HDT-B-HV30D
Hardness test block 200-3000HBW2.5/187.5	HDT-B-HB25A2
Small V-type anvil for Rockwell	ISH-SMALLANVIL
Desk	HDT-DESK

## BALANCING BRACKET CODE ISH-BL01



- Suitable for hardness measurement of long strip specimens
- By adjusting the counterweight, to ensure that the indenter is perpendicular to the specimen

### SPECIFICATION

Sample diameter	<50mm
Test bench type	V-type anvil
Dimension	600×100×100mm
Weight	5kg

application example



## JACK LIFTING BRACKET CODE ISH-ST02



- No need to hold the sample, fixing the sample can reduce measurement error

### SPECIFICATION

Sample diameter	<50mm
Test bench type	V-type anvil
Adjusting the height	200mm (customizable)
Dimension	250×250×400mm
Weight	11kg

application example





## PORTABLE LEEB HARDNESS TESTER APPLICABLE MATERIAL AND HARDNESS RANGE OF IMPACT DEVICE D

Material	HLD	HV	HB	HRC	HRB	HS	Tensile strength (MPa)
Steel & cast steel	300-900	81-955	81-654	20-68	38-100	32-100	375-2639
Tool steel	300-840	80-898		20-67			
Stainless steel	300-800	85-802	85-655		46-101		
Cast iron	360-650		93-334				
Cast aluminum alloy	170-570		19-164		23-84		
Brass	200-550		40-173		13-95		
Bronze	300-700		60-290				
Copper	200-690		45-315				

BLUETOOTH

DATA  
OUTPUT

## PORTABLE LEEB HARDNESS TESTERS

32

**INSPECTION  
CERTIFICATE**



**HDT-CB320**  
(wired probe is included)



**HDT-WL320**  
(wireless probe is included)

- Can use wired probes or wireless probes
- Dual-coil probe for high accuracy
- Universal testing angle, no need to set impact direction
- Based on Leeb (HLD), converted to Vickers (HV), Brinell (HB), Rockwell (HRC, HRA and HRB), Shore (HS) and tensile strength (σb)
- Dual value display, shows both Leeb and converted hardness
- Large 2.4" LCD display with backlight
- With a magnet on the back, the main unit can be attached on steel surfaces
- According to ASTM A956 and DIN 50156



hardness test  
block D (included)



small support ring  
(included)

connect to PC, upload the data to PC, print and send to Excel (software is included)



connect to  
bluetooth printer (optional)



To be continued

Continued from previous page

### SPECIFICATION

<b>Code</b>	<b>HDT-CB320</b>	<b>HDT-WL320</b>		
<b>Probe included</b>	wired probe D	wireless probe D		
<b>Optional probes</b>	wired (DC/C/D/D+15/DL/E/G), wireless (DC/C/D/DL/G)			
<b>Resolution</b>	1HLD/1HV/1HB/0.1HRC/0.1HRB/0.1HRA/0.1HS/1MPa			
<b>Accuracy</b>	±6HLD (when HLD=800)			
<b>Output</b>	USB			
<b>Measuring range</b>	HL 170-960/HRC 1.3-74.7/HRB 1.2-139.7/HB 28-1027/HV 45-1221 HS 4.0-112.1/HRA 1.3-88.5/MPa 118-3315N/mm <sup>2</sup>			
<b>Applicable materials</b>	1. steel/cast steel 5. nodular cast iron 9. copper	2. alloy steel 6. cast aluminum 10. forging steel	3. stainless steel 7. brass 11. rolling steel	4. gray pig iron 8. bronze
<b>Statistics</b>	average/max./min./s.value			
<b>Memory</b>	999 data			
<b>Working environment</b>	-10°C~45°C			
<b>Power supply</b>	2xAA battery			
<b>Dimension</b>	145×68×28mm			
<b>Weight</b>	158g			

### STANDARD DELIVERY

<b>Code</b>	<b>HDT-CB320</b>	<b>HDT-WL320</b>
<b>Main unit</b>	1 pc	1 pc
<b>Wired probe D</b>	1 pc	—
<b>Wireless probe D</b>	—	1 pc
<b>Hardness test block D</b>	1 pc	1 pc
<b>Small support ring</b>	1 pc	1 pc
<b>Cleaning brush</b>	1 pc	1 pc

### OPTIONAL ACCESSORY

<b>Wired probe</b>	<b>DC</b>	<b>HDT-CB320-DC</b>
	<b>C</b>	<b>HDT-CB320-C</b>
	<b>D</b>	<b>HDT-CB320-D</b>
	<b>D+15</b>	<b>HDT-CB320-D15</b>
	<b>DL</b>	<b>HDT-CB320-DL</b>
	<b>E</b>	<b>HDT-CB320-E</b>
	<b>G</b>	<b>HDT-CB320-G</b>
<b>Wireless probe</b>	<b>DC</b>	<b>HDT-WL320-DCW</b>
	<b>C</b>	<b>HDT-WL320-CW</b>
	<b>D</b>	<b>HDT-WL320-DW</b>
	<b>DL</b>	<b>HDT-WL320-DLW</b>
	<b>G</b>	<b>HDT-WL320-GW</b>
<b>Hardness test block D**</b>		<b>HDT-B-HLD3</b>
<b>Hardness test block G*</b>		<b>HDT-B-HLG2</b>
<b>Printer</b>		<b>ISH-LP200-PRINTER</b>
<b>Support rings</b>		page 829

\* Hardness test block G (HDT-B-HLG2) is for probe G (HDT-CB320-G or HDT-WL320-GW)  
\*\* Hardness test block D (HDT-B-HLD3) is for all other probes

wired probes (optional)

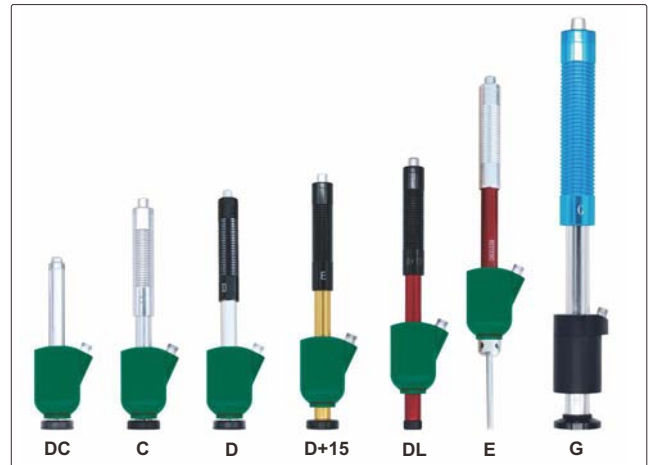

wireless probes (optional)

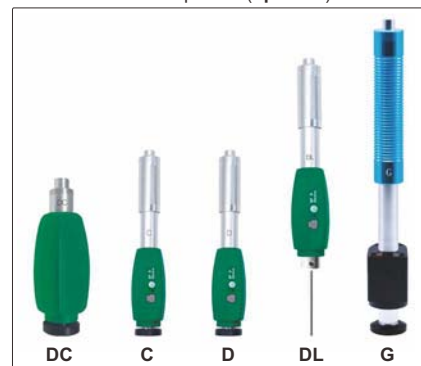

### APPLICABLE WORKPIECE

<b>Probes</b>	<b>DC</b>	<b>C</b>	<b>D</b>	<b>D+15</b>	<b>DL</b>	<b>E</b>	<b>G</b>
<b>Application</b>	inner wall of small space	small or thin workpiece, coating layer	general use	deep groove	narrow slot or small hole	very hard material	casting or forging workpiece
<b>Maximum roughness of workpiece (Ra)</b>	2µm	0.4µm	2µm	2µm	2µm	2µm	7µm
<b>Minimum weight of workpiece</b>	<b>direct measurement</b>	5kg	1.5kg	5kg	5kg	5kg	15kg
	<b>on solid support</b>	2.5kg	0.5kg	2kg	2kg	2kg	5kg
	<b>coupled on plate</b>	0.05-2kg	0.02kg	0.05-2kg	0.1kg	0.1kg	0.5kg
<b>Minimum thickness of workpiece</b>	3mm	1mm	3mm	3mm	3mm	3mm	10mm



## PORTABLE LEEB HARDNESS TESTER CODE ISH-PHB



32

- Based on Leeb (HLD), converted to Vickers (HV), Brinell (HB), Rockwell (HRC and HRB), Shore (HS) and tensile strength (MPa)
- Memory of 99 measurement values for browsing
- Set measurement times (1~9) to have average value
- Connected with printer via bluetooth
- Automatic power off, according to ASTM A 956



hardness test block D (included)



small support ring (included)



wireless printer (optional)

### SPECIFICATION

<b>Min. reading</b>	1HLD, 1HV, 1HB, 0.1HRC, 0.1HRB, 1HS, 1MPa	
<b>Accuracy</b>	±6HLD (when HLD=800)	
<b>Display</b>	Leeb (HLD), converted hardness, material, impact direction, test times, average value, date	
<b>Output</b>	bluetooth	
<b>Applicable workpiece</b>	minimum weight	5kg
		2kg (on solid support)
		0.1kg (coupled on plate)
	minimum thickness: 5mm	
	minimum radius of curved surface: 30mm	
	maximum roughness (Ra): 1.6µm	
<b>Power supply</b>	3×AAA batteries	
<b>Dimension</b>	150×84×28mm	
<b>Weight</b>	200g	

### STANDARD DELIVERY

<b>Main unit</b>	1 pc
<b>Impact device D</b>	1 pc
<b>Hardness test block D</b>	1 pc
<b>Small support ring</b>	1 pc
<b>Cleaning brush</b>	1 pc

### OPTIONAL ACCESSORY

<b>Wireless printer</b>	ISH-DS-PRINTER
<b>Couplant</b>	ISH-COUPPLANT
<b>Support rings</b>	page 829
<b>Hardness test block D</b>	HDT-B-HLD3

# PORTABLE LEEB HARDNESS TESTER (BUILT-IN BLUETOOTH) CODE ISH-PHB-B

BUILT-IN BLUETOOTH

DATA  
OUTPUT

INSPECTION  
CERTIFICATE

- Based on Leeb (HLD), converted to Vickers (HV), Brinell (HB), Rockwell (HRC and HRB), Shore (HS) and tensile strength (MPa)
- Memory of 99 measurement values for browsing
- Set measurement times (1~9) to have average value
- Connected with printer via wireless module
- Automatic power off
- According to ASTM A 956
- Wired data transmission (keyboard signal):  
USB cable connect to computer, press transmission button to send data
- Wireless data transmission (keyboard signal):  
built-in Bluetooth module connect to computer or mobile phone, press transmission button to send data



transmission button



hardness test block D (included)



small support ring (included)



wireless printer (optional)



VIDEO

32

## SPECIFICATION

<b>Min. reading</b>	1HLD, 1HV, 1HB, 0.1HRC, 0.1HRB, 1HS, 1MPa	
<b>Accuracy</b>	±6HLD (when HLD=800)	
<b>Display</b>	Leeb (HLD), converted hardness, material, impact direction, test times, average value, date	
<b>Output</b>	bluetooth, USB	
<b>Applicable workpiece</b>	minimum weight	5kg
		2kg (on solid support)
		0.1kg (coupled on plate)
	minimum thickness: 5mm	
minimum radius of curved surface: 30mm		
maximum roughness (Ra): 1.6µm		
<b>Power supply</b>	3×AAA batteries	
<b>Dimension</b>	150×84×28mm	
<b>Weight</b>	200g	

## STANDARD DELIVERY

<b>Main unit</b>	1 pc
<b>Impact device D</b>	1 pc
<b>Hardness test block D</b>	1 pc
<b>USB cable</b>	1 pc
<b>Small support ring</b>	1 pc
<b>Cleaning brush</b>	1 pc

## OPTIONAL ACCESSORY

<b>Wireless printer</b>	ISH-DS-PRINTER
<b>Couplant</b>	ISH-COUPPLANT
<b>Support rings</b>	page 829
<b>Hardness test block D</b>	HDT-B-HLD3

connected to computer by USB cable,  
upload the data in real time



connected to computer by bluetooth module,  
upload the data in real time





DATA  
OUTPUT

INSPECTION  
CERTIFICATE

## PORTABLE LEEB HARDNESS TESTER CODE ISH-SPHA

- Based on Leeb (HL), converted to Vickers (HV), Brinell (HB), Rockwell (HRC and HRB), Shore (HS) and tensile strength (MPa)
- Connected with printer via bluetooth
- Connected with computer via USB port
- Up to 800 test results can be saved
- Tolerance testing
- Touch screen operation, large display with backlight
- Language: English, Chinese, Italian, German, French and Portuguese
- Automatic power off
- According to ASTM A 956



software flash disk  
(included)



hardness test  
block D (included)



small support ring  
(included)



printer (included)

### SPECIFICATION

Min. reading	1HL, 1HV, 1HB, 0.1HRC, 0.1HRB, 1HS, 1MPa
Accuracy	±6HL (when HL=800)
Display	Leeb (HL), converted hardness, material, impact direction, test times, average value, deviation, time
Output	bluetooth and USB
Power supply	built-in rechargeable battery
Dimension	135×83×24mm
Weight	350g

### STANDARD DELIVERY

Main unit	1 pc
Impact device D	1 pc
Printer	1 pc
Hardness test block D	1 pc
Small support ring	1 pc
Cleaning brush	1 pc
AC/DC adapter	1 pc
Software flash disk and USB cable	1 pc
Pen for touch screen	1 pc

### OPTIONAL ACCESSORY

Impact device DC	ISH-SPHA-DC
Impact device C	ISH-SPHA-C
Impact device D+15	ISH-SPHA-D15
Impact device DL	ISH-SPHA-DL
Impact device G	ISH-SPHA-G
Hardness test block D*	HDT-B-HLD3
Hardness test block G*	HDT-B-HLG2
Couplant	ISH-COUPPLANT
Support rings	page 829

\* Hardness test block G (HDT-B-HLG2) is for impact device G (ISH-SPHA-G).  
Hardness test block D (HDT-B-HLD3) is for all other impact devices.

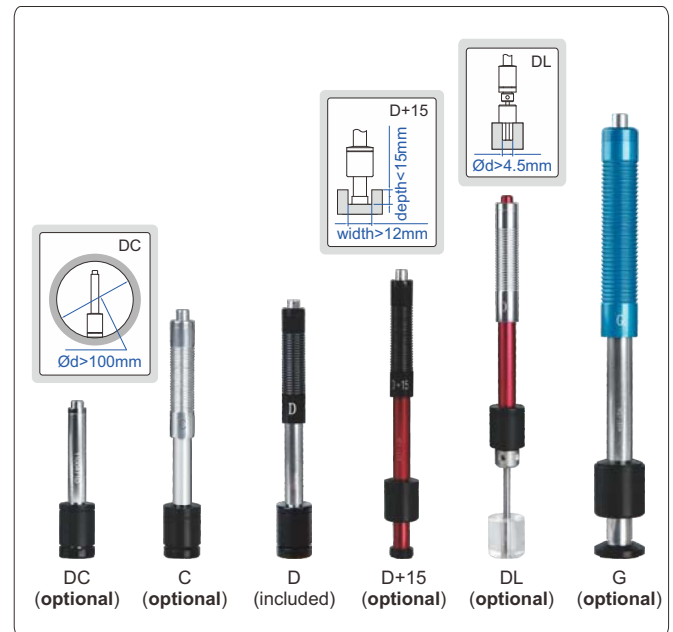

### APPLICABLE WORKPIECE

Impact device	DC	C	D	D+15	DL	G
Application	inner wall of small space	small or thin workpiece, coating layer	general use	deep groove	narrow slot or small hole	casting or forging workpiece
Maximum roughness of workpiece (Ra)	1.6µm	0.4µm	1.6µm	1.6µm	1.6µm	7µm
Minimum weight of workpiece	direct measurement	5kg	1.5kg	5kg	5kg	15kg
	on solid support	2kg	0.5kg	2kg	2kg	5kg
	coupled on plate	0.1kg	0.02kg	0.1kg	0.1kg	0.5kg
Minimum thickness of workpiece	5mm	1mm	5mm	5mm	5mm	10mm

## PORTABLE LEEB HARDNESS TESTERS (BASIC TYPE)

INSPECTION  
CERTIFICATE

POPULAR  
MODEL

- Can change probes
- Dual-coil probe for high accuracy
- Universal testing angle, no need to set impact direction
- Based on Leeb (HLD), converted to Vickers (HV), Brinell (HB), Rockwell (HRC, HRB), Shore (HSD) and tensile strength ( $\sigma$ )
- Dual value display, shows both Leeb and converted hardness
- Large LCD display with backlight
- Can choose large font display and statistics display
- Automatically calculate maximum, minimum and average value
- Save 300 data
- Operation temperature:  $-10^{\circ}\text{C}\sim 45^{\circ}\text{C}$
- According to ASTM A956, GB/T 17394



HDT-LP200



hardness test block D (included)



small support ring (included)



bluetooth printer (included in HDT-LP200B)

### SPECIFICATION

Code	HDT-LP200	HDT-LP200B
Printer	not included	included
Resolution	1HLD/1HV/1HB/0.1HRC/0.1HRB/0.1HSD/1 $\sigma$	
Accuracy	$\pm 6$ HLD (when HLD=800)	
Measuring range	HL 170-960/HRC 17-70/HRB 13-109/ HB 20-655/HV 80-940/HSD 32-99.5/ $\sigma$ ( $\text{rm}$ ) 255-2639N/ $\text{mm}^2$	
Power supply	2xAAA battery	
Dimension	135x77x32mm	
Weight	240g	

### STANDARD DELIVERY

Main unit	1 pc
Hardness test block D	1 pc
Small support ring	1 pc
Cleaning brush	1 pc
Impact device D	1 pc
Bluetooth printer (included in HDT-LP200B)	1 pc

### OPTIONAL ACCESSORY

Impact device DC	HDT-LP200-DC
Impact device C	HDT-LP200-C
Impact device D+15	HDT-LP200-D15
Impact device DL	HDT-LP200-DL
Impact device G	HDT-LP200-G
Hardness test block D**	HDT-B-HLD3
Hardness test block G*	HDT-B-HLG2
Support rings	page 829

\* Hardness test block G (HDT-B-HLG2) is for impact device G (HDT-LP200-G)

\*\* Hardness test block D (HDT-B-HLD3) is for all other impact devices



large font display

statistics display

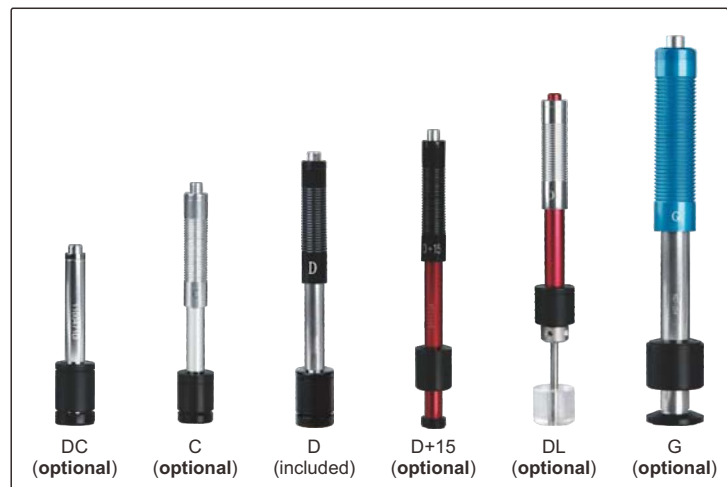

DC (optional) C (optional) D (included) D+15 (optional) DL (optional) G (optional)

### APPLICABLE WORKPIECE

Impact device	DC	C	D	D+15	DL	G
Application	inner wall of small space	small or thin workpiece, coating layer	general use	deep groove	narrow slot or small hole	casting or forging workpiece
Maximum roughness of workpiece (Ra)	2 $\mu\text{m}$	0.4 $\mu\text{m}$	2 $\mu\text{m}$	2 $\mu\text{m}$	2 $\mu\text{m}$	7 $\mu\text{m}$
Minimum weight of workpiece	direct measurement	5kg	1.5kg	5kg	5kg	15kg
	on solid support	2kg	0.5kg	2kg	2kg	5kg
	coupled on plate	0.05kg	0.02kg	0.05kg	0.1kg	0.05kg
Minimum thickness of workpiece	3mm	1mm	3mm	3mm	3mm	10mm





## PORTABLE LEEB HARDNESS TESTER (WITH WIRELESS PROBE) CODE HDT-WP201

- Bluetooth digital probe
- Universal testing angle, no need to set impact direction
- Based on Leeb (HLD), converted to Vickers (HV), Brinell (HB), Rockwell (HRC, HRB), Shore (HSD) and tensile strength ( $\sigma$ )
- Dual value display, shows both Leeb and converted hardness
- Large LCD display with backlight
- Can choose large font display and statistics display
- Automatically calculate maximum, minimum and average value
- Save 300 data
- Operation temperature:  $-10^{\circ}\text{C}\sim 45^{\circ}\text{C}$
- According to ASTM A956, DIN 50156 GB/T 17394



hardness test block D (included)



small support ring (included)



bluetooth printer (optional)

### SPECIFICATION

Resolution	1HLD/1HV/1HB/0.1HRC/0.1HRB/0.1HSD/1 $\sigma$
Accuracy	$\pm 6\text{HLD}$ (when HLD=800)
Measuring range	HL 170-960/HRC 17-69/HRB 13-101.7/ HB 20-655/HV 80-940/HSD 32-99.5/ $\sigma$ (rm) 255-2180N/mm <sup>2</sup>
Power supply	2xAA battery
Dimension	135 $\times$ 77 $\times$ 32mm
Weight	240g



large font display

statistics display

### STANDARD DELIVERY

Main unit	1 pc
Hardness test block D	1 pc
Small support ring	1 pc
Cleaning brush	1 pc
Impact device D	1 pc

### OPTIONAL ACCESSORY

Impact device DC	HDT-WL320-DCW
Impact device C	HDT-WL320-CW
Impact device DL	HDT-WL320-DLW
Impact device G	HDT-WL320-GW
Hardness test block D	HDT-B-HLD3
Bluetooth printer	ISH-LP200-PRINTER
Support rings	page 829

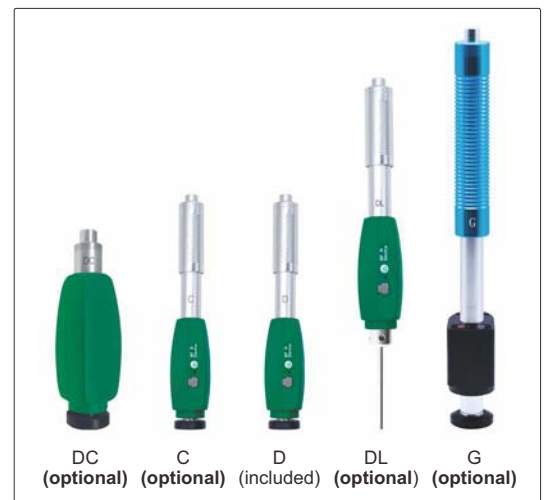

DC (optional) C (optional) D (included) DL (optional) G (optional)

### APPLICABLE WORKPIECE

Impact device	DC	C	D	DL	G
Application	inner wall of small space	small or thin workpiece, coating layer	general use	narrow slot or small hole	casting or forging workpiece
Maximum roughness of workpiece (Ra)	2 $\mu\text{m}$	0.4 $\mu\text{m}$	2 $\mu\text{m}$	2 $\mu\text{m}$	7 $\mu\text{m}$
Minimum weight of workpiece	direct measurement	5kg	1.5kg	5kg	15kg
	on solid support	2kg	0.5kg	2kg	5kg
	coupled on plate	0.05kg	0.02kg	0.05kg	0.05kg
Minimum thickness of workpiece	3mm	1mm	3mm	3mm	10mm

## PEN-TYPE LEEB HARDNESS TESTER (ADVANCED TYPE) CODE HDT-L410

DATA  
OUTPUT

HIGH  
ACCURACY

DL PROBE IS  
OPTIONAL



software flash disk (included)



hardness test block D (included)



wireless printer (optional)



small support ring (included)

- Metal housing
- HD TFT 320×320 display
- Impact device D
- Based on Leeb (HLD), converted to Vickers (HV), Brinell (HB), Rockwell (HRC, HRA and HRB), Shore (HS) and tensile strength (SGM)
- Four display modes
- Automatic direction correction
- Tolerance testing
- Automatic power off, automatic calculation of statistics
- Dual value display, shows both Leeb and other conversion values
- 31 files can be saved, each containing 100 measurement data
- Connected to PC software via USB or Bluetooth 2.0
- Connected with printer via Bluetooth
- Operation temperature: -20°C~70°C
- According to ASTM A956, DIN 50156, GB/T 17394

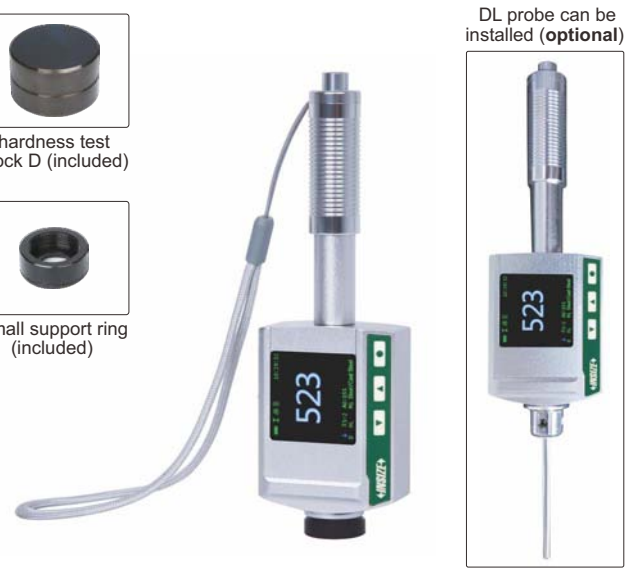

DL probe can be installed (optional)

dynamic ring display

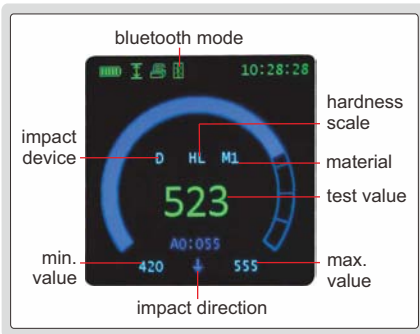

statistic display

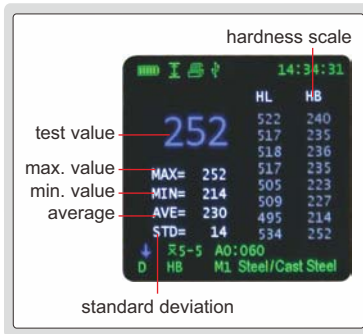

can choose large font display

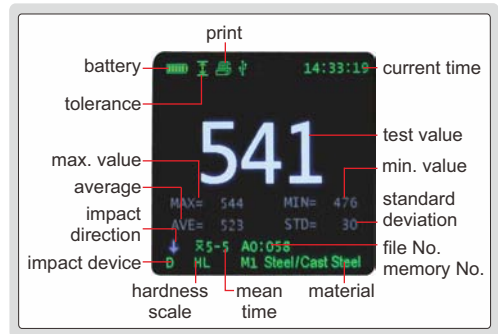

software (included), upload the memory to PC, print and send to EXCEL

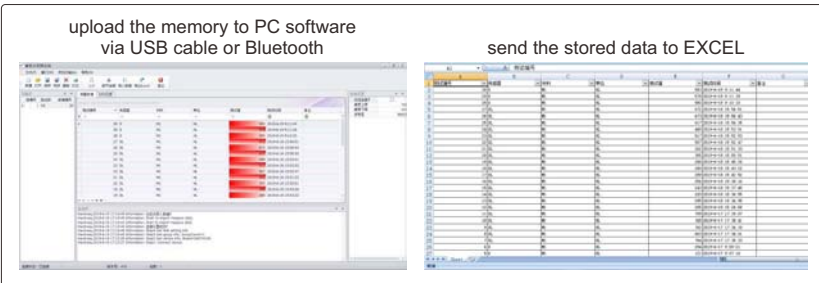

histogram display

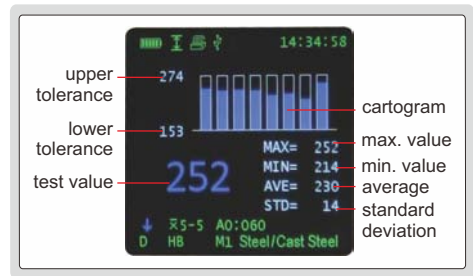

### SPECIFICATION

<b>Resolution</b>	1HLD, 1HV, 1HB, 0.1HRC, 0.1HRB, 0.1HRA, 0.1HS, 1SGM	
<b>Accuracy</b>	±4HLD (when HLD=800)	
<b>Output</b>	USB and bluetooth	
<b>Applicable workpiece</b>	minimum weight	5kg (direct measurement)
		2kg (on solid support)
		0.05kg (coupled on plate)
	minimum thickness: 5mm	
minimum radius of curved surface: 30mm		
maximum roughness (Ra): 2µm		
<b>Power supply</b>	built-in 3.7V rechargeable battery	
<b>Dimension</b>	148×44×22mm	
<b>Weight</b>	115g	

### STANDARD DELIVERY

<b>Main unit</b>	1 pc
<b>Hardness test block D</b>	1 pc
<b>Small support ring</b>	1 pc
<b>Cleaning brush</b>	1 pc
<b>AC/DC adapter</b>	1 pc
<b>Software flash disk and USB cable</b>	1 pc

### OPTIONAL ACCESSORY

<b>Printer</b>	HDT-L410-PRINTER
<b>Support rings</b>	page 829
<b>Hardness test block D</b>	HDT-B-HLD3
<b>DL probe</b>	HDT-L410-DL

**DATA OUTPUT**

**DL PROBE IS OPTIONAL**

**INSPECTION CERTIFICATE**

# PEN-TYPE LEEB HARDNESS TESTER (STANDARD TYPE) CODE HDT-B430



software flash disk (included)



hardness test block D (included)



small support ring (included)



wireless printer (optional)



DL probe can be installed (optional)



- Impact device D is included
- High contrast OLED display
- Based on Leeb (HLD), converted to Vickers (HV), Brinell (HB), Rockwell (HRC, HRA and HRB), Shore (HS) and tensile strength (σb)
- Dual value display, shows both Leeb and other conversion values
- No need to set the testing direction
- 31 files can be saved, each containing 100 measurement data
- Automatically calculate maximum, minimum, average value
- Connected to PC software via USB or Bluetooth
- Connected with printer via Bluetooth
- Operation temperature: -20°C~45°C
- According to ASTM A956, DIN 50156 GB/T, 17394

standard display

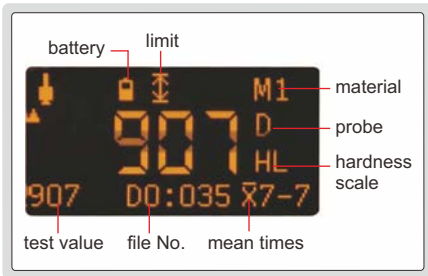

big character display

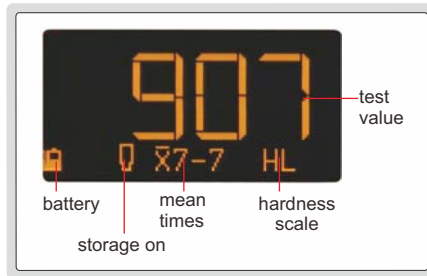

average display

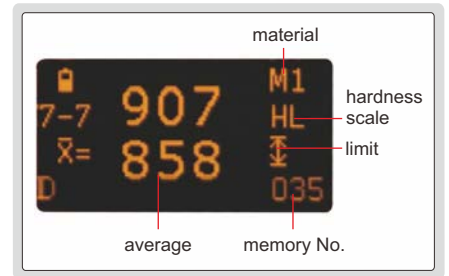

statistical parameter display

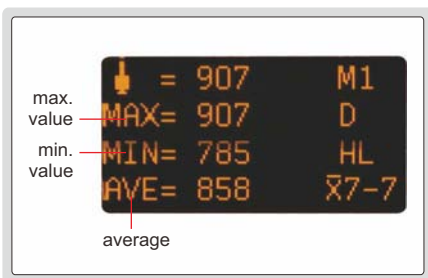

software (included), upload the memory to PC, print and send to EXCEL

upload the memory to PC software via USB cable or Bluetooth

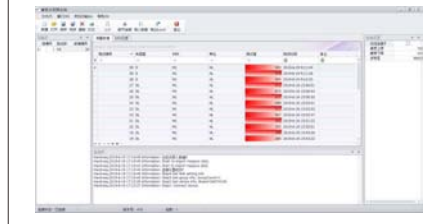

send the stored data to EXCEL

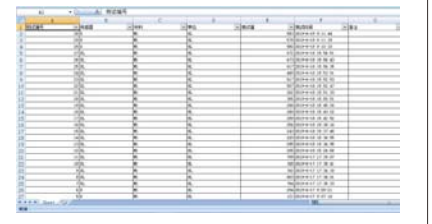

## SPECIFICATION

<b>Resolution</b>	1HLD, 1HV, 1HB, 0.1HRC, 0.1HRB, 0.1HRA, 0.1HSD, 16b	
<b>Accuracy</b>	±6HLD (when HLD=800)	
<b>Measuring range</b>	HLD170-960, HRC17-70, HRB13-109, HB20-655, HV80-940 HSD32-99.5, HRA30-88, σb (rm) 255-2180N/mm <sup>2</sup>	
<b>Applicable workpiece</b>	minimum weight	5kg (direct measurement)
		2kg (on solid support)
		0.05kg (coupled on plate)
	minimum thickness: 5mm	
minimum radius of curved surface: 30mm		
maximum roughness (Ra): 2μm		
<b>Output</b>	USB and bluetooth	
<b>Power supply</b>	built-in 3.7V rechargeable battery	
<b>Dimension</b>	148×44×28mm	
<b>Weight</b>	110g	

## STANDARD DELIVERY

<b>Main unit</b>	1 pc
<b>Hardness test block D</b>	1 pc
<b>Small support ring</b>	1 pc
<b>Cleaning brush</b>	1 pc
<b>AC/DC adapter</b>	1 pc
<b>Software flash disk and USB cable</b>	1 pc

## OPTIONAL ACCESSORY

<b>Printer</b>	ISH-LP200-PRINTER
<b>Support rings</b>	page 829
<b>Hardness test block D</b>	HDT-B-HLD3
<b>DL probe</b>	HDT-L410-DL

## PEN-TYPE LEEB HARDNESS TESTER (BASIC TYPE) CODE HDT-L411

DATA  
OUTPUT

INSPECTION  
CERTIFICATE



software flash disk  
(included)



hardness test  
block D (included)



small support ring  
(included)



can choose large font display

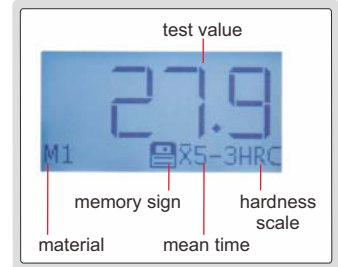

software (included), upload the memory  
to PC, print and send to EXCEL

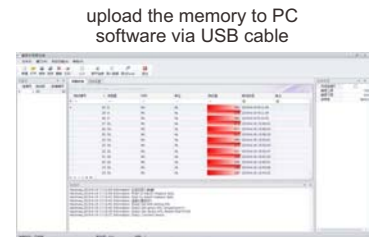

send the stored data to EXCEL

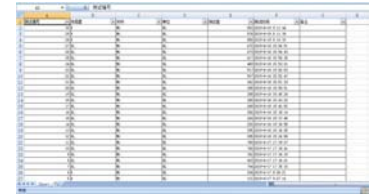

- Impact device D
- Universal testing angle, no need to set impact direction
- Dual-coil probe, high accuracy
- Based on Leeb (HLD), converted to Vickers (HV), Brinell (HB), Rockwell (HRC, HRA and HRB), Shore (HS) and tensile strength (SGM)
- Dual value display, shows both Leeb and converted hardness
- High contrast digital LCD display
- Can choose large font display
- Automatically calculate maximum, minimum, average value
- Connected to PC via USB
- Save 999 data
- Operation temperature: -20°C~45°C
- According to ASTM A956, DIN 50156, GB/T 17394

### SPECIFICATION

<b>Resolution</b>	1HLD, 1HV, 1HB, 0.1HRC, 0.1HRB, 0.1HRA, 0.1HS, 1SGM	
<b>Accuracy</b>	±6HLD (when HLD=800)	
<b>Output</b>	USB	
<b>Measuring range</b>	HL100-960, HRC1-74.7, HRB1.2-140, HB28-1027, HV45-1230, HS4-112, HRA7-88.5, SGM (m) 118-3315N/mm <sup>2</sup>	
<b>Applicable workpiece</b>	minimum weight	5kg (direct measurement)
		2kg (on solid support)
		0.05kg (coupled on plate)
	minimum thickness: 5mm	
	minimum radius of curved surface: 30mm	
	maximum roughness (Ra): 2µm	
<b>Power supply</b>	1xAAA battery	
<b>Dimension</b>	148×45×21mm	
<b>Weight</b>	105g	

### STANDARD DELIVERY

<b>Main unit</b>	1 pc
<b>Hardness test block D</b>	1 pc
<b>Cleaning brush</b>	1 pc
<b>AAA battery</b>	1 pc
<b>Small support ring</b>	1 pc
<b>Software flash disk and USB cable</b>	1 pc

### OPTIONAL ACCESSORY

<b>Support rings</b>	page 829
<b>Hardness test block D</b>	HDT-B-HLD3



## SUPPORT RING SET FOR PORTABLE LEEB HARDNESS TESTER CODE ISH-PH-SP9

type A

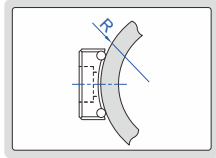

type B

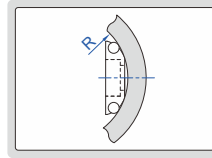

type C

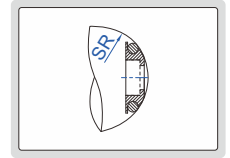

### SPECIFICATION

Type	Applicable workpieces	Range (mm)	Quantity
A	cylindrical outside surface	R10-15	3 pcs
		R14.5-30	
		R25-50	
B	cylindrical inside surface	R11-13	3 pcs
		R12.5-17	
		R16.5-30	
C	spherical inside surface	SR11-13	3 pcs
		SR12.5-17	
		SR16.5-30	
D	spherical outside surface	SR10-15	2 pcs
		SR14.5-30	
E	cylindrical outside surface	R>10	1 pc

type D



type E

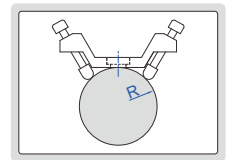
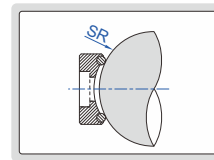

## DIGITAL MAGNETIC ROCKWELL HARDNESS TESTER CODE ISHR-D121



flat anvil for test block  
(included)



- Apply to large and heavy steel or iron workpieces
- With statistic function, display average, maximum and minimum values
- Convert to HV, HB and tensile strength
- According to ISO 6508, ASTM E18



### SPECIFICATION

Hardness scale	HRA, HRB, HRC
Preliminary test force	10kg
Test force	60kg, 100kg, 150kg
Load control	manual
Min. reading	0.1HR
Flat workpiece requirement	length>190mm, width>60mm, thickness>5mm
Cylinder or tube workpiece requirement	length>200mm, diameter>Ø50mm, wall thickness>8mm
Power supply	3×AA batteries
Dimension	245×105×230mm
Weight	5.3kg

### STANDARD DELIVERY

Main unit	1 pc
Flat anvil	1 pc
Diamond indenter	1 pc
Ø1.5875mm carbide ball indenter	1 pc
Hardness test block HRB85~95	1 pc
Hardness test block HRC60~70	1 pc
Hardness test block HRC20~30	1 pc

## MAGNETIC ROCKWELL HARDNESS TESTER CODE ISHR-M111

- Apply to large and heavy steel or iron workpieces
- According to ISO 6508, ASTM E18



flat anvil for test block  
(included)



supports for cylinder or  
tube workpieces (included)



magnifier with LED  
(included)

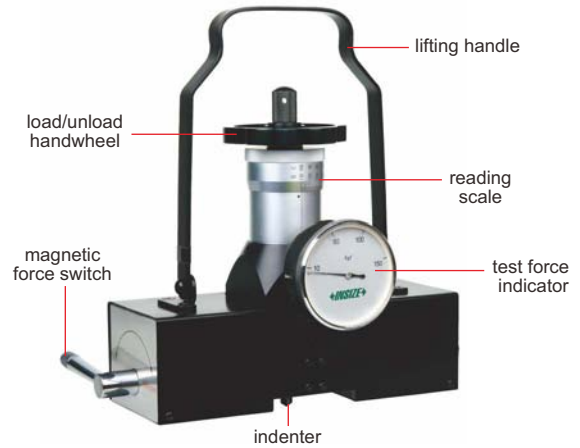

32

### SPECIFICATION

Hardness scale	HRA, HRB, HRC, HRD, HRF, HRG
Preliminary test force	10kg
Test force	60kg, 100kg, 150kg
Load control	manual
Min. reading	1HR
Flat workpiece requirement	length>180mm, width>60mm, thickness>5mm
Cylinder or tube workpiece requirement	length>180mm, diameter>Ø50mm, wall thickness>8mm
Dimension	220×70×220mm
Weight	4.7kg

### STANDARD DELIVERY

Main unit	1 pc
Diamond indenter	1 pc
Ø1.5875mm carbide ball indenter	2 pcs
Hardness test block HRB85-95	1 pc
Hardness test block HRC60-70	1 pc
Hardness test block HRC20-30	1 pc
Flat anvil	1 pc
Support	4 pcs
Magnifier with LED	1 pc

## MAGNETIC BRINELL/ROCKWELL HARDNESS TESTER CODE ISHR-B141



- Apply to large steel or iron workpieces
- According to ISO 6508, ASTM E18

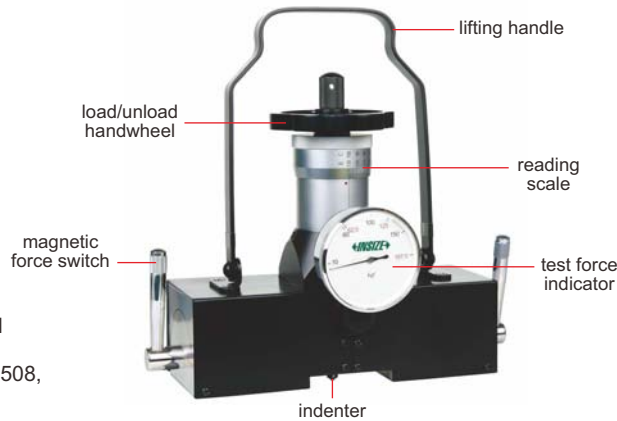

flat anvil for test block  
(included)



supports for cylinder or  
tube workpieces (included)



magnifier with LED  
(included)



measuring microscope  
(included)

### SPECIFICATION

Rockwell scale	HRA, HRB, HRC, HRD, HRF, HRG
Brinell measuring range	20~650HBW
Rockwell test force	10kg preload, 60kg, 100kg, 150kg total load
Brinell test force	62.5kg, 125kg, 187.5kg
Load control	manual
Min. Rockwell reading	1HR
Measuring microscope	40X, graduation 0.01mm
Flat workpiece requirement	length>180mm, width>60mm, thickness>5mm
Cylinder and tube workpiece requirement	length>180mm, diameter>Ø50mm, thickness>8mm
Dimension	220×70×220mm
Weight	4.7kg

### STANDARD DELIVERY

Main unit	1 pc
Flat anvil	1 pc
Support	4 pcs
Diamond Rockwell indenter	1 pc
Ø1.5875mm carbide ball indenter	1 pc
Ø2.5mm Brinell indenter	1 pc
Hardness test block HRB85-95	1 pc
Hardness test block HRC60-70	1 pc
Hardness test block HRC20-30	1 pc
Brinell test block	1 pc
Measuring microscope	1 pc
Magnifier with LED	1 pc

## PORTABLE BRINELL AND ROCKWELL HARDNESS TESTER CODE ISBR-H181



- Apply to huge or medium-size workpieces
- According to ISO 6506, ISO 6508, ASTM E10, ASTM E18



flat anvil  
(included)



V-type anvil  
(included)



measuring  
microscope  
(included)

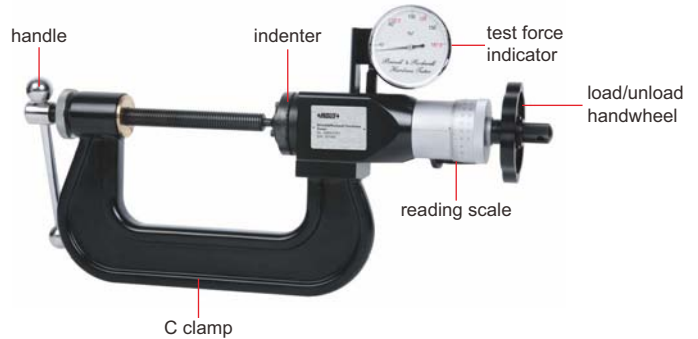

### SPECIFICATION

Rockwell hardness scale	HRA, HRB, HRC
Brinell test range	16~650HBW
Rockwell preliminary test force	10kgf
Rockwell total test force	60kgf, 100kgf, 150kgf
Brinell test force	62.5kgf, 125kgf, 187.5kgf
Load control	manual
Min. reading	rockwell 0.5HR brinell 0.005mm (indentation diameter)
Max. workpiece thickness	75mm
Max. testing width	100mm (from the center of indenter to the main body)
Dimension	510×380×180mm
Weight	2.3kg

### STANDARD DELIVERY

Main unit	1 pc
Diamond indenter	1 pc
Ø1.5875mm carbide ball indenter	1 pc
Ø2.5mm carbide ball indenter	1 pc
Ø5mm carbide ball indenter	1 pc
Hardness test block HRB88~95	1 pc
Hardness test block HRC20~30	1 pc
Hardness test block HRC60~65	1 pc
Hardness test block 200~300HBW2.5/187.5	1 pc
Flat anvil	1 pc
V-type anvil	1 pc
Measuring microscope	1 pc

## PORTABLE ROCKWELL HARDNESS TESTER CODE ISHR-P151



anvil extension for thin  
workpieces (included)



VIDEO



flat anvil (included)



V-type anvil (included)

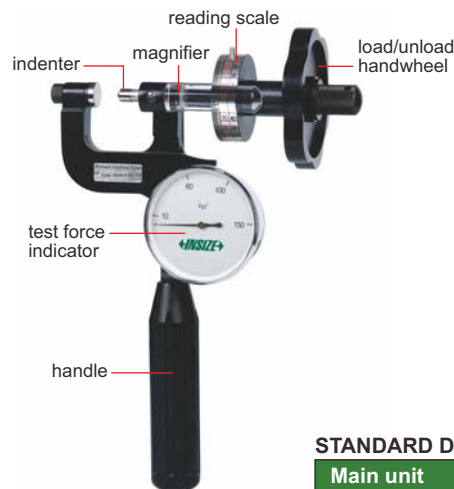

- According to ISO 6508, ASTM E18

### SPECIFICATION

Hardness scale	HRA, HRB, HRC, HRD, HRF, HRG
Preliminary test force	10kg
Test force	60kg, 100kg, 150kg
Load control	manual
Min. reading	1HR
Max. workpiece thickness	25mm
Max. testing width	25mm (from the center of indenter to the main body)
Dimension	240×70×160mm
Weight (with base)	2.5kg

### STANDARD DELIVERY

Main unit	1 pc
Diamond indenter	1 pc
Ø1.5875mm carbide ball indenter	2 pcs
Hardness test block HRB88~95	1 pc
Hardness test block HRC60~65	1 pc
Hardness test block HRC20~30	1 pc
Flat anvil	1 pc
V-type anvil	1 pc
Base	1 pc
Anvil extension	1 pc
Magnifier	2 pcs

## PIN BRINELL HARDNESS TESTER CODE ISHB-P101



- Measure Brinell hardness of large and heavy workpieces
- 1580kg test force and Ø7.26mm ball indenter, equal to 3000kg test force and Ø10mm ball indenter
- Static and impact test modes
- According to ISO and ASTM standard

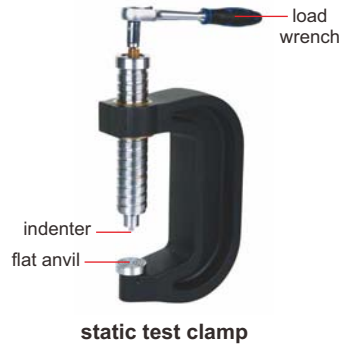

static test clamp

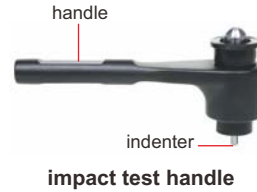

impact test handle

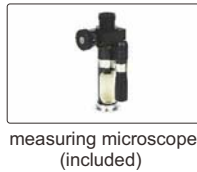
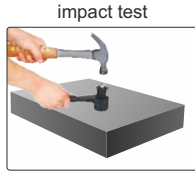
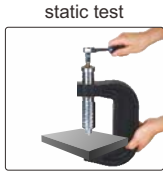
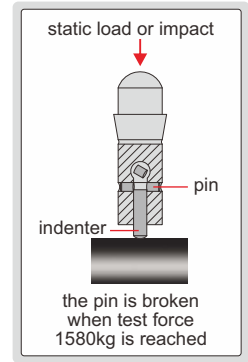

measuring microscope (included)



pins (included)



V-type anvil (included)

### SPECIFICATION

Measuring range	100~350HBW (with Ø7.26mm indenter, included) 350~650HBW (with Ø4mm indenter, optional)
Test force	1580kg
Accuracy	static test: ±3% impact test: ±5%
Measuring microscope	20X, graduation 0.01mm
Max. workpiece height of static test	150mm
Max. testing width of static test	80mm (from the center of indenter to the clamp)
Dimension	195×60×350mm
Weight	4.2kg

### STANDARD DELIVERY

Static test clamp	1 pc
Impact test handle	1 pc
Flat anvil	1 pc
V-type anvil	1 pc
Ø7.26mm indenter	1 pc
Hardness test block	1 pc
Pin	250 pcs
Measuring microscope	1 pc

### OPTIONAL ACCESSORY

Ø4mm indenter	ISHB-P101-INDENTER
Pin (250 pcs)	ISHB-P101-PIN

## HAMMER IMPACT BRINELL HARDNESS TESTER CODE HDT-PB350



hammer impact to apply test force



pins (included)



measuring microscope (included)

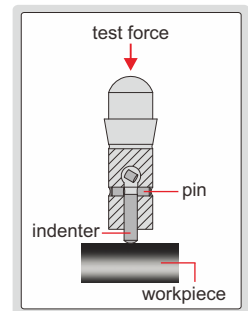

the pin is broken when test force 1580kg is reached

- Measure Brinell hardness of large and heavy workpieces
- 1580kg test force and Ø7.26mm ball indenter, equal to 3000kg test force and Ø10mm ball indenter



### SPECIFICATION

Measuring range	100~350HBW (with Ø7.26mm indenter, included) 350~650HBW (with Ø4mm indenter, optional)
Test force	1580kg
Accuracy	±5%HBW
Repeatability	±5%HBW
Measuring microscope	20X, graduation 0.01mm
Dimension	200×50×100mm
Weight	0.8kg

### STANDARD DELIVERY

Main unit	1 pc
Ø7.26mm indenter	1 pc
Hardness test block	1 pc
Pin	250 pcs
Pin removal tool	1 pc
Measuring microscope	1 pc

### OPTIONAL ACCESSORY

Ø4mm indenter	ISHB-P101-INDENTER
Pin (250 pcs)	ISHB-P101-PIN



## HYDRAULIC BRINELL HARDNESS TESTER CODE ISHB-H131



V-type anvil  
(included)



spherical anvil  
(included)



measuring microscope  
(included)



- According to ISO 6506, ASTM E10

### SPECIFICATION

Measuring range	16~650HBW
Test force	3000kg
Indenter	Ø10mm carbide ball
Measuring microscope	20X, graduation 0.01mm
Max. workpiece height	350mm
Max. testing width	90mm (from the center of indenter to the column)
Dimension	270×225×570mm
Weight	13.8kg

### STANDARD DELIVERY

Main unit	1 pc
Flat anvil	1 pc
V-type anvil	1 pc
Spherical anvil	1 pc
Ø10mm carbide ball	2 pcs
Brinell test block	2 pcs
Measuring microscope	1 pc

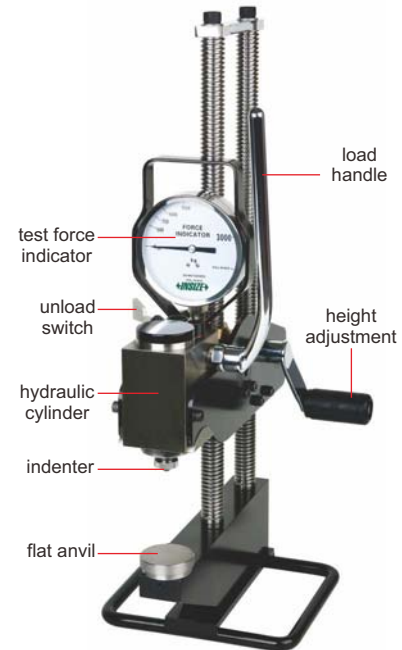

## CHAIN TYPE HYDRAULIC BRINELL HARDNESS TESTER CODE ISHB-C161

- To measure the hardness of cylinders or tubes
- According to ISO 6506, ASTM E10

### SPECIFICATION

Measuring range	32~650HBW
Workpiece diameter range	Ø150~Ø500mm
Test force	3000kg
Indenter	Ø10mm carbide ball
Measuring microscope	20X, graduation 0.01mm
Dimension	270×225×570mm
Weight	14.5kg

### STANDARD DELIVERY

Main unit	1 pc
1.5m chain	1 pc
Ø10mm carbide ball	2 pcs
Brinell test block	2 pcs
Measuring microscope	1 pc

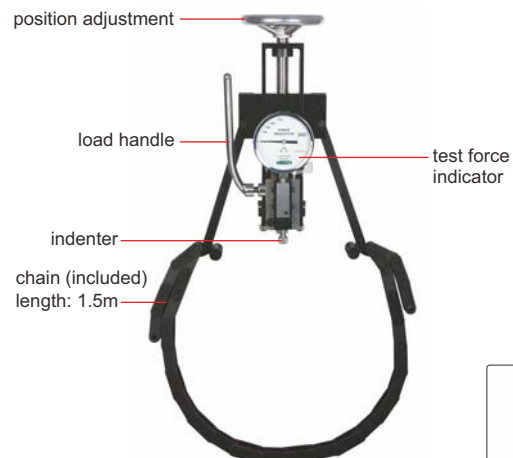

measuring microscope  
(included)

## ALUMINUM HARDNESS TESTERS



- To measure the hardness of soft metal such as aluminum alloy, copper, brass, soft steel, etc.
- According to ASTM B647-84 (2000)

### SPECIFICATION

Code	ISHW-L20	ISHW-L20A	ISHW-L20B	ISHW-B70	ISHW-B75	ISHW-B92
Application	for aluminum alloy general use	for aluminum alloy thick workpiece	for aluminum alloy small tube	for hard aluminum alloy and hard brass	for soft brass and copper	for soft steel and cold-rolled steel
Thickness requirement of flat workpiece	0.6~6mm	0.6~13mm	0.6~8mm	0.6~6mm	0.6~6mm	0.6~6mm
Internal diameter requirement of tube workpiece	>Ø10mm	>Ø10mm	>Ø6mm	>Ø10mm	>Ø10mm	>Ø10mm
Wall thickness requirement of tube workpiece	0.6~6mm	6~13mm (internal diameter Ø10~23.3mm) 0.6~6mm (internal diameter >Ø23.3mm)	0.6~8mm	0.6~6mm	0.6~6mm	0.6~6mm
Hardness range	0~20HW					
Min. reading	1HW					
Accuracy	±0.5HW (at 5~17HW)					
Dimension	205×30×85mm					
Weight	500g					

### STANDARD DELIVERY

Main unit	1 pc
Spare indenter	1 pc
Hardness test block	1 pc
Wrench	1 pc

## ALUMINUM HARDNESS TESTERS (BASIC TYPE)

- To measure the hardness of soft metal such as aluminum alloy, copper, brass, soft steel, etc.
- According to ASTM B647-10 (2016)



VIDEO



ISHW-H10

### STANDARD DELIVERY

Main unit	1 pc
Spare indenter	1 pc
Hardness test block	1 pc
Wrench	1 pc

### SPECIFICATION

Code	ISHW-H10	ISHW-H11	ISHW-H12	ISHW-H13	ISHW-H14	ISHW-H15
Application	for aluminum alloy general use	for aluminum alloy thick workpiece	for aluminum alloy small tube	for hard aluminum alloy and hard brass	for soft brass and copper	for soft steel and cold-rolled steel
Thickness requirement of flat workpiece	0.6~6mm	0.6~13mm	0.6~8mm	0.6~6mm	0.6~6mm	0.6~6mm
Internal diameter requirement of tube workpiece	>Ø10mm	>Ø10mm	>Ø6mm	>Ø10mm	>Ø10mm	>Ø10mm
Wall thickness requirement of tube workpiece	0.6~6mm	6~13mm (internal diameter Ø10~23.3mm) 0.6~6mm (internal diameter >Ø23.3mm)	0.6~8mm	0.6~6mm	0.6~6mm	0.6~6mm
Hardness range	0~20HW					
Min. reading	1HW					
Accuracy	±0.5HW (at 5~17HW)					
Dimension	205×30×95mm					
Weight	500g					

## ALUMINUM HARDNESS TESTER CODE ISHB-B300

- To measure the hardness of workpieces made of pure aluminum, aluminum alloy, fiber reinforced plastic, hard plastic, etc.
- According to ASTM B648-00, ASTM D2853-07



VIDEO

### SPECIFICATION

Hardness range	0~100HBa (equal to 25~150HBW)
Min. reading	1HBa
Accuracy	±2HBa (at 42~52HBa) ±1HBa (at 84~88HBa)
Min. workpiece thickness	0.8mm
Dimension	142×65×90mm
Weight	500g

### STANDARD DELIVERY

Main unit	1 pc
Spare indenter	2 pcs
Hardness test block	2 pcs
Wrench	1 pc



## DIGITAL SHORE DUROMETERS



32



- According to ISO868, ISO7619, ASTM D 2240
- Average and peak (max.) mode
- Dwell time is adjustable
- Tolerance testing
- 500 memories
- Wireless connection to printer
- Handhold use or work with test stand (code **ISH-DS-STANDA**)
- Automatic power off



software flash disk  
(included)

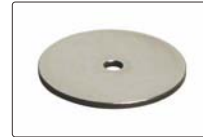

calibration block  
(included)



printer (optional)

### SPECIFICATION

Code	ISH-DSA	ISH-DSD	ISH-DSOO
Unit	Shore A	Shore D	Shore OO
Test material	soft plastic, soft rubber, etc.	hard plastic, hard rubber, etc.	very soft plastic, rubber, sponge, textile, etc.
Measuring range	0~100HA *	0~100HD *	0~100HOO
Resolution	0.1HA	0.1HD	0.1HOO
Accuracy	±1HA	±1HD	±1HOO
Indenter protrusion	2.5mm		
Output	wireless and USB		
Power supply	built-in rechargeable battery		
Dimension	153×50×29mm		
Weight	170g		

\* Use **ISH-DSD** when measuring result is higher than 90HA  
Use **ISH-DSA** when measuring result is lower than 20HD

### STANDARD DELIVERY

Main unit	1 pc
Calibration block	1 pc
Software and USB cable	1 pc
AC/DC adapter	1 pc

### OPTIONAL ACCESSORY

Printer	ISH-DS-PRINTER
Test stand	ISH-DS-STANDA

## TEST STAND FOR DIGITAL SHORE DUROMETERS CODE ISH-DS-STANDA

- For digital shore durometers (code **ISH-DSA**, **ISH-DSD** and **ISH-DSOO**)
- Perform repeatable hardness measurement due to fewer possibilities of human error or measurement variations
- Special structure for stable loading
- Weight block A (included) is for **ISH-DSA**, weight block D (optional) is for **ISH-DSD**, remove weight block for **ISH-DSOO**



weight block D (optional) for ISH-DSD



### SPECIFICATION

Stage diameter	Ø115mm
Max. workpiece height	45mm
Max. testing width	63mm (from test point to the column)
Dimension	Ø195×370mm
Weight	5.61kg

### STANDARD DELIVERY

Test stand	1 pc
Weight block A (for ISH-DSA)	1 pc

### OPTIONAL ACCESSORY

Weight block D (for ISH-DSD)	ISH-DS-W4
------------------------------	-----------



## SHORE DUROMETERS

**INSIZE PLUS**  
MADE IN EUROPE

- According to ISO868, ISO7619, ASTM D 2240
- With peak value indicator
- Handhold use or work with test stand (code **ISH-OS2**)

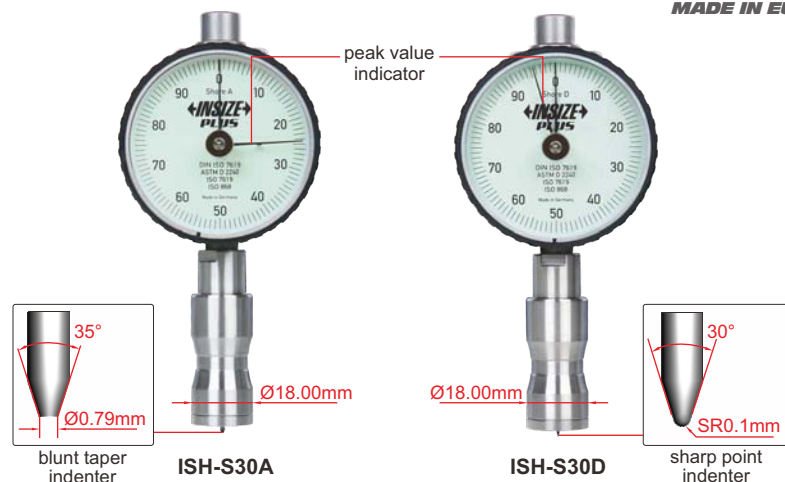

### SPECIFICATION

Code	ISH-S30A	ISH-S30D
Scale	Shore A	Shore D
Test material	soft plastic, soft rubber, etc.	hard plastic, hard rubber, etc.
Measuring range *	0~100HA	0~100HD
Graduation	1HA	1HD
Accuracy	±0.5HA	±0.5HD
Indenter protrusion	2.5mm	
Weight	184g	

\* Use **ISH-S30D** when measuring result is higher than 90HA  
Use **ISH-S30A** when measuring result is lower than 20HD

## TEST STAND FOR SHORE DUROMETERS CODE ISH-OS2

**INSIZE PLUS**  
MADE IN EUROPE



- For shore durometers (code **ISH-S30A** and **ISH-S30D**)
- Perform repeatable hardness measurement due to fewer possibilities of human error or measurement variations
- Special structure for stable loading
- 1kg weight block (included) is for **ISH-S30A**, 4kg weight block (optional) is for **ISH-S30D**

### SPECIFICATION

Stage diameter	Ø98mm
Max. workpiece height	180mm
Max. testing width	115mm (from test point to the column)
Dimension	Ø200×500mm
Weight	18kg

### STANDARD DELIVERY

Test stand	1 pc
1kg weight block (for ISH-S30A)	1 pc
Calibration block	1 pc

### OPTIONAL ACCESSORY

4kg weight block (for ISH-S30D)	ISH-OS2-W4
---------------------------------	------------

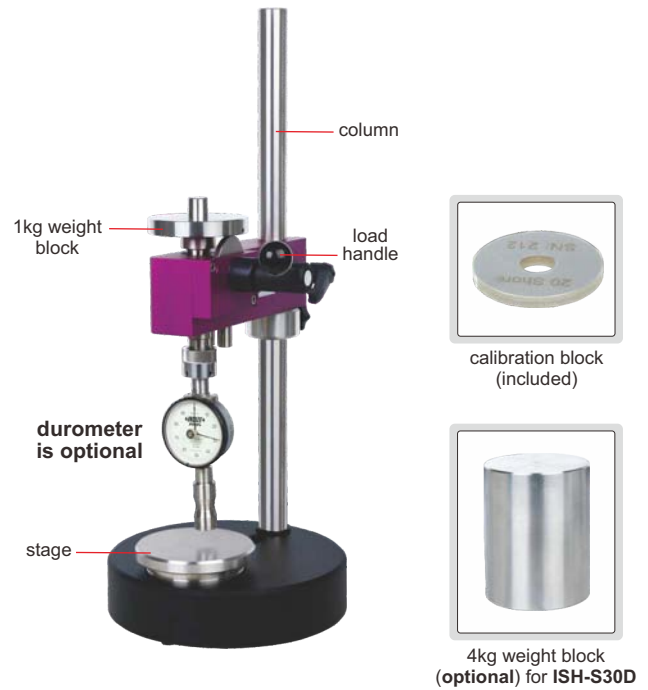

## SHORE DUROMETERS

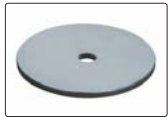

calibration block (optional)

- According to ISO868, ISO7619, ASTM D 2240
- With peak value indicator
- Optional accessory: test stand **ISH-STAC** and **ISH-STD**

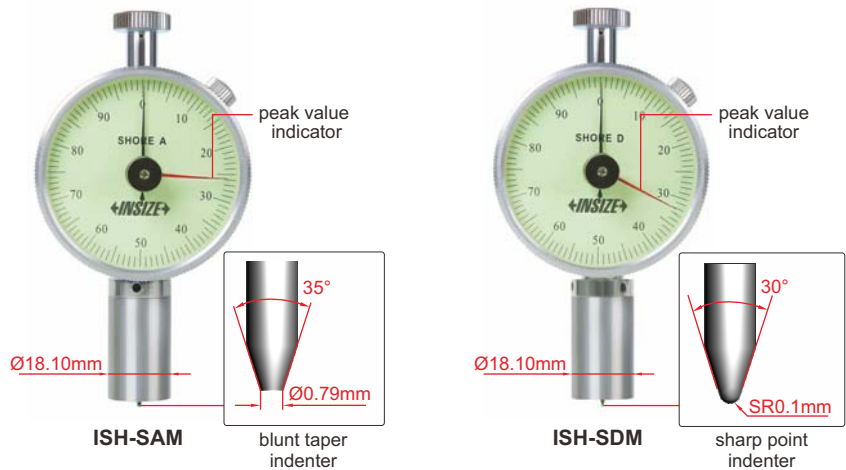

### SPECIFICATION

Code	ISH-SAM	ISH-SDM
Scale	Shore A	Shore D
Application	nature rubber, soft elastomer, etc.	hard rubber, plastic, hard elastomer, etc.
Measuring range *	10~90HA	20~90HD
Graduation	1HA	1HD
Indenter protrusion	2.5mm	
Dimension	115×60×25mm	
Weight	160g	

\* Use **ISH-SDM** when measuring result is higher than 90HA  
Use **ISH-SAM** when measuring result is lower than 20HD

### OPTIONAL ACCESSORY

Calibration block	ISH-DS-BLOCK
-------------------	--------------





VIDEO

## TEST STANDS FOR SHORE DUROMETERS

- For shore durometers (code **ISH-SAM** and **ISH-SDM**)
- Perform repeatable hardness measurement due to fewer possibilities of human error or measurement variations

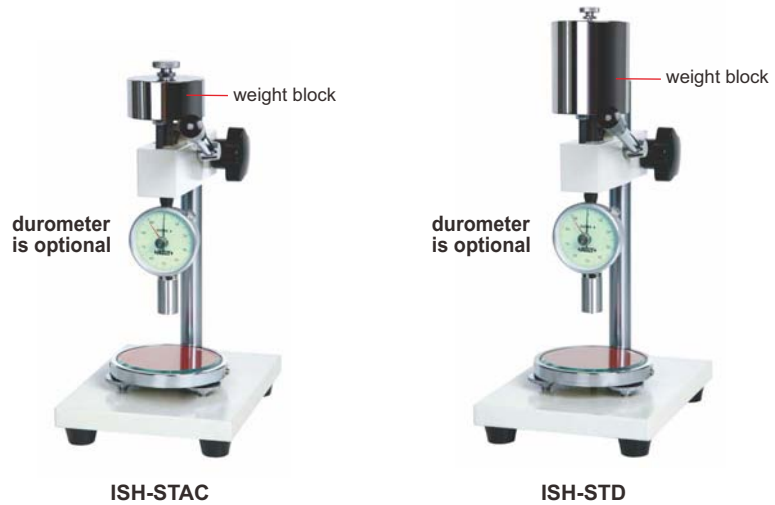

ISH-STAC

ISH-STD

## SPECIFICATION

Code	ISH-STAC	ISH-STD
Applicable durometer	ISH-SAM	ISH-SDM
Stage diameter	Ø100mm	Ø100mm
Max. workpiece height	75mm	75mm
Max. testing width	65mm (from test point to the column)	65mm (from test point to the column)
Weight block	1kg	5kg

## FRUIT HARDNESS TESTER

- Measure the hardness of apples, pears, strawberries and grapes, etc.
- The degree of ripeness can be judged by measuring the hardness of the fruit



9643-4

## SPECIFICATION

Code	Range	Graduation	Accuracy	Probe diameter	Probe depth	Dimension	Weight
9643-4	0.5-4kg/cm <sup>2</sup> (0.5-4×10 <sup>5</sup> Pa)	0.02kg/cm <sup>2</sup> (0.02×10 <sup>5</sup> Pa)	±2%	Ø3.5mm	10mm	151×55×30mm	0.2kg

## HARDNESS TEST BLOCKS



Rockwell

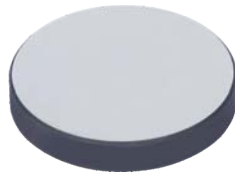

Vickers



Brinell



Leeb



Micro-Vickers



Knoop



Ultrasonic



Shore

■ Supplied with manufacturer inspection certificate

### Rockwell hardness test blocks

Code	Type	Hardness
HDT-B-HRA	HRA	80-84
HDT-B-HRB	HRB	88-100
HDT-B-HRC1	HRC	20-30
HDT-B-HRC2	HRC	35-55
HDT-B-HRC3	HRC	60-70
HDT-B-HRD1	HRD	40-47
HDT-B-HRD2	HRD	55-63
HDT-B-HRD3	HRD	70-75
HDT-B-HRE	HRE	107-114
HDT-B-HRF	HRF	105-114
HDT-B-HRG1	HRG	57-82
HDT-B-HRG2	HRG	80-94

### Rockwell superficial hardness test blocks

Code	Type	Hardness
HDT-B-HR15N1	HR15N	70-77
HDT-B-HR15N2	HR15N	78-88
HDT-B-HR15N3	HR15N	89-91
HDT-B-HR30N1	HR30N	42-54
HDT-B-HR30N2	HR30N	55-73
HDT-B-HR30N3	HR30N	74-80
HDT-B-HR45N1	HR45N	20-31
HDT-B-HR45N2	HR45N	32-61
HDT-B-HR45N3	HR45N	63-70
HDT-B-HR15T	HR15T	88-93
HDT-B-HR30T	HR30T	73-82
HDT-B-HR45T	HR45T	58-72

### Leeb hardness test blocks

Code	Type	Hardness
HDT-B-HLD1	HLD	490-570
HDT-B-HLD2	HLD	590-670
HDT-B-HLD3	HLD	750-830
HDT-B-HLG1	HLG	460-540
HDT-B-HLG2	HLG	550-630

### Vickers hardness test blocks

Code	Type	Hardness
HDT-B-HV5A	HV5	175-200
HDT-B-HV5B	HV5	200-300
HDT-B-HV5C	HV5	300-400
HDT-B-HV5D	HV5	400-500
HDT-B-HV5E	HV5	500-600
HDT-B-HV5F	HV5	600-700
HDT-B-HV5G	HV5	700-750
HDT-B-HV10A	HV10	175-200
HDT-B-HV10B	HV10	200-300
HDT-B-HV10C	HV10	300-400
HDT-B-HV10D	HV10	400-500
HDT-B-HV10E	HV10	500-600
HDT-B-HV10F	HV10	600-700
HDT-B-HV10G	HV10	700-750
HDT-B-HV30A	HV30	175-200
HDT-B-HV30B	HV30	200-300
HDT-B-HV30C	HV30	300-400
HDT-B-HV30D	HV30	400-500
HDT-B-HV30E	HV30	500-600
HDT-B-HV30F	HV30	600-700
HDT-B-HV30G	HV30	700-750
HDT-B-HV50A	HV50	175-200
HDT-B-HV50B	HV50	200-300
HDT-B-HV50C	HV50	300-400
HDT-B-HV50D	HV50	400-500
HDT-B-HV50E	HV50	500-600
HDT-B-HV50F	HV50	600-700
HDT-B-HV50G	HV50	700-750
HDT-B-HV100A	HV100	175-200
HDT-B-HV100B	HV100	200-300
HDT-B-HV100C	HV100	300-400
HDT-B-HV100D	HV100	400-500
HDT-B-HV100E	HV100	500-600
HDT-B-HV100F	HV100	600-700
HDT-B-HV100G	HV100	700-750

To be continued





Continued from previous page

**Micro-Vickers hardness test blocks**

Code	Type	Hardness
HDT-B-HV005A	HV0.05	200-300
HDT-B-HV005B	HV0.05	300-400
HDT-B-HV005C	HV0.05	400-500
HDT-B-HV005D	HV0.05	500-600
HDT-B-HV005E	HV0.05	600-700
HDT-B-HV005F	HV0.05	700-750
HDT-B-HV01A	HV0.1	200-300
HDT-B-HV01B	HV0.1	300-400
HDT-B-HV01C	HV0.1	400-500
HDT-B-HV01D	HV0.1	500-600
HDT-B-HV01E	HV0.1	600-700
HDT-B-HV01F	HV0.1	700-750
HDT-B-HV02A	HV0.2	200-300
HDT-B-HV02B	HV0.2	300-400
HDT-B-HV02C	HV0.2	400-500
HDT-B-HV02D	HV0.2	500-600
HDT-B-HV02E	HV0.2	600-700
HDT-B-HV02F	HV0.2	700-750
HDT-B-HV03A	HV0.3	200-300
HDT-B-HV03B	HV0.3	300-400
HDT-B-HV03C	HV0.3	400-500
HDT-B-HV03D	HV0.3	500-600
HDT-B-HV03E	HV0.3	600-700
HDT-B-HV03F	HV0.3	700-750
HDT-B-HV05A	HV0.5	200-300
HDT-B-HV05B	HV0.5	300-400
HDT-B-HV05C	HV0.5	400-500
HDT-B-HV05D	HV0.5	500-600
HDT-B-HV05E	HV0.5	600-700
HDT-B-HV05F	HV0.5	700-750
HDT-B-HV1A	HV1	200-300
HDT-B-HV1B	HV1	300-400
HDT-B-HV1C	HV1	400-500
HDT-B-HV1D	HV1	500-600
HDT-B-HV1E	HV1	600-700
HDT-B-HV1F	HV1	700-750

**Knoop hardness test blocks**

Code	Type	Hardness
HDT-B-HK005A	HK0.05	200-300
HDT-B-HK005B	HK0.05	400-500
HDT-B-HK005C	HK0.05	700-800
HDT-B-HK01A	HK0.1	200-300
HDT-B-HK01B	HK0.1	400-500
HDT-B-HK01C	HK0.1	700-800
HDT-B-HK02A	HK0.2	200-300
HDT-B-HK02B	HK0.2	400-500
HDT-B-HK02C	HK0.2	700-800
HDT-B-HK03A	HK0.3	200-300
HDT-B-HK03B	HK0.3	400-500
HDT-B-HK03C	HK0.3	700-800
HDT-B-HK05A	HK0.5	200-300
HDT-B-HK05B	HK0.5	400-500
HDT-B-HK05C	HK0.5	700-800
HDT-B-HK1A	HK1	200-300
HDT-B-HK1B	HK1	400-500
HDT-B-HK1C	HK1	700-800

**Brinell hardness test blocks**

Code	Type	Hardness
HDT-B-HB10A1	HBW10/3000	100-200
HDT-B-HB10A2	HBW10/3000	200-300
HDT-B-HB10A3	HBW10/3000	300-400
HDT-B-HB10A4	HBW10/3000	400-500
HDT-B-HB10A5	HBW10/3000	500-600
HDT-B-HB10A6	HBW10/3000	600-650
HDT-B-HB10B1	HBW10/1500	100-200
HDT-B-HB10B2	HBW10/1500	200-300
HDT-B-HB10B3	HBW10/1500	300-400
HDT-B-HB10B4	HBW10/1500	400-500
HDT-B-HB10B5	HBW10/1500	500-600
HDT-B-HB10B6	HBW10/1500	600-650
HDT-B-HB10C1	HBW10/1000	90-200
HDT-B-HB10C2	HBW10/1000	200-300
HDT-B-HB10C3	HBW10/1000	300-400
HDT-B-HB10C4	HBW10/1000	400-450
HDT-B-HB10D1	HBW10/500	90-200
HDT-B-HB10D2	HBW10/500	200-300
HDT-B-HB10D3	HBW10/500	300-400
HDT-B-HB10D4	HBW10/500	400-450
HDT-B-HB25A1	HBW2.5/187.5	100-200
HDT-B-HB25A2	HBW2.5/187.5	200-300
HDT-B-HB25A3	HBW2.5/187.5	300-400
HDT-B-HB25A4	HBW2.5/187.5	400-500
HDT-B-HB25A5	HBW2.5/187.5	500-600
HDT-B-HB25A6	HBW2.5/187.5	600-650
HDT-B-HB25B1	HBW2.5/62.5	90-200
HDT-B-HB25B2	HBW2.5/62.5	200-300
HDT-B-HB25B3	HBW2.5/62.5	300-400
HDT-B-HB25B4	HBW2.5/62.5	400-450
HDT-B-HB5A1	HBW5/750	100-200
HDT-B-HB5A2	HBW5/750	200-300
HDT-B-HB5A3	HBW5/750	300-400
HDT-B-HB5A4	HBW5/750	400-500
HDT-B-HB5A5	HBW5/750	500-600
HDT-B-HB5A6	HBW5/750	600-650
HDT-B-HB5B1	HBW5/250	90-200
HDT-B-HB5B2	HBW5/250	200-300
HDT-B-HB5B3	HBW5/250	300-400
HDT-B-HB5B4	HBW5/250	400-450

**Shore hardness test blocks**

Code	Type	Hardness *
HDT-B-SA	SA	6 pcs/set (30, 40, 50, 60, 70, 80)
HDT-B-SD	SD	3 pcs/set (15, 30, 90)

\*The actual value may be slightly different when delivered

**Ultrasonic hardness test blocks**

Code	Type	Hardness
HDT-B-HRCU1	HRC	20-30
HDT-B-HRCU2	HRC	35-55
HDT-B-HRCU3	HRC	60-70
HDT-B-HV5U1	HV5	200-300
HDT-B-HV5U2	HV5	400-500
HDT-B-HV5U3	HV5	700-750
HDT-B-HB10U1	HBW10/1000	90-200
HDT-B-HB10U2	HBW10/3000	200-300
HDT-B-HB10U3	HBW10/3000	400-500

## CONCRETE STRENGTH TESTERS



DATA OUTPUT



CST-D101



CST-D102

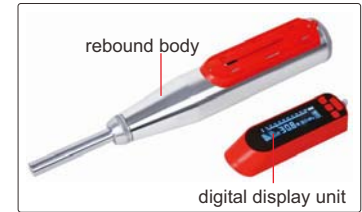

CST-D102 separable

- Measure the strength of general building components, bridges and various concrete components (slabs, beams, columns, bridges, etc.)
- Angle, test surface, pumping, carbonization depth and other parameters can be customized according to the requirements
- The rebound body can be used for 2000 times
- USB data transmission
- The software can automatically generate the test report, and the strength curve can be customized and stored in the tester
- Storage and reading of 1000 test data
- According to JGJ/T23-2011, the curve of rebound meter can be customized to calculate the compressive strength of concrete

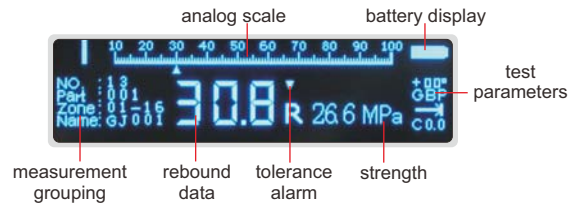

### SPECIFICATION

Code	CST-D101	CST-D102
Display	OLED display	
Range	10-70N/mm <sup>2</sup>	
Accuracy	±1R	
Parameter	MPa, N/mm <sup>2</sup> , Kgf/mm <sup>2</sup>	
Impact energy	2.207J, for testing common buildings or bridge structures	
Output	USB	
Structure	one body, non-seperable	separable, the digital display unit can be reused
Memory	1000 data	
Operation temperature	-40°C~60°C	
Power supply	built-in rechargeable battery	
Dimension	280×75×60mm	
Weight	1.1kg	



software flash disk (included)



sander (included)



calibration block (optional)

### STANDARD DELIVERY

Main unit	1 pc
Sander	1 pc
Power adapter	1 pc
Software and USB cable	1 pc

### OPTIONAL ACCESSORY

Rebound body (for CST-D102)	CST-D102-REBOUND
Digital display unit (for CST-D102)	CST-D102-DISPLAY
Calibration block	CST-D-BLOCK

software (included) for uploading and storing data, printing and importing/exporting strength curves



**Cutting Machines**  
Page 844-846



**Grinders And Polishers**  
Page 847-850



**Mounting Presses**  
Page 851-853



**Metallurgical Microscopes**  
Page 853

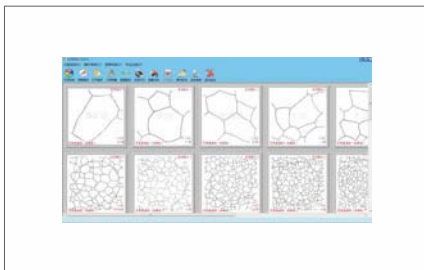

**Metallurgical Analysis Softwares**  
Page 853



**Cutting Machine Accessories**  
Page 854-855



**Mounting Press Accessories**  
Page 855-857



**Grinder And Polisher Accessories**  
Page 857

## AUTOMATIC CUTTING MACHINE (ADVANCED TYPE) CODE MLP-HCM102



- Suitable for cylinder workpieces (diameters≤100mm) and rectangular samples (height≤70mm, width≤100mm)
- Cooling system avoids overheating and destroying sample structure
- Three cutting modes (manual, pulse, continuous cutting), the cutting feed speed and cutting stroke can be programmed

### SPECIFICATION

Maximum cutting diameter	Ø100mm
Cutting blade	Ø350×2.5×Ø32mm
Rotation speed	2200r/min
Spindle travel	145mm
Table travel	300mm
Illumination	LED ceiling light
Noise	≤85dB
Cooling tank	60L
Removable baffle	contain
Table dimension	330×280mm
Power	3kW
Power supply	AC 380V, 50Hz
Dimension	900×860×620mm
Weight	285kg

### STANDARD DELIVERY

Main unit	1 pc
Cutting blade	5 pcs
Cutting blade chuck	2 pcs
Coolant	1 barrel (4L)
Water tank	1 pc

### OPTIONAL ACCESSORY

Coolant (4L, 1:20 diluted with water)	MLP-OL3
Cutting blade (Ø350×2.5×Ø32mm, 40 pcs/box)	MLP-50Z4
Cutting blade chuck (for Ø32mm cutting blade)	MLP-60Y4*
	MLP-HCM102-CHUCK

\* Special cutting blade for high hardness



coolant (included)



cutting blade MLP-50Z4  
(included)



cutting blade MLP-60Y4  
(optional)



## CUTTING MACHINE (STANDARD TYPE) CODE MLP-CM60



33

- For metal and non-metal materials
- Cooling device avoids overheating and destroying sample structure
- With safety switch, the machine will automatically stop when the cover is opened

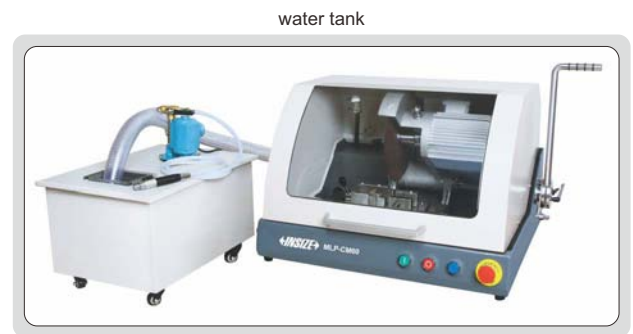

### SPECIFICATION

Maximum cutting diameter	Ø60mm
Cutting blade	Ø250×1.5×Ø25.4mm
Rotation speed	2800r/min
Motor power	2.2kW
Power supply	AC 380V, 50Hz
Dimension	830×620×450mm
Weight	82kg



cutting blade MLP-CM60-CUT2  
(included)

### STANDARD DELIVERY

Main unit	1 pc
Cutting blade	2 pcs
Coolant	1 barrel (4L)
Water tank	1 pc



coolant (optional)

### OPTIONAL ACCESSORY

Coolant (4L, 1:20 diluted with water)	MLP-OL3
Cutting blade (Ø250×1.5×Ø25.4mm, 60 pcs/box)	MLP-CM60-CUT2
Cutting blade (Ø250×2×Ø32mm, 50 pcs/box)	MLP-50Z2 *
Cutting blade chuck (for Ø32mm cutting blade)	MLP-CM60-CHUCK

\* When use MLP-50Z2, please purchase MLP-CM60-CHUCK

# CUTTING MACHINE (BASIC TYPE) CODE MLP-CM86



- For metal and non-metal materials
- Cooling device avoids overheating and destroying sample structure

### SPECIFICATION

Maximum cutting diameter	Ø80mm
Cutting blade	Ø250×2×Ø32mm
Rotation speed	2800r/min
Power	3kW
Power supply	AC 380V, 50Hz
Dimension	690×790×670mm

### STANDARD DELIVERY

Main unit	1 pc
Cutting blade	2 pcs
Coolant	1 barrel (4L)
Water tank	1 pc

### OPTIONAL ACCESSORY

Coolant (4L, 1:20 diluted with water)	MLP-OL3
Cutting blade (Ø250×2×Ø32mm, 50 pcs/box)	MLP-60Y2*
	MLP-50Z2
Cutting blade chuck (for Ø32mm cutting blade)	MLP-CM86-CHUCK

\* Special cutting blade for high hardness



coolant (included)



cutting blade MLP-50Z2 (included)



cutting blade MLP-60Y2 (optional)



## GRINDER AND POLISHER (ADVANCED TYPE) CODE MLP-GP305

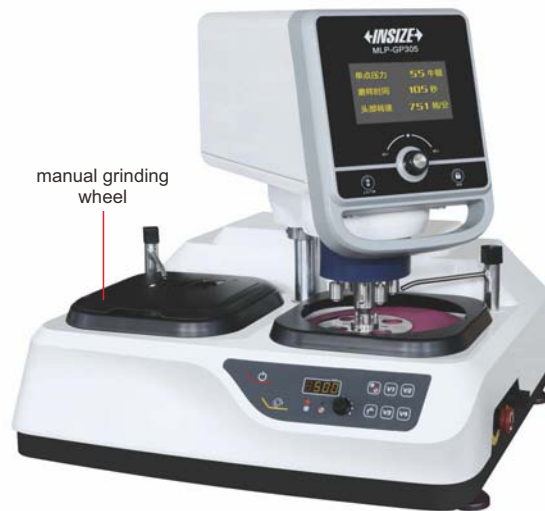

manual grinding wheel

- Replaceable double wheels, rotation direction can be selected
- Multi sample holder, pneumatic single point loading, automatic abrasive distribution
- Adjustable speed
- Water cooling device and abrasive cleaning nozzle prevent samples from overheating and destroying structure
- ABS case and stainless steel parts, anti-corrosion, easy to clean
- Metallographic samples can be roughly ground, finely ground, roughly polished and finely polished

### SPECIFICATION

Wheel diameter	Ø250mm (customizable Ø300mm)
Wheel rotation speed	50~1000r/min (stepless adjustable), 150r/min, 300r/min (two fixed speeds)
Wheel rotation direction	clockwise or counterclockwise
Grinding head speed	50~150r/min (stepless adjustable)
Pressure range	5~60N
Operation number	6
Operation time	0~995s
Sample diameter	Ø30mm (customizable Ø22mm, Ø25mm, Ø30mm, Ø40mm, Ø45mm, Ø50mm)
Air pressure	0.6~0.9MPa
Power supply	AC220V, 50Hz
Input power	1.1kW
Dimension	758×785×680mm
Weight	125kg

### STANDARD DELIVERY

Main unit	1 pc
Silicon carbide paper	20 pcs each (240, 250, 400, 800, 1200), 100 pcs in total
Polishing cloth	3 pcs each (velvet silk, woolen fabric), 6 pcs in total
Polishing agent	1 pc (W2.5, 500ml)
Spray polish agent	1 pc (W2.5, 350ml)
Magnetic pad	2 pcs (Ø250mm)
Anti-stick disc	3 pcs (Ø250mm)

### OPTIONAL ACCESSORY

Silicon carbide paper	<b>MLP-SZG</b> □□ *	50 pcs/box, select granularity: 120, 180, 240, 400, 600, 800, 1000, 1200, 1500, 2000
Polishing cloth	<b>MLP-CT7</b>	15 pcs/box, long velvet silk material
	<b>MLP-CT27</b>	15 pcs/box, woolen fabric
Diamond polishing liquid	<b>MLP-DLA</b> □□ *	500ml, select granularity (µm): W40, W28, W20, W14, W9, W7, W5, W3.5, W2.5, W1.5, W1.0, W0.5, W0.25
Spray polish agent	<b>MLP-DSA</b> □□ *	350ml, select granularity (µm): W40, W28, W20, W14, W10, W7, W5, W3.5, W2.5, W1.5, W1.0, W0.5, W0.25
Magnetic pad	<b>MLP-AD2</b>	Ø250mm
Anti-stick disc	<b>MLP-DC2</b>	Ø250mm

\* □□ is granularity specification, for example, code **MLP-DLA40** stands for 40µm



silicon carbide paper (included)



polishing cloth (included)

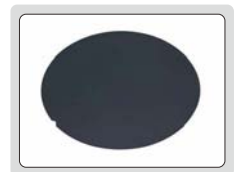

anti-stick disc (included)

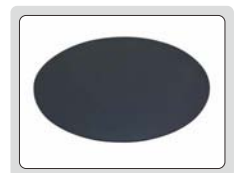

magnetic pad (included)

## GRINDER AND POLISHER (ADVANCED TYPE) CODE MLP-GP260



33

- ABS case and stainless steel parts, anti-corrosion, easy to clean
- Can hold up to 4 samples (6 holes are optional and can hold up to 6 samples)
- Smooth rotation, low noise
- Adjustable speed
- Water cooling device and abrasive cleaning nozzle prevent samples from overheating and destroying structure
- Wheel rotation direction can be selected
- Replaceable wheel

### SPECIFICATION

Wheel diameter	Ø250mm
Wheel rotation speed	50~999r/min (stepless adjustable), 150 or 300r/min (two fixed speeds)
Wheel rotation direction	clockwise or counterclockwise
Grinding head speed	50~150r/min (stepless adjustable)
Pressure range	5~60N
Operation time	5~995s
Sample diameter	Ø30mm (can be customized)
Air pressure	0.6~0.9MPa
Power supply	AC 220V, 50Hz
Input power	1.1kW
Dimension	594×795×687mm
Weight	98kg

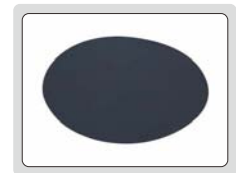

silicon carbide paper  
(optional)

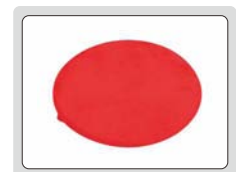

polishing cloth (optional)

### STANDARD DELIVERY

Main unit	1 pc
Silicon carbide paper	6 pcs (200, 600, 1000)
Polishing cloth	4 pcs

### OPTIONAL ACCESSORY

Silicon carbide paper	MLP-SZG□□*	50 pcs/box, select granularity: 120, 180, 240, 400, 600, 800, 1000, 1200, 1500, 2000
Polishing cloth	MLP-CT7	15 pcs/box, long velvet silk material
Diamond polishing liquid	MLP-DLA□□*	500ml, select granularity (µm): W40, W28, W20, W14, W9, W7, W5, W3.5, W2.5, W1.5, W1.0, W0.5, W0.25

\* □□ is granularity specification, for example, code MLP-DLA40 stands for 40µm



## GRINDERS AND POLISHERS (STANDARD TYPE)



- ABS case and stainless steel parts, anti-corrosion, easy to clean
- Replaceable double wheel, wheel can be controlled independently, rotation direction can be selected
- Smooth rotation, low noise
- Four fixed speeds/stepless adjustable speed
- Water cooling device, prevent samples from overheating and destroying structure
- Metallographic samples can be roughly ground, finely ground, roughly polished and finely polished



MLP-GP280



silicon carbide paper  
(optional)



polishing cloth (optional)

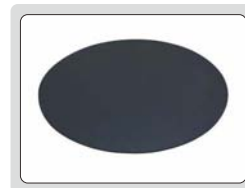

magnetic pad (optional)

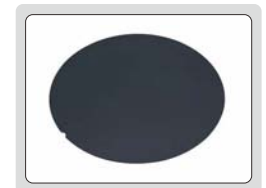

anti-stick disc  
(optional)

### SPECIFICATION

Code	MLP-GP270	MLP-GP280
Wheel diameter	Ø203mm	Ø250mm
Wheel rotation speed	0-1400r/min (stepless adjustable)	0-1000r/min (stepless adjustable)
Wheel rotation direction	clockwise or counterclockwise	
Fixed speed	150r/min, 300r/min, 600r/min, 1000r/min	
Power supply	AC 220V, 50Hz	
Input power	1.5kW	
Dimension	758×785×310mm	
Weight	50kg	

### STANDARD DELIVERY

Main unit	1 pc
Silicon carbide paper	5 pcs each (240, 400, 800, 1200), 20 pcs in total
Polishing cloth	3 pcs
Polishing agent	1 pc

### OPTIONAL ACCESSORY

Silicon carbide paper	MLP-SZD□□* (for MLP-GP270)	50 pcs/box, select granularity, Ø200mm with adhesive: 120, 180, 240, 400, 600, 800, 1000, 1200, 1500, 2000
	MLP-SZG□□* (for MLP-GP280)	50 pcs/box, select granularity, Ø250mm with adhesive: 120, 180, 240, 400, 600, 800, 1000, 1200, 1500, 2000
Polishing cloth	MLP-CT6 (for MLP-GP270)	15 pcs/box, Ø200mm with adhesive, long velvet silk material
	MLP-CT7 (for MLP-GP280)	15 pcs/box, Ø250mm with adhesive, long velvet silk material
Diamond polishing liquid	MLP-DLA□□*	500ml, select granularity (µm): W40, W28, W20, W14, W9, W7, W5, W3.5, W2.5, W1.5, W1.0, W0.5, W0.25
Magnetic pad	MLP-AD1 (for MLP-GP270)	Ø200mm
	MLP-AD2 (for MLP-GP280)	Ø250mm
Anti-stick disc	MLP-DC1 (for MLP-GP280)	Ø200mm
	MLP-DC2 (for MLP-GP280)	Ø250mm

\* □□ is granularity specification, for example, code MLP-DLA40 stands for 40µm

## GRINDER AND POLISHER (BASIC TYPE) CODE MLP-GP314



33

- Double wheels, rotation direction can be selected
- Smooth rotation, low noise
- Water cooling device, prevent samples from overheating and destroying structure
- Replaceable silicon carbide paper and polishing cloth for grinding and polishing process



silicon carbide paper  
(included)

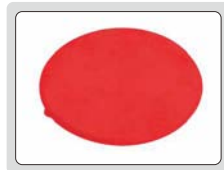

polishing cloth (included)

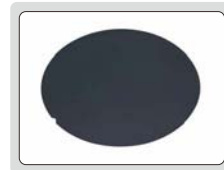

anti-stick disc (optional)



magnetic pad (optional)

### SPECIFICATION

Wheel diameter	Ø203mm
Wheel rotation speed	0~1400r/min (stepless adjustable)
Wheel rotation direction	clockwise or counterclockwise
Power supply	AC 220V, 50Hz
Input power	0.75kW
Dimension	755×700×310mm
Weight	50kg

### STANDARD DELIVERY

Main unit	1 pc
Silicon carbide paper	5 pcs each (240, 400, 800, 1200), 20 pcs in total
Polishing cloth	4 pcs
Polishing agent	1 pc (W2.5, 500ml)

### OPTIONAL ACCESSORY

Silicon carbide paper	MLP-SZD□□*	50 pcs/box, select granularity: 120, 180, 240, 400, 600, 800, 1000, 1200, 1500, 2000
Polishing cloth	MLP-CT6	15 pcs/box, long velvet silk material
Diamond polishing liquid	MLP-DLA□□*	500ml, select granularity (µm): W40, W28, W20, W14, W9, W7, W5, W3.5, W2.5, W1.5, W1.0, W0.5, W0.25
Magnetic pad	MLP-AD1	Ø203mm
Anti-stick disc	MLP-DC1	Ø203mm

\* □□ is granularity specification, for example, code MLP-DLA40 stands for 40µm



## MOUNTING PRESSES (ADVANCED TYPE)



MLP-MP43



MLP-MP53

33

- Built-in heating and cooling structure reduces the mounting time to 6 minutes
- The programmed control system reserves 10 customized preparation schemes to meet different mounting requirements
- The thickness of the middle mold is up to 15mm, and 2 samples can be mounted at the same time at one station
- Can accurately control the pressure size, adjustment range: 1~20MPa



hot mounting resin (included)

### SPECIFICATION

Code	MLP-MP43	MLP-MP53
Station number	1	2
Power	1100W+heating power *	1200W+heating power×2
Mounting diameter	Ø30mm (customizable Ø25, Ø40, Ø50mm)	
System pressure	1~20MPa, optional increase or decrease 1MPa	
Pressure mode	automatic electro-hydraulic	
Cooling mode	automatic water cooling **	
Heating range	90~200°C	
Holding time	0~10min	
Cooling temperature/time	40~90°C/0~10min	
Power supply	AC 220V, 50Hz	
Dimension	530×485×463mm	671×485×463mm
Weight	44kg	77kg

\* Heating power of mounting sleeve: 1800W (mounting diameter≤31.8mm), 2400W (mounting diameter≥38.1mm)

\*\* Cooling water pressure should not be higher than 1MPa, must be filtered through 40µm filter

### STANDARD DELIVERY

Main unit	1 pc
Hot mounting resin	1 bottle (250g)
Funnel	1 pc
Filter	1 pc
Vacuum cleaner tip	1 pc

### OPTIONAL ACCESSORY

Hot mounting resin (black, 4kg)	MLP-DR3
---------------------------------	---------

## MOUNTING PRESS (STANDARD TYPE) CODE MLP-MP30



- Automatic heating, pressuring, cooling and pressure relief
- Water cooling system



hot mounting resin (optional)



### SPECIFICATION

Diameter of workpiece	Ø30mm
Heating temperature range	100~200°C
Delay range	0~999s
Hold time	0~999s
Cooling temperature	20~90°C
Heating power	600W
Power supply	AC 220V, 50Hz
Dimension	350×450×470mm
Weight	45kg

### STANDARD DELIVERY

Main unit	1 pc
Hot mounting resin	1 bottle (250g)
Funnel	1 pc

### OPTIONAL ACCESSORY

Hot mounting resin (black, 4kg)	MLP-DR3
---------------------------------	---------

## MOUNTING PRESS (BASIC TYPE) CODE MLP-MP62



- Suitable for tiny, difficult to handle or irregular metallographic and petrographic samples
- The sample preparation program has three modes: bakelite powder, electric jade powder and user-defined
- The sample preparation program controls the sample preparation time and realizes unattended sample preparation



hot mounting resin (included)



### SPECIFICATION

Mounting diameter	Ø30mm (customizable Ø22mm, Ø45mm)
Heating range	room temperature~200°C
Timing range	0~30min
Power	≤800W
Power supply	AC220V, 50Hz
Dimension	440×253×310mm
Weight	32kg

### STANDARD DELIVERY

Main unit	1 pc
Hot mounting resin	1 bottle (60g)
Funnel	1 pc

### OPTIONAL ACCESSORY

Hot mounting resin (black, 4kg)	MLP-DR3
---------------------------------	---------



VACUUM MOUNTING PRESS  
CODE MLP-MP25

- Suitable for epoxy resins and cold mosaic compound of polyester castable
- High efficiency, simple and reliable



cold mounting compound  
(optional)

SPECIFICATION

Maximum vacuum	-58kPa
Vacuum chamber size	Ø260×125mm
Transposition speed	5r/min
Input power	6W
Power supply	220/110V
Dimension	460×400×403mm
Weight	30kg

STANDARD DELIVERY

Main unit	1 pc
Vacuum pump	1 pc
Ø25mm mold	1 pc
Ø30mm mold	1 pc
Ø40mm mold	1 pc
Ø50mm mold	1 pc
Epoxy resin (400g)	1 pc
Curing agent (200g)	1 pc
Waxed paper tray	10 pcs



OPTIONAL ACCESSORY

Cold mounting compound	MLP-CM1, MLP-CM6
Epoxy resin	MLP-CM3, MLP-CM4

REFER TO PAGE  
638-640 FOR DETAILS

METALLURGICAL MICROSCOPES



5102-M600



5108-M3000



5103-M1000

METALLURGICAL ANALYSIS SOFTWARE AND CAMERA

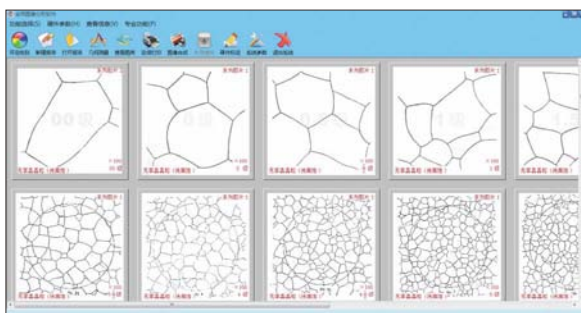

ISM-MAS100

REFER TO PAGE  
657-658 FOR DETAILS

## DIAMOND BLADES

- Specially for precision cutting of carbide, ceramic materials, optical glass and other brittle metal materials



Code	Description	Specification (mm)
MLP-DQ1	1. saw blade is made of edge electroplating 2. used for small workpieces made of crystal, ceramic, glass and alloy materials	Ø100×0.4×12.7
MLP-DQ2		Ø150×0.5×12.7
MLP-DQ3	1. saw blade is made of edge sintering technology 2. used for hard alloy, ceramic, optical glass and other brittle metal materials	Ø100×0.5×20
MLP-DQ4		Ø200×1×32

## CUTTING BLADES



MLP-50Z1

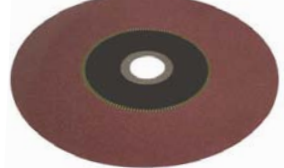

MLP-60Y1

Code	Application	Cutting blade size	Package (pcs/box)
MLP-10R1	1. light non-ferrous metal 2. high toughness metal (Ti) 3. HV hardness value: 0~250	Ø250×1.5×32mm	60
MLP-10R2		Ø250×2×32mm	50
MLP-10R3		Ø300×2×32mm	50
MLP-10R4		Ø350×2.5×32mm	40
MLP-20R1	1. soft ferrous metal 2. HV hardness value: 50~300	Ø250×1.5×32mm	60
MLP-20R2		Ø250×2×32mm	50
MLP-20R3		Ø300×2×32mm	50
MLP-20R4		Ø350×2.5×32mm	40
MLP-30R1	1. medium soft ferrous metal 2. HV hardness value: 120~500	Ø250×1.5×32mm	60
MLP-30R2		Ø250×2×32mm	50
MLP-30R3		Ø300×2×32mm	50
MLP-30R4		Ø350×2.5×32mm	40
MLP-40Z1	1. medium hardness ferrous metal 2. HV hardness value: 180~600	Ø250×1.5×32mm	60
MLP-40Z2		Ø250×2×32mm	50
MLP-40Z3		Ø300×2×32mm	50
MLP-40Z4		Ø350×2.5×32mm	40
MLP-50Z1	1. hard ferrous metal 2. HV hardness value: 180~700	Ø250×1.5×32mm	60
MLP-50Z2		Ø250×2×32mm	50
MLP-50Z3		Ø300×2×32mm	50
MLP-50Z4		Ø350×2.5×32mm	40
MLP-50Z5		Ø400×3×32mm	25
MLP-50Z6		Ø450×3.2×32mm	25
MLP-50Z7		Ø509×4×38.1mm	10
MLP-50Z8		Ø610×4×38.1mm	10
MLP-60Y1	1. high hardness ferrous metal 2. HV hardness value: 250~900	Ø250×1.5×32mm	60
MLP-60Y2		Ø250×2×32mm	50
MLP-60Y3		Ø300×2×32mm	50
MLP-60Y4		Ø350×2.5×32mm	40

- Cutting surfaces are bright and smooth without burning

## CUTTING COOLANT

- Free of mineral oil and sodium nitrite, suitable for all kinds of metallographic cutting machines
- Harmless to human health and environment

Code	Description	Specification
MLP-OL1	1. fully synthetic concentrate, used for various types of cutting machines, specially for built-in cooling circulatory system models	1L
MLP-OL2		2L
MLP-OL3		4L
MLP-OL4		6L
MLP-OL5		10L
MLP-OL6	1. oily mixture, use directly 2. cut water sensitive materials at low speed (high speed cutting machine is prohibited)	1L
MLP-OL7		4L
	3. replace regularly, recommended once a month	



## HOT MOUNTING RESIN

- Suitable for small sample preparation



Code	Color	Description	Package (barrel)
MLP-DR1	black	for common sample preparation, fast grinding speed	0.5kg
MLP-DR2			1kg
MLP-DR3			4kg
MLP-DR4	black	edge protection type, low shrinkage, sample binding, high hardness, good wear resistance, slow grinding speed	0.5kg
MLP-DR5			1kg
MLP-DR6			4kg
MLP-DR7	black	carbon phenolic polymer, used in highly conductive fields, medium grinding speed	0.5kg
MLP-DR8			1kg
MLP-DR9	red	for common sample preparation, fast grinding speed	0.5kg
MLP-DR10			1kg
MLP-DR11	white	for common sample preparation, fast grinding speed	0.5kg
MLP-DR12			1kg
MLP-DR13			4kg
MLP-DR14	green	for common sample preparation, fast grinding speed	0.5kg
MLP-DR15			1kg
MLP-DR16			4kg
MLP-DR17	transparent	transparent, soluble, for sample with size, position, depth and other requirements	0.5kg
MLP-DR18			1kg
MLP-DR19			4kg

## COLD MOUNTING CONSUMABLES



cold mounting resin



curing agent

Code	Description	Package
MLP-CM1	<ol style="list-style-type: none"> <li>1. cold mounting compound, fast speed/good transparency/low viscosity/high strength</li> <li>2. for metal processing without heating, pressure and mounting press</li> <li>3. curing time: 25°C, 25min</li> <li>4. usage: cold mounting resin 3:curing agent 2</li> </ol>	<ol style="list-style-type: none"> <li>1. cold mounting resin 1000g</li> <li>2. curing agent 800ml</li> <li>3. Ø30mm cold mounting mold 1 pc</li> <li>4. plastic cup 20 pcs</li> <li>5. stirring rod 40 pcs, spoon 1 pc</li> </ol>
MLP-CM2	<ol style="list-style-type: none"> <li>1. epoxy resin, low viscosity, good permeability, completely transparent</li> <li>2. for samples which can not be heated or mounting pressed, like PCB, SMT and other micro-slice samples</li> <li>3. curing time: 25°C, 5~6h</li> <li>4. usage: resin liquid 2:curing agent 1</li> </ol>	<ol style="list-style-type: none"> <li>1. resin liquid1000ml</li> <li>2. curing agent 500ml</li> <li>3. Ø30mm cold mounting mold 1 pc</li> <li>4. plastic cup 20 pcs</li> <li>5. stirring rod 40 pcs</li> </ol>
MLP-CM3	<ol style="list-style-type: none"> <li>1. fast epoxy, fast curing products, completely transparent</li> <li>2. for samples which can not be heated or mounting pressed, like PCB, SMT and other micro-slice samples</li> <li>3. curing time: 25°C, 1h</li> <li>4. usage: resin liquid 2:curing agent 1</li> </ol>	<ol style="list-style-type: none"> <li>1. resin liquid1000ml</li> <li>2. curing agent 500ml</li> <li>3. Ø30mm cold mounting mold 1 pc</li> <li>4. plastic cup 20 pcs</li> <li>5. stirring rod 40 pcs</li> </ol>
MLP-CM4	<ol style="list-style-type: none"> <li>1. low viscosity epoxy, good permeability, completely transparent</li> <li>2. for samples which can not be heated or mounting pressed, like PCB, SMT and other micro-slice samples</li> <li>3. curing time: 25°C, 3~4h</li> <li>4. usage: resin liquid 2:curing agent 1</li> </ol>	<ol style="list-style-type: none"> <li>1. resin liquid1000ml</li> <li>2. curing agent 500ml</li> <li>3. Ø30mm cold mounting mold 1 pc</li> <li>4. plastic cup 20 pcs</li> <li>5. stirring rod 40 pcs</li> </ol>
MLP-CM5	<ol style="list-style-type: none"> <li>1. low heat release epoxy, small, shrink, completely transparent</li> <li>2. for samples which can not be heated or mounting pressed, like PCB, SMT and other micro-slice samples</li> <li>3. curing time: 25°C, 20~24h</li> <li>4. usage: resin liquid 3:curing agent 1</li> </ol>	<ol style="list-style-type: none"> <li>1. resin liquid 1000ml,</li> <li>2. curing agent 300ml</li> <li>3. Ø30mm cold mounting mold 1 pc</li> <li>4. plastic cup 20 pcs,</li> <li>5. stirring rod 40 pcs</li> </ol>
MLP-CM6	<ol style="list-style-type: none"> <li>1. cold mounting compound, fast speed/ceramics white/low viscosity/high strength</li> <li>2. for metal processing without heating, pressure and mounting press</li> <li>3. curing time: 25°C, 25min</li> <li>4. usage: cold mounting resin 3:curing agent 2</li> </ol>	<ol style="list-style-type: none"> <li>1. cold mounting resin 1000g</li> <li>2. curing agent 800ml</li> <li>3. Ø30mm cold mounting mold 1 pc</li> <li>4. plastic cup 20 pcs</li> <li>5. stirring rod 40 pcs, spoon 1 pc</li> </ol>

## COLD MOUNTING MOLDS

Code	Description	Specification (mm)
MLP-QM1	round soft mold, for cold embedding of epoxy resin, cold mounting resin on metallographic slice specimens	Ø20×18
MLP-QM2		Ø25×18
MLP-QM3		Ø30×18
MLP-QM4		Ø40×23
MLP-QM5		Ø50×23
MLP-QM6	square soft mold, for cold embedding of epoxy resin, cold mounting resin on metallographic slice specimens	55×20×22
MLP-QM7		70×40×22
MLP-QM8	round hard mold, for cold embedding of epoxy resin, cold mounting resin on metallographic slice specimens	Ø25×23
MLP-QM9		Ø30×27
MLP-QM10		Ø32×27
MLP-QM11		Ø40×29





## MOUNTING DISCHARGING AGENT



Code	Description	Specifications
<b>MLP-RA</b>	for hot mounting press and cold mounting mold discharging	200ml/bottle

**33**

## SLICE CLIPS

**MLP-QP1**

**MLP-QP2**

Code	Description	Specifications
<b>MLP-QP1</b>	stainless steel roll slice clip, for hot and cold mounting fixing	100 pieces/pack
<b>MLP-QP2</b>	PET roll slice clip, for hot and cold mounting fixing	100 pieces/pack

## DIAMOND POLISHING LIQUID

- For surface grinding and polishing of metallographic, lithographic, ferrous and non-ferrous metals, ceramics, composite materials, gems, instruments, optical glass of high finish
- Compared with ordinary polishing agent, under the same grinding and polishing quality, consumption is saved 30%, time is saved 60%



Code	Description	Granularity ( $\mu\text{m}$ )	Package/Bottle
<b>MLP-DLA<math>\square\square</math>*</b>	1. single crystal, water-based, ethylene glycol-based polishing lubricant formulation 2. for general metallographic preparation	40, 30, 28, 20, 14, 10, 9, 7, 6, 5, 3.5, 3, 2.5, 1.5, 1.0, 0.5, 0.25	500ml
<b>MLP-DLB<math>\square\square</math>*</b>	1. single crystal, water-based, propylene glycol-based polishing lubricant formulation 2. for grinding and polishing of soft and ductile materials	30, 20, 15, 14, 9, 7, 6, 5, 3, 2.5, 1.5, 1.0, 0.5, 0.25	500ml
<b>MLP-DLC<math>\square\square</math>*</b>	1. single crystal, water-based, propylene glycol-based polishing lubricant formulation 2. for ultra-precision polishing	0.05	500ml
<b>MLP-DLD<math>\square\square</math>*</b>	1. single crystal, oil-based, solvent-based polishing lubricant formulation 2. for grinding and polishing of soft materials and materials which cannot touch water	20, 14, 9, 7, 5, 3.5, 2.5, 1.5, 1.0, 0.5, 0.25	500ml
<b>MLP-DLE<math>\square\square</math>*</b>	1. polycrystalline, water-based, propylene glycol based polishing lubricant formula 2. for grinding and polishing of different materials and hardness components	9, 6, 3, 1.0, 0.5, 0.25	500ml
<b>MLP-DLF<math>\square\square</math>*</b>	1. polycrystalline, water-based, denatured ethanol based polishing lubricant formula 2. for grinding and polishing of materials which cannot touch water	9, 6, 3, 1.0, 0.5, 0.25	500ml

\*  $\square\square$  is granularity specification, for example, code **MLP-DLA40** stands for diamond polishing liquid 40 $\mu\text{m}$  granularity



**Universal Testing Machines**  
Page 859-865



**High And Low Temperature Test Chambers For Electronic Universal Testing Machines**  
Page 860



**Impact Testing Machines**  
Page 866-867



**Impact Specimen Notch Broaching Machines**  
Page 867



**Universal Push And Pull Testing Machines**  
Page 868



**Digital Spring Testers**  
Page 869



**Force Gages**  
Page 870-874



**Test Stands For Force Gages**  
Page 875-877



**Dial Tension Gages**  
Page 877



**Spindle Tension Meters**  
Page 878

## ELECTRONIC UNIVERSAL TESTING MACHINES

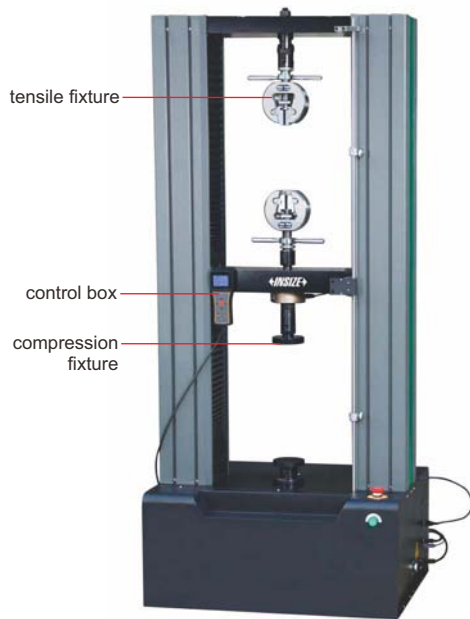

UTM-E50

- For tensile, compression, bend, shear, peel, tear tests of metal and non-metal materials

computer and software (included)

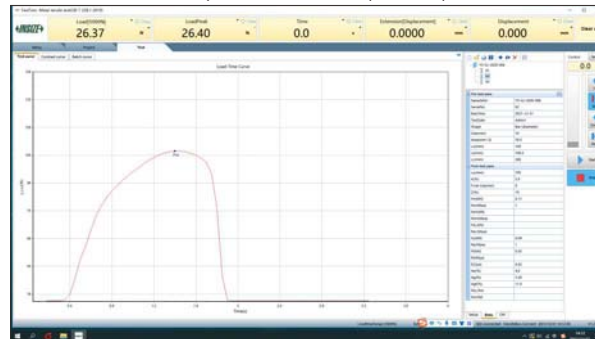

flat jaws (included)



V-shaped jaws (included)

### STANDARD DELIVERY

Main unit	1 pc
Control box	1 pc
Computer	1 pc
Measuring software	1 pc
Printer	1 pc
Wedge tension fixture (including flat jaws and V-shaped jaws) **	1 set
Compression fixture	1 set
Extensometer (only for UTM-E100, UTM-E300)	1 pc

\*\*UTM-E10 does not have V-shaped jaws



### OPTIONAL ACCESSORY

Extensometer	page 865
Fixtures	page 862~863

### SPECIFICATION

Code	UTM-E10	UTM-E50	UTM-E100	UTM-E300
Max. test force	10kN	50kN	100kN	300kN
Accuracy class	0.5 class			
Test force measurement range	0.2%~100%FS			
Test force measurement accuracy	±0.5% of indicating value			
Resolution of test force measurement	1/300000 of Max. test force (same resolution all the way)			
Deformation measurement range	0.2%~100%FS			
Deformation measurement accuracy	±0.5% of indicating value			
Deformation measurement resolution	1/200000 of Max. deformation, up to 1/300000			
Large deformation measurement range	10~800mm			
Large deformation measurement accuracy	±1% of indicating value			
Large deformation measurement resolution	8μm			
Displacement accuracy	±0.5% of indicating value			
Displacement resolution	0.01mm			
Force control speed adjustment range	0.005~5%FS/s			
Force control speed control accuracy	±2% of the set value (speed<0.05%FS/s) ±0.5% of the set value (speed≥0.05%FS/s)			
Deformation speed adjustment range	0.005~5%FS/s			
Deformation speed control accuracy	±2% of the set value (speed<0.05%FS/s) ±0.5% of the set value (speed≥0.05%FS/s)			
Beam displacement speed adjustment range	0.001~500mm/min			
Beam displacement speed control accuracy	±1% of the set value (speed<0.5mm/min) ±0.2% of the set value (speed≥0.5mm/min)			
Crosshead travel *	1030mm	970mm	1250mm	1000mm
Effective compression travel *	800mm	700mm	700mm	600mm
Horizontal test space *	400mm	440mm	600mm	550mm
Power supply	220V, 50Hz, 0.4kW~1kW		380V, 50Hz, 2kW~5kW	
Dimension	715×500×1680mm	820×620×1880mm	1070×855×2180mm	1070×920×2550mm
Weight	230kg	350kg	1000kg	1500kg

\*Can be customized according to test requirements

## HIGH AND LOW TEMPERATURE TEST CHAMBERS FOR ELECTRONIC UNIVERSAL TESTING MACHINES



34



electronic universal testing machine is optional

UTT-M63-E50

- For **UTM-E□□□** electronic universal testing machines
- For tensile, compression, bend, shear tests in high and low temperature environment

### SPECIFICATION

Code	for UTM-E10	UTT-M03-E10	UTT-M33-E10	UTT-M63-E10
	for UTM-E50	UTT-M03-E50	UTT-M33-E50	UTT-M63-E50
	for UTM-E100	UTT-M03-E100	UTT-M33-E100	UTT-M63-E100
Temperature range		(room temperature+10)~300°C	-30~300°C	-60~300°C
Temperature accuracy *		±1°C		
Temperature fluctuation *		±0.5°C		
Temperature uniformity *		≤2°C		
Temperature resolution		0.1°C		
Cooling system		no	compressor or liquid nitrogen	
Cooling time (room temperature@25°C)			1~2°C/min (no-load)	
Warming up time		1~3°C/min (no-load)		
Temperature control		PID automatic temperature control		
Heating system		magnesium powder heating tube		
Aperture size		Ø50mm		
Chamber dimension **		240×430×530mm (suitable for electronic universal testing machines with column spacing of 400mm and above)		
Power supply		AC 220V, 60Hz		
Total power		1.8kW	2.2kW	2.8kW

\*The applicable range of temperature accuracy, uniformity and fluctuation is Ø100×200mm

\*\* Customized according to **UTM-E□□□** electronic universal testing machine and customer requirements

## ELECTRONIC UNIVERSAL TESTING MACHINES

computer and software (included)

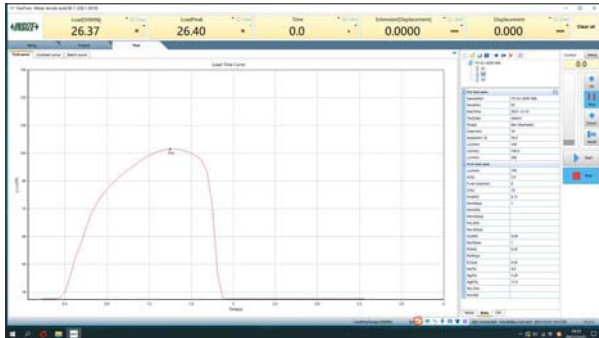

UTM-S5KA

- For tensile, peel, tear tests of metal and non-metal materials

### STANDARD DELIVERY

Main unit	1 pc
Control box	1 pc
Computer	1 pc
Measuring software	1 pc
Printer	1 pc
Tensile fixture	1 set

### OPTIONAL ACCESSORY

Extensometer	page 865
Fixtures	page 862~863

### SPECIFICATION

Code	UTM-S200A	UTM-S500A	UTM-S1KA	UTM-S2KA	UTM-S5KA
Max. test force	200N	500N	1kN	2kN	5kN
Accuracy class	0.5 class				
Test force measurement range	0.4%~100%FS				
Test force measurement accuracy	±0.5% of indicating value				
Resolution of test force measurement	1/300000 of Max. test force (same resolution all the way)				
Deformation measurement range	0.2%~100%FS				
Deformation measurement accuracy	±0.5% of indicating value				
Deformation measurement resolution	1/200000 of Max. deformation, up to 1/300000				
Large deformation measurement range	10~800mm				
Large deformation measurement accuracy	±1% of indicating value				
Large deformation measurement resolution	8μm				
Displacement accuracy	±0.5% of indicating value				
Displacement resolution	0.01mm				
Force control speed adjustment range	0.005~5%FS/s				
Force control speed control accuracy	±2% of the set value (speed<0.05%FS/s) ±0.5% of the set value (speed≥0.05%FS/s)				
Deformation speed adjustment range	0.005~5%FS/s				
Deformation speed control accuracy	±2% of the set value (speed<0.05%FS/s) ±0.5% of the set value (speed≥0.05%FS/s)				
Beam displacement speed adjustment range	0.001~500mm/min				
Beam displacement speed control accuracy	±1% of the set value (speed<0.5mm/min) ±0.2% of the set value (speed≥0.5mm/min)				
Crosshead travel*	900mm				
Effective compression travel*	630mm				
Power supply	220V, 50Hz, 0.4kW~1kW				
Dimension	510×510×1580mm				
Weight	150kg				















\*Can be customized according to test requirements

# FIXTURES FOR ELECTRONIC UNIVERSAL TESTING MACHINES

CUSTOM-MADE

Used with **UTM-E** series and **UTM-S** series electronic universal testing machines

34

<p><b>UTM-F001</b></p> <ul style="list-style-type: none"> <li>Wedge tensile fixture</li> <li>For tensile testing of non-metallic materials and thin metal specimens</li> </ul> 	<p><b>UTM-F002</b></p> <ul style="list-style-type: none"> <li>Hydraulic tensile fixture</li> <li>For tensile testing of metallic materials, round bar specimens</li> </ul> 	<p><b>UTM-F003</b></p> <ul style="list-style-type: none"> <li>10kN wedge tensile fixture</li> <li>For tensile testing of metal specimens</li> </ul> 
<p><b>UTM-F004</b></p> <ul style="list-style-type: none"> <li>Pneumatic tensile fixture</li> <li>For tensile testing of non-metallic material specimens</li> </ul> 	<p><b>UTM-F005</b></p> <ul style="list-style-type: none"> <li>Insulation profile longitudinal shearing fixture</li> <li>Longitudinal shear test for insulation type materials</li> </ul> 	<p><b>UTM-F006</b></p> <ul style="list-style-type: none"> <li>Insulation profile transverse tensile fixture</li> <li>For transverse tensile testing of insulation-type materials</li> </ul> 
<p><b>UTM-F007</b></p> <ul style="list-style-type: none"> <li>Filament winding fixture</li> <li>For tensile testing of data wires, textile fabric wires, plastic wires</li> </ul> 	<p><b>UTM-F008</b></p> <ul style="list-style-type: none"> <li>Filament opposite fixture</li> <li>For tensile testing of wire specimens</li> </ul> 	<p><b>UTM-F009</b></p> <ul style="list-style-type: none"> <li>Pneumatic threadlet tensile fixture</li> <li>For tensile testing of non-metallic wire specimens</li> </ul> 
<p><b>UTM-F010</b></p> <ul style="list-style-type: none"> <li>Steel wire tensile fixture</li> <li>For tensile testing of fine steel wires and iron wires</li> </ul> 	<p><b>UTM-F011</b></p> <ul style="list-style-type: none"> <li>Threadlet winding fixture</li> <li>For tensile testing of filamentary metal specimens</li> </ul> 	<p><b>UTM-F012</b></p> <ul style="list-style-type: none"> <li>Fabric belt winding tensile fixture</li> <li>For tensile testing of non-metallic material specimens</li> </ul> 
<p><b>UTM-F013</b></p> <ul style="list-style-type: none"> <li>Film tensile fixture</li> <li>For tensile testing of paper, film and non-metallic materials</li> </ul> 	<p><b>UTM-F014</b></p> <ul style="list-style-type: none"> <li>Film tensile fixture</li> <li>For tensile testing of paper, film and non-metallic materials</li> </ul> 	<p><b>UTM-F015</b></p> <ul style="list-style-type: none"> <li>Thin film opposite fixture</li> <li>For tensile testing of paper, film and non-metallic materials</li> </ul> 

To be continued

Continued from previous page

<p><b>UTM-F016</b></p> <ul style="list-style-type: none"> <li>Thin plate opposite fixture</li> <li>For tensile testing of thin plates of non-metallic materials</li> </ul> 	<p><b>UTM-F017</b></p> <ul style="list-style-type: none"> <li>Annule tensile fixture</li> <li>For tensile testing of non-metallic annular material specimens</li> </ul> 	<p><b>UTM-F018</b></p> <ul style="list-style-type: none"> <li>Adhesive tensile shearing fixture</li> <li>For tensile shear testing of different adhesive specimens</li> </ul> 
<p><b>UTM-F019</b></p> <ul style="list-style-type: none"> <li>Surface bonding strength fixture</li> <li>Tensile testing for adhesive properties</li> </ul> 	<p><b>UTM-F020</b></p> <ul style="list-style-type: none"> <li>Leverage tensile fixture</li> <li>For tensile testing of rubber, silicone and other elastomers</li> </ul> 	<p><b>UTM-F021</b></p> <ul style="list-style-type: none"> <li>Rubber tensile fixture</li> <li>Specialized for tensile testing of rubber material specimens</li> </ul> 
<p><b>UTM-F022</b></p> <ul style="list-style-type: none"> <li>90° rubber peel fixture</li> <li>Peel test for adhesion of rubber materials</li> </ul> 	<p><b>UTM-F023</b></p> <ul style="list-style-type: none"> <li>PCB plate 90° peel fixture</li> <li>Peel-off test for adhesion of sticky materials on PCBs</li> </ul> 	<p><b>UTM-F024</b></p> <ul style="list-style-type: none"> <li>Plastic bending fixture</li> <li>Specialized for flexural testing of plastic specimens</li> </ul> 
<p><b>UTM-F025</b></p> <ul style="list-style-type: none"> <li>Three-point bending fixture</li> <li>For bending test of various material specimens</li> </ul> 	<p><b>UTM-F026</b></p> <ul style="list-style-type: none"> <li>Waving fixture</li> <li>For tensile testing of non-metallic specimens</li> </ul> 	<p><b>UTM-F027</b></p> <ul style="list-style-type: none"> <li>Butt fixture</li> <li>For tensile testing of different materials</li> </ul> 
<p><b>UTM-F028</b></p> <ul style="list-style-type: none"> <li>Shear fixture</li> <li>For shear testing of different materials</li> </ul> 	<p><b>UTM-F029</b></p> <ul style="list-style-type: none"> <li>Ceramic shearing fixture</li> <li>Specialized for shear testing of ceramic materials</li> </ul> 	<p><b>UTM-F030</b></p> <ul style="list-style-type: none"> <li>Compressive fixture</li> <li>For compression testing of different materials</li> </ul> 
<p><b>UTM-F031</b></p> <ul style="list-style-type: none"> <li>Puncture fixture</li> <li>For film puncture testing</li> </ul> 		

# HYDRAULIC UNIVERSAL TESTING MACHINES

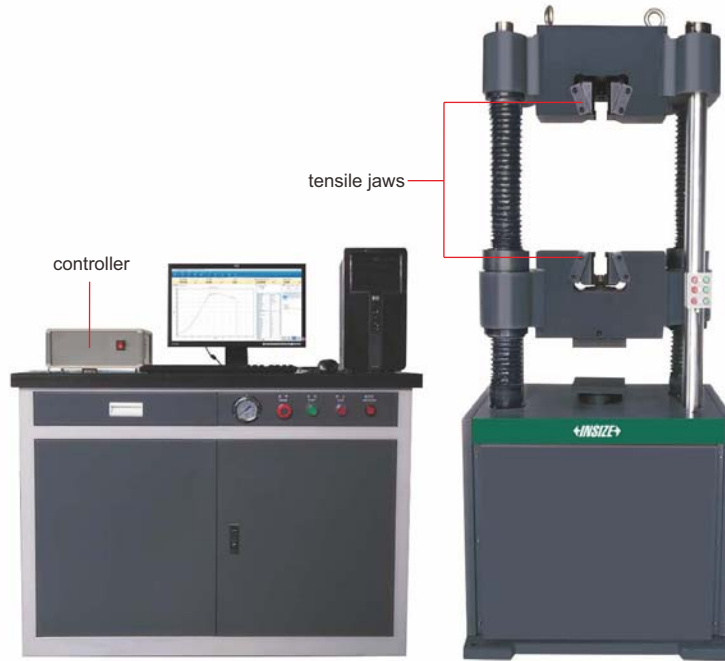

UTM-H300B

- For tensile, compression, bend, shear tests of metal and non-metal materials

### SPECIFICATION

Code	UTM-H300B	UTM-H600B	UTM-H1000B	UTM-H2000B	UTM-H3000B	
Max. test force	300kN	600kN	1000kN	2000kN	3000kN	
Accuracy	±1%					
Test force measurement range	2%~100%FS					
Resolution of test force measurement	1/300000 of Max. test force (same resolution all the way)					
Deformation measurement device	extensometer					
Deformation measurement range	1%~100%FS					
Deformation measurement accuracy	±1%					
Deformation measurement resolution	1/300000					
Displacement accuracy	±1%					
Displacement resolution	0.01mm					
Displacement travel	200mm					
Max tensile space (including piston stroke)	600mm	600mm	680mm	600mm	900mm	
Max compression space (including piston stroke)	500mm	500mm	560mm	500mm	800mm	
Transmission mode	chain drive					
Safety protection device	software protection and mechanical limit protection					
Control function	special software, closed-loop of stress, strain and velocity					
Clamping range of round sample	Ø10~32mm	Ø13~40mm	Ø13~60mm	Ø20~70mm	Ø25~80mm	
Clamping range of flat sample	0~15mm	0~15mm*	0~20mm**	0~40mm	0~80mm	
Upper and lower pressure plate size	Ø188mm	Ø188mm	Ø208mm	Ø208mm	Ø208mm	
Bending branch roll width	140mm					
Total power	2.5kW	3.0kW	3.0kW	3.75kW	5.5kW	
Power supply	380V, 50Hz					
Dimension (mm)	host	800×620×1900	820×650×2000	940×780×2250	1100×760×3000	1250×930×3550
	oil source	1140×600×855				
Weight	2T	2.2T	3T	7.5T	12.6T	

\*Customizable 0~30mm

\*\*Customizable 0~40mm

To be continued



Continued from previous page

computer and software (included)

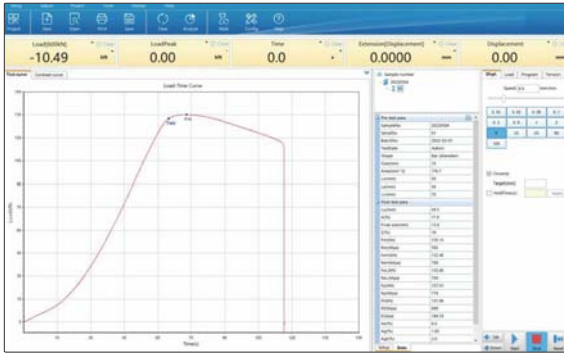

**STANDARD DELIVERY**

Main unit	1 pc
Electro hydraulic servo oil source	1 pc
Electro hydraulic servo valve	1 pc
High pressure oil pump	1 pc
Oil pressure sensor	1 pc
Control box	1 pc
Extensometer	1 pc
Computer	1 pc
Measuring software	1 set
Printer	1 pc
Tensile fixture	1 set
Compression fixture	1 set



acrylic safety shield (optional)



steel wire safety shield (optional)

**OPTIONAL ACCESSORY**

Acrylic safety shield	UTM-H-COVER1
Steel wire safety shield	UTM-H-COVER2

**EXTENSOMETERS**

- Used with universal testing machines

**SPECIFICATION**

Code	Gage length	Deformation
UTM-EX25-5	25mm	5mm
UTM-EX25-10	25mm	10mm
UTM-EX25-25	25mm	25mm
UTM-EX50-5	50mm	5mm
UTM-EX50-10	50mm	10mm
UTM-EX50-25	50mm	25mm
UTM-EX100-5	100mm	5mm
UTM-EX100-10	100mm	10mm
UTM-EX100-25	100mm	25mm
UTM-EX200-5	200mm	5mm
UTM-EX200-10	200mm	10mm
UTM-EX200-25	200mm	25mm
UTM-EX-B	large deformation, customized according to the workpieces	

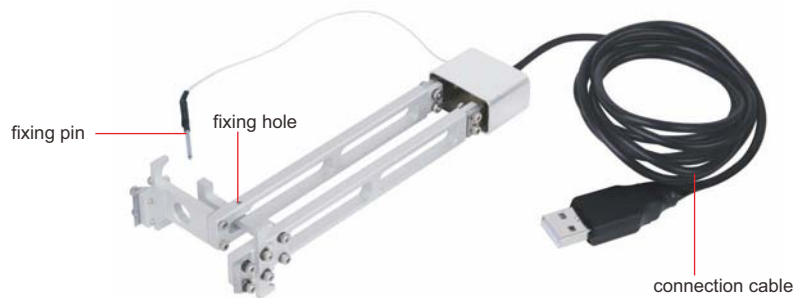

UTM-EX50-10

## SEMI-AUTOMATIC IMPACT TESTING MACHINES



pendulum (included)



span aligner (included)

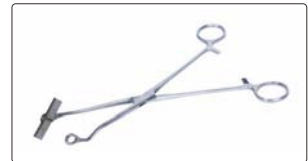

tongs (included)

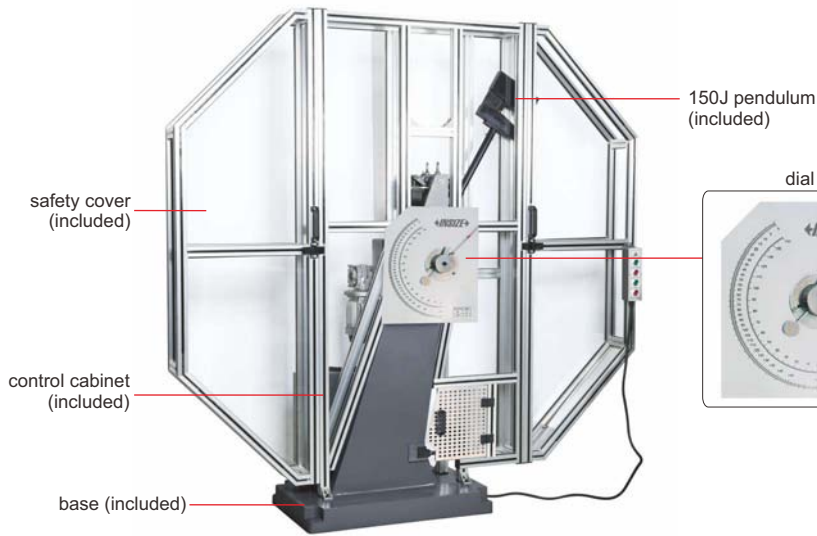

ITM-S150J



dial

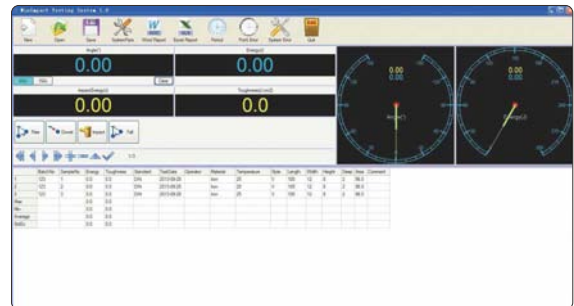

software (included)

- According to ISO148
- For testing the anti-impact performance of metal materials under dynamic load
- High-precision bearings, small bearing friction, the impact absorption rate of empty pendulum is less than 0.3%
- Alloy steel impact blade, hardness HRC60
- PLC controller with built-in energy loss correction program
- Supplied with safety cover
- Supplied with software for data storage, automatic processing, etc.
- Data can be stored in Excel format, output and printed

### SPECIFICATION

Code	ITM-S150J	ITM-S300J	ITM-S450J	ITM-S600J	ITM-S750J
Impact energy	150J	300J	450J	600J	750J
Dial range	0~150J	0~300J	0~450J	0~600J	0~750J
Dial graduation	1J	2J	3J	4J	5J
Pendulum moment	M=80.3848N·m	M=160.7695N·m	M=241.1543N·m	M=321.5390N·m	M=401.9238N·m
Pendulum preparing angle	150°				
Distance between pendulum shaft center and specimen center	750mm				
Impact speed	5.24m/s				
Span of specimen seat	40mm				
End face radius of specimen seat	R (1.0~1.5)mm				
Radius of impact blade	R (2.0~2.5)mm				
Inclination angle of support surface of specimen seat	11°±1°				
Angle of impact blade	30°±1°				
Thickness of impact blade	16mm				
Range of measuring angle	0~360°				
Angle resolution	≤0.06°				
Specimen size	10×10×55mm				
Power supply	AC 380V, 50Hz				
Base size	800×500mm		960×650mm		
Power	400W		1.5kW		
Dimension of main body	2050×690×2015mm		2100×835×2200mm		
Weight	450kg		900kg		

To be continued

Continued from previous page

**STANDARD DELIVERY**

Main unit		1 pc
Dial		1 pc
Control cabinet		1 pc
Pendulum	ITM-S150J	150J pendulum
	ITM-S300J	300J pendulum and 150J pendulum
	ITM-S450J	450J pendulum and 150J pendulum
	ITM-S600J	600J pendulum and 150J pendulum
	ITM-S750J	750J pendulum and 150J pendulum
Simply supported beam fixture (including jaws, anvil)		1 set
Computer		1 set
Printer		1 pc
Software		1 set
Span aligner		1 pc
Tongs		1 pc
Safety cover		1 set

**OPTIONAL ACCESSORY**

Workbench		7911-15
150J pendulum		ITM-S-PE150J
300J pendulum		ITM-S-PE300J
450J pendulum		ITM-S-PE450J
600J pendulum		ITM-S-PE600J
750J pendulum		ITM-S-PE750J
ASTM standard impact blade		ITM-S-ASTM-IB
Sample recovery device		ITM-S-RD
Digital display screen		ITM-S-DDS



**IMPACT SPECIMEN NOTCH BROACHING MACHINE (DOUBLE BROACHES)  
CODE ITM-U32**

- Conforms with ISO 148, ISO 83 and EN 10045 standards
- One-time broaching forming, hydraulic transmission, special internal lubrication device to avoid damage of the broaches
- Dual-station broach, two specimen notches can be processed at the same time



raised broaches



lowered broaches



ITM-U32

**SPECIFICATION**

Broach stroke	350mm (V2, U2, U3 broaches) 400mm (U5 broach)
Specimen size (T×W×L)	10×10×55mm
Broaching speed	0.35-2.5m/min
Driving method	hydraulic
Power supply	380V, 50Hz, 0.4kW
Dimension	660×400×1200mm
Weight	200kg

**STANDARD DELIVERY**

Main unit	1 pc
Broach	U2 and V2

**OPTIONAL ACCESSORY**

U3 broach	ITM-U32-U3
U5 broach	ITM-U32-U5

## UNIVERSAL PUSH AND PULL TESTING MACHINES



34



ISF-U202

- Set force, set positioning and set deformation testing modes
- Protective functions of built-in mechanical limit, overload auto stop and emergency stop
- Dual-speed preset, high-speed approximation and low-speed acquisition
- Automatic back to start location after the test
- Can save 10 sets of test value and 3 sets of curve, test reports can be printed by built-in printer
- Display peak value, real-time value and process curve simultaneously
- Auto calibration of displacement zero
- Unit: lbf, N, kgf, ozf
- Auto power off (the time can be set)

### SPECIFICATION

Code	ISF-U055	ISF-U101	ISF-U202
Max. test force	500N	1000N	2000N
Resolution of force	0.05N	0.1N	0.2N
Test force measurement range	1%~100%FS		
Test force measurement accuracy	±1%FS (test force<10%FS) ±0.5%FS (test force≥10%FS)		
Range of adjustable speed	0.5~500mm/min		
Speed accuracy	±2%FS (speed<10%FS) ±1%FS (speed≥10%FS)		
Displacement resolution	0.001mm		
Displacement travel	300mm	450mm	450mm
Displacement accuracy	±0.4mm		
Unit	lbf, N, kgf, ozf		
Pressure plate size	Ø80mm		
Power supply	AC 220V, 50/60Hz		
Dimension	420×250×700mm	365×305×915mm	365×305×915mm
Weight	29.4kg	40kg	40kg

### STANDARD DELIVERY

Main unit	1 pc
Adapter	2 pcs

**DATA  
OUTPUT**

- Peak hold and automatic release function
- Set upper and lower limits, red and green indicator and buzzer alarm
- Automatic conversion of three units: N, kgf, lbf
- Built in printer
- Automatic power off

**ISF-S10**

**ISF-S500**

**ISF-S1000**
**SPECIFICATION**

Code	ISF-S10	ISF-S20	ISF-S30	ISF-S50	ISF-S100	ISF-S200
Maximum load	10N	20N	30N	50N	100N	200N
Resolution	0.001N	0.002N	0.01N	0.01N	0.02N	0.05N
Range of digital scale	65mm	65mm	65mm	95mm	95mm	95mm
Resolution of digital scale	0.01mm	0.01mm	0.01mm	0.01mm	0.01mm	0.01mm
Disk diameter	Ø30mm	Ø30mm	Ø30mm	Ø49mm	Ø49mm	Ø49mm
Maximum free length of spring	65mm	65mm	65mm	95mm	95mm	95mm
Measuring range of force	5%~100% (maximum load)					
Accuracy of force	±1% (maximum load)					
Data output	RS232					
Power supply	220V, 50/60Hz					
Dimension	300×235×600mm	300×235×600mm	300×235×600mm	300×235×620mm	300×235×620mm	300×235×620mm
Weight	13.2kg	13.2kg	13.2kg	17.3kg	19.1kg	19.1kg

Code	ISF-S300	ISF-S500	ISF-S1000	ISF-S2000	ISF-S5000
Maximum load	300N	500N	1000N	2000N	5000N
Resolution	0.1N	0.1N	0.2N	0.5N	1N
Range of digital scale	95mm	95mm	150mm	150mm	150mm
Resolution of digital scale	0.01mm	0.01mm	0.01mm	0.01mm	0.01mm
Disk diameter	Ø49mm	Ø49mm	Ø108mm	Ø108mm	Ø108mm
Maximum free length of spring	95mm	95mm	200mm	200mm	200mm
Measuring range of force	5%~100% (maximum load)				
Accuracy of force	±1% (maximum load)				
Data output	RS232				
Power supply	220V, 50/60Hz				
Dimension	300×235×620mm	300×235×620mm	490×300×920mm	490×300×920mm	490×300×920mm
Weight	19.1kg	20.8kg	47.5kg	47.5kg	47.5kg

**STANDARD DELIVERY**

Main unit	1 pc
-----------	------

## DIGITAL FORCE GAGES (HIGH ACCURACY)

DATA  
OUTPUT

INSIZE  
INSPECTION  
CERTIFICATE

34



software flash disk  
(included)

printer (optional)



ISF-DF100A  
type A



ISF-DF5KA  
type B



ISF-DF10KC  
type C

- Type A and B can be used for tension and pressure tests, type C is only used for pressure tests
- Peak (max.) and tracking mode
- Units for type A: mN, N, gf, kgf, ozf, lbf, type B: N, kgf, lbf, kN, MPa, type C: N, kgf, lbf, kN, tf, MPa
- Tolerance testing
- 1000 memories
- Automatic power off
- Metal case, touch buttons
- LCD display with backlight
- The display flips over when the bottom faces up
- Overload alarm
- Keyboard signal, can be transmitted to Excel



VIDEO

accessory for type B (included)



flat push tip

adapter

pull clamps

accessory for type A (included)

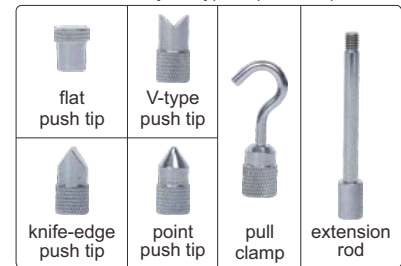

flat  
push tip

V-type  
push tip

knife-edge  
push tip

point  
push tip

pull  
clamp

extension  
rod

### SPECIFICATION

Code	ISF-DF5A	ISF-DF10A	ISF-DF20A	ISF-DF50A	ISF-DF100A	ISF-DF200A	ISF-DF500A	ISF-DF1KA
Type	A (internal sensor)							
Load capacity (N)	5	10	20	50	100	200	500	1000
Resolution (N)	0.0005	0.001	0.005	0.005	0.01	0.05	0.05	0.1
Accuracy	±0.2% (of load capacity)							
Power supply	built-in rechargeable battery							

Code	ISF-DF1KB	ISF-DF2KA	ISF-DF5KA	ISF-DF10KA	ISF-DF20KA
Type	B (external sensor)				
Load capacity (N)	1000	2000	5000	10000	20000
Resolution (N)	0.1	0.5	0.5	1	5
Accuracy	±0.2% (of load capacity)				
Power supply	built-in rechargeable battery				

Code	ISF-DF10KC	ISF-DF20KC	ISF-DF50KC	ISF-DF100KC	ISF-DF200KC
Type	C (external sensor)				
Load capacity (kN)	10	20	50	100	200
Resolution (kN)	0.001	0.005	0.005	0.01	0.05
Accuracy	±0.2% (of load capacity)				
Power supply	built-in rechargeable battery				

### STANDARD DELIVERY

Main unit	1 pc	
AC/DC adapter	1 pc	
Software and USB cable	1 pc	
Push/pull accessory	type A	6 pcs (flat push tip, V-type push tip, knife-edge push tip, point push tip, pull clamp, extension rod)
	type B	4 pcs (flat push tip, adapter, pull clamps)

### OPTIONAL ACCESSORY

Printer	ISF-DF-PRINTER
Test stand	ISF-MT1K

## FORCE GAGE HANDLES CODE ISF-DFAT1

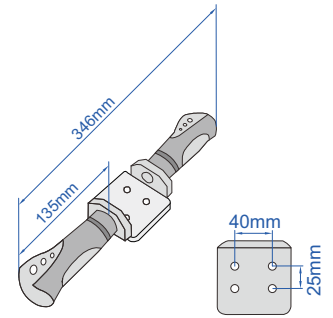

- For digital force gages (code **ISF-DF**□□□)
- Push and pull test
- Maximum range 1000N

### STANDARD DELIVERY

Handle	2 pcs
Base	1 pc

push test with single handle



pull test with two handles



## SOFT PROBES FOR HUMAN BODY



ISF-DFAT2-C1

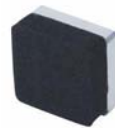

ISF-DFAT2-C2



ISF-DFAT2-C3



ISF-DFAT2-C4

- To measure muscle force
- For press test with digital force gages (code **ISF-DF**□□□) and force gage handles (code **ISF-DFAT1**)
- Maximum range 1000N

Code	Specification
ISF-DFAT2-C1	rectangle, 90×25mm, M6
ISF-DFAT2-C2	square, 25×25mm, M6
ISF-DFAT2-C3	arc-shaped, 90×25mm, R80mm, M6
ISF-DFAT2-C4	M6

application



## DIGITAL FORCE GAGES

DATA  
OUTPUT

INSPECTION  
CERTIFICATE



software flash disk  
(included)



ISF-1DF100



VIDEO

printer (optional)



accessory (included)

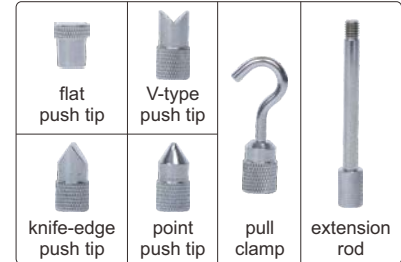

- Push and pull test
- Units: N, gf, kgf, ozf, lbf
- 500 memories
- Automatic power off
- Metal case
- LCD display with backlight
- The display flips over when the bottom faces up
- Overload alarm

### SPECIFICATION

Code	ISF-1DF10	ISF-1DF50	ISF-1DF100	ISF-1DF500	ISF-1DF1000
Load capacity (N)	10	50	100	500	1000
Resolution (N)	0.01	0.01	0.1	0.1	1
Accuracy	±0.3% (of load capacity)				
Measuring mode	tracking, peak (max.), tolerance testing				
Power supply	built-in rechargeable battery				
Dimension	150×73×33mm				
Weight	450g				

### STANDARD DELIVERY

Main unit	1 pc
AC/DC adapter	1 pc
Software and USB cable	1 pc
Push/pull accessory	6 pcs (flat push tip, V-type push tip, knife-edge push tip, point push tip, pull clamp, extension rod)

### OPTIONAL ACCESSORY

Printer	ISF-DF-PRINTER
Test stand	ISF-MT1K

## TEST STAND FOR DIGITAL FORCE GAGES CODE ISF-MT1K

- For digital force gages (code ISF-1DF□□□ and ISF-DF□□□)
- To be used in vertical and horizontal orientation

### SPECIFICATION

Load capacity	1000N
Travel	200mm (3mm vertical movement per revolution of handwheel)
Dimension	196×250×446mm
Weight	13kg

### OPTIONAL ACCESSORY

Digital scale (range: 200mm, resolution: 0.01mm/0.0005")	ISF-MT1K-SCALE
--	----------------

force gage  
is optional



VIDEO



digital scale (optional)



horizontal orientation test





FORCE GAGES



ISF-F500

- Push and pull test
- Peak (max.) or tracking mode

accessory (included)

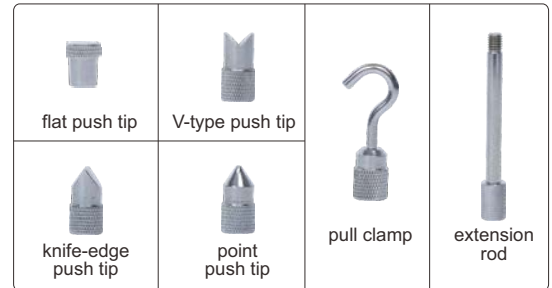

SPECIFICATION

Code		ISF-F10	ISF-F20	ISF-F30	ISF-F50	ISF-F100	ISF-F200	ISF-F300	ISF-F500
Capacity	N	10	20	30	50	100	200	300	500
	kgf	1	2	3	5	10	20	30	50
Graduation	N	0.05	0.1	0.2	0.25	0.5	1	2	2.5
Accuracy		±1% (of load capacity)							

STANDARD DELIVERY

Main unit	1 pc
Push tip	4 pcs (flat, V-type, knife-edge, point)
Pull clamp	1 pc
Extension rod	1 pc

OPTIONAL ACCESSORY

Test stand	ISF-MT500
------------	-----------



TEST STAND FOR FORCE GAGE  
CODE ISF-MT500

- For force gages (code ISF-F□□□)
- To be used in vertical and horizontal orientation

force gage is optional



horizontal orientation test

SPECIFICATION

Load capacity	500N
Travel	150mm (3mm vertical movement per revolution of handwheel)
Dimension	160×240×460mm
Weight	12kg

## PUSH TIPS AND PULL CLAMPS FOR FORCE GAGES

■ For force gages (code ISF-DF□□□, ISF-1DF□□□ and ISF-F□□□)

Unit: mm

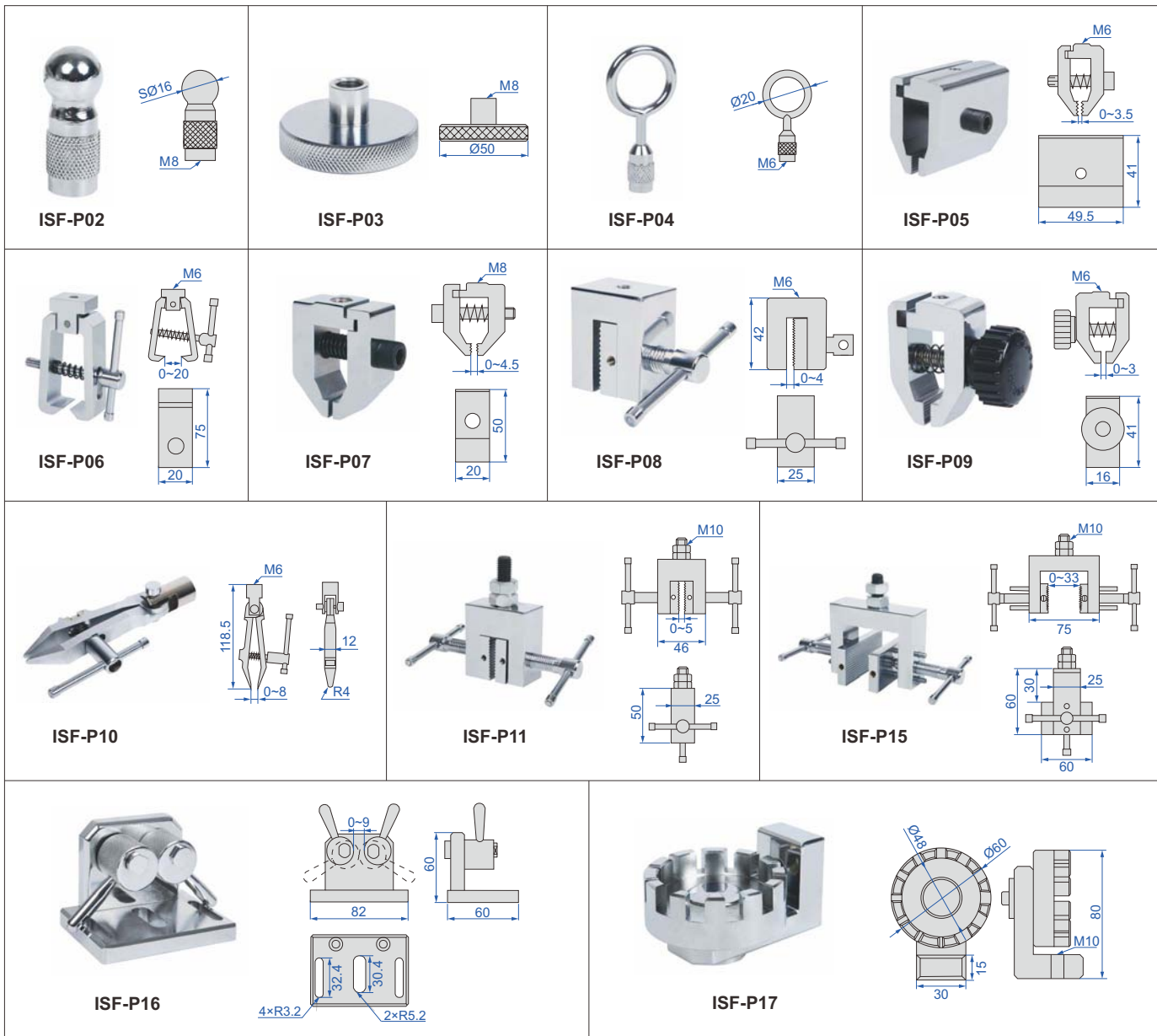

### Push tips

Code	Max. load	Diameter	Weight
ISF-P02	5000N	16mm	33g
ISF-P03	3000N	50mm	17g

### Pull ring

Code	Max. load	Diameter	Weight
ISF-P04	500N	16mm	158g

### Special pull clamps

Code	Max. load	Opening size	Application	Weight
ISF-P16	2400N	0~9mm	for wire pull test	803g
ISF-P17	5000N	1.8~8.4mm	for wire terminal pull test	620g

### Pull clamps

Code	Max. load	Jaw opening	Jaw width	Weight
ISF-P05	1100N	0~3.5mm	49.5mm	241g
ISF-P06	1000N	0~20mm	20mm	217g
ISF-P07	500N	0~4.5mm	20mm	190g
ISF-P08	500N	0~4mm	25mm	274g
ISF-P09	140N	0~3mm	16mm	87g
ISF-P10	230N	0~8mm	4mm	173g
ISF-P11	1500N	0~5mm	25mm	484g
ISF-P15	2000N	0~33mm	60mm	742g



## MOTORIZED VERTICAL TEST STAND CODE ISF-RV61

- For digital force gages (code **ISF-1DF** and **ISF-DF**)
- Push and pull test
- Automatic and manual test
- Programmable automatic operation (automatic cycle)
- Four operation modes: displacement cycle (D cycle), force cycle (F cycle), demo (teaching & playback) mode and positioning mode
- Alarm indications: stroke overrange alarm, force overrange alarm, motor block alarm

### SPECIFICATION

Load capacity	650N (250lbf, 65kg)
Max. travel	220mm
Resolution of displacement	0.01mm
Accuracy of displacement	±0.3mm
Range of adjustable speed	30~720mm/min
Resolution of speed	1mm/min
Accuracy of speed	±2%
Data output	USB, RS232
Work temperature and relative humidity	10~40°C, 10%~80%RH
Power supply	100~230V
Dimension	340×180×630mm
Weight	15.5kg

digital force gage  
is optional



### STANDARD DELIVERY

Test stand	1 pc
AC/DC adapter	1 pc
MD8 cable (for force gages)	1 pc
Software and USB cable	1 pc



## MOTORIZED HORIZONTAL TEST STAND CODE ISF-RH62

- For digital force gages (code **ISF-1DF** and **ISF-DF**)
- Push and pull test
- Automatic and manual test
- Programmable automatic operation (automatic cycle)
- Four operation modes: displacement cycle (D cycle), force cycle (F cycle), demo (teaching & playback) mode and positioning mode
- Alarm indications: stroke overrange alarm, force overrange alarm, motor block alarm

### SPECIFICATION

Load capacity	650N (250lbf, 65kg)
Max. travel	220mm
Resolution of displacement	0.01mm
Accuracy of displacement	±0.3mm
Range of adjustable speed	30~720mm/min
Resolution of speed	1mm/min
Accuracy of speed	±2%
Data output	USB, RS232
Work temperature and relative humidity	10~40°C, 10%~80%RH
Power supply	100~230V
Dimension	671×120×278mm
Weight	13kg

digital force gage  
is optional



### STANDARD DELIVERY

Test stand	1 pc
AC/DC adapter	1 pc
MD8 cable (for force gages)	1 pc
Software and USB cable	1 pc

## MANUAL VERTICAL TEST STANDS FOR FORCE GAGES

ATTENTION:  
ONLY FOR PRESS TEST

- For press test with force gages



VIDEO

force gage  
is optional



ISF-V10A

### SPECIFICATION

Code	ISF-V10A	ISF-V10D
Apply to	dial force gages (code ISF-F□□□)	digital force gages (code ISF-1DF□□□ and ISF-DF□□□)
Load capacity	500N	
Maximum workpiece height	280mm	
Travel	70mm	
Dimension	152×235×425mm	
Weight	10.7kg	

## MANUAL HORIZONTAL TEST STANDS FOR FORCE GAGES

ATTENTION:  
ONLY FOR PULL TEST

- For pull test with force gages



VIDEO

force gage  
is optional



ISF-H20A

### SPECIFICATION

Code	ISF-H20A	ISF-H20D
Apply to	dial force gages (code ISF-F□□□)	digital force gages (code ISF-1DF□□□ and ISF-DF□□□)
Load capacity	500N	
Travel	60mm	
Dimension	450×185×170mm	
Weight	9kg	

## MANUAL HORIZONTAL TEST STAND FOR FORCE GAGES CODE ISF-MH2

- For force gages (code ISF-F□□□, ISF-DF□□□ and ISF-1DF□□□)
- Push and pull test



VIDEO

force gage  
is optional



### SPECIFICATION

Load capacity	1000N
Travel	250mm (1.5mm horizontal movement per revolution of handwheel)
Dimension	542×189×278mm
Weight	21.5kg



VIDEO

## MANUAL STRIPPING FORCE TEST STANDS

- For stripping force test with force gages



ISF-P30A

### SPECIFICATION

Code	ISF-P30A	ISF-P30D
Apply to	dial force gages (code ISF-F□□□)	digital force gages (code ISF-1DF□□□ and ISF-DF□□□)
Load capacity	500N	
Horizontal travel	170mm	
Dimension	420×215×480mm	
Weight	22kg	



VIDEO

- Clockwise and counter-clockwise use
- For electronic and precision mechanical industry, such as test the contact pressure of relay, adjust the tension or compression of spring

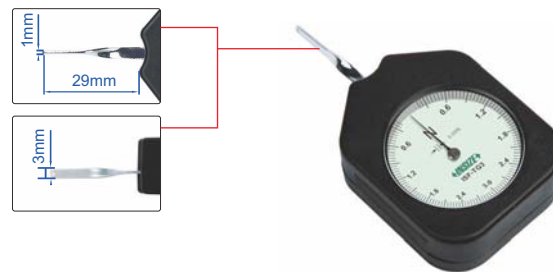

ISF-TG3

## DIAL TENSION GAGES

### SPECIFICATION (Unit: N)

Code	ISF-TGD1	ISF-TGD3	ISF-TGD5	ISF-TG1	ISF-TG1D5	ISF-TG3	ISF-TG5
Range (N)	0.01~0.1	0.03~0.3	0.05~0.5	0.1~1	0.15~1.5	0.3~3	0.5~5
Graduation (N)	0.002	0.005	0.01	0.02	0.025	0.05	0.1
Accuracy	±2% (full scale)						
Dimension (L×W×H)	90×47×19mm						
Weight	60g						

### SPECIFICATION (Unit: gf)

Code	ISF-TG10	ISF-TG30	ISF-TG50	ISF-TG100	ISF-TG150	ISF-TG300	ISF-TG500
Range (gf)	1~10	3~30	5~50	10~100	15~150	30~300	50~500
Graduation (gf)	0.2	0.5	1	2	2.5	5	10
Accuracy	±2% (full scale)						
Dimension (L×W×H)	90×47×19mm						
Weight	60g						

## SPINDLE TENSION METERS



RFS-BT40

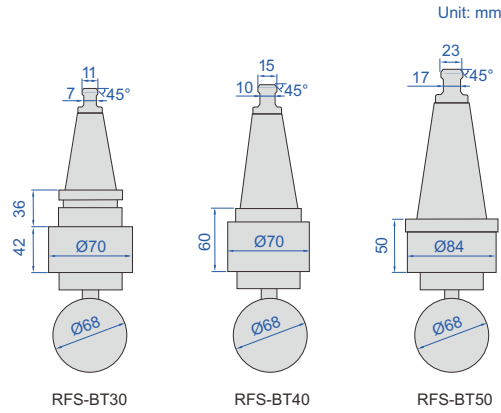

RFS-HSK63A

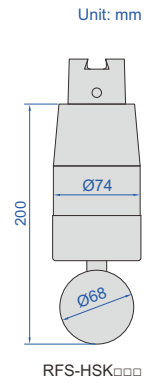

34

- Hydraulic mechanical structure, high stability
- To detect the tension of locking device

### RFS-BT $\square\square$ SPECIFICATION

Code	Dial range *	Accuracy	Applicable tension of spindle	Rivet angle **
RFS-BT30	0~60kg/cm <sup>2</sup>	±0.96kg/cm <sup>2</sup>	200~500kgf	45°
RFS-BT40	0~150kg/cm <sup>2</sup>	±2.4kg/cm <sup>2</sup>	500~1100kgf	
RFS-BT50	0~250kg/cm <sup>2</sup>	±4kg/cm <sup>2</sup>	1500~2200kgf	

### RFS-HSK $\square\square$ SPECIFICATION

Code	Dial range *	Accuracy	Applicable tension of spindle
RFS-HSK20A	0~120kg/cm <sup>2</sup>	±1.92kg/cm <sup>2</sup>	50~100kgf
RFS-HSK20C			
RFS-HSK20E			
RFS-HSK25A	0~150kg/cm <sup>2</sup>	±2.4kg/cm <sup>2</sup>	250~500kgf
RFS-HSK25C			
RFS-HSK25E			
RFS-HSK32A	0~500kg/cm <sup>2</sup>	±8kg/cm <sup>2</sup>	350~600kgf
RFS-HSK32B			
RFS-HSK32C			
RFS-HSK32D			
RFS-HSK32E			
RFS-HSK32F			
RFS-HSK40A			
RFS-HSK40B			
RFS-HSK40C			
RFS-HSK40D			
RFS-HSK40E			
RFS-HSK40F			
RFS-HSK50A	0~1100kg/cm <sup>2</sup>	±17.6kg/cm <sup>2</sup>	1000~2000kgf
RFS-HSK50B			
RFS-HSK50C			
RFS-HSK50D			
RFS-HSK50E			
RFS-HSK50F			

Code	Dial range *	Accuracy	Applicable tension of spindle
RFS-HSK63A	0~1800kg/cm <sup>2</sup>	±28.8kg/cm <sup>2</sup>	1500~3000kgf
RFS-HSK63B			
RFS-HSK63C			
RFS-HSK63D			
RFS-HSK63E			
RFS-HSK63F			
RFS-HSK80A	0~2800kg/cm <sup>2</sup>	±44.8kg/cm <sup>2</sup>	2000~4000kgf
RFS-HSK80B			
RFS-HSK80C			
RFS-HSK80D			
RFS-HSK80E			
RFS-HSK80F			
RFS-HSK100A	0~7000kg/cm <sup>2</sup>	±112kg/cm <sup>2</sup>	6000~9000kgf
RFS-HSK100B			
RFS-HSK100C			
RFS-HSK100D			
RFS-HSK100E			
RFS-HSK100F			
RFS-HSK160A	0~11500kg/cm <sup>2</sup>	±184kg/cm <sup>2</sup>	10000~16000kgf
RFS-HSK160B			
RFS-HSK160C			
RFS-HSK160D			
RFS-HSK160E			
RFS-HSK160F			

\* The actual tension of spindle (kgf) is 10X of dial reading

\*\* Can be customized for 60° and 90°



Digital Torque Testers  
Page 880



Bottle Cap Torque Testers  
Page 880



Digital Torque Testers  
Page 881-882



Torque Wrench Test Stands  
Page 883



Torque Screwdrivers  
Page 883-885



Intelligent Electric Screwdrivers  
Page 885-886



Torque Wrenches  
Page 887-899



Torque Adapters  
Page 900



Torque Multipliers  
Page 901-903

## DIGITAL TORQUE TESTERS

DATA  
OUTPUT



two display modes

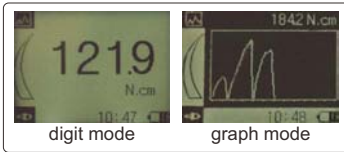

software flash disk  
(included)

- External sensor
- Metal case, touch buttons
- Clockwise and counter-clockwise operation
- Test mode: track, peak, first peak, preset tolerance
- Unit: N.m, N.cm, kgf.cm, lbf.in, lbf.ft
- Set tolerance with judgement
- 1000 memories
- LCD display with backlight, can automatically turn 180°
- Overload alarm
- Automatic power off



IST-DTT5

### SPECIFICATION

Code	IST-DTT1	IST-DTT5	IST-DTT10
Load capacity	0.05~1N.m	0.25~5N.m	0.5~10N.m
Resolution	0.0001N.m	0.0005N.m	0.001N.m
Max. clamping diameter	Ø10mm	Ø10mm	Ø13mm
Sampling frequency	2000 times per second		
Accuracy	±0.3% (of load capacity)		
Output	USB, RS232, alarm signal		
Power supply	built-in rechargeable battery		
Dimension	145x73x34mm		
Weight	1.4kg		

### STANDARD DELIVERY

Main unit	1 pc
External sensor	1 pc
AC/DC adapter	1 pc
Software and USB cable	1 pc

### OPTIONAL ACCESSORY

Printer	ISF-DF-PRINTER
RS232 cable	IST-DTT-CABLE



printer (optional)

## DIGITAL BOTTLE CAP TORQUE TESTERS

DATA  
OUTPUT



- Measure the opening and tightening torque of bottle caps
- Unit: N.m, N.cm, kgf.cm, lbf.in, lbf.ft
- 1500 memories
- Wireless connection to printer
- Automatic power off
- LCD display with backlight
- Overload alarm
- With calibration function



IST-DCT20

two display modes



software flash disk  
(included)



printer (optional)

### SPECIFICATION

Code	IST-DCT2	IST-DCT5	IST-DCT10	IST-DCT20
Load capacity	2N.m	5N.m	10N.m	20N.m
Resolution	0.0002N.m	0.0005N.m	0.001N.m	0.002N.m
Clamping range	Ø19.5~190mm			
Accuracy	±0.5% (of load capacity)			
Measuring mode	tracking, peak (max.), first peak, double peak, tolerance testing			
Output	wireless and USB			
Power supply	built-in rechargeable battery			
Dimension	200×197×142mm			
Weight	2.5kg			

### STANDARD DELIVERY

Main unit	1 pc
AC/DC adapter	1 pc
Software and USB cable	1 pc

### OPTIONAL ACCESSORY

Printer	ISH-DS-PRINTER
---------	----------------



ATTENTION: NOT SUITABLE FOR ELECTRIC WRENCHES,  
IMPACT WRENCHES OR PNEUMATIC WRENCHES

## DIGITAL TORQUE TESTERS



IST-04TT350  
type A



IST-04TT815  
type B

- Test torque wrenches, torque screwdrivers and other torque tools
- Clockwise operation
- Peak, track and first peak working modes
- Tolerance testing
- LED indicator for target torque alarm:
  - Green LED light on when the value is within tolerance;
  - Red LED light on when the value is above the high tolerance
- Power off automatically in 2 minutes without any operations



adaptor  
(type A included)

### SPECIFICATION

Code	IST-04TT5	IST-04TT28	IST-04TT68	IST-04TT350	IST-04TT815	IST-04TT1000	IST-04TT2000
Type	A				B		
Range	0.5~5N.m	2.8~28N.m	6.8~68N.m	35~350N.m	81.5~815N.m	100~1000N.m	200~2000N.m
Accuracy	±1% (clockwise)						
Resolution	0.001N.m	0.01N.m	0.01N.m	0.1N.m	0.1N.m	1N.m	1N.m
Unit	N.m, in.lb, ft.lb, kg.cm					N.m, ft.lb	
Square socket/hex driver	1/4"	3/8"	3/8"	1/2"	27mm	27mm	27mm
Adaptor	no	3/8" to 1/4"	3/8" to 1/4"	1/2" to 3/8" 3/8" to 1/4"	no		
Power supply	DC						
Weight	0.75kg	0.75kg	1.1kg	1.1kg	5.1kg	5.1kg	5.1kg

### STANDARD DELIVERY

Main unit	1 pc
AC/DC adapter	1 pc
Adaptor	refer to details

## DIGITAL TORQUE TESTERS

ATTENTION: NOT SUITABLE FOR ELECTRIC WRENCHES, IMPACT WRENCHES OR PNEUMATIC WRENCHES



IST-TT550

- With external sensor, to test torque wrenches, torque screwdrivers and other torque tools
- Clockwise and counter-clockwise operation
- Peak, track and first peak working modes
- Unit: N.m, in.lb, ft.lb, kg.cm
- Tolerance testing
- LED indicator for target torque alarm:
  - Yellow LED light on when the value is below the low tolerance;
  - green LED light on when the value is within tolerance;
  - red LED light on when the value is above the high tolerance
- The buzzer alarms when the maximum torque value is captured in the first peak mode
- Automatic power off

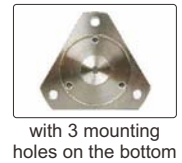

### SPECIFICATION

Code	IST-TT05	IST-TT5	IST-TT30	IST-TT50	IST-TT220	IST-TT550	IST-TT1000	IST-TT2200
Range	0.1~0.5N.m	0.5~5N.m	3~30N.m	5~50N.m	22~220N.m	55~550N.m	100~1000N.m	220~2200N.m
Accuracy	±1% (clockwise and counter-clockwise)							
Resolution	0.0001N.m	0.0001N.m	0.001N.m	0.001N.m	0.01N.m	0.01N.m	0.1N.m	0.1N.m
Square socket (L)	1/4"	1/4"	3/8"	3/8"	1/2"	3/4"	1"	1"
Power supply	DC							
Adaptor	no	no	3/8" to 1/4"	3/8" to 1/4"	1/2" to 3/8" 3/8" to 1/4"	3/4" to 1/2" 1/2" to 3/8"	1" to 3/4" 3/4" to 1/2" 1/2" to 3/8"	1" to 3/4" 3/4" to 1/2"
Transducer dimension	63×63 ×65mm	63×63 ×65mm	89×89 ×75mm	89×89 ×75mm	109×109 ×83mm	140×140 ×107mm	160×160 ×126mm	160×160 ×126mm
Weight	0.75kg	0.75kg	1.1kg	1.1kg	1.4kg	2.9kg	5.0kg	5.1kg

### STANDARD DELIVERY

Main unit	1 pc
Transducer with 1.5m cable	1 pc
Extension cable (1.2m)	1 pc
AC/DC adapter	1 pc
Adaptor	refer to details

## TORQUE WRENCH TEST STANDS

35

application example



IST-06TS350



- Rotate the wheel to apply force. Rotary speed is adjustable
- Easy operation due to the gear box
- Used with digital torque testers (IST-TT series)

### SPECIFICATION

Code	IST-06TS350	IST-06TS1100	IST-06TS2000
Max. torque value	350N.m	1100N.m	2000N.m
Arm length	197~686mm	380~1350mm	420~1690mm
Dimension	860×290×590mm	1760×350×590mm	2090×350×590mm
Weight	32.5kg	76kg	80kg

Can be customized according to test requirements



digital torque tester (optional)

### OPTIONAL ACCESSORY

Digital torque tester	IST-TT series
Adaptor	IST-06TS-BLOCK1 (necessary for IST-TT05, IST-TT5, IST-TT30, IST-TT50 and IST-TT220)
	IST-06TS-BLOCK2 (necessary for IST-TT550, IST-TT1000 and IST-TT2200)



phillips screwdriver bits (included)



hex screwdriver bits (included)

- Clockwise and counter-clockwise operation
- Unit: cN.m, in.lb, kg.cm
- Peak and track working modes
- Target torque value can be set, with audible and visible alarm:
  - Green LED light on and buzzer sounds when target torque value is 90%~100% of target torque
  - Red LED light on and buzzer sounds when target torque value is reached
- Power off automatically in 5 minutes without any operations

### SPECIFICATION

Code	IST-SD50	IST-SD200	IST-SD400
Range	10~50cN.m	40~200cN.m	80~400cN.m
Accuracy	clockwise	±3%	±2.5%
	counter-clockwise	±4%	±3.5%
Resolution	0.1cN.m	0.1cN.m	0.1cN.m
Size of hex socket (L)	1/4"	1/4"	1/4"
Power supply	1×AAA battery		
Length	193mm	203mm	203mm
Weight	190g	200g	200g

## DIGITAL TORQUE SCREWDRIVERS

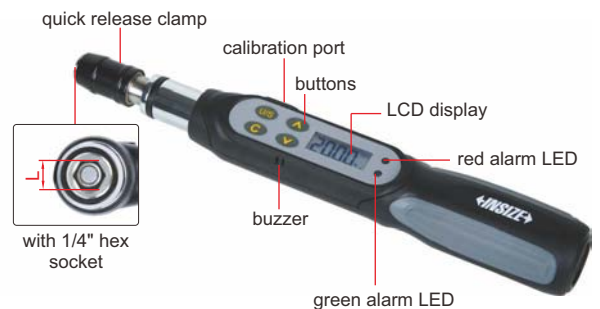

IST-SD200



### STANDARD DELIVERY

Torque screwdriver	1 pc
Phillips screwdriver bits	1 pc
Hex screwdriver bits	1 pc

### OPTIONAL ACCESSORY

Calibration cable	IST-SD-CABLE
-------------------	--------------

## BLUETOOTH DIGITAL TORQUE SCREWDRIVERS (KEYBOARD SIGNAL)



BUILT-IN  
BLUETOOTH

INSPECTION  
CERTIFICATE

35



### Torque screwdrivers:

- Clockwise and counter-clockwise operation
- Unit: N.m, in.lb, ft.lb, kg.cm
- Peak and track working modes
- Target torque value can be set, with audible and visible alarm:
  - LED lights up in sequence and the buzzer sounds when target torque value is 80%~99.5% of target torque
  - Both green and red LED light on and buzzer sounds when target torque value is reached
- Power off in 2 minutes automatically

### Data transmission:

- Built-in Bluetooth module, which can be connected with computers (with Bluetooth function), mobile phones, tablets and other devices
- Keyboard signal, can be transmitted to Excel
- Transmission distance is 10 meters (no obstacles, no electromagnetic interference)
- Bluetooth connection and disconnection are respectively shown by indicator lights

### SPECIFICATION

Code	IST-3SD50	IST-3SD200	IST-3SD400
Range	0.1~0.5N.m	0.4~2N.m	0.8~4N.m
Accuracy	clockwise	±3%	±2.5%
	counter-clockwise	±4%	±3.5%
Resolution	0.001N.m	0.001N.m	0.001N.m
Size of hex socket (L)	1/4"	1/4"	1/4"
Power supply	2×AAA batteries		
Length	193mm	193mm	193mm
Weight	304g	304g	383g



### STANDARD DELIVERY

Torque screwdriver	1 pc
Phillips screwdriver bits	1 pc
Hex screwdriver bits	1 pc
Wrench (only for IST-3SD200, IST-3SD400)	1 pc

### OPTIONAL ACCESSORY

Calibration cable	IST-SD-CABLE
-------------------	--------------

**ATTENTION: CLOCKWISE OPERATION ONLY**

## TORQUE SCREWDRIVERS

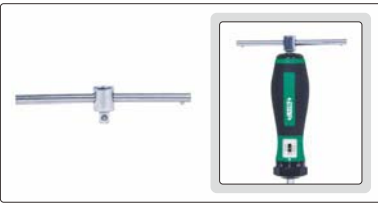

T-bar wrench  
(for IST-MG250, IST-MG360, IST-MG600)



IST-MG100

### SPECIFICATION

Code	IST-MG100	IST-MG250	IST-MG360	IST-MG600
Range (clockwise)	20~100cN.m	50~250cN.m	60~360cN.m	1.0~6.0N.m
Graduation	2cN.m	5cN.m	5cN.m	0.1N.m
Head	1/4" hex socket			
Accuracy	±6%			
Length	172mm			
Weight	0.26kg			

### STANDARD DELIVERY

Torque screwdriver	1 pc
T-bar wrench (for IST-MG250, IST-MG360, IST-MG600)	1 pc



## INTELLIGENT ELECTRIC SCREWDRIVERS



HES-H022

- Unit: kfg.cm, N.m, mN.m, 0.01kgf.cm, lbf.in
- Up to 8 preset values can form a task link
- Clockwise and counter-clockwise operation
- Non-slip grip handle
- Built-in overload protection function

To be continued

Continued from previous page

## SPECIFICATION

<b>Code</b>	<b>HES-H022</b>	<b>HES-H055</b>	<b>HES-H107</b>
<b>Range</b>	0.2~1.5kgf.cm 0.02~0.15N.m	0.5~5kgf.cm 0.05~0.5N.m	1~7kgf.cm 0.1~0.7N.m
<b>Accuracy</b>	±5%		
<b>Speed</b>	30~2000rpm		30~1000rpm
<b>Bits model</b>	tail deficient type		
<b>Dimension</b>	<b>electric screwdriver</b>	30×42×204mm	
	<b>control box</b>	147×60×201mm	
<b>Weight</b>	<b>electric screwdriver</b>	250g	
	<b>control box</b>	1280g	
<b>Power</b>	AC 220V		

### features

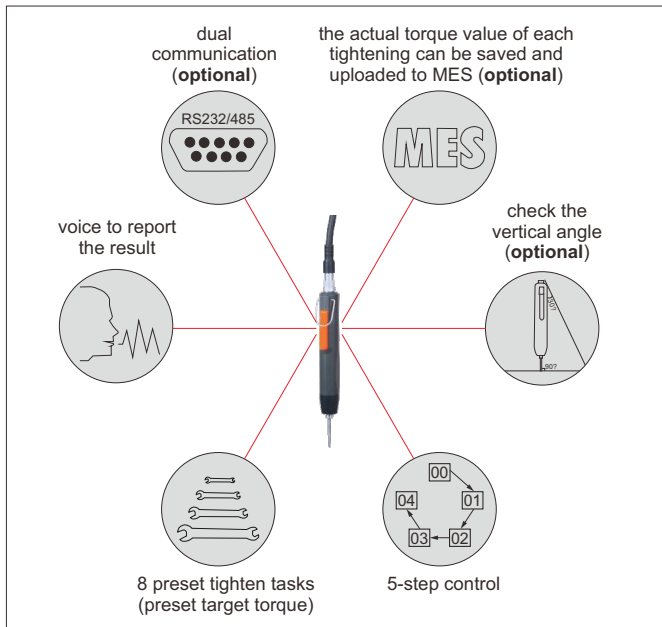

### STANDARD DELIVERY

<b>Electric screwdriver (with bits and connection cable)</b>	1 pc
<b>Control box</b>	1 pc
<b>AC adapter</b>	1 pc
<b>Software and USB disk</b>	1 pc
<b>RS232 connection cable</b>	1 pc

### OPTIONAL ACCESSORY

<b>RS232 connection cable</b>	<b>HES-H-CABLE-232</b>
<b>RS485 connection cable</b>	<b>HES-H-CABLE-485</b>
<b>Bits</b>	<b>HES-H-BITS</b>
<b>I/O control function</b>	<b>HES-H-SOFT-T</b>
<b>Network transmission function</b>	<b>HES-H-SOFT-T</b>
<b>Upload to MES</b>	<b>HES-H-SOFT-M</b>
<b>Vertical angle detection function</b>	<b>HES-H-SOFT-C</b>
<b>QR code scanner</b>	<b>HES-H-S</b>
<b>Mechanical arm</b>	<b>HES-H-X</b>

### operation system on control box (included)

**I/O control (optional)**

data storage, alarm items, parameter settings, electric screwdriver parameters, results, unit, actual torque value, tighten number of screws, task linkbutton, run task link automatically

**main interface**

**I/O control (optional)**

loosen parameters, tighten parameters, save settings, 5 steps, real-time task

**task interface**



## SMALL RANGE DIGITAL TORQUE WRENCH

35

- Clockwise and counter-clockwise operation
- Unit: N.m, in.lb, ft.lb, kg.cm
- Peak and track working modes
- Target torque value can be set, with audible and visible alarm:
  - Green LED light on and buzzer sounds when target torque value is 90%~100% of target torque
  - Red LED light on and buzzer sounds when target torque value is reached
- Power off automatically in 5 minutes without any operations
- Non-slip grip handle
- With overload record (once the torque reaches 110% of the maximum range)

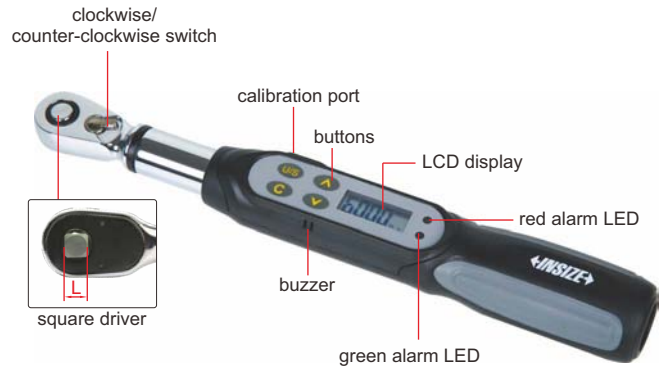

IST-WP6

### SPECIFICATION

<b>Code</b>	IST-WP6	
<b>Range</b>	1.2~6N.m	
<b>Accuracy</b>	clockwise	±3%
	counter-clockwise	±4%
<b>Resolution</b>	0.001N.m	
<b>Square driver (L)</b>	1/4"	
<b>Power supply</b>	1×AAA battery	
<b>Length</b>	260mm	
<b>Weight</b>	430g	

### OPTIONAL ACCESSORY

<b>Calibration cable</b>	IST-SD-CABLE
--------------------------	--------------



## SHORT HANDLE DIGITAL TORQUE WRENCHES

- Clockwise and counter-clockwise operation
- Unit: N.m, in.lb, ft.lb, kg.cm
- Peak and track working modes
- Target torque value can be set, with audible and visible alarm:
  - Green LED light on and buzzer sounds when torque value is 90%~100% of target torque
  - Both green and red LED light on and buzzer sounds when target torque value is reached
- Power off in 5 minutes automatically
- Non-slip grip handle
- With damp record
- With overload record (once the torque reaches 110% of the maximum range)



IST-WS60

### SPECIFICATION

Code	IST-WS12	IST-WS20	IST-WS30	IST-WS30A	IST-WS60	IST-WS85
<b>Range</b>	2.4~12N.m	4~20N.m	6~30N.m	6~30N.m	12~60N.m	17~85N.m
<b>Accuracy</b>	clockwise	±3%				
	counter-clockwise	±4%				
<b>Resolution</b>	0.01N.m	0.01N.m	0.01N.m	0.01N.m	0.01N.m	0.1N.m
<b>Square driver (L)</b>	1/4"	1/4"	1/4"	3/8"	3/8"	3/8"
<b>Power supply</b>	2×AAA batteries					
<b>Length</b>	215mm	215mm	215mm	215mm	225mm	271mm
<b>Weight</b>	750g	750g	750g	830g	917g	1000g

### OPTIONAL ACCESSORY

<b>Calibration cable</b>	IST-SD-CABLE
--------------------------	--------------

## DIGITAL TORQUE WRENCHES



OPTIONAL ACCURACY:  
CLOCKWISE:  $\pm 1\%$   
COUNTER-CLOCKWISE:  $\pm 2\%$   
ONLY FOR RANGE 6-850N.m

35

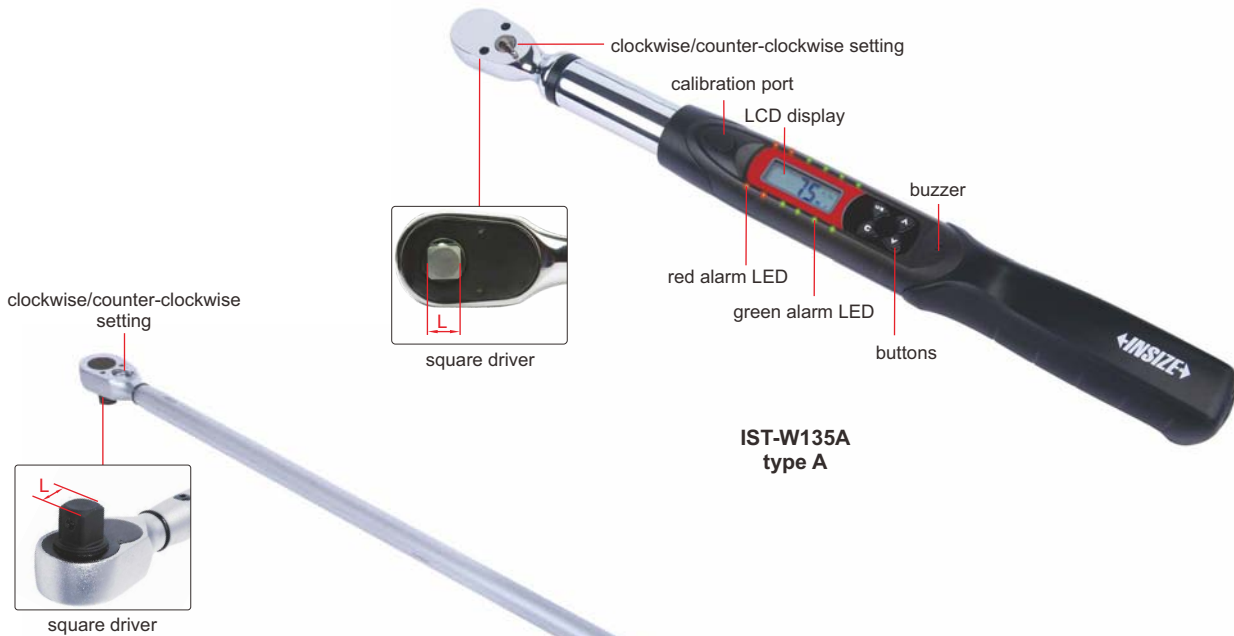

IST-W135A  
type A

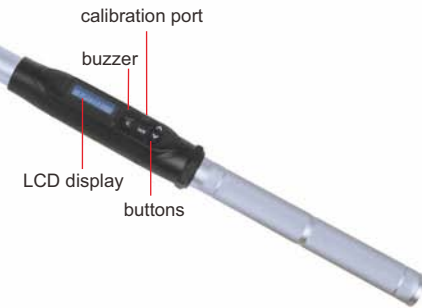
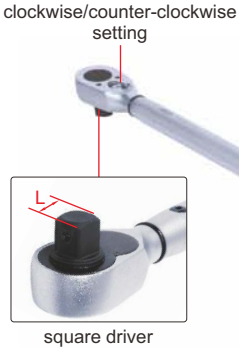

IST-W1200A  
type B

- Clockwise and counter-clockwise operation
- Unit: N.m, in.lb, ft.lb, kg.cm
- Peak and track working mode
- Target torque value can be set, with audible and visible alarm:
  - Green LED light on and buzzer sounds when torque value is 90%~100% of target torque
  - Both green and red LED light on and buzzer sounds when target torque value is reached
- Power off automatically in 5 minutes without any operations
- Non-slip grip handle
- With damp record
- With overload record (once the torque reaches 110% of the maximum range)

### SPECIFICATION

Code	Type	Range	Accuracy	Resolution	Square driver (L)	Power supply	Length	Weight
IST-W30A	A	6~30N.m	clockwise: $\pm 2\%$ counter-clock wise: $\pm 3\%$	0.01N.m	1/4"	2×AA batteries, for 110 hours working	390mm	830g
IST-W135A		27~135N.m		0.1N.m	3/8"		415mm	950g
IST-W200A		40~200N.m		0.1N.m	1/2"		530mm	1.4kg
IST-W340A		68~340N.m		0.1N.m	1/2"		650mm	1.6kg
IST-W500A*	B	100~500N.m	clockwise: $\pm 2.5\%$ counter-clock wise: $\pm 3.5\%$	0.1N.m	3/4"		1285mm	7kg
IST-W850A		170~850N.m		0.1N.m	3/4"		1295mm	6kg
IST-W1200A		240~1200N.m		1N.m	1"		1920mm	13kg
IST-W1500A		300~1500N.m		1N.m	1"		1920mm	13kg
IST-W2000A		400~2000N.m		1N.m	1"	1920mm	14kg	

### OPTIONAL ACCESSORY

Calibration cable    IST-W-CABLE

\* The accuracy of this code is not optional



**OPTIONAL ACCURACY:**  
 CLOCKWISE:  $\pm 1\%$   
 COUNTER-CLOCKWISE:  $\pm 2\%$

## INTERCHANGEABLE HEAD DIGITAL TORQUE WRENCHES

**INSPECTION  
 CERTIFICATE**



**IST-2W135A**

ratchet head (included)

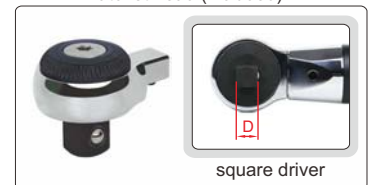

- Clockwise and counter-clockwise operation
- Unit: N.m, in.lb, ft.lb, kg.cm, degree
- Peak and track working modes
- Target torque value can be set, with audible and visible alarm:
  - Green LED light on and buzzer sounds when torque value is 90%~100% of target torque
  - Both green and red LED light on and buzzer sounds when target torque value is reached
- Power off in 5 minutes automatically without any operations
- Non-slip grip handle
- With damp record
- With overload record (once the torque reaches 110% of the maximum range)

torque correction

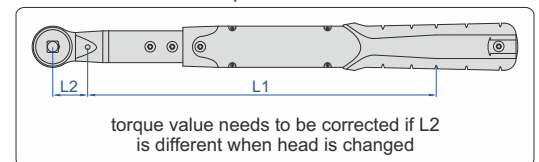

### SPECIFICATION

Code	IST-2W30A	IST-2W135A	IST-2W200A	IST-2W340A	IST-2W410A
Range	6~30N.m	27~135N.m	40~200N.m	68~340N.m	82~410N.m
Accuracy	clockwise	$\pm 2\%$			
	counter-clockwise	$\pm 3\%$			
Resolution	0.01N.m	0.1N.m	0.1N.m	0.1N.m	0.1N.m
Socket size (A×B)	12×9mm	12×9mm	18×14mm	18×14mm	18×14mm
Arm length (L1)	272.7mm	287.7mm	381.2mm	501.2mm	501.2mm
Power supply	2xAA batteries, for 110 hours working				
Weight	1400g	1570g	2170g	2320g	2320g

### STANDARD DELIVERY

Torque wrench	1 pc
Ratchet head	1 pc

### OPTIONAL ACCESSORY

Calibration cable	IST-W-CABLE
Interchangeable head	refer to details

To be continued

Continued from previous page

**RATCHET HEAD (INCLUDED) SPECIFICATION**

Code of torque wrench	IST-2W30A	IST-2W135A	IST-2W200A	IST-2W340A	IST-2W410A
Square driver (D)	1/4"	3/8"	1/2"	1/2"	3/4"
Length (L2)	29mm	29mm	40mm	40mm	40mm



**RATCHET HEAD (optional)**

Code	Square driver (D)	Applicable wrenches
IST-2W-R1	1/4"	IST-2W30A
IST-2W-R2	3/8"	IST-2W135A
IST-2W-R3	1/2"	IST-2W135A
IST-2W-R4	1/2"	IST-2W200A IST-2W340A IST-2W410A

**ADJUSTABLE SPANNER HEAD (optional)**

Code	Open size	Applicable wrenches
IST-2W-A1	5-27mm	IST-2W30A IST-2W135A
IST-2W-A2	5-30mm	IST-2W200A IST-2W410A
IST-2W-A3	10-41mm	IST-2W340A IST-2W410A



**OPEN END HEAD (optional)**

Code	Open size	Applicable wrenches
IST-2W-K7	7mm	IST-2W30A IST-2W135A
IST-2W-K8	8mm	
IST-2W-K9	9mm	
IST-2W-K10	10mm	
IST-2W-K11	11mm	
IST-2W-K12	12mm	
IST-2W-K13	13mm	
IST-2W-K14	14mm	
IST-2W-K15	15mm	
IST-2W-K16	16mm	
IST-2W-K17	17mm	
IST-2W-K18	18mm	
IST-2W-K19	19mm	
IST-2W-K13A	13mm	
IST-2W-K14A	14mm	
IST-2W-K15A	15mm	
IST-2W-K16A	16mm	
IST-2W-K17A	17mm	
IST-2W-K18A	18mm	
IST-2W-K19A	19mm	
IST-2W-K21A	21mm	
IST-2W-K22A	22mm	
IST-2W-K24A	24mm	
IST-2W-K27A	27mm	

**BOX END HEAD (optional)**

Code	Open size	Applicable wrenches
IST-2W-M7	7mm	IST-2W30A IST-2W135A
IST-2W-M8	8mm	
IST-2W-M10	10mm	
IST-2W-M11	11mm	
IST-2W-M12	12mm	
IST-2W-M13	13mm	
IST-2W-M14	14mm	
IST-2W-M15	15mm	
IST-2W-M16	16mm	
IST-2W-M17	17mm	
IST-2W-M18	18mm	
IST-2W-M19	19mm	
IST-2W-M21	21mm	
IST-2W-M22	22mm	
IST-2W-M13A	13mm	
IST-2W-M14A	14mm	
IST-2W-M15A	15mm	
IST-2W-M16A	16mm	
IST-2W-M17A	17mm	
IST-2W-M18A	18mm	
IST-2W-M19A	19mm	
IST-2W-M21A	21mm	

**OPTIONAL ACCURACY:**  
CLOCKWISE:  $\pm 1\%$   
COUNTER-CLOCKWISE:  $\pm 2\%$   
ONLY FOR RANGE 6~340N.m

**MEASURE THE TORQUE  
OF TIGHTENED BOLTS**

## QUALITY INSPECTION TORQUE WRENCHES

**INSPECTION  
CERTIFICATE**

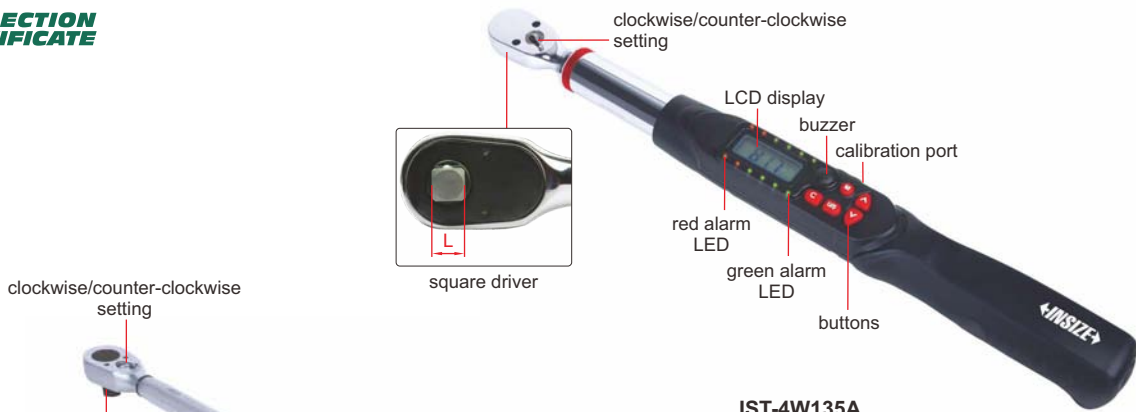

**IST-4W135A  
type A**

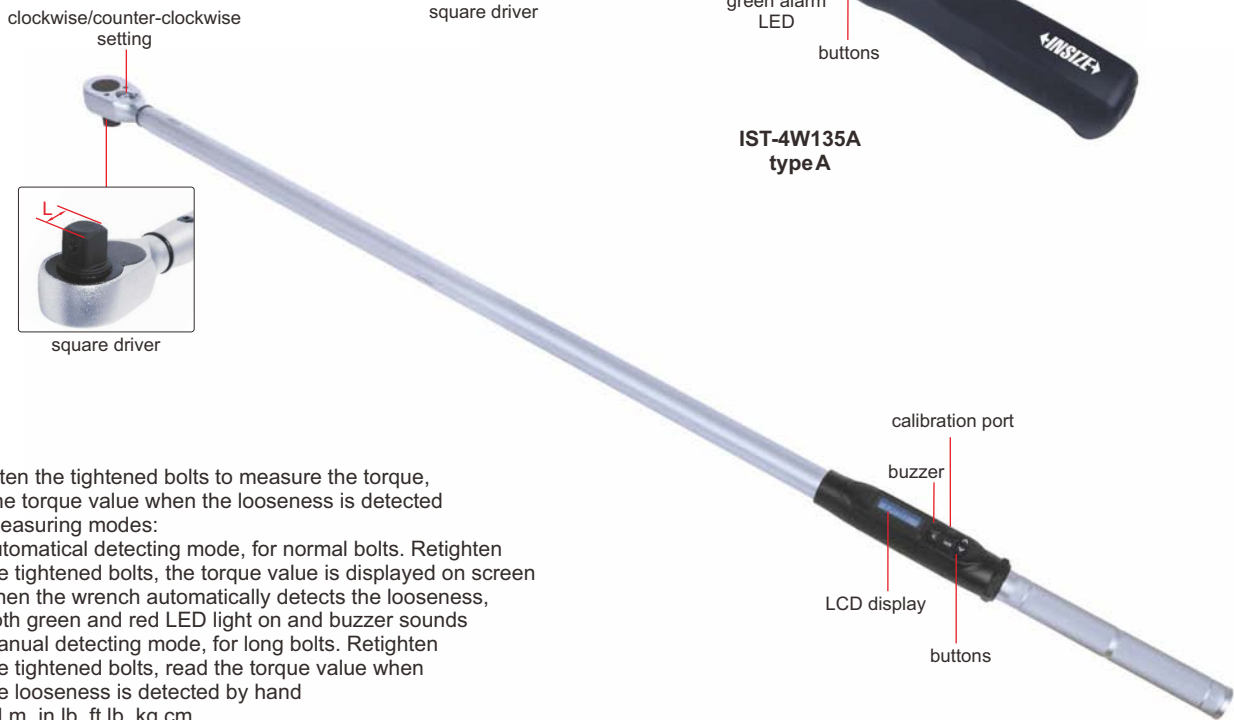

**IST-4W1200A  
type B**

- Retighten the tightened bolts to measure the torque, read the torque value when the looseness is detected
- Two measuring modes:
  - M1: automatic detecting mode, for normal bolts. Retighten the tightened bolts, the torque value is displayed on screen when the wrench automatically detects the looseness, both green and red LED light on and buzzer sounds
  - M2: manual detecting mode, for long bolts. Retighten the tightened bolts, read the torque value when the looseness is detected by hand
- Unit: N.m, in.lb, ft.lb, kg.cm
- Peak and track working mode (only for M2 measuring mode)
- Clockwise and count-clockwise operation
- Memory of 50 results
- Power off in 15 minutes automatically
- Non-slip grip handle
- With overload record (once the torque reaches 110% of the maximum range)

### SPECIFICATION

Code	Type	Range	Accuracy	Resolution	Square driver (L)	Power supply	Length	Weight
IST-4W30A	A	6~30N.m	clockwise: $\pm 2\%$ counter-clock wise: $\pm 3\%$	0.01N.m	1/4"	2×AA batteries, for 110 hours working	390mm	760g
IST-4W135A		27~135N.m		0.1N.m	3/8"		415mm	940g
IST-4W200A		40~200N.m		0.1N.m	1/2"		530mm	1340g
IST-4W340A		68~340N.m		0.1N.m	1/2"		650mm	1540g
IST-4W850A	B	170~850N.m	clockwise: $\pm 2.5\%$ counter-clock wise: $\pm 3.5\%$	0.1N.m	3/4"		1220mm	6000g
IST-4W1200A		240~1200N.m		1N.m	1"		1800mm	9100g
IST-4W1500A		300~1500N.m		1N.m	1"		1800mm	9100g
IST-4W2000A		400~2000N.m		1N.m	1"		1800mm	10500g

### OPTIONAL ACCESSORY

Calibration cable	IST-W-CABLE
-------------------	-------------

## TWO-WAY WIRELESS DIGITAL TORQUE WRENCHES

OPTIONAL ACCURACY:  
CLOCKWISE: ±1%  
COUNTER-CLOCKWISE: ±2%

TRANSMISSION DISTANCE  
IS 300 METERS

INSPECTION  
CERTIFICATE



IST-13W135A



two-way receiver

35

### Torque wrench:

- The test results can be transmitted wirelessly to the computer and PLC
- Unit: N.m, in.lb, ft.lb, kg.cm
- Clockwise and counter-clockwise operation
- Peak and track working mode
- Can set tolerance with judgement in peak working mode
- 9 target torque values can be set, with audible and visible alarm:
  - Green LED light on and buzzer sounds when torque value is 80%~99.5% of target torque
  - Both green and red LED light on and buzzer sounds when torque value is over 99.5% of target torque
- Power off in 2 minutes automatically
- Non-slip grip handle
- With damp record
- With overload record (once the torque reaches 110% of the maximum range)

### Two-way receiver:

- A two-way receiver can be connected with up to 10 wrenches at the same time, and the maximum transmission distance is 300 meters

### Software:

- In Windows10 system version 1709 or above
- Two operation mode:
  - Data transmission mode: wrench transmits actual torque value to software after operation
  - Program guidance mode: firstly set process on software (set sequence of tightening, select wrench and set torque values and tolerances). Then software shows which wrench the operator should use (indicator light of the selected wrench is on) and shows the target torque value, and serial number of the screw to be tightened (shows on the wrench); After the operation is finished, the actual torque value is sent to software.
- Can select whether the wrench only sends qualified data after operation (in accordance with the tolerance)
- Two data transmission modes: automatic or press button to send
- When the wrench is disconnected, data is stored in the wrench and automatically sent to computer after wireless connection
- The data in software can be printed or sent to Excel

### TWO-WAY RECEIVER SPECIFICATION

Code	IST-13WREC	IST-13WREC-PLC
Signal output to	computer	PLC
Working frequency	ISM433MHz (432.0~433.8MHz, adjustable)	
Power supply	power adapter, 24V, 0.5A	
Dimension	200×108×31mm	
Weight	500g	

### OPTIONAL ACCESSORY

Calibration cable	IST-SD-CABLE
-------------------	--------------

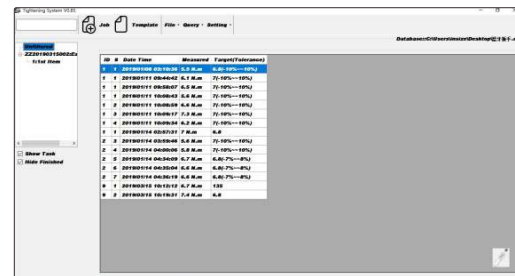

data transmission mode

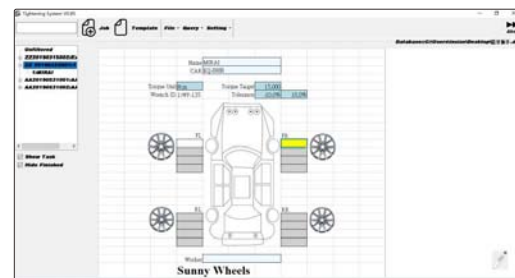

program guidance mode

### SPECIFICATION

Code	Range	Accuracy	Unit	Resolution	Square driver (L)	Working frequency	Power supply	Length	Weight
IST-13W30A	6~30N.m	clockwise: ±2% counter-clockwise: ±3%	N-m/ft-lb/ in-lb/kg-cm	0.01N.m	1/4"	ISM433MHz (432.0~433.8MHz, adjustable)	2×AA batteries	390mm	760g
IST-13W60A	12~60N.m			0.01N.m	3/8"			390mm	940g
IST-13W135A	27~135N.m			0.1N.m	3/8"			415mm	940g
IST-13W200A	40~200N.m			0.1N.m	1/2"			530mm	1340g
IST-13W340A	68~340N.m			0.1N.m	1/2"			650mm	1540g
IST-13W1200A	240~1200N.m	clockwise: ±2.5% counter-clockwise: ±3.5%	N-m/ft-lb	1N.m	1"			1800mm	9000g
IST-13W1500A	300~1500N.m			1N.m	1"			1800mm	9000g
IST-13W2000A	400~2000N.m			1N.m	1"			1800mm	10500g

**TYPE B OPTIONAL ACCURACY:**  
CLOCKWISE:  $\pm 1\%$   
COUNTER-CLOCKWISE:  $\pm 2\%$

BUILT-IN BLUETOOTH



## BLUETOOTH DIGITAL TORQUE WRENCHES (KEYBOARD SIGNAL)



### Torque wrenches:

- Unit: in.lb, ft.lb, N.m, kg.cm
- Clockwise and counter-clockwise operation
- Peak and track working mode
- Can set tolerance with judgement in peak working mode
- 9 target torque values can be set, with audible and visible alarm:  
LED lights up in sequence, and the buzzer gets louder and louder when torque value is 80%~99.5% of target torque
- Power off in 2 minutes automatically
- Non-slip grip handle
- With overload record (once the torque reaches 110% of the maximum range)

### Data transmission:

- Built-in Bluetooth 4.0 module, which can be connected with computers (with Bluetooth function), mobile phones, tablets and other devices
- Keyboard signal, can be transmitted to Excel, Word, TXT
- Transmission distance is 10 meters (no obstacles, no electromagnetic interference)
- Bluetooth connection and disconnection are respectively shown by indicator lights



transmission distance is 10 meters  
(no obstacles, no electromagnetic interference)

### SPECIFICATION

Code	IST-15W06A	IST-15W12A	IST-15W20A	IST-15W30A	IST-15W135A	IST-15W200A	IST-15W340A
Type	A (short handle)			B (long handle)			
Range	1.2~6N.m	2.4~12N.m	4~20N.m	6~30N.m	27~135N.m	40~200N.m	68~340N.m
Accuracy	clockwise	$\pm 2\%$					
	counter-clockwise	$\pm 3\%$					
Tolerance setting range	-20%~+20% (target torque value)						
Resolution	0.001N.m	0.01N.m	0.01N.m	0.01N.m	0.1N.m	0.1N.m	0.1N.m
Square driver (L)	1/4"	1/4"	1/4"	1/4"	3/8"	1/2"	1/2"
Power supply	2xAAA batteries			2xAA batteries			
Length	215mm	215mm	215mm	390mm	415mm	530mm	650mm
Weight	750g	750g	750g	760g	940g	1340g	1540g

### OPTIONAL ACCESSORY

Calibration cable	IST-SD-CABLE
-------------------	--------------

# INTERCHANGEABLE HEAD TORQUE WRENCHES

ATTENTION: CLOCKWISE OPERATION ONLY



IST-11WM200

- According to DIN ISO 6789, ASME B107.300
- All-metal construction, sturdy and durable

### SPECIFICATION

Code	Range (clockwise)	Accuracy	Graduation	Socket size (A×B)	Length	Weight
IST-11WM12	2.5~12N.m	±6% (<10N.m) ±4% (≥10N.m)	0.05N.m	12×9mm	284mm	580g
IST-11WM30	6.0~30N.m	±6% (<10N.m) ±4% (≥10N.m)	0.1N.m	12×9mm	303mm	720g
IST-11WM60	10~60N.m	±4%	0.5N.m	12×9mm	372mm	860g
IST-11WM125	25~125N.m	±4%	0.5N.m	12×9mm	427mm	940g
IST-11WM200	40~200N.m	±4%	1N.m	18×14mm	460mm	1060g
IST-11WM335	65~335N.m	±4%	1N.m	18×14mm	520mm	1200g
IST-11WM500	100~500N.m	±4%	2.5N.m	32×24mm	855mm	5000g
IST-11WM800	160~800N.m	±4%	4N.m	32×24mm	1055mm	5900g
IST-11WM1000	200~1000N.m	±4%	5N.m	32×24mm	1055mm	5900g
IST-11WM1500	300~1500N.m	±4%	5N.m	36×27mm	1249mm	9000g
IST-11WM2000	400~2000N.m	±4%	10N.m	36×27mm	1249mm	9000g
IST-11WM3000	600~3000N.m	±4%	15N.m	36×27mm	1249mm	10300g

### RATCHET HEAD (optional)



Code	Square driver	Applicable wrenches
IST-11WM-R1	1/4"	IST-11WM12 IST-11WM30
IST-11WM-R2	3/8"	IST-11WM12 IST-11WM30 IST-11WM60 IST-11WM125
IST-11WM-R3	1/2"	IST-11WM200 IST-11WM335
IST-11WM-R4*	3/4"	IST-11WM200 IST-11WM335
IST-11WM-R5	3/4"	IST-11WM500 IST-11WM800 IST-11WM1000
IST-11WM-R6	1"	IST-11WM1500 IST-11WM2000 IST-11WM3000



### HOOK HEAD (optional)

**Hook head** customized according to customer requirements

To be continued

Continued from previous page



**OPEN END HEAD (optional)**

Code	Open size	Applicable wrenches
IST-11WM-K8	8mm	IST-11WM12 IST-11WM30 IST-11WM60 IST-11WM125
IST-11WM-K10	10mm	
IST-11WM-K13	13mm	
IST-11WM-K14	14mm	
IST-11WM-K15	15mm	
IST-11WM-K17	17mm	
IST-11WM-K19*	19mm	
IST-11WM-K13A	13mm	IST-11WM200 IST-11WM335
IST-11WM-K14A	14mm	
IST-11WM-K15A	15mm	
IST-11WM-K17A	17mm	
IST-11WM-K19A	19mm	
IST-11WM-K22A	22mm	
IST-11WM-K24A	24mm	
IST-11WM-K27A*	27mm	
IST-11WM-K30A*	30mm	
IST-11WM-K32A*	32mm	
IST-11WM-K22B	22mm	IST-11WM500 IST-11WM800 IST-11WM1000
IST-11WM-K24B	24mm	
IST-11WM-K27B	27mm	
IST-11WM-K28B	28mm	
IST-11WM-K30B	30mm	
IST-11WM-K32B	32mm	
IST-11WM-K33B*	33mm	
IST-11WM-K36B*	36mm	
IST-11WM-K38B*	38mm	
IST-11WM-K40B*	40mm	
IST-11WM-K30C	30mm	IST-11WM1500 IST-11WM2000 IST-11WM3000
IST-11WM-K32C	32mm	
IST-11WM-K34C	34mm	
IST-11WM-K36C	36mm	
IST-11WM-K38C	38mm	
IST-11WM-K41C	41mm	
IST-11WM-K45C	45mm	
IST-11WM-K50C*	50mm	
IST-11WM-K55C*	55mm	
IST-11WM-K60C*	60mm	

**BOX END HEAD (optional)**

Code	Open size	Applicable wrenches
IST-11WM-M8	8mm	IST-11WM12 IST-11WM30 IST-11WM60 IST-11WM125
IST-11WM-M10	10mm	
IST-11WM-M13	13mm	
IST-11WM-M14	14mm	
IST-11WM-M15	15mm	
IST-11WM-M17	17mm	
IST-11WM-M19	19mm	
IST-11WM-M13A	13mm	IST-11WM200 IST-11WM335
IST-11WM-M14A	14mm	
IST-11WM-M15A	15mm	
IST-11WM-M17A	17mm	
IST-11WM-M19A	19mm	
IST-11WM-M22A	22mm	
IST-11WM-M24A	24mm	
IST-11WM-M27A	27mm	
IST-11WM-M30A	30mm	
IST-11WM-M32A	32mm	
IST-11WM-M22B	22mm	IST-11WM500 IST-11WM800 IST-11WM1000
IST-11WM-M24B	24mm	
IST-11WM-M27B	27mm	
IST-11WM-M28B	28mm	
IST-11WM-M30B	30mm	
IST-11WM-M32B	32mm	
IST-11WM-M33B	33mm	
IST-11WM-M36B*	36mm	
IST-11WM-M38B*	38mm	
IST-11WM-M40B	40mm	
IST-11WM-M30C	30mm	IST-11WM1500 IST-11WM2000 IST-11WM3000
IST-11WM-M32C	32mm	
IST-11WM-M34C	34mm	
IST-11WM-M36C	36mm	
IST-11WM-M38C	38mm	
IST-11WM-M41C	41mm	
IST-11WM-M45C	45mm	
IST-11WM-M50C	50mm	
IST-11WM-M55C*	55mm	
IST-11WM-M60C*	60mm	

\*Torque value needs to be corrected for these heads

## TORQUE WRENCHES

ATTENTION: CLOCKWISE  
OPERATION ONLY



35

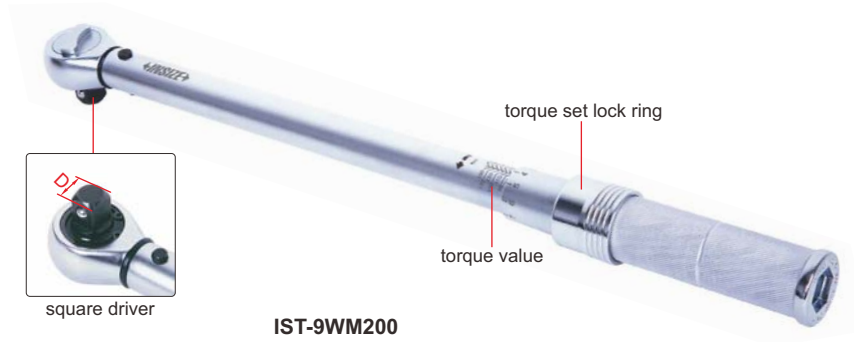

- According to DIN ISO 6789, ASME B107.300
- All-metal construction, sturdy and durable

### SPECIFICATION

Code	IST-9WM12	IST-9WM20	IST-9WM30	IST-9WM60	IST-9WM100
Range (clockwise)	2.5~12N.m	4~20N.m	6~30N.m	10~60N.m	20~100N.m
Accuracy	±6% (<10N.m) ±4% (≥10N.m)	±6% (<10N.m) ±4% (≥10N.m)	±6% (<10N.m) ±4% (≥10N.m)	±4%	±4%
Graduation	0.1N.m	0.1N.m	0.2N.m	0.5N.m	0.5N.m
Square driver (D)	1/4"	1/4"	3/8"	3/8"	1/2"
Length	290mm	290mm	318mm	388mm	443mm
Weight	680g	680g	820g	960g	1040g

Code	IST-9WM125	IST-9WM200	IST-9WM335	IST-9WM500	IST-9WM800
Range (clockwise)	25~125N.m	40~200N.m	65~335N.m	100~500N.m	160~800N.m
Accuracy	±4%	±4%	±4%	±4%	±4%
Graduation	0.5N.m	1N.m	1N.m	2.5N.m	4N.m
Square driver (D)	1/2"	1/2"	1/2"	3/4"	3/4"
Length	443mm	468mm	528mm	855mm	1055mm
Weight	1040g	1160g	1300g	5000g	5900g

Code	IST-9WM1000	IST-9WM1500	IST-9WM2000	IST-9WM3000
Range (clockwise)	200~1000N.m	300~1500N.m	400~2000N.m	600~3000N.m
Accuracy	±4%	±4%	±4%	±4%
Graduation	5N.m	5N.m	10N.m	15N.m
Square driver (D)	3/4"	1"	1"	1"
Length	1055mm	1260mm	1260mm	1260mm
Weight	5900g	9200g	9200g	10500g



ATTENTION: DISPLAY PRE-SET TORQUE VALUE (NOT REAL TIME TORQUE)

ATTENTION: CLOCKWISE OPERATION ONLY



## INTERCHANGEABLE HEAD MECHANICAL TORQUE WRENCHES (DIGITAL SETTING)



- Unit: N.m, in.lb, ft.lb, kg.cm
- Mechanical "click" torque wrench, the pre-set torque value is shown on the display

### SPECIFICATION

Code	IST-25WM60	IST-25WM100	IST-25WM140	IST-25WM200	IST-25WM300
Range (clockwise)	12~60N.m	20~100N.m	28~140N.m	40~200N.m	60~300N.m
Accuracy	±3%	±3%	±3%	±3%	±3%
Resolution	0.1N.m	0.1N.m	0.1N.m	0.1N.m	0.1N.m
Socket size (A×B)	12×9mm	12×9mm	18×14mm	18×14mm	18×14mm
Length	408mm	431mm	492mm	510mm	568mm
Weight	1.3kg	1.4kg	1.45kg	1.5kg	1.7kg



### RATCHET HEAD (optional)

Code	Square driver	Applicable wrenches
IST-11WM-R1	1/4"	IST-25WM60 IST-25WM100
IST-11WM-R2	3/8"	IST-25WM60 IST-25WM100
IST-11WM-R3	1/2"	IST-25WM140 IST-25WM200 IST-25WM300
IST-11WM-R4*	3/4"	IST-25WM140 IST-25WM200 IST-25WM300

### BOX END HEAD (optional)

Code	Open size	Applicable wrenches
IST-11WM-M8	8mm	IST-25WM60 IST-25WM100
IST-11WM-M10	10mm	
IST-11WM-M13	13mm	
IST-11WM-M14	14mm	
IST-11WM-M15	15mm	
IST-11WM-M17	17mm	
IST-11WM-M19	19mm	IST-25WM140 IST-25WM200
IST-11WM-M13A	13mm	
IST-11WM-M14A	14mm	
IST-11WM-M15A	15mm	
IST-11WM-M17A	17mm	
IST-11WM-M19A	19mm	
IST-11WM-M22A	22mm	
IST-11WM-M24A	24mm	
IST-11WM-M27A	27mm	
IST-11WM-M30A	30mm	
IST-11WM-M32A	32mm	



### HOOK HEAD (optional)

Hook head	customized according to customer requirements
-----------	---

To be continued

Continued from previous page



### OPEN END HEAD (optional)

Code	Open size	Applicable wrenches
IST-11WM-K6	6mm	IST-25WM60 IST-25WM100
IST-11WM-K7	7mm	
IST-11WM-K8	8mm	
IST-11WM-K9	9mm	
IST-11WM-K10	10mm	
IST-11WM-K11	11mm	
IST-11WM-K12	12mm	
IST-11WM-K13	13mm	
IST-11WM-K14	14mm	
IST-11WM-K15	15mm	
IST-11WM-K16	16mm	
IST-11WM-K17	17mm	
IST-11WM-K18*	18mm	
IST-11WM-K19*	19mm	
IST-11WM-K13A	13mm	IST-25WM140 IST-25WM200 IST-25WM300
IST-11WM-K14A	14mm	
IST-11WM-K15A	15mm	
IST-11WM-K16A	16mm	
IST-11WM-K17A	17mm	
IST-11WM-K18A	18mm	
IST-11WM-K19A	19mm	
IST-11WM-K20A	20mm	
IST-11WM-K21A	21mm	
IST-11WM-K22A	22mm	
IST-11WM-K23A	23mm	
IST-11WM-K24A	24mm	
IST-11WM-K27A*	27mm	
IST-11WM-K30A*	30mm	
IST-11WM-K32A*	32mm	

\*Torque value needs to be corrected for these heads

## MECHANICAL TORQUE WRENCHES (DIGITAL SETTING)

ATTENTION: DISPLAY PRE-SET TORQUE VALUE (NOT REAL TIME TORQUE)

ATTENTION: CLOCKWISE OPERATION ONLY

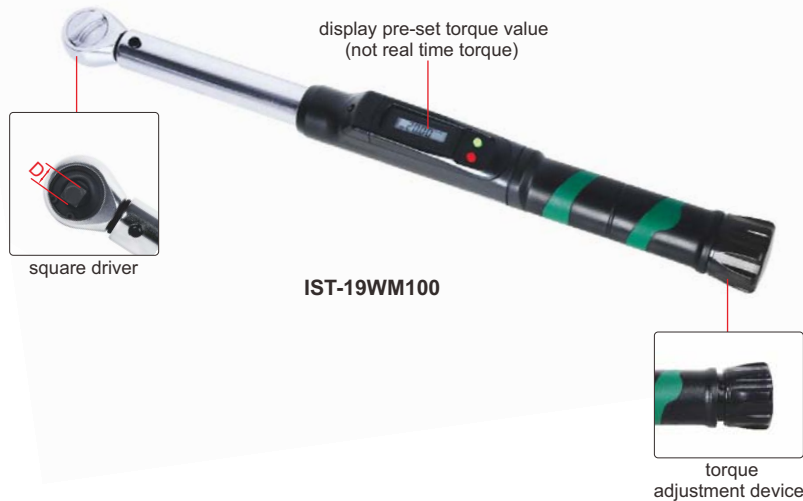

- Unit: N.m, in.lb, ft.lb, kg.cm
- Mechanical "click" torque wrench, the pre-set torque value is shown on the display

### SPECIFICATION

Code	IST-19WM60	IST-19WM100	IST-19WM140	IST-19WM200	IST-19WM300
Range (clockwise)	12~60N.m	20~100N.m	28~140N.m	40~200N.m	60~300N.m
Accuracy	±3%	±3%	±3%	±3%	±3%
Resolution	0.1N.m	0.1N.m	0.1N.m	0.1N.m	0.1N.m
Square driver (D)	3/8"	3/8"	1/2"	1/2"	1/2"
Length	382mm	450mm	481mm	520mm	585mm
Weight	1.3kg	1.4kg	1.45kg	1.6kg	1.8kg

**ATTENTION: CLOCKWISE OPERATION ONLY**

## PRESET TORQUE WRENCHES

- Torque is preset, to prevent adjustment by mistake during use
- The torque is set at the factory before delivery. Customers can also set the torque with torque adjustment tool (**IST-PW-TOOL**, optional) and digital torque testers (**IST-TT□□□□**, optional)
- Clockwise operation only



square driver

**IST-PW60**



torque adjustment tool (optional)

35

### SPECIFICATION

Code	IST-PW12	IST-PW20	IST-PW30	IST-PW60	IST-PW125	IST-PW200
Adjustable range*	2.5~12N.m 22~105in.lb	4~20N.m 36~175in.lb	6~30N.m 55~265in.lb	10~60N.m 8~44ft.lb	25~125N.m 20~90ft.lb	40~200N.m 30~145ft.lb
Accuracy	±3%	±3%	±3%	±3%	±3%	±3%
Square driver (D)	1/4"	1/4"	3/8"	3/8"	3/8"	1/2"
Length	184mm	184mm	214mm	255mm	366mm	457mm
Weight	450g	450g	500g	560g	790g	1200g

Code	IST-PW340	IST-PW500	IST-PW650	IST-PW800	IST-PW1000A	IST-PW1000B
Adjustable range*	65~340N.m 50~250ft.lb	100~500N.m 75~365ft.lb	150~650N.m 110~475ft.lb	160~800N.m 120~585ft.lb	200~1000N.m 150~735ft.lb	200~1000N.m 150~735ft.lb
Accuracy	±3%	±3%	±4%	±4%	±4%	±4%
Square driver (D)	1/2"	3/4"	3/4"	3/4"	3/4"	1"
Length	691mm	910mm	910mm	1037mm	1265mm	1265mm
Weight	1960g	2800g	2800g	5000g	6000g	6000g

### OPTIONAL ACCESSORY

Torque adjustment tool	<b>IST-PW-TOOL</b>
------------------------	--------------------

\* Adjust to a fixed torque value according to customer requirements before delivery

## DIAL TORQUE WRENCHES



square driver

**IST-DW70**



- Clockwise and counter-clockwise operation
- According to DIN ISO 6789, ASME B107.300

### SPECIFICATION

Code	IST-DW1D8	IST-DW3D5	IST-DW9	IST-DW18	IST-DW35	IST-DW70	IST-DW140	IST-DW240	IST-DW350	IST-DW480
Range	0.36~1.8N.m 3~16in.lb	0.7~3.5N.m 6~30in.lb	1.8~9N.m 15~75in.lb	3.6~18N.m 30~150in.lb	7~35N.m 60~300in.lb	14~70N.m 120~600in.lb	28~140N.m 20~100ft.lb	48~240N.m 35~175ft.lb	70~350N.m 50~250ft.lb	96~480N.m 70~350ft.lb
Accuracy	±3%	±3%	±3%	±3%	±3%	±3%	±3%	±3%	±3%	±3%
Graduation	0.02N.m 0.2in.lb	0.05N.m 0.5in.lb	0.1N.m 1in.lb	0.2N.m 2in.lb	0.5N.m 5in.lb	1N.m 10in.lb	2N.m 1ft.lb	3N.m 2.5ft.lb	2.5N.m 2.5ft.lb	6N.m 5ft.lb
Square driver (D)	1/4"	1/4"	1/4"	3/8"	3/8"	3/8"	1/2"	1/2"	1/2"	3/4"
Length	254mm	254mm	254mm	254mm	254mm	378mm	546mm	546mm	546mm	708mm
Weight	480g	480g	480g	480g	480g	820g	1300g	1300g	1300g	4030g

## DIGITAL TORQUE ADAPTERS (WITH ANGLE DETECTION)



working with mechanical wrenches



35



IST-5W135A



- Clockwise and counter-clockwise operation
- After reaching the desired torque, turn the wrench at a angle to apply extra torque
- Unit: N.m, in.lb, ft.lb, kg.cm, degree
- Peak and track working modes
- Target torque or angle value can be set, with audible and visible alarm:
  - Green LED light on and buzzer sounds when torque or angle value is 80%~100% of target torque or angle
  - Both green and red LED light on and buzzer sounds when target torque or angle value is reached
- Power off in 2 minutes automatically
- Memory 50 measurement values for browsing
- With overload record (once the torque reaches 110% of the maximum range)

### SPECIFICATION

Code		IST-5W30A	IST-5W135A	IST-5W200A	IST-5W340A
Range	torque	6~30N.m	27~135N.m	40~200N.m	68~340N.m
	angle	0~999°			
Accuracy	clockwise	±3%			
	counter-clockwise	±4%			
	angle	±2° (rotate at 90°)			
Resolution	torque	0.01N.m	0.1N.m	0.1N.m	0.1N.m
	angle	1°			
Square driver (L)		1/4"	3/8"	1/2"	1/2"
Power supply		2xAAA batteries			
Dimension		Ø85×60mm	Ø85×75mm	Ø85×80mm	Ø85×80mm
Weight		150g	220g	240g	240g

### OPTIONAL ACCESSORY

Calibration cable	IST-SD-CABLE
-------------------	--------------

## DIGITAL ANGLE METER CODE 2177-121

REFER TO PAGE 376  
FOR DETAILS



## TORQUE MULTIPLIERS



IST-TM2000

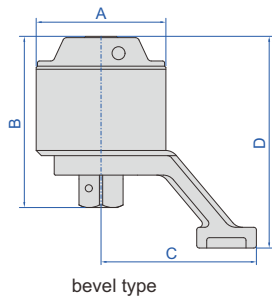

IST-TM3500P

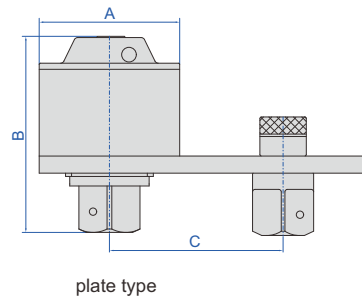

- Input to output accuracy:  $\pm 5\%$

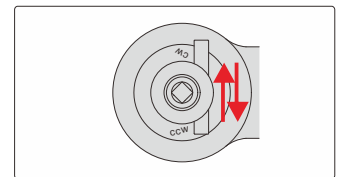

after tightening, toggle the anti-bounce reversing dowel, turn the wrench in the anticlockwise direction, then remove the wrench from torque multiplier

### Z TYPE (BEVEL TYPE) TORQUE MULTIPLIER

Code	Capacity	Torque ratio	Square socket	Square driver	Dimension (A×B×C×D)	For bolt	For nut	Weight
IST-TM1000	1000N.m	1:4	1/2"	1"	82×98.5×97×122.4mm	M20~30	S30~46	2.1kg
IST-TM2000	2000N.m	1:13	1/2"	1"	82×120×105×147mm	M22~35	S32~55	3.15kg
IST-TM3500	3500N.m	1:16	1/2"	1"	98×131×120×163mm	M30~45	S46~70	4.9kg
IST-TM5500	5500N.m	1:20.5	1/2"	1 1/2"	115×163.5×137×199mm	M38~52	S55~80	8.1kg
IST-TM7500	7500N.m	1:23	1/2"	1 1/2"	127×173×146×215mm	M42~60	S65~90	10.6kg
IST-TM10000	10000N.m	1:28	1/2"	1 1/2"	141×170×164×238mm	M52~72	S80~105	14kg

### L TYPE (PLATE TYPE) TORQUE MULTIPLIER

Code	Capacity	Torque ratio	Square socket	Square driver	Dimension (A×B×C)	For bolt	For nut	Weight
IST-TM1000P	1000N.m	1:4	1/2"	1"	82×91×(76.7~127.3)mm	M20~30	S30~46	2.4kg
IST-TM2000P	2000N.m	1:13	1/2"	1"	82×120×(92.7~129.3)mm	M22~35	S32~55	3.5kg
IST-TM3500P	3500N.m	1:16	1/2"	1"	98×128×(102.7~145.3)mm	M30~45	S46~70	5.0kg
IST-TM5500P	5500N.m	1:20.5	1/2"	1 1/2"	115×157×(134.05~165.95)mm	M38~52	S55~80	8.7kg
IST-TM7500P	7500N.m	1:23	1/2"	1 1/2"	127×168×(139.05~190.95)mm	M42~60	S65~90	11.7kg
IST-TM10000P	10000N.m	1:28	1/2"	1 1/2"	141×186×(144.05~215.95)mm	M52~72	S80~105	15.2kg
IST-TM15000P	15000N.m	1:50	3/4"	2 1/2"	156×246×(155.25~244.75)mm	M60~85	S80~120	24.1kg
IST-TM20000P	20000N.m	1:76	3/4"	2 1/2"	170×264×(163.75~276.25)mm	M72~100	S105~145	27.8kg

## SPLINE-TYPE TORQUE MULTIPLIERS

after tightening, toggle the anti-bounce reversing dowel, turn the wrench in the anticlockwise direction, then remove the wrench from torque multiplier

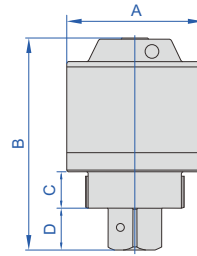
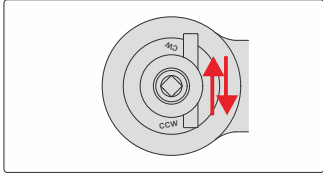

IST-ST2000



- High efficiency gear set with small input torque and large output torque
- Can be installed directly on the workpieces or through different options to form different installation types

plate type



bevel type



### SPECIFICATION

Code	Type	Capacity	Accuracy	Torque ratio	Square socket	Square driver	Dimension (A×B×C×D)	For bolt	For nut	Weight				
IST-ST2000	plate	2000N.m	±5%	1:13.3	1/2"	1"	82×135×18×26mm	M22~35	S32~55	3.2kg				
	bevel			1:12										
IST-ST3500	plate	3500N.m		1:16	1/2"	1"								
	bevel			1:15										
IST-ST5500	plate	5500N.m		1:21.5	1/2"	1 1/2"					115×180×29×39mm	M38~52	S55~80	7.8kg
	bevel			1:18.5										
IST-ST7500	plate	7500N.m	1:24	1/2"	1 1/2"									
	bevel		1:20											

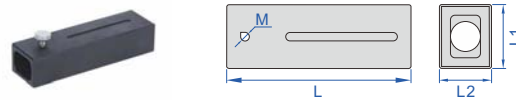
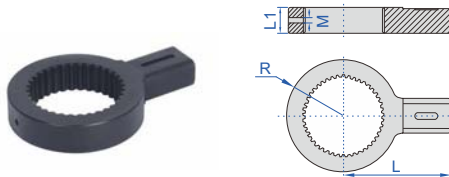

#### CONNECTION SPLINE (optional)

Code	Dimension (mm)			
	R	L	L1	M
IST-ST2000-C1	41	78	18	5
IST-ST3500-C2	49	95	23	5
IST-ST5500-C3	58	112	28.5	6
IST-ST7500-C4	63.5	123.5	29	6

#### PLATE REACTION ARM (optional)

Code	Dimension (mm)			
	L	L1	L2	M
IST-ST2000-P1	120	38	25.5	4
IST-ST3500-P2	145	42	32	5
IST-ST5500-P3	150	53	45	6
IST-ST7500-P4	175	60	49	8

To be continued

Continued from previous page

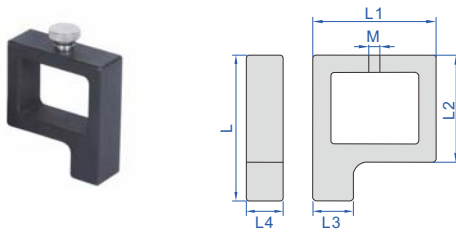

REACTION BLOCK (optional)

Code	Dimension (mm)					
	L	L1	L2	L3	L4	M
IST-ST2000-R1	53.5	52	39.5	15	18	4
IST-ST3500-R2	66	58	48	18	20	5
IST-ST5500-R3	94.5	73	65	22	25	6
IST-ST7500-R4	98	83	72	28	25	8

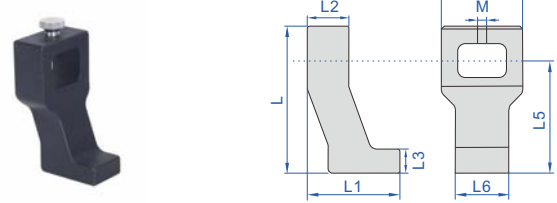

BEVEL REACTION ARM (optional)

Code	Dimension (mm)								
	L	L1	L2	L3	L4	L5	L6	M	
IST-ST2000-B1	85	51	18	14	44	60	25	4	
IST-ST3500-B2	87.5	52	20	15	50	67	30	5	
IST-ST5500-B3	110	70	30	16	59	86	35	6	
IST-ST7500-B4	123	78	35	20	68	94	45	6	



IST-DT2000

- High efficiency gear set with small input torque and large output torque
- The reaction arm can adjust the position of the applied force according to the operation conditions
- Plate reaction arm and bevel reaction arm are included

## TWO-USE TORQUE MULTIPLIERS

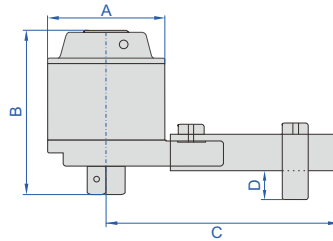
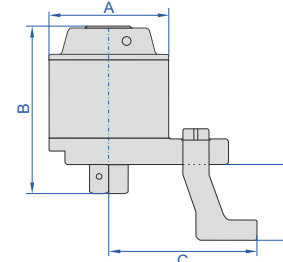
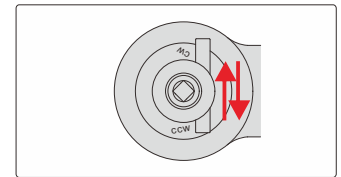

plate type



bevel type

after tightening, toggle the anti-bounce reversing dowel, turn the wrench in the anticlockwise direction, then remove the wrench from torque multiplier



application



plate type



bevel type



## SPECIFICATION

Code	Type	Capacity	Accuracy	Torque ratio	Square socket	Square driver	Dimension (A×B×C×D)	For bolt	For nut	Weight
IST-DT2000	plate	2000N.m	±5%	1:13.3	1/2"	1"	82×120×160×21mm	M22~35	S32~55	4.1kg
	bevel			1:12			82×120×93×52mm			
IST-DT3500	plate	3500N.m		1:16	1/2"	1"	98×133×152×26mm	M30~45	S46~70	6.4kg
	bevel			1:15			98×133×117×56mm			
IST-DT5500	plate	5500N.m		1:21.5	1/2"	1 1/2"	115×165×210×39.5mm	M38~52	S55~80	11.4kg
	bevel			1:18.5			115×165×134×72mm			
IST-DT7500	plate	7500N.m		1:24	1/2"	1 1/2"	127×174×243×38mm	M42~60	S65~90	16kg
	bevel			1:20			127×174×146×80mm			



Electronic Balances  
Page 905-909



Explosion Proof Electronic Balances  
Page 909



Weighing Scales  
Page 910/912



Counting Scales  
Page 911



Electronic Pocket Scales  
Page 911-912



Platform Scales  
Page 913



Floor Scales  
Page 914



Electronic Crane Scales  
Page 915-917



Moisture Analyzers  
Page 918



Weights  
Page 919-920





DATA  
OUTPUT

ELECTRONIC BALANCES (0.1mg)



printer (optional)



calibration weight  
(included in 8310-120M,  
8310-210M and 8310-320M)



8310-320A

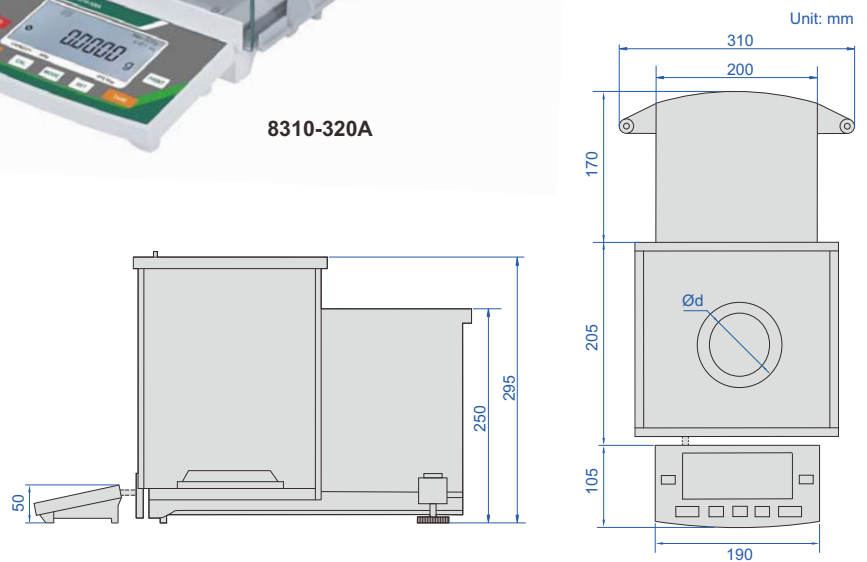

- Rear electromagnetic sensor
- Separated display unit and weighing unit, reduce vibration error
- Digital processing technology improves reading stability and response speed for micro sample addition, sample weight and balance reading is consistent
- Unit: g, oz, ct, lb
- Weighing, counting, taring, percentage
- Data output

SPECIFICATION

Code	8310-120M	8310-210M	8310-320M	8310-120A	8310-210A	8310-320A
Calibration	external calibration			internal calibration		
Maximum weighing	120g	210g	320g	120g	210g	320g
Minimum weighing	10mg	10mg	10mg	10mg	10mg	10mg
Resolution (d)	0.1mg	0.1mg	0.1mg	0.1mg	0.1mg	0.1mg
Verification interval (e)	1mg	1mg	1mg	1mg	1mg	1mg
Accuracy (m is load)	m≤50g: ±0.5mg; 50g<m≤200g: ±1mg; m>200g: ±1.5mg			m≤50g: ±0.5mg; 50g<m≤200g: ±1mg; m>200g: ±1.5mg		
Repeatability	±0.1mg					
Linearity	±0.1mg					
Stabilization time	2.5s					
Weighing pan size (Ød)	Ø90mm					
Output	RS232					
Operation temperature	10~30°C					
Operation humidity	20~85% RH					
Power supply	power adapter (12V/2A)					
Dimension (L×W×H)	480×310×320mm					
Weight	6kg					

OPTIONAL ACCESSORY

RS232 cable	8304-CABLE *
Printer	8303-PRINTER

\* Used to connect with computers

## ELECTRONIC BALANCES (0.1mg)

DATA OUTPUT

36



8304-120



calibration weight (included)



printer (optional)

- Electromagnetic sensor
- Unit: g, ct, oz, lb
- Weighing, counting, taring
- Data output

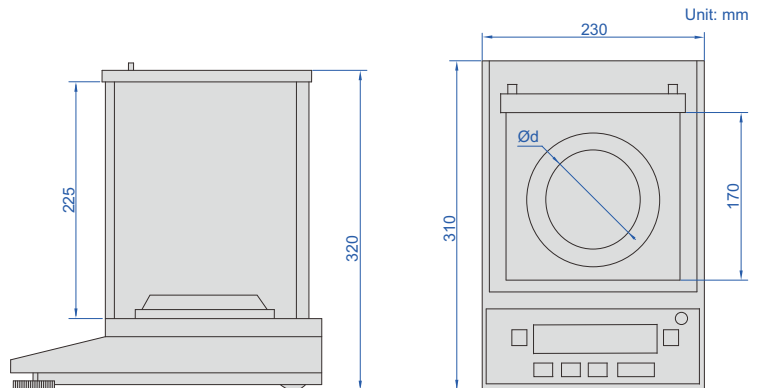

### SPECIFICATION

Code	8304-120	8304-220
Maximum weighing	120g	220g
Minimum weighing	10mg	10mg
Resolution (d)	0.1mg	0.1mg
Verification interval (e)	1mg	1mg
Accuracy (m is load)	m≤50g: ±0.5mg; 50g<m≤120g: ±1mg	m≤50g: ±0.5mg; 50g<m≤200g: ±1mg; m>200g: ±1.5mg
Weighing pan size (Ød)	Ø90mm	
Operation temperature	10~30°C	
Operation humidity	20~85% RH	
Power supply	power adapter (12V/2A)	
Dimension (L×W×H)	230×310×320mm	

### OPTIONAL ACCESSORY

RS232 cable	8304-CABLE *
Printer	8303-PRINTER
Data output cable (keyboard format)	7302-8304 page 14

\*Used to connect with computers

DATA  
OUTPUT

## ELECTRONIC BALANCES (1mg)

36



calibration weight (included)

8303-520

Unit: mm

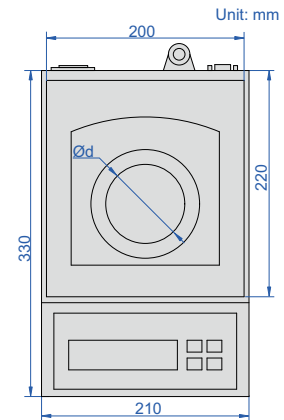
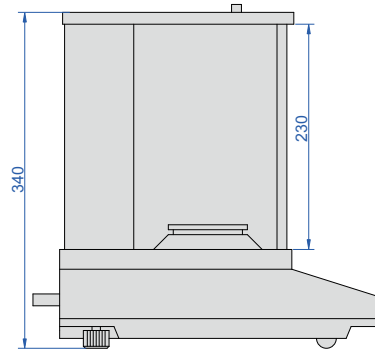

- Aluminum alloy shell, wind shield, three side glass sliding doors
- Electromagnetic balance sensor
- Unit: g, ct, ozt, oz, gn, dwt, mg
- Weighing, counting, taring
- Data output
- With a hook at the bottom

### SPECIFICATION

Code	8303-220	8303-320	8303-520	8303-620	8303-1020
Maximum weighing	220g	320g	520g	620g	1020g
Minimum weighing	20mg	20mg	100mg	100mg	100mg
Resolution (d)	1mg	1mg	1mg	1mg	1mg
Verification interval (e)	10mg	10mg	10mg	10mg	10mg
Accuracy	load capacity≤500g: ±5mg; load capacity>500g: ±10mg				
Weighing pan size (Ød)	Ø80mm				Ø120mm
Operation temperature	15~30°C		18~23°C		
Operation humidity	40%~80% RH		50%~70% RH		
Power supply	220V, 50/60Hz				
Dimension (L×W×H)	330×210×340mm				

### OPTIONAL ACCESSORY

RS232 cable	8301-CABLE *
Printer	8303-PRINTER



printer (optional)

\* Used to connect with computers

# ELECTRONIC BALANCES (0.01g)

DATA  
OUTPUT



36



8305-5000

- LCD with back light
- Unit: g, ct, ozt, oz, GN, dwt, lb, kg
- Weighing, counting, taring



calibration weight  
(included in 8305-2000  
and 8305-3000)

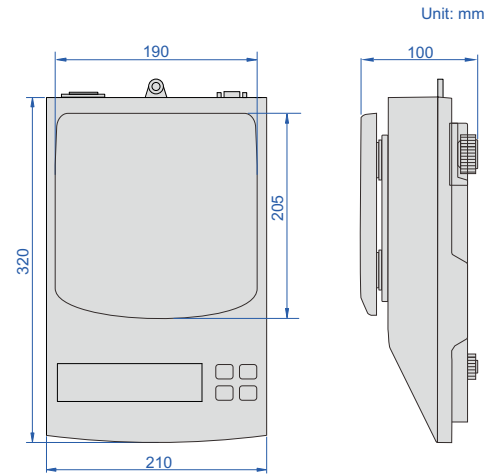

## SPECIFICATION

Code	8305-2000	8305-3000	8305-5000	8305-6000
Maximum weighing	2kg	3kg	5kg	6kg
Minimum weighing	0.2g	0.2g	0.2g	0.2g
Resolution (d)	0.01g	0.01g	0.01g	0.01g
Verification interval (e)	0.1g	0.1g	0.1g	0.1g
Accuracy (m is load)	m≤0.5kg: ±0.05g; 0.5kg<m≤2kg: ±0.1g	m≤0.5kg: ±0.05g; 0.5kg<m≤2kg: ±0.1g m>2kg: ±0.15g	m≤0.5kg: ±0.05g; 0.5kg<m≤2kg: ±0.1g m>2kg: ±0.15g	m≤0.5kg: ±0.05g; 0.5kg<m≤2kg: ±0.1g m>2kg: ±0.15g
Weighing pan size	190×205mm			
Output	RS232			
Operation temperature	0~40°C			
Operation humidity	≤80% RH			
Power supply	220V, 50/60Hz			
Dimension (L×W×H)	320×210×100mm			

## OPTIONAL ACCESSORY

RS232 cable	8301-CABLE*
Printer	8303-PRINTER
Data output cable (keyboard format)	7302-8001 page 14
Wireless transmitter (need receiver)	7315-8301 page 6

\*Used to connect with computers



printer (optional)

DATA  
OUTPUT

Ex

**EXPLOSION PROOF ELECTRONIC BALANCES**

**8105-30KG**

- LCD display, with backlight
- Zero-setting, subtracting tare value, counting
- Unit: g, ct, oz, lb, ozt

**SPECIFICATION**

Code	8105-5KG	8105-30KG
Maximum weighing	5kg	30kg
Minimum weighing	0.5g	5g
Resolution (d)	0.01g	0.1g
Verification interval (e)	0.1g	1g
Accuracy (m is load)	m≤0.05kg: ±0.05g; 0.05kg≤m≤0.2kg: ±0.1g; 0.2kg≤m≤5kg: ±0.15g	m≤0.5kg: ±0.5g; 0.5kg≤m≤2kg: ±1.0g; m>2kg: ±1.5g
Dimension of pan	170×170mm	
Output	RS232	
Operation temperature	15~30°C	
Operation humidity	40%~80% RH	
Power	explosion-proof battery, DC7.4V/4.0Ah	
Dimension (L×W×H)	290×185×80mm	

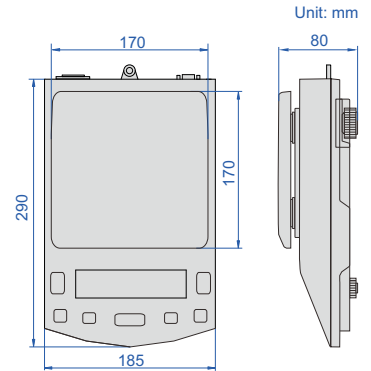
**OPTIONAL ACCESSORY**

RS232 cable	8105-CABLE*
-------------	-------------

\* Used to connect with computers

 DATA  
OUTPUT

**ELECTRONIC BALANCES**

- Automatic zero when power on
- Unit: g (gram), ct (carat), ozt (troy ounce)
- Weighing, counting, taring
- Overload alarm
- Data output



**8301-3000**

 windshield  
(included in 8301-300, 8301-600 and 8301-1200)

 calibration weight  
(included in 8301-300, 8301-600 and 8301-1200)

**SPECIFICATION**

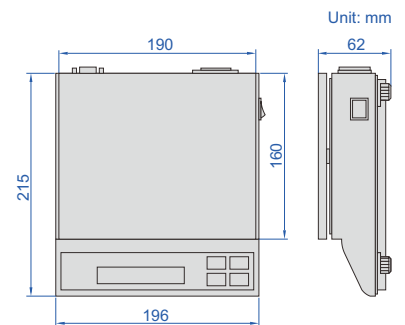
Code	8301-300	8301-600	8301-1200	8301-3000	8301-6000
Maximum weighing	300g	600g	1200g	3000g	6000g
Minimum weighing	0.2g	0.2g	0.2g	2g	2g
Resolution (d)	0.01g	0.01g	0.01g	0.1g	0.1g
Verification interval (e)	0.1g	0.1g	0.1g	1g	1g
Accuracy (m is load)	m≤50g: ±0.05g; 50g<m≤200g: ±0.1g; m>200g: ±0.15g			m≤500g: ±0.5g; 500g<m≤2000g: ±1g; m>2000g: ±1.5g	
Weighing pan size	Ø135mm			190×160mm	
Operation temperature	0~40°C				
Operation humidity	≤80% RH				
Power supply	220V, 50/60Hz				
Dimension (L×W×H)	215×196×62mm				

**OPTIONAL ACCESSORY**

RS232 cable	8301-CABLE
Data output cable (keyboard format)	7302-8001 page 14
Wireless transmitter (need receiver)	7315-8301 page 6

## WEIGHING SCALES (OIML CERTIFICATE)



36

- LCD display, with backlight
- Zero-setting, subtracting tare value
- Overload alarm
- Automatic power off
- OIML certificate (No. 0200-NAWI-04601)



8002-30M

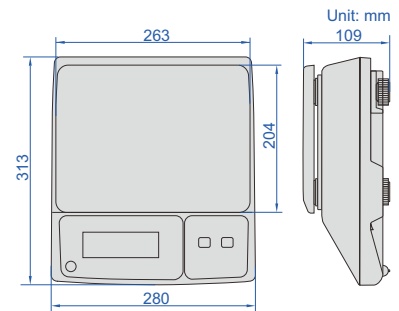

### SPECIFICATION

Code	8002-6M	8002-15M	8002-30M	8002-6MD	8002-15MD	8002-30MD
Maximum weighing	3/6kg	6/15kg	15/30kg	3/6kg	6/15kg	15/30kg
Minimum weighing	20g	40g	100g	20g	40g	100g
Resolution (d)	1/2g	2/5g	5/10g	1/2g	2/5g	5/10g
Verification interval (e)	2g	5g	10g	2g	5g	10g
Accuracy (m is load)	m≤3kg: ±1g 3kg<m≤6kg: ±2g	m≤6kg: ±2g 6kg<m≤15kg: ±5g	m≤15kg: ±5g 15kg<m≤30kg: ±10g	m≤3kg: ±1g 3kg<m≤6kg: ±2g	m≤6kg: ±2g 6kg<m≤15kg: ±5g	m≤15kg: ±5g 15kg<m≤30kg: ±10g
Output	no			RS232		
Operation temperature	-10~40°C					
Power	rechargeable battery (6V/3.2Ah), power adapter (12V/500mA)					
Dimensions of pan	263×204mm					

## WEIGHING SCALES (HIGH PRECISION)



printer (optional)

- LCD display, with backlight
- Zero-setting, subtracting tare value
- Overload alarm
- Automatic power off



8001-30

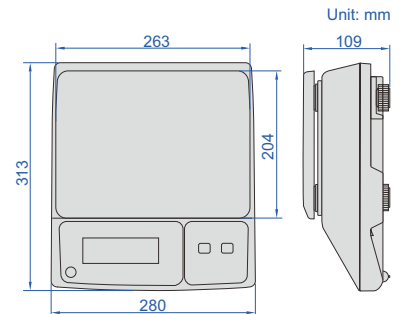

### SPECIFICATION

Code	8001-6	8001-15	8001-30	8001-6D	8001-15D	8001-30D
Maximum weighing	6kg	15kg	30kg	6kg	15kg	30kg
Minimum weighing	4g	10g	20g	4g	10g	20g
Resolution (d)	0.2g	0.5g	1g	0.2g	0.5g	1g
Accuracy (m is load)	m≤1kg: ±1g 1kg<m≤4kg: ±2g m>4kg: ±3g	m≤2.5kg: ±2.5g 2.5kg<m≤10kg: ±5g m>10kg: ±7.5g	m≤5kg: ±5g 5kg<m≤20kg: ±10g m>20kg: ±15g	m≤1kg: ±1g 1kg<m≤4kg: ±2g m>4kg: ±3g	m≤2.5kg: ±2.5g 2.5kg<m≤10kg: ±5g m>10kg: ±7.5g	m≤5kg: ±5g 5kg<m≤20kg: ±10g m>20kg: ±15g
Units	kg, lb			kg		
Output	no			RS232		
Operation temperature	-10~40°C					
Power	rechargeable battery (6V/3.2Ah), power adapter (12V/500mA)					
Dimensions of pan	263×204mm					

### OPTIONAL ACCESSORY (for scales with RS232)

Printer	8001-PRINTER
Data output cable (keyboard format)	7302-8001 page 14

## COUNTING SCALES



printer (optional)

- LCD display, with backlight
- Zero-setting, subtracting tare value, counting, accumulation, checking alarm
- Overload alarm
- Units: kg, g, lb, tj, hj, lb-oz

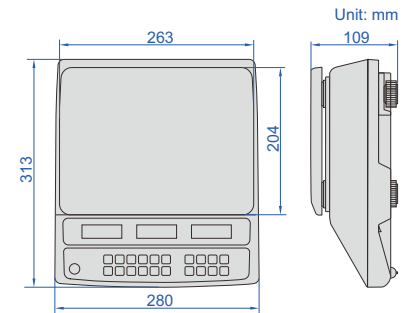
**8101-30**

### SPECIFICATION

Code	8101-6	8101-15	8101-30	8101-6D	8101-15D	8101-30D
Maximum weighing	6kg	15kg	30kg	6kg	15kg	30kg
Minimum weighing	4g	10g	20g	4g	10g	20g
Resolution (d)	0.2g	0.5g	1g	0.2g	0.5g	1g
Accuracy (m is load)	m≤1kg: ±1g 1kg<m≤4kg: ±2g m>4kg: ±3g	m≤2.5kg: ±2.5g 2.5kg<m≤10kg: ±5g m>10kg: ±7.5g	m≤5kg: ±5g 5kg<m≤20kg: ±10g m>20kg: ±15g	m≤1kg: ±1g 1kg<m≤4kg: ±2g m>4kg: ±3g	m≤2.5kg: ±2.5g 2.5kg<m≤10kg: ±5g m>10kg: ±7.5g	m≤5kg: ±5g 5kg<m≤20kg: ±10g m>20kg: ±15g
Output	no			RS232		
Operation temperature	-10~40°C					
Power	rechargeable battery (6V/3.2Ah), power adapter (12V/500mA)					
Dimensions of pan	263×204mm					

### OPTIONAL ACCESSORY (for scales with RS232)

Printer	8001-PRINTER
---------	--------------

**ATTENTION:**  
LOW ACCURACY

## ELECTRONIC POCKET SCALE (ECONOMIC TYPE)

- LCD display, with backlight
- Zero-setting, subtracting tare value, counting
- Overload alarm
- Automatic power off

**8601-100**

### SPECIFICATION

Code	8601-100
Maximum weighing	100g
Minimum weighing	0.1g
Resolution (d)	0.01g
Accuracy (m is load)	0.1g≤m≤1g: ±0.03g; 1g<m≤30g: ±0.05g 30g<m≤50g: ±0.07g; m>50g: ±0.14g
Units	g, oz, dwt, ozt
Dimension of pan	55×64mm
Dimension (L×W×H)	108×65×21mm
Operation temperature	-10~40°C
Power supply	2×AAA batteries

use of pan



## ELECTRONIC POCKET SCALE (ECONOMIC TYPE)

ATTENTION:  
LOW ACCURACY

36

- LCD display, with backlight
- Zero-setting, subtracting tare value, counting
- Overload alarm
- Automatic power off



8602-200

### SPECIFICATION

<b>Code</b>	<b>8602-200</b>
<b>Maximum weighing</b>	200g
<b>Minimum weighing</b>	0.2g
<b>Resolution (d)</b>	0.02g
<b>Accuracy (m is load)</b>	0.2g≤m≤2g: ±0.06g; 2g<m≤60g: ±0.1g 60g<m≤100g: ±0.14g; m>100g: ±0.28g
<b>Units</b>	g, oz, dwt, ozt
<b>Dimension of pan</b>	55×64mm
<b>Dimension (L×W×H)</b>	120×70×17mm
<b>Operation temperature</b>	-10~40°C
<b>Power supply</b>	2×CR2032 batteries

use of pan



## WEIGHING SCALES (ECONOMIC TYPE)

- Unit: g, oz, lb, tl



8003-3

### SPECIFICATION

Code	8003-3	8003-6	8003-10
<b>Maximum weighing</b>	3kg	6kg	10kg
<b>Minimum weighing</b>	2g	10g	20g
<b>Resolution (d)</b>	0.1g	0.5g	1g
<b>Accuracy</b>	±0.5g	±2.5g	±5g
<b>Weighing pan size</b>	157×157mm		
<b>Operation temperature</b>	5~35°C		
<b>Power supply</b>	2×AAA batteries, power adapter		
<b>Dimension (L×W)</b>	160×225mm		



DATA  
OUTPUT

PLATFORM SCALES



8501-AL150



printer (optional)

- LCD large screen display with LED backlight
- Weighing, overweight alarm, counting, keyboard lock, accumulating, auto zero and animal scale
- Unit: kg, g, lb, oz

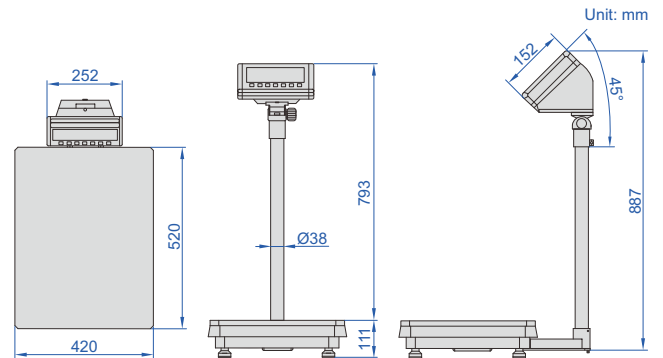

SPECIFICATION

Code	8501-AL60	8501-AL150	8501-AL300
Maximum weighing	60kg	150kg	300kg
Minimum weighing	100g	200g	400g
Resolution (d)	5g	10g	20g
Accuracy	±10g	±20g	±30g
Operation temperature	-10~40°C		
Material	platform: stainless steel, base: die-cast aluminum		
Dimension of platform	420×520mm		
Power	rechargeable lead acid battery (6V/4Ah)		
Output	RS232		
Weight	18.3kg		

OPTIONAL ACCESSORY

Printer	8001-PRINTER
Data output cable (keyboard format)	7302-8001 page 14

## FLOOR SCALES

DATA  
OUTPUT

36

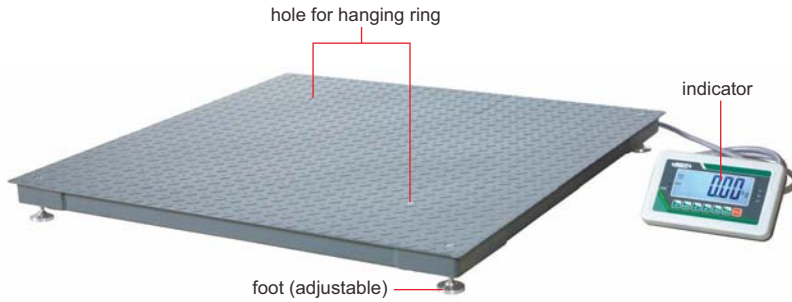

8401-1T1212

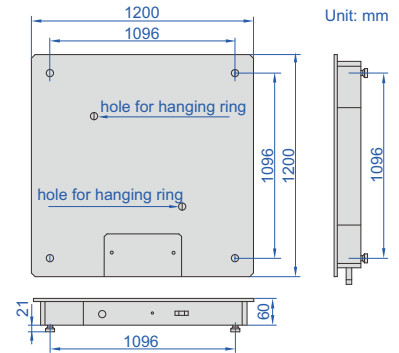

- LCD large screen display with automatic backlight
- Zero, overweight alarm, deduction, unit conversion, accumulating, animal scale, etc.
- Unit: kg, g, lb, oz
- OIML approved load cell

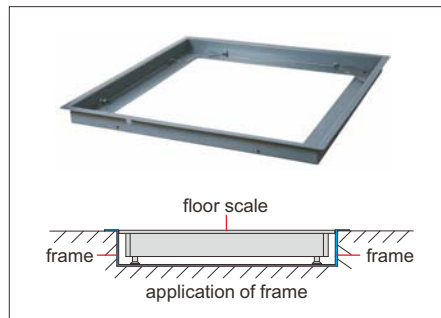

frame (optional)



stand (optional)

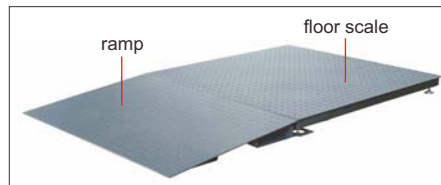

ramp (optional)



printer (optional)

### SPECIFICATION

Code	8401-1T1212	8401-2T1212	8401-3T1212
Maximum weighing	1t	2t	3t
Minimum weighing	10kg	20kg	20kg
Resolution (d)	0.5kg	1kg	1kg
Verification interval (e)	0.5kg	1kg	1kg
Accuracy (m is load)	m≤250kg: ±0.25kg; 250kg<m≤1000kg: ±0.5kg	m≤500kg: ±0.5kg; 500kg<m≤2000kg: ±1kg; m>2000kg: ±1.5kg	
Load cell	4 pcs 350Ω		
Operation temperature	-10~40°C		
Material	mild steel		
Dimension of platform	1200×1200mm		
Power	rechargeable lead acid battery (6V/4Ah)		
Output	RS232		
Weight	140kg		

### STANDARD DELIVERY

Main unit	1 pc
Indicator	1 pc
AC/DC adapter	1 pc
Stainless steel foot	4 pcs
Hanging ring	2 pcs

### OPTIONAL ACCESSORY

Ramp	8401-1212-1
Frame	8401-1212-2
Stand	8401-STAND
Printer	8001-PRINTER

**IP65**  
WATERPROOF

- Dust/waterproof level: IP65
- LED display, remote control
- Low voltage indicator
- Unit: kg, lb
- Automatic power off
- Overload alarm
- 360° safe rotary hook and shackle
- Aluminum alloy die casting case with high strength

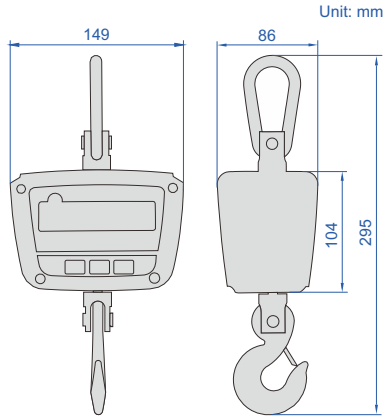

**SPECIFICATION**

Code	8201-50KG	8201-150KG	8201-300KG
Maximum weighing	50kg	150kg	300kg
Minimum weighing	0.4kg	1.0kg	2.0kg
Resolution (d)	0.02kg/0.01kg	0.05kg/0.02kg	0.10kg/0.05kg
Verification interval (e)	0.02kg	0.05kg	0.10kg
Accuracy	±0.02kg	±0.05kg	±0.10kg
Operation temperature	-10~40°C		
Operation humidity	30%~90% RH		
Overload alarm	100%F.S.+9e		
Maximum safe load	125%F.S.		
Limited overload	400%F.S.		
Power supply	rechargeable battery 6V/3Ah (for 40 hours working)		
Stable reading time	≤8s		

**ELECTRONIC CRANE SCALES**



remote controller (included)

8201-150KG

**STANDARD DELIVERY**

Main unit	1 pc
Remote controller	1 pc
Battery charger	1 pc

- LED display, remote control
- Low voltage indicator
- Unit: kg, lb
- Automatic power off
- Overload alarm
- 360° safe rotary hook and shackle
- Plastic case

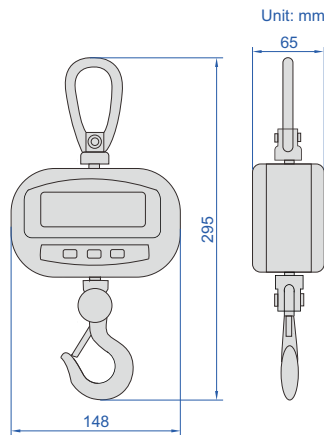

**SPECIFICATION**

Code	8202-50KG	8202-150KG	8202-300KG
Maximum weighing	50kg	150kg	300kg
Minimum weighing	0.4kg	1.0kg	2.0kg
Resolution (d)	0.02kg/0.01kg	0.05kg/0.02kg	0.10kg/0.05kg
Verification interval (e)	0.02kg	0.05kg	0.10kg
Accuracy	±0.02kg	±0.05kg	±0.10kg
Operation temperature	-10~40°C		
Operation humidity	30%~90% RH		
Overload alarm	100%F.S.+9e		
Maximum safe load	125%F.S.		
Limited overload	400%F.S.		
Power supply	4×1.5V AA batteries (for 40 hours working)		
Stable reading time	≤8s		

**ELECTRONIC CRANE SCALES (BASIC TYPE)**



remote controller (included)

8202-150KG

**STANDARD DELIVERY**

Main unit	1 pc
Remote controller	1 pc

## ELECTRONIC CRANE SCALES

36

- Zeroing, taring, weighing
- LED display, remote control
- Low voltage indicator
- Unit: kg, lb
- Overload alarm
- Automatic power off
- Aluminum alloy die casting case with high strength

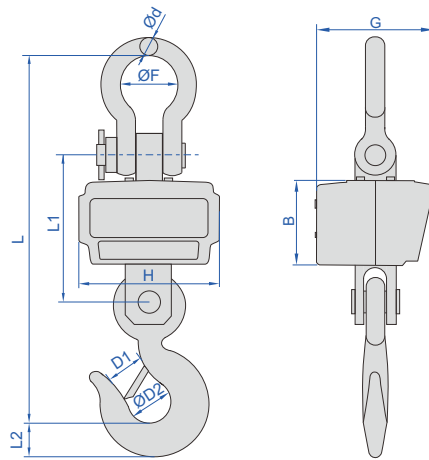

8204-CS3T



remote controller (included)

(mm)

Code	B	G	H	L	L1	L2	D1	ØD2	Ød	ØF
8204-CS06T	120	163	198	420	190	33	40	47	21	76
8204-CS1T	120	163	198	420	190	33	40	47	21	76
8204-CS2T	120	163	198	420	190	33	50	47	21	76
8204-CS3T	120	163	198	462	196	40	50	50	23	76
8204-CS5T	120	163	198	511	204	47	52	60	26	80
8204-CS10T	135	181	206	589	239	66	52	70	36	90
8204-CS15T	135	181	206	727	257	77	60	85	47	135

### SPECIFICATION

Code	8204-CS06T	8204-CS1T	8204-CS2T	8204-CS3T
Maximum weighing	600kg	1000kg	2000kg	3000kg
Minimum weighing	4kg	10kg	20kg	20kg
Resolution (d)	0.2kg/0.1kg	0.5kg/0.2kg	1kg/0.5kg	1kg/0.5kg
Verification interval (e)	0.2kg	0.5kg	1kg	1kg
Accuracy (m is load)	m≤100kg: ±0.1kg; 50kg<m≤200kg: ±0.2kg; m>200kg: ±0.3kg	m≤250kg: ±0.25kg; 250kg<m≤1000kg: ±0.5kg	m≤500kg: ±0.5kg; 500kg<m≤2000kg: ±1kg	m≤500kg: ±0.5kg; 500kg<m≤2000kg: ±1kg; m>2000kg: ±1.5kg
Overload alarm	100%F.S.+9e			
Maximum safe load	150%F.S.			
Limited overload	400%F.S.			
Stable reading time	≤8s			
Power supply	rechargeable battery 6V/4Ah (for 40 hours working)			
Operation temperature	-10~40°C			
Operation humidity	≤85% RH			

Code	8204-CS5T	8204-CS10T	8204-CS15T
Maximum weighing	5000kg	10000kg	15000kg
Minimum weighing	40kg	100kg	100kg
Resolution (d)	2kg/1kg	5kg/2kg	5kg/2kg
Verification interval (e)	2kg	5kg	5kg
Accuracy (m is load)	m≤1000kg: ±1kg; 1000kg<m≤4000kg: ±2kg; m>4000kg: ±3kg	m≤2500kg: ±2.5kg; 2500kg<m≤10000kg: ±5kg	m≤2500kg: ±2.5kg; 2500kg<m≤10000kg: ±5kg; m>10000kg: ±7.5kg
Overload alarm	100%F.S.+9e		
Maximum safe load	150%F.S.		
Limited overload	400%F.S.		
Stable reading time	≤8s		
Power supply	rechargeable battery 6V/4Ah (for 40 hours working)		
Operation temperature	-10~40°C		
Operation humidity	≤85% RH		

To be continued

Continued from previous page

**STANDARD DELIVERY**

Main unit	1 pc
Remote controller	1 pc
Battery charger	1 pc



handheld display (optional)



large display (optional)

**OPTIONAL ACCESSORY**

Handheld display	8204-INDICATOR (must be supplied with scales together)
Large display	8204-SCREEN (must be supplied with scales together)

**ELECTRONIC CRANE SCALES**

- Zeroing, taring, weighing
- LED display, remote control
- Low voltage indicator
- Unit: kg, lb
- Overload alarm
- Automatic power off
- Aluminum alloy die casting case with high strength



8203-CW05T



remote controller (included)

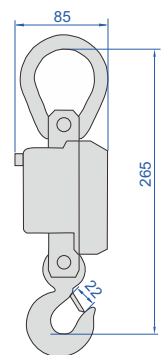
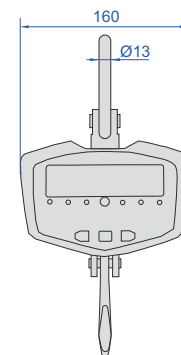

Unit: mm

**SPECIFICATION**

Code	8203-CW03T	8203-CW05T	8203-CW1T
Maximum weighing	300kg	500kg	1000kg
Minimum weighing	2kg	4kg	10kg
Resolution (d)	0.1kg/0.05kg	0.2kg/0.1kg	0.5kg/0.2kg
Verification interval (e)	0.1kg	0.2kg	0.5kg
Accuracy (m is load)	m≤50kg: ±0.05kg; 50kg<m≤200kg: ±0.1kg; m>200kg: ±0.15kg	m≤100kg: ±0.1kg; 100kg<m≤400kg: ±0.2kg; m>400kg: ±0.3kg	m≤250kg: ±0.25kg; 250kg<m≤1000kg: ±0.5kg
Overload alarm	100%F.S.+9e		
Maximum safe load	150%F.S.		
Limited overload	400%F.S.		
Stable reading time	<10s		
Power supply	3×1.5V AA batteries		
Operation temperature	-10~40°C		
Operation humidity	30%~90% RH		

**STANDARD DELIVERY**

Main unit	1 pc
Remote controller	1 pc

# MOISTURE ANALYZERS

DATA  
OUTPUT



36



8701-RM40



calibration weight  
(included)

- LCD screen
- High sensitivity temperature and humidity sensor
- Ring halogen lamp heating evenly, shorten drying time

### SPECIFICATION

Code	8701-RM20	8701-RM30	8701-RM40
Maximum weighing	120g	120g	120g
Resolution (d)	5mg	1mg	0.1mg
Accuracy for moisture	sample<10g	±10%	±0.5%
	sample≥10g	±5%	±0.3%
Operation temperature	13~25°C		
Verification interval	2.5s		
Warm-up time	20~30 minutes		
Weighing pan size	Ø90mm		
Heating source	halogen lamp (450W)		
Range for heating temperature	60~200°C		
Heating time setting	0~99 minutes		
Heating mode	standard heating, step heating, rapid heating		
Shutdown mode	automatic shutdown, manual shutdown, timed shutdown		
Output	RS232C		
Power supply	220V, 50/60Hz		
Dimension (L×W×H)	330×210×340mm		

### STANDARD DELIVERY

Main unit	1 pc
Weight	1 pc

### OPTIONAL ACCESSORY

RS232 cable	8304-CABLE *
Printer	8303-PRINTER

\*Used to connect with computers



1kg      200g      500mg      200mg      100mg

- Supplied with manufacturer inspection certificate

**OIML R111-2004 TOLERANCE**

Weight	E2	F1	F2	M1
1mg	0.006mg	0.020mg	0.06mg	0.20mg
2mg	0.006mg	0.020mg	0.06mg	0.20mg
5mg	0.006mg	0.020mg	0.06mg	0.20mg
10mg	0.008mg	0.025mg	0.08mg	0.25mg
20mg	0.010mg	0.03mg	0.10mg	0.3mg
50mg	0.012mg	0.04mg	0.12mg	0.4mg
100mg	0.016mg	0.05mg	0.16mg	0.5mg
200mg	0.020mg	0.06mg	0.20mg	0.6mg
500mg	0.025mg	0.08mg	0.25mg	0.8mg
1g	0.03mg	0.10mg	0.3mg	1.0mg
2g	0.04mg	0.12mg	0.4mg	1.2mg
5g	0.05mg	0.16mg	0.5mg	1.6mg
10g	0.06mg	0.20mg	0.6mg	2.0mg
20g	0.08mg	0.25mg	0.8mg	2.5mg
50g	0.10mg	0.3mg	1.0mg	3.0mg
100g	0.16mg	0.5mg	1.6mg	5.0mg
200g	0.3mg	1.0mg	3.0mg	10mg
500g	0.8mg	2.5mg	8.0mg	25mg
1kg	1.6mg	5.0mg	16mg	50mg
2kg	3.0mg	10mg	30mg	100mg
5kg	8.0mg	25mg	80mg	250mg
10kg	16mg	50mg	160mg	500mg
20kg	30mg	100mg	300mg	1000mg

**CLASS SELECTION**

Resolution of the weighing instruments	Required class of weights
0.001mg	E1
0.01mg	E2
0.1mg	E2/F1
1mg	F2
0.01g/0.1g	M1

Weight	Class and material						Shape	
	E2 (non-magnetic stainless steel)	F1 (non-magnetic stainless steel)	F1 (304 stainless steel)	F2 (304 stainless steel)	M1 (304 stainless steel)	M1 (steel, chrome plated)		
1mg	8911-1MGE2	8911-1MGF1	8911-1MGF1S	8911-1MGF2	8911-1MGM1	—	sheet	
2mg	8911-2MGE2	8911-2MGF1	8911-2MGF1S	8911-2MGF2	8911-2MGM1			
5mg	8911-5MGE2	8911-5MGF1	8911-5MGF1S	8911-5MGF2	8911-5MGM1			
10mg	8911-10MGE2	8911-10MGF1	8911-10MGF1S	8911-10MGF2	8911-10MGM1			
20mg	8911-20MGE2	8911-20MGF1	8911-20MGF1S	8911-20MGF2	8911-20MGM1			
50mg	8911-50MGE2	8911-50MGF1	8911-50MGF1S	8911-50MGF2	8911-50MGM1			
100mg	8911-100MGE2	8911-100MGF1	8911-100MGF1S	8911-100MGF2	8911-100MGM1			
200mg	8911-200MGE2	8911-200MGF1	8911-200MGF1S	8911-200MGF2	8911-200MGM1			
500mg	8911-500MGE2	8911-500MGF1	8911-500MGF1S	8911-500MGF2	8911-500MGM1			
1g	8911-1GE2	8911-1GF1	8911-1GF1S	8911-1GF2	8911-1GM1	—	cylinder	
2g	8911-2GE2	8911-2GF1	8911-2GF1S	8911-2GF2	8911-2GM1			
5g	8911-5GE2	8911-5GF1	8911-5GF1S	8911-5GF2	8911-5GM1			
10g	8911-10GE2	8911-10GF1	8911-10GF1S	8911-10GF2	8911-10GM1			8911-10GM1C
20g	8911-20GE2	8911-20GF1	8911-20GF1S	8911-20GF2	8911-20GM1			8911-20GM1C
50g	8911-50GE2	8911-50GF1	8911-50GF1S	8911-50GF2	8911-50GM1			8911-50GM1C
100g	8911-100GE2	8911-100GF1	8911-100GF1S	8911-100GF2	8911-100GM1			8911-100GM1C
200g	8911-200GE2	8911-200GF1	8911-200GF1S	8911-200GF2	8911-200GM1			8911-200GM1C
500g	8911-500GE2	8911-500GF1	8911-500GF1S	8911-500GF2	8911-500GM1			8911-500GM1C
1kg	8911-1KGE2	8911-1KGF1	8911-1KGF1S	8911-1KGF2	8911-1KGM1			8911-1KGM1C
2kg	8911-2KGE2	8911-2KGF1	8911-2KGF1S	8911-2KGF2	8911-2KGM1			8911-2KGM1C
5kg	8911-5KGE2	8911-5KGF1	8911-5KGF1S	8911-5KGF2	8911-5KGM1	8911-5KGM1C		
10kg	8911-10KGE2	8911-10KGF1	8911-10KGF1S	8911-10KGF2	8911-10KGM1	8911-10KGM1C		
20kg	8911-20KGE2	8911-20KGF1	8911-20KGF1S	8911-20KGF2	8911-20KGM1	8911-20KGM1C		

## WEIGHT SETS



- Supplied with manufacturer inspection certificate



8910-200GF1

### CLASS AND MATERIAL

Specification	Code				
	E2 (non-magnetic stainless steel)	F1 (non-magnetic stainless steel)	F1 (304 stainless steel)	F2 (304 stainless steel)	M1 (304 stainless steel)
1mg~100g	8910-100GE2	8910-100GF1	8910-100GF1S	8910-100GF2	8910-100GM1
1mg~200g	8910-200GE2	8910-200GF1	8910-200GF1S	8910-200GF2	8910-200GM1
1mg~1kg	8910-1KGE2	8910-1KGF1	8910-1KGF1S	8910-1KGF2	8910-1KGM1
1mg~2kg	8910-2KGE2	8910-2KGF1	8910-2KGF1S	8910-2KGF2	8910-2KGM1
1mg~5kg	8910-5KGE2	8910-5KGF1	8910-5KGF1S	8910-5KGF2	8910-5KGM1

### SPECIFICATION AND SHAPE

Weight	Specification				
	1mg~100g	1mg~200g	1mg~1kg	1mg~2kg	1mg~5kg
1mg	◆	◆	◆	◆	◆
2mg	◆◆*	◆◆*	◆◆*	◆◆*	◆◆*
5mg	◆	◆	◆	◆	◆
10mg	◆	◆	◆	◆	◆
20mg	◆◆*	◆◆*	◆◆*	◆◆*	◆◆*
50mg	◆	◆	◆	◆	◆
100mg	◆	◆	◆	◆	◆
200mg	◆◆*	◆◆*	◆◆*	◆◆*	◆◆*
500mg	◆	◆	◆	◆	◆
1g	■	■	■	■	■
2g	■◆*	■◆*	■◆*	■◆*	■◆*
5g	■	■	■	■	■
10g	■	■	■	■	■
20g	■◆*	■◆*	■◆*	■◆*	■◆*
50g	■	■	■	■	■
100g	■	■	■	■	■
200g		■◆*	■◆*	■◆*	■◆*
500g			■	■	■
1kg			■	■	■
2kg				■◆*	■◆*
5kg					■
Quantity	21 pcs	23 pcs	25 pcs	27 pcs	28 pcs
Total range	1mg~211.11g	1mg~611.11g	1mg~2111.11g	1mg~6111.11g	1mg~11111.11g

- ◆ sheet
- cylinder
- ◆\* sheet, with mark
- \* cylinder, with mark



# SALT SPRAY TESTERS, TEMPERATURE AND HUMIDITY CHAMBERS

37



Salt Spray Testers  
Page 922



Temperature And Humidity Chambers  
Page 923-925

**SALT SPRAY TESTER  
CODE SFT-S210R**

- Using plastic precision nozzle and conical spray device, the salt spray drops evenly and rapidly, the nozzle has a long working life and does not crystallize
- The spraying time can be controlled internally without external time relay
- The flow rate of salt water and the pressure of compressed air are regulated by flow meter and pressure regulating valve to ensure uniform salt spray settlement
- Manual water adding system can automatically replenish when the water level is insufficient to ensure uninterrupted test

**SPECIFICATION**

Test condition	suitable for neutral and acid salt spray test
Chamber dimension (WxHxD)	900×500×600mm
Chamber volume	270L
Saline tank volume	25L
Chamber temperature	35±1°C
Saturated barrel temperature	47±1°C
Saline temperature	35±1°C
Heating mode	heat radiation
Spray mode	continuous, intermittent
Test fluid	neutral: purified water+sodium chloride (PH6.5~7.2)
Compressed air pressure	2~3kgf/cm <sup>2</sup>
Power supply	AC 220V, 1Ø, 50HZ, 2kW
Dimension (WxHxD)	1560×1250×910mm
Weight	118kg

**STANDARD DELIVERY**

Main unit	1 pc
Stick	1 group
Sodium chloride	2 bottles
10L salt water preparation measuring cup	1 pc
80ml standard cup	2 pcs
50ml metering cup	2 pcs

**OPTIONAL ACCESSORY**

Nozzle	SFT-S210R-NOZZLE
Brine Filter	SFT-S210R-FILTER

## DESKTOP TEMPERATURE AND HUMIDITY CHAMBER CODE THT-Z158



VIDEO



- Table design, quiet and small
- Equipped with operation system with 7-inch touch screen controller
- Intelligent refrigeration and dehumidification system, it can save 30~45% of electricity compared with traditional machines
- Output excel data report through USB port

### SPECIFICATION

Chamber dimension (WxHxD)		300×350×300mm
Chamber volume		32L
Temperature range		-40~120°C
Humidity range		20~98%RH
Temperature/humidity uniformity		≤2°C, ±3%RH
Temperature/humidity fluctuation		±0.5°C, ±2.5%RH
Temperature/humidity stability		±0.3°C, 2.5%RH
Warm up time		1~3°C/min
Cooling time		0.7~1°C/min
Operation environment	environment temperature	5~35°C
	relative humidity	≤85%RH
Material	case material	cold rolled steel plate+varnish
	chamber material	SUS#304 stainless steel
	thermal insulation material	polyurethane foam
Cooling system		compressor
Protector		compressor overload protection switch, refrigerant high pressure protection switch, ceramic fuse, water plate of water shortage protection switch, electromagnetic switch, air burn protection switch, alarm
Power supply		AC220, 50/60HZ, 2kW
Dimension (WxHxD)		550×850×1050mm
Weight		185kg

### STANDARD DELIVERY

Main unit	1 pc
Test hole	1 pc
Shelf	2 pcs

**THT-A101T**

- The chamber is equipped with an independent operation system with 7-inch or 10.1-inch touch screen controller
- Intelligent refrigeration and dehumidification system, combined with energy-saving control algorithm, can adjust the refrigeration level and save energy. Compared with traditional machines, it can save 30~45% of electricity
- It can output excel data report through USB port

**SPECIFICATION**

Code	THT-A101T	THT-A102T	THT-A103T	THT-A104T	THT-A105T
Chamber dimension (WxHxD)	500×600×500mm	500×500×400mm	500×750×600mm	700×850×700mm	1000×1000×1000mm
Chamber volume	150L	100L	225L	416L	1000L
Temperature range	-40~150°C				
Humidity range	10~98%RH				
Temperature/humidity fluctuation	±0.5°C, ±2.5%RH				
Temperature/humidity uniformity	<2°C, 5%RH				
Temperature/humidity stability	0.2°C, 2%RH				
Temperature/humidity deviation	±2°C, 3%RH				
Warm up time	about 3°C/min				
Cooling time	about 1°C/min				
Material	case material	cold rolled steel plate+varnish			
	chamber material	SUS#304 stainless steel			
	thermal insulation material	rigid polyurethane foam			
Cooling system	compressor				
Protector	no fuse switch, compressor overpressure, overheat protection, overtemperature protection, overload protection, dry burning protection, water shortage protection, etc				
Power supply	AC220V, 50HZ, 4.5kW	AC220V, 50HZ, 2kW	AC380V, 3Ø, 50HZ, 4kW	AC380V, 3Ø, 50HZ, 3.5kW	AC380V, 3Ø, 50HZ, 3.5kW
Dimension (WxHxD)	800×1660×1400mm	750×1550×1170mm	850×1750×1200mm	950×1850×1400mm	1300×1950×1850mm
Weight	365kg	285kg	385kg	510kg	950kg

**STANDARD DELIVERY**

Main unit	1 pc
Test hole	1 pc
Shelf	2 pcs

# PROGRAMMABLE TEMPERATURE AND HUMIDITY CHAMBER (PROFESSIONAL TYPE) CODE HTT-A150

temperature and humidity control range diagram

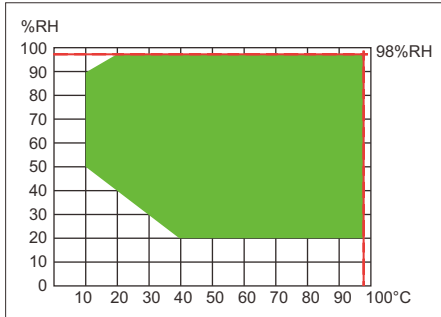

- The chamber is equipped with a standalone operation system and uses a 7-inch human-machine interface touch screen programmable controller
- Adopt advanced balanced temperature and humidity control system, dynamic PID and steam partial pressure control, HFC environmental refrigerant
- Remote control and data acquisition can be performed through the RS232 interface, and CSV data files can be directly exported to a USB flash drive



## SPECIFICATION

<b>Chamber dimension (WxHxD)</b>		500×600×500mm
<b>Chamber volume</b>		150L
<b>Temperature range</b>		-40~150°C
<b>Humidity range</b>		20~98%RH
<b>Temperature/humidity deviation</b>		±2.0°C, ±2.5%RH
<b>Temperature/humidity fluctuation</b>		±0.5°C, ±2.0%RH
<b>Temperature/humidity uniformity</b>		±2.0°C, ±3.0%RH
<b>Warm up time</b>		2.0~3.0°C/min (empty)
<b>Cooling time</b>		1.0~1.5°C/min (empty)
<b>Cooling system</b>		compressor
<b>Material</b>	<b>case material</b>	double-sided galvanized steel plate+spray treatment
	<b>chamber material</b>	SUS#304 stainless steel
	<b>thermal insulation</b>	rigid polyurethane foam
<b>Protector</b>		total power supply phase sequence and out-of-phase protection, leakage protection, load short-circuit protection, adjustable over-temperature protection, humidification system water-deficit protection, compressor over-pressure protection, etc.
<b>Power supply</b>		AC380V, 50Hz, 5kW
<b>Dimension (WxHxD)</b>		765×1670×1575mm
<b>Weight</b>		370kg

## STANDARD DELIVERY

<b>Main unit</b>	1 pc
<b>Test hole</b>	1 pc
<b>Shelf</b>	2 pcs

CODE	PAGE
<b>00</b>	
0010.....	730
0011.....	729
0020.....	718
0021.....	718
0022.....	717
<b>01</b>	
0110.....	728
0120.....	726
0130.....	732
0131.....	731
0132.....	732~733
0140.....	727
<b>02</b>	
0213.....	750
0215.....	750
0222.....	749
0231.....	748~749
<b>03</b>	
0310.....	754
0311.....	752
0312.....	755
0313.....	753
0314.....	755
0320.....	754
0321.....	751
<b>04</b>	
0411.....	720
0412.....	719
0431.....	722
0432.....	721
<b>05</b>	
0501.....	735
<b>06</b>	
0611.....	733
0612.....	734
<b>11</b>	
1102.....	19
1103.....	18
1106.....	29
1108.....	19
1109.....	20
1110.....	22
1111.....	24
1113.....	18
1114.....	19
1115.....	17
1117.....	30
1118.....	17
1119.....	20
1120.....	44
1121.....	43
1122.....	58

CODE	PAGE
1123.....	53
1124.....	40
1125.....	37~38
1128.....	47
1129.....	47
1130.....	21
1135.....	31
1136.....	30
1138.....	54
1139.....	24
1140.....	77
1141.....	69
1142.....	70
1143.....	73
1144.....	71
1145.....	77
1146.....	299
1147.....	70
1148.....	72
1149.....	68
1150.....	88
1151.....	90
1154.....	91
1155.....	85
1156.....	89
1157.....	86
1158.....	87
1160.....	419
1161.....	60
1162.....	65
1163.....	297
1165.....	62
1166.....	441
1167.....	65
1168.....	66
1169.....	51
1170.....	23
1171.....	23
1172.....	62
1176.....	45
1177.....	56
1178.....	48
1179.....	60
1180.....	218
1181.....	64
1183.....	52
1184.....	59
1185.....	50
1186.....	59
1187.....	50
1188.....	52
1189.....	212
1191.....	49
1192.....	55
1193.....	21
1195.....	17
1196.....	20
1199.....	46
<b>12</b>	
1201.....	24

CODE	PAGE
1202.....	25
1203.....	24
1204.....	24
1205.....	25
1207.....	31
1208.....	32
1210.....	32
1214.....	33
1215.....	33
1217.....	27
1223.....	26
1224.....	27
1226.....	28
1229.....	64
1233.....	26
1236.....	31
1238.....	26
1239.....	27
1240.....	74
1243.....	76
1244.....	76
1246.....	298
1247.....	74
1248.....	75
1249.....	75
1250.....	91
1251.....	92
1253.....	91
1262.....	45
1267.....	218
1273.....	63
1275.....	440
1281.....	64
1291.....	49
<b>13</b>	
1311.....	28
1312.....	28
1316.....	28
1338.....	54
1340.....	73
1341.....	73
1351.....	90
1376.....	46
<b>15</b>	
1501.....	213
1520.....	42
1521.....	57
1524.....	56
1525.....	58
1526.....	38~39
1527.....	61
1528.....	61
1530.....	41
1531.....	215
1532.....	53
1533.....	62
1534.....	53
1535.....	51
1536.....	63

CODE	PAGE
1537.....	219
1538.....	66
1539.....	63
1540.....	71
1543.....	68
<b>21</b>	
2103.....	229
2104.....	229
2108.....	233
2109.....	234
2112.....	227
2114.....	234
2115.....	231
2116.....	228
2117.....	236
2118.....	235
2121.....	280
2122.....	191
2124.....	182
2126.....	190
2127.....	195
2128.....	192
2131.....	284
2132.....	285
2133.....	239
2134.....	238
2137.....	233
2138.....	230
2139.....	230
2140.....	240
2141.....	80
2142.....	78
2143.....	81
2144.....	392
2145.....	81
2146.....	300
2147.....	299
2149.....	237
2151.....	281
2152.....	189
2153.....	188
2163.....	297
2164.....	297
2166.....	296
2167.....	296
2168.....	298
2170.....	500
2171.....	377
2174.....	376
2175.....	499
2176.....	377
2177.....	376
2179.....	499
2182.....	216
2183.....	211
2184.....	296
2186.....	295
2187.....	341
2188.....	210
2189.....	216



CODE	PAGE
2197.....	212
2198.....	500
2199.....	498
<b>22</b>	
2222.....	280
2223.....	283
2230.....	304
2231.....	305
2232.....	308
2233.....	307
2234.....	302
2235.....	303
2236.....	313
2237.....	311
2240.....	304
2241.....	306
2242.....	308
2243.....	307
2245.....	302
2246.....	312
2247.....	310
2250.....	315
2251.....	314
2252.....	95~96
2255.....	309
2256.....	309
2260.....	315
2261.....	314
2274.....	437
2275.....	387
2276.....	437
2278.....	438
2280.....	387
2281.....	439
2282.....	439
<b>23</b>	
2301.....	244
2302.....	247
2307.....	249
2308.....	243
2309.....	248
2310.....	246
2311.....	243
2313.....	242
2314.....	245
2316.....	249
2318.....	247
2321.....	281
2322.....	191
2324.....	246
2326.....	250
2328.....	247
2332.....	285
2333.....	285
2334.....	282
2341.....	79
2342.....	79
2343.....	78
2344.....	692

CODE	PAGE
2348.....	197
2361.....	287
2363.....	288
2364.....	286
2365.....	287
2366.....	286
2367.....	293
2372.....	380
2373.....	380
2374.....	379
2380.....	222~223
2381.....	222~223
2383.....	224
2385.....	478
2386.....	225
2394.....	494
2395.....	198
2396.....	255
2397.....	494
2398.....	224
2399.....	225
<b>24</b>	
2421.....	186
2422.....	187
2423.....	192
2424.....	194
2425.....	187
2426.....	185
2428.....	196
2430.....	202
2480.....	226
<b>25</b>	
2501.....	232
2511.....	211
<b>27</b>	
2710.....	292
2711.....	284
2715.....	208
2716.....	209
2724.....	193~194
2771.....	381
<b>28</b>	
2801.....	244
2824.....	193~194
2825.....	190
2827.....	195
2828.....	192
2830.....	241
2840.....	483
2841.....	300
2843.....	692
2844.....	691
2846.....	482
2847.....	477
2849.....	440
2852.....	189
2853.....	188

CODE	PAGE
2859.....	294
2860.....	289
2862.....	291
2863.....	291
2866.....	291
2870.....	291
2871.....	286
2872.....	287
2873.....	293
2874.....	294
2875.....	289
2876.....	293
2877.....	288
2878.....	292
2879.....	290
2880.....	222
2881.....	240
2882.....	249
2885.....	248
2886.....	242
2887.....	242
2888.....	244
2889.....	246
2890.....	241
2891.....	241
2892.....	243
2893.....	245
2894.....	245
2895.....	223
2896.....	223
2897.....	222
2898.....	225
2899.....	224
<b>29</b>	
2931.....	94
2941.....	200
2942.....	200
2943.....	220
2944.....	220
<b>31</b>	
3101.....	108
3102.....	110
3108.....	109
3109.....	111
3127.....	179~180
3128.....	181
<b>32</b>	
3202.....	113
3203.....	114
3205.....	121
3206.....	118
3208.....	116
3209.....	116
3210.....	115
3216.....	117
3220.....	169
3221.....	170
3222.....	172

CODE	PAGE
3224.....	171
3225.....	173
3226.....	177
3227.....	178~179
3228.....	181
3229.....	171
3230.....	134
3231.....	116
3232.....	138
3233.....	141
3234.....	148
3235.....	121
3236.....	117
3238.....	151
3239.....	147
3240.....	82
3241.....	83
3260.....	144
3261.....	143
3262.....	147
3263.....	157
3264.....	157
3266.....	140
3280.....	150
3281.....	129
3282.....	154
3283.....	152
3285.....	158
3287.....	125
3288.....	146
3290.....	149
3291.....	133
3292.....	157
3293.....	158
3294.....	155
3296.....	125
3297.....	136
<b>33</b>	
3331.....	124
3332.....	122
3333.....	122
3334.....	295
3335.....	294
3338.....	153
3346.....	124
3350.....	104
3351.....	105
3352.....	139
3353.....	156
3354.....	135
3355.....	145
3356.....	142
3358.....	102
3359.....	103
<b>34</b>	
3400.....	115
<b>35</b>	
3506.....	119

CODE	PAGE
3520.....	170
3521.....	174
3522.....	199
3530.....	134
3532.....	138
3533.....	141
3534.....	148
3538.....	151
3539.....	147
3540.....	82
3560.....	144
3561.....	143
3562.....	148
3565.....	111
3566.....	140
3580.....	150
3581.....	130
3583.....	152
3588.....	146
3590.....	149
3591.....	133
3594.....	155
3597.....	136
<b>36</b>	
3632.....	106
3634.....	174
3635.....	175
3636.....	131
3638.....	176
3641.....	176
3650.....	137
3653.....	146
3658.....	140
3659.....	134
3661.....	107
3675.....	120
3676.....	153
3677.....	154
3678.....	170
3679.....	169
3680.....	127
3681.....	113
3682.....	112
3683.....	173
3684.....	172
3685.....	123
<b>37</b>	
3701.....	112
<b>40</b>	
4001.....	329
4002.....	333
4004.....	463
4006.....	463
<b>41</b>	
4100.....	322
4101.....	323
4103.....	321

CODE	PAGE
4104.....	324
4105.....	319
4106.....	320
4107.....	326
4108.....	326
4110.....	336
4111.....	318
4118.....	336
4120.....	358
4121.....	365
4124.....	345
4128.....	346
4129.....	359~363
4130.....	354
4131.....	364
4139.....	355~357
4141.....	382
4142.....	459
4143.....	462
4144.....	381
4147.....	390
4155.....	465
4157.....	404
4158.....	465
4160.....	327
4164.....	325
4166.....	335
4168.....	350
4177.....	372
4178.....	373~374
4179.....	83
4180.....	390
4184.....	158
4190.....	349
4191.....	391
4192.....	336
4193.....	334
4194.....	334
4198.....	550
4199.....	159
<b>42</b>	
4206.....	201
4208.....	200
4209.....	201
<b>46</b>	
4601.....	409
4602.....	409
4605.....	410
4608.....	410
4621.....	412
4622.....	412
4623.....	411
4624.....	411
4630.....	420
4647.....	366
4649.....	352
4653.....	183~184
4662.....	350
4666.....	353

CODE	PAGE
4676.....	351
4677.....	367~371
<b>47</b>	
4700.....	389
4701.....	387
4702.....	389
4706.....	389
4707.....	386
4710.....	382
4720.....	401
4721.....	399
4722.....	400
4723.....	400
4725.....	395
4726.....	396
4728.....	404
4731.....	394
4733.....	402
4734.....	396
4735.....	398
4737.....	397
4738.....	403
4739.....	402
4741.....	403
4745.....	388
4747.....	388
4754.....	389
4760.....	388
4762.....	388
4770.....	383
4771.....	405
4780.....	378
4781.....	378
4782.....	401
4786.....	398
4788.....	399
4789.....	394
4790.....	383
4791.....	384
4792.....	386
4793.....	385
4794.....	384
4795.....	386
4796.....	385
4797.....	379
4799.....	378
<b>48</b>	
4801.....	416
4802.....	416
4803.....	418
4804.....	416
4806.....	415
4807.....	415
4808.....	418
4809.....	418
4810.....	414
4812.....	415
4820.....	413
4824.....	414

CODE	PAGE
4829.....	435
4830.....	421
4831.....	422
4832.....	422
4833.....	420
4834.....	423
4835.....	425
4836.....	422
4837.....	420
4838.....	424
4839.....	427
4840.....	426
4841.....	427
4842.....	417
4843.....	417
4844.....	219
4845.....	693
4846.....	426
4847.....	423
4848.....	423
4849.....	425
4850.....	425
4851.....	426
4852.....	421
4853.....	419
4854.....	417
4855.....	421
4860.....	414
4865.....	215
<b>49</b>	
4902.....	501
4903.....	502
4905.....	502
4906.....	501
4907.....	502
4908.....	502
4910.....	503
4911.....	505
4912.....	503
4913.....	504
4914.....	505
4917.....	507
4918.....	506
4921.....	504
4922.....	504
4923.....	506
<b>50</b>	
5013.....	447
5021.....	443
5022.....	443
5023.....	444
5024.....	444
5031.....	444
5032.....	444
5041.....	445
5042.....	445
5051.....	445
5052.....	445
5061.....	446



# CODE NO. INDEX



CODE	PAGE
5062.....	446
5063.....	446
5064.....	428
5071.....	428
5072.....	428
5081.....	447
5091.....	447
<b>51</b>	
5101.....	636
5102.....	638
5103.....	640
5104.....	637
5106.....	646
5107.....	642
5108.....	639
5109.....	641
<b>52</b>	
5201.....	728
<b>53</b>	
5301.....	603
5302.....	597
5303.....	602
5305.....	648
5307.....	618
5309.....	629~630
5310.....	609~610
5311.....	631~632
5313.....	604
5314.....	475~476
5315.....	600~601
5316.....	615
5317.....	616~617
5318.....	605
5319.....	621
5320.....	598~599
5322.....	619~620
<b>57</b>	
5700.....	698
5701.....	697~698
5702.....	694
5704.....	698
<b>58</b>	
5801.....	724
5802.....	724
5803.....	725
5804.....	736
5805.....	736
5806.....	723
<b>59</b>	
5900.....	735
<b>61</b>	
6140.....	34
6141.....	76
6143.....	51

CODE	PAGE
6144.....	35
6145.....	36
6146.....	36
<b>62</b>	
6200.....	268
6201.....	268
6202.....	268
6207.....	269
6208.....	266
6210.....	266
6211.....	269
6212.....	269
6214.....	270
6215.....	269
6216.....	268
6217.....	270
6219.....	265
6221.....	268
6224.....	267
6225.....	271
6226.....	270
6227.....	271
6228.....	267
6229.....	265
6230.....	271
6250.....	308
6251.....	303
6252.....	306
6254.....	315
6255.....	309
6272.....	267
6282.....	250~252
6284.....	226
6291.....	264
6293.....	263
6294.....	264
6295.....	264
6296.....	263
6297.....	263
6298.....	226
<b>63</b>	
6300.....	159
6301.....	160
6302.....	160
6307.....	163
6309.....	34
6310.....	161
6312.....	342
6315.....	159
6316.....	340
6317.....	343
6318.....	162
6319.....	344
6331.....	347
6332.....	348
6333.....	347
6353.....	163
6354.....	163
6372.....	164

CODE	PAGE
6373.....	164
6375.....	167
6377.....	166
6381.....	166
6384.....	165
6385.....	164
6386.....	165
6387.....	165
6388.....	167
6389.....	166
6391.....	400
<b>65</b>	
6511.....	462
6512.....	460~461
6513.....	467
6519.....	469
6520.....	469
6521.....	468
6523.....	467
6524.....	468
6526.....	469
6527.....	466
6528.....	468
6531.....	462
6533.....	461
6534.....	461
6535.....	464
6536.....	466
6537.....	459
6538.....	466
6539.....	459
6540.....	333
6547.....	464
6548.....	464
6549.....	465
6553.....	493
6554.....	493
6555.....	494
6556.....	493
6557.....	493
6558.....	481
6562.....	480
6566.....	479
6567.....	480
6568.....	480
6571.....	478
6572.....	479
6573.....	479
6582.....	470
6583.....	473
6584.....	471
6585.....	472
6586.....	472
6587.....	472
6588.....	473
<b>68</b>	
6801.....	457
6802.....	453
6803.....	453

CODE	PAGE
6804.....	454
6805.....	455
6806.....	454
6832.....	424
6841.....	272
6842.....	276
6843.....	98
6844.....	97
6845.....	277
6846.....	277
6847.....	99
6852.....	392
6862.....	275
6863.....	274
6864.....	274
6865.....	278
6866.....	272
6867.....	273
6869.....	275
6870.....	273
6874.....	331
6875.....	763
6876.....	272
6878.....	458
6879.....	463
6880.....	83
6881.....	328
6882.....	330
6883.....	327
6884.....	332
6885.....	550
6886.....	327
6887.....	455
6888.....	455
6889.....	456
6890.....	457
6891.....	458
6892.....	458
6896.....	452
6897.....	456
6898.....	452
<b>69</b>	
6900.....	450
6902.....	451
6903.....	451
6990.....	442
<b>71</b>	
7101.....	516
7102.....	517
7106.....	261
7107-1.....	262
7107-11.....	260
7107-11V.....	260
7107-12.....	260
7107-12V.....	260
7107-2.....	262
7107-3.....	262
7110.....	436
7111.....	391

CODE	PAGE
7113.....	434
7114.....	203
7115.....	204
7116.....	204
7117.....	390
7118.....	391
7119.....	435
7120.....	439
7121.....	435
7122.....	434
7123.....	436
7130.....	256~257
7131.....	256
7134.....	258~259
7135.....	202
7136.....	203
7137.....	201
7139.....	432
7140.....	432
7141.....	430
7142.....	432
7143.....	433
7144.....	433
7145.....	433
7146.....	434
7150.....	92
7160.....	667
7161.....	668
7162.....	667
7163.....	668
7164.....	668
<b>72</b>	
7202.....	441
7203.....	441
7205.....	440
7212.....	259
7230.....	442
7231.....	442
7232.....	442
7240.....	429
7241.....	429
7247.....	430
7260.....	430
7261.....	429
7262.....	429
<b>73</b>	
7302.....	12~14
7304.....	15
7305.....	8~11
7315.....	4~7
7317.....	2~3
7321.....	177
7324-HUB4.....	15
7324-HUB7.....	15
7325-ADD5.....	15
7325-ADD10.....	15
7327-FS.....	15
7327-SW.....	15
7330.....	254

CODE	PAGE
7331.....	253
7332.....	253
7333.....	253
7338.....	443
7340.....	337
7341.....	338
7342.....	337
7344.....	339
7345.....	337
7350.....	198
7351.....	197
7353.....	198
7360.....	236
7381.....	131
7382.....	126
7383.....	132
7384.....	128
7385.....	177
7386.....	161
7390.....	128
7391.....	133
7393.....	132
7394.....	126
<b>75</b>	
7511.....	663
7512.....	666
7513.....	665
7514.....	663
7515.....	663
7516.....	660
7517.....	660
7520.....	660
7521.....	660
7522.....	665
7523.....	666
7524.....	663
7525.....	661
7526.....	662
7527.....	664
7528.....	664
7529.....	665
7530.....	667
<b>76</b>	
7600.....	725
<b>80</b>	
8001.....	910
8002.....	910
8003.....	912
<b>81</b>	
8101.....	911
8105.....	909
<b>82</b>	
8201.....	915
8202.....	915
8203.....	917
8204.....	916~917

CODE	PAGE
<b>83</b>	
8301.....	909
8303.....	907
8304.....	906
8305.....	908
8310.....	905
<b>84</b>	
8401.....	914
<b>85</b>	
8501.....	913
<b>86</b>	
8601.....	911
8602.....	912
<b>87</b>	
8701.....	918
<b>89</b>	
8910.....	920
8911.....	919
<b>91</b>	
9132.....	747
<b>92</b>	
9216.....	740
9219.....	743
9223.....	715
9224.....	716
9225.....	715
9241.....	739
9242.....	741
9246.....	742
9247.....	741
<b>93</b>	
9315.....	744
9341.....	726
9351.....	731
9353.....	730
9362.....	753
<b>94</b>	
9401.....	517
9408.....	518
9410.....	484
9411.....	492
9412.....	491
9413.....	485~486
9414.....	487~488
9415.....	489~490
<b>95</b>	
9501.....	688
9503.....	690
9511.....	693
9561.....	719

CODE	PAGE
9563.....	431
<b>96</b>	
9643.....	839
9651.....	738
<b>97</b>	
9710.....	696
9720.....	718
9721.....	745
9722.....	745
9723.....	745
<b>99</b>	
9911.....	739
<b>ALT</b>	
ALT-P150.....	519
<b>CMM</b>	
CMM-BE□□□.....	543~544
CMM-CM□□□.....	543~544
CMM-LM□□□.....	541~542
CMM-MN432.....	537~538
CMM-ST□□□.....	539~540
<b>CST</b>	
CST-D101.....	842
CST-D102.....	842
<b>DBC</b>	
DBC-M660.....	757
<b>DSW</b>	
DSW-A010.....	725
<b>EMU</b>	
EMU-S340.....	705
<b>GRL</b>	
GRL-L340.....	508
<b>HDT</b>	
HDT-AMV338.....	808~809
HDT-B-□□□.....	840~841
HDT-B430.....	827
HDT-CB320.....	819~820
HDT-CRS200.....	789~790
HDT-DMV90.....	806~807
HDT-L410.....	826
HDT-L411.....	828
HDT-LP200.....	824
HDT-LP200B.....	824
HDT-MB610.....	815
HDT-MB710.....	815
HDT-MBE320.....	814
HDT-MVE1300.....	804
HDT-MVH1100.....	805
HDT-PB350.....	832
HDT-RA151.....	800
HDT-RH411.....	798



CODE	PAGE
HDT-RM421.....	797
HDT-RSR100.....	803
HDT-RT151.....	793~794
HDT-RT152.....	793~794
HDT-RT153.....	793~794
HDT-RW160.....	802
HDT-VE03.....	810~811
HDT-VE14.....	810~811
HDT-VE35.....	810~811
HDT-VE56.....	810~811
HDT-VH05.....	812~813
HDT-VH11.....	812~813
HDT-VH31.....	812~813
HDT-VH51.....	812~813
HDT-WL320.....	819~820
HDT-WP201.....	825
<b>HES</b>	
HES-H022.....	885~886
HES-H055.....	885~886
HES-H107.....	885~886
<b>HSM</b>	
HSM-A310.....	526
<b>HTT</b>	
HTT-A150.....	925
<b>ISBR</b>	
ISBR-H181.....	831
<b>ISD</b>	
ISD-CL□□□.....	593
ISD-E320.....	582~583
ISD-E430.....	582~583
ISD-F432.....	575~577
ISD-H210.....	579~580
ISD-H320.....	579~580
ISD-H430.....	579~580
ISD-V150A.....	581~582
ISD-V220□□□.....	584~585
ISD-V250A.....	581~582
ISD-V270□□□.....	584~585
ISD-V300A.....	581~582
ISD-V370□□□.....	584~585
ISD-V400A.....	581~582
ISD-V500N.....	586~587
ISD-V501N.....	586~587
ISD-V500HN.....	586~587
ISD-V501HN.....	586~587
ISD-VMM□□□.....	595~596
ISD-W3150.....	578~579
<b>ISE</b>	
ISE-2DT.....	497
ISE-L051.....	496
ISE-L051L.....	496
<b>ISF</b>	
ISF-1DF□□□.....	872
ISF-DF□□□.....	870

CODE	PAGE
ISF-DFAT1.....	871
ISF-DFAT2-□□□.....	871
ISF-F□□□.....	873
ISF-H20A.....	876
ISF-H20D.....	876
ISF-MH2.....	876
ISF-MT1K.....	872
ISF-MT500.....	873
ISF-P□□□.....	874
ISF-P30A.....	877
ISF-P30D.....	877
ISF-RH62.....	875
ISF-RV61.....	875
ISF-S□□□.....	869
ISF-TG□□□.....	877
ISF-U055.....	868
ISF-U101.....	868
ISF-U202.....	868
ISF-V10A.....	876
ISF-V10D.....	876
<b>ISGF</b>	
ISGF-0501.....	442
ISGF-0901.....	442
<b>ISHB</b>	
ISHB-B300.....	835
ISHB-C161.....	833
ISHB-H131.....	833
ISHB-MSA.....	816
ISHB-P151.....	831
<b>ISH</b>	
ISH-BL01.....	818
ISH-BRV.....	817
ISH-DSA.....	836
ISH-DSD.....	836
ISH-DSOO.....	836
ISH-DS-STANDA.....	837
ISH-MR150.....	799
ISH-MRD200.....	795
ISH-OS2.....	838
ISH-PHB.....	821
ISH-PHB-B.....	822
ISH-PH-SP9.....	829
ISH-R150.....	801
ISH-RD200.....	796
ISH-S30A.....	837
ISH-S30D.....	837
ISH-SAM.....	838
ISH-SDM.....	838
ISH-SPHA.....	823
ISH-ST02.....	818
ISH-STAC.....	839
ISH-STD.....	839
<b>ISHR</b>	
ISHR-B141.....	830
ISHR-D121.....	829
ISHR-M111.....	830
ISHR-P101.....	832

CODE	PAGE
ISHR-P151.....	831
ISHR-T100.....	791~792
ISHR-T200.....	791~792
ISHR-T300.....	791~792
<b>ISHW</b>	
ISHW-B70.....	834
ISHW-B75.....	834
ISHW-B92.....	834
ISHW-H□□□.....	835
ISHW-L20.....	834
ISHW-L20A.....	834
ISHW-L20B.....	834
<b>ISL</b>	
ISL-A1-□□□.....	510~511
ISL-A5-□□□.....	510~511
ISL-B1-□□□.....	511~512
ISL-B5-□□□.....	510~512
ISL-DR2.....	513
ISL-DR3.....	513
ISL-LCD7.....	514
ISL-SET1.....	515
<b>ISM</b>	
ISM-AD-□□□.....	659
ISM-CM20.....	653~654
ISM-CM63.....	651~652
ISM-CT820.....	622
ISM-DL300.....	606~607
ISM-DL301.....	606~607
ISM-DL302.....	608
ISM-DL400.....	624~625
ISM-DL510.....	613~614
ISM-DL520.....	611~612
ISM-DL-COAXIAL.....	627
ISM-DL-LED.....	627
ISM-DL-OB□□□.....	628
ISM-DL-STAGE1.....	626
ISM-LED-100L4.....	626
ISM-LED-9245R.....	626
ISM-LED-BRACKET.....	627
ISM-LED-CTRL.....	626
ISM-MAS100.....	657~658
ISM-MP8B.....	655~656
ISM-MV10.....	652
ISM-PM100.....	659
ISM-PM20.....	659
ISM-PM40.....	659
ISM-PM50.....	659
ISM-PM200SA.....	633
ISM-PM200SB.....	633
ISM-POL1000.....	649
ISM-WF200.....	634~635
ISM-ZS100.....	644
ISM-ZS100T.....	644
ISM-ZS200.....	643
ISM-ZS30.....	647
ISM-ZS50.....	645
ISM-ZS50T.....	645
ISM-ZS70-S.....	650

CODE	PAGE
ISM-ZS-LED.....	627
<b>ISO</b>	
ISO-1000FN.....	690
ISO-1200FN.....	689
ISO-8000FN.....	687
<b>ISP</b>	
ISP-A1000E.....	559~560
ISP-A3000E.....	563~564
ISP-A5000E.....	561~562
ISP-A6000.....	567~568
ISP-A6000E.....	567~568
ISP-A7000E.....	565~566
ISP-AZ3020.....	561~562
ISP-W3020.....	563~564
ISP-W4025.....	565~566
ISP-Z3015.....	559~560
<b>ISQ</b>	
ISQ-01-□□□.....	545~547
ISQ-02-□□□.....	545~547
ISQ-03-□□□.....	545~547
ISQ-05-□□□.....	545~547
ISQ-20-□□□.....	548~549
ISQ-25-□□□.....	548~549
ISQ-30-□□□.....	548~549
ISQ-35-□□□.....	548~549
ISQ-40-□□□.....	548~549
ISQ-45-□□□.....	548~549
ISQ-50-□□□.....	548~549
ISQ-55-□□□.....	548~549
ISQ-DG6.....	694
ISQ-DG8.....	695
ISQ-DRM31.....	723
ISQ-PK100.....	699
ISQ-RA600.....	207
ISQ-RM30.....	724
ISQ-TS120K.....	716
<b>ISR</b>	
ISR-C002.....	776~777
ISR-C003.....	784
ISR-C200.....	774~775
ISR-C300.....	778~780
ISR-CS□□□.....	785
ISR-CS130-W.....	784
ISR-LS□□□.....	786
ISR-RS□□□.....	786
ISR-T120.....	781~783
<b>IST</b>	
IST-04TT□□□.....	881
IST-06TS1100.....	883
IST-06TS2000.....	883
IST-06TS350.....	883
IST-11WM□□□.....	894~895
IST-13W□□□.....	892
IST-15W□□□.....	893
IST-19WM□□□.....	898
IST-25WM□□□.....	897~898

CODE	PAGE
IST-2W□□□	889~890
IST-3SD200	884
IST-3SD400	884
IST-3SD50	884
IST-4W□□□	891
IST-5W135A	900
IST-5W200A	900
IST-5W30A	900
IST-5W340A	900
IST-9WM□□□	896
IST-DCT10	880
IST-DCT2	880
IST-DCT20	880
IST-DCT5	880
IST-DT2000	903
IST-DT3500	903
IST-DT5500	903
IST-DT7500	903
IST-DTT1	879
IST-DTT10	879
IST-DTT5	879
IST-DW□□□	899
IST-MG100	885
IST-MG250	885
IST-MG360	885
IST-MG600	885
IST-PW□□□	899
IST-SD50	883
IST-SD200	883
IST-SD400	883
IST-ST□□□	902~903
IST-TM□□□	901
IST-TT□□□	882
IST-W□□□	888
IST-WP6	887
IST-WS□□□	887
<b>ISU</b>	
ISU-100D	713
ISU-250C	712
ISU-300D	711
ISU-700D	710
ISU-710D	709
ISU-720D	708
ISU-800D	706
ISU-810D	707
ISU-PB3	534
ISU-PB5	535
ISU-S□□□	714
<b>ISV</b>	
ISV-1H□□□	684
ISV-1HLED	685
ISV-1LED1	685
ISV-2CAM	685
ISV-E30	680
ISV-E40	679
ISV-K□□□	676
ISV-L	672~674
ISV-P6	677
ISV-S	675

CODE	PAGE
ISV-S106	678
ISV-T105	678
ISV-VP280	683
ISV-Y	670~671
<b>ISY</b>	
ISY-100	555~556
ISY-200	551
ISY-300	553
ISY-400	554
ISY-500	552
ISY-600	557
ISY-700	592
<b>ITM</b>	
ITM-S□□□	866~867
ITM-U32	867
<b>LDM</b>	
LDM-030	520
LDM-065	520
LDM-D090	521
<b>MLP</b>	
MLP-10□□□	854
MLP-20□□□	854
MLP-30□□□	854
MLP-40□□□	854
MLP-50□□□	854
MLP-60□□□	854
MLP-CM□□□	856
MLP-CM60	845
MLP-CM86	846
MLP-DL□□□	857
MLP-DQ□□□	854
MLP-DR□□□	855
MLP-GP260	848
MLP-GP270	849
MLP-GP280	849
MLP-GP305	847
MLP-GP314	850
MLP-HCM102	844
MLP-MP25	853
MLP-MP30	852
MLP-MP43	851
MLP-MP53	851
MLP-MP62	852
MLP-OL□□□	855
MLP-QM□□□	856
MLP-QP1	857
MLP-QP2	857
MLP-RA	857
<b>MPI</b>	
MPI-HD130	534
MPI-HF360	534
MPI-P110	533
MPI-P220	533
MPI-P330	533
<b>OES</b>	

CODE	PAGE
OES-T350	522~523
<b>PHT</b>	
PHT-C751	699
<b>PIC</b>	
PIC-D155	751
<b>PPF</b>	
PPF-BF62	701
<b>QMS</b>	
QMS-A110	573~574
QMS-A200	573~574
QMS-A220	571~572
QMS-A315	571~572
QMS-A320	571~572
QMS-A450	569~570
<b>QMY</b>	
QMY-AP32	701
<b>RCT</b>	
RCT-300	759~760
RCT-RA260	761~762
<b>RFS</b>	
RFS-BT□□□	878
RFS-HSK□□□	878
<b>RXT</b>	
RXT-BM301	535
<b>SFT</b>	
SFT-S210R	922
<b>SPM</b>	
SPM-1000	764~765
SPM-2000	766~767
SPM-4000	772~773
SPM-5000	768~769
SPM-6000	770~772
<b>SPT</b>	
SPT-AD21	700
<b>TGI</b>	
TGI-□□□	374
<b>THD</b>	
THD-PF34	702
<b>THL</b>	
THL-A01	756~757
<b>THT</b>	
THT-A□□□	924
THT-Z158	923
<b>TLP</b>	
TLP-300H	529

CODE	PAGE
TLP-400E	528
TLP-P340	527
<b>UFD</b>	
UFD-T680	531~532
<b>UTM</b>	
UTM-E□□□	859
UTM-EX□□□	865
UTM-F□□□	862~863
UTM-H□□□	864~865
UTM-S□□□	861
<b>UTT</b>	
UTT-M□□□	860
<b>VMM</b>	
VMM-L□□□	588~589
<b>VSP</b>	
VSP-201	681~682
<b>XRF</b>	
XRF-B210	524~525

# APPLICATION INDEX OF MEASURING TOOLS

## SHAFT DIAMETER



**Dial Snap Gages**  
2186-  
(page 295)



**Adjustable Snap Gages**  
2187- (page 341)



**Indicating Micrometers**  
3332-, 3333-  
(page 122)



**Micrometers With Dial Indicator**  
3296-, 3331-, 3346-, 3685-  
(page 123-125)



**Dial Snap Gages**  
3335-, 3334-  
(page 294-295)



**Outside Micrometers**  
(page 108-117)



**Universal Calipers**  
1125-  
(page 37-38)

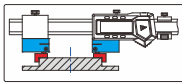

**Digital/Dial/Vernier Calipers**  
(page 17-33)



**External Caliper Gages**  
2131-, 2333-, 2332-, 2132-  
(page 284-285)



**Circumference Tapes**  
(page 203-204)



**Internal And External Diameter Comparison Instruments**  
6844-, 6843-  
(page 97-98)



## EXTERNAL GROOVE DIAMETER



**Digital Blade Calipers**  
1188-, 1532-  
(page 52-53)

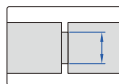

**Blade Micrometers**  
3232-, 3532-, 3650-  
(page 137-138)

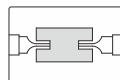

**High Precision Digital Blade Micrometers/Snap Gages**  
3352-  
(page 139)

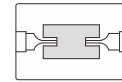

**Digital Outside Neck Calipers**  
1187-  
(page 50)

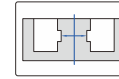

**Digital Calipers With Interchangeable Points**  
1526-, 1124-, 1530-  
(page 38-41)

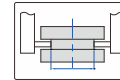

**Universal Calipers**  
1125-  
(page 37-38)

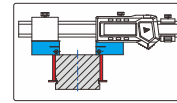

**External Caliper Gages**  
2131-, 2333-, 2332-, 2132-  
(page 284-285)



**Outside Calipers**  
7262-, 7241-  
(page 429)



## ARC RADIUS

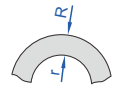

**Outside Diameter Variation Measuring Instruments**  
2715-  
(page 208)



**Outside Diameter Measuring Instruments**  
2716-  
(page 209)



**Digital Radius Gages**  
2183, 2197, 2511  
(page 211-212)

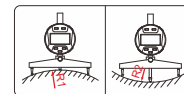

**Digital Radius Gages**  
2188-, 1501-  
(page 210/213)

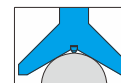

**Digital Arc Radius Calipers**  
1189-  
(page 212)

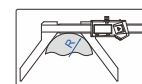

**Radius Gages**  
4801-, 4804-  
(page 416)



# APPLICATION INDEX OF MEASURING TOOLS

## BORE DIAMETER

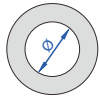

**Digital/Dial/Vernier Calipers With Internal Measuring Jaws**  
(page 17-33)



**Universal Calipers**  
1125-  
(page 37-38)



**Carbon Fiber Comparison Gages**  
2931-  
(page 94)



**Comparison Gages**  
2252-  
(page 95-96)



**Digital Inside Knife-Edge Calipers**  
1123-, 1138-  
(page 53-54)



**Inside Micrometers**  
3220-, 3520-, 3679-  
(page 169-170)



**Three Points Internal Micrometers**  
3227-, 3127-, 3228-, 3128-  
(page 178-181)



**Pistol Grip Three Points Bore Gages**  
2124-  
(page 182)



**Tubular Inside Micrometers**  
(page 170-175)



**Split Type Dial Bore Gages**  
(page 185-186)



**Bore Plug Gages**  
4653-  
(page 183-184)



**Bore Gages**  
(page 187-199)



**Telescoping Gages**  
4208-, 4206-, 4209-  
(page 200-201)



**Inside Calipers**  
7261-, 7240-  
(page 429)



**Internal Caliper Gages**  
(page 280-284)



**Taper Bore Gages**  
4852-, 4855-  
(page 421)



**Pin Gages**  
(page 334-336)



**Plain Plug Gages**  
(page 345-348)



**Taper Gages**  
4833-, 4837-  
(page 420)



**Tape Bore Gages**  
2430-  
(page 202)



**Internal And External Diameter Comparison Instruments**  
6844-, 6843-  
(page 97-98)



## DIAMETER OF GROOVE INSIDE HOLES

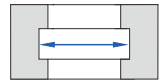

**Universal Calipers**  
1125-  
(page 37-38)



**Carbon Fiber Comparison Gages**  
2931-  
(page 94)



**Comparison Gages**  
2252-  
(page 95-96)



# APPLICATION INDEX OF MEASURING TOOLS

**Digital Calipers With Interchangeable Points**  
1526-, 1124-, 1530-  
(page 38-41)



**Inside Groove Calipers**  
(page 42-49)



**Accessory Sets For Digital Calipers**  
6144, 6145-, 6146-  
(page 35-36)

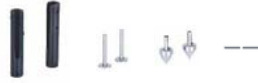

**Internal Caliper Gages**  
(page 280-284)

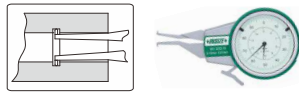

**Internal Chamfer Gages**  
2941-, 2942-  
(page 200)

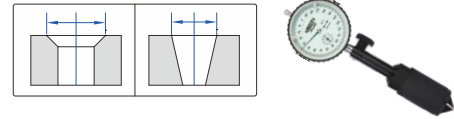

## CHAMFER

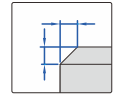

**Chamfer Gages**  
4844-, 1180-, 1267-  
(page 218-219)



**Digital Chamfer Gages**  
1537-  
(page 219)



## WIDTH AND POSITION OF GROOVE INSIDE HOLES



**Digital Hook Calipers**  
1122-  
(page 58)



**Depth Gages With Hook**  
1142-, 1144-  
(page 70-71)  
1540-, 1248-, 1243-  
(page 71/75-76)

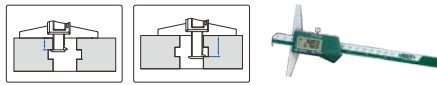

**Digital Depth Gages With Round Depth Bar**  
1148-  
(page 72)

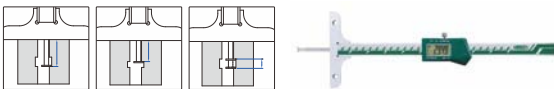

**Groove Micrometers**  
3287- (page 125)

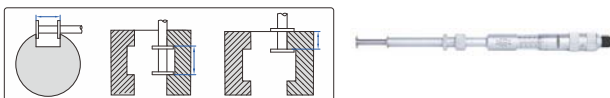

**Digital Groove Gages**  
2145-  
(page 81)

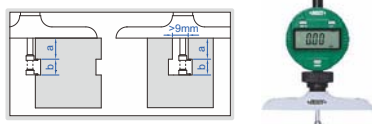

**Digital Groove Measurement Stands**  
6870-  
(page 273)



## DIAMETER OF BORE WITH CHAMFER



**Chamfer Height Gages**  
2943-, 2944-  
(page 220)



## TUBE WALL THICKNESS

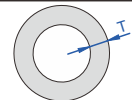

**Ultrasonic Thickness Gages**  
(page 705-713)



**Digital Tube Thickness Calipers**  
1161-  
(page 60)



**Cylindrical Anvil Tube Micrometers**  
3261-, 3561-  
(page 143)

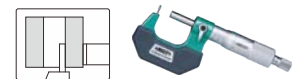

**Spherical Anvil Tube Micrometers**  
3260-, 3560-, 3355-  
(page 144-145)



**Tube Thickness Gages**  
2876-, 2367-, 2859-  
(page 293-294)

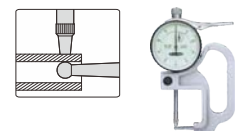

**Digital Tube Thickness Gages**  
2873-  
(page 293)

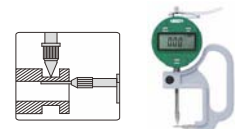

# APPLICATION INDEX OF MEASURING TOOLS

## HEIGHT

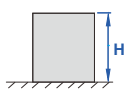

**Digital Height Gages**  
1155-, 1157-, 1158-  
(page 85-87)



**Height Gages**  
(page 88-92)



**Dial Indicator Stands**  
(page 272-277)



**Transfer Stands**  
6865-  
(page 278)



**Mini Digital Height Gages**  
1146-, 1246-  
(page 298-299)

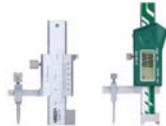

**Digital/Dial Height Gages**  
2147-, 2146-  
(page 299-300)



## DEPTH



**Depth Gages**  
(page 68-71)

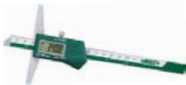

**Depth Gages With Point**  
1143-  
(page 73)

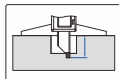

**Depth Gages With Hook**  
1142-, 1144- (page 70-71)  
1540-, 1248-, 1243-  
(page 71/75-76)

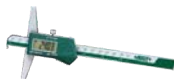
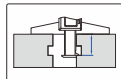
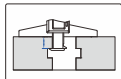

**Digital Depth Gages With Round Depth Bar**  
1148- (page 72)

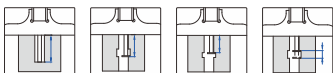

**Mini Depth Gages**  
1244-, 1145-, 1140-  
(page 76-77)



**Dial/Digital Depth Gages**  
2343-, 2142-, 2341-, 2342-, 2141-  
(page 78-80)



**Depth Micrometers**  
3540-, 3240-, 3241-  
(page 82-83)



**Digital/Dial/Vernier Calipers With Depth Bar**  
(page 17-33)



## THICKNESS



**Thickness Gages**  
(page 286-292)



**Digital Snap Gages**  
2166-, 2167-, 2163-, 1163-  
(page 296-297)



**External Caliper Gages**  
2131-, 2333-, 2332-, 2132-  
(page 284-285)



## SHAFT DIAMETER INSIDE HOLE

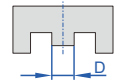

**Caliper Type Micrometers**  
3238-, 3538-  
(page 151)



**Jaw Type Micrometers**  
3283-, 3583-  
(page 152)



**Digital Outside Neck Calipers**  
1187-  
(page 50)



## SLOT WIDTH

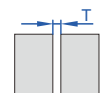



# APPLICATION INDEX OF MEASURING TOOLS

**Taper Gages**  
4833-, 4837-  
(page 420)



**Taper Slot Gages**  
1160-, 4630-  
(page 419-420)



**Internal Caliper Gages**  
(page 280-284)



**Feeler Gages**  
(page 409-411)



**Step And Gap Gages**  
2168-  
(page 298)

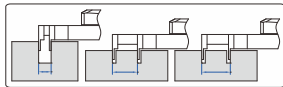

**Groove Micrometers**  
3287- (page 125)

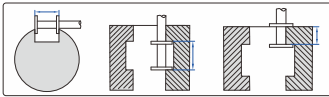

**HOLE CENTER-TO-CENTER  
AND CENTER-TO-EDGE  
DISTANCE**

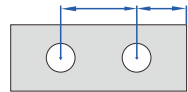

**Digital Centering Calipers**  
1192-, 1177-, 1525-,  
1524-, 1521-  
(page 55-58)



**Universal Calipers**  
1125-  
(page 37-38)

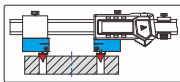

**Accessory Sets For Digital Calipers**  
6144, 6145-, 6146-  
(page 35-36)



**ANGLE**

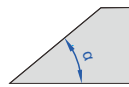

**Protractors**  
(page 376-379)



**Digital Angle Meters**  
2177-  
(page 376)



**Protractors**  
2374-, 2372-, 2373-, 2771-  
(page 379-381)



**Squares**  
4745-, 4747-, 4760-, 4762-, 4706-, 4754-  
(page 388-389)



**Angle Gages**  
4806-, 4807  
(page 415)



**Angle Gage Blocks**  
4002-, 6540-  
(page 333)



**Digital Levels And  
Slope Meters**  
2175-, 2179-, 2170-,  
2199-, 2198-  
(page 498-500)

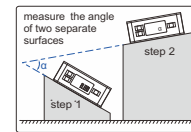

**STRAIGHTNESS  
AND FLATNESS**

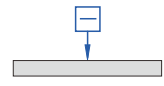

**Straight Edges**  
(page 389-391)



**Straightness/Flatness Gages**  
2144-  
(page 392)



**Flatness Measurement Stands**  
6852-  
(page 392)



**Optical Flats**  
4191-  
(page 391)



**SQUARENESS**

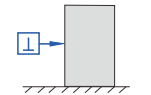

**Squares**  
4141-, 4144-, 4710-  
(page 381-382)



**Granite Squares With V Groove**  
4142-, 6539-  
(page 459)



# APPLICATION INDEX OF MEASURING TOOLS

**Perpendicularity Testers**  
4770-  
(page 383)



**Disk Micrometers**  
(page 153-156)

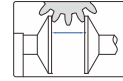

**Squares**  
(page 383-387)



**External Gear Tooth Micrometers**  
3291-, 3591-, 3636-  
(page 131-133)

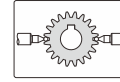

## COAXIALITY AND RUNOUT

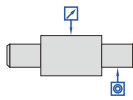

**Concentricity Gages**  
(page 394-398)



**Internal Gear Tooth Micrometers**  
3638-  
(page 176)



**Internal Gear Tooth Micrometers**  
3678-  
(page 170)



**Bench Centers**  
(page 398-404)



**Gear Bore Gages**  
2428-  
(page 196)

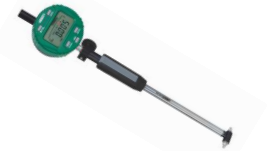

**V-blocks**  
(page 452-456)



**Universal Calipers**  
1125-  
(page 37-38)

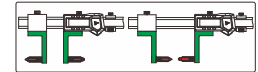

**Magnetic V-blocks**  
(page 456-458)



**Digital Calipers With Interchangeable Points**  
1526-, 1124-  
(page 38-40)



## DIAMETER OF CUTTING TOOLS WITH ODD FLUTES



**V Shape Calipers**  
1229-, 1273-, 1539-  
(page 63-64)



**Gear Tooth Pitch Gages**  
4860-  
(page 414)



**V-Anvil Micrometers**  
3290-, 3590-  
(page 149)



## KEYWAY

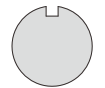

**Keyway Depth Gages**  
2182-, 2189-  
(page 216)

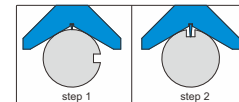

## GEAR AND SPLINE



**Digital Gear Tooth Calipers**  
1181-, 1281-  
(page 64)

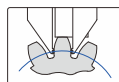

**Keyway Symmetry Gages**  
4865-  
(page 215)



**Keyway Symmetry Digital Calipers**  
1531-  
(page 215)



# APPLICATION INDEX OF MEASURING TOOLS

## THREAD

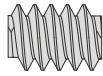

**Threaded Hole Location Gages**  
4662-, 4676-  
(page 350-351)



**Thread Depth Gages**  
4649-, 4666-  
(page 352-353)



**3-Wires**  
7382-, 7394-  
(page 126)



**External Screw Thread Micrometers**  
3281-, 3581-, 3680-  
(page 127-130)

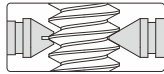

**Internal Screw Thread Micrometers**  
3641-, 3226-  
(page 176-177)

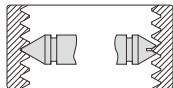

**Thread Plug Gages**  
(page 354-371)



**Thread Ring Gages**  
(page 358-365)



**Pitch Gages**  
4824-, 4820-  
(page 413-414)



**Universal Calipers**  
1125- (page 37-38)



**Digital Calipers With Interchangeable Points**  
1526-, 1124-  
(page 38-40)



## FOR OIL PIPES AND FLANGES

**Thread Pitch Measuring Instruments**  
2235-, 2234-, 2245-  
(page 302-303)



**Thread Taper Measuring Instruments**  
2230-, 2231-, 2240-, 2241-  
(page 304-306)

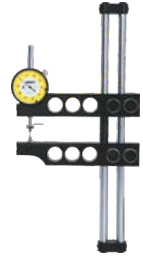

**Thread Height Measuring Instruments**  
2232-, 2233-, 2242-, 2243-, 2255-, 2256-  
(page 307-309)



**Thread Crest Diameter Measuring Instruments**  
2237-, 2236-, 2246-, 2247-  
(page 310-313)



**Digital Groove Width Measuring Instrument**  
2250-, 2260-  
(page 315)



**Digital Groove Diameter Measuring Instrument**  
2251-, 2261-  
(page 314)



**Digital Calipers With Interchangeable Ball Tips**  
1527-, 1528-  
(page 61)



**Digital RTJ Ring Groove Calipers**  
1179-  
(page 60)





**INSIZE DO (BRASIL) LTDA.**

Add: Av. do Trabalhador, 2640 - Centro  
Empresarial Castelo Branco,  
CEP 18552-100-Boituva-SP-Brasil  
Tel: +55 15 29490830  
E-mail: vendas@insize.com.br  
Website: www.insize.com.br



**INSIZE USA**

Add: 2230 Commerce Drive Loganville, GA 30052  
Tel: 470-240-2520  
Fax: 470-448-4771  
E-mail: sales@insizeus.com  
Website: www.insizeus.com



**INSIZE (CHINA) CO., LTD.**

Add: 80 Xiangyang Road, Suzhou New District,  
215009 China  
Tel: +86-512-68099993  
Fax: +86-512-68085081  
E-mail: china@insize.com  
Website: www.insize.cn



**INSIZE EUROPE S.L.**

Add: Arestí No 8, 48160, Derio, Spain  
Tel: +34-94-4544308  
E-mail: europe@insize.com  
Website: www.insize-eu.com



**INSIZE INDIA**

Add: Block B-09, Sumel-8, Nr. Ajit Mill Char  
Rasta, Rakhial Ahmedabad - 380023, India  
Tel: +91-78-19819939, 19819941  
E-mail: india@insize.com  
Website: www.insize.in



**INSIZE Czech s.r.o.**

Add: Krumlovská 1454/26, Ivančice 664 91,  
Czech republic  
Tel: +420-544 500 151  
GSM: +420-703 148 182  
E-mail: obchod@insize.cz  
Website: www.insize.cz



**INSIZE Mexico**

Add: Miguel Hidalgo 1332 Poniente Col La  
Esmeralda CP 67140, Guadalupe,  
Nuevo León, México  
Tel: +52 (81) 811 843 8316  
E-mail: hola@insize.mx  
Website: www.insize.mx



**www.insize.com**

**Application index of  
measuring tools  
(page 933-939)**



**Distributed by:**

