



CATALOG 18

Toronto • Montréal • Edmonton

CUTTING
TOOLS

INDEXABLE
CUTTING TOOLS

ABRASIVES,
FILES & GRINDING

TURNING, MILLING
& WORK HOLDING

HAND, MARKING
& AIR TOOLS

MEASURING TOOLS
& INSPECTION

SET-UP TOOLS
& THREAD REPAIR

REFERENCE
SECTION

KAR Industrial/Industriel Inc.

WWW.KAR.CA





Buy from the Tooling Specialist...

KAR Industrial Inc. is pleased to present the 18th edition of its tooling catalog. With over 650 colour pages and a new layout, this version of our catalog encompasses all of our new tools, features six-digit part numbers and includes a comprehensive easy to follow index.

Serving the Canadian Metalworking Industry since 1954, KAR recognizes the need to provide regional service across Canada with three warehouse locations and by stocking over 30,000 product SKU's. We are proud to partner with over 150 manufacturers and offer tools and name brands that are most requested by machine shops and manufacturing facilities.

Our Team is dedicated to meeting your expectations for products and service with each and every order.

Call the Tooling Specialist Today!

Faites vos achats auprès du spécialiste de l'outillage...

C'est avec plaisir que KAR Industriel Inc. vous présente la 18e édition de son catalogue d'outillage. Cette version de notre catalogue de plus de 650 pages en couleurs offre une nouvelle disposition et regroupe la totalité de nos nouveaux outils, affiche des numéros de pièces à six caractères et comprend un index complet facile à consulter.

Au service de l'industrie canadienne du travail des métaux depuis 1954, KAR reconnaît la nécessité d'offrir un service régional partout au Canada grâce à trois entrepôts différents approvisionnés de plus de 30 000 articles. Nous sommes fiers de notre partenariat avec plus de 150 fabricants ainsi que d'offrir les outils et les marques les plus demandés par les ateliers de mécanique et les usines de production.

Notre équipe s'efforce de satisfaire vos attentes en matière de produits et de service lors de chacune de vos commandes.

Communiquez avec le spécialiste de l'outillage dès aujourd'hui !



Cutting Tools 3-214

Drills, Reamers, Counterbores & Countersinks, Taps, Dies & Threading, End Mills & Roughers, Milling Cutters & Saws, Boring Bars, Broaches, Deburring Tools & Burrs, Tool Bits & Knurling Tools, Hole Cutters

1

Indexable Cutting Tools 215-298

Turning, Grooving, Parting, Threading, Milling, Thread Milling

2

Abrasives, Files & Sharpening 299-306

Mounted Flap Wheels, Mounted Points, Needle Files, Sharpening Stones

3

Turning, Milling & Work Holding 307-474

Live & Dead Centers, Lathe Chucks & Accessories, Turning, Milling, Machine Accessories, Vises & Accessories, Dividing Heads & Indexing Spacers, Clamping Components, Drilling, Tapping, Boring, Fluid Accessories

4

Hand, Marking & Air Tools 475-488

Wrenches, Marking Equipment & Supplies, Air Tapping, Punch Formers, Punches & Scribes, Inside/Outside Calipers & Dividers

5

Measuring Tools & Inspection Instruments 489-623

Calipers, Micrometers, Indicators & Depth Gages, Magnetic Stands, Height Gages, Bore Gages, Thickness Gages, Gage Blocks, Levels & Protractors, Rules, Straight Edges & Squares, Gages, Edge & Center Finders, Zero Setting, Surface Roughness, Measuring Tool Sets, Hardness Testers, Durometers, Microscopes & Videoscopes, Surface Plates, Loupes & Magnifiers

6

Set-Up Tools & Thread Repair 629-645

Angle Plates, Blocks & Parallels, Set-Up Tools, Straight Edges, Key Stock & Shim Stock, Drill Rods, Magnets

7

Reference 647-653

Black Book Reference Guides, Tap Drill Sizes, Decimal Equivalents, Cutting Speed Conversions, Speeds & Feeds for High Speed Steel Drills, Tap Drill Sizes for Forming Taps, Technical Information for Standard Carbide Drills

8

INDEX

Since 1954
Depuis 1954





Proudly serving the Metalworking Industry since 1954!

Buy from KAR, buy with confidence! With over 70 years of tooling experience, we use our knowledge to offer you the value that you want, quality you need and superior service you expect while saving you time and money.

With three conveniently located warehouses stocking over 30,000 SKU's, KAR has the ability to offer you:

- Inventory ready for immediate delivery
- Inventory sourced from over 150 manufacturer partners
- Opportunities to consolidate your orders with one supplier

We recognize and understand today's business demands and know that your time is valuable. We make doing business with KAR simple and efficient:

- Three order desks for customer service
- Open Monday to Friday from 8 am to 5 pm local time
- Toll free numbers: TORONTO1-800-387-3127
MONTRÉAL.....1-800-363-7862
EDMONTON1-866-440-4326
- All orders received by 4 pm local time are shipped the same day
- Orders for pick-ups are ready within one hour

Please give us a call if you can't find a product or require a size not listed in our catalog. One of our experienced customer service representatives will be pleased to help you find it.

KAR is your One Stop Shop for Cutting Tools and Machine Shop Accessories!

Au service de l'industrie du travail des métaux depuis 1954 !

Pour des achats en toute confiance, c'est à KAR qu'il faut penser ! Grâce à son expérience acquise au fil des 70 dernières années, KAR est en mesure d'offrir à ses clients des produits à la hauteur de leurs attentes ainsi qu'un service de qualité supérieure tout en leur faisant économiser temps et argent.

Grâce à ses trois entrepôts bien situés et approvisionnés de plus de 30 000 articles, KAR peut vous offrir :

- Un fond de stock prêt pour livraison immédiate
- Une importante quantité d'articles provenant de plus de 150 partenaires fournisseurs
- La possibilité de regrouper vos commandes auprès d'un seul et unique fournisseur

KAR sait parfaitement que votre temps est précieux et s'efforce de traiter avec sa clientèle de manière simple et efficace. Par conséquent, KAR offre à ses clients :

- Trois bureaux de commande pour assurer son service à la clientèle
- Heures d'ouverture du lundi au vendredi, de 8 h à 17 h (heure locale)
- Des numéros d'appels sans frais : TORONTO1-800-387-3127
MONTRÉAL.....1-800-363-7862
EDMONTON1-866-440-4326
- Toutes les commandes reçues avant 16 h (heure locale) sont expédiées le jour même
- Les commandes à ramasser sont prêtes à cueillir à l'intérieur d'un délai de une (1) heure

Si vous ne trouvez pas un produit ou que la dimension d'un article ne figure pas dans notre catalogue, n'hésitez pas à communiquer avec nous. L'un de nos représentants du Service à la clientèle sera heureux de vous aider dans vos recherches.

*KAR ... pour trouver tout d'un seul coup en matière
d'outils de coupe et d'accessoires pour ateliers de mécanique !*



Drills

4-69



Reamers

70-85



Counterbores & Countersinks

86-102



Taps, Dies & Threading

98-116



End Mills & Roughers

117-149



Milling Cutters & Saws

150-159



Boring Bars

160-167



Broaches

168-176



Deburring Tools & Burrs

177-201



Tool Bits & Knurling Tools

202-211



Hole Cutters

212-214



For Tap Drill Sizes,
Decimal Equivalents,
Cutting Speed Conversions,
Speeds & Feeds and other
Cutting Tool Technical Information
see REFERENCE Section

Jobber Length Drills

High Speed Steel & Cobalt

General Purpose – High Speed Steel – Black Oxide



- 118° point
- Oxide finish creates a porous layer that holds cutting oil which provides abrasion resistance and improved chip flow

High Production – High Speed Steel – Bi-Color



- 135° split point
- Black and gold finish

Heavy Duty – Super Cobalt



- 135° split point
- Type J

Super High Production - Heavy Duty – Cobalt



- 135° split point
- Gold/amber finish



High Speed Steel
Gold-P Coated



Tolerance of D	up to 1/8(.1250)
	0~ -.0005
	over 1/8(.1250) ~ up to 1/4(.2500)
	0~ -.0007
	over 1/4(.2500) ~ up to 1/2(.5000)
	0~ -.0010

- Straight shank
- Flute Geometry: right hand spiral with wider flutes
- Point Angle: 135° split point on sizes 0.059" diameter and over
- Surface treatment: bright body with TiN coating on working part
- Application: drilling in steel, cast steel (alloyed and non-alloyed), grey cast iron, graphite, and malleable cast iron

Size	Decimal Equivalent (Inch)	Flute Length (Inch)	Overall Length (Inch)	HSS 118° Point Black Oxide	HSS 135° Split Point Bi-Color	Super Cobalt 135° Split Point	Cobalt 135° Split Point	HSS Gold-P Coated
				Code	Code	Code	Code	Code
#80	0.0135	1/8	3/4	754605	-	606903	-	-
#79	0.0145	1/8	3/4	754606	-	606902	-	-
1/64	0.0156	3/16	3/4	752002	-	606755	-	-
#78	0.0160	3/16	7/8	754607	-	606901	-	-
#77	0.0180	3/16	7/8	754608	-	606900	-	-
#76	0.0200	3/16	7/8	754609	-	606899	-	-
#75	0.0210	1/4	1	754610	-	606898	-	-
#74	0.0225	1/4	1	754611	-	606897	-	-
#73	0.0240	5/16	1-1/8	754612	-	606896	-	-
#72	0.0250	5/16	1-1/8	754613	-	606895	-	-
#71	0.0260	3/8	1-1/4	754614	-	606894	-	-
#70	0.0280	3/8	1-1/4	754615	-	606893	-	-
#69	0.0292	1/2	1-3/8	754616	-	606892	-	-
#68	0.0310	1/2	1-3/8	754617	-	606891	-	-
1/32	0.0312	1/2	1-3/8	752003	-	606756	-	-
#67	0.0320	1/2	1-3/8	754618	-	606890	-	-
#66	0.0330	1/2	1-3/8	754619	-	606889	-	-
#65	0.0350	5/8	1-1/2	754620	-	606888	-	-
#64	0.0360	5/8	1-1/2	754621	-	606887	-	-
#63	0.0370	5/8	1-1/2	754622	-	606886	-	-
#62	0.0380	5/8	1-1/2	754623	-	606885	-	-
#61	0.0390	11/16	1-5/8	754624	-	606884	-	-
#60	0.0400	11/16	1-5/8	754625	606536	751001	606907	-
#59	0.0410	11/16	1-5/8	754626	606535	751002	606908	-
#58	0.0420	11/16	1-5/8	754627	606538	751003	606909	-
#57	0.0430	3/4	1-3/4	754628	606537	751004	606910	-
#56	0.0465	3/4	1-3/4	754629	606509	751005	606911	*883186
3/64	0.0469	3/4	1-3/4	752004	-	751006	-	*883020
#55	0.0520	7/8	1-7/8	754630	606534	751007	606912	*883187
#54	0.0550	7/8	1-7/8	754631	606533	751008	606913	*883188
#53	0.0595	7/8	1-7/8	754632	606508	751009	606914	883189
1/16	0.0625	7/8	1-7/8	752005	606450	751010	606700	883021

*Cobalt sizes under 1/16" are not split point

Jobber Length Drills

High Speed Steel & Cobalt (continued)



Size	Decimal Equivalent (Inch)	Flute Length (Inch)	Overall Length (Inch)	HSS 118° Point Black Oxide	HSS 135° Split Point Bi-Color	Super Cobalt 135° Split Point	Cobalt 135° Split Point	HSS Gold-P Coated
				Code	Code	Code	Code	Code
#52	0.0635	7/8	1-7/8	754633	606507	751011	606915	883190
#51	0.0670	1	2	754634	606506	751012	606916	883191
#50	0.0700	1	2	754635	606532	751013	606917	883192
#49	0.0730	1	2	754636	606531	751014	606918	883193
#48	0.0760	1	2	754637	606505	751015	606919	883194
5/64	0.0781	1	2	752006	606451	751016	606701	883022
#47	0.0785	1	2	754638	606504	751017	606920	883195
#46	0.0810	1-1/8	2-1/8	754639	606503	751018	606921	883196
#45	0.0820	1-1/8	2-1/8	754640	606530	751019	606922	883197
#44	0.0860	1-1/8	2-1/8	754641	606529	751020	606923	883198
#43	0.0890	1-1/4	2-1/4	754642	606502	751021	606924	883199
#42	0.0935	1-1/4	2-1/4	754643	606501	751022	606925	883200
3/32	0.0938	1-1/4	2-1/4	752007	606452	751023	606702	883023
#41	0.0960	1-3/8	2-3/8	754644	606500	751024	606926	883201
#40	0.0980	1-3/8	2-3/8	754645	606528	751025	606927	883202
#39	0.0995	1-3/8	2-3/8	754646	606527	751026	606928	883203
#38	0.1015	1-7/16	2-1/2	754647	606526	751027	606929	883204
#37	0.1040	1-7/16	2-1/2	754648	606525	751028	606930	883205
#36	0.1065	1-7/16	2-1/2	754649	606499	751029	606931	883206
7/64	0.1094	1-1/2	2-5/8	752008	606453	751030	606703	883024
#35	0.1100	1-1/2	2-5/8	754650	606498	751031	606932	883207
#34	0.1110	1-1/2	2-5/8	754651	606497	751032	606933	883208
#33	0.1130	1-1/2	2-5/8	754652	606524	751033	606934	883209
#32	0.1160	1-5/8	2-3/4	754653	606523	751034	606935	883210
#31	0.1200	1-5/8	2-3/4	754654	606496	751035	606936	883211
1/8	0.1250	1-5/8	2-3/4	752009	606454	751036	606704	883025
#30	0.1285	1-5/8	2-3/4	754655	606495	751037	606937	883212
#29	0.1360	1-3/4	2-7/8	754656	606494	751038	606938	883213
#28	0.1405	1-3/4	2-7/8	754657	606522	751039	606939	883214
9/64	0.1406	1-3/4	2-7/8	752010	606455	751040	606705	883026
#27	0.1440	1-7/8	3	754658	606521	751041	606940	883215
#26	0.1470	1-7/8	3	754659	606493	751042	606941	883216
#25	0.1495	1-7/8	3	754660	606492	751043	606942	883217
#24	0.1520	2	3-1/8	754661	606491	751044	606943	883218
#23	0.1540	2	3-1/8	754662	606520	751045	606944	883219
5/32	0.1562	2	3-1/8	752011	606456	751046	606706	883027
#22	0.1570	2	3-1/8	754663	606519	751047	606945	883220
#21	0.1590	2-1/8	3-1/4	754664	606490	751048	606946	883221
#20	0.1610	2-1/8	3-1/4	754665	606489	751049	606947	883222
#19	0.1660	2-1/8	3-1/4	754666	606488	751050	606948	883223
#18	0.1695	2-1/8	3-1/4	754667	606518	751051	606949	883224
11/64	0.1719	2-1/8	3-1/4	752012	606457	751052	606707	883028
#17	0.1730	2-3/16	3-3/8	754668	606517	751053	606950	883225
#16	0.1770	2-3/16	3-3/8	754669	606487	751054	606951	883226
#15	0.1800	2-3/16	3-3/8	754670	606486	751055	606952	883227
#14	0.1820	2-3/16	3-3/8	754671	606485	751056	606953	883228
#13	0.1850	2-5/16	3-1/2	754672	606516	751057	606954	883229
3/16	0.1875	2-5/16	3-1/2	752013	606458	751058	606708	883029
#12	0.1890	2-5/16	3-1/2	754673	606515	751059	606955	883230
#11	0.1910	2-5/16	3-1/2	754674	606484	751060	606956	883231
#10	0.1935	2-7/16	3-5/8	754675	606483	751061	606957	883232
#9	0.1960	2-7/16	3-5/8	754676	606482	751062	606958	883233
#8	0.1990	2-7/16	3-5/8	754677	606514	751063	606959	883234
#7	0.2010	2-7/16	3-5/8	754678	606513	751064	606960	883235

Jobber Length Drills

High Speed Steel & Cobalt (continued)



Size	Decimal Equivalent (Inch)	Flute Length (Inch)	Overall Length (Inch)	HSS 118° Point Black Oxide	HSS 135° Split Point Bi-Color	Super Cobalt 135° Split Point	Cobalt 135° Split Point	HSS Gold-P Coated
				Code	Code	Code	Code	Code
13/64	0.2031	2-7/16	3-5/8	752014	606459	751065	606709	883030
#6	0.2040	2-1/2	3-3/4	754679	606481	751066	606961	883236
#5	0.2055	2-1/2	3-3/4	754680	606480	751067	606962	883237
#4	0.2090	2-1/2	3-3/4	754681	606479	751068	606963	883238
#3	0.2130	2-1/2	3-3/4	754682	606512	751069	606964	883239
7/32	0.2188	2-1/2	3-3/4	752015	606460	751070	606710	883031
#2	0.2210	2-5/8	3-7/8	754683	606511	751071	606965	883240
#1	0.2280	2-5/8	3-7/8	754684	606510	751072	606966	883241
A	0.2340	2-5/8	3-7/8	752016	-	751073	606729	883108
15/64	0.2344	2-5/8	3-7/8	752017	606461	751074	606711	883032
B	0.2380	2-3/4	4	752018	-	751075	606730	883109
C	0.2420	2-3/4	4	606587	-	751076	606731	883110
D	0.2460	2-3/4	4	752019	-	751077	606732	883111
1/4 or E	0.2500	2-3/4	4	752020	606462	751078	606712	883033 (1/4") 883112 (E)
F	0.2570	2-7/8	4-1/8	752021	-	751079	606733	883113
G	0.2610	2-7/8	4-1/8	752022	-	751080	606734	883114
17/64	0.2656	2-7/8	4-1/8	752023	606463	751081	606713	883034
H	0.2660	2-7/8	4-1/8	752024	-	751082	606735	883115
I	0.2720	2-7/8	4-1/8	752025	-	751083	606736	883116
J	0.2770	2-7/8	4-1/8	752026	-	751084	606737	883117
K	0.2810	2-15/16	4-1/4	752027	-	751085	606738	883118
9/32	0.2812	2-15/16	4-1/4	752028	606464	751086	606714	883035
L	0.2900	2-15/16	4-1/4	752029	-	751087	606739	883119
M	0.2950	3-1/16	4-3/8	752030	-	751088	606740	883120
19/64	0.2969	3-1/16	4-3/8	752031	606465	751089	606715	883036
N	0.3020	3-1/16	4-3/8	752032	-	751090	606741	883121
5/16	0.3125	3-3/16	4-1/2	752033	606466	751091	606716	883037
O	0.3160	3-3/16	4-1/2	-	-	751092	606742	883122
P	0.3230	3-5/16	4-5/8	752035	-	751093	606743	883123
21/64	0.3281	3-5/16	4-5/8	752036	606467	751094	606717	883038
Q	0.3320	3-7/16	4-3/4	752037	-	751095	606744	883124
R	0.3390	3-7/16	4-3/4	752038	-	751096	606745	883125
11/32	0.3438	3-7/16	4-3/4	752039	606468	751097	606718	883039
S	0.3480	3-1/2	4-7/8	752040	-	751098	606746	883126
T	0.3580	3-1/2	4-7/8	752041	-	751099	606747	883127
23/64	0.3594	3-1/2	4-7/8	752042	606469	751100	606719	883040
U	0.3680	3-5/8	5	752043	-	751101	606748	883128
3/8	0.3750	3-5/8	5	752044	606470	751102	606720	883041
V	0.3770	3-5/8	5	752045	-	751103	606749	883129
W	0.3860	3-3/4	5-1/8	752046	-	751104	606750	883130
25/64	0.3906	3-3/4	5-1/8	752047	606471	751105	606721	883042
X	0.3970	3-3/4	5-1/8	752048	-	751106	606751	883131
Y	0.4040	3-7/8	5-1/4	752049	-	751107	606752	883132
13/32	0.4062	3-7/8	5-1/4	752050	606472	751108	606722	883043
Z	0.4130	3-7/8	5-1/4	752051	-	751109	606753	883133
27/64	0.4219	3-15/16	5-3/8	752052	606473	751110	606723	883044
7/16	0.4375	4-1/16	5-1/2	752053	606474	751111	606724	883045
29/64	0.4531	4-3/16	5-5/8	752054	606475	751112	606725	883046
15/32	0.4688	4-5/16	5-3/4	752055	606476	751113	606726	883047
31/64	0.4844	4-3/8	5-7/8	752056	606477	751114	606727	883048
1/2	0.5000	4-1/2	6	752057	606478	751115	606728	883049
33/64	0.5156	4-13/16	6-5/8	752058	-	606787	-	-

Jobber Length Drills

High Speed Steel & Cobalt (continued)



Size	Decimal Equivalent (Inch)	Flute Length (Inch)	Overall Length (Inch)	HSS 118° Point Black Oxide	HSS 135° Split Point Bi-Color	Super Cobalt 135° Split Point	Cobalt 135° Split Point	HSS Gold-P Coated
				Code	Code	Code	Code	Code
17/32	0.5312	4-13/16	6-5/8	752059	-	606788	-	-
35/64	0.5469	4-13/16	6-5/8	752060	-	606789	-	-
9/16	0.5625	4-13/16	6-5/8	752061	-	606790	-	-
37/64	0.5781	4-13/16	6-5/8	752062	-	606791	-	-
19/32	0.5938	5-3/16	7-1/8	752063	-	606792	-	-
39/64	0.6094	5-3/16	7-1/8	752064	-	606793	-	-
5/8	0.6250	5-3/16	7-1/8	752065	-	606794	-	-
41/64	0.6406	5-3/16	7-1/8	752066	-	606795	-	-
21/32	0.6562	5-3/16	7-1/8	752067	-	606796	-	-
43/64	0.6719	5-5/8	7-5/8	752068	-	606797	-	-
11/16	0.6875	5-5/8	7-5/8	752069	-	606798	-	-
23/32	0.7188	5-5/8	7-5/8	606583	-	-	-	-
3/4	0.7500	5-5/8	7-5/8	606584	-	-	-	-

Metric Jobber Length Drills

High Speed Steel – Gold-P Coated



- Straight shank
- Flute Geometry: right hand helix
- Point Angle: 135° (split point on sizes 1.6mm diameter and over)
- Surface treatment: bright body with TiN coating on working part
- Application: drilling in steel, cast steel (alloyed and non-alloyed), grey cast iron, graphite, and malleable cast iron

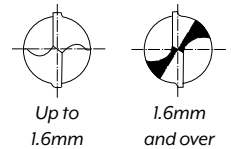

ASK ABOUT OTHER SIZES IN SERIES AVAILABLE FOR SPECIAL ORDER

Size	Decimal Equivalent (Inch)	Flute Length (mm)	Overall Length (mm)	Code	Size	Decimal Equivalent (Inch)	Flute Length (mm)	Overall Length (mm)	Code
1.0	0.0394	12	34	883450	5.7	0.2244	57	93	883487
1.3	0.0512	16	38	883475	5.9	0.2323	57	93	883488
1.4	0.0551	18	40	883476	6.0	0.2362	57	93	883460
1.5	0.0591	18	40	883451	6.1	0.2402	63	101	883489
1.8	0.0709	22	46	883477	6.2	0.2441	63	101	883490
1.9	0.0748	22	46	883478	6.3	0.2480	63	101	883491
2.0	0.0787	24	49	883452	6.4	0.2520	63	101	883492
2.1	0.0827	24	49	883479	6.5	0.2559	63	101	883461
2.2	0.0866	27	53	883480	7.0	0.2756	69	109	883462
2.3	0.0906	27	53	883481	7.1	0.2795	69	109	883493
2.5	0.0984	30	57	883453	7.2	0.2835	69	109	883494
3.0	0.1181	33	61	883454	7.3	0.2874	69	109	883495
3.1	0.1222	36	65	883482	7.5	0.2953	69	109	883463
3.3	0.1299	36	65	883483	7.8	0.3071	75	117	883496
3.4	0.1339	39	70	883484	8.0	0.315	75	117	883464
3.5	0.1378	39	70	883455	8.1	0.3189	75	117	883497
3.8	0.1496	43	75	883485	8.5	0.3346	75	117	883465
4.0	0.1575	43	75	883456	8.6	0.3386	81	125	883498
4.5	0.1772	47	80	883457	8.7	0.3425	81	125	883499
5.0	0.1969	52	86	883458	8.8	0.3465	81	125	883590
5.3	0.2087	52	86	883486	9.0	0.3543	81	125	883466
5.5	0.2165	57	93	883459	9.3	0.3661	81	125	883592

Metric Jobber Length Drills

High Speed Steel – Gold-P Coated (*continued*)



ASK ABOUT OTHER SIZES IN SERIES AVAILABLE FOR SPECIAL ORDER

Size	Decimal Equivalent (Inch)	Flute Length (mm)	Overall Length (mm)	Code	Size	Decimal Equivalent (Inch)	Flute Length (mm)	Overall Length (mm)	Code
9.4	0.3701	81	125	883593	10.7	0.4212	94	142	883600
9.5	0.3740	81	125	883467	10.8	0.4252	94	142	883601
9.6	0.3780	87	133	883594	10.9	0.4291	94	142	883602
9.7	0.3819	87	133	883595	11.0	0.4330	94	142	883470
9.9	0.3898	87	133	883596	11.3	0.4448	94	142	883603
10.0	0.3937	87	133	883468	11.5	0.4527	94	142	883471
10.2	0.4016	87	133	883597	11.6	0.4566	94	142	883604
10.4	0.4094	87	133	883598	11.8	0.4645	94	142	883605
10.5	0.4134	87	133	883469	12.0	0.4724	101	151	883472
10.6	0.4173	87	133	883599	12.5	0.4921	101	151	883473
					13.0	0.5118	101	151	883474

Metric Jobber Length Drills

General Purpose – High Speed Steel – Black Oxide & *Bright Finish



• 118° point

(*Bright Finish)

Size (mm)	Decimal Equiv. (Inch)	Flute Length (Inch)	Overall Length (Inch)	Code	Size (mm)	Decimal Equiv. (Inch)	Flute Length (Inch)	Overall Length (Inch)	Code	Size (mm)	Decimal Equiv. (Inch)	Flute Length (Inch)	Overall Length (Inch)	Code
0.15	0.0059	3/64	3/4	615400	2.00	0.0787	1	2-1/8	615457	6.20	0.2441	2-3/4	4	615511
0.16	0.0063	3/64	3/4	*615401	2.05	0.0807	1-1/8	2-1/8	615458	6.25	0.2461	2-3/4	4	615512
0.17	0.0067	1/16	3/4	*615402	2.10	0.0827	1-1/8	2-1/8	615459	6.30	0.2480	2-3/4	4	615513
0.18	0.0071	1/16	3/4	*615403	2.15	0.0846	1-1/8	2-1/8	615460	6.40	0.2520	2-7/8	4-1/8	615514
0.19	0.0075	1/16	3/4	615404	2.20	0.0866	1-1/4	2-1/4	615461	6.50	0.2559	2-7/8	4-1/8	615515
0.20	0.0079	1/16	3/4	615405	2.25	0.0886	1-1/4	2-1/4	615462	6.60	0.2598	2-7/8	4-1/8	615516
0.21	0.0083	3/32	3/4	*615406	2.30	0.0906	1-1/4	2-1/4	615463	6.70	0.2638	2-7/8	4-1/8	615517
0.22	0.0087	1/16	3/4	*615407	2.35	0.0925	1-1/4	2-1/4	615464	6.75	0.2657	2-7/8	4-1/8	615518
0.23	0.0091	3/32	3/4	615408	2.40	0.0945	1-3/8	2-3/8	615465	6.80	0.2677	2-7/8	4-1/8	615519
0.26	0.0102	5/64	3/4	*615411	2.45	0.0965	1-3/8	2-3/8	615466	6.90	0.2717	2-7/8	4-1/8	615520
0.28	0.0110	5/64	3/4	*615413	2.50	0.0984	1-3/8	2-3/8	615467	7.00	0.2756	2-7/8	4-1/8	615521
0.29	0.0114	5/64	3/4	615414	2.60	0.1024	1-7/16	2-1/2	615468	7.10	0.2795	2-15/16	4-1/4	615522
0.30	0.0118	3/32	3/4	615415	2.70	0.1063	1-7/16	2-1/2	615469	7.20	0.2835	2-15/16	4-1/4	615523
0.32	0.0126	3/32	3/4	615416	2.75	0.1083	1-1/2	2-5/8	615470	7.25	0.2854	2-15/16	4-1/4	615524
0.34	0.0134	5/32	3/4	*615417	2.80	0.1102	1-1/2	2-5/8	615471	7.30	0.2874	2-15/16	4-1/4	615525
0.35	0.0138	1/8	3/4	615418	2.90	0.1142	1-5/8	2-3/4	615472	7.40	0.2913	3-1/16	4-3/8	615526
0.36	0.0142	5/32	3/4	*615419	3.00	0.1181	1-5/8	2-3/4	615473	7.50	0.2953	3-1/16	4-3/8	615527
0.38	0.0150	3/16	3/4	*615420	3.10	0.1220	1-5/8	2-3/4	615474	7.60	0.2992	3-1/16	4-3/8	615528
0.40	0.0158	3/16	7/8	615421	3.20	0.1260	1-5/8	2-3/4	615475	7.70	0.3031	3-3/16	4-1/2	615529
0.42	0.0165	3/16	7/8	*615422	3.25	0.1280	1-5/8	2-3/4	615476	7.75	0.3051	3-3/16	4-1/2	615530
0.44	0.0173	3/16	7/8	*615423	3.30	0.1299	1-3/4	2-7/8	615477	7.80	0.3071	3-3/16	4-1/2	615531
0.45	0.0177	3/16	7/8	615424	3.40	0.1339	1-3/4	2-7/8	615478	7.85	0.3091	3-3/16	4-1/2	615532
0.46	0.0181	3/16	7/8	*615425	3.50	0.1378	1-3/4	2-7/8	615479	7.90	0.3110	3-3/16	4-1/2	615533
0.48	0.0189	3/16	7/8	615426	3.60	0.1417	1-7/8	3	615480	8.00	0.3150	3-3/16	4-1/2	615534
0.50	0.0197	3/16	7/8	615427	3.70	0.1457	1-7/8	3	615481	8.10	0.3189	3-5/16	4-5/8	615535
0.55	0.0217	1/4	1	615428	3.75	0.1476	1-7/8	3	615482	8.20	0.3228	3-5/16	4-5/8	615536
0.60	0.0236	5/16	1-1/8	615429	3.80	0.1496	1-7/8	3	615483	8.25	0.3248	3-5/16	4-5/8	615537
0.65	0.0256	3/8	1-1/4	615430	3.90	0.1535	2	3-1/8	615484	8.30	0.3268	3-5/16	4-5/8	615538
0.70	0.0276	3/8	1-1/4	615431	4.00	0.1575	2-1/8	3-1/4	615485	8.40	0.3307	3-7/16	4-3/4	615539
0.75	0.0295	1/2	1-3/8	615432	4.10	0.1614	2-1/8	3-1/4	615486	8.50	0.3346	3-7/16	4-3/4	615540
0.80	0.0315	1/2	1-3/8	615433	4.20	0.1654	2-1/8	3-1/4	615487	8.60	0.3386	3-7/16	4-3/4	615541
0.85	0.0335	5/8	1-1/2	615434	4.25	0.1673	2-1/8	3-1/4	615488	8.70	0.3425	3-7/16	4-3/4	615542
0.90	0.0355	5/8	1-1/2	615435	4.30	0.1693	2-1/8	3-1/4	615489	8.75	0.3445	3-1/2	4-7/8	615543
0.95	0.0374	5/8	1-1/2	615436	4.40	0.1732	2-3/16	3-3/8	615490	8.80	0.3465	3-1/2	4-7/8	615544
1.00	0.0394	11/16	1-5/8	615437	4.50	0.1772	2-3/16	3-3/8	615491	8.90	0.3504	3-1/2	4-7/8	615545
1.05	0.0413	11/16	1-5/8	615438	4.60	0.1811	2-3/16	3-3/8	615492	9.00	0.3543	3-1/2	4-7/8	615546
1.10	0.0433	3/4	1-3/4	615439	4.70	0.1850	2-5/16	3-1/2	615493	9.10	0.3583	3-1/2	4-7/8	615547
1.15	0.0453	3/4	1-3/4	615440	4.75	0.1870	2-5/16	3-1/2	615494	9.20	0.3622	3-5/8	5	615548
1.20	0.0472	7/8	1-7/8	615441	4.80	0.1890	2-5/16	3-1/2	615495	9.25	0.3642	3-5/8	5	615549
1.25	0.0492	7/8	1-7/8	615442	4.90	0.1929	2-7/16	3-5/8	615496	9.30	0.3661	3-5/8	5	615550
1.30	0.0512	7/8	1-7/8	615443	5.00	0.1968	2-7/16	3-5/8	615497	9.40	0.3701	3-5/8	5	615551
1.35	0.0531	7/8	1-7/8	615444	5.10	0.2008	2-7/16	3-5/8	615498	9.50	0.3740	3-5/8	5	615552
1.40	0.0551	7/8	1-7/8	615445	5.20	0.2047	2-1/2	3-3/4	615499	9.60	0.3780	3-3/4	5-1/8	615553
1.45	0.0571	7/8	1-7/8	615446	5.25	0.2067	2-1/2	3-3/4	615500	9.70	0.3819	3-3/4	5-1/8	615554
1.50	0.0591	7/8	1-7/8	615447	5.30	0.2087	2-1/2	3-3/4	615501	9.75	0.3839	3-3/4	5-1/8	615555
1.55	0.0610	7/8	1-7/8	615448	5.40	0.2126	2-1/2	3-3/4	615502	9.80	0.3858	3-3/4	5-1/8	615556
1.60	0.0630	7/8	1-7/8	615449	5.50	0.2165	2-1/2	3-3/4	615503	9.90	0.3898	3-3/4	5-1/8	615557
1.65	0.0650	1	2	615450	5.60	0.2205	2-5/8	3-7/8	615504	10.00	0.3937	3-3/4	5-1/8	615558
1.70	0.0669	1	2	615451	5.70	0.2244	2-5/8	3-7/8	615505	10.10	0.3976	3-3/4	5-1/4	615559
1.75	0.0689	1	2	615452	5.75	0.2264	2-5/8	3-7/8	615506	10.20	0.4016	3-7/8	5-1/4	615560
1.80	0.0709	1	2	615453	5.80	0.2283	2-5/8	3-7/8	615507	10.30	0.4055	3-7/8	5-1/4	615561
1.85	0.0728	1	2	615454	5.90	0.2323	2-5/8	3-7/8	615508	10.40	0.4094	3-7/8	5-1/4	615562
1.90	0.0748	1	2	615455	6.00	0.2362	2-3/4	4	615509	10.50	0.4134	3-15/16	5-3/8	615563
1.95	0.0768	1	2	615456	6.10	0.2402	2-3/4	4	615510	10.70	0.4213	3-15/16	5-3/8	615564

Metric Jobber Length Drills

General Purpose – High Speed Steel – Black Oxide & *Bright Finish (continued)



• 118° point

Size (mm)	Decimal Equiv. (Inch)	Flute Length (Inch)	Overall Length (Inch)	Code	Size (mm)	Decimal Equiv. (Inch)	Flute Length (Inch)	Overall Length (Inch)	Code	Size (mm)	Decimal Equiv. (Inch)	Flute Length (Inch)	Overall Length (Inch)	Code
10.80	0.4252	4-1/16	5-1/2	615565	12.10	0.4764	4-3/8	5-7/8	615579	14.00	0.5512	4-13/16	6-5/8	615593
10.90	0.4291	4-1/16	5-1/2	615566	12.20	0.4803	4-3/8	5-7/8	615580	14.50	0.5709	4-13/16	6-5/8	615594
11.00	0.4331	4-1/16	5-1/2	615567	12.25	0.4823	4-3/8	5-7/8	615581	15.00	0.5906	5-3/16	7-1/8	615595
11.10	0.4370	4-1/16	5-1/2	615568	12.30	0.4843	4-3/8	5-7/8	615582	15.25	0.6004	5-3/16	7-1/8	615596
11.20	0.4409	4-3/16	5-5/8	615569	12.40	0.4882	4-3/8	5-7/8	615583	15.50	0.6102	5-3/16	7-1/8	615597
11.25	0.4429	4-3/16	5-5/8	615570	12.50	0.4921	4-1/2	6	615584	16.00	0.6299	5-3/16	7-1/8	615598
11.30	0.4449	4-3/16	5-5/8	615571	12.60	0.4961	4-1/2	6	615585	16.50	0.6490	5-3/16	7-1/8	615599
11.40	0.4488	4-3/16	5-5/8	615572	12.70	0.5000	4-1/2	6	615586	17.00	0.6693	5-5/8	7-5/8	615600
11.50	0.4528	4-3/16	5-5/8	615573	12.75	0.5020	4-1/2	6	615587	17.50	0.6890	5-5/8	7-5/8	615601
11.60	0.4567	4-3/16	5-5/8	615574	12.80	0.5039	4-1/2	6	615588	18.00	0.7087	5-5/8	7-5/8	615602
11.70	0.4606	4-3/16	5-5/8	615575	12.90	0.5079	4-1/2	6	615589	19.00	0.7480	5-5/8	7-5/8	615603
11.80	0.4646	4-3/16	5-5/8	615576	13.00	0.5118	4-1/2	6	615590	19.50	0.7677	5-5/8	7-5/8	615604
11.90	0.4685	4-3/16	5-5/8	615577	13.50	0.5315	4-13/16	6-5/8	615591	20.00	0.7874	5-5/8	7-5/8	615605
12.00	0.4724	4-3/8	5-7/8	615578	13.80	0.5433	4-13/16	6-5/8	615592					

Jobber Length Drills



Inch, Metric, Wire Gage & Letter Sizes – Solid Carbide – 118° Point

- For drilling steels in general – cast steels, cast iron, chilled cast iron, malleable cast iron, non-ferrous heavy metals, non-ferrous light metals, and abrasive plastics

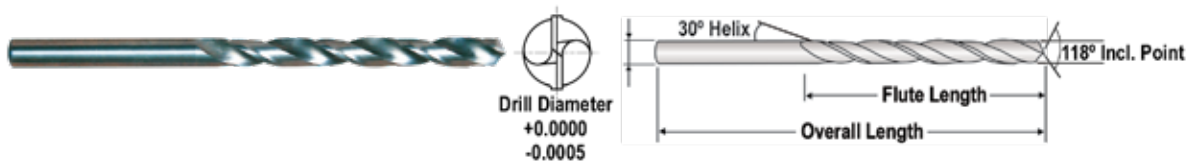

Size	Decimal Equivalent (Inch)	Flute Length	Overall Length	Code	Size	Decimal Equivalent (Inch)	Flute Length	Overall Length	Code
1/32	0.0312	5/16	1-1/4	952088	45	0.0820	1	1-3/4	952306
1 mm	0.0394	15.9 mm	38.1 mm	952640	44	0.0860	1	2	952304
60	0.0400	3/4	1-1/2	952336	43	0.0890	1	2	952302
59	0.0410	3/4	1-1/2	952334	42	0.0935	1	2	952300
58	0.0420	3/4	1-1/2	952332	3/32	0.0938	1	2	952096
57	0.0430	3/4	1-1/2	952330	41	0.0960	1	2	952298
56	0.0465	3/4	1-1/2	952328	40	0.0980	1	2	952296
3/64	0.0469	3/4	1-1/2	952090	2.5 mm	0.0984	25.4 mm	50.8 mm	952646
55	0.0520	3/4	1-1/2	952326	39	0.0995	1-1/4	2-1/4	952294
54	0.0550	3/4	1-1/2	952324	38	0.1015	1-1/4	2-1/4	952292
1.5 mm	0.0591	19.1 mm	38.1 mm	952642	37	0.1040	1-1/4	2-1/4	952290
53	0.0595	3/4	1-1/2	952322	36	0.1065	1-1/4	2-1/4	952288
1/16	0.0625	3/4	1-1/2	952092	7/64	0.1094	1-1/4	2-1/4	952098
52	0.0635	3/4	1-1/2	952320	35	0.1100	1-1/4	2-1/4	952286
51	0.0670	3/4	1-1/2	952318	34	0.1110	1-1/4	2-1/4	952284
50	0.0700	7/8	1-3/4	952316	33	0.1130	1-1/4	2-1/4	952282
49	0.0730	7/8	1-3/4	952314	32	0.1160	1-1/4	2-1/4	952280
48	0.0760	7/8	1-3/4	952312	3 mm	0.1181	31.8 mm	57.2 mm	952648
5/64	0.0781	7/8	1-3/4	952094	31	0.1200	1-1/4	2-1/4	952278
47	0.0785	7/8	1-3/4	952310	1/8	0.1250	1-1/4	2-1/4	952100
2 mm	0.0787	22.2 mm	44.5 mm	952644	30	0.1285	1-1/4	2-1/4	952276
46	0.0810	7/8	1-3/4	952308	29	0.1360	1-3/8	2-1/2	952274

Jobber Length Drills

Inch, Metric & Wire Gage Sizes – Solid Carbide – 118° Point (continued)

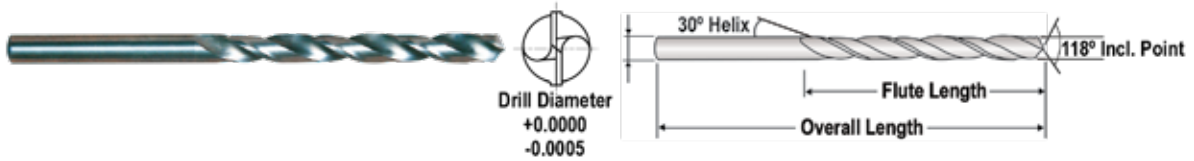

Size	Decimal Equivalent (Inch)	Flute Length	Overall Length	Code	Size	Decimal Equivalent (Inch)	Flute Length	Overall Length	Code
3.5 mm	0.1378	34.9 mm	63.5 mm	952650	F	0.2570	2	3-1/4	952168
28	0.1405	1-3/8	2-1/2	952272	G	0.2610	2-1/8	3-1/2	952170
9/64	0.1406	1-3/8	2-1/2	952102	17/64	0.2656	2-1/8	3-1/2	952118
27	0.1440	1-3/8	2-1/2	952270	H	0.2660	2-1/8	3-1/2	952172
26	0.1470	1-3/8	2-1/2	952268	I	0.2720	2-1/8	3-1/2	952174
25	0.1495	1-3/8	2-1/2	952266	7 mm	0.2756	54.0 mm	88.9 mm	952664
24	0.1520	1-3/8	2-1/2	952264	J	0.2770	2-1/8	3-1/2	952176
23	0.1540	1-3/8	2-1/2	952262	K	0.2810	2-1/8	3-1/2	952178
5/32	0.1563	1-3/8	2-1/2	952104	9/32	0.2812	2-1/8	3-1/2	952120
22	0.1570	1-3/8	2-1/2	952260	L	0.2900	2-1/8	3-1/2	952180
4 mm	0.1575	34.9 mm	63.5 mm	952652	M	0.2950	2-3/8	3-3/4	952182
21	0.1590	1-3/8	2-1/2	952258	7.5 mm	0.2953	60.3 mm	101.6 mm	952666
20	0.1610	1-3/8	2-1/2	952256	19/64	0.2969	2-3/8	3-3/4	952122
19	0.1660	1-5/8	2-3/4	952254	N	0.3020	2-3/8	3-3/4	952184
18	0.1695	1-5/8	2-3/4	952252	5/16	0.3125	2-3/8	3-3/4	952124
11/64	0.1719	1-5/8	2-3/4	952106	8 mm	0.3150	60.3 mm	101.6 mm	952668
17	0.1730	1-5/8	2-3/4	952250	O	0.3160	2-3/8	3-3/4	952186
16	0.1770	1-5/8	2-3/4	952248	P	0.3230	2-3/8	3-3/4	952188
4.5 mm	0.1772	41.3 mm	69.9 mm	952654	21/64	0.3281	2-1/2	4	952126
15	0.1800	1-5/8	2-3/4	952246	Q	0.3320	2-1/2	4	952190
14	0.1820	1-5/8	2-3/4	952244	8.5 mm	0.3346	63.5 mm	101.6 mm	952670
13	0.1850	1-5/8	2-3/4	952242	R	0.3390	2-1/2	4	952192
3/16	0.1875	1-5/8	2-3/4	952108	11/32	0.3438	2-1/2	4	952128
12	0.1890	1-5/8	2-3/4	952240	S	0.3480	2-1/2	4	952194
11	0.1910	1-5/8	2-3/4	952238	9 mm	0.3543	69.9 mm	108 mm	952672
10	0.1935	1-5/8	2-3/4	952236	T	0.3580	2-3/4	4-1/4	952196
9	0.1960	1-3/4	3	952234	23/64	0.3594	2-3/4	4-1/4	952130
5 mm	0.1969	44.5 mm	76.2 mm	952656	U	0.3680	2-3/4	4-1/4	952198
8	0.1990	1-3/4	3	952232	9.5 mm	0.3740	69.9 mm	108 mm	952674
7	0.2010	1-3/4	3	952230	3/8	0.3750	2-3/4	4-1/4	952132
13/64	0.2031	1-3/4	3	952110	V	0.3770	2-3/4	4-1/4	952200
6	0.2040	1-3/4	3	952228	W	0.3860	2-7/8	4-1/2	952202
5	0.2055	1-3/4	3	952226	25/64	0.3906	2-7/8	4-1/2	952134
4	0.2090	1-3/4	3	952224	10 mm	0.3937	73.0 mm	114.3 mm	952676
3	0.2130	1-3/4	3	952222	X	0.3970	2-7/8	4-1/2	952204
5.5 mm	0.2165	44.5 mm	76.2 mm	952658	Y	0.4040	2-7/8	4-1/2	952206
7/32	0.2188	1-3/4	3	952112	13/32	0.4062	2-7/8	4-1/2	952136
2	0.2210	1-3/4	3	952220	Z	0.4130	2-7/8	4-1/2	952208
1	0.2280	1-3/4	3	952218	10.5 mm	0.4134	73.0 mm	114.3 mm	952678
A	0.2340	2	3-1/4	952158	27/64	0.4219	2-7/8	4-1/2	952138
15/64	0.2344	2	3-1/4	952114	11 mm	0.4331	73.0 mm	114.3 mm	952680
6 mm	0.2362	50.8 mm	82.6 mm	952660	7/16	0.4375	2-7/8	4-1/2	952140
B	0.2380	2	3-1/4	952160	11.5 mm	0.4528	76.2 mm	120.7 mm	952682
C	0.2420	2	3-1/4	952162	29/64	0.4531	3	4-3/4	952142
D	0.2460	2	3-1/4	952164	15/32	0.4688	3	4-3/4	952144
1/4 (E)	0.2500	2	3-1/4	952116	12 mm	0.4724	76.2 mm	120.7 mm	952684
E	0.2500	2	3-1/4	952166	31/64	0.4844	3	4-3/4	952146
6.5 mm	0.2559	50.8 mm	82.6 mm	952662	1/2	0.5000	3	4-3/4	952148

NOTE: See Reference section for recommended cutting conditions for standard carbide drills

Jobber Length Drills

Inch, Metric & Wire Gage Sizes – Carbide Tipped – 118° Point



- Designed for production drilling of cast iron, non-ferrous metals, composites, plastics, and non-metals (Not normally recommended for drilling steels)
- Carbide tips are high temperature brazed to hardened high speed steel bodies
- Choose carbide tipped design when setup rigidity is difficult to maintain and where cost control is indicated and regrind life is not a significant factor

Size	Decimal Equivalent (Inch)	Flute Length (Inch)	Overall Length (Inch)	Code
32	0.1160	1-5/8	2-3/4	555101
31	0.1200	1-5/8	2-3/4	555102
1/8	0.1250	1-5/8	2-3/4	555103
30	0.1285	1-5/8	2-3/4	555104
29	0.1360	2	3-1/8	555105
28	0.1405	2	3-1/8	555106
9/64	0.1406	2	3-1/8	555107
27	0.1440	2	3-1/8	555108
26	0.1470	2	3-1/8	555109
25	0.1495	2	3-1/8	555110
24	0.1520	2	3-1/8	555111
23	0.1540	2	3-1/8	555112
5/32	0.1562	2	3-1/8	555113
22	0.1570	2	3-1/8	555114
21	0.1590	2	3-1/8	555115
20	0.1610	2-5/16	3-1/2	555116
19	0.1660	2-5/16	3-1/2	555117
18	0.1695	2-5/16	3-1/2	555118
11/64	0.1719	2-5/16	3-1/2	555119
17	0.1730	2-5/16	3-1/2	555120
16	0.1770	2-5/16	3-1/2	555121
15	0.1800	2-5/16	3-1/2	555122
14	0.1820	2-5/16	3-1/2	555123
13	0.1850	2-5/16	3-1/2	555124
3/16	0.1875	2-5/16	3-1/2	555125
12	0.1890	2-5/16	3-1/2	555126
11	0.1910	2-5/16	3-1/2	555127
10	0.1935	2-1/2	3-3/4	555128
9	0.1960	2-1/2	3-3/4	555129
8	0.1990	2-1/2	3-3/4	555130
7	0.2010	2-1/2	3-3/4	555131
13/64	0.2031	2-1/2	3-3/4	555132
6	0.2040	2-1/2	3-3/4	555133
5	0.2055	2-1/2	3-3/4	555134
4	0.2090	2-1/2	3-3/4	555135
3	0.2130	2-1/2	3-3/4	555136
7/32	0.2188	2-1/2	3-3/4	555137
2	0.2210	2-1/2	3-3/4	555138
1	0.2280	2-3/4	4	555139
A	0.2340	2-3/4	4	555140

Size	Decimal Equivalent (Inch)	Flute Length (Inch)	Overall Length (Inch)	Code
15/64	0.2344	2-3/4	4	555141
B	0.2380	2-3/4	4	555142
C	0.2420	2-3/4	4	555143
D	0.2460	2-3/4	4	555144
1/4 & E	0.2500	2-3/4	4	555146
F	0.2570	2-15/16	4-1/4	555147
G	0.2610	2-15/16	4-1/4	555148
17/64	0.2656	2-15/16	4-1/4	555149
H	0.2660	2-15/16	4-1/4	555150
I	0.2720	2-15/16	4-1/4	555151
J	0.2770	2-15/16	4-1/4	555152
K	0.2810	2-15/16	4-1/4	555153
9/32	0.2812	2-15/16	4-1/4	555154
L	0.2900	3-3/16	4-1/2	555155
M	0.2950	3-3/16	4-1/2	555156
19/64	0.2969	3-3/16	4-1/2	555157
N	0.3020	3-3/16	4-1/2	555158
5/16	0.3125	3-3/16	4-1/2	555159
O	0.3160	3-3/16	4-1/2	555160
P	0.3230	3-7/16	4-3/4	555161
21/64	0.3281	3-7/16	4-3/4	555162
R	0.3390	3-7/16	4-3/4	555164
11/32	0.3438	3-7/16	4-3/4	555165
S	0.3480	3-5/8	5	555166
T	0.3580	3-5/8	5	555167
23/64	0.3594	3-5/8	5	555168
U	0.3680	3-5/8	5	555169
3/8	0.3750	3-5/8	5	555170
V	0.3770	3-5/8	5	555171
W	0.3860	3-7/8	5-1/4	555172
25/64	0.3906	3-7/8	5-1/4	555173
X	0.3970	3-7/8	5-1/4	555174
Y	0.4040	3-7/8	5-1/4	555175
13/32	0.4062	3-7/8	5-1/4	555176
Z	0.4130	4-1/16	5-1/2	555177
27/64	0.4219	4-1/16	5-1/2	555178
7/16	0.4375	4-1/16	5-1/2	555179
29/64	0.4531	4-5/16	5-3/4	555180
15/32	0.4688	4-5/16	5-3/4	555181
31/64	0.4844	4-1/2	6	555182
1/2	0.5000	4-1/2	6	555183

Left Hand Jobber Length Drills

High Speed Steel



- 118° point
- For use in left hand spindle rotation on screw machines and drill heads
- May be used as screw extractor for drilling out broken studs or fasteners
- Sets supplied in metal indexed storage case

Size (Inch)	Decimal Equiv. (Inch)	Flute Length (Inch)	Overall Length (Inch)	Code
1/64	0.0156	3/16	3/4	607600
1/32	0.0312	1/2	1-3/8	607601
3/64	0.0469	3/4	1-3/4	607602
1/16	0.0625	7/8	1-7/8	751201
5/64	0.0781	1	2	751202
3/32	0.0938	1-1/4	2-1/4	751203
7/64	0.1094	1-1/2	2-5/8	751204
1/8	0.1250	1-5/8	2-3/4	751205

Size (Inch)	Decimal Equiv. (Inch)	Flute Length (Inch)	Overall Length (Inch)	Code
9/64	0.1406	1-3/4	2-7/8	751206
5/32	0.1562	2	3-1/8	751207
11/64	0.1719	2-1/8	3-1/4	607610
3/16	0.1875	2-5/16	3-1/2	751208
13/64	0.2031	2-7/16	3-5/8	751209
7/32	0.2188	2-1/2	3-3/4	751210
15/64	0.2344	2-5/8	3-7/8	751211
1/4	0.2500	2-3/4	4	607615
17/64	0.2656	2-7/8	4-1/8	751212
9/32	0.2812	2-15/16	4-1/4	751213
19/64	0.2969	3-1/16	4-3/8	751214
5/16	0.3125	3-3/16	4-1/2	751215

Size (Inch)	Decimal Equiv. (Inch)	Flute Length (Inch)	Overall Length (Inch)	Code
21/64	0.3281	3-5/16	4-5/8	751216
11/32	0.3438	3-7/16	4-3/4	751217
23/64	0.3594	3-1/2	4-7/8	751218
3/8	0.3750	3-5/8	5	751219
25/64	0.3906	3-3/4	5-1/8	751220
13/32	0.4062	3-7/8	5-1/4	751221
27/64	0.4219	3-15/16	5-3/8	751222
7/16	0.4375	4-1/16	5-1/2	751223
29/64	0.4531	4-3/16	5-5/8	751224
15/32	0.4688	4-5/16	5-3/4	751225
31/64	0.4844	4-3/8	5-7/8	751226
1/2	0.5000	4-1/2	6	751227

Screw Machine Length Drills

High Speed Steel & Cobalt

General Purpose
High Speed Steel – Bright Finish



Drill Size	Shank Diameter
Up to 1"	Same as drill diameter
Over 1" to 1-1/4"	1"
Over 1-1/4" to 1-1/2"	1-1/4"
Over 1-1/2" to 2-1/2"	1-1/2"

Heavy Duty
Cobalt



- 135° split point
- Short flute length and overall length provides maximum rigidity drilling in stainless and other tough alloys, castings and forgings
- Sets supplied in metal indexed storage case

- 118° standard point
- Popular drills in the automotive and construction industries
- Short flute and overall length provides maximum rigidity
- Often used in screw machine set-ups where spindle clearance is limited

Fractional Sizes

Size (Inch)	Decimal Equiv. (Inch)	Flute Length (Inch)	Overall Length (Inch)	HSS Bright Finish	Cobalt
				Code	Code
3/64	0.0469	1/2	1-3/8	607900	*752771
1/16	0.0625	5/8	1-5/8	752308	752708
5/64	0.0781	11/16	1-11/16	752314	752714
3/32	0.0938	3/4	1-3/4	752321	752721
7/64	0.1094	13/16	1-13/16	752328	752728
1/8	0.1250	7/8	1-7/8	752334	752734
9/64	0.1406	15/16	1-15/16	752338	752738
5/32	0.1562	1	2-1/16	752344	752744
11/64	0.1719	1-1/16	2-1/8	752350	752750
3/16	0.1875	1-1/8	2-3/16	752356	752756
13/64	0.2031	1-3/16	2-1/4	752363	752763
7/32	0.2188	1-1/4	2-3/8	752368	752768
15/64	0.2344	1-5/16	2-7/16	752372	752771
1/4	0.2500	1-3/8	2-1/2	752376	752772

Size (Inch)	Decimal Equiv. (Inch)	Flute Length (Inch)	Overall Length (Inch)	HSS Bright Finish	Cobalt
				Code	Code
17/64	0.2656	1-7/16	2-5/8	752379	752773
9/32	0.2812	1-1/2	2-11/16	752384	752774
19/64	0.2969	1-9/16	2-3/4	752387	752775
5/16	0.3125	1-5/8	2-13/16	752389	752776
21/64	0.3281	1-11/16	2-15/16	752392	752777
11/32	0.3438	1-11/16	3	752395	752778
23/64	0.3594	1-3/4	3-1/16	752398	752779
3/8	0.3750	1-13/16	3-1/8	752400	752780
25/64	0.3906	1-7/8	3-1/4	752403	752781
13/32	0.4062	1-15/16	3-5/16	752406	752782
27/64	0.4219	2	3-3/8	752408	752783
7/16	0.4375	2-1/16	3-7/16	752409	752784
29/64	0.4531	2-1/8	3-9/16	752410	752785
15/32	0.4688	2-1/8	3-5/8	752411	752786

*Cobalt sizes under 1/16" are not split point

Screw Machine Length Drills

High Speed Steel & Cobalt



Fractional Sizes (continued)

Size (Inch)	Decimal Equiv. (Inch)	Flute Length (Inch)	Overall Length (Inch)	HSS Bright Finish	Cobalt	Size (Inch)	Decimal Equiv. (Inch)	Flute Length (Inch)	Overall Length (Inch)	HSS Bright Finish	Cobalt
				Code	Code					Code	Code
31/64	0.4844	2-3/16	3-11/16	752412	752787	49/64	0.7656	3-1/4	5-1/8	607946	608496
1/2	0.5000	2-1/4	3-3/4	752413	752788	25/32	0.7812	3-1/4	5-1/8	607947	608497
33/64	0.5156	2-3/8	3-7/8	607930	608480	51/64	0.7969	3-3/8	5-1/4	607948	608498
17/32	0.5312	2-3/8	3-7/8	607931	608481	13/16	0.8125	3-3/8	5-1/4	607949	608499
35/64	0.5469	2-1/2	4	607932	608482	53/64	0.8281	3-1/2	5-3/8	607950	608500
9/16	0.5625	2-1/2	4	607933	608483	27/32	0.8438	3-1/2	5-3/8	607951	608501
37/64	0.5781	2-5/8	4-1/8	607934	608484	55/64	0.8594	3-1/2	5-1/2	607952	608502
19/32	0.5938	2-5/8	4-1/8	607935	608485	7/8	0.8750	3-1/2	5-1/2	607953	608503
39/64	0.6094	2-3/4	4-1/4	607936	608486	57/64	0.8906	3-5/8	5-5/8	607954	608504
5/8	0.6250	2-3/4	4-1/4	607937	608487	29/32	0.9062	3-5/8	5-5/8	607955	608505
41/64	0.6406	2-7/8	4-1/2	607938	608488	59/64	0.9219	3-3/4	5-3/4	607956	608506
21/32	0.6562	2-7/8	4-1/2	607939	608489	15/16	0.9375	3-3/4	5-3/4	607957	608507
43/64	0.6719	2-7/8	4-5/8	607940	608490	61/64	0.9531	3-7/8	5-7/8	607958	608508
11/16	0.6875	2-7/8	4-5/8	607941	608491	31/32	0.9688	3-7/8	5-7/8	607959	608509
45/64	0.7031	3	4-3/4	607942	608492	63/64	0.9844	4	6	607960	608510
23/32	0.7188	3	4-3/4	607943	608493	1	1.0000	4	6	607961	608016
47/64	0.7344	3-1/8	5	607944	608494	1-3/8	1.3750	4-1/2	7-1/8	-	608017
3/4	0.7500	3-1/8	5	607945	608495						

NOTE: Sizes over 1/2" furnished with notched point

Letter Sizes

Size	Decimal Equiv. (Inch)	Flute Length (Inch)	Overall Length (Inch)	HSS Bright Finish	Cobalt	Size	Decimal Equiv. (Inch)	Flute Length (Inch)	Overall Length (Inch)	HSS Bright Finish	Cobalt
				Code	Code					Code	Code
A	0.2340	1-5/16	2-7/16	752371	608511	O	0.3160	1-11/16	2-15/16	752390	608524
B	0.2380	1-3/8	2-1/2	752373	608512	P	0.3230	1-11/16	2-15/16	752391	608525
C	0.2420	1-3/8	2-1/2	752374	608513	Q	0.3320	1-11/16	3	752393	608526
D	0.2460	1-3/8	2-1/2	752375	608514	R	0.3390	1-11/16	3	752394	608527
E	0.2500	1-3/8	2-1/2	752376	752772	S	0.3480	1-3/4	3-1/16	752396	608528
F	0.2570	1-7/16	2-5/8	752377	608515	T	0.3580	1-3/4	3-1/16	752397	608529
G	0.2610	1-7/16	2-5/8	752378	608516	U	0.3680	1-13/16	3-1/8	752399	608530
H	0.2660	1-1/2	2-11/16	752380	608517	V	0.3770	1-7/8	3-1/4	752401	608531
I	0.2720	1-1/2	2-11/16	752381	608518	W	0.3860	1-7/8	3-1/4	752402	608532
J	0.2770	1-1/2	2-11/16	752382	608519	X	0.3970	1-15/16	3-5/16	752404	608533
K	0.2810	1-1/2	2-11/16	752383	608520	Y	0.4040	1-15/16	3-5/16	752405	608534
L	0.2900	1-9/16	2-3/4	752385	608521	Z	0.4130	2	3-3/8	752407	608535
M	0.2950	1-9/16	2-3/4	752386	608522						
N	0.3020	1-5/8	2-13/16	752388	608523						

Wire Gage Sizes

Size	Decimal Equiv. (Inch)	Flute Length (Inch)	Overall Length (Inch)	HSS Bright Finish	Cobalt	Size	Decimal Equiv. (Inch)	Flute Length (Inch)	Overall Length (Inch)	HSS Bright Finish	Cobalt
				Code	Code					Code	Code
1	0.2280	1-5/16	2-7/16	752370	752770	5	0.2055	1-1/4	2-3/8	752365	752765
2	0.2210	1-5/16	2-7/16	752369	752769	6	0.2040	1-1/4	2-3/8	752364	752764
3	0.2130	1-1/4	2-3/8	752367	752767	7	0.2010	1-3/16	2-1/4	752362	752762
4	0.2090	1-1/4	2-3/8	752366	752766	8	0.1990	1-3/16	2-1/4	752361	752761

Screw Machine Length Drills

High Speed Steel & Cobalt



Wire Gage Sizes (continued)

Size	Decimal Equiv. (Inch)	Flute Length (Inch)	Overall Length (Inch)	HSS Bright Finish	Cobalt	Size	Decimal Equiv. (Inch)	Flute Length (Inch)	Overall Length (Inch)	HSS Bright Finish	Cobalt
				Code	Code					Code	Code
9	0.1960	1-3/16	2-1/4	752360	752760	35	0.1100	7/8	1-7/8	752329	752729
10	0.1935	1-3/16	2-1/4	752359	752759	36	0.1065	13/16	1-13/16	752327	752727
11	0.1910	1-3/16	2-1/4	752358	752758	37	0.1040	13/16	1-13/16	752326	752726
12	0.1890	1-3/16	2-1/4	752357	752757	38	0.1015	13/16	1-13/16	752325	752725
13	0.1850	1-1/8	2-3/16	752355	752755	39	0.0995	13/16	1-13/16	752324	752724
14	0.1820	1-1/8	2-3/16	752354	752754	40	0.0980	13/16	1-13/16	752323	752723
15	0.1800	1-1/8	2-3/16	752353	752753	41	0.0960	13/16	1-13/16	752322	752722
16	0.1770	1-1/8	2-3/16	752352	752752	42	0.0935	3/4	1-3/4	752320	752720
17	0.1730	1-1/8	2-3/16	752351	752751	43	0.0890	3/4	1-3/4	752319	752719
18	0.1695	1-1/16	2-1/8	752349	752749	44	0.0860	3/4	1-3/4	752318	752718
19	0.1660	1-1/16	2-1/8	752348	752748	45	0.0820	3/4	1-3/4	752317	752717
20	0.1610	1-1/16	2-1/8	752347	752747	46	0.0810	3/4	1-3/4	752316	752716
21	0.1590	1-1/16	2-1/8	752346	752746	47	0.0785	3/4	1-3/4	752315	752715
22	0.1570	1-1/16	2-1/8	752345	752745	48	0.0760	11/16	1-11/16	752313	752713
23	0.1540	1	2-1/16	752343	752743	49	0.0730	11/16	1-11/16	752312	752712
24	0.1520	1	2-1/16	752342	752742	50	0.0700	11/16	1-11/16	752311	752711
25	0.1495	1	2-1/16	752341	752741	51	0.0670	11/16	1-11/16	752310	752710
26	0.1470	1	2-1/16	752340	752740	52	0.0635	11/16	1-11/16	752309	752709
27	0.1440	1	2-1/16	752339	752737	53	0.0595	5/8	1-5/8	752307	*752707
28	0.1405	15/16	1-15/16	752337	752737	54	0.0550	5/8	1-5/8	752306	*752706
29	0.1360	15/16	1-15/16	752336	752736	55	0.0520	5/8	1-5/8	752305	*752705
30	0.1285	15/16	1-15/16	752335	752735	56	0.0465	1/2	1-3/8	752304	*752704
31	0.1200	7/8	1-7/8	752333	752733	57	0.0430	1/2	1-3/8	752303	*752703
32	0.1160	7/8	1-7/8	752332	752732	58	0.0420	1/2	1-3/8	752302	*752702
33	0.1130	7/8	1-7/8	752331	752731	59	0.0410	1/2	1-3/8	752301	*752701
34	0.1110	7/8	1-7/8	752330	752730	60	0.0400	1/2	1-3/8	752300	*752700

*Cobalt sizes 53 to 60 are *not* split point

Metric Screw Machine Length Drills

Heavy Duty – Cobalt



• 135° split point

Size (mm)	Decimal Equiv. (Inch)	Flute Length (Inch)	Overall Length (Inch)	Code	Size (mm)	Decimal Equiv. (Inch)	Flute Length (Inch)	Overall Length (Inch)	Code	Size (mm)	Decimal Equiv. (Inch)	Flute Length (Inch)	Overall Length (Inch)	Code
1.00	0.0394	1/2	1-3/8	*608596	4.20	0.1654	7/8	2-5/32	608610	7.90	0.3110	1-15/32	3-1/8	608624
1.40	0.0551	1/2	1-3/8	*608597	4.30	0.1693	15/16	2-9/32	608611	8.00	0.3150	1-15/32	3-1/8	608625
1.50	0.0591	1/2	1-3/8	*608598	4.40	0.1732	15/16	2-9/32	608612	8.20	0.3228	1-15/32	3-1/8	608626
1.70	0.0669	7/16	1-3/8	608599	4.50	0.1772	15/16	2-9/32	608613	8.40	0.3307	1-15/32	3-1/8	608627
1.75	0.0689	7/16	1-7/16	608600	5.00	0.1969	1-1/32	2-7/16	608614	8.50	0.3346	1-15/32	3-1/8	608628
2.00	0.0787	15/32	1-1/2	608601	5.40	0.2126	1-3/32	2-19/32	608615	9.00	0.3543	1-9/16	3-5/16	608629
2.05	0.0807	15/32	1-1/2	608602	5.80	0.2283	1-3/32	2-19/32	608616	9.10	0.3583	1-9/16	3-5/16	608630
2.50	0.0984	1/2	1-9/16	608603	6.00	0.2362	1-3/32	2-19/32	608617	9.90	0.3898	1-11/16	3-1/2	608631
2.70	0.1063	5/8	1-13/16	608604	6.50	0.2559	1-7/32	2-3/4	608618	10.00	0.3937	1-11/16	3-1/2	608632
2.80	0.1102	5/8	1-13/16	608605	7.00	0.2756	1-11/32	2-29/32	608619	10.50	0.4134	1-11/16	3-1/2	608633
3.00	0.1181	5/8	1-13/16	608606	7.10	0.2795	1-11/32	2-29/32	608620	11.50	0.4528	1-7/8	3-3/4	608634
3.20	0.1260	23/32	1-13/16	608607	7.40	0.2913	1-11/32	2-29/32	608621	11.80	0.4646	1-7/8	3-3/4	608635
3.50	0.1378	25/32	2-1/16	608608	7.50	0.2953	1-11/32	2-29/32	608622	12.20	0.4803	2-1/64	4-1/64	608636
4.00	0.1575	7/8	2-5/32	608609	7.60	0.2992	1-15/32	3-1/8	608623	12.50	0.4921	2-1/64	4-1/64	608637

*Cobalt sizes 1.00mm to 1.50mm are *not* split point

Screw Machine Length Drills

Inch, Metric, Wire Gage & Letter Sizes – Solid Carbide – 135° Split Point



- For use on work hardening and gummy materials, titanium, inconel, cast iron, and stainless steel

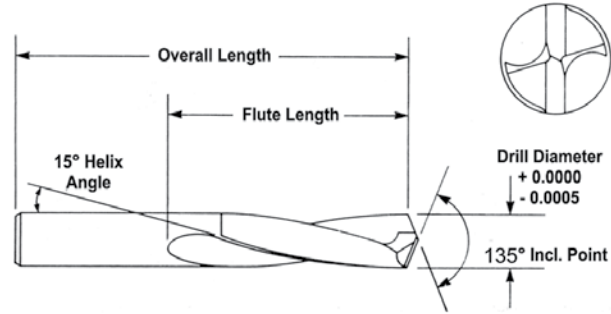

Size	Decimal Equivalent (Inch)	Flute Length	Overall Length	Code
60	0.0400	3/8	1-1/2	952630
59	0.0410	3/8	1-1/2	952628
58	0.0420	3/8	1-1/2	952626
57	0.0430	3/8	1-1/2	952624
56	0.0465	3/8	1-1/2	952622
55	0.0520	3/8	1-1/2	952620
54	0.0550	3/8	1-1/2	952618
1.5 mm	0.0591	9.5 mm	38.1 mm	952702
53	0.0595	3/8	1-1/2	952616
1/16	0.0625	3/8	1-1/2	952386
52	0.0635	3/8	1-1/2	952614
51	0.0670	3/8	1-1/2	952612
50	0.0700	3/8	1-1/2	952610
49	0.0730	3/8	1-1/2	952608
48	0.0760	1/2	1-1/2	952606
5/64	0.0781	1/2	1-1/2	952388
47	0.0785	1/2	1-1/2	952604
2 mm	0.0787	12.7 mm	38.1 mm	952704
46	0.0810	1/2	1-1/2	952602
45	0.0820	1/2	1-1/2	952600
44	0.0860	1/2	2	952598
43	0.0890	1/2	2	952596
42	0.0935	1/2	2	952594
3/32	0.0938	1/2	2	952390
41	0.0960	1/2	2	952592
40	0.0980	5/8	2	952590
2.5 mm	0.0984	15.9 mm	50.8 mm	952706
39	0.0995	5/8	2	952588
38	0.1015	5/8	2	952586
37	0.1040	5/8	2	952584
36	0.1065	5/8	2	952582
7/64	0.1094	5/8	2	952392
35	0.1100	5/8	2	952580
34	0.1110	5/8	2	952578
33	0.1130	5/8	2	952576
32	0.1160	5/8	2	952574
3 mm	0.1181	15.9 mm	50.8 mm	952708
31	0.1200	5/8	2	952572
1/8	0.1250	5/8	2	952394
30	0.1285	5/8	2	952570
29	0.1360	5/8	2	952568
3.5 mm	0.1378	15.9 mm	50.8 mm	952710
28	0.1405	5/8	2	952566
9/64	0.1406	5/8	2	952396

Size	Decimal Equivalent (Inch)	Flute Length	Overall Length	Code
27	0.1440	5/8	2	952564
26	0.1470	5/8	2	952562
25	0.1495	5/8	2	952560
24	0.1520	5/8	2	952558
23	0.1540	5/8	2	952556
5/32	0.1563	3/4	2	952398
22	0.1570	3/4	2	952554
4 mm	0.1575	19.1 mm	50.8 mm	952712
21	0.1590	3/4	2	952552
20	0.1610	3/4	2	952550
19	0.1660	3/4	2-1/8	952548
18	0.1695	3/4	2-1/8	952546
11/64	0.1719	3/4	2-1/8	952400
17	0.1730	3/4	2-1/8	952544
16	0.1770	3/4	2-1/8	952542
4.5 mm	0.1772	19.1 mm	54 mm	952714
15	0.1800	3/4	2-3/16	952540
14	0.1820	3/4	2-3/16	952538
13	0.1850	3/4	2-3/16	952536
3/16	0.1875	3/4	2-3/16	952402
12	0.1890	3/4	2-3/16	952534
11	0.1910	3/4	2-3/16	952532
10	0.1935	3/4	2-3/16	952530
9	0.1960	3/4	2-1/4	952528
5 mm	0.1969	19.1 mm	57.2 mm	952716
8	0.1990	3/4	2-1/4	952526
7	0.2010	3/4	2-1/4	952524
13/64	0.2031	3/4	2-1/4	952404
6	0.2040	3/4	2-1/4	952522
5	0.2055	3/4	2-1/4	952520
4	0.2090	3/4	2-1/4	952518
3	0.2130	1	2-1/2	952516
5.5 mm	0.2165	25.4 mm	63.5 mm	952718
7/32	0.2188	1	2-1/2	952406
2	0.2210	1	2-1/2	952514
1	0.2280	1	2-1/2	952512
A	0.2340	1	2-1/2	952452
15/64	0.2344	1	2-1/2	952408
6 mm	0.2362	5.4 mm	63.5 mm	952720
B	0.2380	1	2-1/2	952454
C	0.2420	1	2-1/2	952456
D	0.2460	1	2-1/2	952458
1/4 (E)	0.2500	1	2-1/2	952410
E	0.2500	1	2-1/2	952460

Screw Machine Length Drills

Inch, Metric, Wire Gage & Letter Sizes – Solid Carbide – 135° Split Point (continued)

Size	Decimal Equivalent (Inch)	Flute Length	Overall Length	Code
6.5 mm	0.2559	25.4 mm	63.5 mm	952722
F	0.2570	1	2-1/2	952462
G	0.2610	1	2-1/2	952464
17/64	0.2656	1	2-1/2	952412
H	0.2660	1	2-1/2	952466
I	0.2720	1	2-1/2	952468
J	0.2770	1	2-1/2	952470
K	0.2810	1	2-1/2	952472
9/32	0.2813	1	2-1/2	952414
L	0.2900	1	2-1/2	952474
M	0.2950	1-1/4	2-1/2	952476
7.5 mm	0.2953	31.8 mm	63.5 mm	952726
19/64	0.2969	1-1/4	2-1/2	952416
N	0.3020	1-1/4	2-1/2	952478
5/16	0.3125	1-1/4	2-1/2	952418
8 mm	0.3150	31.8 mm	63.5 mm	952728
O	0.3160	1-1/4	2-1/2	952480
P	0.3230	1-1/4	2-1/2	952482
21/64	0.3281	1-1/4	2-1/2	952420
Q	0.3320	1-1/4	2-1/2	952484
8.5 mm	0.3346	31.8 mm	63.5 mm	952730
R	0.3390	1-1/4	2-1/2	952486
11/32	0.3438	1-1/4	2-1/2	952422
S	0.3480	1-1/4	2-1/2	952488

Size	Decimal Equivalent (Inch)	Flute Length	Overall Length	Code
9 mm	0.3543	31.8 mm	63.5 mm	952732
T	0.3580	1-1/4	2-1/2	952490
23/64	0.3594	1-1/4	2-1/2	952424
U	0.3680	1-1/4	2-1/2	952492
9.5 mm	0.3740	31.8 mm	63.5 mm	952734
3/8	0.3750	1-1/4	2-1/2	952426
V	0.3770	1-1/4	2-1/2	952494
W	0.3860	1-1/4	2-3/4	952496
25/64	0.3906	1-1/4	2-3/4	952428
10 mm	0.3937	31.8 mm	69.9 mm	952736
X	0.3970	1-1/4	2-3/4	952498
Y	0.4040	1-1/4	2-3/4	952500
13/32	0.4063	1-1/4	2-3/4	952430
Z	0.4130	1-1/4	2-3/4	952502
10.5 mm	0.4134	31.8 mm	69.9 mm	952738
27/64	0.4219	1-1/4	2-3/4	952432
11 mm	0.4331	31.8 mm	69.9 mm	952740
7/16	0.4375	1-1/4	2-3/4	952434
11.5 mm	0.4528	31.8 mm	76.2 mm	952742
29/64	0.4531	1-1/4	3	952436
15/32	0.4688	1-1/4	3	952438
31/64	0.4844	1-1/4	3	952440
1/2	0.5000	1-1/4	3	952442

Taper Length Drills

High Speed Steel & Cobalt

General Purpose
High Speed Steel – Black Oxide



- 118° point for general purpose applications
- Used where a longer overall length and flute length are required
- Used in production drilling, they have the same flute length as taper shank drills
- Sets supplied in metal indexed storage case

Heavy Duty
Super Cobalt – Bronze Finish



- 135° split point, super cobalt, heavy duty for stainless steel and other tough alloy steels, castings, and forgings
- Used where a longer overall length and flute length are required
- Used in production drilling, they have the same flute length as taper shank drills
- Sets supplied in metal indexed storage case

Fractional Sizes

Size (Inch)	Decimal Equiv. (Inch)	Flute Length (Inch)	Overall Length (Inch)	HSS Black Oxide	Super Cobalt
				Code	Code
1/64	0.0156	5/16	1-1/2	609100	609500
1/32	0.0312	3/4	2	609101	609501
3/64	0.0469	1-1/8	2-1/4	752805	609502
1/16	0.0625	1-3/4	3	752809	609503
5/64	0.0781	2	3-3/4	752815	609504
3/32	0.0938	2-1/4	4-1/4	752822	609505
7/64	0.1094	2-1/2	4-5/8	752829	609506
1/8	0.1250	2-3/4	5-1/8	752835	609507
9/64	0.1406	3	5-3/8	752839	609508
5/32	0.1562	3	5-3/8	752845	609509
11/64	0.1719	3-3/8	5-3/4	752851	609510
3/16	0.1875	3-3/8	5-3/4	752857	609511
13/64	0.2031	3-5/8	6	752864	609512
7/32	0.2188	3-5/8	6	752869	609513

Size (Inch)	Decimal Equiv. (Inch)	Flute Length (Inch)	Overall Length (Inch)	HSS Black Oxide	Super Cobalt
				Code	Code
15/64	0.2344	3-3/4	6-1/8	752873	609514
1/4	0.2500	3-3/4	6-1/8	752877	609515
17/64	0.2656	3-7/8	6-1/4	752880	609516
9/32	0.2812	3-7/8	6-1/4	752885	609517
19/64	0.2969	4	6-3/8	752888	609518
5/16	0.3125	4	6-3/8	752890	609519
21/64	0.3281	4-1/8	6-1/2	752893	609520
11/32	0.3438	4-1/8	6-1/2	752896	609521
23/64	0.3594	4-1/4	6-3/4	752899	609522
3/8	0.3750	4-1/4	6-3/4	752901	609523
25/64	0.3906	4-3/8	7	752904	609524
13/32	0.4062	4-3/8	7	752907	609525
27/64	0.4219	4-5/8	7-1/4	752909	609526
7/16	0.4375	4-5/8	7-1/4	752910	609527

Taper Length Drills

High Speed Steel & Cobalt



Fractional Sizes (continued)

Size (Inch)	Decimal Equiv. (Inch)	Flute Length (Inch)	Overall Length (Inch)	HSS Black Oxide	Super Cobalt	Size (Inch)	Decimal Equiv. (Inch)	Flute Length (Inch)	Overall Length (Inch)	HSS Black Oxide	Super Cobalt
				Code	Code					Code	Code
29/64	0.4531	4-3/4	7-1/2	752911	609528	63/64	0.9844	6-3/8	11	752945	609562
15/32	0.4688	4-3/4	7-1/2	752912	609529	1	1.0000	6-3/8	11	752946	609563
31/64	0.4844	4-3/4	7-3/4	752913	609530	1-1/64	1.0156	6-1/2	11-1/8	752947	-
1/2	0.5000	4-3/4	7-3/4	752914	609531	1-1/32	1.0312	6-1/2	11-1/8	752948	-
33/64	0.5156	4-3/4	8	752915	609532	1-3/64	1.0469	6-5/8	11-1/4	752949	-
17/32	0.5312	4-3/4	8	752916	609533	1-1/16	1.0625	6-5/8	11-1/4	752950	-
35/64	0.5469	4-7/8	8-1/4	752917	609534	1-5/64	1.0781	6-7/8	11-1/2	752951	-
9/16	0.5625	4-7/8	8-1/4	752918	609535	1-3/32	1.0938	6-7/8	11-1/2	752952	-
37/64	0.5781	4-7/8	8-3/4	752919	609536	1-7/64	1.1094	7-1/8	11-3/4	752953	-
19/32	0.5938	4-7/8	8-3/4	752920	609537	1-1/8	1.1250	7-1/8	11-3/4	752954	-
39/64	0.6094	4-7/8	8-3/4	752921	609538	1-9/64	1.1406	7-1/4	11-7/8	752955	-
5/8	0.6250	4-7/8	8-3/4	752922	609539	1-5/32	1.1562	7-1/4	11-7/8	752956	-
41/64	0.6406	5-1/8	9	752923	609540	1-11/64	1.1719	7-3/8	12	752957	-
21/32	0.6562	5-1/8	9	752924	609541	1-3/16	1.1875	7-3/8	12	752958	-
43/64	0.6719	5-3/8	9-1/4	752924	609542	1-13/64	1.2031	7-1/2	12-1/8	752959	-
11/16	0.6875	5-3/8	9-1/4	752926	609543	1-7/32	1.2188	7-1/2	12-1/8	752960	-
45/64	0.7031	5-5/8	9-1/2	752927	609544	1-15/64	1.2344	7-7/8	12-1/2	752961	-
23/32	0.7188	5-5/8	9-1/2	752928	609545	1-1/4	1.2500	7-7/8	12-1/2	752962	-
47/64	0.7344	5-7/8	9-3/4	752929	609546	1-9/32	1.2812	8-1/2	14-1/8	752963	-
3/4	0.7500	5-7/8	9-3/4	752930	609547	1-5/16	1.3125	8-5/8	14-1/4	752964	-
49/64	0.7656	6	9-7/8	752931	609548	1-11/32	1.3438	8-3/4	14-3/8	752965	-
25/32	0.7812	6	9-7/8	752932	609549	1-3/8	1.3750	8-7/8	14-1/2	752966	-
51/64	0.7969	6-1/8	10	752933	609550	1-13/32	1.4062	9	14-5/8	752967	-
13/16	0.8125	6-1/8	10	752934	609551	1-7/16	1.4375	9-1/8	14-3/4	752968	-
53/64	0.8281	6-1/8	10	752935	609552	1-15/32	1.4688	9-1/4	14-7/8	752969	-
27/32	0.8438	6-1/8	10	752936	609553	1-1/2	1.5000	9-3/8	15	752970	-
55/64	0.8594	6-1/8	10	752937	609554	1-9/16	1.5625	9-5/8	15-1/4	752971	-
7/8	0.8750	6-1/8	10	752938	609555	1-5/8	1.6250	9-7/8	15-5/8	752972	-
57/64	0.8906	6-1/8	10	752939	609556	1-11/16	1.6875	10-1/8	16	609190	-
29/32	0.9062	6-1/8	10	752940	609557	1-3/4	1.7500	10-1/2	16-1/4	752973	-
59/64	0.9219	6-1/8	10-3/4	752941	609558	1-13/16	1.8125	10-1/2	16-1/4	609192	-
15/16	0.9375	6-1/8	10-3/4	752942	609559	1-7/8	1.8700	10-5/8	16-1/4	609193	-
61/64	0.9531	6-3/8	11	752943	609560	1-15/16	1.9375	10-3/4	16-5/8	609194	-
31/32	0.9688	6-3/8	11	752944	609561	2	2.0000	10-3/4	17-1/4	609195	-

NOTE: Sizes over 1/2" furnished with notched point

Wire Gage Sizes

Size	Decimal Equiv. (Inch)	Flute Length (Inch)	Overall Length (Inch)	High Speed Steel Bright Finish	Size	Decimal Equiv. (Inch)	Flute Length (Inch)	Overall Length (Inch)	High Speed Steel Bright Finish
				Code					Code
1	0.2280	3-3/4	6-1/8	752871	13	0.1850	3-3/8	5-3/4	752858
2	0.2210	3-3/4	6-1/8	752870	14	0.1820	3-3/8	5-3/4	752855
3	0.2130	3-5/8	6	752868	15	0.1800	3-3/8	5-3/4	752854
4	0.2090	3-5/8	6	752867	16	0.1770	3-3/8	5-3/4	752853
5	0.2055	3-5/8	6	752866	17	0.1730	3-3/8	5-3/4	752852
6	0.2040	3-5/8	6	752865	18	0.1695	3-3/8	5-3/4	752850
7	0.2010	3-5/8	6	752863	19	0.1660	3-3/8	5-3/4	752849
8	0.1990	3-5/8	6	752862	20	0.1610	3-3/8	5-3/4	752848
9	0.1960	3-5/8	6	752861	21	0.1590	3-3/8	5-3/4	752847
10	0.1935	3-5/8	6	752860	22	0.1570	3-3/8	5-3/4	752846
11	0.1910	3-5/8	6	752859	23	0.1540	3	5-3/8	752844
12	0.1890	3-5/8	6	752858	24	0.1520	2	5-3/8	752843

Taper Length Drills

High Speed Steel & Cobalt



Wire Gage Sizes (continued)

Size	Decimal Equiv. (Inch)	Flute Length (Inch)	Overall Length (Inch)	High Speed Steel Bright Finish	Size	Decimal Equiv. (Inch)	Flute Length (Inch)	Overall Length (Inch)	High Speed Steel Bright Finish
				Code					Code
25	0.1495	2	5-3/8	752842	53	0.0595	1-3/4	3	752808
26	0.1470	2	5-3/8	752841	54	0.0550	1-3/4	3	752807
27	0.1440	2	5-3/8	752840	55	0.0520	1-3/4	3	752806
28	0.1405	2	5-3/8	752838	56	0.0465	1-1/8	2-1/4	752804
29	0.1360	2	5-3/8	752837	57	0.0430	1-1/8	2-1/4	752803
30	0.1285	2	5-3/8	752836	58	0.0420	1-1/8	2-1/4	752802
31	0.1200	2-3/4	5-1/8	752834	59	0.0410	1-1/8	2-1/4	752801
32	0.1160	2-3/4	5-1/8	752833	60	0.0400	1-1/8	2-1/4	752800
33	0.1130	2-3/4	5-1/8	752832	61	0.0390	1-1/8	2-1/4	609256
34	0.1110	2-3/4	5-1/8	752831	62	0.0380	3/4	2	609257
35	0.1100	2-3/4	5-1/8	752830	63	0.0370	3/4	2	609258
36	0.1065	2-1/2	4-5/8	752828	64	0.0360	3/4	2	609259
37	0.1040	2-1/2	4-5/8	752827	65	0.0350	3/4	2	609260
38	0.1015	2-1/2	4-5/8	752826	66	0.0330	3/4	2	609261
39	0.0995	2-1/2	4-5/8	752825	67	0.0320	3/4	2	609262
40	0.0980	2-1/2	4-5/8	752824	68	0.0310	3/4	2	609263
41	0.0960	2-1/2	4-5/8	752823	69	0.0292	3/4	2	609264
42	0.0935	2-1/4	4-1/4	752821	70	0.0280	3/4	2	609265
43	0.0890	2-1/4	4-1/4	752820	71	0.0260	3/4	2	609266
44	0.0860	2-1/4	4-1/4	752819	72	0.0250	5/16	1-1/2	609267
45	0.0820	2-1/4	4-1/4	752818	73	0.0240	5/16	1-1/2	609268
46	0.0810	2-1/4	4-1/4	752817	74	0.0225	5/16	1-1/2	609269
47	0.0785	2-1/4	4-1/4	752816	75	0.0210	5/16	1-1/2	609270
48	0.0760	2	3-3/4	752814	76	0.0200	5/16	1-1/2	609271
49	0.0730	2	3-3/4	752813	77	0.0180	5/16	1-1/2	609272
50	0.0700	2	3-3/4	752812	78	0.0160	5/16	1-1/2	609273
51	0.0670	2	3-3/4	752811	79	0.0145	5/16	1-1/2	609274
52	0.0635	2	3-3/4	752810	80	0.0135	5/16	1-1/2	609275

Metric Taper Length Drills

General Purpose – High Speed Steel



- 118° point
- Longer flute and overall length than jobber length drills

Size (mm)	Decimal Equiv. (Inch)	Flute Length (Inch)	Overall Length (Inch)	Code	Size (mm)	Decimal Equiv. (Inch)	Flute Length (Inch)	Overall Length (Inch)	Code	Size (mm)	Decimal Equiv. (Inch)	Flute Length (Inch)	Overall Length (Inch)	Code
1.00	0.0394	1-1/8	2-1/4	609301	1.60	0.0630	2	3-3/4	609313	2.20	0.0866	2-1/4	4-1/4	609325
1.05	0.0413	1-1/8	2-1/4	609302	1.65	0.0650	2	3-3/4	609314	2.25	0.0886	2-1/4	4-1/4	609326
1.10	0.0433	1-1/8	2-1/4	609303	1.70	0.0669	2	3-3/4	609315	2.30	0.0906	2-1/4	4-1/4	609327
1.15	0.0453	1-1/8	2-1/4	609304	1.75	0.0689	2	3-3/4	609316	2.35	0.0925	2-1/4	4-1/4	609328
1.20	0.0472	1-3/4	3	609305	1.80	0.0709	2	3-3/4	609317	2.40	0.0945	2-1/2	4-5/8	609329
1.25	0.0492	1-3/4	3	609306	1.85	0.0728	2	3-3/4	609318	2.45	0.0965	2-1/2	4-5/8	609330
1.30	0.0512	1-3/4	3	609307	1.90	0.0748	2	3-3/4	609319	2.50	0.0984	2-1/2	4-5/8	609331
1.35	0.0531	1-3/4	3	609308	1.95	0.0768	2	3-3/4	609320	2.60	0.1024	2-1/2	4-5/8	609332
1.40	0.0551	1-3/4	3	609309	2.00	0.0787	2-1/4	4-1/4	609321	2.70	0.1063	2-1/2	4-5/8	609333
1.45	0.0571	1-3/4	3	609310	2.05	0.0807	2-1/4	4-1/4	609322	2.80	0.1102	2-3/4	5-1/8	609334
1.50	0.0591	1-3/4	3	609311	2.10	0.0827	2-1/4	4-1/4	609323	2.90	0.1142	2-3/4	5-1/8	609335
1.55	0.0610	1-3/4	3	609312	2.15	0.0846	2-1/4	4-1/4	609324	3.00	0.1181	2-3/4	5-1/8	609336

Metric Taper Length Drills

General Purpose – High Speed Steel (continued)



Size (mm)	Decimal Equiv. (Inch)	Flute Length (Inch)	Overall Length (Inch)	Code	Size (mm)	Decimal Equiv. (Inch)	Flute Length (Inch)	Overall Length (Inch)	Code	Size (mm)	Decimal Equiv. (Inch)	Flute Length (Inch)	Overall Length (Inch)	Code
3.10	0.1220	2-3/4	5-1/8	609337	8.20	0.3228	4-1/8	6-1/2	609378	18.50	0.7283	5-7/8	9-3/4	609418
3.20	0.1260	3	5-3/8	609338	8.50	0.3346	4-1/8	6-1/2	609379	19.00	0.7480	5-7/8	9-3/4	609419
3.30	0.1299	3	5-3/8	609339	8.80	0.3465	4-1/4	6-3/4	609380	19.50	0.7677	6	9-7/8	609420
3.40	0.1339	3	5-3/8	609340	9.00	0.3543	4-1/4	6-3/4	609381	20.00	0.7874	6-1/8	10	609421
3.50	0.1378	3	5-3/8	609341	9.20	0.3622	4-1/4	6-3/4	609382	20.50	0.8071	6-1/8	10	609422
3.60	0.1417	3	5-3/8	609342	9.50	0.3740	4-1/4	6-3/4	609383	21.00	0.8268	6-1/8	10	609423
3.70	0.1457	3	5-3/8	609343	9.80	0.3858	4-3/8	7	609384	21.50	0.8465	6-1/8	10	609424
3.80	0.1496	3	5-3/8	609344	10.00	0.3937	4-3/8	7	609385	22.00	0.8661	6-1/8	10	609425
3.90	0.1535	3	5-3/8	609345	10.20	0.4016	4-3/8	7	609386	22.50	0.8858	6-1/8	10	609426
4.00	0.1575	3-3/8	5-3/4	609346	10.50	0.4134	4-5/8	7-1/4	609387	23.00	0.9055	6-1/8	10	609427
4.10	0.1614	3-3/8	5-3/4	609347	10.80	0.4252	4-5/8	7-1/4	609388	23.50	0.9252	6-1/8	10-3/4	609428
4.20	0.1654	3-3/8	5-3/4	609348	11.00	0.4331	4-5/8	7-1/4	609389	24.00	0.9449	6-3/8	11	609429
4.30	0.1693	3-3/8	5-3/4	609349	11.20	0.4409	4-3/4	7-1/2	609390	24.50	0.9646	6-3/8	11	609430
4.40	0.1732	3-3/8	5-3/4	609350	11.50	0.4528	4-3/4	7-1/2	609391	25.00	0.9843	6-3/8	11	609431
4.50	0.1772	3-3/8	5-3/4	609351	11.80	0.4646	4-3/4	7-1/2	609392	25.50	1.0039	6-1/2	11-1/8	609457
4.60	0.1811	3-3/8	5-3/4	609352	12.00	0.4724	4-3/4	7-3/4	609393	26.00	1.0236	6-1/2	11-1/8	609432
4.70	0.1850	3-3/8	5-3/4	609353	12.20	0.4803	4-3/4	7-3/4	609394	26.50	1.0433	6-5/8	11-1/4	609433
4.80	0.1890	3-5/8	6	609354	12.50	0.4921	4-3/4	7-3/4	609395	27.00	1.0630	6-5/8	11-1/4	609434
4.90	0.1929	3-5/8	6	609355	12.80	0.5039	4-3/4	8	609396	27.50	1.0827	6-7/8	11-1/2	609435
5.00	0.1968	3-5/8	6	609356	13.00	0.5118	4-3/4	8	609397	28.00	1.1024	7-1/8	11-3/4	609436
5.10	0.2008	3-5/8	6	609357	13.20	0.5197	4-3/4	8	609398	28.50	1.1220	7-1/8	11-3/4	609437
5.20	0.2047	3-5/8	6	609358	13.50	0.5315	4-3/4	8	609399	29.00	1.1417	7-1/4	11-7/8	609438
5.30	0.2087	3-5/8	6	609359	13.80	0.5433	4-7/8	8-1/4	609400	29.50	1.1614	7-3/8	12	609439
5.40	0.2126	3-5/8	6	609360	14.00	0.5512	4-7/8	8-1/4	609401	30.00	1.1811	7-3/8	12	609440
5.50	0.2165	3-5/8	6	609361	14.25	0.5610	4-7/8	8-1/4	609402	30.50	1.2008	7-1/2	12-1/8	609441
5.70	0.2244	3-3/4	6-1/8	609363	14.50	0.5709	4-7/8	8-3/4	609403	31.00	1.2205	7-7/8	12-1/2	609442
5.80	0.2283	3-3/4	6-1/8	609364	14.75	0.5807	4-7/8	8-3/4	609404	31.50	1.2402	7-7/8	12-1/2	609443
5.90	0.2323	3-3/4	6-1/8	609365	15.00	0.5906	4-7/8	8-3/4	609405	32.00	1.2598	8-1/2	14-1/8	609444
6.00	0.2362	3-3/4	6-1/8	609366	15.25	0.6004	4-7/8	8-3/4	609406	32.50	1.2795	8-1/2	14-1/8	609445
6.10	0.2402	3-3/4	6-1/8	609367	15.50	0.6102	4-7/8	8-3/4	609407	33.00	1.2992	8-5/8	14-1/4	609446
6.20	0.2441	3-3/4	6-1/8	609368	15.75	0.6201	4-7/8	8-3/4	609408	33.50	1.3189	8-3/4	14-3/8	609447
6.30	0.2480	3-3/4	6-1/8	609369	16.00	0.6299	5-1/8	9	609409	34.00	1.3386	8-3/4	14-3/8	609448
6.40	0.2520	3-7/8	6-1/4	609370	16.25	0.6398	5-1/8	9	609410	34.50	1.3583	8-7/8	14-1/2	609449
6.50	0.2559	3-7/8	6-1/4	609371	16.50	0.6496	5-1/8	9	609411	35.00	1.3780	9	14-5/8	609450
6.80	0.2677	3-7/8	6-1/4	609372	16.75	0.6594	5-3/8	9-1/4	609412	35.50	1.3976	9	14-5/8	609451
7.00	0.2756	3-7/8	6-1/4	609373	17.00	0.6693	5-3/8	9-1/4	609413	36.00	1.4173	9-1/8	14-3/4	609452
7.20	0.2835	4	6-3/8	609374	17.25	0.6791	5-3/8	9-1/4	609414	36.50	1.4370	9-1/8	14-3/4	609453
7.50	0.2953	4	6-3/8	609375	17.50	0.6890	5-5/8	9-1/2	609415	37.00	1.4567	9-1/4	14-7/8	609454
7.80	0.3071	4	6-3/8	609376	17.75	0.6988	5-5/8	9-1/2	609416	37.50	1.4764	9-3/8	15	609455
8.00	0.3150	4-1/8	6-1/2	609377	18.00	0.7087	5-5/8	9-1/2	609417	38.00	1.4961	9-3/8	15	609456

Taper Length Drills

Carbide Tipped



- The extra length of these drills increases their reach through drill bushings

Decimal Size (Inch)	Drill Size (Inch)	Flute Length (Inch)	Overall Length (Inch)	Code	Decimal Size (Inch)	Drill Size (Inch)	Flute Length (Inch)	Overall Length (Inch)	Code
0.1250	1/8	2-3/4	5-1/8	555201	0.4375	7/16	4-5/8	7-1/4	555211
0.1406	9/64	3	5-3/8	555226	0.4688	15/32	4-3/4	7-1/2	555212
0.1562	5/32	3	5-3/8	555202	0.5000	1/2	4-3/4	7-3/4	555213
0.1719	11/64	3-3/8	5-3/4	555227	0.5156	33/64	4-3/4	8	555238
0.1875	3/16	3-3/8	5-3/4	555203	0.5312	17/32	4-3/4	8	555214
0.2031	13/64	3-5/8	6	555228	0.5469	35/64	4-7/8	8-1/4	555239
0.2188	7/32	3-5/8	6	555204	0.5625	9/16	4-7/8	8-1/4	555215
0.2344	15/64	3-3/4	6-1/8	555229	0.5781	37/64	4-7/8	8-3/4	555240
0.2500	1/4	3-3/4	6-1/8	555205	0.5938	19/32	4-7/8	8-3/4	555216
0.2656	17/64	3-7/8	6-1/4	555230	0.6094	39/64	4-7/8	8-3/4	555241
0.2812	9/32	3-7/8	6-1/4	555206	0.6250	5/8	4-7/8	8-3/4	555217
0.2969	19/64	4	6-3/8	555231	0.6406	41/64	5-1/8	9	555242
0.3125	5/16	4	6-3/8	555207	0.6562	21/32	5-1/8	9	555218
0.3281	21/64	4-1/8	6-1/2	555232	0.6719	43/64	5-3/8	9-1/4	555243
0.3438	11/32	4-1/8	6-1/2	555208	0.6875	11/16	5-3/8	9-1/4	555219
0.3750	3/8	4-1/4	6-3/4	555209	0.7031	45/64	5-5/8	9-1/2	555244
0.4062	13/32	4-3/8	7	555210	0.7188	23/32	5-5/8	9-1/2	555220
0.4219	27/64	4-5/8	7-1/4	555235	0.7344	47/64	5-7/8	9-3/4	555245
					0.7500	3/4	5-7/8	9-3/4	555221

Taper Shank Drills

High Speed Steel & Super Cobalt – Standard Shank



- High speed steel
- 118° point for general purpose applications
- Super cobalt
- 135° split point for heavy duty applications
- Premium cobalt drills exhibit greater toughness, abrasion resistance and higher hardness than the standard high speed drills
- Recommended for use on hard to machine materials where longer tool life is desired

Size (Inch)	Decimal Equiv. (Inch)	High Speed Steel				Super Cobalt			
		Flute Length (Inch)	Overall Length (Inch)	Morse Taper	Code	Flute Length (Inch)	Overall Length (Inch)	Morse Taper	Code
1/16	0.0625	1-1/4	4-5/8	1	612650	-	-	-	-
5/64	0.0781	1-3/8	4-3/4	1	612651	-	-	-	-
1/8	0.1250	1-7/8	5-1/8	1	751450	-	-	-	-
9/64	0.1406	2-1/8	5-3/8	1	751451	-	-	-	-
5/32	0.1562	2-1/8	5-3/8	1	751452	-	-	-	-
11/64	0.1719	2-1/2	5-3/4	1	751453	-	-	-	-
3/16	0.1875	2-1/2	5-3/4	1	751454	-	-	-	-
13/64	0.2031	2-3/4	6	1	612652	-	-	-	-
7/32	0.2188	2-3/4	6	1	751455	-	-	-	-
15/64	0.2344	2-7/8	6-1/8	1	751456	-	-	-	-
1/4	0.2500	2-7/8	6-1/8	1	751457	2-7/8	6-1/8	1	613900
17/64	0.2656	3	6-1/4	1	751458	3	6-1/4	1	613901
9/32	0.2812	3	6-1/4	1	751459	3	6-1/4	1	613902
19/64	0.2969	3-1/8	6-3/8	1	751460	3-1/8	6-3/8	1	613903
5/16	0.3125	3-1/8	6-3/8	1	751461	3-1/8	6-3/8	1	613904
21/64	0.3281	3-1/4	6-1/2	1	751462	3-1/4	6-1/2	1	613905
11/32	0.3438	3-1/4	6-1/2	1	751463	3-1/4	6-1/2	1	613906
23/64	0.3594	3-1/2	6-3/4	1	751464	3-1/2	6-3/4	1	613907

Taper Shank Drills

High Speed Steel & Super Cobalt – Standard Shank (continued)



Size (Inch)	Decimal Equiv. (Inch)	High Speed Steel				Super Cobalt			
		Flute Length (Inch)	Overall Length (Inch)	Morse Taper	Code	Flute Length (Inch)	Overall Length (Inch)	Morse Taper	Code
3/8	0.3750	3-1/2	6-3/4	1	751465	3-1/2	7-3/8	2	613908
25/64	0.3906	3-5/8	7	1	751466	3-5/8	7-1/2	2	613909
13/32	0.4062	3-5/8	7	1	751467	3-5/8	7-1/2	2	613910
27/64	0.4219	3-7/8	7-1/4	1	751468	3-7/8	7-3/4	2	613911
7/16	0.4375	3-7/8	7-1/4	1	751469	3-7/8	7-3/4	2	613912
29/64	0.4531	4-1/8	7-1/2	1	751470	4-1/8	8	2	613913
15/32	0.4688	4-1/8	7-1/2	1	751471	4-1/8	8	2	613914
31/64	0.4844	4-3/8	8-1/4	2	751472	4-3/8	8-1/4	2	613915
1/2	0.5000	4-3/8	8-1/4	2	751473	4-3/8	8-1/4	2	613916
33/64	0.5156	4-5/8	8-1/2	2	751474	4-5/8	8-1/2	2	613917
17/32	0.5312	4-5/8	8-1/2	2	751475	4-5/8	8-1/2	2	613918
35/64	0.5469	4-7/8	8-3/4	2	751476	4-7/8	8-3/4	2	613919
9/16	0.5625	4-7/8	8-3/4	2	751477	4-7/8	8-3/4	2	613920
37/64	0.5781	4-7/8	8-3/4	2	751478	4-7/8	8-3/4	2	613921
19/32	0.5938	4-7/8	8-3/4	2	751479	4-7/8	8-3/4	2	613922
39/64	0.6094	4-7/8	8-3/4	2	751480	4-7/8	8-3/4	2	613923
5/8	0.6250	4-7/8	8-3/4	2	751481	4-7/8	8-3/4	2	613924
41/64	0.6406	5-1/8	9	2	751482	5-1/8	9-3/4	3	613925
21/32	0.6562	5-1/8	9	2	751483	5-1/8	9-3/4	3	613926
43/64	0.6719	5-3/8	9-1/4	2	751484	5-3/8	10	3	613927
11/16	0.6875	5-3/8	9-1/4	2	751485	5-3/8	10	3	613928
45/64	0.7031	5-5/8	9-1/2	2	751486	5-5/8	10-1/4	3	613929
23/32	0.7188	5-5/8	9-1/2	2	751487	5-5/8	10-1/4	3	613930
47/64	0.7344	5-7/8	9-3/4	2	751488	5-7/8	10-1/2	3	613931
3/4	0.7500	5-7/8	9-3/4	2	751489	5-7/8	10-1/2	3	613932
49/64	0.7656	6	9-7/8	2	751490	6	10-5/8	3	613933
25/32	0.7812	6	9-7/8	2	751491	6	10-5/8	3	613934
51/64	0.7969	6-1/8	10-3/4	3	751492	6-1/8	10-3/4	3	613935
13/16	0.8125	6-1/8	10-3/4	3	751493	6-1/8	10-3/4	3	613936
53/64	0.8281	6-1/8	10-3/4	3	751494	6-1/8	10-3/4	3	613937
27/32	0.8438	6-1/8	10-3/4	3	751495	6-1/8	10-3/4	3	613938
55/64	0.8594	6-1/8	10-3/4	3	751496	6-1/8	10-3/4	3	613939
7/8	0.8750	6-1/8	10-3/4	3	751497	6-1/8	10-3/4	3	613940
57/64	0.8906	6-1/8	10-3/4	3	751498	6-1/8	10-3/4	3	613941
29/32	0.9062	6-1/8	10-3/4	3	751499	6-1/8	10-3/4	3	613942
59/64	0.9219	6-1/8	10-3/4	3	751500	6-1/8	10-3/4	3	613943
15/16	0.9375	6-1/8	10-3/4	3	751501	6-1/8	10-3/4	3	613944
61/64	0.9531	6-3/8	11	3	751502	6-3/8	11	3	613945
31/32	0.9688	6-3/8	11	3	751503	6-3/8	11	3	613946
63/64	0.9844	6-3/8	11	3	751504	6-3/8	11	3	613947
1	1.0000	6-3/8	11	3	751505	6-3/8	11	3	613948
1-1/64	1.0156	6-1/2	11-1/8	3	751506	6-1/2	12-1/8	4	613949
1-1/32	1.0312	6-1/2	11-1/8	3	751507	6-1/2	12-1/8	4	613950
1-3/64	1.0469	6-5/8	11-1/4	3	751508	6-5/8	12-1/4	4	613951
1-1/16	1.0625	6-5/8	11-1/4	3	751509	6-5/8	12-1/4	4	613952
1-5/64	1.0781	6-7/8	12-1/2	4	751510	6-7/8	12-1/2	4	613953
1-3/32	1.0938	6-7/8	12-1/2	4	751511	6-7/8	12-1/2	4	613954
1-7/64	1.1094	7-1/8	12-3/4	4	751512	7-1/8	12-3/4	4	613955
1-1/8	1.1250	7-1/8	12-3/4	4	751513	7-1/8	12-3/4	4	613956
1-9/64	1.1406	7-1/4	12-7/8	4	751514	7-1/4	12-7/8	4	613957
1-5/32	1.1562	7-1/4	12-7/8	4	612653	7-1/4	12-7/8	4	613958
1-11/64	1.1719	7-3/8	13	4	751515	7-3/8	13	4	613959

Taper Shank Drills

High Speed Steel & Super Cobalt – Standard Shank (continued)



Size (Inch)	Decimal Equiv. (Inch)	High Speed Steel				Super Cobalt			
		Flute Length (Inch)	Overall Length (Inch)	Morse Taper	Code	Flute Length (Inch)	Overall Length (Inch)	Morse Taper	Code
1-3/16	1.1875	7-3/8	13	4	751516	7-3/8	13	4	613960
1-13/64	1.2031	7-1/2	13-1/8	4	751517	7-1/2	13-1/8	4	613961
1-7/32	1.2188	7-1/2	13-1/8	4	751518	7-1/2	13-1/8	4	613962
1-15/64	1.2344	7-7/8	13-1/2	4	751519	7-7/8	13-1/2	4	613963
1-1/4	1.2500	7-7/8	13-1/2	4	751520	7-7/8	13-1/2	4	613964
1-17/64	1.2656	8-1/2	14-1/8	4	751521	8-1/2	14-1/8	4	613965
1-9/32	1.2812	8-1/2	14-1/8	4	751522	8-1/2	14-1/8	4	613966
1-19/64	1.2969	8-5/8	14-1/4	4	751523	8-5/8	14-1/4	4	613967
1-5/16	1.3125	8-5/8	14-1/4	4	751524	8-5/8	15-7/8	5	613968
1-21/64	1.3281	8-3/4	14-3/8	4	751525	8-3/4	14-3/8	4	613969
1-11/32	1.3438	8-3/4	14-3/8	4	751526	8-3/4	14-3/8	4	613970
1-23/64	1.3594	8-7/8	14-1/2	4	751527	8-7/8	14-1/2	4	613971
1-3/8	1.3750	8-7/8	14-1/2	4	751528	8-7/8	15-7/8	5	613972
1-25/64	1.3906	9	14-5/8	4	751529	9	14-5/8	4	613973
1-13/32	1.4062	9	14-5/8	4	751530	9	14-5/8	4	613974
1-27/64	1.4219	9-1/8	14-3/4	4	751531	9-1/8	14-3/4	4	613975
1-7/16	1.4375	9-1/8	14-3/4	4	751532	9-1/8	16-1/8	5	613976
1-29/64	1.4531	9-1/4	14-7/8	4	751533	9-1/4	14-7/8	4	613977
1-15/32	1.4688	9-1/4	14-7/8	4	751534	9-1/4	14-7/8	4	613978
1-31/64	1.4844	9-3/8	15	4	751535	9-3/8	15	4	613979
1-1/2	1.5000	9-3/8	15	4	751536	9-3/8	16-3/8	5	613980
1-33/64	1.5156	9-3/8	16-3/8	5	612654	-	-	-	-
1-17/32	1.5312	9-3/8	16-3/8	5	751537	-	-	-	-
1-35/64	1.5469	9-5/8	16-5/8	5	612655	-	-	-	-
1-9/16	1.5625	9-5/8	16-5/8	5	751538	-	-	-	-
1-37/64	1.5781	9-7/8	16-7/8	5	612656	-	-	-	-
1-19/32	1.5938	9-7/8	16-7/8	5	751539	-	-	-	-
1-39/64	1.6094	10	17	5	612657	-	-	-	-
1-5/8	1.6250	10	17	5	751540	10	17	5	613981
1-41/64	1.6406	10-1/8	17-1/8	5	612658	-	-	-	-
1-21/32	1.6562	10-1/8	17-1/8	5	612659	-	-	-	-
1-43/64	1.6719	10-1/8	17-1/8	5	612660	-	-	-	-
1-11/16	1.6875	10-1/8	17-1/8	5	751541	-	-	-	-
1-45/64	1.7031	10-1/8	17-1/8	5	612661	-	-	-	-
1-23/32	1.7188	10-1/8	17-1/8	5	751542	-	-	-	-
1-47/64	1.7344	10-1/8	17-1/8	5	612662	-	-	-	-
1-3/4	1.7500	10-1/8	17-1/8	5	751543	10-1/8	17-1/8	5	613982
1-49/64	1.7656	10-1/8	17-1/8	5	612663	-	-	-	-
1-25/32	1.7812	10-1/8	17-1/8	5	751544	-	-	-	-
1-51/64	1.7969	10-1/8	17-1/8	5	612664	-	-	-	-
1-13/16	1.8125	10-1/8	17-1/8	5	751545	10-1/8	17-1/8	5	613983
1-53/64	1.8281	10-1/8	17-1/8	5	612665	-	-	-	-
1-27/32	1.8438	10-1/8	17-1/8	5	751546	-	-	-	-
1-55/64	1.8594	10-3/8	17-3/8	5	612666	-	-	-	-
1-7/8	1.8750	10-3/8	17-3/8	5	751547	-	-	-	-
1-57/64	1.8906	10-3/8	17-3/8	5	612667	-	-	-	-
1-29/32	1.9062	10-3/8	17-3/8	5	751548	-	-	-	-
1-59/64	1.9219	10-3/8	17-3/8	5	612668	-	-	-	-
1-15/16	1.9375	10-3/8	17-3/8	5	751549	-	-	-	-
1-61/64	1.9531	10-3/8	17-3/8	5	612669	-	-	-	-
1-31/32	1.9688	10-3/8	17-3/8	5	751550	-	-	-	-
1-63/64	1.9844	10-3/8	17-3/8	5	612670	-	-	-	-

Taper Shank Drills

High Speed Steel & Super Cobalt – Standard Shank (continued)



Size (Inch)	Decimal Equiv. (Inch)	High Speed Steel				Super Cobalt			
		Flute Length (Inch)	Overall Length (Inch)	Morse Taper	Code	Flute Length (Inch)	Overall Length (Inch)	Morse Taper	Code
2	2.0000	10-3/8	17-3/8	5	751551	-	-	-	-
2-1/64	2.0156	10-3/8	17-3/8	5	612671	-	-	-	-
2-1/32	2.0312	10-3/8	17-3/8	5	751552	-	-	-	-
2-3/64	2.0469	10-1/4	17-3/8	5	612672	-	-	-	-
2-1/16	2.0625	10-1/4	17-3/8	5	751553	-	-	-	-
2-3/32	2.0938	10-1/4	17-3/8	5	751554	-	-	-	-
2-1/8	2.1250	10-1/4	17-3/8	5	751555	-	-	-	-
2-5/32	2.1562	10-1/4	17-3/8	5	751556	-	-	-	-
2-3/16	2.1875	10-1/4	17-3/8	5	751557	-	-	-	-
2-7/32	2.2188	10-1/8	17-3/8	5	751558	-	-	-	-
2-1/4	2.2500	10-1/8	17-3/8	5	751559	-	-	-	-
2-9/32	2.2812	10-1/8	17-3/8	5	612673	-	-	-	-
2-5/16	2.3125	10-1/8	17-3/8	5	751560	-	-	-	-
2-11/32	2.3438	10-1/8	17-3/8	5	612674	-	-	-	-
2-3/8	2.3750	10-1/8	17-3/8	5	751561	-	-	-	-
2-13/32	2.4062	11-1/4	18-3/4	5	612675	-	-	-	-
2-7/16	2.4375	11-1/4	18-3/4	5	751562	-	-	-	-
2-15/32	2.4688	11-1/4	18-3/4	5	612676	-	-	-	-
2-1/2	2.5000	11-1/4	18-3/4	5	751563	-	-	-	-
2-17/32	2.5312	11-7/8	19-1/2	5	612677	-	-	-	-
2-9/16	2.5625	11-7/8	19-1/2	5	751564	-	-	-	-
2-19/32	2.5938	11-7/8	19-1/2	5	612678	-	-	-	-
2-5/8	2.6250	11-7/8	19-1/2	5	751565	-	-	-	-
2-21/32	2.6562	12-3/4	20-3/8	5	612679	-	-	-	-
2-11/16	2.6875	12-3/4	20-3/8	5	751566	-	-	-	-
2-23/32	2.7188	12-3/4	20-3/8	5	612680	-	-	-	-
2-3/4	2.7500	12-3/4	20-3/8	5	751567	-	-	-	-
2-25/32	2.7812	13-3/8	21-1/8	5	612681	-	-	-	-
2-13/16	2.8125	13-3/8	21-1/8	5	751568	-	-	-	-
2-27/32	2.8438	13-3/8	21-1/8	5	612682	-	-	-	-
2-7/8	2.8750	13-3/8	21-1/8	5	751569	-	-	-	-
2-29/32	2.9062	13-3/8	21-1/8	5	612683	-	-	-	-
2-15/16	2.9375	14	21-3/4	5	751570	-	-	-	-
2-31/32	2.9688	14	21-3/4	5	612684	-	-	-	-
3	3.0000	14	21-3/4	5	751571	-	-	-	-
3-1/16	3.0625	14-5/8	24-1/2	6	612685	-	-	-	-
3-1/8	3.1250	14-5/8	24-1/2	6	751572	-	-	-	-
3-3/16	3.1875	14-5/8	24-1/2	6	612686	-	-	-	-
3-1/4	3.2500	15-1/2	25-1/2	6	751573	-	-	-	-
3-5/16	3.3125	15-1/2	25-1/2	6	612687	-	-	-	-
3-3/8	3.3750	15-1/2	25-1/2	6	612688	-	-	-	-
3-7/16	3.4375	15-1/2	25-1/2	6	612689	-	-	-	-
3-1/2	3.5000	16-3/8	26-1/2	6	612690	-	-	-	-
3-5/8	3.6250	16-3/8	26-1/2	6	612691	-	-	-	-
3-3/4	3.7500	16-3/8	26-1/2	6	612692	-	-	-	-
3-7/8	3.8750	16-3/8	26-1/2	6	612693	-	-	-	-
4	4.0000	17-1/2	27-1/2	6	612694	-	-	-	-

Taper Shank Drills

High Speed Steel – Larger than Standard Shank



- High speed steel
- 118° point for general purpose applications

Size (Inch)	Decimal Equiv. (Inch)	Flute Length (Inch)	Overall Length (Inch)	Morse Taper	Code
21/64	0.3281	3-1/2	7-3/8	2	612848
23/64	0.3594	3-1/2	7-3/8	2	612849
3/8	0.3750	3-1/2	7-3/8	2	751626
25/64	0.3906	3-5/8	7-1/2	2	751627
13/32	0.4062	3-5/8	7-1/2	2	751628
27/64	0.4219	3-7/8	7-3/4	2	751629
7/16	0.4375	3-7/8	7-3/4	2	751630
29/64	0.4531	4-1/8	8	2	751631
15/32	0.4688	4-1/8	8	2	751632
41/64	0.6406	5-1/8	9-3/4	3	751633
21/32	0.6562	5-1/8	9-3/4	3	751634
43/64	0.6719	5-3/8	10	3	751635

Size (Inch)	Decimal Equiv. (Inch)	Flute Length (Inch)	Overall Length (Inch)	Morse Taper	Code
11/16	0.6875	5-3/8	10	3	751636
45/64	0.7031	5-5/8	10-1/4	3	751637
23/32	0.7188	5-5/8	10-1/4	3	751638
47/64	0.7344	5-7/8	10-1/2	3	751639
3/4	0.7500	5-7/8	10-1/2	3	751640
49/64	0.7656	6	10-5/8	3	751641
25/32	0.7812	6	10-5/8	3	751642
1	1.0000	6-3/8	12	4	751575
1-1/32	1.0312	6-1/2	12-1/8	4	751576
1-1/16	1.0625	6-5/8	12-1/4	4	751577

Taper Shank Drills

High Speed Steel & Super Cobalt – Smaller than Standard Shank



- High speed steel
- 118° point for general purpose applications
- Super cobalt
- 135° split point for heavy duty applications
- Premium cobalt drills exhibit greater toughness, abrasion resistance and higher hardness than the standard high speed drills
- Recommended for use on hard to machine materials where longer tool life is desired

Size (Inch)	Decimal Equiv. (Inch)	High Speed Steel				Super Cobalt			
		Flute Length (Inch)	Overall Length (Inch)	Morse Taper	Code	Flute Length (Inch)	Overall Length (Inch)	Morse Taper	Code
3/8	0.3750	-	-	-	-	3-1/2	6-3/4	1	613984
31/64	0.4844	4-3/8	7-3/4	1	612850	-	-	-	-
1/2	0.5000	4-3/8	7-3/4	1	612851	-	-	-	-
33/64	0.5156	4-5/8	8	1	612852	-	-	-	-
17/32	0.5312	4-5/8	8	1	612853	-	-	-	-
35/64	0.5469	4-7/8	8-1/4	1	612854	-	-	-	-
9/16	0.5625	4-7/8	8-1/4	1	612855	-	-	-	-
37/64	0.5781	4-7/8	8-1/4	1	612856	-	-	-	-
21/32	0.6562	5-1/8	9-3/4	1	612857	-	-	-	-
25/32	0.7812	-	-	-	-	6	9-7/8	2	613985
51/64	0.7969	6-1/8	10	2	612858	-	-	-	-
13/16	0.8125	6-1/8	10	2	612859	6-1/8	10	2	613986
53/64	0.8281	6-1/8	10	2	612860	-	-	-	-
27/32	0.8438	6-1/8	10	2	612861	-	-	-	-
55/64	0.8594	6-1/8	10	2	612862	-	-	-	-
7/8	0.8750	6-1/8	10	2	612863	-	-	-	-
57/64	0.8906	6-1/8	10	2	612864	-	-	-	-
29/32	0.9062	6-1/8	10	2	612865	-	-	-	-
1	1.0000	6-1/4	10-1/8	2	612866	-	-	-	-
1-5/64	1.0781	6-7/8	11-1/2	3	612867	-	-	-	-
1-3/32	1.0938	6-7/8	11-1/2	3	612868	-	-	-	-
1-7/64	1.1094	7-1/8	11-3/4	3	612869	-	-	-	-
1-1/8	1.1250	7-1/8	11-3/4	3	612870	-	-	-	-
1-9/64	1.1406	7-1/4	11-7/8	3	612871	-	-	-	-
1-5/32	1.1562	7-1/4	11-7/8	3	612872	-	-	-	-
1-11/64	1.1719	7-3/8	12	3	612873	-	-	-	-
1-3/16	1.1875	7-3/8	12	3	612874	7-3/8	12	3	613987
1-13/64	1.2031	7-1/2	12-1/8	3	612875	-	-	-	-

Taper Shank Drills

High Speed Steel & Super Cobalt – Smaller than Standard Shank (continued)

Size (Inch)	Decimal Equiv. (Inch)	High Speed Steel				Super Cobalt			
		Flute Length (Inch)	Overall Length (Inch)	Morse Taper	Code	Flute Length (Inch)	Overall Length (Inch)	Morse Taper	Code
1-7/32	1.2188	7-1/2	12-1/8	3	612876	-	-	-	-
1-15/64	1.2344	7-7/8	12-1/2	3	612877	-	-	-	-
1-1/4	1.2500	7-7/8	12-1/2	3	612878	-	-	-	-
1-9/32	1.2812	8-1/2	13-1/8	3	612879	-	-	-	-
1-5/16	1.3125	8-5/8	13-1/4	3	612880	8-5/8	14-1/4	4	613988
1-11/32	1.3438	8-3/4	13-3/8	3	612881	-	-	-	-
1-3/8	1.3750	8-7/8	13-1/2	3	612882	8-7/8	14-1/2	4	613989
1-13/32	1.4062	9	13-5/8	3	612883	-	-	-	-
1-7/16	1.4375	9-1/8	13-3/4	3	612884	9-1/8	14-3/4	4	613990
1-15/32	1.4688	9-1/4	13-7/8	3	612885	-	-	-	-
1-1/2	1.5000	9-3/8	14	3	612886	9-3/8	15	4	613991
1-33/64	1.5156	9-3/8	15	4	612887	-	-	-	-
1-17/32	1.5312	9-3/8	16	4	612888	-	-	-	-
1-35/64	1.5469	9-5/8	15-1/4	4	612889	-	-	-	-
1-9/16	1.5625	9-5/8	15-1/4	4	612890	-	-	-	-
1-37/64	1.5781	9-7/8	15-1/2	4	612891	-	-	-	-
1-19/32	1.5938	9-7/8	15-1/2	4	612892	-	-	-	-
1-39/64	1.6094	10	15-5/8	4	612893	-	-	-	-
1-5/8	1.6250	10	15-5/8	4	612894	-	-	-	-
1-41/64	1.6406	10-1/8	15-3/4	4	612895	-	-	-	-
1-21/32	1.6562	10-1/8	15-3/4	4	612896	-	-	-	-
1-43/64	1.6719	10-1/8	15-3/4	4	612897	-	-	-	-
1-11/16	1.6875	10-1/8	15-3/4	4	612898	-	-	-	-

Metric Taper Shank Drills

High Speed Steel – General Purpose – 118° Point



- Designed for high production drilling on a wide range of materials and will perform well under various operating conditions
- Supplied with a black nitrate finish for increased abrasion resistance and extra long life
- Manufactured to ISO standards

Size (mm)	Morse Taper	Flute Length (mm)	Overall Length (mm)	Code	Size (mm)	Morse Taper	Flute Length (mm)	Overall Length (mm)	Code	Size (mm)	Morse Taper	Flute Length (mm)	Overall Length (mm)	Code
8.0	1	75	156	612997	19.0	2	135	233	613017	28.5	3	170	291	613039
8.5	1	75	156	612998	19.5	2	140	238	613018	29.0	3	175	296	613040
9.0	1	81	162	612999	20.0	2	140	238	613019	29.5	3	175	296	613041
9.5	1	81	162	613000	20.5	2	145	243	613020	30.0	3	175	296	613042
10.0	1	87	168	613001	21.0	2	145	243	613021	30.5	3	175	296	613043
10.5	1	87	168	613002	22.0	2	150	248	613022	31.0	3	180	301	613044
11.0	1	87	168	613003	22.5	2	155	253	613023	31.5	3	180	301	613045
11.5	1	87	168	751643	23.0	2	155	253	613024	32.0	4	185	334	613046
12.0	1	94	175	751644	21.5	3	150	248	613025	32.5	4	185	334	613047
12.5	1	94	175	613004	22.0	3	150	248	613026	33.0	4	185	334	613048
13.0	1	101	182	613005	22.5	3	155	253	613027	33.5	4	185	334	613049
13.5	1	101	182	613006	23.0	3	155	253	613028	34.0	4	190	339	613050
14.0	1	108	189	613007	23.5	3	155	276	613029	34.5	4	190	339	613051
14.5	2	114	212	613008	24.0	3	155	276	613030	35.0	4	190	339	613052
15.0	2	114	212	613009	24.5	3	155	276	613031	35.5	4	190	339	613053
15.5	2	120	218	613010	25.0	3	160	281	613032	36.0	4	195	344	613054
16.0	2	120	218	613011	25.5	3	160	281	613033	36.5	4	195	344	613055
16.5	2	125	223	613012	26.0	3	165	286	613034	37.0	4	195	344	613056
17.0	2	125	223	613013	26.5	3	165	286	613035	37.5	4	195	344	613057
17.5	2	130	228	613014	27.0	3	165	286	613036	38.0	4	200	349	613058
18.0	2	130	228	613015	27.5	3	170	291	613037	38.5	4	200	349	613059
18.5	2	135	233	613016	28.0	3	170	291	613038	39.0	4	200	349	613060
										39.5	4	200	349	613061
										40.0	4	200	349	613062

Aircraft Extension Drills

High Speed Steel – 135° Split Point



Size	Decimal Equivalent (Inch)	Flute Length (Inch)	6"	12"	Size	Decimal Equivalent (Inch)	Flute Length (Inch)	6"	12"
			Overall Length	Overall Length				Overall Length	Overall Length
			Code	Code				Code	Code
65	0.0350	5/8	610450	-	11/64	0.1719	2-1/8	753010	610585
60	0.0400	11/16	610451	610542	17	0.1730	2-3/16	610492	610586
59	0.0410	11/16	610452	610543	16	0.1770	2-3/16	610493	610587
58	0.0420	11/16	610453	610544	15	0.1800	2-3/16	610494	610588
57	0.0430	3/4	610454	610545	14	0.1820	2-3/16	610495	610589
56	0.0465	3/4	610455	610546	13	0.1850	2-5/16	610496	610590
3/64	0.0469	3/4	610456	610547	3/16	0.1875	2-5/16	753011	753032
55	0.0520	7/8	610457	610548	12	0.1890	2-5/16	610497	610591
54	0.0550	7/8	610458	610549	11	0.1910	2-5/16	753012	753033
53	0.0595	7/8	610459	610550	10	0.1935	2-7/16	753013	753034
1/16	0.0625	7/8	610460	610551	9	0.1960	2-7/16	610498	610592
52	0.0635	7/8	610461	610552	8	0.1990	2-7/16	610499	610593
51	0.0670	1	610462	610553	7	0.2010	2-7/16	610500	610594
50	0.0700	1	610463	610554	13/64	0.2031	2-7/16	753014	753035
49	0.0730	1	610464	610555	6	0.2040	2-1/2	610501	610595
48	0.0760	1	610465	610556	5	0.2055	2-1/2	610502	610596
5/64	0.0781	1	610466	610557	4	0.2090	2-1/2	610503	610597
47	0.0785	1	610467	610558	3	0.2130	2-1/2	610504	610598
46	0.0810	1-1/8	610468	610559	7/32	0.2188	2-1/2	753015	753036
45	0.0820	1-1/8	610469	610560	2	0.2210	2-5/8	753016	610599
44	0.0860	1-1/8	610470	610561	1	0.2280	2-5/8	753017	753037
43	0.0890	1-1/4	610471	610562	A	0.2340	2-5/8	610505	610600
42	0.0935	1-1/4	610472	610563	15/64	0.2344	2-5/8	753018	753038
3/32	0.0938	1-1/4	753000	610564	B	0.2380	2-3/4	610506	610601
41	0.0960	1-3/8	610473	610565	C	0.2420	2-3/4	610507	610602
40	0.0980	1-3/8	753001	753024	D	0.2460	2-3/4	610508	610603
39	0.0995	1-3/8	610474	610566	1/4	0.2500	2-3/4	753019	753039
38	0.1015	1-7/16	610475	610567	F	0.2570	2-7/8	610509	610604
37	0.1040	1-7/16	610476	610568	G	0.2610	2-7/8	610510	610605
36	0.1065	1-7/16	610477	610569	17/64	0.2656	2-7/8	610511	753040
7/64	0.1094	1-1/2	753002	610570	H	0.2660	2-7/8	610512	610606
35	0.1100	1-1/2	610478	610571	I	0.2720	2-7/8	610513	610607
34	0.1110	1-1/2	610479	610572	J	0.2770	2-7/8	610514	610608
33	0.1130	1-1/2	610480	610573	K	0.2810	2-15/16	610515	610609
32	0.1160	1-5/8	610481	610574	9/32	0.2812	2-15/16	610516	753041
31	0.1200	1-5/8	610482	610575	L	0.2900	2-15/16	610517	610610
1/8	0.1250	1-5/8	753003	753025	M	0.2950	3-1/16	610518	610611
30	0.1285	1-5/8	753004	753026	19/64	0.2969	3-1/16	610519	753042
29	0.1360	1-3/4	753005	753027	N	0.3020	3-1/16	610520	610612
28	0.1405	1-3/4	610483	610576	5/16	0.3125	3-3/16	753020	753043
9/64	0.1406	1-3/4	753006	753028	O	0.3160	3-3/16	610521	610613
27	0.1440	1-7/8	610484	610577	P	0.3230	3-5/16	610522	610614
26	0.1470	1-7/8	610485	610578	21/64	0.3281	3-5/16	610523	753044
25	0.1495	1-7/8	610486	610579	Q	0.3320	3-7/16	610524	610615
24	0.1520	2	610487	610580	R	0.3390	3-7/16	610525	610616
23	0.1540	2	610488	610581	11/32	0.3438	3-7/16	610526	753045
5/32	0.1562	2	753007	753029	S	0.3480	3-1/2	610527	610617
22	0.1570	2	610489	610582	T	0.3580	3-1/2	610528	610618
21	0.1590	2-1/8	753008	753030	23/64	0.3594	3-1/2	610529	753046
20	0.1610	2-1/8	753009	753031	U	0.3680	3-5/8	610530	610619
19	0.1660	2-1/8	610490	610583	3/8	0.3750	3-5/8	753021	753047
18	0.1695	2-1/8	610491	610584	V	0.3770	3-5/8	610531	610620

Aircraft Extension Drills

High Speed Steel – 135° Split Point (continued)



Size	Decimal Equivalent (Inch)	Flute Length (Inch)	6"	12"	Size	Decimal Equivalent (Inch)	Flute Length (Inch)	6"	12"
			Overall Length	Overall Length				Overall Length	Overall Length
			Code	Code				Code	Code
W	0.3860	3-3/4	610532	610621	27/64	0.4219	3-15/16	610538	753050
25/64	0.3906	3-3/4	610533	753048	7/16	0.4375	4-1/16	753022	753051
X	0.3970	3-3/4	610534	610622	29/64	0.4531	4-3/16	610539	753052
Y	0.4040	3-7/8	610535	610623	15/32	0.4688	4-5/16	610540	753053
13/32	0.4062	3-7/8	610536	753049	31/64	0.4844	4-3/8	610541	753054
Z	0.4130	3-7/8	610537	610624	1/2	0.5000	4-1/2	753023	753055

Extra Length Drills

Inch, Metric & Letter Sizes – Straight Shank – High Speed Steel



- 118° point, for deep hole or long reach drilling in a wide variety of materials
- Hand held or fixed spindle use

Size	Decimal Equivalent (Inch)	6" OAL	8" OAL	9" OAL	10" OAL	12" OAL	15" OAL	18" OAL	24" OAL	48" OAL
		4" Flute Length	5-1/2" Flute Length	6-1/2" Flute Length	7-1/2" Flute Length	9" Flute Length	11" Flute Length	12" Flute Length	18" Flute Length	5-1/2" Flute Length
		Code	Code	Code	Code	Code	Code	Code	Code	Code
1/16	0.0625	610000	-	-	-	-	-	-	-	-
5/64	0.0781	610001	-	-	-	-	-	-	-	-
3/32	0.0938	610002	610009	-	-	-	-	-	-	-
7/64	0.1094	610003	610010	-	-	610072	-	-	-	-
3 mm	0.1181	-	-	-	-	610130	-	-	-	-
1/8	0.1250	610004	610011	-	610044	751400	-	610208	-	-
9/64	0.1406	610005	610012	-	610045	751401	-	-	-	-
5/32	0.1562	610006	610013	-	610046	751402	-	610209	-	-
4 mm	0.1575	-	-	-	-	610131	-	-	-	-
11/64	0.1719	610007	610014	-	610047	751403	-	-	-	-
3/16	0.1875	610008	610015	-	610048	751404	610150	610210	-	-
5 mm	0.1968	-	-	-	-	610132	-	-	-	-
13/64	0.2031	-	610016	-	610049	751405	-	610211	-	-
7/32	0.2188	-	610017	-	610050	751406	610151	610212	-	-
15/64	0.2344	-	610018	-	610051	751407	-	610213	-	-
6 mm	0.2362	-	-	-	-	610133	-	-	-	-
1/4	0.2500	-	610019	-	610052	751408	610152	610214	610299	610317
F	0.2570	-	610020	-	-	-	-	-	-	-
17/64	0.2656	-	610021	-	610053	751409	-	610215	-	-
7 mm	0.2756	-	-	-	-	610134	-	-	-	-
9/32	0.2812	-	610022	-	610054	751410	610153	610216	-	-
19/64	0.2969	-	610023	-	610055	751411	-	610217	-	-
5/16	0.3125	-	610024	-	610056	751412	610154	610218	610300	610318
8 mm	0.3150	-	-	-	-	610135	-	-	-	-
21/64	0.3281	-	610025	-	610057	751413	-	610219	-	-
11/32	0.3438	-	610026	-	610058	751414	610155	610220	-	-
9 mm	0.3543	-	-	-	-	610136	-	-	-	-
23/64	0.3594	-	610027	-	610059	751415	-	610221	-	-
3/8	0.3750	-	610028	-	610060	751416	610156	610222	610301	610319
25/64	0.3906	-	610029	-	610061	751417	-	610223	-	-

Extra Length Drills

Inch, Metric & Letter Sizes – Straight Shank – High Speed Steel (continued)



Size	Decimal Equivalent (Inch)	6" OAL	8" OAL	9" OAL	10" OAL	12" OAL	15" OAL	18" OAL	24" OAL	48" OAL
		4" Flute Length	5-1/2" Flute Length	6-1/2" Flute Length	7-1/2" Flute Length	9" Flute Length	11" Flute Length	12" Flute Length	18" Flute Length	5-1/2" Flute Length
		Code	Code	Code	Code	Code	Code	Code	Code	Code
10 mm	0.3937	-	-	-	-	610137	-	-	-	-
13/32	0.4062	-	610030	-	610062	751418	610157	610224	-	-
10.5 mm	0.4134	-	-	-	-	610138	-	-	-	-
27/64	0.4219	-	610031	610037	610063	751419	-	610225	-	-
11 mm	0.4331	-	-	-	610064	610139	610158	610226	-	-
7/16	0.4375	-	610032	610038	610065	751420	610159	610227	610302	610320
29/64	0.4531	-	610033	610039	610066	751421	610160	610228	-	-
15/32	0.4688	-	610034	610040	610067	751422	610161	610229	-	-
12 mm	0.4724	-	-	-	-	610140	-	-	-	-
31/64	0.4844	-	610035	610041	610068	751423	-	610230	-	-
1/2	0.5000	-	610036	610042	610069	751424	610162	610231	610303	610321
13 mm	0.5118	-	-	-	-	610141	-	-	-	-
33/64	0.5156	-	-	-	-	610098	-	610232	-	-
17/32	0.5312	-	-	610043	610070	610099	610163	610233	-	-
13.8 mm	0.5433	-	-	-	-	610142	-	-	-	-
35/64	0.5469	-	-	-	-	610100	-	610234	-	-
14 mm	0.5512	-	-	-	-	610143	-	-	-	-
9/16	0.5625	-	-	-	610071	610101	610164	610235	610304	-
37/64	0.5781	-	-	-	-	610102	-	610236	-	-
15 mm	0.5906	-	-	-	-	610144	-	-	-	-
19/32	0.5938	-	-	-	-	610103	610165	610237	-	-
39/64	0.6094	-	-	-	-	610104	-	610238	-	-
5/8	0.6250	-	-	-	-	610105	610166	610239	610305	610322
16 mm	0.6299	-	-	-	-	610145	-	-	-	-
41/64	0.6406	-	-	-	-	610106	-	610240	-	-
21/32	0.6562	-	-	-	-	610107	610167	610241	-	-
17 mm	0.6693	-	-	-	-	610146	-	-	-	-
43/64	0.6719	-	-	-	-	610108	-	610242	-	-
11/16	0.6875	-	-	-	-	610109	610168	610243	610306	-
17.5 mm	0.6890	-	-	-	-	610147	-	-	-	-
45/64	0.7031	-	-	-	-	610110	-	610244	-	-
23/32	0.7188	-	-	-	-	610111	610169	610245	-	-
47/64	0.7344	-	-	-	-	610112	-	610246	-	-
3/4	0.7344	-	-	-	-	610113	610170	610247	610307	610323
49/64	0.7656	-	-	-	-	610114	-	610248	-	-
25/32	0.7812	-	-	-	-	610115	610171	610249	610308	-
20 mm	0.7874	-	-	-	-	610148	-	-	-	-
51/64	0.7969	-	-	-	-	610116	-	610250	-	-
13/16	0.8125	-	-	-	-	610117	610172	610251	610309	-
53/64	0.8281	-	-	-	-	610118	-	610252	-	-
27/32	0.8438	-	-	-	-	610119	-	610253	610310	-
55/64	0.8594	-	-	-	-	610120	-	610254	-	-
7/8	0.8750	-	-	-	-	610121	610173	610255	610311	-
22.5 mm	0.8858	-	-	-	-	610149	-	-	-	-
57/64	0.8906	-	-	-	-	610122	-	610256	-	-
29/32	0.9062	-	-	-	-	610123	-	610257	-	-
59/64	0.9219	-	-	-	-	610124	-	610258	-	-
15/16	0.9375	-	-	-	-	610125	610174	610259	610312	-
61/64	0.9531	-	-	-	-	610126	-	610260	-	-
31/32	0.9688	-	-	-	-	610127	-	610261	-	-
63/64	0.9844	-	-	-	-	610128	-	610262	-	-
1	1.0000	-	-	-	-	610129	610175	610263	610313	-
1-1/8	1.1250	-	-	-	-	-	-	610264	610314	-
1-3/16	1.1875	-	-	-	-	-	-	610265	610315	-
1-1/4	1.2500	-	-	-	-	-	-	610266	610316	-

Extra Length Drills

1/2" Reduced Shank – Straight Shank – High Speed Steel – 118° Point



Size	Decimal Equivalent (Inch)	12" OAL		18" OAL		Size	Decimal Equivalent (Inch)	12" OAL		18" OAL	
		9"		12"				9"		12"	
		Flute Length	Code	Flute Length	Code			Flute Length	Code	Flute Length	Code
33/64	0.5156	610176	610267	49/64	0.7656	610192	610283				
17/32	0.5312	610177	610268	25/32	0.7812	610193	610284				
35/64	0.5469	610178	610269	51/64	0.7969	610194	610285				
9/16	0.5625	610179	610270	13/16	0.8125	610195	610286				
37/64	0.5781	610180	610271	53/64	0.8281	610196	610287				
19/32	0.5938	610181	610272	27/32	0.8438	610197	610288				
39/64	0.6094	610182	610273	55/64	0.8594	610198	610289				
5/8	0.6250	610183	610274	7/8	0.8750	610199	610290				
41/64	0.6406	610184	610275	57/64	0.8906	610200	610291				
21/32	0.6562	610185	610276	29/32	0.9062	610201	610292				
43/64	0.6719	610186	610277	59/64	0.9219	610202	610293				
11/16	0.6875	610187	610278	15/16	0.9375	610203	610294				
45/64	0.7031	610188	610279	61/64	0.9531	610204	610295				
23/32	0.7188	610189	610280	31/32	0.9688	610205	610296				
47/64	0.7344	610190	610281	63/64	0.9844	610206	610297				
3/4	0.7500	610191	610282	1	1.0000	610207	610298				

Taper Shank Extra Length Drills

High Speed Steel – 118° Point



- Used in deep hole or long reach drilling applications and are suitable for many types of materials

Size (Inch)	Decimal Equiv. (Inch)	Flute Length (Inch)	Overall Length (Inch)	Morse Taper	Code	Size (Inch)	Decimal Equiv. (Inch)	Flute Length (Inch)	Overall Length (Inch)	Morse Taper	Code
1/8	0.1250	5	8	1	613300	9/32	0.2812	7	10	1	613325
9/64	0.1406	5	8	1	613301	19/64	0.2969	7	10	1	613326
5/32	0.1562	5	8	1	613302	21/64	0.3281	7	10	1	613327
11/64	0.1719	5	8	1	613303	23/64	0.3594	7	10	1	613328
3/16	0.1875	5	8	1	613304	3/8	0.3750	7	10	1	613329
13/64	0.2031	5	8	1	613305	7/16	0.4375	7	10	1	613330
7/32	0.2188	5	8	1	613306	29/64	0.4531	7	10	1	613331
15/64	0.2344	5	8	1	613307	15/32	0.4688	7	10	1	613332
1/4	0.2500	5	8	1	613308	31/64	0.4844	6	10	2	613333
17/64	0.2656	5	8	1	613309	1/2	0.5000	6	10	2	613334
9/32	0.2812	5	8	1	613310	33/64	0.5156	6	10	2	613335
19/64	0.2969	5	8	1	613311	17/32	0.5312	6	10	2	613336
5/16	0.3125	5	8	1	613312	9/16	0.5625	6	10	2	613337
5/16	0.3125	4	8	2	613730	37/64	0.5781	6	10	2	613338
21/64	0.3281	5	8	1	613313	19/32	0.5938	6	10	2	613339
11/32	0.3438	5	8	1	613314	5/8	0.6250	6	10	2	613340
23/64	0.3594	5	8	1	613315	1/8	0.1250	9	12	1	613341
3/8	0.3750	5	8	1	613316	11/64	0.1719	9	12	1	613342
29/64	0.4531	5	8	1	613317	3/16	0.1875	9	12	1	613343
15/32	0.4688	5	8	1	613318	13/64	0.2031	9	12	1	613344
5/32	0.1562	7	10	1	613319	7/32	0.2188	9	12	1	613345
11/64	0.1719	7	10	1	613320	15/64	0.2344	9	12	1	613346
13/64	0.2031	7	10	1	613321	1/4	0.2500	9	12	1	613347
7/32	0.2188	7	10	1	613322	17/64	0.2656	9	12	1	613348
15/64	0.2344	7	10	1	613323	9/32	0.2812	9	12	1	613349
1/4	0.2500	7	10	1	613324	19/64	0.2969	9	12	1	613350

Taper Shank Extra Length Drills

High Speed Steel – 118° Point (continued)



Size (Inch)	Decimal Equiv. (Inch)	Flute Length (Inch)	Overall Length (Inch)	Morse Taper	Code	Size (Inch)	Decimal Equiv. (Inch)	Flute Length (Inch)	Overall Length (Inch)	Morse Taper	Code
5/16	0.3125	9	12	1	613351	5/8	0.6250	10	14	2	613404
21/64	0.3281	9	12	1	613352	21/32	0.6562	10	14	2	613405
11/32	0.3438	9	12	1	613353	11/16	0.6875	10	14	2	613406
23/64	0.3594	9	12	1	613354	45/64	0.7031	10	14	2	613407
3/8	0.3750	9	12	1	613355	23/32	0.7188	10	14	2	613408
25/64	0.3906	9	12	1	613356	47/64	0.7344	10	14	2	613409
13/32	0.4062	9	12	1	613357	3/4	0.7500	10	14	2	613410
27/64	0.4219	9	12	1	613358	49/64	0.7656	10	14	2	613411
7/16	0.4375	9	12	1	613359	25/32	0.7812	10	14	2	613412
29/64	0.4531	9	12	1	613360	27/32	0.8438	9	14	3	613413
15/32	0.4688	9	12	1	613361	57/64	0.8906	9	14	3	613414
31/64	0.4844	8	12	2	613362	31/32	0.9688	9	14	3	613415
1/2	0.5000	8	12	2	613363	63/64	0.9844	9	14	3	613416
33/64	0.5156	8	12	2	613364	3/16	0.1875	12	15	1	613417
17/32	0.5312	8	12	2	613365	13/64	0.2031	12	15	1	613418
35/64	0.5469	8	12	2	613366	7/32	0.2188	12	15	1	613419
9/16	0.5625	8	12	2	613367	15/64	0.2344	12	15	1	613420
37/64	0.5781	8	12	2	613368	1/4	0.2500	12	15	1	613421
19/32	0.5938	8	12	2	613369	17/64	0.2656	12	15	1	613422
39/64	0.6094	8	12	2	613370	9/32	0.2812	12	15	1	613423
5/8	0.6250	8	12	2	613371	19/64	0.2969	12	15	1	613424
41/64	0.6406	8	12	2	613372	5/16	0.3125	12	15	1	613425
21/32	0.6562	8	12	2	613373	21/64	0.3281	12	15	1	613426
43/64	0.6719	8	12	2	613374	11/32	0.3438	12	15	1	613427
11/16	0.6875	8	12	2	613375	23/64	0.3594	12	15	1	613428
45/64	0.7031	8	12	2	613376	3/8	0.3750	12	15	1	613429
23/32	0.7188	8	12	2	613377	25/64	0.3906	12	15	1	613430
47/64	0.7344	8	12	2	613378	13/32	0.4062	12	15	1	613431
3/4	0.7500	8	12	2	613379	27/64	0.4219	12	15	1	613432
49/64	0.7656	8	12	2	613380	7/16	0.4375	12	15	1	613433
49/64	0.7656	7	12	3	613731	29/64	0.4531	12	15	1	613434
25/32	0.7812	8	12	2	613381	15/32	0.4688	12	15	1	613435
25/32	0.7812	7	12	3	613732	31/64	0.4844	11	15	2	613436
51/64	0.7969	7	12	3	613382	1/2	0.5000	11	15	2	613437
13/16	0.8125	7	12	3	613383	33/64	0.5156	11	15	2	613438
53/64	0.8281	7	12	3	613384	17/32	0.5312	11	15	2	613439
27/32	0.8438	7	12	3	613385	35/64	0.5469	12	15	1	613440
55/64	0.8594	7	12	3	613386	35/64	0.5469	11	15	2	613734
7/8	0.8750	7	12	3	613387	9/16	0.5625	11	15	2	613441
57/64	0.8906	7	12	3	613388	37/64	0.5781	11	15	2	613442
29/32	0.9062	7	12	3	613389	19/32	0.5938	11	15	2	613443
59/64	0.9219	7	12	3	613390	39/64	0.6094	11	15	2	613444
15/16	0.9375	7	12	3	613391	5/8	0.6250	11	15	2	613445
31/32	0.9688	7	12	3	613392	41/64	0.6406	11	15	2	613446
1	1.0000	7	12	3	613393	21/32	0.6562	11	15	2	613447
5/16	0.3125	10	14	2	613394	43/64	0.6719	11	15	2	613448
7/16	0.4375	11	14	1	613395	11/16	0.6875	11	15	2	613449
15/32	0.4688	11	14	1	613396	45/64	0.7031	11	15	2	613450
15/32	0.4688	10	14	2	613733	23/32	0.7188	11	15	2	613451
31/64	0.4844	10	14	2	613397	47/64	0.7344	11	15	2	613452
1/2	0.5000	10	14	2	613398	3/4	0.7500	11	15	2	613453
33/64	0.5156	10	14	2	613399	49/64	0.7656	11	15	2	613454
17/32	0.5312	10	14	2	613400	25/32	0.7812	11	15	2	613455
37/64	0.5781	10	14	2	613401	51/64	0.7969	10	15	3	613456
19/32	0.5938	10	14	2	613402	13/16	0.8125	10	15	3	613457
39/64	0.6094	10	14	2	613403	53/64	0.8281	10	15	3	613458

Taper Shank Extra Length Drills

High Speed Steel – 118° Point (continued)



Size (Inch)	Decimal Equiv. (Inch)	Flute Length (Inch)	Overall Length (Inch)	Morse Taper	Code	Size (Inch)	Decimal Equiv. (Inch)	Flute Length (Inch)	Overall Length (Inch)	Morse Taper	Code
27/32	0.8438	10	15	3	613459	45/64	0.7031	14	18	2	613514
55/64	0.8594	10	15	3	613460	23/32	0.7188	14	18	2	613515
7/8	0.8750	10	15	3	613461	47/64	0.7344	14	18	2	613516
57/64	0.8906	10	15	3	613462	3/4	0.7500	14	18	2	613517
29/32	0.9062	10	15	3	613463	49/64	0.7656	14	18	2	613518
59/64	0.9219	10	15	3	613464	25/32	0.7812	14	18	2	613519
15/16	0.9375	10	15	3	613465	51/64	0.7969	13	18	3	613520
61/64	0.9531	10	15	3	613466	13/16	0.8125	13	18	3	613521
31/32	0.9688	10	15	3	613467	53/64	0.8281	13	18	3	613522
63/64	0.9844	10	15	3	613468	27/32	0.8438	13	18	3	613523
1	1.0000	10	15	3	613469	55/64	0.8594	13	18	3	613524
1-1/64	1.0156	10	15	3	613470	7/8	0.8750	13	18	3	613525
1-1/32	1.0312	10	15	3	613471	57/64	0.8906	13	18	3	613526
1-3/64	1.0469	10	15	3	613472	29/32	0.9062	13	18	3	613527
1-1/16	1.0625	10	15	3	613473	59/64	0.9219	13	18	3	613528
1-5/64	1.0781	9	15	4	613474	15/16	0.9375	13	18	3	613529
1-3/32	1.0938	9	15	4	613475	61/64	0.9531	13	18	3	613530
1-7/64	1.1094	9	15	4	613476	31/32	0.9688	13	18	3	613531
1-1/8	1.1250	9	15	4	613477	63/64	0.9844	13	18	3	613532
1-9/64	1.1406	9	15	4	613478	1	1.0000	13	18	3	613533
1-5/32	1.1562	9	15	4	613479	1-1/64	1.0156	13	18	3	613534
1-11/64	1.1719	9	15	4	613480	1-1/32	1.0312	13	18	3	613535
1-3/16	1.1875	10	15	3	613481	1-3/64	1.0469	13	18	3	613536
1-3/16	1.1875	9	15	4	613735	1-1/16	1.0625	13	18	3	613537
1-7/32	1.2188	9	15	4	613482	1-5/64	1.0781	12	18	4	613538
1-15/64	1.2344	9	15	4	613483	1-3/32	1.0938	12	18	4	613539
1-1/4	1.2500	9	15	4	613484	1-7/64	1.1094	12	18	4	613540
1/4	0.2500	15	18	1	613485	1-1/8	1.1250	12	18	4	613541
17/64	0.2656	15	18	1	613486	1-9/64	1.1406	12	18	4	613542
9/32	0.2812	15	18	1	613487	1-5/32	1.1562	12	18	4	613543
19/64	0.2969	15	18	1	613488	1-11/64	1.1719	12	18	4	613544
5/16	0.3125	15	18	1	613489	1-3/16	1.1875	12	18	4	613545
21/64	0.3281	15	18	1	613490	1-7/32	1.2188	12	18	4	613546
11/32	0.3438	15	18	1	613491	1-15/64	1.2344	12	18	4	613547
23/64	0.3594	15	18	1	613492	1-1/4	1.2500	12	18	4	613548
3/8	0.3750	15	18	1	613493	1-17/64	1.2656	12	18	4	613549
25/64	0.3906	15	18	1	613494	1-9/32	1.2813	12	18	4	613550
13/32	0.4062	15	18	1	613495	1-5/16	1.3125	12	18	4	613551
27/64	0.4219	15	18	1	613496	1-11/32	1.3438	12	18	4	613552
7/16	0.4375	15	18	1	613497	1-23/64	1.3594	12	18	4	613553
29/64	0.4531	15	18	1	613498	1-3/8	1.3750	12	18	4	613554
15/32	0.4688	15	18	1	613499	1-13/32	1.4062	12	18	4	613555
31/64	0.4844	14	18	2	613500	1-7/16	1.4375	12	18	4	613556
1/2	0.5000	14	18	2	613501	1-15/32	1.4688	12	18	4	613557
33/64	0.5156	14	18	2	613502	1-1/2	1.5000	12	18	4	613558
17/32	0.5312	14	18	2	613503	1-9/16	1.5625	10	18	5	613559
35/64	0.5469	14	18	2	613504	1-5/8	1.6250	10	18	5	613560
9/16	0.5625	14	18	2	613505	1-11/16	1.6875	10	18	5	613561
37/64	0.5781	14	18	2	613506	1-3/4	1.7500	10	18	5	613562
19/32	0.5938	14	18	2	613507	1-13/16	1.8125	10	18	5	613563
39/64	0.6094	14	18	2	613508	1-7/8	1.8750	10	18	5	613564
5/8	0.6250	14	18	2	613509	33/64	0.5156	16	20	2	613565
41/64	0.6406	14	18	2	613510	9/16	0.5625	16	20	2	613566
21/32	0.6562	14	18	2	613511	19/32	0.5938	16	20	2	613567
43/64	0.6719	14	18	2	613512	47/64	0.7344	16	20	2	613568
11/16	0.6875	14	18	2	613513	13/16	0.8125	15	20	3	613569

Taper Shank Extra Length Drills

High Speed Steel – 118° Point (continued)



Size (Inch)	Decimal Equiv. (Inch)	Flute Length (Inch)	Overall Length (Inch)	Morse Taper	Code	Size (Inch)	Decimal Equiv. (Inch)	Flute Length (Inch)	Overall Length (Inch)	Morse Taper	Code
27/32	0.8438	15	20	3	613570	63/64	0.9844	19	24	3	613626
7/8	0.8750	15	20	3	613571	1	1.0000	19	24	3	613627
15/16	0.9375	15	20	3	613572	1-1/64	1.0156	19	24	3	613628
31/32	0.9688	15	20	3	613573	1-1/32	1.0312	19	24	3	613629
1-1/16	1.0625	15	20	3	613574	1-3/64	1.0469	19	24	3	613630
1-3/32	1.0938	14	20	4	613575	1-1/16	1.0625	19	24	3	613631
1-1/8	1.1250	14	20	4	613576	1-5/64	1.0781	18	24	4	613632
1-3/16	1.1875	14	20	4	613577	1-3/32	1.0938	18	24	4	613633
1-13/64	1.2031	14	20	4	613578	1-1/8	1.1250	18	24	4	613634
1-7/32	1.2188	14	20	4	613579	1-9/64	1.1406	18	24	4	613635
1-1/4	1.2500	14	20	4	613580	1-5/32	1.1562	18	24	4	613636
1-11/32	1.3438	14	20	4	613581	1-11/64	1.1719	18	24	4	613637
1-13/32	1.4062	14	20	4	613582	1-3/16	1.1875	18	24	4	613638
1-7/16	1.4375	14	20	4	613583	1-13/64	1.2031	18	24	4	613639
1-15/32	1.4688	14	20	4	613584	1-7/32	1.2188	18	24	4	613640
1-3/4	1.7500	13	20	5	613585	1-15/64	1.2344	18	24	4	613641
2-7/32	2.2188	13	20	5	613586	1-1/4	1.2500	18	24	4	613642
3/8	0.3750	21	24	1	613587	1-17/64	1.2656	18	24	4	613643
25/64	0.3906	21	24	1	613588	1-9/32	1.2812	18	24	4	613644
13/32	0.4062	21	24	1	613589	1-5/16	1.3125	18	24	4	613645
27/64	0.4219	21	24	1	613590	1-11/32	1.3438	18	24	4	613646
7/16	0.4375	21	24	1	613591	1-23/64	1.3594	18	24	4	613647
29/64	0.4531	21	24	1	613592	1-3/8	1.3750	18	24	4	613648
15/32	0.4688	21	24	1	613593	1-13/32	1.4062	18	24	4	613649
31/64	0.4844	20	24	2	613594	1-7/16	1.4375	18	24	4	613650
1/2	0.5000	20	24	2	613595	1-15/32	1.4688	18	24	4	613651
33/64	0.5156	20	24	2	613596	1-1/2	1.5000	18	24	4	613652
17/32	0.5312	20	24	2	613597	1-9/16	1.5625	17	24	5	613653
35/64	0.5469	20	24	2	613598	1-5/8	1.6250	17	24	5	613654
9/16	0.5625	20	24	2	613599	1-11/16	1.6875	17	24	5	613655
37/64	0.5781	20	24	2	613600	1-3/4	1.7500	17	24	5	613656
19/32	0.5938	20	24	2	613601	1-25/32	1.7812	17	24	5	613657
39/64	0.6094	20	24	2	613602	1-13/16	1.8125	17	24	5	613658
5/8	0.6250	20	24	2	613603	1-7/8	1.8750	18	24	4	613659
41/64	0.6406	20	24	2	613604	1-7/8	1.8750	17	24	5	613736
21/32	0.6562	20	24	2	613605	1-15/16	1.9375	17	24	5	613660
43/64	0.6719	20	24	2	613606	2	2.0000	18	24	4	613661
11/16	0.6875	20	24	2	613607	2	2.0000	17	24	5	613737
45/64	0.7031	20	24	2	613608	2-1/16	2.0625	17	24	5	613662
23/32	0.7188	20	24	2	613609	2-1/8	2.1250	17	24	5	613663
47/64	0.7344	20	24	2	613610	2-3/16	2.1875	17	24	5	613664
3/4	0.7500	20	24	2	613611	2-7/32	2.2188	17	24	5	613665
49/64	0.7656	20	24	2	613612	2-1/4	2.2500	17	24	5	613666
25/32	0.7812	20	24	2	613613	2-5/16	2.3125	17	24	5	613667
51/64	0.7969	19	24	3	613614	2-3/8	2.3750	17	24	5	613668
13/16	0.8125	19	24	3	613615	2-7/16	2.4375	17	24	5	613669
53/64	0.8281	19	24	3	613616	2-1/2	2.5000	17	24	5	613670
27/32	0.8438	19	24	3	613617	2-9/16	2.5625	17	24	5	613671
55/64	0.8594	19	24	3	613618	2-5/8	2.6250	17	24	5	613672
7/8	0.8750	19	24	3	613619	2-11/16	2.6875	17	24	5	613673
57/64	0.8906	19	24	3	613620	2-3/4	2.7500	17	24	5	613674
29/32	0.9062	19	24	3	613621	2-13/16	2.8125	17	24	5	613675
59/64	0.9219	19	24	3	613622	2-7/8	2.8750	17	24	5	613676
15/16	0.9375	19	24	3	613623	2-15/16	2.9375	17	24	5	613677
61/64	0.9531	19	24	3	613624	3	3.0000	17	24	5	613678
31/32	0.9688	19	24	3	613625	3/4	0.7500	26	30	2	613679

Taper Shank Extra Length Drills

High Speed Steel – 118° Point (continued)



Size (Inch)	Decimal Equiv. (Inch)	Flute Length (Inch)	Overall Length (Inch)	Morse Taper	Code	Size (Inch)	Decimal Equiv. (Inch)	Flute Length (Inch)	Overall Length (Inch)	Morse Taper	Code
13/16	0.8125	25	30	3	613680	2-7/16	2.4375	23	30	5	613706
7/8	0.8750	25	30	3	613681	2-1/2	2.5000	23	30	5	613707
15/16	0.9375	25	30	3	613682	2-5/8	2.6250	23	30	5	613708
1	1.0000	25	30	3	613683	2-3/4	2.7500	23	30	5	613709
1-1/16	1.0625	25	30	3	613684	2-7/8	2.8750	23	30	5	613710
1-1/8	1.1250	24	30	4	613685	3	3.0000	23	30	5	613711
1-3/16	1.1875	24	30	4	613686	3-1/8	3.1250	23	30	5	613712
1-1/4	1.2500	24	30	4	613687	3-1/4	3.2500	23	30	5	613713
1-5/16	1.3125	24	30	4	613688	3-3/8	3.3750	23	30	5	613714
1-3/8	1.3750	24	30	4	613689	3-1/2	3.5000	23	30	5	613715
1-7/16	1.4375	24	30	4	613690	1-1/2	1.5000	30	36	4	613716
1-1/2	1.5000	24	30	4	613691	1-3/4	1.7500	29	36	5	613717
1-9/16	1.5625	23	30	5	613692	2	2.0000	29	36	5	613718
1-5/8	1.6250	23	30	5	613693	2-1/8	2.1250	29	36	5	613719
1-11/16	1.6875	23	30	5	613694	2-1/4	2.2500	29	36	5	613720
1-3/4	1.7500	23	30	5	613695	2-3/8	2.3750	29	36	5	613721
1-13/16	1.8125	23	30	5	613696	2-1/2	2.5000	29	36	5	613722
1-7/8	1.8750	23	30	5	613697	2-5/8	2.6250	29	36	5	613723
1-15/16	1.9375	23	30	5	613698	2-3/4	2.7500	29	36	5	613724
2	2.0000	23	30	5	613699	3	3.0000	29	36	5	613725
2-1/16	2.0625	23	30	5	613700	3-1/8	3.1250	29	36	5	613726
2-1/8	2.1250	23	30	5	613701	3-1/4	3.2500	29	36	5	613727
2-3/16	2.1875	23	30	5	613702	3-3/8	3.3750	29	36	5	613728
2-1/4	2.2500	23	30	5	613703	3-1/2	3.5000	29	36	5	613729
2-5/16	2.3125	23	30	5	613704						
2-3/8	2.3750	23	30	5	613705						

Reduced Shank Drills

Silver & Deming



- 1/2" diameter shank
- 118° split point
- Milled flutes, ground lands
- Sets supplied in wooden block

Fractional Sizes – Cobalt (Gold)

Size (Inch)	Decimal Equivalent (Inch)	Code	Size (Inch)	Decimal Equivalent (Inch)	Code	Size (Inch)	Decimal Equivalent (Inch)	Code
17/32	0.5312	608900	23/32	0.7188	608906	29/32	0.9062	608912
9/16	0.5625	608901	3/4	0.7500	608907	15/16	0.9375	608913
19/32	0.5938	608902	25/32	0.7812	608908	31/32	0.9688	608914
5/8	0.6250	608903	13/16	0.8125	608909	1	1.0000	608915
21/32	0.6562	608904	27/32	0.8438	608910			
11/16	0.6875	608905	7/8	0.8750	608911			

Reduced Shank Drills

High Speed Steel & Cobalt – 1/2" Shank – Silver & Deming



- Heavy web 8% cobalt content permits use at higher speeds in hardened stainless, heat treated and high temperature alloys
- All sizes 6" overall with 3" flute length

Size	Decimal Equiv.(Inch)	1/2" Standard Shank		1/2" Shank with Flats		Size	Decimal Equiv.(Inch)	1/2" Standard Shank		1/2" Shank with Flats	
		HSS 118°	Cobalt 135° Split Point	HSS 118° Split Point	Cobalt 135° Split Point			HSS 118°	Cobalt 135° Split Point	HSS 118° Split Point	Cobalt 135° Split Point
		Code	Code	Code	Code			Code	Code	Code	Code
1/2	0.5000	608670	608916	*608734	608966	1	1.0000	751281	751350	609691	608997
33/64	0.5156	751250	608917	609660	608967	1-1/64	1.0156	608702	-	608767	-
17/32	0.5312	751251	608918	609661	608968	1-1/32	1.0312	608703	608949	608768	-
35/64	0.5469	751252	608919	609662	608969	1-3/64	1.0469	608704	-	608769	-
9/16	0.5625	751253	751351	609663	608970	1-1/16	1.0625	751282	608950	608770	-
37/64	0.5781	751254	608921	609664	608971	1-5/64	1.0781	608706	-	608771	-
19/32	0.5938	751255	608922	609665	-	1-3/32	1.0938	608707	608951	608772	-
39/64	0.6094	751256	608923	609666	608972	1-7/64	1.1094	608708	-	608773	-
5/8	0.6250	751257	751352	609667	608973	1-1/8	1.1250	751283	608952	608774	-
41/64	0.6406	751258	608925	609668	608974	1-9/64	1.1406	608710	608953	608775	-
21/32	0.6562	751259	608926	609669	608975	1-5/32	1.1562	751284	608954	608776	-
43/64	0.6719	751260	608927	609670	608976	1-11/64	1.1719	608712	-	608777	-
11/16	0.6875	751261	751353	609671	608977	1-3/16	1.1875	751285	608955	608778	-
45/64	0.7031	751262	608929	609672	608978	1-13/64	1.2031	608714	-	608779	-
23/32	0.7188	751263	608930	609673	608979	1-7/32	1.2188	608715	608956	608780	-
47/64	0.7344	751264	608931	609674	608980	1-15/64	1.2344	608716	-	608781	-
3/4	0.7500	751265	751354	609675	608981	1-1/4	1.2500	751286	608957	608782	-
49/64	0.7656	751266	608933	609676	608982	1-17/64	1.2656	608718	-	608783	-
25/32	0.7812	751267	608934	609677	608983	1-9/32	1.2812	608719	608958	608784	-
51/64	0.7969	751268	608935	609678	608984	1-19/64	1.2969	608720	-	608785	-
13/16	0.8125	751269	751355	609679	608985	1-5/16	1.3125	608721	608959	608786	-
53/64	0.8281	751270	608937	609680	608986	1-21/64	1.3281	608722	-	608787	-
27/32	0.8438	751271	608938	609681	608987	1-11/32	1.3438	608723	608960	608788	-
55/64	0.8594	751272	608939	609682	608988	1-23/64	1.3594	608724	-	608789	-
7/8	0.8750	751273	751356	609683	608989	1-3/8	1.3750	608725	608961	608790	-
57/64	0.8906	751274	608941	609684	608990	1-25/64	1.3906	608726	-	608791	-
29/32	0.9062	751275	608942	609685	608991	1-13/32	1.4062	608727	608962	608792	-
59/64	0.9219	751276	608943	609686	608992	1-27/64	1.4219	608728	-	608793	-
15/16	0.9375	751277	751357	609687	608993	1-7/16	1.4375	608729	608963	608794	608998
61/64	0.9531	751278	608945	609688	608994	1-29/64	1.4531	608730	-	608795	-
31/32	0.9688	751279	608946	609689	608995	1-15/32	1.4688	608731	608964	608796	608999
63/64	0.9844	751280	608947	609690	608996	1-31/64	1.4844	608732	-	608797	-
						1-1/2	1.5000	608733	608965	608798	609000

*Not split point

Reduced Shank Drills

High Speed Steel – 1/2" Shank – Silver & Deming – Maintenance Length – 135° Split Point



- 3 flats on shank ensures positive chucking without slippage
- Surface treated flutes
- 135° split point ensures fast hole starts without walking

Fractional Sizes

Size (Inch)	Decimal Equivalent (Inch)	Code	Size (Inch)	Decimal Equivalent (Inch)	Code	Size (Inch)	Decimal Equivalent (Inch)	Code
33/64	0.5156	751288	35/64	0.5469	751290	37/64	0.5781	751292
17/32	0.5312	751289	9/16	0.5625	751291	19/32	0.5938	751293

Reduced Shank Drills

High Speed Steel – 1/2" Shank – Silver & Deming – Maintenance Length – 135° Split Point



Fractional Sizes (continued)

Size (Inch)	Decimal Equivalent (Inch)	Code	Size (Inch)	Decimal Equivalent (Inch)	Code	Size (Inch)	Decimal Equivalent (Inch)	Code
39/64	0.6094	751294	47/64	0.7344	751302	55/64	0.8594	751309
5/8	0.6250	751295	3/4	0.7500	751303	7/8	0.8750	751310
41/64	0.6406	751296	49/64	0.7656	751304	57/64	0.8906	751311
21/32	0.6562	751297	25/32	0.7812	751305	29/32	0.9062	751312
43/64	0.6719	751298	51/64	0.7969	751306	59/64	0.9219	751313
11/16	0.6875	751299	13/16	0.8125	751307	15/16	0.9375	751314
45/64	0.703	751300	53/64	0.8281	751308	61/64	0.9531	751315
23/32	0.7188	751301	27/32	0.8438	751318	31/32	0.9688	751316
						63/64	0.9844	751317
						1	1.0000	751287

Metric – High Speed Steel – 1/2 Shank – Silver & Deming – 118° Point



Size (mm)	Decimal Equiv. (Inch)	Flute Length (Inch)	Overall Length (Inch)	Code	Size (mm)	Decimal Equiv. (Inch)	Flute Length (Inch)	Overall Length (Inch)	Code	Size (mm)	Decimal Equiv. (Inch)	Flute Length (Inch)	Overall Length (Inch)	Code
13.00	0.5118	3	6	608799	19.00	0.7480	3	6	751325	25.00	0.9843	3	6	751331
13.50	0.5315	3	6	608800	19.50	0.7677	3	6	608812	25.50	1.0039	3	6	608824
14.00	0.5512	3	6	751320	20.00	0.7874	3	6	751326	26.00	1.0236	3	6	608825
14.50	0.5709	3	6	608802	20.50	0.8071	3	6	608814	26.50	1.0433	3	6	608826
15.00	0.5906	3	6	751321	21.00	0.8268	3	6	751327	27.00	1.0630	3	6	608827
15.50	0.6102	3	6	608804	21.50	0.8465	3	6	608816	27.50	1.0827	3	6	608828
16.00	0.6299	3	6	751322	22.00	0.8661	3	6	751328	28.00	1.1024	3	6	608829
16.50	0.6496	3	6	608806	22.50	0.8858	3	6	608818	28.50	1.1220	3	6	608830
17.00	0.6693	3	6	751323	23.00	0.9055	3	6	751329	29.00	1.1417	3	6	608831
17.50	0.6890	3	6	608808	23.50	0.9252	3	6	608820	30.00	1.1811	3	6	608832
18.00	0.7087	3	6	751324	24.00	0.9449	3	6	751330	30.50	1.2008	3	6	608833
18.50	0.7283	3	6	608810	24.50	0.9646	3	6	608822	31.00	1.2205	3	6	608834

High Speed Steel – 3/8" Shank Metal Working Drills – 118° Point



Size (Inch)	Decimal Equivalent (Inch)	Code	Size (Inch)	Decimal Equivalent (Inch)	Code	Size (Inch)	Decimal Equivalent (Inch)	Code
25/64	0.3906	753117	33/64	0.5156	610940	41/64	0.6406	610944
13/32	0.4062	753118	17/32	0.5312	753125	21/32	0.6562	610945
27/64	0.4219	753119	35/64	0.5469	610941	43/64	0.6719	610946
7/16	0.4375	753120	9/16	0.5625	753126	11/16	0.6875	610947
29/64	0.4531	753121	37/64	0.5781	610942	45/64	0.7031	610948
15/32	0.4688	753122	19/32	0.5938	753127	23/32	0.7188	610949
31/64	0.4844	753123	39/64	0.6094	610943	47/64	0.7344	610950
1/2	0.5000	753124	5/8	0.6250	753128	3/4	0.7500	610951

Reduced Shank Drills

High Speed Steel – 3/4" Shank – Boring Mill & Screw Machine – 118° Point



Size (Inch)	Decimal Equiv. (Inch)	Flute Length (Inch)	Overall Length (Inch)	Code	Size (Inch)	Decimal Equiv. (Inch)	Flute Length (Inch)	Overall Length (Inch)	Code	Size (Inch)	Decimal Equiv. (Inch)	Flute Length (Inch)	Overall Length (Inch)	Code
25/32	0.7812	3	6	610900	1-7/32	1.2188	3	6	610914	1-21/32	1.6562	3	6	610928
13/16	0.8125	3	6	610901	1-1/4	1.2500	3	6	610915	1-11/16	1.6875	3	6	610929
27/32	0.8438	3	6	610902	1-9/32	1.2812	3	6	610916	1-23/32	1.7188	3	6	610930
7/8	0.8750	3	6	610903	1-5/16	1.3125	3	6	610917	1-3/4	1.7500	3	6	610931
29/32	0.9062	3	6	610904	1-11/32	1.3438	3	6	610918	1-25/32	1.7812	3	6	610932
15/16	0.9375	3	6	610905	1-3/8	1.3750	3	6	610919	1-13/16	1.8125	3	6	610933
31/32	0.9688	3	6	610906	1-13/32	1.4062	3	6	610920	1-27/32	1.8438	3	6	610934
1	1.0000	3	6	610907	1-7/16	1.4375	3	6	610921	1-7/8	1.8750	3	6	610935
1-1/32	1.0312	3	6	610908	1-15/32	1.4688	3	6	610922	1-29/32	1.9062	3	6	610936
1-1/16	1.0625	3	6	610909	1-1/2	1.5000	3	6	610923	1-15/16	1.9375	3	6	610937
1-3/32	1.0938	3	6	610910	1-17/32	1.5312	3	6	610924	1-31/32	1.9688	3	6	610938
1-1/8	1.1250	3	6	610911	1-9/16	1.5625	3	6	610925	2	2.0000	3	6	610939
1-5/32	1.1562	3	6	610912	1-19/32	1.5938	3	6	610926					
1-3/16	1.1875	3	6	610913	1-5/8	1.6250	3	6	610927					

Spade Drill Inserts

Super Cobalt (T15) – TiN Coated & TiAlN Coated



TiN Coated

TiAlN Coated

- For use with high nickel alloys and materials with hardness over 29HRC
- Custom sizes available upon request

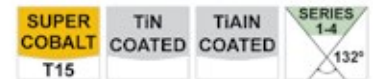

TiN COATED: Titanium Nitride reinforces the wear resistance, hardness and toughness of the tool

TiAlN COATED: Titanium Aluminum Nitride has a higher hardness than TiN which greatly increases the tool life and can withstand higher temperatures when machining cast irons and tough steels

Series Min. to Max.	Thickness	Diameter	Decimal Equivalent (Inch)	Super Cobalt (T15) TiN Coated	Super Cobalt (T15) TiAlN Coated
				Code	Code
Y 0.374" to 0.436" 9.50 mm to 11.07 mm	3/32" 2.4 mm	9.50 mm	0.3740	548345	548616
		3/8"	0.3750	548346	548617
		9.80 mm	0.3858	548347	548618
		25/64"	0.3906	548348	548619
		10 mm	0.3937	548349	548620
		10.20 mm	0.4016	548350	548621
		13/32"	0.4062	548351	548622
		10.50 mm	0.4134	548352	548623
		27/64"	0.4219	548353	548624
		10.80 mm	0.4252	548354	548625
Z 0.437" to 0.510" 11.10 mm to 12.95 mm	3/32" 2.4 mm	11 mm	0.4331	548355	548626
		7/16"	0.4375	548356	548627
		11.50 mm	0.4528	548357	548628
		29/64"	0.4531	548358	548629
		15/32"	0.4688	548359	548630
		12 mm	0.4724	548360	548631
		31/64"	0.4844	548361	548632
		12.50 mm	0.4921	548362	548633
		1/2"	0.5000	548363	548634



Spade Drill Inserts



Super Cobalt (T15) – TiN Coated & TiAlN Coated (continued)

Series Min. to Max.	Thickness	Diameter	Decimal Equivalent (Inch)	Super Cobalt (T15) TiN Coated	Super Cobalt (T15) TiAlN Coated
				Code	Code
0 0.511" to 0.695" 12.98 mm to 17.65 mm	1/8" 3.2 mm	13 mm	0.5118	548364	548490
		33/64"	0.5156	548365	548491
		17/32"	0.5312	548366	548492
		13.50 mm	0.5315	548367	548493
		35/64"	0.5469	548382	548508
		14 mm	0.5512	548368	548494
		9/16"	0.5625	548369	548495
		14.50 mm	0.5709	548370	548496
		37/64"	0.5781	548371	548497
		15 mm	0.5906	548372	548498
		19/32"	0.5938	548373	548499
		39/64"	0.6094	548383	548509
		15.50 mm	0.6102	548374	548500
		5/8"	0.6250	548375	548501
		16 mm	0.6299	548376	548502
		41/64"	0.6406	548384	548510
		16.50 mm	0.6496	548377	548503
		21/32"	0.6562	548378	548504
17 mm	0.6693	548379	548505		
43/64"	0.6719	548385	548511		
11/16"	0.6875	548380	548506		
17.50 mm	0.6890	548381	548507		
1 0.690" to 0.960" 17.53 mm to 24.38 mm	5/32" 4.0 mm	45/64"	0.7031	548386	548512
		18 mm	0.7087	548387	548513
		23/32"	0.7188	548388	548514
		18.50 mm	0.7283	548389	548515
		47/64"	0.7344	548390	548516
		19 mm	0.7480	548391	548517
		3/4"	0.7500	548392	548518
		49/64"	0.7656	548393	548519
		19.50 mm	0.7677	548394	548520
		25/32"	0.7812	548395	548521
		20 mm	0.7874	548396	548522
		51/64"	0.7969	548408	548534
		20.50 mm	0.8071	548397	548523
		13/16"	0.8125	548398	548524
		21 mm	0.8268	548399	548525
		27/32"	0.8438	548400	548526
		55/64"	0.8594	548409	548535
		22 mm	0.8661	548401	548527
		7/8"	0.8750	548402	548528
		57/64"	0.8906	548410	548536
23 mm	0.9055	548403	548529		
29/32"	0.9062	548404	548530		
59/64"	0.9219	548405	548531		
15/16"	0.9375	548406	548532		
24 mm	0.9449	548407	548533		



Spade Drill Inserts



Super Cobalt (T15) – TiN Coated & TiAlN Coated (continued)

Series Min. to Max.	Thickness	Diameter	Decimal Equivalent (Inch)	Super Cobalt (T15) TiN Coated	Super Cobalt (T15) TiAlN Coated
				Code	Code
2 0.961" to 1.380" 24.41 mm to 35.05 mm	3/16" 4.8 mm	31/32"	0.9688	548411	548537
		63/64"	0.9843	548412	548538
		1"	1.0000	548413	548539
		1-1/64"	1.0156	548414	548540
		26 mm	1.0236	548415	548541
		1-1/32"	1.0312	548416	548542
		1-3/64"	1.0469	548437	548563
		1-1/16"	1.0625	548417	548543
		27 mm	1.0630	548418	548544
		1-3/32"	1.0938	548419	548545
		28 mm	1.1024	548420	548546
		1-7/64"	1.1094	548438	548564
		1-1/8"	1.1250	548421	548547
		29 mm	1.1417	548422	548548
		1-5/32"	1.1562	548423	548549
		30 mm	1.1811	548424	548550
		1-3/16"	1.1875	548425	548551
		1-7/32"	1.2188	548426	548552
		31 mm	1.2205	548427	548553
		1-1/4"	1.2500	548428	548554
		32 mm	1.2598	548429	548555
		1-9/32"	1.2812	548430	548556
		33 mm	1.2992	548431	548557
		1-5/16"	1.3125	548432	548558
		34 mm	1.3386	548433	548559
		1-11/32"	1-3438	548434	548560
1-3/8"	1.3750	548435	548561		
35 mm	1.3780	548436	548562		
3 1.353" to 1.882" 34.36 mm to 47.80 mm	1/4" 6.4 mm	1-13/32"	1.4062	548439	548565
		36 mm	1.4173	548440	548566
		1-7/16"	1.4375	548441	548567
		37 mm	1.4567	548442	548568
		1-15/32"	1.4688	548443	548569
		38 mm	1.4961	548444	548570
		1-1/2"	1.5000	548445	548571
		1-17/32"	1.5312	548446	548572
		39 mm	1.5354	548447	548573
		1-9/16"	1.5625	548448	548574
		40 mm	1.5748	548449	548575
		1-19/32"	1.5938	548450	548576
		41 mm	1.6142	548451	548577
		1-5/8"	1.6250	548452	548578
		42 mm	1.6535	548453	548579
		1-21/32"	1.6562	548454	548580
		1-11/16"	1.6875	548455	548581
		43 mm	1.6929	548456	548582
		1-23/32"	1.7188	548457	548583
		44 mm	1.7323	548458	548584
		1-3/4"	1.7500	548459	548585
		45 mm	1.7717	548460	548586
		1-25/32"	1.7812	548461	548587
		46 mm	1.8110	548462	548588
		1-13/16"	1.8125	548463	548589
		1-27/32"	1.8438	548464	548590
47 mm	1.8504	548465	548591		
1-7/8"	1.8750	548466	548592		



Spade Drill Inserts



Super Cobalt (T15) – TiN Coated & TiAlN Coated (continued)

Series Min. to Max.	Thickness	Diameter	Decimal Equivalent (Inch)	Super Cobalt (T15) TiN Coated	Super Cobalt (T15) TiAlN Coated
				Code	Code
4 1.850" to 2.570" 46.99 mm to 65.28 mm	5/16" 8.0 mm	1-29/32"	1.9062	548467	548593
		1-15/16"	1.9375	548468	548594
		1-31/32"	1.9688	548469	548595
		2"	2.0000	548470	548596
		2-1/32"	2.0312	548471	548597
		2-3/64"	2.0472	548472	548598
		2-1/16"	2.0625	548473	548599
		2-3/32"	2.0938	548474	548600
		2-1/8"	2.1250	548475	548601
		2-5/32"	2.1562	548476	548602
		2-3/16"	2.1875	548477	548603
		2-7/32"	2.2188	548478	548604
		2-1/4"	2.2500	548479	548605
		2-9/32"	2.2812	548480	548606
		2-5/16"	2.3125	548481	548607
		2-11/32"	2.3438	548482	548608
		2-3/8"	2.3750	548483	548609
		2-13/32"	2.4062	548484	548610
		2-7/16"	2.4375	548485	548611
		2-15/32"	2.4688	548486	548612
2-1/2"	2.5000	548487	548613		
2-17/32"	2.5312	548488	548614		
2-9/16"	2.5625	548489	548615		

High Speed Steel (M4) – TiN Coated & TiAlN Coated



- For use with steels and cast irons
- Custom sizes available upon request



TiN COATED: Titanium Nitride reinforces the wear resistance, hardness and toughness of the tool

TiAlN COATED: Titanium Aluminum Nitride has a higher hardness than TiN which greatly increases the tool life and can withstand higher temperatures when machining cast irons and tough steels

Series Min. to Max.	Thickness	Diameter	Decimal Equivalent (Inch)	HSS (M4) TiN Coated	HSS (M4) TiAlN Coated
				Code	Code
1 0.690" to 0.960" 17.53 mm to 24.38 mm (continued on next page)	5/32" 4.0 mm	45/64"	0.7031	548000	548134
		18 mm	0.7087	548001	548135
		23/32"	0.7188	548002	548136
		18.50 mm	0.7283	548003	548137
		47/64"	0.7344	548004	548138
		19 mm	0.7480	548005	548139
		3/4"	0.7500	548006	548140
		49/64"	0.7656	548007	548141
		19.50 mm	0.7677	548008	548142
		25/32"	0.7812	548009	548143
		20 mm	0.7874	548010	548144
		51/64"	0.7969	548022	548156
		20.50 mm	0.8071	548011	548145
		13/16"	0.8125	548012	548146



Spade Drill Inserts

High Speed Steel (M4) – TiN Coated & TiAlN Coated (continued)



Series Min. to Max.	Thickness	Diameter	Decimal Equivalent (Inch)	HSS (M4) TiN Coated	HSS (M4) TiAlN Coated
				Code	Code
(continued) 1 0.690" to 0.960" 17.53 mm to 24.38 mm	5/32" 4.0 mm	21 mm	0.8268	548013	548147
		27/32"	0.8438	548014	548148
		55/64"	0.8594	548023	548157
		22 mm	0.8661	548015	548149
		7/8"	0.8750	548016	548150
		57/64"	0.8906	548024	548158
		23 mm	0.9055	548017	548151
		29/32"	0.9062	548018	548152
		59/64"	0.9219	548019	548153
		15/16"	0.9375	548020	548154
24 mm	0.9449	548021	548155		
2 0.961" to 1.380" 24.41 mm to 35.05 mm	3/16" 4.8 mm	31/32"	0.9688	548025	548159
		63/64"	0.9843	548026	548160
		1"	1.0000	548027	548161
		1-1/64"	1.0156	548028	548162
		26 mm	1.0236	548029	548163
		1-1/32"	1.0312	548030	548164
		1-3/64"	1.0469	548051	548185
		1-1/16"	1.0625	548031	548165
		27 mm	1.0630	548032	548166
		1-3/32"	1.0938	548033	548167
		28 mm	1.1024	548034	548168
		1-7/64"	1.1094	548052	548186
		1-1/8"	1.1250	548035	548169
		29 mm	1.1417	548036	548170
		1-5/32"	1.1562	548037	548171
		30 mm	1.1811	548038	548172
		1-3/16"	1.1875	548039	548173
		1-7/32"	1.2188	548040	548174
		31 mm	1.2205	548041	548175
		1-1/4"	1.2500	548042	548176
32 mm	1.2598	548043	548177		
1-9/32"	1.2812	548044	548178		
33 mm	1.2992	548045	548179		
1-5/16"	1.3125	548046	548180		
34 mm	1.3386	548047	548181		
1-11/32"	1.3438	548048	548182		
1-3/8"	1.3750	548049	548183		
35 mm	1.3780	548050	548184		
3 1.353" to 1.882" 34.36 mm to 47.80 mm <i>(continued on next page)</i>	1/4" 6.4 mm	1-13/32"	1.4062	548053	548187
		36 mm	1.4173	548054	548188
		1-7/16"	1.4375	548055	548189
		37 mm	1.4567	548056	548190
		1-15/32"	1.4688	548057	548191
		38 mm	1.4961	548058	548192
		1-1/2"	1.5000	548059	548193
		1-17/32"	1.5312	548060	548194
		39 mm	1.5354	548061	548195
		1-9/16"	1.5625	548062	548196
		40 mm	1.5748	548063	548197
		1-19/32"	1.5938	548064	548198
		41 mm	1.6142	548065	548199
1-5/8"	1.6250	548066	548200		



Spade Drill Inserts



High Speed Steel (M4) – TiN Coated & TiAlN Coated (continued)

Series Min. to Max.	Thickness	Diameter	Decimal Equivalent (Inch)	HSS (M4) TiN Coated	HSS (M4) TiAlN Coated
				Code	Code
<i>(continued)</i> 3 1.353" to 1.882" 34.36 mm to 47.80 mm	1/4" 6.4 mm	42 mm	1.6535	548067	548201
		1-21/32"	1.6563	548068	548202
		1-11/16"	1.6875	548069	548203
		43 mm	1.6929	548070	548204
		1-23/32"	1.7188	548071	548205
		44 mm	1.7323	548072	548206
		1-3/4"	1.7500	548073	548207
		45 mm	1.7717	548074	548208
		1-25/32"	1.7812	548075	548209
		46 mm	1.8110	548076	548210
		1-13/16"	1.8125	548077	548211
		1-27/32"	1.8438	548078	548212
		47 mm	1.8504	548079	548213
		1-7/8"	1.8750	548080	548214
		4 1.850" to 2.570" 46.99 mm to 65.28 mm	5/16" 8.0 mm	1-29/32"	1.9063
1-15/16"	1.9375			548082	548216
1-31/32"	1.9688			548083	548217
2"	2.0000			548084	548218
2-1/32"	2.0313			548085	548219
2-3/64"	2.0472			548086	548220
2-1/16"	2.0625			548087	548221
2-3/32"	2.0938			548088	548222
2-1/8"	2.1250			548089	548223
2-5/32"	2.1563			548090	548224
2-3/16"	2.1875			548091	548225
2-7/32"	2.2188			548092	548226
2-1/4"	2.2500			548093	548227
2-9/32"	2.2813			548094	548228
2-5/16"	2.3125			548095	548229
2-11/32"	2.3438			548096	548230
2-3/8"	2.3750			548097	548231
2-13/32"	2.4063			548098	548232
2-7/16"	2.4375			548099	548233
2-15/32"	2.4688			548100	548234
2-1/2"	2.5000	548101	548235		
2-17/32"	2.5313	548102	548236		
2-9/16"	2.5625	548103	548237		
5 2.456" to 3.000" 62.38 mm to 76.20 mm	7/16" 11.1 mm	2-1/2"	2.5000	548104	TiAlN Available Upon Request
		2-5/8"	2.6250	548105	
		2-3/4"	2.7500	548106	
		2-25/32"	2.7813	548107	
		2-13/16"	2.8125	548108	
		2-27/32"	2.8438	548109	
		2-7/8"	2.8750	548110	
		2-29/32"	2.9063	548111	
		2-15/16"	2.9375	548112	
		2-31/32"	2.9688	548113	
3"	3.0000	548114			
6 3.001" to 3.507" 76.23 mm to 89.08 mm	7/16" 11.1 mm	3-1/32"	3.0313	548115	TiAlN Available Upon Request
		3-1/16"	3.0625	548116	
		3-3/32"	3.0938	548117	
		3-1/8"	3.1250	548118	
		3-1/4"	3.2500	548119	
		3-3/8"	3.3750	548120	
		3-7/16"	3.4375	548121	
3-1/2"	3.5000	548122			



Spade Drill Inserts

High Speed Steel (M4) – TiN Coated & TiAlN Coated (continued)



Series Min. to Max.	Thickness	Diameter	Decimal Equivalent (Inch)	HSS (M4) TiN Coated	HSS (M4) TiAlN Coated
				Code	Code
7 3.455" to 4.000" 87.76 mm to 101.60 mm	7/16" 11.1 mm	3-9/16"	3.5625	548123	TiAlN Available Upon Request
		3-5/8"	3.6250	548124	
		3-3/4"	3.7500	548125	
		3-7/8"	3.8750	548126	TiAlN Available Upon Request
		3-15/16"	3.9375	548127	
		4"	4.0000	548128	
8 4.001" to 4.507" 101.63 mm to 114.48 mm	7/16" 11.1 mm	4-1/16"	4.0625	548129	TiAlN Available Upon Request
		4-1/8"	4.1250	548130	
		4-1/4"	4.2500	548131	
		4-3/8"	4.3750	548132	
		4-1/2"	4.5000	548133	

Rotary Coolant Inducers (RCI) & Accessories

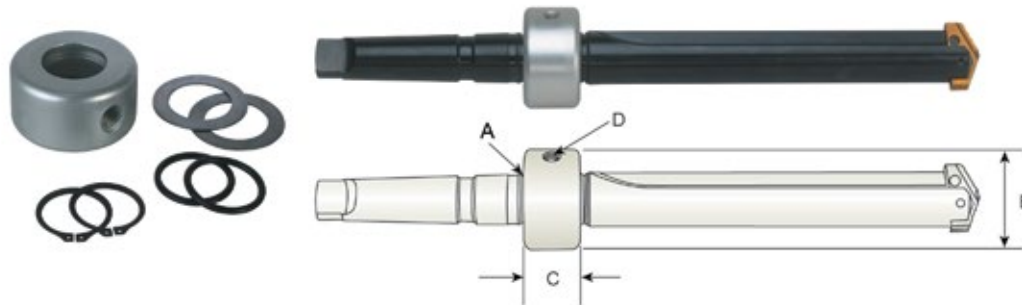

A Inside Diameter (Inch)	B Outside Diameter (Inch)	C Height (Inch)	D Coolant Hole Thread Size (NPT)	Thread for Driving Rod	Code
3/4	1-3/4	7/8	1/8	5/16-18 - NC	549625
1	2-1/8	1-1/8	1/8	5/16-18 - NC	549626
1-1/4	2-1/2	1-3/8	1/4	3/8-16 - NC	549627
1-3/4	3	1-3/8	1/4	3/8-16 - NC	549628
2-1/4	3-3/4	1-3/4	1/2	1/2-13 - NC	549629

Short Length – Straight Shank – Straight Flute

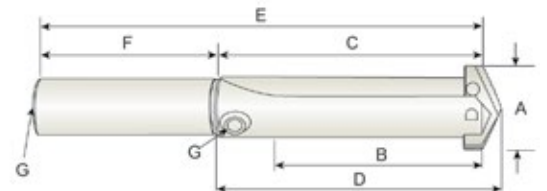

Series	Shank Diameter (Inch)	A Drill Insert Range (Inch)	B Maximum Drill Depth (Inch)	C Flute Length (Inch)	D Reference Length (Inch)	E Overall Length (Inch)	F Shank Length (Inch)	G Coolant Hole Thread Size (NPT)	Code
Y	3/4	3/8 – 27/64	1-1/4	2-1/32	2-1/8	4-13/32	2-3/8	1/8	549580
Z	3/4	7/16 – 1/2	1-1/4	2-1/32	2-1/8	4-13/32	2-3/8	1/8	549581
0	3/4	33/64 – 11/16	1-3/8	2-3/16	2-19/64	4-9/16	2-3/8	1/8	549564
0.5	3/4	39/64 – 11/16	1-3/8	2-3/16	2-19/64	4-9/16	2-3/8	1/8	549565
1	3/4	45/64 – 15/16	2-5/8	3-7/8	4-1/64	6-7/8	3	1/8	549566
1	1	45/64 – 15/16	2-5/8	3-7/8	4-1/64	6-7/8	3	1/8	549567

Spade Drill Holders



Short Length – Straight Shank – Straight Flute (continued)

Series	Shank Diameter (Inch)	A Drill Insert Range (Inch)	B Maximum Drill Depth (Inch)	C Flute Length (Inch)	D Reference Length (Inch)	E Overall Length (Inch)	F Shank Length (Inch)	G Coolant Hole Thread Size (NPT)	Code
1.5	3/4	55/64 – 15/16	2-5/8	3-7/8	4-1/64	6-7/8	3	1/8	549568
1.5	1	55/64 – 15/16	2-5/8	3-7/8	4-1/64	6-7/8	3	1/8	549569
2	1	31/32 – 1-3/8	3-3/8	4-1/2	4-41/64	8	3-1/2	1/8	549570
2	1-1/4	31/32 – 1-3/8	3-3/8	4-1/2	4-41/64	8	3-1/2	1/8	549571
2.5	1	1-3/16 – 1-3/8	3-3/8	4-1/2	4-41/64	8	3-1/2	1/8	549572
2.5	1-1/4	1-3/16 – 1-3/8	3-3/8	4-1/2	4-41/64	8	3-1/2	1/8	549573
3	1-1/4	1-13/32 – 1-7/8	4-3/4	6	6-3/16	10	4	1/4	549574
3	1-1/2	1-13/32 – 1-7/8	4-3/4	6	6-3/16	10	4	1/4	549575
4	1-1/2	1-29/32 – 2-9/16	5-1/8	6-1/2	6-11/16	10-1/2	4	1/4	549576
4	1-3/4	1-29/32 – 2-9/16	5-1/8	6-1/2	6-11/16	10-1/2	4	1/4	549577
5-6	2	2-1/2 – 3-1/2	6-3/4	8-1/2	8-3/4	12-1/2	4	1/2	549578
7-8	3	3-17/32 – 4-1/2	6-3/4	8-7/8	9-1/8	13-7/8	5	1/2	549579

Intermediate Length – Straight Shank – Straight Flute

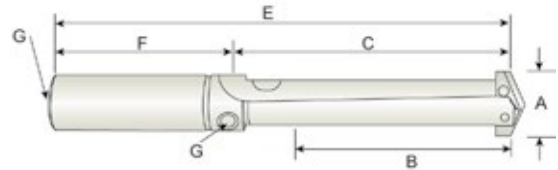

Series	Shank Diameter (Inch)	A Drill Insert Range (Inch)	B Maximum Drill Depth (Inch)	C Flute Length (Inch)	E Overall Length (Inch)	F Shank Length (Inch)	G Coolant Hole Thread Size (NPT)	Code
1	1	45/64 – 15/16	4-5/8	5-7/8	8-7/8	3	1/8	549582
1.5	1	55/64 – 15/16	4-5/8	5-7/8	8-7/8	3	1/8	549583
2	1-1/4	31/32 – 1-3/8	5-3/8	6-1/2	10	3-1/2	1/8	549584
2.5	1-1/4	1-3/16 – 1-3/8	5-3/8	6-1/2	10	3-1/2	1/8	549585
3	1-1/2	1-13/32 – 1-7/8	6-1/2	7-3/4	11-3/4	4	1/4	549586

Standard Length – Straight Shank – Straight Flute

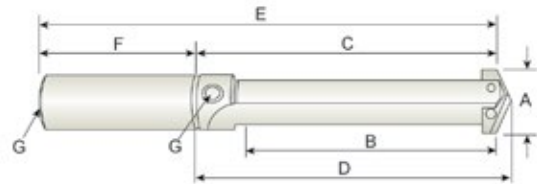

Series	Shank Diameter (Inch)	A Drill Insert Range (Inch)	B Maximum Drill Depth (Inch)	C Flute Length (Inch)	D Reference Length (Inch)	E Overall Length (Inch)	F Shank Length (Inch)	G Coolant Hole Thread Size (NPT)	Code
Y	3/4	3/8 – 27/64	2-3/8	3-5/32	3-1/4	5-17/32	2-3/8	1/8	549603
Z	3/4	7/16 – 1/2	2-3/8	3-5/32	3-1/4	5-17/32	2-3/8	1/8	549604
0	3/4	33/64 – 11/16	2-1/2	3-5/16	3-27/64	5-11/16	2-3/8	1/8	549587
0.5	3/4	39/64 – 11/16	2-1/2	3-5/16	3-27/64	5-11/16	2-3/8	1/8	549588
1	3/4	45/64 – 15/16	6-5/8	7-7/8	8-1/64	10-7/8	3	1/8	549589
1	1	45/64 – 15/16	6-5/8	7-7/8	8-1/64	10-7/8	3	1/8	549590
1.5	3/4	55/64 – 15/16	6-5/8	7-7/8	8-1/64	10-7/8	3	1/8	549591
1.5	1	55/64 – 15/16	6-5/8	7-7/8	8-1/64	10-7/8	3	1/8	549592
2	1	31/32 – 1-3/8	7-3/8	8-1/2	8-41/64	12	3-1/2	1/8	549593
2	1-1/4	31/32 – 1-3/8	7-3/8	8-1/2	8-41/64	12	3-1/2	1/8	549594



Spade Drill Holders

Standard Length – Straight Shank – Straight Flute (continued)

Series	Shank Diameter (Inch)	A Drill Insert Range (Inch)	B Maximum Drill Depth (Inch)	C Flute Length (Inch)	D Reference Length (Inch)	E Overall Length (Inch)	F Shank Length (Inch)	G Coolant Hole Thread Size (NPT)	Code
2.5	1	1-3/16 – 1-3/8	7-3/8	8-1/2	8-41/64	12	3-1/2	1/8	549595
2.5	1-1/4	1-3/16 – 1-3/8	7-3/8	8-1/2	8-41/64	12	3-1/2	1/8	549596
3	1-1/4	1-13/32 – 1-7/8	8-1/4	9-1/2	9-11/16	13-1/2	4	1/4	549597
3	1-1/2	1-13/32 – 1-7/8	8-1/4	9-1/2	9-11/16	13-1/2	4	1/4	549598
4	1-1/2	1-29/32 – 2-9/16	9-1/8	10-1/2	10-11/16	14-1/2	4	1/4	549599
4	1-3/4	1-29/32 – 2-9/16	9-1/8	10-1/2	10-11/16	14-1/2	4	1/4	549600
5-6	2	2-1/2 – 3-1/2	10-3/4	12-1/2	12-3/4	16-1/2	4	1/2	549601
7-8	3	3-17/32 – 4-1/2	10-3/4	12-7/8	13-1/8	17-7/8	5	1/2	549602

Extended Length – Straight Shank – Straight Flute

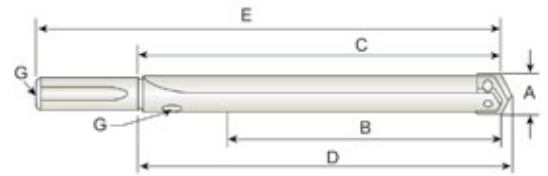

Series	Shank Diameter (Inch)	A Drill Insert Range (Inch)	B Maximum Drill Depth (Inch)	C Flute Length (Inch)	D Reference Length (Inch)	E Overall Length (Inch)	F Shank Length (Inch)	G Coolant Hole Thread Size (NPT)	Code
Y	3/4	3/8 – 27/64	4-3/8	5-5/32	5-1/4	7-17/32	2-3/8	1/8	549615
Z	3/4	7/16 – 1/2	4-3/8	5-5/32	5-1/4	7-17/32	2-3/8	1/8	549616
0	3/4	33/64 – 11/16	4-1/2	5-5/16	5-27/64	7-11/16	2-3/8	1/8	549605
0.5	3/4	39/64 – 11/16	4-1/2	5-5/16	5-27/64	7-11/16	2-3/8	1/8	549606
1	1	45/64 – 15/16	10-5/8	11-7/8	12-1/64	14-7/8	3	1/8	549607
1.5	1	55/64 – 15/16	10-5/8	11-7/8	12-1/64	14-7/8	3	1/8	549608
2	1-1/4	31/32 – 1-3/8	11-3/8	12-1/2	12-41/64	16	3-1/2	1/8	549609
2.5	1-1/4	1-3/16 – 1-3/8	11-3/8	12-1/2	12-41/64	16	3-1/2	1/8	549610
3	1-1/4	1-13/32 – 1-7/8	13-3/4	15	15-3/16	19	4	1/4	549611
4	1-1/2	1-29/32 – 2-9/16	16-5/8	18	18-3/16	22	4	1/4	549612
5	2	2-1/2 – 3-1/2	18-1/4	20	20-1/4	24	4	1/2	549613
7	3	3-17/32 – 4-1/2	21-7/8	24	24-1/4	29	5	1/2	549614

Long Length – Straight Shank – Straight Flute

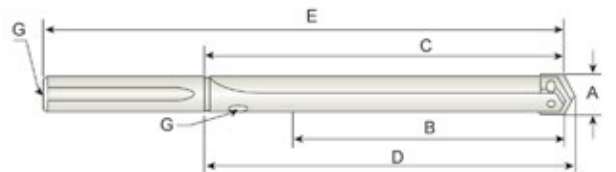

Series	Shank Diameter (Inch)	A Drill Insert Range (Inch)	B Maximum Drill Depth (Inch)	C Flute Length (Inch)	D Reference Length (Inch)	E Overall Length (Inch)	F Shank Length (Inch)	G Coolant Hole Thread Size (NPT)	Code
0	3/4	33/64 – 11/16	7	7-13/16	7-59/64	10-3/16	2-3/8	1/8	549617
0.5	3/4	39/64 – 11/16	7	7-13/16	7-59/64	10-3/16	2-3/8	1/8	549618

Spade Drill Holders



Extra Long Length – Straight Shank – Straight Flute



Series	Shank Diameter (Inch)	A Drill Insert Range (Inch)	B Maximum Drill Depth (Inch)	C Flute Length (Inch)	D Reference Length (Inch)	E Overall Length (Inch)	F Shank Length (Inch)	G Coolant Hole Thread Size (NPT)	Code
1	1	45/64 – 15/16	18	19-1/4	19-25/64	22-1/4	3	1/8	549619
2	1-1/4	31/32 – 1-3/8	20-1/8	21-1/4	21-25/64	24-3/4	3-1/2	1/8	549620
3	1-1/2	1-13/32 – 1-7/8	22	23-1/4	23-7/16	27-1/4	4	1/4	549621
4	1-1/2	1-29/32 – 2-9/16	24-5/8	26	26-3/16	30	4	1/4	549622
5	2	2-1/2 – 3-1/2	26	27-3/4	28	31-3/4	4	1/2	549623
7	3	3-17/32 – 4-1/2	27	29-1/8	29-3/8	34-1/8	5	1/2	549624

Short Length – Taper Shank – Straight Flute

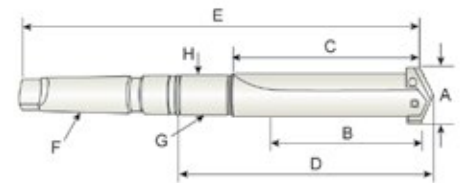

Series	F Morse Taper	A Drill Insert Range (Inch)	B Maximum Drill Depth (Inch)	C Flute Length (Inch)	D Reference Length (Inch)	E Overall Length (Inch)	G Coolant Hole Thread Size (NPT)	H Rotary Coolant Inducer Reference	Code
Y	2	3/8 – 27/64	1-1/4	2-1/32	3-15/32	6-5/16	1/16	549625	549540
Z	2	7/16 – 1/2	1-1/4	2-1/32	3-15/32	6-5/16	1/16	549625	549541
0	2	33/64 – 11/16	1-3/8	2-3/16	3-41/64	6-15/32	1/16	549625	549524
0.5	2	39/64 – 11/16	1-3/8	2-3/16	3-41/64	6-15/32	1/16	549625	549525
1	3	45/64 – 15/16	2-3/4	3-7/8	5-39/64	9-5/32	1/8	549626	549526
1	4	45/64 – 15/16	2-3/4	3-7/8	5-43/64	10-5/32	1/8	549626	549527
1.5	3	55/64 – 15/16	2-3/4	3-7/8	5-39/64	9-5/32	1/8	549626	549528
1.5	4	55/64 – 15/16	2-3/4	3-7/8	5-43/64	10-5/32	1/8	549626	549529
2	3	31/32 – 1-3/8	3-3/8	4-1/2	6-15/64	9-25/32	1/8	549626	549530
2	4	31/32 – 1-3/8	3-3/8	4-1/2	6-19/64	10-25/32	1/8	549626	549531
2.5	3	1-3/16 – 1-3/8	3-3/8	4-1/2	6-15/64	9-25/32	1/8	549626	549532
2.5	4	1-3/16 – 1-3/8	3-3/8	4-1/2	6-37/64	11-1/16	1/4	549627	549533
3	4	1-13/32 – 1-7/8	4-3/4	6	8-1/8	12-9/16	1/4	549627	549534
3	5	1-13/32 – 1-7/8	4-3/4	6	8-1/8	13-13/16	1/4	549628	549535
4	4	1-29/32 – 2-9/16	5-1/8	6-1/2	8-5/8	13-1/16	1/4	549627	549536
4	5	1-29/32 – 2-9/16	5-1/8	6-1/2	8-5/8	14-5/16	1/4	549628	549537
5-6	5	2-1/2 – 3-1/2	6-3/4	8-1/2	11-5/16	16-15/16	1/2	549629	549538
7-8	5	3-17/32 – 4-1/2	6-3/4	8-7/8	11-11/16	17-5/16	1/2	549629	549539



Spade Drill Holders

Intermediate Length – Taper Shank – Helical Flute

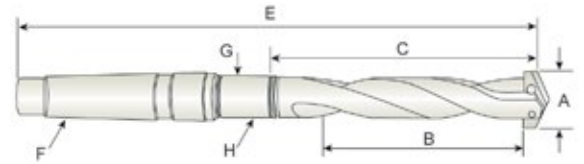

Series	F Morse Taper	A Drill Insert Range (Inch)	B Maximum Drill Depth (Inch)	C Flute Length (Inch)	E Overall Length (Inch)	G Coolant Hole Thread Size (NPT)	H Rotary Coolant Inducer Reference	Code
1	3	45/64 – 15/16	4-3/4	5-7/8	11-5/32	1/8	549626	549560
1.5	3	55/64 – 15/16	4-3/4	5-7/8	11-5/32	1/8	549626	549561
2	4	31/32 – 1-3/8	5-3/8	6-1/2	12-25/32	1/8	549626	549562
2.5	4	1-3/16 – 1-3/8	5-3/8	6-1/2	13-1/16	1/4	549627	549563

Standard Length – Taper Shank – Straight Flute

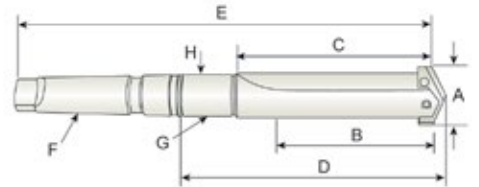

Series	F Morse Taper	A Drill Insert Range (Inch)	B Maximum Drill Depth (Inch)	C Flute Length (Inch)	D Reference Length (Inch)	E Overall Length (Inch)	G Coolant Hole Thread Size (NPT)	H Rotary Coolant Inducer Reference	Code
Y	2	3/8 – 27/64	2-3/8	3-5/32	4-19/32	7-7/16	1/16	549625	549558
Z	2	7/16 – 1/2	2-3/8	3-5/32	4-19/32	7-7/16	1/16	549625	549559
0	2	33/64 – 11/16	2-1/2	3-5/16	4-49/64	7-19/32	1/16	549625	549542
0.5	2	39/64 – 11/16	2-1/2	3-5/16	4-49/64	7-19/32	1/16	549625	549543
1	3	45/64 – 15/16	6-3/4	7-7/8	9-39/64	13-5/32	1/8	549626	549544
1	4	45/64 – 15/16	6-3/4	7-7/8	9-43/64	14-5/32	1/8	549626	549545
1.5	3	55/64 – 15/16	6-3/4	7-7/8	9-39/64	13-5/32	1/8	549626	549546
1.5	4	55/64 – 15/16	6-3/4	7-7/8	9-43/64	14-5/32	1/8	549626	549547
2	3	31/32 – 1-3/8	7-3/8	8-1/2	10-15/64	13-25/32	1/8	549626	549548
2	4	31/32 – 1-3/8	7-3/8	8-1/2	10-19/64	14-25/32	1/8	549626	549549
2.5	3	1-3/16 – 1-3/8	7-3/8	8-1/2	10-15/64	13-25/32	1/8	549626	549550
2.5	4	1-3/16 – 1-3/8	7-3/8	8-1/2	10-37/64	15-1/16	1/4	549627	549551
3	4	1-13/32 – 1-7/8	8-1/4	9-1/2	11-5/8	16-1/16	1/4	549627	549552
3	5	1-13/32 – 1-7/8	8-1/4	9-1/2	11-5/8	17-5/16	1/4	549628	549553
4	4	1-29/32 – 2-9/16	9-1/8	10-1/2	12-5/8	17-1/16	1/4	549627	549554
4	5	1-29/32 – 2-9/16	9-1/8	10-1/2	12-5/8	18-5/16	1/4	549628	549555
5-6	5	2-1/2 – 3-1/2	10-3/4	12-1/2	15-5/16	20-15/16	1/2	549629	549556
7-8	5	3-17/32 – 4-1/2	10-3/4	12-7/8	15-11/16	21-5/16	1/2	549629	549557

Replacement Screws



Torx® Screws

Series	Torx® Size	Torque (lbs)	Code
Y	T7	5.5	549506
Z	T7	5.5	549508
0	T8	11.0	549510
0.5	T8	11.0	549512
1	T9	20.0	549514
1.5	T9	20.0	549516
2-2.5	T15	45.0	549518
3-4	T20	90.0	549520
5-8	T25	155.0	549522

Nylon Locking Torx® Screws

Series	Torx® Size	Torque (lbs)	Code
Y	T7	5.5	549507
Z	T7	5.5	549509
0	T8	11.0	549511
0.5	T8	11.0	549513
1	T9	20.0	549515
1.5	T9	20.0	549517
2-2.5	T15	45.0	549519
3-4	T20	90.0	549521
5-8	T25	155.0	549523

TORX® Screwdrivers on page 476

Spade Drill Insert Technical Information

High Speed Steel



Toughness Values

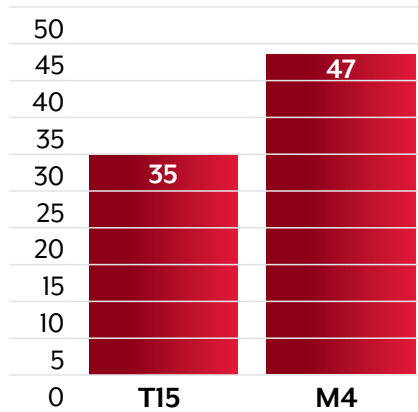

Wear Values

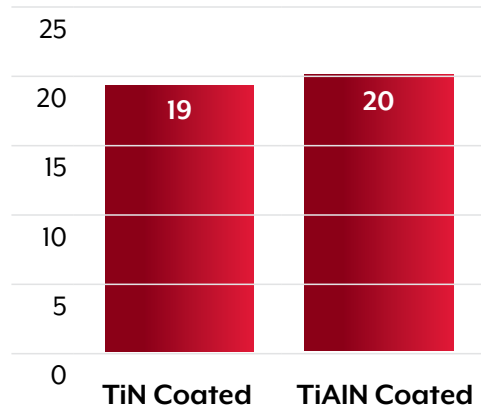

WHEN TO USE M4

- | Worn machines
- | Manual machines
- | If T-15 breaks
- | Cross hole drilling

WHEN TO USE T15

- | On CNC machines
- | When M-4 life needs to be extended
- | Abrasive drilling

Speeds & Feeds Recommendations

Material	Material Hardness (HRC)	SFM Surface Footage	Feed (Inch per Revolution)						
			3/8" to 1/2"	33/64" to 11/16"	45/64" to 15/16"	31/32" to 1-3/8"	1-13/32" to 1-7/8"	1-29/32" to 2-9/16"	2-19/32" to 4-1/2"
Free Machining Steel 1118, 1215, 12L14, etc.	-	280	0.007	0.010	0.013	0.016	0.020	0.023	0.028
	<12	260	0.007	0.010	0.013	0.016	0.020	0.023	0.028
	12-25	240	0.007	0.010	0.013	0.016	0.020	0.023	0.028
Low and Medium Carbon Steel 1018, 1040, 1140, etc.	<7	240	0.006	0.009	0.012	0.015	0.019	0.023	0.027
	7-20	225	0.005	0.008	0.010	0.014	0.018	0.021	0.024
	20-29	210	0.005	0.008	0.010	0.014	0.018	0.021	0.024
	29-35	195	0.004	0.007	0.009	0.012	0.016	0.019	0.022
Alloy Steel 4140, 5140, 8640, etc.	<7	210	0.006	0.008	0.010	0.014	0.017	0.019	0.220
	7-20	195	0.005	0.008	0.010	0.014	0.017	0.019	0.220
	20-29	180	0.005	0.007	0.010	0.014	0.017	0.019	0.220
	29-35	170	0.004	0.006	0.009	0.012	0.015	0.017	0.200
	35-40	155	0.003	0.006	0.009	0.012	0.015	0.017	0.200
High Strength Alloy Steel 4340, 4330V, 300M, etc.	20-32	110	0.005	0.007	0.009	0.010	0.014	0.017	0.020
	32-37	85	0.004	0.007	0.009	0.010	0.014	0.017	0.020
	37-43	70	0.003	0.006	0.008	0.009	0.012	0.015	0.018
Structural Steel A36, A285, A516, etc.	-	200	0.006	0.010	0.012	0.014	0.018	0.021	0.026
	12-25	170	0.005	0.009	0.010	0.012	0.016	0.019	0.024
	37-43	140	0.004	0.008	0.009	0.010	0.014	0.017	0.020
High Temperature Alloy Hastelloy B, Inconel 600, etc.	<18	40	0.003	0.006	0.007	0.008	0.010	0.012	0.015
	18-32	35	0.003	0.006	0.007	0.008	0.010	0.012	0.015
Stainless Steel 303, 416, 420, 17-4 PH, etc.	<7	105	0.006	0.008	0.009	0.011	0.014	0.016	0.020
	7-29	90	0.005	0.007	0.008	0.010	0.012	0.014	0.018
Tool Steel H-13, H021, A04, O-2, S-3, etc.	<12	110	0.004	0.006	0.008	0.010	0.012	0.015	0.017
	12-25	90	0.004	0.006	0.008	0.010	0.012	0.015	0.017
Aluminum	<6	850	0.008	0.013	0.016	0.020	0.022	0.025	0.025
	-	450	0.008	0.013	0.016	0.018	0.022	0.025	0.025
Cast Iron Gray, Ductile, Nodular	-	250	0.007	0.012	0.016	0.020	0.024	0.027	0.030
	<12	225	0.006	0.011	0.014	0.018	0.022	0.025	0.028
	12-18	195	0.006	0.009	0.012	0.016	0.018	0.021	0.024
	18-26	165	0.005	0.007	0.009	0.012	0.014	0.017	0.020
	26-32	135	0.004	0.006	0.007	0.009	0.012	0.014	0.016

Formulas:

- IPM = RPM x IPR
- SFM = RPM x 0.262 x DIA
- RPM = SFM x 3.82 ÷ DIA

- IPM = Inch per Minute (feed rate)
- SFM = Surface Feet per Minute
- RPM = Revolutions per Minute
- DIA = Drill Diameter (inch)
- IPR = Inch per Revolution (feed rate)

Core Drills

High Speed Steel – Taper Shank – 4 Flute



- Used to enlarge and straighten cored or drilled holes
- Because of their rigidity, these drills generate closer tolerance holes and better finish than standard drills
- Used to enlarge holes up to 40% smaller than the drill diameter

Size (Inch)	Decimal Equiv. (Inch)	Flute Length (Inch)	Overall Length (Inch)	Morse Taper	Code	Size (Inch)	Decimal Equiv. (Inch)	Flute Length (Inch)	Overall Length (Inch)	Morse Taper	Code
9/32	0.2812	3	6-1/4	1	612511	1-17/64	1.2656	8-1/2	14-1/8	4	612559
3/8	0.3750	3-1/2	6-3/4	1	612512	1-9/32	1.2812	8-1/2	14-1/8	4	612560
13/32	0.4062	3-5/8	7	1	612513	1-5/16	1.3125	8-5/8	14-1/4	4	612561
7/16	0.4375	3-7/8	7-1/4	1	612514	1-11/32	1.3438	8-3/4	14-3/8	4	612562
15/32	0.4688	4-1/8	7-1/2	1	612515	1-3/8	1.3750	8-7/8	14-1/2	4	612563
31/64	0.4844	4-3/8	8-1/4	2	612516	1-13/32	1.4062	9	14-5/8	4	612564
1/2	0.5000	4-3/8	8-1/4	2	612517	1-7/16	1.4375	9-1/8	14-3/4	4	612565
33/64	0.5156	4-5/8	8-1/2	2	612518	1-15/32	1.4688	9-1/4	14-7/8	4	612566
17/32	0.5312	4-5/8	8-1/2	2	612519	1-1/2	1.5000	9-3/8	15	4	612567
35/64	0.5469	4-7/8	8-3/4	2	612520	1-17/32	1.5312	9-3/8	16-3/8	5	612568
9/16	0.5625	4-7/8	8-3/4	2	612521	1-35/64	1.5469	9-5/8	16-5/8	5	612569
37/64	0.5781	4-7/8	8-3/4	2	612522	1-9/16	1.5625	9-5/8	16-5/8	5	612570
19/32	0.5938	4-7/8	8-3/4	2	612523	1-37/64	1.5781	9-7/8	16-7/8	5	612571
5/8	0.6250	4-7/8	8-3/4	2	612524	1-19/32	1.5938	9-7/8	16-7/8	5	612572
41/64	0.6406	5-1/8	9	2	612525	1-39/64	1.6094	10	17	5	612573
21/32	0.6562	5-1/8	9	2	612526	1-5/8	1.6250	10	17	5	612574
11/16	0.6875	5-3/8	9-1/4	2	612527	1-21/32	1.6562	10-1/8	17-1/8	5	612575
45/64	0.7031	5-5/8	9-1/2	2	612528	1-11/16	1.6875	10-1/8	17-1/8	5	612576
23/32	0.7188	5-5/8	9-1/2	2	612529	1-23/32	1.7188	10-1/8	17-1/8	5	612577
47/64	0.7344	5-5/8	9-1/2	2	612530	1-3/4	1.7500	10-1/8	17-1/8	5	612578
3/4	0.7500	5-7/8	9-3/4	2	612531	1-25/32	1.7812	10-1/8	17-1/8	5	612579
49/64	0.7656	6	9-7/8	2	612532	1-13/16	1.8125	10-1/8	17-1/8	5	612580
25/32	0.7812	6	9-7/8	2	612533	1-27/32	1.8438	10-1/8	17-1/8	5	612581
51/64	0.7969	6-1/8	10-3/4	3	612534	1-7/8	1.8750	10-3/8	17-3/8	5	612582
13/16	0.8125	6-1/8	10-3/4	3	612535	1-29/32	1.9062	10-3/8	17-3/8	5	612583
27/32	0.8438	6-1/8	10-3/4	3	612536	1-15/16	1.9375	10-3/8	17-3/8	5	612584
55/64	0.8594	6-1/8	10-3/4	3	612537	1-31/32	1.9688	10-3/8	17-3/8	5	612585
7/8	0.8750	6-1/8	10-3/4	3	612538	2	2.0000	10-3/8	17-3/8	5	612586
29/32	0.9062	6-1/8	10-3/4	3	612539	2-1/32	2.0312	10-3/8	17-3/8	5	612587
59/64	0.9219	6-1/8	10-3/4	3	612540	2-1/16	2.0625	10-1/4	17-3/8	5	612588
15/16	0.9375	6-1/8	10-3/4	3	612541	2-1/8	2.1250	10-1/4	17-3/8	5	612589
61/64	0.9531	6-3/8	11	3	612542	2-5/32	2.1562	10-1/4	17-3/8	5	612590
31/32	0.9688	6-3/8	11	3	612543	2-3/16	2.1875	10-1/4	17-3/8	5	612591
63/64	0.9844	6-3/8	11	3	612544	2-1/4	2.2500	10-1/8	17-3/8	5	612592
1	1.0000	6-3/8	11	3	612545	2-5/16	2.3125	10-1/8	17-3/8	5	612593
1-1/64	1.0156	6-1/2	11-1/8	3	612546	2-3/8	2.3750	10-1/8	17-3/8	5	612594
1-1/32	1.0312	6-1/2	11-1/8	3	612547	2-7/16	2.4375	11-1/4	18-3/4	5	612595
1-3/64	1.0469	6-5/8	11-1/4	3	612548	2-1/2	2.5000	11-1/4	18-3/4	5	612596
1-1/16	1.0625	6-5/8	11-1/4	3	612549	2-9/16	2.5625	11-7/8	19-1/2	5	612597
1-5/64	1.0781	6-7/8	11-1/2	3	612550	2-5/8	2.6250	11-7/8	19-1/2	5	612598
1-3/32	1.0938	6-7/8	12-1/2	4	612551	2-11/16	2.6875	12-3/4	20-3/8	5	612599
1-1/8	1.1250	7-1/8	12-3/4	4	612552	2-3/4	2.7500	12-3/4	20-3/8	5	612600
1-5/32	1.1562	7-1/4	12-7/8	4	612553	2-13/16	2.8125	13-3/8	21-1/8	5	612601
1-3/16	1.1875	7-3/8	13	4	612554	2-7/8	2.8750	13-3/8	21-1/8	5	612602
1-13/64	1.2031	7-1/2	13-1/8	4	612555	2-15/16	2.9375	14	21-3/4	5	612603
1-7/32	1.2188	7-1/2	13-1/8	4	612556	3	3.0000	14	21-3/4	5	612604
1-15/64	1.2344	7-7/8	13-1/2	4	612557						
1-1/4	1.2500	7-7/8	13-1/2	4	612558						

Oil Hole Drills

High Speed Steel – Straight Shank – 118° Point



- Designed with oil holes throughout the length of the land section of the drill to deliver a high pressure oil flow to the cutting edges
- Coolant flow flushes chips out of the hole to reduce heat and chip packing problems common to deep hole drilling applications
- Surface speeds may be increased by 30% or more over standard drill styles

Size (Inch)	Decimal Equivalent (Inch)	Flute Length (Inch)	Overall Length (Inch)	Code	Size (Inch)	Decimal Equivalent (Inch)	Flute Length (Inch)	Overall Length (Inch)	Code
15/64	0.2344	3-3/8	5-3/4	615000	5/8	0.6250	5-3/4	8-3/4	615024
1/4	0.2500	3-3/4	6-1/8	615001	41/64	0.6406	5-7/8	9	615025
9/32	0.2812	4	6-3/8	615002	21/32	0.6562	5-7/8	9	615026
19/64	0.2969	4	6-3/8	615003	43/64	0.6719	6	9-1/4	615027
5/16	0.3125	4	6-3/8	615004	11/16	0.6875	6	9-1/4	615028
21/64	0.3281	4-1/8	6-1/2	615005	45/64	0.7031	6-3/16	9-1/2	615029
11/32	0.3438	4-1/8	6-1/2	615006	23/32	0.7188	6-3/16	9-1/2	615030
23/64	0.3594	4-1/4	6-3/4	615007	47/64	0.7344	6-3/8	9-3/4	615031
3/8	0.3750	4-1/4	6-3/4	615008	3/4	0.7500	6-3/8	9-3/4	615032
25/64	0.3906	4-3/8	7	615009	49/64	0.7656	6-1/2	9-7/8	615033
13/32	0.4062	4-3/8	7	615010	25/32	0.7812	6-1/2	9-7/8	615034
27/64	0.4219	4-5/8	7-1/4	615011	51/64	0.7969	6-5/8	10	615035
7/16	0.4375	4-5/8	7-1/4	615012	13/16	0.8125	6-5/8	10	615036
29/64	0.4531	4-7/8	7-1/2	615013	53/64	0.8281	6-3/4	10-1/4	615037
15/32	0.4688	4-7/8	7-1/2	615014	27/32	0.8438	6-3/4	10-1/4	615038
31/64	0.4844	5	7-3/4	615015	55/64	0.8594	7	10-1/2	615039
1/2	0.5000	5	7-3/4	615016	7/8	0.8750	7	10-1/2	615040
33/64	0.5156	5-1/4	8	615017	57/64	0.8906	7	10-5/8	615041
17/32	0.5312	5-1/4	8	615018	29/32	0.9062	7	10-5/8	615042
35/64	0.5469	5-3/8	8-1/4	615019	59/64	0.9219	7	10-3/4	615043
9/16	0.5625	5-3/8	8-1/4	615020	15/16	0.9375	7	10-3/4	615044
37/64	0.5781	5-5/8	8-1/2	615021	61/64	0.9531	7-1/8	10-7/8	615045
19/32	0.5938	5-5/8	8-1/2	615022	31/32	0.9688	7-1/8	10-7/8	615046
39/64	0.6094	5-3/4	8-3/4	615023	63/64	0.9844	7-3/16	11	615047
					1	1.0000	7-3/16	11	615048

Die Drills

Carbide Tipped – Straight Flute/Straight Shank – 118° Point



- For hard materials primarily in the range of 48-65 HRC

Size (Inch)	Decimal Equivalent (Inch)	Flute Length (Inch)	Overall Length (Inch)	Code	Size (Inch)	Decimal Equivalent (Inch)	Flute Length (Inch)	Overall Length (Inch)	Code
3/16	0.1875	1-1/2	3-1/2	555301	7/16	0.4375	3	5-1/2	555309
13/64	0.2031	1-3/4	3-3/4	555325	29/64	0.4531	3-1/4	5-3/4	555333
7/32	0.2188	1-3/4	3-3/4	555302	15/32	0.4688	3-1/4	5-3/4	555310
15/64	0.2344	2	4	555326	31/64	0.4844	3-1/2	6	555334
1/4	0.2500	2	4	555303	1/2	0.5000	3-1/2	6	555311
17/64	0.2656	2-1/4	4-1/4	555327	17/32	0.5312	3-1/2	6	555312
9/32	0.2812	2-1/4	4-1/4	555304	9/16	0.5625	3-1/2	6	555313
19/64	0.2969	2-1/2	4-1/2	555328	19/32	0.5938	4	7	555314
5/16	0.3125	2-1/2	4-1/2	555305	5/8	0.6250	4	7	555315
21/64	0.3281	2-3/4	4-3/4	555329	21/32	0.6562	4-1/2	7-1/2	555316
11/32	0.3438	2-3/4	4-3/4	555306	11/16	0.6875	4-1/2	7-1/2	555317
23/64	0.3594	3	5	555330	23/32	0.7188	4-3/4	8	555318
3/8	0.3750	3	5	555307	3/4	0.7500	4-3/4	8	555319
25/64	0.3906	3	5-1/4	555331	13/16	0.8125	4-3/4	8	555320
13/32	0.4062	3	5-1/4	555308	7/8	0.8750	4-3/4	8	555321
27/64	0.4219	3	5-1/2	555332	15/16	0.9375	4-3/4	8	555322
					1	1.0000	4-3/4	8	555323

Standard Step Drills – Jobber Length

High Speed Steel – For Drilling and Counterboring Cap Screw Clearance Holes



Screw Size	Minor Dia.	Major Dia.	Step Length (Inch)	Flute Length (Inch)	Overall Length (Inch)	Code	Screw Size	Minor Dia.	Major Dia.	Step Length (Inch)	Flute Length (Inch)	Overall Length (Inch)	Code
#6	0.150"	1/4"	1/2	2-3/4	4	311291	5/16"	11/32"	1/2"	3/4	4-1/2	6	311295
#8	0.178"	L	1/2	2-15/16	4-1/4	311292	3/8"	13/32"	19/32"	7/8	5-3/16	7-1/8	311296
#10	0.204"	Q	5/8	3-7/16	4-3/4	311293	1/2"	17/32"	25/32"	1	3-1/4	*5-1/8	311297
1/4"	9/32"	13/32"	11/16	3-7/8	5-1/4	311294							

*Shorter than jobber length

High Speed Steel – For Drilling and Countersinking 82 Degree Flat Head Machine Screws



Screw Size	Minor Dia.	Major Dia.	Step Length (Inch)	Flute Length (Inch)	Overall Length (Inch)	Code	Screw Size	Minor Dia.	Major Dia.	Step Length (Inch)	Flute Length (Inch)	Overall Length (Inch)	Code
#6	0.142"	9/32"	1/2	2-15/16	4-1/4	311306	5/16"	0.320"	5/8"	3/4	5-3/16	7-1/8	311310
#8	0.169"	Q	1/2	3-7/16	4-3/4	311307	3/8"	0.383"	3/4"	7/8	5-5/8	5	311311
#10	0.196"	W	5/8	3-3/4	5-1/8	311308	1/2"	0.510"	7/8"	1	3-1/2	*5-1/8	311312
1/4"	0.257"	1/2"	11/16	4-13/16	6	311309							

*Shorter than jobber length

High Speed Steel – For Drilling 45 Degree Chamfered Holes to be Tapped



Screw Size	Minor Dia.	Major Dia.	Step Length (Inch)	Flute Length (Inch)	Overall Length (Inch)	Code	Screw Size	Minor Dia.	Major Dia.	Step Length (Inch)	Flute Length (Inch)	Overall Length (Inch)	Code
5-40	0.101	9/64	1/2	1-3/4	2-7/8	311313	5/16-18	0.261	13/32	15/16	3-7/8	5-1/4	311321
6-32	0.109	5/32	1/2	2	3-1/8	311314	5/16-24	0.272	13/32	15/16	3-7/8	5-1/4	311322
8-32	0.136	3/16	1/2	2-5/16	3-1/2	311315	3/8-16	0.316	31/64	1	4-3/8	5-7/8	311323
8-36	0.136	3/16	1/2	2-5/16	3-1/2	311316	3/8-24	0.339	31/64	1	4-3/8	5-7/8	311324
10-24	0.152	1/4	5/8	2-3/4	4	311317	7/16-14	0.375	17/32	1-1/16	4-13/16	6-5/8	311325
10-32	0.161	1/4	5/8	2-3/4	4	311318	7/16-20	0.390	17/32	1-1/16	4-13/16	6-5/8	311326
1/4-20	0.204	21/64	13/16	3-5/16	4-5/8	311319	1/2-13	0.437	5/8	1-1/16	5-3/16	7-1/8	311327
1/4-28	0.218	21/64	13/16	3-5/16	4-5/8	311320	1/2-20	0.452	5/8	1-1/16	5-3/16	7-1/8	311328

Self Starting Step Drills

High Speed Steel



Series	Number of Steps	Included Diameters	Code
SSD1	13	1/8, 5/32, 3/16, 7/32, 1/4, 9/32, 5/16, 11/32, 3/8, 13/32, 7/16, 15/32, 1/2	754700
SSD2	6	3/16, 1/4, 5/16, 3/8, 7/16, 1/2	754701
SSD3	9	1/4, 5/16, 3/8, 7/16, 1/2, 9/16, 5/8, 11/16, 3/4	754702
SSD4	12	3/16, 1/4, 5/16, 3/8, 7/16, 1/2, 9/16, 5/8, 11/16, 3/4, 13/16, 7/8	754703



Multi-Diameter Step Drills

High Speed Steel & TiN Coated



Diameter (mm)	Capacity (mm)	L (mm)	H (mm)	d (mm)	HSS Series 470	TiN Coated Series 475
					Code	Code
12	4, 5, 6, 7, 8, 9, 10, 11, 12	79	5	6	754704	754710
20	4, 6, 8, 10, 12, 14, 16, 18, 20	67	3	8	754705	754711
30	4, 6, 8, 10, 12, 14, 16, 18, 20, 22, 24, 26, 28, 30	100	4	10	754706	754712
32.5	5, 7.5, 9.7, 12.7, 15.2, 16.2, 18.6, 20.4, 22.5, 25.4, 28.3, 30.5, 32.5	78	4	10	754707	754713
38	6, 9, 13, 16, 19, 21, 23, 26, 29, 32, 35, 38	100	4	10	754708	754714
SETS – 3 Pieces – 12, 20 & 30 mm Diameters					754709	754715

Spade Drills

Solid Carbide



- For use on thin sheet applications and shallow hole drilling

Size (Inch)	Decimal Equivalent (Inch)	Flute Length (Inch)	Overall Length (Inch)	Code	Size (Inch)	Decimal Equivalent (Inch)	Flute Length (Inch)	Overall Length (Inch)	Code
1/32	0.0313	3/16	1-1/2	952000	9/32	0.2812	3/4	2-1/2	952016
1/16	0.0625	5/16	1-1/2	952002	5/16	0.3125	7/8	2-1/2	952018
3/32	0.0938	7/16	1-1/2	952004	11/32	0.3438	15/16	2-1/2	952020
1/8	0.1250	7/16	1-1/2	952006	3/8	0.3750	1	2-1/2	952022
5/32	0.1562	15/32	2	952008	13/32	0.4062	1	2-1/2	952024
3/16	0.1875	9/16	2	952010	7/16	0.4375	1-1/16	2-1/2	952026
7/32	0.2188	19/32	2	952012	15/32	0.4688	1-1/8	2-1/2	952028
1/4	0.2500	11/16	2	952014	1/2	0.5000	1-1/8	2-1/2	952030

Drill Blanks



- Made from high speed steel
- Hardened (63-65 HRC) and ground
- Can be used as punches, gages, pins or ground for special tools

#80 to Letter H – 12 pieces per package
 Letter "I" to 1/2" – 6 pieces per package
 3/32 to 1" – 1 piece per package
 Please order in package quantity

Tolerance	
Up to 1/2"	1/2" to 1"
+0.0000"/-0.0003"	+0.0000"/-0.0005"

High Speed Steel – Fractional Sizes

Size (Inch)	Decimal Equivalent (Inch)	Overall Length (Inch)	Code	Size (Inch)	Decimal Equivalent (Inch)	Overall Length (Inch)	Code	Size (Inch)	Decimal Equivalent (Inch)	Overall Length (Inch)	Code
1/64	0.0156	3/4	219300	7/64	0.1094	2-5/8	219306	13/64	0.2031	3-5/8	219312
1/32	0.0312	1-3/8	219301	1/8	0.1250	2-3/4	219307	7/32	0.2188	3-3/4	219313
3/64	0.0469	1-3/4	219302	9/64	0.1406	2-7/8	219308	15/64	0.2344	3-7/8	219314
1/16	0.0625	1-7/8	219303	5/32	0.1562	3-1/8	219309	1/4	0.2500	4	219315
5/64	0.0781	2	219304	11/64	0.1719	3-1/4	219310	17/64	0.2656	4-1/8	219316
3/32	0.0938	2-1/4	219305	3/16	0.1875	3-1/2	219311	9/32	0.2812	4-1/4	219317

Drill Blanks

High Speed Steel – Fractional Sizes (continued)



Size (Inch)	Decimal Equivalent (Inch)	Overall Length (Inch)	Code
19/64	0.2969	4-3/8	219318
5/16	0.3125	4-1/2	219319
21/64	0.3281	4-5/8	219320
11/32	0.3438	4-3/4	219321
23/64	0.3594	4-7/8	219322
3/8	0.3750	5	219323
25/64	0.3906	5-1/8	219324
13/32	0.4062	5-1/4	219325
27/64	0.4219	5-3/8	219326
7/16	0.4375	5-1/2	219327
29/64	0.4531	5-5/8	219328
15/32	0.4688	5-3/4	219329
31/64	0.4844	5-7/8	219330
1/2	0.5000	6	219331
33/64	0.5156	6	219332
17/32	0.5312	6	219333

Size (Inch)	Decimal Equivalent (Inch)	Overall Length (Inch)	Code
35/64	0.5469	6	219334
9/16	0.5625	6	219335
37/64	0.5781	6	219336
19/32	0.5938	6	219337
39/64	0.6094	6	219338
5/8	0.6250	6	219339
41/64	0.6406	6	219340
21/32	0.6562	6	219341
43/64	0.6719	6	219342
11/16	0.6875	6	219343
45/64	0.7031	6	219344
23/32	0.7188	6	219345
47/64	0.7344	6	219346
3/4	0.7500	6	219347
49/64	0.7656	6	219348
25/32	0.7812	6	219349

Size (Inch)	Decimal Equivalent (Inch)	Overall Length (Inch)	Code
51/64	0.7969	6	219350
13/16	0.8125	6	219351
53/64	0.8281	6	219352
27/32	0.8438	6	219353
55/64	0.8594	6	219354
7/8	0.8750	6	219355
57/64	0.8906	6	219356
29/32	0.9062	6	219357
59/64	0.9219	6	219358
15/16	0.9375	6	219359
61/64	0.9531	6	219360
31/32	0.9688	6	219361
63/64	0.9844	6	219362
1	1.0000	6	219363

Precision Ground Rods

Micrograin Solid Carbide



- Cut to length sizes
- All ground rods are made of premium high strength micrograin carbide
- Ground Rod Tolerances:
Diameter: +0.0000"/-0.0005"; Splits: +0.001"/-0.000" above center

Rod Diameter (Inch)	Rod Length (Inch)	Length Tolerance (Inch)	Code
1/16	1-1/2	+ 0.063	970000
3/32	2	+ 0.063	970002
3/32	2-1/2	+ 0.063	970004
1/8	1-1/2	+ 0.063	970006
1/8	2	+ 0.063	970008
1/8	2-1/4	+ 0.063	970010
1/8	2-1/2	+ 0.063	970012
1/8	3	+ 0.063	970014
1/8	12	+ 0.125	970016
5/32	1-1/2	+ 0.063	970018
5/32	2	+ 0.063	970020
3/16	2	+ 0.063	970022
3/16	2-1/2	+ 0.063	970024
3/16	3	+ 0.063	970026
3/16	4	+ 0.063	970028
3/16	6	+ 0.125	970030
3/16	12	+ 0.125	970032
1/4	2	+ 0.063	970034

Rod Diameter (Inch)	Rod Length (Inch)	Length Tolerance (Inch)	Code
1/4	2-1/2	+ 0.063	970036
1/4	3	+ 0.063	970038
1/4	4	+ 0.080	970040
1/4	6	+ 0.125	970042
1/4	12	+ 0.125	970044
5/16	2	+ 0.063	970046
5/16	2-1/2	+ 0.063	970048
5/16	3	+ 0.063	970050
5/16	4	+ 0.080	970052
5/16	6	+ 0.125	970054
5/16	12	+ 0.125	970056
3/8	2	+ 0.063	970058
3/8	2-1/2	+ 0.063	970060
3/8	3	+ 0.063	970062
3/8	3-1/2	+ 0.063	970064
3/8	4	+ 0.080	970066
3/8	6	+ 0.125	970068
3/8	12	+ 0.125	970070

Rod Diameter (Inch)	Rod Length (Inch)	Length Tolerance (Inch)	Code
7/16	2-1/2	+ 0.063	970072
7/16	3	+ 0.063	970074
1/2	2	+ 0.063	970076
1/2	2-1/2	+ 0.063	970078
1/2	3	+ 0.063	970080
1/2	3-1/2	+ 0.063	970082
1/2	4	+ 0.080	970084
1/2	6	+ 0.125	970086
1/2	12	+ 0.125	970088
9/16	3-1/2	+ 0.063	970090
5/8	3-1/2	+ 0.063	970092
5/8	6	+ 0.125	970094
3/4	4	+ 0.080	970096
3/4	6	+ 0.125	970098
1	4	+ 0.080	970100
1	6	+ 0.125	970102

Drill Indexes

Drills Sold Separately

Jobber Length Indexes



Combination Jobber Length Indexes

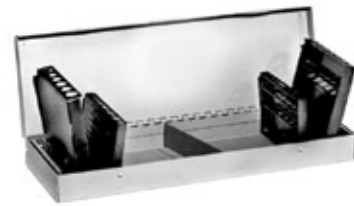

Description	No. of Indexes	Model No.	Code
1/16 to 1/2 by 64ths	29	CZ29	311076
Letter - A to Z	26	CZ26	311078
Wire Gage - 1 to 60	60	CZ60	311079
Metric - 1 to 7 mm by 0.5 mm	13	CZM13	311105
Metric - 1 to 10 mm by 0.5 mm	19	CZM19	311086
Metric - 1 to 13 mm by 0.5 mm	25	CZM25	311087
Metric - 6 to 10 mm by 0.1 mm	41	CZM41	311106

Description	No. of Indexes	Model No.	Code
1/16 to 1/2 by 64ths, Letter - A to Z, Wire Gage - 1 to 60	115	CZ115	311081
1/16 to 1/2 by 64ths, Letter - A to Z, Wire Gage - 1 to 80	135	CZ135	311088
1/16 to 1/2 by 64ths, Wire Gage - 1 to 80, Metric - 1 to 13 mm by 0.5mm, Inch/Metric	134	CZ134	311089
Metric - 1 to 13 mm Various Sizes	118	CZM118	311115

Drill Sets

Jobber Length

13 Pieces



Size	Description	Code
1/16 to 1/4 by 64ths Metal Index	HSS, Left Hand, 118° Point	752071
	Cobalt, Bronze, 135° Split Point	751128

15 Pieces



Size	Description	Code
1/16 to 1/2 by 32nds Metal Index	HSS, Left Hand, 118° Point	606613
	Cobalt, Bronze, 135° Split Point	751126

21 Pieces



Size	Description	Code
1/16 to 3/8 by 64ths Metal Index	HSS, Left Hand, 118° Point	606615

Metric – 25 Pieces



Size	Description	Code
1 to 13 mm by 0.5 mm Metal Index	HSS, 118° Point	311138
	Cobalt, 135° Split Point	754717

Drill Sets

Jobber Length (continued)

Premium Metric – 25 Pieces



- Made of special Hi-Molybdenum tool steel, with precision ground points, flutes, body, clearance, and drill diameter for the ultimate in accuracy and performance
- Body and clearance are gold surface treated for maximum lubricity
- Specially designed for hand held drills
- Recommended for use in work hardening grades of stainless steel and other hard metal drilling applications

Size	Description	Code
1 to 13 mm by 0.5 mm Metal Index	Black and Gold Finish, 135° Split Point	750017

29 Pieces



- 135° split point
- Straight shank
- Right hand spiral wide flutes

Size	Description	Code
1/16" to 1/2" by 64ths Metal Index	HSS TiN Coated Gold-P	883345

26 Pieces



Size	Description	Code
Letter Sizes A to Z Metal Index	HSS Oxide Finish 118° Point	752001

29 Pieces



Size	Description	Code
1/16 to 1/2 by 64ths Metal Index	HSS	313201
	Cobalt	313202

29 Pieces



Size	Description	Code
1/16 to 1/2 by 64ths Metal Index	HSS, Oxide Finish, 118° Point	752000
	HSS, *Reduced 3/8 Shank, 118° Point	311164
	HSS, Left Hand,	751200

*Maximum shank diameter in set

60 Pieces



Size	Description	Code
Wire Gage Sizes 1 to 60 Metal Index	HSS	313203
	Cobalt	313204

60 Pieces



Size	Description	Code
Wire Gage Sizes 1 to 60 Metal Index	HSS, Left Hand, 118° Point	311151

Drill Sets

Jobber Length (continued)

115 Pieces



Size	Description	Code
1/16 to 1/2 by 64ths, Letter Sizes A to Z, and Wire Gage Sizes 1 to 60 Metal Index	HSS, Oxide Finish, 118° Point	754603
	HSS, Bright Finish, 118° Point	753360
	Cobalt, Heavy Duty, 135° Split Point	752075

Metric – 134 Pieces

Size	Description	Code
1 to 13 mm by 0.5 mm, 1/16 to 1/2 by 64ths, Wire Gage Sizes 1 to 60 Metal Index	HSS, 118° Point	311141

135 Pieces

Size	Description	Code
1/16 to 1/2 by 64ths, Letter Sizes A to Z, and Wire Gage Sizes 1 to 60 Metal Index	HSS, Oxide Finish, 118° Point	311140

Screw Machine, Taper Length, Taper Shank & Aircraft Extension

Screw Machine Length – 115 Pieces



Size	Description	Code
1/16 to 1/2 by 64ths, Letter Sizes A to Z, and Wire Gage Sizes 1 to 60 Metal Index	HSS, Bright Finish, 118° Point	753361
	HSS, Oxide Finish, 135° Split Point	311179

Taper Length – 29 Pieces



Size	Description	Code
1/16 to 1/2 by 64ths Metal Index	HSS, Oxide Finish, 118° Point	311187
	Cobalt, Bronze Finish, 135° Split Point	311192

Aircraft Extension – 29 Pieces



Size	Description	Code
1/16 to 1/2 by 64ths Metal Index	HSS, 6" Overall Length	311118
	HSS, 12" Overall Length	311119

Taper Shank – 16 Pieces



Size	Description	Code
49/64 to 1 by 64ths Metal Index	HSS, 118° Point	311194

Drill Sets

Reduced Shank

1/2" Reduced Shank – 8 Pieces



1/2" Reduced Shank – 8 Pieces

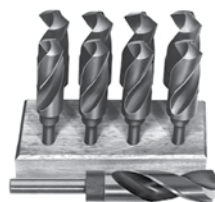

Size	Description	Code
9/16 to 1 by 16ths Metal Index	Cobalt, Round Shank	311171

Size	Description	Code
9/16 to 1 by 16ths Wooden Block	Cobalt	313207



1/2" Reduced Shank – 8 Pieces

Size	Description	Code
1-1/16 to 1-1/2 by 16ths Wooden Block	Cobalt, 135° Split Point	609001

1/2" Reduced Shank – 33 Pieces

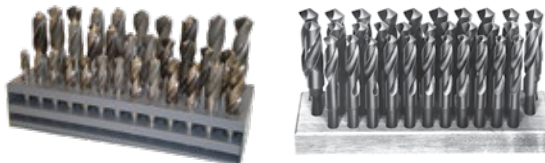

Size	Description	Code
1/2 to 1 by 64ths Metal Index	HSS, Flatted Shank	607115
33/64 to 1 by 64ths Wooden Block	HSS, Flatted Shank	311168

3/8" Reduced Shank – 8 Pieces

Size	Description	Code
3/8 to 17/32 by 32nds, 9/16, and 5/8 Wooden Block	HSS	311165

Step Drills

Standard Step Drill Sets
6 Pieces

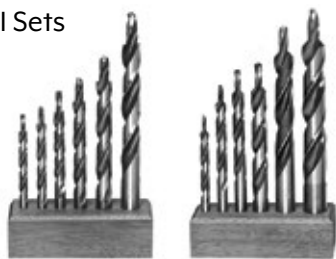

Size	Description	Code
Jobber Length #6 - 3/8 NC Screw Sizes Wooden Block	For Flat Head Screws	311184
	For Cap Screws	311182
	For Tap Drills	311185
Metric Jobber Length 3 to 10 mm Screw Sizes Wooden Block	For Cap Screws	615276

Self Starting Step Drill Set
Multi-Diameter
3 Pieces



Size	Description	Code
1/8 to 1/2, 3/16 to 1/2, & 9/16 to 1 Metal Index	3 flats on shank	750010



Combined Drills & Countersinks

High Speed Steel, TiN Coated & Cobalt – 60° Plain Type

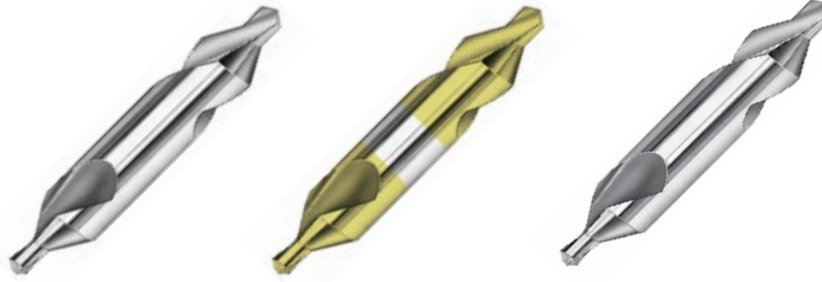

60° Angle
(Series 115)

60° Angle TiN Coated
(Series 08115)

60° Angle Cobalt
(Series 1055)

Size	Body Diameter (Inch)	Point Diameter (Inch)	Point Length (Inch)	Overall Length (Inch)	60° Angle (Series 115) HSS M2	60° Angle (Series 08115) HSS M2 – TiN	60° Angle (Series 1055) Cobalt M42
					Code	Code	Code
000	1/8	0.020	1/32	1-1/4	540599	-	-
00	1/8	0.025	1/32	1-1/4	540600	-	-
0	1/8	1/32	3/64	1-1/4	540610	-	-
1	1/8	3/64	1/16	1-1/4	540611	601000	540531
2	3/16	5/64	7/64	1-7/8	540612	601001	540532
3	1/4	7/64	9/64	2	540613	601002	540533
4	5/16	1/8	5/32	2-1/8	540614	601003	540534
4-1/2	3/8	9/64	3/16	2-1/2	540604	-	-
5	7/16	3/16	1/4	2-3/4	540615	601004	540535
6	1/2	7/32	19/64	3	540616	601005	540536
7	5/8	1/4	5/16	3-1/4	540617	601006	540537
8	3/4	5/16	13/32	3-1/2	540618	601007	540538
9	7/8	11/32	7/16	3-5/8	540619	-	-
10	1	3/8	1/2	3-3/4	540598	-	-

Combined Drills & Countersinks

High Speed Steel, Cobalt & Carbide – 60° Plain Type

• 60° included angle

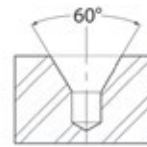

High Speed Steel & Cobalt

Size	Overall Length (Inch)	Drill Length (Inch)	Body Dia. (Inch)	Drill Dia. (Inch)	60° Angle HSS	60° Angle Cobalt
					Code	Code
00	1-1/4	0.025	1/8	0.025	521002	-
0	1-1/4	1/32	1/8	1/32	521003	-
1	1-1/4	3/64	1/8	3/64	521011	521031
2	1-7/8	5/64	3/16	5/64	521012	521032
3	2	7/64	1/4	7/64	521013	521033
4	2-1/8	1/8	5/16	1/8	521014	521034
5	2-3/4	3/16	7/16	3/16	521015	521035
6	3	7/32	1/2	7/32	521016	521036
7	3-1/4	1/4	5/8	1/4	521017	521037
8	3-1/2	5/16	3/4	5/16	521018	521038

Carbide

Size	Overall Length (Inch)	Body Diameter (Inch)	Drill Diameter (Inch)	60° Angle Carbide
				Code
1	1-1/2	1/8	3/64	952040
2	1-7/8	3/16	5/64	952042
3	2	1/4	7/64	952044
4	2-1/8	5/16	1/8	952046
5	2-3/4	7/16	3/16	952048
6	3	1/2	7/32	952050
7	3	5/8	1/4	952052
8	3	3/4	5/16	952054

Combined Drills & Countersinks

High Speed Steel – 60° Plain Long Type



60° Angle
(Series 185)

Size	Body Diameter (Inch)	Point Length (Inch)	Point Diameter (Inch)	Overall Length (Inch)	60° Angle (Series 185) HSS M2	
					Code	
1	1/8	1/16	3/64	3	540561	
*1	1/8	1/16	3/64	4	540562	
1	1/8	1/16	3/64	5	540563	
1	1/8	1/16	3/64	6	540564	
2	3/16	7/64	5/64	3	540567	
*2	3/16	7/64	5/64	4	540568	
2	3/16	7/64	5/64	5	540569	
2	3/16	7/64	5/64	6	540570	
3	1/4	9/64	7/64	3	540571	
*3	1/4	9/64	7/64	4	540572	
3	1/4	9/64	7/64	5	540573	
3	1/4	9/64	7/64	6	540574	
4	5/16	5/32	1/8	3	540575	
*4	5/16	5/32	1/8	4	540576	

Size	Body Diameter (Inch)	Point Length (Inch)	Point Diameter (Inch)	Overall Length (Inch)	60° Angle (Series 185) HSS M2	
					Code	
4	5/16	5/32	1/8	5	540577	
4	5/16	5/32	1/8	6	540578	
4-1/2	3/8	3/16	9/64	4	540579	
4-1/2	3/8	3/16	9/64	5	540580	
4-1/2	3/8	3/16	9/64	6	540581	
*5	7/16	1/4	3/16	4	540582	
5	7/16	1/4	3/16	5	540583	
5	7/16	1/4	3/16	6	540584	
6	1/2	19/64	7/32	4	540585	
6	1/2	19/64	7/32	5	540586	
6	1/2	19/64	7/32	6	540587	
7	5/8	5/16	1/4	5	540588	
7	5/8	5/16	1/4	6	540589	
8	3/4	13/32	5/16	6	540590	

SETS – 5 Pieces – Sizes *1 to *5 – 4" Overall Length 540560

Combined Drills & Countersinks

High Speed Steel & Solid Carbide – 60° Plain Long Type



Size	Overall Length (Inch)	Body Dia. (Inch)	Drill Length (Inch)	Drill Dia. (Inch)	60° Angle	
					HSS Code	Carbide Code
1	3	1/8	3/64	3/64	540631	-
1	4	1/8	3/64	3/64	540632	952064
1	5	1/8	3/64	3/64	540633	-
1	6	1/8	3/64	3/64	540634	-
2	4	3/16	5/64	5/64	540635	952066
2	5	3/16	5/64	5/64	540636	-
2	6	3/16	5/64	5/64	540637	-
3	4	1/4	7/64	7/64	540638	952068
3	5	1/4	7/64	7/64	540639	-
3	6	1/4	7/64	7/64	540640	-
4	4	5/16	1/8	1/8	540641	952070
4	5	5/16	1/8	1/8	540642	-

Size	Overall Length (Inch)	Body Dia. (Inch)	Drill Length (Inch)	Drill Dia. (Inch)	60° Angle	
					HSS Code	Carbide Code
4	6	5/16	1/8	1/8	540643	-
4-1/2	4	3/8	9/64	9/64	540644	-
4-1/2	5	3/8	9/64	9/64	540645	-
4-1/2	6	3/8	9/64	9/64	540646	-
5	4	7/16	3/16	3/16	540647	-
5	5	7/16	3/16	3/16	540648	-
5	6	7/16	3/16	3/16	540649	952072
6	5	1/2	7/32	7/32	540650	-
6	6	1/2	7/32	7/32	540651	952074
7	6	5/8	1/4	1/4	540652	952076
8	6	3/4	5/16	5/16	540653	952078

Combined Drills & Countersinks

High Speed Steel – 82° & 90° Plain Type



Size	Body Diameter (Inch)	Point Diameter (Inch)	Point Length (Inch)	Overall Length (Inch)	82° Angle (Series 154)	90° Angle (Series 155)
					HSS M2 Code	HSS M2 Code
1	1/8	3/64	1/16	1-1/4	540511	540521
2	3/16	5/64	7/64	1-7/8	540512	540522
3	1/4	7/64	9/64	2	540513	540523
4	5/16	1/8	5/32	2-1/8	540514	540524
5	7/16	3/16	1/4	2-3/4	540515	540525
6	1/2	7/32	19/64	3	540516	540526
7	5/8	1/4	5/16	3-1/4	540517	540527
8	3/4	5/16	13/32	3-1/2	540518	540528

High Speed Steel – Radius Type



Magafor center drills with the special radius profile provide the following benefits:

- Reduces tip breakage
- Serves as a protective chamfer
- Provides an exact bearing

Size	Body Diameter (Inch)	Point Diameter (Inch)	Point Length (Inch)	Overall Length (Inch)	Radius (Inch)	(Series 125) HSS M2 Code
1	1/8	3/64	1/8	1-1/4	5/32	540541
2	3/16	5/64	7/32	1-7/8	7/32	540542
3	1/4	7/64	9/32	2	5/16	540543
4	5/16	1/8	3/8	2	3/8	540544
5	7/16	3/16	1/2	2-3/4	1/2	540545
6	1/2	7/32	9/16	3	17/32	540546
7	5/8	1/4	11/16	3-1/4	11/16	540547
8	3/4	5/16	13/16	3-1/2	13/16	540548
SETS – 5 Pieces – Sizes 1 to 5						540540

High Speed Steel – 60° & 120° Bell Type



The Bell type design has included angles of 60° and 120° to form protected centers.

Size	Body Diameter (Inch)	Point Diameter (Inch)	Point Length (Inch)	Overall Length (Inch)	Bell Diameter (Inch)	(Series 135) HSS M2 Code
11	1/8	3/64	1/16	1-1/4	0.100	540621
12	3/16	1/16	3/32	1-7/8	0.150	540622
13	1/4	3/32	1/8	2	0.200	540623
14	5/16	7/64	5/32	2-1/8	0.250	540624
15	7/16	5/32	7/32	2-3/4	0.350	540625
16	1/2	3/16	1/4	3	0.400	540626
17	5/8	7/32	5/16	3-1/4	0.500	540627
18	3/4	1/4	11/32	3-1/2	0.600	540628
19	7/8	5/16	7/16	3-5/8	0.700	540629
20	1	3/8	1/2	3-3/4	0.800	540630
SETS – 5 Pieces – Sizes 11 to 15						540620

Indexable Combined Drill & Countersinks

Carbide Inserts

- Secure insert pocket allows for quick and repeatable indexes
- Easy change over from one size to another – same body holds #2, #3, #4 and #5 inserts
- Carbide inserts for extended tool life
- One grade handles all applications
- Multiple bodies available for the same indexable insert (5/16", 3/8", 1/2", 5/8", 3/4", 1", and 1-1/4")
- Convenient, low-cost and economical

Individual Holders



5/8" holder body style shown

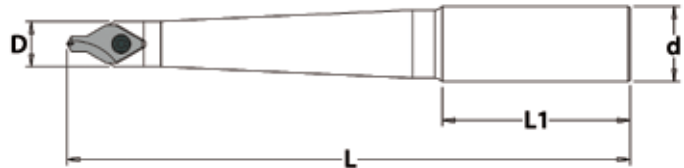

Dimensions (Inch)	Screw Reference	Key Reference	d Shank Diameter (Inch)	D Diameter (Inch)	L1 Length (Inch)	L Overall Length (Inch)	Code
5/16 x 4	TSB-0307	Torx® 9	5/16	0.393	1-13/32	4	530660
3/8 x 4	TSB-0307	Torx® 9	3/8	0.393	1-9/16	4	530661
1/2 x 4	TSB-0307	Torx® 9	1/2	0.393	1-23/32	4	530662
5/8 x 5	TSB-0307	Torx® 9	5/8	0.393	1-7/8	5	530663
3/4 x 6	TSB-0307	Torx® 9	3/4	0.393	1-7/8	6	530664
1 x 7	TSB-0307	Torx® 9	1	0.393	2-3/16	7	530665
1-1/4 x 8	TSB-0307	Torx® 9	1-1/4	0.393	2-11/32	8	530666



Indexable Combined Drill & Countersink Sets

Description	Code
5/8" x 5" Holder, 4 Carbide Inserts #2, #3, #4, and #5, and a Torx® 9 Key	530671
1/2" x 4" Holder, 4 Carbide Inserts #2, #3, #4, and #5, and a Torx® 9 Key	530672

Replacement Inserts

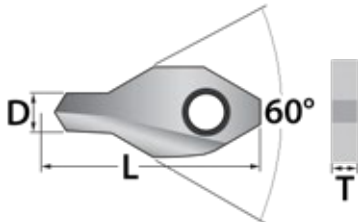

Insert	Material	D (Inch)	L Length (Inch)	T Thickness (Inch)	Code
#2	Carbide	5/64	0.811	0.157	530667
#3	Carbide	7/64	0.811	0.157	530668
#4	Carbide	1/8	0.811	0.157	530669
#5	Carbide	3/16	0.811	0.157	530670

Spare Screw



Description	Code
TSB-0307 (Torx® 9)	530673

Recommended Cutting Data

Material	Cutting Speed		Feed/Revolution							
	ft./min.	m/min.	#2 (5/64")		#3 (7/64")		#4 (1/8")		#5 (3/16")	
			inch/rev.	mm/rev.	inch/rev.	mm/rev.	inch/rev.	mm/rev.	inch/rev.	mm/rev.
Mild Steel	160-230	50-70	0.001-0.002	0.03-0.05	0.0025-0.004	0.06-0.10	0.003-0.0047	0.08-0.12	0.003-0.0055	0.08-0.14
Alloy Steel	150-210	45-65	0.0008-0.002	0.02-0.05	0.0015-0.003	0.04-0.08	0.0025-0.004	0.06-0.10	0.0025-0.004	0.06-0.10
Tool Steel	130-200	40-60	0.0004-0.0015	0.01-0.04	0.0008-0.0025	0.02-0.06	0.0015-0.003	0.04-0.08	0.0015-0.003	0.04-0.08
Stainless Steel	20-65	5-20	0.0004-0.0008	0.01-0.02	0.0004-0.001	0.01-0.03	0.0008-0.002	0.02-0.05	0.0008-0.0025	0.02-0.06
Cast Iron	160-230	50-70	0.0008-0.0025	0.02-0.06	0.0015-0.003	0.04-0.08	0.0025-0.004	0.06-0.10	0.0025-0.004	0.06-0.10
Aluminum	330-660	100-200	0.0004-0.0015	0.01-0.04	0.0008-0.002	0.02-0.05	0.0008-0.0025	0.02-0.06	0.0008-0.0025	0.02-0.06

Spotweld Drills

HSS-E Cobalt



- Centering point allows drilling without deviation
- Special sharpening allows the first sheet to be bored without damage to the second
- Design allows excellent penetration, a high wear resistance, and many regrinds



D (mm)	d2 (mm)	Flute Length (mm)	Overall Length (mm)	Series 201 Code
6	6	28	66	615370
7	7	34	74	615371
8	8	37	79	615372
10	10	43	89	615373

Spotweld Drills

For Pneumatic Tools

HSS-E Cobalt



- Short drills designed to be used with pneumatic disconnectors
- Shanks have flats with 60° taper



D (mm)	d2 (mm)	Flute Length (mm)	Overall Length (mm)	Series 202 Code
8	8	15	38	615374

Spotting & Centering Drills

High Speed Steel

Short Length – Right Hand Cut

- 118° point
- Short flute and overall lengths provides greater rigidity



Size (Inch)	Decimal Equivalent (Inch)	Flute Length (Inch)	Overall Length (Inch)	Code
3/8	0.3750	1	2	615300
7/16	0.4375	1	2	615301
1/2	0.5000	1	2	615302
5/8	0.6250	1-1/8	2-1/4	615303
3/4	0.7500	1-1/8	2-1/4	615304
7/8	0.8750	1-1/4	2-1/2	615305
1	1.0000	1-1/4	2-1/2	615306
1-1/4	1.2500	2	4	615307
1-1/2	1.5000	2-1/2	5	615308
1-3/4	1.7500	2-3/4	5-1/2	615309

CNC Spot Drills

High Speed Steel – 90° & 120° Points

Standard Length – Right Hand Cut

- Used to establish perfect alignment of the follow-up tool



Size (Inch)	Decimal Equiv. (Inch)	Flute Length (Inch)	Overall Length (Inch)	90° Point	120° Point
				Code	Code
1/4	0.2500	3/4	2-1/2	601020	601026
3/8	0.3750	1-1/8	3-1/8	601021	601027
1/2	0.5000	1-3/8	3-3/4	601022	601028
5/8	0.6250	1-5/8	4-3/8	601023	601029
3/4	0.7500	1-7/8	5	601024	601030
1	1.0000	2-1/4	6	601025	601031

CNC Spot Drills



Cobalt & TiN Coated – Inch & Metric – 90° & 120° Angles – Standard Length



Inch

Body Diameter (Inch)	Decimal Equivalent (Inch)	Flute Length (Inch)	Overall Length (Inch)	90° Angle (Series 195) Cobalt	120° Angle (Series 196) Cobalt	90° Angle (Series 0895) TiN Coated	120° Angle (Series 0896) TiN Coated
				Code	Code	Code	Code
1/8	0.125	3/8	2	540658	540668	601032	601041
3/16	0.188	5/8	2-3/8	540659	540669	601033	601042
1/4	0.250	7/8	2-5/8	540660	540670	601034	601043
3/8	0.375	1	3-1/2	540661	540671	601035	601044
1/2	0.500	1-3/8	4	540662	540672	601036	601045
5/8	0.625	1-3/8	4-1/2	540663	540673	601037	601046
3/4	0.750	1-5/8	5-1/8	540664	540674	601038	601047
1	1.000	1-3/4	5-1/2	540665	540675	601039	601048
SETS – 4 Pieces – Sizes 1/4, 3/8, 1/2, and 5/8”				540666	540676	601040	601049

NOTE: TiN coated sets have 6 pieces: sizes 1/8, 3/16, 1/4, 5/16, 3/8 and 1/2”

Metric

Body Diameter (mm)	Decimal Equivalent (Inch)	Flute Length (Inch)	Overall Length (Inch)	90° Angle (Series 195) Cobalt	120° Angle (Series 196) Cobalt	90° Angle (Series 0895) TiN Coated	120° Angle (Series 0896) TiN Coated
				Code	Code	Code	Code
2	0.079	5/16	2	540001	540014	601050	601063
3	0.118	3/8	2	540002	540015	601051	601064
4	0.157	1/2	2	540003	540016	601052	601065
5	0.197	5/8	2-3/8	540004	540017	601053	601066
6	0.236	3/4	2-5/8	540005	540018	601054	601067
8	0.315	1	3-1/8	540006	540019	601055	601068
10	0.394	1	3-1/2	540007	540020	601056	601069
12	0.472	1-1/4	4	540008	540021	601057	601070
14	0.551	1-3/8	4-1/2	540009	540022	601058	601071
16	0.630	1-3/8	4-1/2	540010	540023	601059	601072
18	0.709	1-5/8	5-1/8	540011	540024	601060	601073
20	0.787	1-5/8	5-1/8	540012	540025	601061	601074
25	0.984	1-3/4	5-1/2	540013	540026	601062	601075

Cobalt – Inch & Metric – 90° & 120° Angles – Long Length



Inch

Metric

Body Diameter (Inch)	Decimal Equiv. (Inch)	Flute Length (Inch)	Overall Length (Inch)	90° Angle (Series 197)	120° Angle (Series 199)
				Code	Code
1/4	0.250	7/8	5-1/2	540680	540690
3/8	0.375	1	6-3/4	540681	540691
1/2	0.500	1-3/8	6-3/4	540682	540692
5/8	0.625	1-3/8	7-7/8	540683	540693
3/4	0.750	1-5/8	7-7/8	540684	540694
1	1.000	1-3/4	7-7/8	540685	540695
SETS – 4 Pieces Sizes 1/4, 3/8, 1/2, and 5/8”				540686	540697

Body Diameter (mm)	Decimal Equiv. (Inch)	Flute Length (Inch)	Overall Length (Inch)	90° Angle (Series 197)
				Code
4	0.157	1/2	4	540027
5	0.197	9/16	4-3/4	540028
6	0.236	3/4	5-1/2	540029
8	0.315	1	5-1/2	540030
10	0.394	1	6-3/4	540031
12	0.472	1-3/16	6-3/4	540032
16	0.630	1-3/8	7-7/8	540033
20	0.787	1-9/16	7-7/8	540034



CNC Spot Drills

Micrograin Solid Carbide

Stub Length

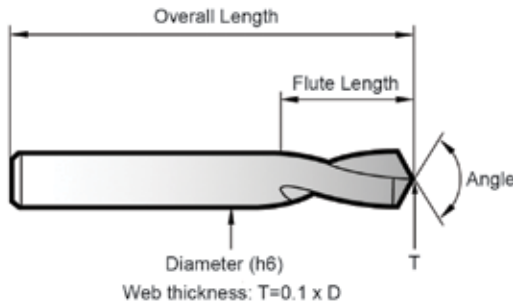

Hard'X: AlTiN carbide tool coating with a high hardness of 3500 HV. This coating shows high thermic stability and excellent protection against heat and wear. Ideal for dry machining - high speed cut - in treated steels and dies up to 67 HRC.

Diameters	Tolerance D	Angle	L
0.078-0.118	0 + 0.0002"	±1°	±0.0395
1/8-0.236	0 + 0.0003"	±1°	±0.0395
1/4-0.394	0 + 0.0004"	±1°	±0.0395
0.472-1	0 + 0.0005"	±1°	±0.0395

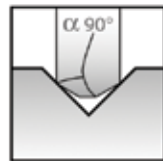

90 degree angle:
By using the Magafor NC drill of diameter over the drilling tool, centering and chamfering are obtained in a single operation

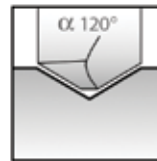

120 degree angle:
The preliminary hole obtained with the Magafor NC drill corresponds to the angle at the end of the tool used in drilling and prevents it from deviating

90° Angle (Series 8195), Hard'X 90° Angle (Series 8195-H) & 120° Angle (Series 8196)

Diameter Inch (mm)	Overall Length (Inch)	Flute Length (Inch)	Web Thickness of Split Point (Inch)	90° Angle (Series 8195)	90° Angle (Series 8195-H)	120° Angle (Series 8196)
				Code	Hard'X Code	Code
0.078 (2)	1-9/16	0.315	0.008	540050	314267	540070
0.118 (3)	1-3/4	0.4	0.012	540051	314270	540071
0.157 (4)	2	0.475	0.016	540052	314273	540072
0.197 (5)	2	0.6	0.02	540053	314276	540073
0.236 (6)	2	0.7	0.023	540054	314279	540074
1/4 (6.35)	2	0.7	0.023	540055	314282	540075
5/16 (7.93)	2-3/8	0.9	0.031	314264	314285	-
0.315 (8)	2-3/8	0.9	0.031	540056	314288	540076
3/8 (9.52)	2-3/4	0.95	0.039	540057	314291	540077
0.394 (10)	2-3/4	0.95	0.039	540058	314294	540078
0.472 (12)	2-3/4	0.95	0.047	540059	314297	540079
1/2 (12.70)	2-3/4	0.95	0.051	540060	314300	540080
0.551 (14)	3	0.95	0.055	540061	314303	540081
5/8 (15.87)	3-1/8	1	0.063	540062	314306	540082
0.63 (16)	3-1/8	1	0.063	540063	314309	540083
0.787 (20)	4	1-3/8	0.079	540064	314312	540084

Long Length – 90° Angle (Series 8197)



Diameter Inch (mm)	Overall Length (Inch)	Flute Length (Inch)	Web Thickness of Split Point (Inch)	90° Angle (Series 8197)	Diameter Inch (mm)	Overall Length (Inch)	Flute Length (Inch)	Web Thickness of Split Point (Inch)	90° Angle (Series 8197)
				Code					Code
0.157 (4)	4	0.475	0.016	314318	0.394 (10)	6-3/4	1	0.039	314336
0.197 (5)	4-3/4	0.6	0.02	314321	0.472 (12)	6-3/4	1-3/16	0.047	314339
0.236 (6)	5-1/2	0.8	0.023	314324	1/2 (12.70)	6-3/4	1-3/8	0.051	314342
1/4 (6.35)	5-1/2	0.87	0.025	314327	5/8 (15.87)	8	1-3/8	0.063	314345
0.315 (8)	5-1/2	1	0.031	314330	0.63 (16)	8	1-3/8	0.063	314348
3/8 (9.52)	6-3/4	1	0.039	314333	3/4 (19.05)	8	1-5/8	0.075	314351
					0.787 (20)	8	1-5/8	0.079	314354

CNC Spotting Drills



HSS-E Cobalt – 90° Angle – 118° Point Geometry – Uncoated & RED-X Coated

- 118° point geometry offers improved penetration rates while reinforcing the point
- Double ended for cost savings
- Available in 4-Piece sets or sold individually
- RED-X coating provides increased speeds and feeds and allows machining up to 55 HRC

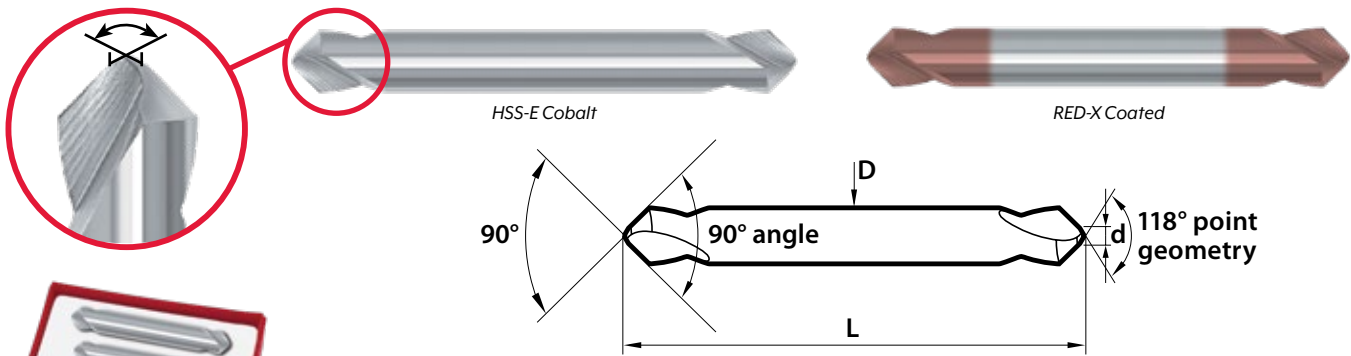

D (Inch)	d (Inch)	L (Inch)	90° Uncoated (Series 019)	90° RED-X Coated (Series 0919)
			Code	Code
3/16	1/16	2	540091	540096
1/4	3/32	2	540092	540097
3/8	9/64	3	540093	540098
1/2	3/16	4	540094	540099
SETS – 4 Pieces – 3/16", 1/4", 3/8", 1/2"			540090	540095

Drill Mills



2 Flute & 4 Flute – 90° Point



Cutting Diameter (Inch)	Shank Diameter (Inch)	Flute Length (Inch)	Overall Length (Inch)	2 Flute	4 Flute
				Code	Code
1/8	1/8	1/8	1-1/2	313820	313824
1/4	1/4	1/4	2-1/2	313821	313825
3/8	3/8	3/8	2-1/2	313822	313826
1/2	1/2	1/2	3	313823	313827

Indexable Spotting Drills

Carbide Inserts

- One combination tool that does four applications, giving extra efficiency and reduced cycle times
- For spotting, engraving, chamfering and grooving on CNC and conventional milling machines
- For spotting on CNC lathes
- Indexable carbide insert with 4 cutting edges provides great cost per edge and long tool life
- Insert fits both 1/2" and 5/8" diameter tools
- Extended reach tools: 5/8" x 6" and 5/8" x 9"

Individual Holders

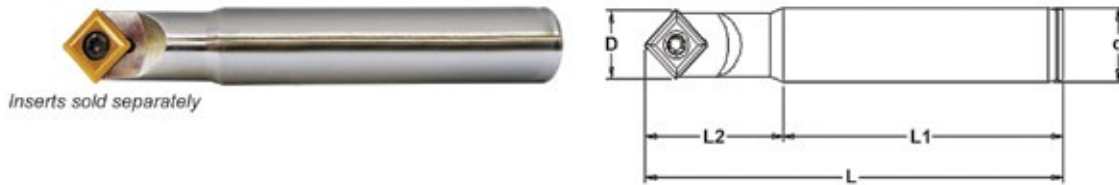

Dimensions (Inch)	Insert Reference	Screw Reference	Key Reference	D (Inch)	d (Inch)	L (Inch)	L1 (Inch)	L2 (Inch)	Code
1/2 x 4	XDBPIIT308	TSB-3508	Torx® 15	0.551	0.500	4.00	2.75	1.25	530650
5/8 x 4	XDBPIIT308	TSB-3508	Torx® 15	0.551	0.625	4.00	2.75	1.25	530651
5/8 x 6	XDBPIIT308	TSB-3508	Torx® 15	0.551	0.625	6.00	4.75	1.25	530652
5/8 x 9	XDBPIIT308	TSB-3508	Torx® 15	0.551	0.625	9.00	7.75	1.25	530653



Indexable Spotting Drill Sets

Description	Grade	Code
1/2" x 4" holder, 1 carbide insert and a Torx® 15 key	Steel	530676
5/8" x 4" holder, 1 carbide insert and a Torx® 15 key	Steel	530675
1/2" x 4" holder, 6 carbide inserts and a Torx® 15 key	Steel	530659
5/8" x 4" holder, 6 carbide inserts and a Torx® 15 key	Steel	530656
5/8" x 4" holder, 6 carbide inserts and a Torx® 15 key	Stainless Steel	530657

Replacement Inserts

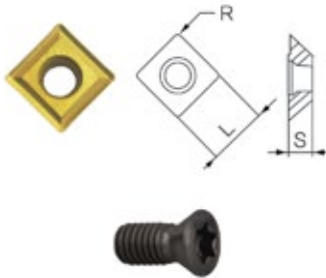

Description	Material/Grade	L (Inch)	S (Inch)	R (Inch)	Code
XDBPIIT308-P	Carbide for Steel	0.433	0.156	0.031	530654
XDBPIIT308-S	Carbide for Stainless Steel	0.433	0.156	0.031	530655

Spare Screw

Description	Code
TSB-3508 (Torx® 15)	530658

Recommended Cutting Data

- = Point angle 90°
- H = Centering depth
- D = Effective diameter
- Vc = Cutting speed: ft./min. or m/min.
- S = Spindle speed
- F = Feed rate
- f = Feed/Rev.: inch/rev. or mm/rev.
- Ff = Feed rate factor

Maximum H

- Centering0.28" (7mm)
- Grooving0.20" (5mm)
- Chamfering....0.28" (7mm)

Inch

$$RPM = \frac{SFM \times 3.82}{D}$$

F = RPM x Inch/Rev x # of Flutes

Metric

$$RPM = \frac{1000 \times SFM}{\pi \times D}$$

F = RPM x mm/Rev x # of Flutes

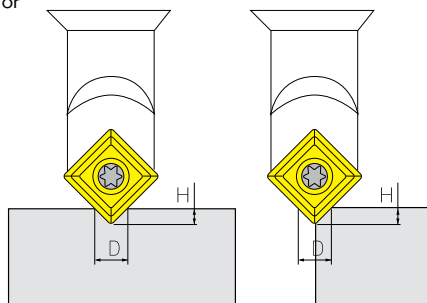

Material	Cutting Speed		Feed/Revolution	
	ft./min.	m/min.	inch/rev.	mm/rev.
Carbon Steel	400-500	120-150	0.002	0.05
Alloy Steel	330-400	100-120	0.0015	0.04
High Alloy Steel	200-260	60-80	0.001	0.03
Hard Steel < HRC40	200-260	60-80	0.001	0.03
Hard Steel, 40	165-200	50-60	0.001	0.03
Stainless Steel	165-200	50-60	0.001	0.03
Gray Cast Iron	260-332	80-102	0.002	0.05

MULTI-V Drill Mill Multi-Function Tool

Micrograin Solid Carbide – 90° Angle

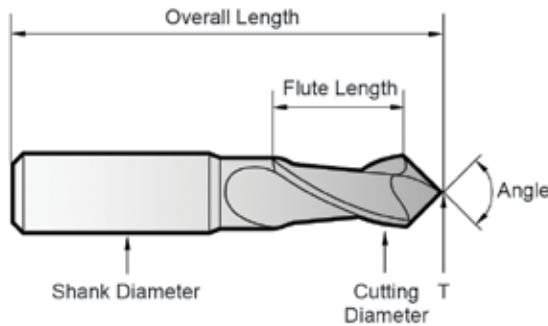
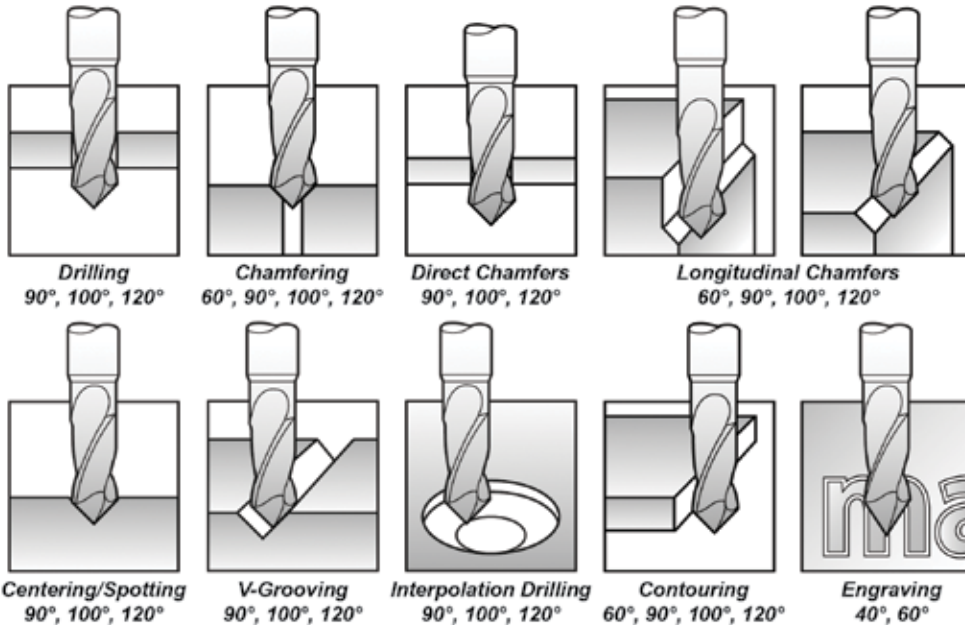

Web thickness: $T=0.1 \times D$

Tolerances

Diagrams		Angle	Shank Diameter	
0.020-0.118	-0 -0.0010	$\pm 1^\circ$	0.118	0-0.00020
0.157-0.236	-0 -0.0012	$\pm 1^\circ$	0.157-0.197	0-0.00030
0.250-0.394	-0 -0.0014	$\pm 1^\circ$	0.197-0.394	0-0.00035
0.472-0.630	-0.0018 -0.0036	$\pm 1^\circ$	0.500-0.630	0-0.00045
0.787	-0.0025 -0.0045	$\pm 1^\circ$	0.787	0-0.00050

Cutting Diameter (Inch)	Cutting Diameter (mm)	Overall Length (Inch)	Flute Length (Inch)	Shank Diameter (Inch)	(Series 8090) Code	Cutting Diameter (Inch)	Cutting Diameter (mm)	Overall Length (Inch)	Flute Length (Inch)	Shank Diameter (Inch)	(Series 8090) Code
0.020	0.50	1-1/2	0.040	0.118	540401	0.157	4.00	2	0.315	0.197	540414
0.024	0.60	1-1/2	0.047	0.118	540402	3/16	4.76	2	0.375	1/4	540415
0.028	0.70	1-1/2	0.055	0.118	540403	0.197	5.00	2	0.395	0.236	540416
0.031	0.80	1-1/2	0.063	0.118	540404	0.236	6.00	2-3/8	0.475	0.315	540417
0.035	0.90	1-1/2	0.071	0.118	540405	1/4	6.35	2-3/8	0.475	5/16	540418
0.039	1.00	1-1/2	0.080	0.118	540406	5/16	7.93	2-3/4	0.630	3/8	540419
0.047	1.20	1-1/2	0.095	0.118	540407	0.315	8.00	2-3/4	0.630	0.394	540420
0.055	1.40	1-1/2	0.110	0.118	540408	3/8	9.52	2-3/4	0.710	1/2	540421
0.059	1.50	1-1/2	0.120	0.118	540409	0.394	10.00	2-3/4	0.710	0.472	540422
0.063	1.60	1-1/2	0.125	0.118	314000	0.472	12.00	2-3/4	0.790	0.472	540423
0.071	1.80	1-1/2	0.140	0.118	540410	1/2	12.70	2-3/4	0.790	1/2	540424
0.078	2.00	1-1/2	0.160	0.118	540411	5/8	15.07	3-1/8	1.000	5/8	540425
0.098	2.50	1-1/2	0.195	0.118	540412	0.630	16.00	3-1/8	1.025	0.630	540426
0.118	3.00	2	0.240	0.157	540413	0.787	20.00	4	1.260	0.787	540427



Chamfering Biconical Cutters

K15 Carbide – Front & Back

- Special design equals positive cut plus relieving profile
- Unequalled surface finish
- Impressive performance
- Extended tools profile life



Bi-Face: For superior finish operations, Bi-Face has a constant relieved profile. Longitudinal or interpolated work for front and back chamfering of edges and holes.

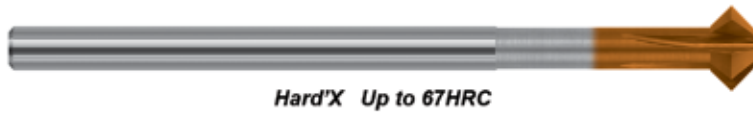

Hard'X: AlTiN carbide tool coating with a high hardness of 3500 HV. This coating shows high thermic stability and excellent protection against heat and wear. Ideal for dry machining - high speed cut - in treated steels and dies up to 67 HRC.

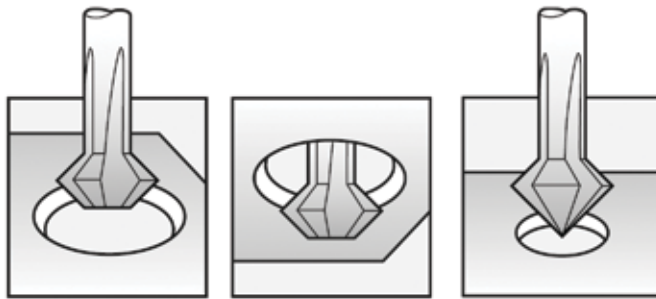

Front

Back

Deburring

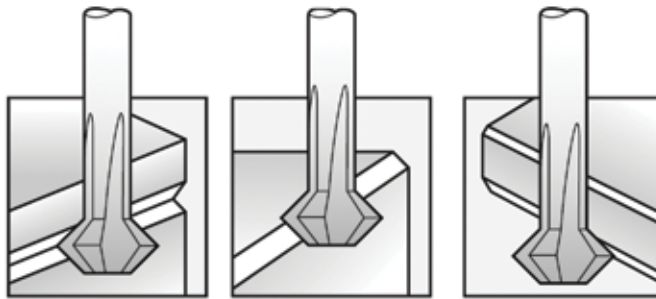

V-Grooving

Top & Bottom Chamfering

Tolerances			
D	Tolerance	L	Angle
0.04 - 0.197	0 - 0.002	± 0.04	±1°
0.236 - 0.63	0 - 0.004	± 0.04	±1°

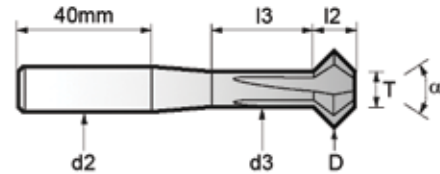

Standard 4 Flute Bi-Face 90° Angle (Series 8490) & Hard'X 90° Angle (Series 8490-H)

Diameter Inch (mm)	d2 (Inch)	d3 Max. (Inch)	T Max. (Inch)	L Min. (Inch)	L2 (Inch)	L3 (Inch)	90° Angle (Series 8490)	90° Angle (Series 8490-H)
							Bi-Face Code	Hard'X Code
0.118 (3)	0.236	0.087	0.047	4	0.051	0.394	314198	314222
0.157 (4)	0.236	0.114	0.063	4	0.069	0.472	314201	314225
0.197 (5)	0.236	0.134	0.079	4	0.091	0.591	314204	314228
0.236 (6)	0.236	0.154	0.094	4	0.114	0.709	314207	314231
0.315 (8)	0.236	0.193	0.193	4	0.118	1.339	314210	314234
0.394 (10)	0.236	0.232	0.232	4	0.157	1.339	314213	314237
0.472 (12)	0.236	0.232	0.232	4	0.236	1.339	314216	314240
0.630 (16)	0.394	0.311	0.311	4	0.315	1.339	314219	314243

Chucking Reamers

High Speed Steel & Cobalt – Straight Shank – Straight & Spiral Flutes



Fractional Sizes

Size (Inch)	Decimal Equiv. (Inch)	Flute Length (Inch)	Overall Length (Inch)	HSS		Cobalt	Size (Inch)	Decimal Equiv. (Inch)	Flute Length (Inch)	Overall Length (Inch)	HSS		Cobalt
				Straight Flute	Spiral Flute	Straight Flute					Straight Flute	Spiral Flute	Straight Flute
				Code	Code	Code					Code	Code	Code
3/64	0.0469	1/2	2-1/2	-	600079	-	43/64	0.6719	2-1/4	9	600039	-	-
1/16	0.0625	1/2	2-1/2	600000	600080	-	11/16	0.6875	2-1/4	9	600040	600114	600163
5/64	0.0781	3/4	3	600001	600081	-	45/64	0.7031	2-1/4	9	600041	-	-
3/32	0.0938	3/4	3	600002	600082	-	23/32	0.7188	2-1/4	9	600042	600115	600164
7/64	0.1094	7/8	3-1/2	600003	-	-	47/64	0.7344	2-1/2	9-1/2	600043	-	-
1/8	0.1250	7/8	3-1/2	600004	600084	600133	3/4	0.7500	2-1/2	9-1/2	600044	600116	600165
9/64	0.1406	1	4	600005	600085	600134	49/64	0.7656	2-1/2	9-1/2	600045	-	-
5/32	0.1562	1	4	600006	600086	600135	25/32	0.7812	2-1/2	9-1/2	600046	600117	600166
11/64	0.1719	1-1/8	4-1/2	600007	600087	600136	51/64	0.7969	2-1/2	9-1/2	600047	-	-
3/16	0.1875	1-1/8	4-1/2	600008	600088	600137	13/16	0.8125	2-1/2	9-1/2	600048	600118	600167
13/64	0.2031	1-1/4	5	600009	600089	600138	53/64	0.8281	2-1/2	9-1/2	600049	-	-
7/32	0.2188	1-1/4	5	600010	600090	600139	27/32	0.8438	2-1/2	9-1/2	600050	600119	600168
15/64	0.2344	1-1/2	6	600011	600091	600140	55/64	0.8594	2-5/8	10	600051	-	-
1/4	0.2500	1-1/2	6	600012	600092	600141	7/8	0.8750	2-5/8	10	600052	600120	600169
17/64	0.2656	1-1/2	6	600013	600093	600142	57/64	0.8906	2-5/8	10	600053	-	-
9/32	0.2812	1-1/2	6	600014	600094	600143	29/32	0.9062	2-5/8	10	600054	600121	600170
19/64	0.2969	1-1/2	6	600015	600095	600144	59/64	0.9219	2-5/8	10	600055	-	-
5/16	0.3125	1-1/2	6	600016	600096	600145	15/16	0.9375	2-5/8	10	600056	600122	600171
21/64	0.3281	1-1/2	6	600017	600097	600146	61/64	0.9531	2-5/8	10	600057	-	-
11/32	0.3438	1-1/2	6	600018	600098	600147	31/32	0.9688	2-5/8	10	600058	600123	600172
23/64	0.3594	1-3/4	7	600019	600099	600148	63/64	0.9844	2-5/5	10	600059	-	-
3/8	0.3750	1-3/4	7	600020	600100	600149	1	1.0000	2-3/4	10-1/2	600060	600124	600173
25/64	0.3906	1-3/4	7	600021	600101	600150	1-1/32	1.0312	2-3/4	10-1/2	600061	-	-
13/32	0.4062	1-3/4	7	600022	600102	600151	1-1/16	1.0625	2-3/4	10-1/2	600062	600125	-
27/64	0.4219	1-3/4	7	600023	600103	600152	1-3/32	1.0938	2-3/4	10-1/2	600063	-	-
7/16	0.4375	1-3/4	7	600024	600104	600153	1-1/8	1.1250	2-7/8	10-1/2	600064	600126	-
29/64	0.4531	1-3/4	7	600025	600105	600154	1-5/32	1.1562	2-7/8	10-1/2	600065	-	-
15/32	0.4688	1-3/4	7	600026	600106	600155	1-3/16	1.1875	2-7/8	10-1/2	600066	600127	-
31/64	0.4844	2	8	600027	600107	600156	1-7/32	1.2187	2-7/8	10-1/2	600067	-	-
1/2	0.5000	2	8	600028	600108	600157	1-1/4	1.2500	3	11-1/2	600068	600128	-
33/64	0.5156	2	8	600029	-	-	1-5/16	1.3125	3	11-1/2	600069	600129	-
17/32	0.5312	2	8	600030	600109	600158	1-3/8	1.3750	3-1/4	12	600070	600130	-
35/64	0.5469	2	8	600031	-	-	1-7/16	1.4375	3-1/4	12	600071	600131	-
9/16	0.5625	2	8	600032	600110	600159	1-1/2	1.5000	3-1/2	12-1/2	600072	600132	-
37/64	0.5781	2	8	600033	-	-	1-9/16	1.5625	3-1/2	12-1/2	600073	-	-
19/32	0.5938	2	8	600034	600111	600160	1-5/8	1.6250	3-1/2	12-1/2	600074	-	-
39/64	0.6094	2-1/4	9	600035	-	-	1-11/16	1.6875	3-1/2	12-1/2	600075	-	-
5/8	0.6250	2-1/4	9	600036	600112	600161	1-3/4	1.7500	4	13-1/2	600076	-	-
41/64	0.6406	2-1/4	9	600037	-	-	1-7/8	1.8750	4	14	600077	-	-
21/32	0.6562	2-1/4	9	600038	600113	600162	2	2.0000	4	14	600078	-	-

Chucking Reamers

High Speed Steel – Straight Shank – Straight Flute



REAMERS

Letter Sizes

Size	Decimal Equiv. (Inch)	Flute Length (Inch)	Overall Length (Inch)	Code
A	0.2340	1-1/2	6	600174
B	0.2380	1-1/2	6	600175
C	0.2420	1-1/2	6	600176
D	0.2460	1-1/2	6	600177
E	0.2500	1-1/2	6	600012
F	0.2570	1-1/2	6	600178
G	0.2610	1-1/2	6	600179
H	0.2660	1-1/2	6	600180

Size	Decimal Equiv. (Inch)	Flute Length (Inch)	Overall Length (Inch)	Code
I	0.2720	1-1/2	6	600181
J	0.2770	1-1/2	6	600182
K	0.2810	1-1/2	6	600183
L	0.2900	1-1/2	6	600184
M	0.2950	1-1/2	6	600185
N	0.3020	1-1/2	6	600186
O	0.3160	1-1/2	6	600187
P	0.3230	1-1/2	6	600188

Size	Decimal Equiv. (Inch)	Flute Length (Inch)	Overall Length (Inch)	Code
Q	0.3320	1-1/2	6	600189
R	0.3390	1-1/2	6	600190
S	0.3480	1-3/4	7	600191
T	0.3580	1-3/4	7	600192
U	0.3680	1-3/4	7	600193
V	0.3770	1-3/4	7	600194
W	0.3860	1-3/4	7	600195
X	0.3970	1-3/4	7	600196
Y	0.4040	1-3/4	7	600197
Z	0.4130	1-3/4	7	600198

Wire Gage Sizes

Size	Decimal Equiv. (Inch)	Flute Length (Inch)	Overall Length (Inch)	Code
1	0.2280	1-1/2	6	600199
2	0.2210	1-1/2	6	600200
3	0.2130	1-1/4	5	600201
4	0.2090	1-1/4	5	600202
5	0.2055	1-1/4	5	600203
6	0.2040	1-1/4	5	600204
7	0.2010	1-1/4	5	600205
8	0.1990	1-1/4	5	600206
9	0.1960	1-1/4	5	600207
10	0.1935	1-1/4	5	600208

Size	Decimal Equiv. (Inch)	Flute Length (Inch)	Overall Length (Inch)	Code
11	0.1910	1-1/4	5	600209
12	0.1890	1-1/8	4-1/2	600210
13	0.1850	1-1/8	4-1/2	600211
14	0.1820	1-1/8	4-1/2	600212
15	0.1800	1-1/8	4-1/2	600213
16	0.1770	1-1/8	4-1/2	600214
17	0.1730	1-1/8	4-1/2	600215
18	0.1695	1-1/8	4-1/2	600216
19	0.1660	1-1/8	4-1/2	600217
20	0.1610	1-1/8	4-1/2	600218

Size	Decimal Equiv. (Inch)	Flute Length (Inch)	Overall Length (Inch)	Code
21	0.1590	1-1/8	4-1/2	600219
22	0.1570	1	4	600220
23	0.1540	1	4	600221
24	0.1520	1	4	600222
25	0.1495	1	4	600223
26	0.1470	1	4	600224
27	0.1440	1	4	600225
28	0.1405	1	4	600226
29	0.1360	1	4	600227
30	0.1285	7/8	3-1/2	600228
31	0.1200	7/8	3-1/2	600229
32	0.1160	7/8	3-1/2	600230

Over & Under Sizes

Size (Inch)	Flute Length (Inch)	Overall Length (Inch)	Code
0.1240	7/8	3-1/2	600231
0.1260	7/8	3-1/2	600232
0.1865	1-1/8	4-1/2	600233
0.1885	1-1/8	4-1/2	600234

Size (Inch)	Flute Length (Inch)	Overall Length (Inch)	Code
0.2490	1-1/2	6	600235
0.2510	1-1/2	6	600236
0.3115	1-1/2	6	600237
0.3135	1-1/2	6	600238

Size (Inch)	Flute Length (Inch)	Overall Length (Inch)	Code
0.3740	1-3/4	7	600239
0.3760	1-3/4	7	600240
0.4365	1-3/4	7	600241
0.4385	1-3/4	7	600242
0.4990	2	8	600243
0.5010	2	8	600244

Dowel Pin Sizes

Size (Inch)	Flute Length (Inch)	Overall Length (Inch)	Code
0.1230	7/8	3-1/2	600245
0.1247	7/8	3-1/2	600246
0.1855	1-1/8	4-1/2	600247
0.1870	1-1/8	4-1/2	600248

Size (Inch)	Flute Length (Inch)	Overall Length (Inch)	Code
0.2480	1-1/2	6	600249
0.2495	1-1/2	6	600250
0.3105	1-1/2	6	600251
0.3120	1-1/2	6	600252

Size (Inch)	Flute Length (Inch)	Overall Length (Inch)	Code
0.3730	1-3/4	7	600253
0.3745	1-3/4	7	600254
0.4355	1-3/4	7	600255
0.4370	1-3/4	7	600256
0.4980	2	8	600257
0.4995	2	8	600258



Chucking Reamers

High Speed Steel – Straight Shank – Straight Flute

Sets

Size	No. of Pieces	Code
Fractional Sizes - 1/16" to 1/2" by 64ths in Metal Index	29	311435
Letter Sizes - A to Z in Metal Index	26	311436
Wire Gage Sizes - 1 to 60 in Plastic Pouch	60	311437
Over and Under Sizes - 0.124" to 0.501" in Metal Index	14	311438
Dowel Pin Sizes - 0.123" to 0.4995" in Metal Index	14	311439

Decimal Reamers – Right Hand Cut



TOLERANCE UP TO 0.250: +0.0001"/+0.0004"
0.250 TO 0.750: +0.0001"/+0.0005"

Decimal Equivalent (Inch)	Code	Decimal Equivalent (Inch)	Code	Decimal Equivalent (Inch)	Code	Decimal Equivalent (Inch)	Code	Decimal Equivalent (Inch)	Code
0.1230	600245	0.1915	600295	0.2460	600341	0.3115	600237	0.4390	600417
0.1240	600231	0.1920	600296	0.2470	600342	0.3120	600252	0.4410	600418
0.1245	600259	0.1930	600297	0.2475	600343	0.3130	600382	0.4420	600419
0.1247	600246	0.1940	600298	0.2480	600249	0.3135	600238	0.4430	600420
0.1255	600260	0.1950	600299	0.2485	600344	0.3140	600383	0.4440	600421
0.1260	600232	0.1960	600300	0.2490	600235	0.3145	600384	0.4480	600422
0.1265	600261	0.1970	600301	0.2495	600250	0.3150	600385	0.4490	600423
0.1270	600262	0.1980	600302	0.2505	600345	0.3160	600386	0.4550	600424
0.1280	600263	0.1990	600303	0.2510	600236	0.3165	600387	0.4560	600425
0.1290	600264	0.2000	600304	0.2515	600346	0.3170	600388	0.4820	600426
0.1295	600265	0.2020	600305	0.2520	600347	0.3180	600389	0.4900	600427
0.1300	600266	0.2024	600306	0.2530	600348	0.3190	600390	0.4970	600428
0.1370	600267	0.2030	600307	0.2540	600349	0.3200	600391	0.4980	600257
0.1375	600268	0.2050	600308	0.2550	600350	0.3220	600392	0.4990	600243
0.1380	600269	0.2060	600309	0.2560	600351	0.3240	600393	0.4995	600258
0.1400	600270	0.2070	600310	0.2570	600352	0.3250	600394	0.5010	600244
0.1410	600271	0.2080	600311	0.2580	600353	0.3270	600395	0.5015	600429
0.1415	600272	0.2090	600312	0.2590	600354	0.3280	600396	0.5020	600430
0.1420	600273	0.2100	600313	0.2600	600355	0.3290	600397	0.5030	600431
0.1520	600274	0.2110	600314	0.2650	600356	0.3300	600398	0.5040	600432
0.1560	600275	0.2120	600315	0.2690	600357	0.3360	600399	0.5050	600433
0.1580	600276	0.2140	600316	0.2710	600358	0.3370	600400	0.5240	600434
0.1670	600277	0.2150	600317	0.2760	600359	0.3440	600401	0.5250	600435
0.1720	600278	0.2155	600318	0.2770	600360	0.3490	600402	0.5260	600436
0.1740	600279	0.2160	600319	0.2800	600361	0.3550	600403	0.5300	600437
0.1750	600280	0.2170	600320	0.2820	600362	0.3590	600404	0.5500	600438
0.1760	600281	0.2180	600321	0.2830	600363	0.3690	600405	0.5580	600439
0.1770	600282	0.2190	600322	0.2840	600364	0.3730	600253	0.5590	600440
0.1810	600283	0.2200	600323	0.2860	600365	0.3740	600239	0.5615	600441
0.1820	600284	0.2211	600324	0.2870	600366	0.3745	600254	0.5690	600442
0.1840	600285	0.2270	600325	0.2890	600367	0.3755	600406	0.5740	600443
0.1845	600286	0.2300	600326	0.2900	600368	0.3760	600240	0.5840	600444
0.1850	600287	0.2310	600327	0.2920	600369	0.3765	600407	0.5850	600445
0.1855	600247	0.2320	600328	0.2930	600370	0.3770	600408	0.5860	600446
0.1860	600288	0.2340	600329	0.2940	600371	0.3790	600409	0.5880	600447
0.1865	600233	0.2350	600330	0.2960	600372	0.3800	600410	0.6050	600448
0.1870	600248	0.2360	600331	0.2980	600373	0.3860	600411	0.6220	600449
0.1875	600289	0.2370	600332	0.2990	600374	0.3880	600412	0.6240	600450
0.1880	600290	0.2380	600333	0.3030	600375	0.4000	600413	0.6250	600451
0.1885	600234	0.2390	600334	0.3050	600376	0.4070	600414	0.6255	600452
0.1895	600291	0.2400	600335	0.3060	600377	0.4300	600415	0.6260	600453
0.1900	600292	0.2410	600336	0.3070	600378	0.4320	600416	0.6300	600454
0.1905	600293	0.2420	600337	0.3090	600379	0.4355	600255	0.7480	600455
0.1910	600294	0.2430	600338	0.3100	600380	0.4365	600241	0.7490	600456
		0.2440	600339	0.3105	600251	0.4370	600256	0.7510	600457
		0.2450	600340	0.3110	600381	0.4385	600242	0.7580	600458

Metric Chucking Reamers

High Speed Steel – Straight & Taper Shanks – Straight Flutes



REAMERS

Size (mm)	Decimal Equivalent (Inch)	Shank Diameter (mm)	Straight Flutes			Size (mm)	Decimal Equivalent (Inch)	Shank Diameter (mm)	Straight Flutes		
			Straight Shank	Taper Shank					Straight Shank	Taper Shank	
				Code	Morse Taper					Code	Code
2.5	0.0984	2.5	535831	-	-	17.5	0.6890	14.0	535861	-	-
3.0	0.1181	3.0	535832	-	-	18.0	0.7087	14.0	535862	2	600472
3.5	0.1375	3.5	535833	-	-	18.5	0.7283	16.0	535863	-	-
4.0	0.1575	4.0	535834	-	-	19.0	0.7480	16.0	535864	2	600473
4.5	0.1772	4.5	535835	-	-	19.5	0.7777	16.0	535865	-	-
5.0	0.1968	5.0	535836	1	600459	20.0	0.7874	16.0	535866	2	600474
5.5	0.2165	5.6	535837	-	-	20.5	0.8071	18.0	535867	-	-
6.0	0.2362	5.6	535838	1	600460	21.0	0.8268	18.0	535868	2	600475
6.5	0.2559	6.3	535839	-	-	21.5	0.8465	18.0	535869	-	-
7.0	0.2756	7.1	535840	1	600461	22.0	0.8661	18.0	535870	2	600476
7.5	0.2953	7.1	535841	-	-	22.5	0.8858	18.0	535871	-	-
8.0	0.3150	8.0	535842	1	600462	23.0	0.9055	18.0	535872	2	600477
8.5	0.3346	8.0	535843	-	-	23.5	0.9252	20.0	535873	-	-
9.0	0.3543	9.0	535844	1	600463	24.0	0.9449	20.0	535874	3	600478
9.5	0.3740	9.0	535845	-	-	24.5	0.9646	20.0	535875	-	-
10.0	0.3937	10.0	535846	1	600464	25.0	0.9843	20.0	535876	3	600479
10.5	0.4133	10.0	535847	-	-	26.0	1.0236	-	-	3	600480
11.0	0.4331	10.0	535848	1	600465	27.0	1.0623	-	-	3	600481
11.5	0.4528	10.0	535849	-	-	28.0	1.1024	-	-	3	600482
12.0	0.4724	10.0	535850	1	600466	29.0	1.1417	-	-	3	600483
12.5	0.4921	10.0	535851	-	-	30.0	1.1811	-	-	3	600484
13.0	0.5118	10.0	535852	1	600467	31.0	1.2205	-	-	3	600485
13.5	0.5315	12.5	535853	-	-	32.0	1.2598	-	-	4	600486
14.0	0.5512	12.5	535854	1	600468	33.0	1.2992	-	-	4	600487
14.5	0.5709	12.5	535855	-	-	34.0	1.3386	-	-	4	600488
15.0	0.5906	12.5	535856	2	600469	35.0	1.3780	-	-	4	600489
15.5	0.6102	12.5	535857	-	-	36.0	1.4173	-	-	4	600490
16.0	0.6299	12.5	535858	2	600470	37.0	1.4567	-	-	4	600491
16.5	0.6496	14.0	535859	-	-	38.0	1.4961	-	-	4	600492
17.0	0.6693	14.0	535860	2	600471	40.0	1.5748	-	-	4	600493

Chucking Reamers

High Speed Steel – Taper Shank – Straight & Spiral Flutes



Size (Inch)	Decimal Equiv. (Inch)	Flute Length (Inch)	Overall Length (Inch)	Morse Taper	HSS		Size (Inch)	Decimal Equiv. (Inch)	Flute Length (Inch)	Overall Length (Inch)	Morse Taper	HSS	
					Straight Flute	Spiral Flute						Straight Flute	Spiral Flute
1/4	0.2500	1-1/2	6	1	535001	535051	5/8	0.6250	2-1/4	9	2	535020	535070
9/32	0.2812	1-1/2	6	1	535003	535053	21/32	0.6562	2-1/4	9	2	535021	535071
5/16	0.3125	1-1/2	6	1	535004	535054	11/16	0.6875	2-1/4	9	2	535022	535072
11/32	0.3438	1-1/2	6	1	535006	535056	23/32	0.7188	2-1/4	9	2	535023	535073
3/8	0.3750	1-3/4	7	1	535008	535058	3/4	0.7500	2-1/2	9-1/2	2	535025	535075
13/32	0.4062	1-3/4	7	1	535009	535059	25/32	0.7812	2-1/2	9-1/2	2	535026	535076
7/16	0.4375	1-3/4	7	1	535010	535060	13/16	0.8125	2-1/2	9-1/2	2	535027	535077
15/32	0.4688	1-3/4	7	1	535011	535061	27/32	0.8438	2-1/2	9-1/2	2	535028	535078
1/2	0.5000	2	8	1	535013	535063	7/8	0.8750	2-5/8	10	2	535029	535079
17/32	0.5312	2	8	1	535015	535065	29/32	0.9062	2-5/8	10	2	535030	535080
9/16	0.5625	2	8	1	535017	535067	15/16	0.9375	2-5/8	10	3	535031	535081
19/32	0.5938	2	8	1	535019	535069	31/32	0.9688	2-5/8	10	3	535032	535082

Chucking Reamers

High Speed Steel – Taper Shank – Straight & Spiral Flutes (continued)



Size (Inch)	Decimal Equiv. (Inch)	Flute Length (Inch)	Overall Length (Inch)	Morse Taper	HSS	
					Straight Flute	Spiral Flute
					Code	Code
1	1.0000	2-3/4	10-1/2	3	535033	535083
1-1/16	1.0625	2-3/4	10-1/2	3	535034	535084
1-1/8	1.1250	2-7/8	11	3	535035	535085
1-5/32	1.1562	2-7/8	11	3	-	535086
1-3/16	1.1875	2-7/8	11	3	535037	535087
1-1/4	1.2500	3	11-1/2	4	535038	535088

Size (Inch)	Decimal Equiv. (Inch)	Flute Length (Inch)	Overall Length (Inch)	Morse Taper	HSS	
					Straight Flute	Spiral Flute
					Code	Code
1-5/16	1.3125	3	11-1/2	4	535039	535089
1-3/8	1.3750	3-1/4	12	4	535040	535090
1-7/16	1.4375	3-1/4	12	4	535041	535091
1-1/2	1.5000	3-1/2	12-1/2	4	535042	535092
1-3/4	1.7500	4	13-1/2	4	-	535096
2	2.0000	4	14-1/2	4	-	535097

Taper Reamer Set – Fast Spiral

4 Pieces



- Made from special Hi-Tungsten tool steel, gold surface treated body and clearance for maximum lubricity
- Specially designed for reaming structural steel plate commonly found in truck frames, rail cars, bridges and pressure vessels
- The fast spiral is more aggressive than the standard spiral type

Size	Description	Code
3/8", 1/2", 5/8", and 3/4" Fitted Case	3 Flats on Shank Gold Finish	750011

Chucking Reamers

Carbide Tipped – Straight & Taper Shanks – Straight Flutes



Size (Inch)	No. of Flutes	Flute Length (Inch)	OAL (Inch)	Carbide Tipped			
				Straight Shank		Taper Shank	
				Shank Dia. (Inch)	Code	Morse Taper	Code
3/16	4	1-1/8	4-1/2	11/64	555601	-	-
7/32	4	1-1/4	5	13/64	555602	-	-
1/4	4	1-1/2	6	15/64	555603	1	555633
9/32	4	1-1/2	6	15/64	555604	1	555634
5/16	4	1-1/2	6	9/32	555605	1	555635
11/32	4	1-1/2	6	9/32	555606	1	555636
3/8	4	1-3/4	7	5/16	555607	1	555637
13/32	4	1-3/4	7	5/16	555608	1	555638
7/16	4	1-3/4	7	3/8	555609	1	555639
15/32	4	1-3/4	7	3/8	555610	1	555640
1/2	6	2	8	7/16	555611	1	555641
9/16	6	2	8	7/16	555612	1	555642
5/8	6	2-1/4	9	9/16	555613	2	555643
11/16	6	2-1/4	9	9/16	555614	2	555644

Size (Inch)	No. of Flutes	Flute Length (Inch)	OAL (Inch)	Carbide Tipped			
				Straight Shank		Taper Shank	
				Shank Dia. (Inch)	Code	Morse Taper	Code
3/4	6	2-1/2	9-1/2	5/8	555615	2	555645
13/16	6	2-1/2	9-1/2	5/8	555616	2	555646
7/8	6	2-5/8	10	3/4	555617	2	555647
15/16	8	2-5/8	10	3/4	555618	3	555648
1	8	2-3/4	10-1/2	7/8	555619	3	555649
1-1/16	8	2-3/4	10-1/2	7/8	555620	3	555650
1-1/8	8	2-7/8	11	7/8	555621	3	555651
1-3/16	8	2-7/8	11	1	555622	3	555652
1-1/4	8	3	11-1/2	1	555623	-	-
1-5/16	8	3	11-1/2	-	-	4	555654
1-3/8	8	3-1/4	12	-	-	4	555655
1-7/16	8	3-1/4	12	-	-	4	555656
1-1/2	8	3-1/2	12-1/2	1-1/4	555627	4	555657

Chucking Reamers

Micrograin Solid Carbide – Straight Shank – 4 & 6 Straight Flutes



Diameter	Diameter Tolerances
0.0280" to 0.2500"	+0.0000/+0.0002"
0.2501" to 0.5000"	+0.0000/+0.0003"

- Decimal, fractional, wire, letter and metric sizes
- C2 micrograin solid carbide with 10% cobalt
- Suitable for reaming tough and abrasive materials
- Shank same size as cutting diameter
- Sizes include oversize, undersize and dowel pin size
- 4 flute reamers up to 0.255" diameter, 6 flute reamers on all other sizes
- Sizes from #70 to 1/4" are in increments of 0.0005" and sizes from 0.2505" to 0.5000" are in increments of 0.001"

D/P = DOWEL PIN SIZE, O/S = OVERSIZE, U/S = UNDERSIZE

High Speed Steel and Cobalt reamers also available

REAMERS

Size	Decimal Equivalent (Inch)	Flute Length (Inch)	Overall Length (Inch)	Code
70	0.0280	1/4	1-1/2	940000
69	0.0292	1/4	1-1/2	940002
0.0300	0.0300	1/4	1-1/2	940310
68	0.0310	1/4	1-1/2	940004
1/32	0.0312	1/4	1-1/2	940006
0.0315	0.0315	1/4	1-1/2	940312
67	0.0320	1/4	1-1/2	940008
0.0325	0.0325	1/4	1-1/2	940314
66	0.0330	1/4	1-1/2	940010
0.0335	0.0335	1/4	1-1/2	940316
0.0340	0.0340	1/4	1-1/2	940318
0.0345	0.0345	1/4	1-1/2	940320
65	0.0350	1/4	1-1/2	940012
0.0355	0.0355	1/4	1-1/2	940322
64	0.0360	1/4	1-1/2	940014
0.0365	0.0365	1/4	1-1/2	940324
63	0.0370	1/4	1-1/2	940016
0.0375	0.0375	1/4	1-1/2	940326
62	0.0380	1/4	1-1/2	940018
0.0385	0.0385	1/4	1-1/2	940328
61	0.0390	1/4	1-1/2	940020
1 mm	0.0394	1/4	1-1/2	940022
0.0395	0.0395	1/4	1-1/2	940330
60	0.0400	1/4	1-1/2	940024
0.0405	0.0405	1/4	1-1/2	940332
59	0.0410	1/4	1-1/2	940026
0.0415	0.0415	1/4	1-1/2	940334
58	0.0420	3/8	1-1/2	940028
0.0425	0.0425	3/8	1-1/2	940336
57	0.0430	3/8	1-1/2	940030
0.0435	0.0435	3/8	1-1/2	940338
0.0440	0.0440	3/8	1-1/2	940340
0.0445	0.0445	3/8	1-1/2	940342
0.0450	0.0450	3/8	1-1/2	940344
0.0455	0.0455	3/8	1-1/2	940346
0.0460	0.0460	3/8	1-1/2	940348
56	0.0465	3/8	1-1/2	940032
3/64	0.0469	3/8	1-1/2	940034
0.0470	0.0470	3/8	1-1/2	940350
0.0475	0.0475	3/8	1-1/2	940352
0.0480	0.0480	3/8	1-1/2	940354
0.0485	0.0485	3/8	1-1/2	940356
0.0490	0.0490	3/8	1-1/2	940358
0.0495	0.0495	3/8	1-1/2	940360
0.0500	0.0500	3/8	1-1/2	940362
0.0505	0.0505	3/8	1-1/2	940364

Size	Decimal Equivalent (Inch)	Flute Length (Inch)	Overall Length (Inch)	Code
0.0510	0.0510	3/8	1-1/2	940366
0.0515	0.0515	3/8	1-1/2	940368
55	0.0520	3/8	1-1/2	940036
0.0525	0.0525	3/8	1-1/2	940370
0.0530	0.0530	3/8	1-1/2	940372
0.0535	0.0535	3/8	1-1/2	940374
0.0540	0.0540	3/8	1-1/2	940376
0.0545	0.0545	3/8	1-1/2	940378
54	0.0550	3/8	1-1/2	940038
0.0555	0.0555	3/8	1-1/2	940380
0.0560	0.0560	3/8	1-1/2	940382
0.0565	0.0565	3/8	1-1/2	940384
0.0570	0.0570	3/8	1-1/2	940386
0.0575	0.0575	3/8	1-1/2	940388
0.0580	0.0580	3/8	1-1/2	940390
0.0585	0.0585	3/8	1-1/2	940392
0.0590	0.0590	3/8	1-1/2	940394
1.5 mm	0.0591	3/8	1-1/2	940040
53	0.0595	3/8	1-1/2	940042
0.0600	0.0600	3/8	1-1/2	940396
0.0605	0.0605	3/8	1-1/2	940398
0.0610	0.0610	3/8	1-1/2	940400
0.0615	0.0615	3/8	1-1/2	940402
0.0620	0.0620	3/8	1-1/2	940404
1/16	0.0625	3/8	1-1/2	940044
0.0630	0.0630	3/8	1-1/2	940406
52	0.0635	3/8	1-1/2	940046
0.0640	0.0640	3/8	1-1/2	940408
0.0645	0.0645	3/8	1-1/2	940410
0.0650	0.0650	3/8	1-1/2	940412
0.0655	0.0655	1/2	1-3/4	940414
0.0660	0.0660	1/2	1-3/4	940416
0.0665	0.0665	1/2	1-3/4	940418
51	0.0670	1/2	1-3/4	940048
0.0675	0.0675	1/2	1-3/4	940420
0.0680	0.0680	1/2	1-3/4	940422
0.0685	0.0685	1/2	1-3/4	940424
0.0690	0.0690	1/2	1-3/4	940426
0.0695	0.0695	1/2	1-3/4	940428
50	0.0700	1/2	1-3/4	940050
0.0705	0.0705	1/2	1-3/4	940430
0.0710	0.0710	1/2	1-3/4	940432
0.0715	0.0715	1/2	1-3/4	940434
0.0720	0.0720	1/2	1-3/4	940436
0.0725	0.0725	1/2	1-3/4	940438
49	0.0730	1/2	1-3/4	940052

Chucking Reamers

Micrograin Solid Carbide – Straight Shank – 4 & 6 Straight Flutes (continued)



REAMERS

Size	Decimal Equivalent (Inch)	Flute Length (Inch)	Overall Length (Inch)	Code	Size	Decimal Equivalent (Inch)	Flute Length (Inch)	Overall Length (Inch)	Code
0.0735	0.0735	1/2	1-3/4	940440	39	0.0995	5/8	2-1/4	940080
0.0740	0.0740	1/2	1-3/4	940442	0.1000	0.1000	5/8	2-1/4	940526
0.0745	0.0745	1/2	1-3/4	940444	0.1005	0.1005	5/8	2-1/4	940528
0.0750	0.0750	1/2	1-3/4	940446	0.1010	0.1010	5/8	2-1/4	940530
0.0755	0.0755	1/2	1-3/4	940448	38	0.1015	5/8	2-1/4	940082
48	0.0760	1/2	1-3/4	940054	0.1020	0.1020	5/8	2-1/4	940532
0.0765	0.0765	1/2	1-3/4	940450	0.1025	0.1025	5/8	2-1/4	940534
0.0770	0.0770	1/2	1-3/4	940452	0.1030	0.1030	5/8	2-1/4	940536
0.0775	0.0775	1/2	1-3/4	940454	0.1035	0.1035	5/8	2-1/4	940538
0.0780	0.0780	1/2	1-3/4	940456	37	0.1040	5/8	2-1/4	940084
5/64	0.0781	1/2	1-3/4	940056	0.1045	0.1045	5/8	2-1/4	940540
47	0.0785	1/2	1-3/4	940058	0.1050	0.1050	5/8	2-1/4	940542
2 mm	0.0787	1/2	1-3/4	940060	0.1055	0.1055	5/8	2-1/4	940544
0.0790	0.0790	1/2	1-3/4	940458	0.1060	0.1060	5/8	2-1/4	940546
0.0795	0.0795	1/2	1-3/4	940460	36	0.1065	5/8	2-1/4	940086
0.0800	0.0800	1/2	1-3/4	940462	0.1070	0.1070	5/8	2-1/4	940548
0.0805	0.0805	1/2	1-3/4	940464	0.1075	0.1075	5/8	2-1/4	940550
46	0.0810	1/2	1-3/4	940062	0.1080	0.1080	5/8	2-1/4	940552
0.0815	0.0815	1/2	2	940466	0.1085	0.1085	5/8	2-1/4	940554
45	0.0820	1/2	2	940064	0.1090	0.1090	5/8	2-1/4	940556
0.0825	0.0825	1/2	2	940468	7/64	0.1094	5/8	2-1/4	940088
0.0830	0.0830	1/2	2	940470	0.1095	0.1095	5/8	2-1/4	940558
0.0835	0.0835	1/2	2	940472	35	0.1100	5/8	2-1/4	940090
0.0840	0.0840	1/2	2	940474	0.1105	0.1105	5/8	2-1/4	940560
0.0845	0.0845	1/2	2	940476	34	0.1110	5/8	2-1/4	940092
0.0850	0.0850	1/2	2	940478	0.1115	0.1115	5/8	2-1/4	940562
0.0855	0.0855	1/2	2	940480	0.1120	0.1120	5/8	2-1/4	940564
44	0.0860	1/2	2	940066	0.1125	0.1125	5/8	2-1/4	940566
0.0865	0.0865	1/2	2	940482	33	0.1130	5/8	2-1/4	940094
0.0870	0.0870	1/2	2	940484	0.1135	0.1135	5/8	2-1/4	940568
0.0875	0.0875	1/2	2	940486	0.1140	0.1140	5/8	2-1/4	940570
0.0880	0.0880	1/2	2	940488	0.1145	0.1145	5/8	2-1/4	940572
0.0885	0.0885	1/2	2	940490	0.1150	0.1150	5/8	2-1/4	940574
43	0.0890	1/2	2	940068	0.1155	0.1155	5/8	2-1/4	940576
0.0895	0.0895	1/2	2	940492	32	0.1160	5/8	2-1/4	940096
0.0900	0.0900	1/2	2	940494	0.1165	0.1165	5/8	2-1/4	940578
0.0905	0.0905	1/2	2	940496	0.1170	0.1170	5/8	2-1/4	940580
0.0910	0.0910	1/2	2	940498	0.1175	0.1175	5/8	2-1/4	940582
0.0915	0.0915	1/2	2	940500	0.1180	0.1180	5/8	2-1/4	940584
0.0920	0.0920	1/2	2	940502	3 mm	0.1181	5/8	2-1/4	940098
0.0925	0.0925	1/2	2	940504	0.1185	0.1185	5/8	2-1/4	940586
0.0930	0.0930	1/2	2	940506	0.1190	0.1190	5/8	2-1/4	940588
42	0.0935	1/2	2	940070	0.1195	0.1195	5/8	2-1/4	940590
3/32	0.0938	1/2	2	940072	31	0.1200	5/8	2-1/4	940100
0.0940	0.0940	1/2	2	940508	0.1205	0.1205	5/8	2-1/4	940592
0.0945	0.0945	1/2	2	940510	0.1210	0.1210	5/8	2-1/4	940594
0.0950	0.0950	1/2	2	940512	0.1215	0.1215	5/8	2-1/4	940596
0.0955	0.0955	1/2	2	940514	0.1220	0.1220	5/8	2-1/4	940598
41	0.0960	1/2	2	940074	0.1225	0.1225	5/8	2-1/4	940600
0.0965	0.0965	1/2	2	940516	D/P	0.1230	5/8	2-1/4	940602
0.0970	0.0970	5/8	2-1/4	940518	0.1235	0.1235	5/8	2-1/4	940604
0.0975	0.0975	5/8	2-1/4	940520	U/S	0.1240	5/8	2-1/4	940606
40	0.0980	5/8	2-1/4	940076	0.1245	0.1245	5/8	2-1/4	940608
2.5 mm	0.0984	5/8	2-1/4	940078	D/P	0.1247	5/8	2-1/4	940610
0.0985	0.0985	5/8	2-1/4	940522	1/8	0.1250	5/8	2-1/4	940102
0.0990	0.0990	5/8	2-1/4	940524	0.1255	0.1255	5/8	2-1/4	940612

Chucking Reamers

Micrograin Solid Carbide – Straight Shank – 4 & 6 Straight Flutes (continued)



Size	Decimal Equivalent (Inch)	Flute Length (Inch)	Overall Length (Inch)	Code	Size	Decimal Equivalent (Inch)	Flute Length (Inch)	Overall Length (Inch)	Code
O/S	0.1260	5/8	2-1/4	940614	0.1525	0.1525	3/4	2-1/2	940708
0.1265	0.1265	5/8	2-1/4	940616	0.1530	0.1530	3/4	2-1/2	940710
0.1270	0.1270	5/8	2-1/4	940618	0.1535	0.1535	3/4	2-1/2	940712
0.1275	0.1275	5/8	2-1/4	940620	23	0.1540	3/4	2-1/2	940124
0.1280	0.1280	5/8	2-1/4	940622	0.1541	0.1541	3/4	2-1/2	940714
30	0.1285	5/8	2-1/4	940104	0.1545	0.1545	3/4	2-1/2	940716
0.1290	0.1290	5/8	2-1/4	940624	0.1550	0.1550	3/4	2-1/2	940718
0.1295	0.1295	5/8	2-1/4	940626	0.1555	0.1555	3/4	2-1/2	940720
0.1300	0.1300	5/8	2-1/4	940628	0.1560	0.1560	3/4	2-1/2	940722
0.1305	0.1305	3/4	2-1/2	940630	5/32	0.1562	3/4	2-1/2	940126
0.1310	0.1310	3/4	2-1/2	940632	0.1565	0.1565	3/4	2-1/2	940724
0.1315	0.1315	3/4	2-1/2	940634	22	0.1570	3/4	2-1/2	940128
0.1320	0.1320	3/4	2-1/2	940636	4 mm	0.1575	3/4	2-1/2	940130
0.1325	0.1325	3/4	2-1/2	940638	0.1580	0.1580	3/4	2-1/2	940726
0.1330	0.1330	3/4	2-1/2	940640	0.1585	0.1585	3/4	2-1/2	940728
0.1335	0.1335	3/4	2-1/2	940642	21	0.1590	3/4	2-1/2	940132
0.1340	0.1340	3/4	2-1/2	940644	0.1595	0.1595	3/4	2-1/2	940730
0.1345	0.1345	3/4	2-1/2	940646	0.1600	0.1600	3/4	2-1/2	940732
0.1350	0.1350	3/4	2-1/2	940648	0.1605	0.1605	3/4	2-1/2	940734
0.1355	0.1355	3/4	2-1/2	940650	20	0.1610	7/8	2-3/4	940134
29	0.1360	3/4	2-1/2	940106	0.1615	0.1615	7/8	2-3/4	940736
0.1365	0.1365	3/4	2-1/2	940652	0.1620	0.1620	7/8	2-3/4	940738
0.1370	0.1370	3/4	2-1/2	940654	0.1625	0.1625	7/8	2-3/4	940740
0.1375	0.1375	3/4	2-1/2	940656	0.1630	0.1630	7/8	2-3/4	940742
3.5 mm	0.1378	3/4	2-1/2	940108	0.1635	0.1635	7/8	2-3/4	940744
0.1380	0.1380	3/4	2-1/2	940658	0.1640	0.1640	7/8	2-3/4	940746
0.1385	0.1385	3/4	2-1/2	940660	0.1645	0.1645	7/8	2-3/4	940748
0.1390	0.1390	3/4	2-1/2	940662	0.1650	0.1650	7/8	2-3/4	940750
0.1395	0.1395	3/4	2-1/2	940664	0.1655	0.1655	7/8	2-3/4	940752
0.1400	0.1400	3/4	2-1/2	940666	19	0.1660	7/8	2-3/4	940136
28	0.1405	3/4	2-1/2	940110	0.1665	0.1665	7/8	2-3/4	940754
9/64	0.1406	3/4	2-1/2	940112	0.1670	0.1670	7/8	2-3/4	940756
0.1410	0.1410	3/4	2-1/2	940668	0.1675	0.1675	7/8	2-3/4	940758
0.1415	0.1415	3/4	2-1/2	940670	0.1680	0.1680	7/8	2-3/4	940760
0.1420	0.1420	3/4	2-1/2	940672	0.1685	0.1685	7/8	2-3/4	940762
0.1425	0.1425	3/4	2-1/2	940674	0.1690	0.1690	7/8	2-3/4	940764
0.1430	0.1430	3/4	2-1/2	940676	18	0.1695	7/8	2-3/4	940138
0.1435	0.1435	3/4	2-1/2	940678	0.1700	0.1700	7/8	2-3/4	940766
27	0.1440	3/4	2-1/2	940114	0.1705	0.1705	7/8	2-3/4	940768
0.1445	0.1445	3/4	2-1/2	940680	0.1710	0.1710	7/8	2-3/4	940770
0.1450	0.1450	3/4	2-1/2	940682	0.1715	0.1715	7/8	2-3/4	940772
0.1455	0.1455	3/4	2-1/2	940684	11/64	0.1719	7/8	2-3/4	940140
0.1460	0.1460	3/4	2-1/2	940686	0.1720	0.1720	7/8	2-3/4	940774
0.1465	0.1465	3/4	2-1/2	940688	0.1725	0.1725	7/8	2-3/4	940776
26	0.1470	3/4	2-1/2	940116	17	0.1730	7/8	2-3/4	940142
0.1475	0.1475	3/4	2-1/2	940690	0.1735	0.1735	7/8	2-3/4	940778
0.1480	0.1480	3/4	2-1/2	940692	0.1740	0.1740	7/8	2-3/4	940780
0.1485	0.1485	3/4	2-1/2	940694	0.1745	0.1745	7/8	2-3/4	940782
0.1490	0.1490	3/4	2-1/2	940696	0.1750	0.1750	7/8	2-3/4	940784
25	0.1495	3/4	2-1/2	940120	0.1755	0.1755	7/8	2-3/4	940786
0.1500	0.1500	3/4	2-1/2	940698	0.1760	0.1760	7/8	2-3/4	940788
0.1505	0.1505	3/4	2-1/2	940700	0.1765	0.1765	7/8	2-3/4	940790
0.1507	0.1507	3/4	2-1/2	940702	16	0.1770	7/8	2-3/4	940144
0.1510	0.1510	3/4	2-1/2	940704	4.5 mm	0.1772	7/8	2-3/4	940146
0.1515	0.1515	3/4	2-1/2	940706	0.1775	0.1775	7/8	2-3/4	940792
24	0.1520	3/4	2-1/2	940122	0.1780	0.1780	7/8	2-3/4	940794

Chucking Reamers

Micrograin Solid Carbide – Straight Shank – 4 & 6 Straight Flutes (continued)



REAMERS

Size	Decimal Equivalent (Inch)	Flute Length (Inch)	Overall Length (Inch)	Code	Size	Decimal Equivalent (Inch)	Flute Length (Inch)	Overall Length (Inch)	Code
0.1785	0.1785	7/8	2-3/4	940796	0.2045	0.2045	1	3	940882
0.1790	0.1790	7/8	2-3/4	940798	0.2050	0.2050	1	3	940884
0.1795	0.1795	7/8	2-3/4	940800	5	0.2055	1	3	940174
15	0.1800	7/8	2-3/4	940148	0.2060	0.2060	1	3	940886
0.1805	0.1805	7/8	2-3/4	940802	0.2065	0.2065	1	3	940888
0.1810	0.1810	7/8	2-3/4	940804	0.2070	0.2070	1	3	940890
0.1814	0.1814	7/8	2-3/4	940806	0.2075	0.2075	1	3	940892
0.1815	0.1815	7/8	2-3/4	940808	0.2080	0.2080	1	3	940894
14	0.1820	7/8	2-3/4	940150	0.2085	0.2085	1	3	940896
0.1825	0.1825	7/8	2-3/4	940810	4	0.2090	1	3	940176
0.1830	0.1830	7/8	2-3/4	940812	0.2095	0.2095	1	3	940898
0.1835	0.1835	7/8	2-3/4	940814	0.2100	0.2100	1	3	940900
0.1840	0.1840	7/8	2-3/4	940816	0.2105	0.2105	1	3	940902
0.1845	0.1845	7/8	2-3/4	940818	0.2110	0.2110	1	3	940904
13	0.1850	7/8	2-3/4	940152	0.2115	0.2115	1	3	940906
D/P	0.1855	7/8	2-3/4	940820	0.2120	0.2120	1	3	940908
0.1860	0.1860	7/8	2-3/4	940822	0.2125	0.2125	1	3	940910
U/S	0.1865	7/8	2-3/4	940824	3	0.2130	1	3	940178
D/P	0.1870	7/8	2-3/4	940826	0.2135	0.2135	1	3	940912
0.1872	0.1872	7/8	2-3/4	940828	0.2140	0.2140	1	3	940914
3/16	0.1875	7/8	2-3/4	940154	0.2145	0.2145	1	3	940916
0.1880	0.1880	7/8	2-3/4	940830	0.2150	0.2150	1	3	940918
O/S	0.1885	7/8	2-3/4	940832	0.2155	0.2155	1	3	940920
12	0.1890	7/8	2-3/4	940156	0.2160	0.2160	1	3	940922
0.1895	0.1895	7/8	2-3/4	940834	5.5 mm	0.2165	1	3	940180
0.1900	0.1900	7/8	2-3/4	940836	0.2170	0.2170	1	3	940924
0.1905	0.1905	7/8	2-3/4	940838	0.2175	0.2175	1	3	940926
11	0.1910	7/8	2-3/4	940158	0.2177	0.2177	1	3	940928
0.1915	0.1915	7/8	2-3/4	940840	0.2180	0.2180	1	3	940930
0.1920	0.1920	1	3	940842	0.2185	0.2185	1	3	940932
0.1925	0.1925	1	3	940844	7/32	0.2188	1	3	940182
0.1930	0.1930	1	3	940846	0.2190	0.2190	1	3	940934
10	0.1935	1	3	940160	0.2195	0.2195	1	3	940936
0.1940	0.1940	1	3	940848	0.2200	0.2200	1	3	940938
0.1945	0.1945	1	3	940850	0.2205	0.2205	1	3	940940
0.1950	0.1950	1	3	940852	2	0.2210	1	3	940184
0.1955	0.1955	1	3	940854	0.2215	0.2215	1	3	940942
9	0.1960	1	3	940162	0.2220	0.2220	1	3	940944
0.1965	0.1965	1	3	940856	0.2225	0.2225	1	3	940946
5 mm	0.1969	1	3	940164	0.2230	0.2230	1	3	940948
0.1970	0.1970	1	3	940858	0.2235	0.2235	1	3	940950
0.1975	0.1975	1	3	940860	0.2240	0.2240	1	3	940952
0.1980	0.1980	1	3	940862	0.2245	0.2245	1	3	940954
0.1985	0.1985	1	3	940864	0.2250	0.2250	1	3	940956
8	0.1990	1	3	940166	0.2255	0.2255	1	3	940958
0.1995	0.1995	1	3	940866	0.2260	0.2260	1	3	940960
0.2000	0.2000	1	3	940868	0.2265	0.2265	1	3	940962
0.2005	0.2005	1	3	940870	0.2270	0.2270	1	3	940964
7	0.2010	1	3	940168	0.2275	0.2275	1	3	940966
0.2015	0.2015	1	3	940872	1	0.2280	1	3	940186
0.2020	0.2020	1	3	940874	0.2285	0.2285	1	3	940968
0.2025	0.2025	1	3	940876	0.2290	0.2290	1	3	940970
0.2030	0.2030	1	3	940878	0.2295	0.2295	1	3	940972
13/64	0.2031	1	3	940170	0.2300	0.2300	1	3	940974
0.2035	0.2035	1	3	940880	0.2305	0.2305	1	3	940976
6	0.2040	1	3	940172	0.2310	0.2310	1	3	940978

Chucking Reamers

Micrograin Solid Carbide – Straight Shank – 4 & 6 Straight Flutes (continued)



Size	Decimal Equivalent (Inch)	Flute Length (Inch)	Overall Length (Inch)	Code	Size	Decimal Equivalent (Inch)	Flute Length (Inch)	Overall Length (Inch)	Code
0.2315	0.2315	1	3	940980	0.2600	0.2600	1-1/8	3-1/4	941076
0.2320	0.2320	1	3	940982	G	0.2610	1-1/8	3-1/4	940206
0.2325	0.2325	1	3	940984	0.2620	0.2620	1-1/8	3-1/4	941078
0.2330	0.2330	1	3	940986	0.2630	0.2630	1-1/8	3-1/4	941080
0.2335	0.2335	1	3	940988	0.2635	0.2635	1-1/8	3-1/4	941082
A	0.2340	1	3	940188	0.2640	0.2640	1-1/8	3-1/4	941084
15/64	0.2344	1	3	940190	0.2650	0.2650	1-1/8	3-1/4	941086
0.2345	0.2345	1	3	940990	17/64	0.2656	1-1/8	3-1/4	940208
0.2350	0.2350	1	3	940992	H	0.2660	1-1/8	3-1/4	940210
0.2355	0.2355	1	3	940994	0.2670	0.2670	1-1/8	3-1/4	941088
0.2360	0.2360	1	3	940996	0.2680	0.2680	1-1/8	3-1/4	941090
6 mm	0.2362	1	3	940192	0.2690	0.2690	1-1/8	3-1/4	941092
0.2365	0.2365	1	3	940998	0.2700	0.2700	1-1/8	3-1/4	941094
0.2370	0.2370	1	3	941000	0.2710	0.2710	1-1/8	3-1/4	941096
0.2375	0.2375	1	3	941002	I	0.2720	1-1/8	3-1/4	940212
B	0.2380	1	3	940194	0.2730	0.2730	1-1/8	3-1/4	941098
0.2385	0.2385	1	3	941004	0.2740	0.2740	1-1/8	3-1/4	941100
0.2390	0.2390	1	3	941006	0.2750	0.2750	1-1/8	3-1/4	941102
0.2395	0.2395	1	3	941008	7 mm	0.2756	1-1/8	3-1/4	940214
0.2400	0.2400	1	3	941010	0.2760	0.2760	1-1/8	3-1/4	941104
0.2405	0.2405	1	3	941012	J	0.2770	1-1/8	3-1/4	940216
0.2410	0.2410	1	3	941014	0.2780	0.2780	1-1/8	3-1/4	941106
0.2415	0.2415	1	3	941016	0.2790	0.2790	1-1/8	3-1/4	941108
C	0.2420	1	3	940196	0.2800	0.2800	1-1/8	3-1/4	941110
0.2425	0.2425	1	3	941018	K	0.2810	1-1/8	3-1/4	940218
0.2430	0.2430	1	3	941020	9/32	0.2812	1-1/8	3-1/4	940220
0.2435	0.2435	1	3	941022	0.2818	0.2818	1-1/8	3-1/4	941112
0.2445	0.2445	1	3	941026	0.2820	0.2820	1-1/8	3-1/4	941114
0.2450	0.2450	1	3	941028	0.2830	0.2830	1-1/8	3-1/4	941116
0.2455	0.2455	1	3	941030	0.2840	0.2840	1-1/8	3-1/4	941118
D	0.2460	1	3	940198	0.2850	0.2850	1-1/8	3-1/4	941120
0.2465	0.2465	1	3	941032	0.2860	0.2860	1-1/8	3-1/4	941122
0.2470	0.2470	1	3	941034	0.2870	0.2870	1-1/8	3-1/4	941124
0.2475	0.2475	1	3	941036	0.2880	0.2880	1-1/8	3-1/4	941126
D/P	0.2480	1	3	941038	0.2890	0.2890	1-1/8	3-1/4	941128
0.2485	0.2485	1	3	941040	L	0.2900	1-1/8	3-1/4	940222
U/S	0.2490	1	3	941042	0.2910	0.2910	1-1/8	3-1/4	941130
D/P	0.2495	1	3	941044	0.2920	0.2920	1-1/8	3-1/4	941132
1/4	0.2500	1	3	940200	0.2930	0.2930	1-1/8	3-1/4	941134
0.2505	0.2505	1	3	941046	0.2940	0.2940	1-1/8	3-1/4	941136
O/S	0.2510	1	3	941048	M	0.2950	1-1/8	3-1/4	940224
0.2515	0.2515	1	3	941050	7.5 mm	0.2953	1-1/8	3-1/4	940226
0.2520	0.2520	1	3	941052	0.2960	0.2960	1-1/8	3-1/4	941138
0.2525	0.2525	1	3	941054	19/64	0.2964	1-1/8	3-1/4	940228
0.2530	0.2530	1	3	941056	0.2970	0.2970	1-1/8	3-1/4	941140
0.2535	0.2535	1	3	941058	0.2980	0.2980	1-1/8	3-1/4	941142
0.2540	0.2540	1	3	941060	0.2990	0.2990	1-1/8	3-1/4	941144
0.2545	0.2545	1	3	941062	0.3000	0.3000	1-1/8	3-1/4	941146
0.2550	0.2550	1	3	941064	0.3010	0.3010	1-1/8	3-1/4	941148
6.5 mm	0.2559	1-1/8	3-1/4	940202	N	0.3020	1-1/8	3-1/4	940230
0.2560	0.2560	1-1/8	3-1/4	941066	0.3030	0.3030	1-1/8	3-1/4	941150
0.2565	0.2565	1-1/8	3-1/4	941068	0.3040	0.3040	1-1/8	3-1/4	941152
F	0.2570	1-1/8	3-1/4	940204	0.3050	0.3050	1-1/8	3-1/4	941154
0.2575	0.2575	1-1/8	3-1/4	941070	0.3060	0.3060	1-1/8	3-1/4	941156
0.2580	0.2580	1-1/8	3-1/4	941072	0.3070	0.3070	1-1/8	3-1/4	941158
0.2590	0.2590	1-1/8	3-1/4	941074	0.3080	0.3080	1-1/8	3-1/4	941160

Chucking Reamers

Micrograin Solid Carbide – Straight Shank – 4 & 6 Straight Flutes (continued)



REAMERS

Size	Decimal Equivalent (Inch)	Flute Length (Inch)	Overall Length (Inch)	Code	Size	Decimal Equivalent (Inch)	Flute Length (Inch)	Overall Length (Inch)	Code
0.3090	0.3090	1-1/8	3-1/4	941162	0.3570	0.3570	1-1/4	3-1/2	941252
0.3100	0.3100	1-1/8	3-1/4	941164	T	0.3580	1-1/4	3-1/2	940254
D/P	0.3105	1-1/8	3-1/4	941166	0.3590	0.3590	1-1/4	3-1/2	941254
0.3110	0.3110	1-1/8	3-1/4	941168	23/64	0.3594	1-1/4	3-1/2	940256
U/S	0.3115	1-1/8	3-1/4	941170	0.3600	0.3600	1-1/4	3-1/2	941256
D/P	0.3120	1-1/8	3-1/4	941172	0.3610	0.3610	1-1/4	3-1/2	941258
5/16	0.3125	1-1/8	3-1/4	940232	0.3620	0.3620	1-1/4	3-1/2	941260
0.3130	0.3130	1-1/8	3-1/4	941174	0.3630	0.3630	1-1/4	3-1/2	941262
O/S	0.3135	1-1/8	3-1/4	941176	0.3640	0.3640	1-1/4	3-1/2	941264
0.3140	0.3140	1-1/8	3-1/4	941178	0.3650	0.3650	1-1/4	3-1/2	941266
8 mm	0.3150	1-1/8	3-1/4	940234	0.3660	0.3660	1-1/4	3-1/2	941268
O	0.3160	1-1/8	3-1/4	940236	0.3670	0.3670	1-1/4	3-1/2	941270
0.3170	0.3170	1-1/4	3-1/2	941180	U	0.3680	1-1/4	3-1/2	940258
0.3180	0.3180	1-1/4	3-1/2	941182	0.3690	0.3690	1-1/4	3-1/2	941272
0.3190	0.3190	1-1/4	3-1/2	941184	0.3700	0.3700	1-1/4	3-1/2	941274
0.3200	0.3200	1-1/4	3-1/2	941186	0.3710	0.3710	1-1/4	3-1/2	941276
0.3210	0.3210	1-1/4	3-1/2	941188	0.3720	0.3720	1-1/4	3-1/2	941278
0.3220	0.3220	1-1/4	3-1/2	941190	D/P	0.3730	1-1/4	3-1/2	941280
P	0.3230	1-1/4	3-1/2	940238	9.5 mm	0.3740	1-1/4	3-1/2	940260
0.3240	0.3240	1-1/4	3-1/2	941192	D/P	0.3745	1-1/4	3-1/2	941282
0.3250	0.3250	1-1/4	3-1/2	941194	3/8	0.3750	1-1/4	3-1/2	940262
0.3260	0.3260	1-1/4	3-1/2	941196	0.3755	0.3755	1-1/4	3-1/2	941284
0.3270	0.3270	1-1/4	3-1/2	941198	O/S	0.3760	1-1/4	3-1/2	941286
0.3280	0.3280	1-1/4	3-1/2	941200	0.3765	0.3765	1-1/4	3-1/2	941288
21/64	0.3281	1-1/4	3-1/2	940240	V	0.3770	1-1/4	3-1/2	940264
0.3290	0.3290	1-1/4	3-1/2	941202	0.3780	0.3780	1-1/4	3-1/2	941290
0.3300	0.3300	1-1/4	3-1/2	941204	0.3790	0.3790	1-1/4	3-1/2	941292
0.3310	0.3310	1-1/4	3-1/2	941206	0.3800	0.3800	1-1/4	3-1/2	941294
Q	0.3320	1-1/4	3-1/2	940242	0.3810	0.3810	1-1/4	3-1/2	941296
0.3330	0.3330	1-1/4	3-1/2	941208	0.3820	0.3820	1-1/4	3-1/2	941298
0.3340	0.3340	1-1/4	3-1/2	941210	0.3830	0.3830	1-1/4	3-1/2	941300
8.5 mm	0.3346	1-1/4	3-1/2	940244	0.3840	0.3840	1-1/4	3-1/2	941302
0.3350	0.3350	1-1/4	3-1/2	941212	0.3850	0.3850	1-1/4	3-1/2	941304
0.3360	0.3360	1-1/4	3-1/2	941214	W	0.3860	1-1/4	3-1/2	940266
0.3370	0.3370	1-1/4	3-1/2	941216	0.3870	0.3870	1-1/4	3-1/2	941306
0.3380	0.3380	1-1/4	3-1/2	941218	0.3880	0.3880	1-1/4	3-1/2	941308
R	0.3390	1-1/4	3-1/2	940246	0.3890	0.3890	1-1/4	3-1/2	941310
0.3400	0.3400	1-1/4	3-1/2	941220	0.3900	0.3900	1-1/4	3-1/2	941312
0.3410	0.3410	1-1/4	3-1/2	941222	25/64	0.3906	1-1/4	3-1/2	940268
0.3420	0.3420	1-1/4	3-1/2	941224	0.3910	0.3910	1-1/4	3-1/2	941314
0.3430	0.3430	1-1/4	3-1/2	941226	0.3920	0.3920	1-1/4	3-1/2	941316
11/32	0.3438	1-1/4	3-1/2	940248	0.3930	0.3930	1-1/4	3-1/2	941318
0.3440	0.3440	1-1/4	3-1/2	941228	10 mm	0.3937	1-1/4	3-1/2	940270
0.3450	0.3450	1-1/4	3-1/2	941230	0.3940	0.3940	1-1/4	3-1/2	941320
0.3460	0.3460	1-1/4	3-1/2	941232	0.3950	0.3950	1-1/4	3-1/2	941322
0.3470	0.3470	1-1/4	3-1/2	941234	0.3960	0.3960	1-1/4	3-1/2	941324
S	0.3480	1-1/4	3-1/2	940250	X	0.3970	1-1/4	3-1/2	940272
0.3490	0.3490	1-1/4	3-1/2	941236	0.3980	0.3980	1-1/4	3-1/2	941326
0.3500	0.3500	1-1/4	3-1/2	941238	0.3990	0.3990	1-1/4	3-1/2	941328
0.3510	0.3510	1-1/4	3-1/2	941240	0.4000	0.4000	1-1/4	3-1/2	941330
0.3520	0.3520	1-1/4	3-1/2	941242	0.4010	0.4010	1-1/4	3-1/2	941332
0.3530	0.3530	1-1/4	3-1/2	941244	0.4020	0.4020	1-1/4	3-1/2	941334
0.3540	0.3540	1-1/4	3-1/2	941246	0.4030	0.4030	1-1/4	3-1/2	941336
9 mm	0.3543	1-1/4	3-1/2	940252	Y	0.4040	1-1/4	3-1/2	940274
0.3550	0.3550	1-1/4	3-1/2	941248	0.4050	0.4050	1-1/4	3-1/2	941338
0.3560	0.3560	1-1/4	3-1/2	941250	0.4060	0.4060	1-1/4	3-1/2	941340

Chucking Reamers

Micrograin Solid Carbide – Straight Shank – 4 & 6 Straight Flutes (continued)



Size	Decimal Equivalent (Inch)	Flute Length (Inch)	Overall Length (Inch)	Code	Size	Decimal Equivalent (Inch)	Flute Length (Inch)	Overall Length (Inch)	Code
13/32	0.4062	1-1/4	3-1/2	940276	0.4560	0.4560	1-3/8	4	941442
0.4070	0.4070	1-1/4	3-1/2	941342	0.4570	0.4570	1-3/8	4	941444
0.4080	0.4080	1-1/4	3-1/2	941344	0.4580	0.4580	1-3/8	4	941446
0.4090	0.4090	1-1/4	3-1/2	941346	0.4590	0.4590	1-3/8	4	941448
0.4100	0.4100	1-1/4	3-1/2	941348	0.4600	0.4600	1-3/8	4	941450
0.4110	0.4110	1-1/4	3-1/2	941350	0.4610	0.4610	1-3/8	4	941452
0.4120	0.4120	1-1/4	3-1/2	941352	0.4620	0.4620	1-3/8	4	941454
Z	0.4130	1-1/4	3-1/2	940278	0.4630	0.4630	1-3/8	4	941456
10.5 mm	0.4134	1-1/4	3-1/2	940280	0.4640	0.4640	1-3/8	4	941458
0.4140	0.4140	1-1/4	3-1/2	941354	0.4650	0.4650	1-3/8	4	941460
0.4150	0.4150	1-1/4	3-1/2	941356	0.4660	0.4660	1-3/8	4	941462
0.4160	0.4160	1-1/4	3-1/2	941358	0.4670	0.4670	1-3/8	4	941464
0.4170	0.4170	1-3/8	4	941360	0.4680	0.4680	1-3/8	4	941466
0.4180	0.4180	1-3/8	4	941362	15/32	0.4688	1-3/8	4	940292
0.4190	0.4190	1-3/8	4	941364	0.4690	0.4690	1-3/8	4	941468
0.4200	0.4200	1-3/8	4	941366	0.4700	0.4700	1-3/8	4	941470
0.4210	0.4210	1-3/8	4	941368	0.4710	0.4710	1-3/8	4	941472
27/64	0.4219	1-3/8	4	940282	0.4720	0.4720	1-3/8	4	941474
0.4230	0.4230	1-3/8	4	941370	12 mm	0.4724	1-3/8	4	940294
0.4240	0.4240	1-3/8	4	941372	0.4730	0.4730	1-3/8	4	941476
0.4250	0.4250	1-3/8	4	941374	0.4740	0.4740	1-3/8	4	941478
0.4260	0.4260	1-3/8	4	941376	0.4750	0.4750	1-3/8	4	941480
0.4270	0.4270	1-3/8	4	941378	0.4760	0.4760	1-3/8	4	941482
0.4280	0.4280	1-3/8	4	941380	0.4770	0.4770	1-3/8	4	941484
0.4290	0.4290	1-3/8	4	941382	0.4780	0.4780	1-3/8	4	941486
0.4300	0.4300	1-3/8	4	941384	0.4790	0.4790	1-1/2	4	941488
0.4310	0.4310	1-3/8	4	941386	0.4800	0.4800	1-1/2	4	941490
0.4320	0.4320	1-3/8	4	941388	0.4805	0.4805	1-1/2	4	941492
0.4330	0.4330	1-3/8	4	941390	0.4810	0.4810	1-1/2	4	941494
11 mm	0.4331	1-3/8	4	940284	0.4820	0.4820	1-1/2	4	941496
0.4340	0.4340	1-3/8	4	941392	0.4830	0.4830	1-1/2	4	941498
0.4350	0.4350	1-3/8	4	941394	0.4840	0.4840	1-1/2	4	941500
D/P	0.4355	1-3/8	4	941396	31/64	0.4844	1-1/2	4	940296
0.4360	0.4360	1-3/8	4	941398	0.4850	0.4850	1-1/2	4	941502
U/S	0.4365	1-3/8	4	941400	0.4860	0.4860	1-1/2	4	941504
D/P	0.4370	1-3/8	4	941402	0.4870	0.4870	1-1/2	4	941506
7/16	0.4375	1-3/8	4	940286	0.4880	0.4880	1-1/2	4	941508
0.4380	0.4380	1-3/8	4	941404	0.4890	0.4890	1-1/2	4	941510
O/S	0.4385	1-3/8	4	941406	0.4900	0.4900	1-1/2	4	941512
0.4390	0.4390	1-3/8	4	941408	0.4910	0.4910	1-1/2	4	941514
0.4400	0.4400	1-3/8	4	941410	12.5 mm	0.4921	1-1/2	4	940298
0.4410	0.4410	1-3/8	4	941412	0.4930	0.4930	1-1/2	4	941516
0.4420	0.4420	1-3/8	4	941414	0.4940	0.4940	1-1/2	4	941518
0.4430	0.4430	1-3/8	4	941416	0.4950	0.4950	1-1/2	4	941520
0.4440	0.4440	1-3/8	4	941418	0.4960	0.4960	1-1/2	4	941522
0.4450	0.4450	1-3/8	4	941420	0.4970	0.4970	1-1/2	4	941524
0.4460	0.4460	1-3/8	4	941422	D/P	0.4980	1-1/2	4	941526
0.4470	0.4470	1-3/8	4	941424	U/S	0.4990	1-1/2	4	941528
0.4480	0.4480	1-3/8	4	941426	D/P	0.4995	1-1/2	4	941530
0.4490	0.4490	1-3/8	4	941428	1/2	0.5000	1-1/2	4	940300
0.4500	0.4500	1-3/8	4	941430	0.5005	0.5005	1-1/2	4	940118
0.4510	0.4510	1-3/8	4	941432	O/S	0.5010	1-1/2	4	941532
0.4520	0.4520	1-3/8	4	941434	0.5015	0.5015	1-1/2	4	941534
11.5 mm	0.4528	1-3/8	4	940288	0.5020	0.5020	1-1/2	4	941536
0.4530	0.4530	1-3/8	4	941436	0.5030	0.5030	1-1/2	4	941538
29/64	0.4531	1-3/8	4	940290	0.5040	0.5040	1-1/2	4	941540
0.4540	0.4540	1-3/8	4	941438	0.5050	0.5050	1-1/2	4	941542
0.4550	0.4550	1-3/8	4	941440					

Expansion Chucking Reamers

High Speed Steel – Straight & Taper Shanks – Straight Flutes



- The expansion feature allows the reamer to be sharpened to maintain the original size

Size (Inch)	Decimal Equiv. (Inch)	Flute Length (Inch)	Overall Length (Inch)	HSS			Size (Inch)	Decimal Equiv. (Inch)	Flute Length (Inch)	Overall Length (Inch)	HSS				
				Straight Shank		Taper Shank					Straight Shank		Taper Shank		
				Code	Morse Taper	Code					Code	Morse Taper	Code		
1	1.0000	1-5/8	10-1/2	525611	3	525630	1-7/16	1.4375	2	12	525712	4	525640		
1-1/32	1.0312	1-5/8	10-1/2	525612	3	525631	1-1/2	1.5000	2-1/8	12-1/2	525713	4	525641		
1-1/16	1.0625	1-5/8	10-1/2	525613	3	525632	1-9/16	1.5625	2-1/8	12-1/2	525714	4	525642		
1-1/8	1.1250	1-3/4	11	525614	3	525633	1-5/8	1.6250	2-1/4	13	525715	4	525643		
1-5/32	1.1562	1-5/8	10-1/2	525615	3	525634	1-11/16	1.6875	2-1/4	13	525716	4	525644		
1-3/16	1.1875	1-3/4	11	525616	3	525635	1-3/4	1.7500	2-3/8	13-1/2	525717	5	525645		
1-7/32	1.2188	1-3/4	11	525617	4	525636	1-13/16	1.8125	2-3/8	13-1/2	525718	5	525646		
1-1/4	1.2500	1-7/8	11-1/2	525618	4	525637	1-7/8	1.8750	2-1/2	14	525719	5	525647		
1-5/16	1.3125	1-7/8	11-1/2	525619	4	525638	1-15/16	1.9375	2-1/2	14	525730	5	525648		
1-3/8	1.3750	2	12	525711	4	525639	2	2.0000	2-1/2	14	525731	5	525649		

Maximum Expansion to 1/2 = 0.006", to 1 = 0.010", to 1-1/2 = 0.012", 1-1/2 and over = 0.015"

Taper Bridge Reamers

High Speed Steel – Taper Shanks – Spiral & Straight Flutes



Full Diameter (Inch)	Approx. Point Diameter (Inch)	Flute Length (Inch)	Overall Length (Inch)	Taper	Taper Shank		Full Diameter (Inch)	Approx. Point Diameter (Inch)	Flute Length (Inch)	Overall Length (Inch)	Taper	Taper Shank	
					Straight Flute	Spiral Flute						Straight Flute	Spiral Flute
					Code	Code						Code	Code
5/16	11/64	4-3/8	8-1/4	2	-	600522	1-3/16	59/64	7-3/8	12	4	600567	600538
13/32	7/32	4-3/8	8-1/4	2	-	600523	1-1/4	63/64	7-3/8	13	4	600568	600539
7/16	17/64	4-3/8	8-1/4	2	600553	600524	1-5/16	1-1/64	7-3/8	13	4	600569	600540
15/32	9/32	5-1/8	9	2	600554	600525	1-3/8	1-1/8	7-3/8	13	4	-	600541
1/2	5/16	5-1/8	9	2	600555	600526	1-7/16	1-1/8	7-3/8	13	4	600571	600542
17/32	11/32	5-1/8	9	2	-	600527	1-1/2	1-1/4	7-3/8	13	4	600572	600543
9/16	3/8	5-1/8	9	2	600557	600528	1-9/16	1-1/4	7-3/8	13	4	600573	600544
5/8	25/64	6-1/8	10	3	600558	600529	1-5/8	1-1/4	7-3/8	13	4	-	600545
11/16	13/32	7-1/8	11-3/4	3	600559	600530	1-11/16	1-3/8	7-3/8	13	4	-	600546
3/4	15/32	7-3/8	12	3	600560	600531	1-3/4	1-7/16	7-3/8	13	4	-	600547
13/16	35/64	7-3/8	12	3	600561	600532	1-13/16	1-7/16	7-3/8	13	4	-	600548
7/8	39/64	7-3/8	12	3	600562	600533	1-7/8	1-1/2	7-3/8	13	4	-	600549
15/16	43/64	7-3/8	12	3	600563	600534	1-15/16	1-1/2	7-3/8	13	4	-	600550
1	47/64	7-3/8	12	3	-	600535	2	1-3/4	7-3/8	13	4	-	600551
1-1/16	13/16	7-3/8	12	3	600565	600536							
1-1/8	55/64	7-3/8	12	3	600566	600537							

Taper Finishing Reamers

High Speed Steel – Straight & Taper Shanks – Straight Flutes



Morse Taper Finish	Small End Dia. (Inch)	Large End Dia. (Inch)	Flute Length (Inch)	Straight Flutes				Morse Taper Finish	Small End Dia. (Inch)	Large End Dia. (Inch)	Flute Length (Inch)	Straight Flutes			
				Straight Shank		Taper Shank						Straight Shank		Taper Shank	
				Shank Dia. (Inch)	Code	Morse Taper Shank	Code					Shank Dia. (Inch)	Code	Morse Taper Shank	Code
0	0.2503	0.3674	2-1/4	5/16	311440	0	311447	2	0.5696	0.7444	3-1/2	5/8	311442	2	311449
1	0.3674	0.5170	3	7/16	311441	1	311448	3	0.7748	0.9881	4-1/4	7/8	311443	3	311450
								4	1.0167	1.2893	5-1/4	1-1/4	311444	4	311451
								5	1.4717	1.8005	6-1/4	1-1/2	311445	5	311452
								6	2.1120	2.5550	8-1/2	2	311446	6	311453

Taper Car Reamers

High Speed Steel – Hex Shanks – Spiral Flutes



Reamer Diameter (Inch)	Shank Diameter (Inch)	Flute Length (Inch)	Overall Length (Inch)	Code
13/16	1-1/4	5	7	600494
15/16	1-7/16	5	7	600495
1-1/16	1-5/8	5	7	600496

High Speed Steel – Taper Shanks – 5 Flute Left Hand Spiral – Right Hand Cut



Reamer Diameter (Inch)	Morse Taper	Flute Length (Inch)	Overall Length (Inch)	Code	Reamer Diameter (Inch)	Morse Taper	Flute Length (Inch)	Overall Length (Inch)	Code
5/16	1	2-3/4	5-11/16	600497	3/4	3	5	9-1/2	600504
3/8	1	2-3/4	5-11/16	600498	13/16	3	5	9-1/2	600505
7/16	2	3-1/2	6-15/16	600499	15/16	3	5	9-1/2	600506
1/2	2	4	7-9/16	600500	1	3	5	9-1/2	600507
9/16	2	4	7-9/16	600501	1-1/16	3	5	9-1/2	600508
11/16	3	4-1/2	8-13/16	600503					

High Speed Steel – Straight Shanks with 3 Equal Flats – Spiral Flute



Reamer Diameter (Inch)	Shank Diameter (Inch)	Shank Length (Inch)	Flute Length (Inch)	Overall Length (Inch)	Code	Reamer Diameter (Inch)	Shank Diameter (Inch)	Shank Length (Inch)	Flute Length (Inch)	Overall Length (Inch)	Code
5/16	5/16	1-1/2	2-3/4	4-5/8	600509	11/16	1/2	1-1/2	4-1/2	6-3/8	600515
3/8	3/8	1-1/2	2-3/4	4-5/8	600510	3/4	1/2	1-1/2	5	6-7/8	600516
7/16	7/16	1-1/2	3-1/2	5-3/8	600511	13/16	1/2	1-1/2	5	6-7/8	600517
1/2	1/2	1-1/2	4	5-7/8	600512	7/8	1/2	1-1/2	5	6-7/8	600518
9/16	1/2	1-1/2	4	5-7/8	600513	15/16	1/2	1-1/2	5	6-7/8	600519
5/8	1/2	1-1/2	4-1/2	6-3/8	600514	1	1/2	1-1/2	5	6-7/8	600520
						1-1/16	1/2	1-1/2	5	6-7/8	600521

Taper Pin Reamers

High Speed Steel – Straight & Spiral Flutes



Size	Small End Diameter (Inch)	Large End Diameter (Inch)	No. of Flutes	Flute Length (Inch)	Overall Length (Inch)	Shank Size (Inch)	Straight Flute	Spiral Flute
							Code	Code
5/0	0.0719	0.0966	2	1-3/16	2-3/16	7/64	525122	525152
4/0	0.0869	0.1142	2	1-5/16	5-5/16	1/8	525123	525153
3/0	0.1029	0.1302	2	1-5/16	2-5/16	9/64	525124	525154
2/0	0.1137	0.1462	3	1-9/16	2-9/16	5/32	525125	525155
0	0.1287	0.1638	3	1-11/16	2-15/16	11/64	525126	525156
1	0.1447	0.1798	3	1-11/16	2-15/16	3/16	525127	525157
2	0.1605	0.2008	3	1-15/16	3-3/16	13/64	525128	525158
3	0.1813	0.2294	3	2-15/16	3-11/16	15/64	525129	525159
4	0.2071	0.2604	3	2-9/16	4-1/16	17/64	525130	525160
5	0.2409	0.2994	3	2-13/16	4-5/16	5/16	525131	525161
6	0.2773	0.3540	3	3-11/16	5-7/16	23/64	525132	525162
7	0.3297	0.4220	3	4-7/16	6-5/16	13/32	525133	525163
8	0.3971	0.5050	3	5-3/16	7-3/16	7/16	525134	525164
9	0.4805	0.6066	4	6-1/16	8-5/16	9/16	525135	525165
10	0.5799	0.7216	4	6-13/16	9-5/16	5/8	525136	525166

Taper Pipe Reamers

High Speed Steel – Spiral Flute



Size (Inch)	Small End Dia. (Inch)	Large End Dia. (Inch)	No. of Flutes	Flute Length (Inch)	Overall Length (Inch)	Shank Size (Inch)	Code	Size (Inch)	Small End Dia. (Inch)	Large End Dia. (Inch)	No. of Flutes	Flute Length (Inch)	Overall Length (Inch)	Shank Size (Inch)	Code
1/16	0.2450	0.2910	6	3/4	2	–	525100	1	1.1030	1.2120	10	1-3/4	3-3/4	1.1250	525106
1/8	0.3160	0.3620	6	3/4	2-1/8	0.4375	525101	1-1/4	1.4440	1.5530	10	1-3/4	4	1.3125	525107
1/4	0.4060	0.4620	6	1-1/16	2-7/16	0.5625	525102	1-1/2	1.6840	1.7930	10	1-3/4	4-1/4	1.5000	525108
3/8	0.5400	0.6060	8	1-1/16	2-9/16	0.7000	525103	2	2.1590	2.2680	12	1-3/4	4-1/2	1.8750	525109
1/2	0.6650	0.7510	8	1-3/8	3-1/8	0.6875	525104								
3/4	0.8760	0.9620	10	1-3/8	3-1/4	0.9063	525105								

Adjustable Hand Reamers

High Speed Steel



- Blades are adjusted by loosening one nut and tightening the other
- Each reamer expands to the next minimal size
- Sets supplied in fitted case

Size	Adjustment Range (Inch)	Blade Length (Inch)	Overall Length (Inch)	Code	Size	Adjustment Range (Inch)	Blade Length (Inch)	Overall Length (Inch)	Code
8/A	1/4 – 9/32	1-11/32	3-1/4	535100	F	25/32 – 27/32	2-5/8	7-3/8	535112
7/A	9/32 – 5/16	1-11/32	3-1/2	535101	G	27/32 – 15/16	3	8	535113
6/A	5/16 – 11/32	1-1/2	4-1/8	535102	H	15/16 – 1-1/16	3-1/4	9	535114
5/A	11/32 – 3/8	1-1/2	4-3/8	535103	I	1-1/16 – 1-3/16	3-3/8	10	535115
4/A	3/8 – 13/32	1-1/2	4-3/4	535104	J	1-3/16 – 1-11/32	3-7/8	11	535116
3/A	13/32 – 7/16	1-1/2	5	535105	K	1-11/32 – 1-1/2	4-1/4	12	535117
2/A	7/16 – 15/32	1-5/8	5-1/4	535106	L	1-1/2 – 1-13/16	4-7/16	14	535118
A	15/32 – 17/32	1-5/8	5-1/2	535107	M	1-13/16 – 2-7/32	5	16	535119
B	17/32 – 19/32	1-13/16	5-3/4	535108	N	2-7/32 – 2-3/4	4-13/16	18	535120
C	19/32 – 21/32	2-1/16	6-1/2	535109	O	2-3/4 – 3-11/32	5-3/16	20	535121
D	21/32 – 23/32	2-3/16	6-3/4	535110					
E	23/32 – 25/32	2-1/2	7	535111					

SETS – 11 Pieces – Sizes A to K 535125

Shell Reamers

High Speed Steel – Straight & Spiral Flutes



O.D. TOLERANCE: 3/4 to 1" +0.0005", -0.0000"
Over 1" +0.0006", -0.0002"

REAMERS

Size (Inch)	Overall Length (Inch)	Hole Diameter (Inch)	Straight Flute	Spiral Flute	Size (Inch)	Overall Length (Inch)	Hole Diameter (Inch)	Straight Flute	Spiral Flute
			Code	Code				Code	Code
3/4	2-1/4	3/8	535210	535270	2-3/8	3-3/4	1-1/4	535245	535305
13/16	2-1/2	1/2	535211	535271	2-7/16	3-3/4	1-1/4	535246	535306
7/8	2-1/2	1/2	535212	535272	2-1/2	3-3/4	1-1/4	535247	535307
15/16	2-1/2	1/2	535213	535273	2-9/16	4	1-1/2	535248	535308
1	2-1/2	1/2	535214	535274	2-5/8	4	1-1/2	535249	535309
1-1/16	2-3/4	5/8	535215	535275	2-11/16	4	1-1/2	535250	535310
1-1/8	2-3/4	5/8	535216	535276	2-3/4	4	1-1/2	535251	535311
1-3/16	2-3/4	5/8	535217	535277	2-13/16	4	1-1/2	535252	535312
1-1/4	2-3/4	5/8	535218	535278	2-7/8	4	1-1/2	535253	535313
1-5/16	3	3/4	535220	535280	2-15/16	4	1-1/2	535254	535314
1-3/8	3	3/4	535222	535282	3	4	1-1/2	535255	535315
1-7/16	3	3/4	535224	535284	3-1/16	4-1/2	1-3/4	535200	535324
1-1/2	3	3/4	535226	535286	3-1/8	4-1/2	1-3/4	535256	535316
1-9/16	3	3/4	535228	535288	3-3/16	4-1/2	1-3/4	535201	535325
1-5/8	3	3/4	535229	535289	3-1/4	4-1/2	1-3/4	535257	535317
1-11/16	3-1/2	1	535231	535291	3-5/16	4-1/2	1-3/4	535202	535326
1-3/4	3-1/2	1	535232	535292	3-3/8	4-1/2	1-3/4	535258	535318
1-13/16	3-1/2	1	535233	535293	3-7/16	4-1/2	1-3/4	535203	535327
1-7/8	3-1/2	1	535235	535295	3-1/2	4-1/2	1-3/4	535259	535319
1-15/16	3-1/2	1	535237	535297	3-9/16	5	2	535204	535328
2	3-1/2	1	535239	535299	3-5/8	5	2	535260	535320
2-1/16	3-3/4	1-1/4	535240	535300	3-11/16	5	2	535205	535329
2-1/8	3-3/4	1-1/4	535241	535301	3-3/4	5	2	535261	535321
2-3/16	3-3/4	1-1/4	535242	535302	3-13/16	5	2	535206	535330
2-1/4	3-3/4	1-1/4	535243	535303	3-7/8	5	2	535262	535322
2-5/16	3-3/4	1-1/4	535244	535304	3-15/16	5	2	535207	535331
					4	5	2	535263	535323

Shell Reamer Arbors

Straight & Taper Shanks



Size (Inch)	Reference Location Diameter (Inch)	Fits Smallest Reamer Size (Inch)	Fits Largest Reamer Size (Inch)	Overall Length (Inch)	Straight Shank		Taper Shank	
					Shank Diameter (Inch)	Code	Morse Taper	Code
4	3/8	21/32	25/32	9	1/2	535340	2	535350
5	1/2	13/16	1-1/32	9-1/2	5/8	535341	2	535351
6	5/8	1-1/16	1-9/32	10	3/4	535342	3	535352
7	3/4	1-5/16	1-21/32	11	7/8	535343	3	535353
8	1	1-11/16	2	12	1-1/8	535344	4	535354
9	1-1/4	2-1/16	2-1/2	13	1-3/8	535345	4	535355
10	1-1/2	2-9/16	3	14	1-5/8	535346	5	535356
11	1-3/4	3-1/16	3-1/2	15	2	535347	5	535357
12	2	3-9/16	4	16	2-1/8	535348	-	-

Counterbores

High Speed Steel – Solid Pilot – 3 Flute – Straight & Taper Shanks



Screw Size	Cutter Diameter	Pilot Diameter	Overall Length (Inch)	Straight Shank		Taper Shank	
				Shank Diameter (Inch)	Code	Morse Taper	Code
No. 5	7/32"	9/64"	3	3/16	545771	-	-
No. 6	1/4"	5/32"	3	7/32	545772	-	-
No. 8	19/64"	11/64"	3	1/4	545773	-	-
No. 10	21/64"	13/64"	3	5/16	545774	-	-
1/4	13/32"	9/32"	3-1/2	3/8	545775	2	545785
5/16	1/2"	11/32"	5	7/16	545776	-	-
3/8	19/32"	13/32"	5	1/2	545777	2	545787
7/16	11/16"	15/32"	6	1/2	545778	2	545788
1/2	25/32"	17/32"	7	1/2	545779	2	545789
5/8	31/32"	21/32"	7-1/2	3/4	545780	2	545790
3/4	1-3/16"	13/16"	8	1	545781	3	545791
7/8	1-3/8"	15/16"	8	1	545782	3	-
1	1-9/16"	1-1/16"	10	1	545784	3	-
M3	6 mm	3.4 mm	-	7/32	545803	-	-
M4	8 mm	4.5 mm	-	5/16	545804	-	-
M5	10 mm	5.5 mm	-	3/8	545805	-	-
M6	11 mm	6.6 mm	-	7/16	545806	-	-
M8	15 mm	9 mm	-	1/2	545808	-	-
M10	18 mm	11 mm	-	1/2	545810	-	-
M12	20 mm	14 mm	-	1/2	545812	-	-
M14	24 mm	15 mm	-	-	-	2	545814
M16	26 mm	17 mm	-	-	-	2	545816
M20	33 mm	21 mm	-	-	-	2	545820

COUNTERBORES & COUNTERSINKS

Counterbores

High Speed Steel – With Interchangeable Pilot Holes – Straight & Taper Shanks



Diameter (Inch)	Overall Length (Inch)	Shank Length (Inch)	No. of Flutes	Hole Diameter (Inch)	Straight Shank		Taper Shank	
					Shank Diameter (Inch)	Code	Morse Taper	Code
1/4	3-13/16	3-1/16	3	3/32	15/64	525650	-	-
9/32	3-13/16	3-1/16	3	3/32	17/64	525651	1	525751
5/16	3-13/16	3-1/16	3	3/32	19/64	525652	1	525752
11/32	3-13/16	3-1/16	3	3/32	5/16	525653	1	525753
3/8	4-1/16	3-1/16	3	5/32	5/16	525654	1	525754
13/32	4-1/16	3-1/16	3	5/32	3/8	525655	1	525755
7/16	4-1/16	3-1/16	3	5/32	3/8	525656	1	525756
15/32	4-5/16	3-1/16	3	3/16	7/16	525657	1	525757
1/2	4-5/16	3-1/16	3	3/16	7/16	525658	1	525758
17/32	4-5/16	3-1/16	3	3/16	1/2	525659	1	525759
9/16	4-5/16	3-1/16	3	3/16	1/2	525660	1	525760
19/32	5-1/8	3-7/8	3	3/16	1/2	525661	2	525761
5/8	5-1/8	3-7/8	3	3/16	1/2	525662	2	525762
21/32	5-1/8	3-7/8	3	3/16	1/2	525663	2	525763
11/16	5-1/8	3-7/8	3	3/16	1/2	525664	2	525764
23/32	5-3/8	3-7/8	3	1/4	1/2	525665	2	525765

Counterbores

High Speed Steel – With Interchangeable Pilot Holes – Straight & Taper Shanks (continued)

Diameter (Inch)	Overall Length (Inch)	Shank Length (Inch)	No. of Flutes	Hole Diameter (Inch)	Straight Shank		Taper Shank	
					Shank Diameter (Inch)	Code	Morse Taper	Code
3/4	5-3/8	3-7/8	3	1/4	1/2	525666	2	525766
25/32	5-3/8	3-7/8	3	1/4	5/8	525667	2	525767
13/16	5-3/8	3-7/8	3	1/4	5/8	525668	2	525768
27/32	5-3/8	3-7/8	3	1/4	3/4	525669	-	-
7/8	5-3/8	3-7/8	3	1/4	3/4	525670	2	525769
29/32	6-1/8	4-5/8	3	1/4	3/4	525671	-	-
15/16	6-1/8	4-5/8	3	1/4	3/4	525672	3	525770
31/32	6-3/8	4-5/8	3	5/16	3/4	525673	-	-
1	6-3/8	4-5/8	3	5/16	3/4	525674	3	525771
1-1/16	6-3/8	4-5/8	3	5/16	3/4	525675	3	525772
1-1/8	6-3/8	4-5/8	3	5/16	1	525676	3	525773
1-3/16	6-3/8	4-5/8	3	5/16	1	525677	3	525774
1-1/4	6-5/8	4-5/8	5	3/8	1	525678	3	525775
1-5/16	6-5/8	4-5/8	5	3/8	1	525685	3	525776
1-3/8	6-5/8	4-5/8	5	3/8	1	525679	3	525777
1-7/16	7-7/8	5-7/8	5	3/8	1-1/4	525686	4	525790
1-1/2	7-7/8	5-7/8	5	3/8	1-1/4	525680	4	525778
1-5/8	8-1/8	5-7/8	5	7/16	1-1/4	525681	4	525779
1-11/16	8-1/8	5-7/8	5	7/16	1-1/4	525688	4	525792
1-3/4	8-1/8	5-7/8	5	7/16	1-1/4	525682	4	525780
1-13/16	8-1/8	5-7/8	5	7/16	-	-	4	525793
1-7/8	8-1/8	5-7/8	5	7/16	1-1/2	525683	4	525781
2	8-3/8	5-7/8	5	1/2	1-1/2	525684	4	525782
2-1/8	9-7/8	5-7/8	5	1/2	-	-	5	525783
2-1/4	9-7/8	5-7/8	5	1/2	-	-	5	525784
2-3/8	9-7/8	7-3/8	5	1/2	-	-	5	525785
2-1/2	9-7/8	7-3/8	5	1/2	-	-	5	525786

Counterbore Pilots

Precision Ground



- Pilots of different diameters can be used with each counterbore
- Used in spot facing and counterboring operations with same pilot
- A wide range of pilots can be used with each tool (*The shank diameter must be the same as the pilot hole size in the counterbore*)

Pilot Diameter (Inch)	Shank Diameter (Inch)							
	3/32	5/32	3/16	1/4	5/16	3/8	7/16	1/2
	Code	Code	Code	Code	Code	Code	Code	Code
1/8	311586	-	-	-	-	-	-	-
5/32	311587	-	-	-	-	-	-	-
3/16	311588	311593	-	-	-	-	-	-
7/32	311589	311594	311600	-	-	-	-	-
1/4	311590	311595	311601	-	-	-	-	-
9/32	311591	311596	311602	311615	-	-	-	-
5/16	311592	311597	311603	311616	-	-	-	-
11/32	-	311598	311604	311617	-	-	-	-
3/8	-	311599	311605	311618	311634	-	-	-
13/32	-	-	311606	311619	311635	311656	-	-
7/16	-	-	311607	311620	311636	311657	-	-
15/32	-	-	311608	311621	311637	311658	-	-
1/2	-	-	311609	311622	311638	311659	311682	-
17/32	-	-	311610	311623	311639	311660	311683	-
9/16	-	-	311611	311624	311640	311661	311684	311712
19/32	-	-	311612	311625	311641	311662	311685	-
5/8	-	-	311613	311626	311642	311663	-	311713
21/32	-	-	311614	311627	311643	311664	311687	-



Counterbore Pilots

Precision Ground (continued)

Pilot Diameter (Inch)	Shank Diameter (Inch)							
	3/32	5/32	3/16	1/4	5/16	3/8	7/16	1/2
	Code	Code	Code	Code	Code	Code	Code	Code
11/16	-	-	-	311628	311644	311665	311688	311714
23/32	-	-	-	311629	311645	311666	311689	-
3/4	-	-	-	311630	311646	311667	311690	311715
25/32	-	-	-	311631	311647	311668	311691	-
13/16	-	-	-	311632	311648	311669	311692	311717
7/8	-	-	-	311633	311649	311670	311693	311718
29/32	-	-	-	-	311650	311671	311694	-
15/16	-	-	-	-	311651	311672	311695	311720
31/32	-	-	-	-	311652	311673	311696	-
1	-	-	-	-	311653	311674	311697	311722
1-1/16	-	-	-	-	311654	311675	311698	311723
1-1/8	-	-	-	-	311655	311676	311699	311724
1-3/16	-	-	-	-	-	311677	311700	311725
1-1/4	-	-	-	-	-	311678	311701	311726
1-5/16	-	-	-	-	-	311679	311702	311727
1-3/8	-	-	-	-	-	311680	311703	311728
1-7/16	-	-	-	-	-	311681	311704	-
1-1/2	-	-	-	-	-	-	311705	311730
1-9/16	-	-	-	-	-	-	311706	311731
1-5/8	-	-	-	-	-	-	311707	311732
1-11/16	-	-	-	-	-	-	311708	311733
1-3/4	-	-	-	-	-	-	311709	311734
1-13/16	-	-	-	-	-	-	-	311735
1-7/8	-	-	-	-	-	-	-	311736
1-15/16	-	-	-	-	-	-	-	311737
2	-	-	-	-	-	-	-	311738

COUNTERBORES & COUNTERSINKS

Indexable Counterbores

Carbide – For Sockethead Cap Screw Holes

- Significant increase in cutting speeds over high speed steel
- No regrinding
- One carbide insert fits all size holders
- Outlasts high speed on abrasive materials
- No clamps to impede chip flow
- C5/C6 carbide insert and Torx® wrench included with each tool



Holder & Sets



Carbide TPGH Inserts

- Triangle – positive rake
- Ground all over
- Chip groove on one side



Cap Screw (Inch)	Pilot Diameter (Inch)	Outer Diameter (Inch)	Shank Diameter (Inch)	Overall Length (Inch)	No. of Flutes	Code
3/8	13/32	19/32	1/2	4-3/8	1	311032
7/16	15/32	11/16	1/2	4-7/16	1	311033
1/2	17/32	25/32	5/8	4-1/2	1	311034
5/8	21/32	31/32	5/8	4-5/8	2	311035
3/4	13/16	1-3/16	3/4	4-3/4	3	311036
7/8	15/16	1-3/8	3/4	4-7/8	3	311037
1	1-1/16	1-9/16	3/4	5	3	311038
SETS – 4 Pieces – 3/8", 7/16", 1/2", 5/8", Torx® wrench Supplied in wooden block						311039
SETS – 3 Pieces – 3/4", 7/8", 1", Torx® wrench Supplied in wooden block						311040

Type	Radius (Inch)	I.C. (Inch)	Thickness (Inch)	Code
C2 Carbide	1/64	1/4	3/32	577459
C5 Carbide	1/64	1/4	3/32	577461
TiN Coated	0.008	1/4	3/32	210357
TiN Coated	1/64	1/4	3/32	577463

Replacement Screw



Description	Code
Torx® 6 screw for 1/4 inserts	577457

Cap Screw Counterbores Multi-Tool System

Forward Counterbore Set

OPERATION FOR FORWARD AND BACKWARD APPLICATIONS

- STEP 1: Select appropriate pilot holder and blade for screw size needed
- STEP 2: Insert blade into pilot holder and tighten set screw
 - A) FORWARD COUNTERBORING: Use in clockwise direction
 - B) BACKWARD COUNTERBORING: Use in reverse spindle, counter-clockwise direction

STEP 1

STEP 2

**FORWARD CUTTING
CLOCKWISE**

**BACKWARD CUTTING
COUNTER-CLOCKWISE
(Requires reverse spindle drive)**

- Simple design for standard cap screws
- More chip clearance
- Used in confined areas
- Using the same pilot holder you can forward counterbore or backward counterbore and spotface

Description	Code
SETS – 10 Pieces – One blade and one pilot holder for screw sizes No. 10, 1/4", 5/16", 3/8", and 1/2"	311031

COUNTERBORES & COUNTERSINKS

Call your Local KAR Distributor
for all your KAR needs!

Find them at WWW.KAR.CA,
click FIND A DISTRIBUTOR

Countersinks – 3 Flute

Metric & Inch – Cobalt M35, TiN Coated & Carbide



This highly productive countersinking cutter is a much improved version of the traditional multiflute milling cutter:

- wide flutes provide good chip evacuation
- positive cut
- constant profile aids regrinding of the tool
- self-centering of the cutting mill (three bearing points)
- virtually eliminates vibration

Dimensions are adapted so as to sink 90 degree screw caps up to M12. We recommend lubricating.

Carbide:

- Diameter 12.4 to 31 = 3 flatted shanks
- Diameter 4.3 to 8.3 = cylindrical shank
- Diameter 10.4 to 31 = brazed carbide head

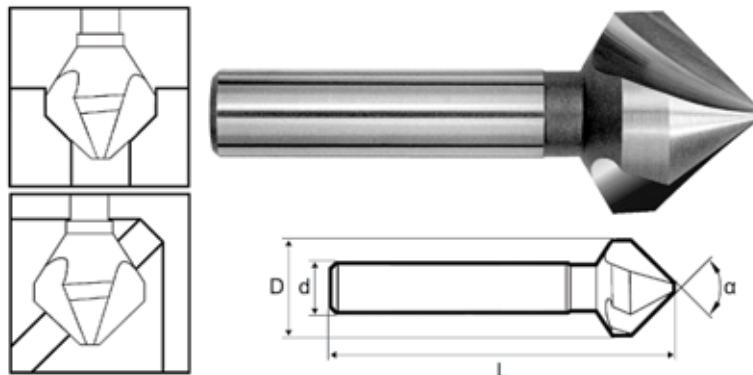

Metric & Inch – Cobalt M35 & TiN Coated – 60°, 82°, 90°, 100°, & 120° Angles

D Overall Diameter (mm)	d Shank Diameter (mm)	Chamfer Range Min/Max (mm)	L Overall Length (Inch)	60° Angle	82° Angle	82° Angle	90° Angle	90° Angle	100° Angle	120° Angle
				Series 432	Series 434	Series 4834 - TiN	Series 431	Series 4831 - TiN	Series 435	Series 433
				Code	Code	Code	Code	Code	Code	Code
6.35 1/4 Inch	6.35	1.5-6.35	1.77		540390	540437	540376	540383		
7.93 5/16 Inch	6.35	2-7.93	1.77		540391	540438	540377	540384		
9.52 3/8 Inch	6.35	2.5-9.52	1.97		540392	540439	540378	540385		
10.4	6	2.5-10.4	2	540301	540311	540361	540321	540371	540331	540341
12.7 1/2 Inch	6.35	2.9-12.7	1.97		540393	540440	540379	540386		
15.87 5/8 Inch	9.52	3.2-15.87	2.36		540394	540441	540380	540387		
16.5	10	3.2-16.5	2-1/4	540302	540312	540362	540322	540372	540332	540342
19.05 3/4 Inch	9.52	3.5-19.05	2.36		540395	540442	540381	540388		
20.5	10	3.5-20.5	2-1/2	540303	540313	540363	540323	540373	540333	540343
25.0	10	3.8-25	2-5/8	540304	540314	540364	540324	540374	540334	540344
25.4 1 Inch	9.52	3.8-25.4	2.76		540396	540443	540382	540389		
31.0	12	4.2-31	2-3/4	540305	540315	540365	540325	540375	540335	540345
40.0	16	8-40	4-1/2	-	-	-	*540326	-	-	-
50.0	16	10-50	5	-	-	-	*540327	-	-	-
63.0	16	10-63	5-1/2	-	-	-	*540328	-	-	-
80.0	16	14-80	6-1/2	-	-	-	*540329	-	-	-

* Three gripping flats on shank



Countersinks – 3 Flute

Metric – Cobalt M35, TiN Coated & Carbide (continued)

Metric – Cobalt – 90° Angle – Extra-Long

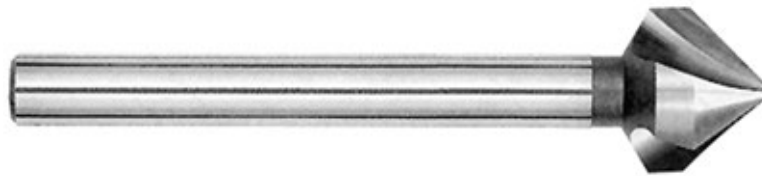

COUNTERBORES & COUNTERSINKS

D Overall Diameter (mm)	d Shank Diameter (mm)	Chamfer Range Min/Max (mm)	L Overall Length (mm)	Series 4303 Code
6.3	6	1.3-6.3	84	540500
8.3	8	1.8-8.3	85	540501
10.4	10	2.2-10.4	87	540502
12.4	10	2.5-12.4	108	540503

D Overall Diameter (mm)	d Shank Diameter (mm)	Chamfer Range Min/Max (mm)	L Overall Length (mm)	Series 4303 Code
16.5	16	2.8-16.5	112	540504
20.5	16	3-20.5	115	540505
25	20	3.2-25	118	540506

Metric – Carbide – 90° Angle

Hard'X: AlTiN carbide tool coating with a high hardness of 3500 HV. This coating shows high thermic stability and excellent protection against heat and wear. Ideal for dry machining – high speed cut – in treated steels and dies up to 67 HRC

D Overall Diameter (mm)	d Shank Diameter (mm)	Chamfer Range Min/Max (mm)	L Overall Length (mm)	Series 8431 Code	Hard'X Series 8431-H Code
4.3	4	1.3-4.3	40	314357	314387
5.3	4	1.3-5.3	40	314360	314390
6.3	5	1.3-6.3	45	314363	314393
8.3	6	1.8-8.3	50	314366	314396
10.4	6	2.2-10.4	50	314369	314399

D Overall Diameter (mm)	d Shank Diameter (mm)	Chamfer Range Min/Max (mm)	L Overall Length (mm)	Series 8431 Code	Hard'X Series 8431-H Code
12.4	8	2.5-12.4	56	314372	314402
16.5	10	2.8-16.5	60	314375	314405
20.5	10	3-20.5	63	314378	314408
25	10	3.2-25	67	314381	314411
31	12	3.5-31	71	314384	314414

Metric – Carbide – 90° Angle – Extra-Long

D Overall Diameter (mm)	d Shank Diameter (mm)	Chamfer Range Min/Max (mm)	L Overall Length (mm)	Series 8431-L Code
6.3	6	1.3-6.3	84	314417
8.3	8	1.8-8.3	85	314420
10.4	10	2.2-10.4	87	314423

D Overall Diameter (mm)	d Shank Diameter (mm)	Chamfer Range Min/Max (mm)	L Overall Length (mm)	Series 8431-L Code
12.4	10	2.5-12.4	108	314426
16.5	16	2.8-16.5	112	314429
20.5	16	3-20.5	115	314432

Metric & Inch – Cobalt M35 & TiN Coated – 5-Piece Metric Sets | 6-Piece Inch Sets

- Metric sizes: 10.4, 16.5, 20.5, 25 and 31 mm
- Inch sizes: 1/4, 5/16, 3/8, 1/2, 5/8 and 3/4 Inch
- Supplied in fitted storage case



Included Angle	Metric 5-Piece Sets		Inch 6-Piece Sets	
	Cobalt M35	TiN Coated	Cobalt M35	TiN Coated
	Code	Code	Code	Code
60°	540351	541351	-	-
82°	540352	541352	540446	540447
90°	540353	541353	540444	540445
100°	540354	541354	-	-
120°	540355	541355	-	-



FLAT HEAD SCREWS

82° = SAE (UNF, UNC) 90° = Metric 100° = Aviation

Anti-Vibration Countersinks – 3 Flute

Metric – Cobalt M35 – 90° Angle – Red'X Coated



- Decreases the axial force compared to traditional countersinks, reducing tool vibrations which provides a better finish
- DIN 335-C
- The equal division 3 x 120° of the flutes offer good results in most materials
- HSSE-Cobalt (M35) with Red'X is 65 HRC, to machine steels up to 1000N/mm²
- Cast irons up to 200 HB, copper, brass, bronze, aluminum
- Red'X coating is 3500 HV and considerably increases the tool life by increasing wear resistance and improving surface finish

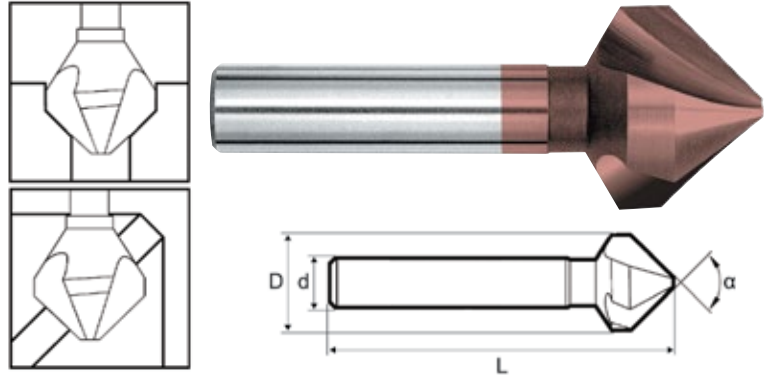

D Overall Diameter (mm)	d Shank Diameter (mm)	Chamfer Range Min/Max (mm)	L Overall Length (mm)	Series 493A Code
4.3	4	1.3-4.3	40	541160
5.3	4	1.5-5.3	40	541161
6.0	5	1.5-6.0	45	541162
6.3	5	1.5-6.3	45	541163
8.0	6	2.0-8.0	50	541164
8.3	6	2.0-8.3	50	541165
9.4	6	2.2-9.4	50	541166
10.0	6	2.5-10.0	50	541167
10.4	6	2.5-10.4	50	541168
11.5	8	2.8-11.5	56	541169

D Overall Diameter (mm)	d Shank Diameter (mm)	Chamfer Range Min/Max (mm)	L Overall Length (mm)	Series 493A Code
12.0	8	2.8-12.0	56	541170
12.4	8	2.8-12.4	56	541171
15.0	10	3.2-15.0	60	541172
16.5	10	3.2-16.5	60	541173
20.5	10	3.5-20.5	63	541174
25.0	10	3.8-25.0	67	541175
28.0	12	4.0-28.0	71	541176
30.0	12	4.2-30.0	71	541177
31.0	12	4.2-31.0	71	541178

Metric – Cobalt M35 – 90° Angle – Red'X Coated – 3-Piece Sets



Description	Red'X Series 493A
	Code
3-PC. SET 493A/98 – Ø 8.3mm, 12.4mm, 20.5mm	541179
3-PC. SET 493A/99 – Ø 10.4mm, 16.5mm, 25mm	541180

Countersinks – Chatterless with Hole

Cobalt M35 & TiN Coated



- The hole-style deburring tool is designed to countersink and chamfer light metals and plastics
- The finish is smooth and free of burrs
- Lubrication is recommended

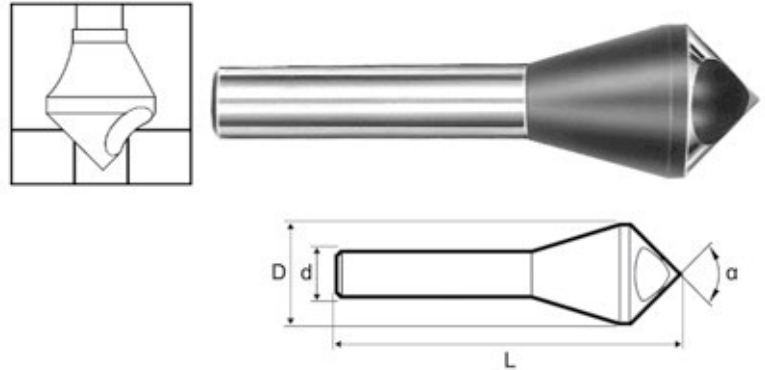

Inch & Metric – Cobalt M35 & TiN Coated – 60°, 82°, 90°, 100°, & 120° Angles

D Overall Diameter (Inch)	D Overall Diameter (mm)	d Shank Diameter	Chamfer Range Min/Max	L Overall Length (Inch)	60° Angle	82° Angle	82° Angle	90° Angle	90° Angle	100° Angle	120° Angle
					Series 412	Series 414	Series 4814 - TiN	Series 411	Series 4811	Series 415	Series 413
					Code	Code	Code	Code	Code	Code	Code
1/4	-	1/4"	0.08"-0.20"	1-3/4	∞601076	∞601081	601281	∞601086	601286	-	-
-	10	6 mm	4 mm-9 mm	1-3/4	540101	540111	541111	540121	541121	540131	540141
7/16	-	1/4"	0.20"-0.39"	1-3/4	601077	601082	601282	601087	601287	-	-
9/16	-	1/4"	0.24"-0.51"	2	601078	601083	601283	601088	601288	-	-
-	15	8 mm	6 mm-14 mm	2	540102	540112	541112	540122	541122	540132	540142
-	20	10 mm	8 mm-18 mm	2-1/2	540103	540113	541113	540123	541123	540133	540143
13/16	-	1/2"	0.31"-0.70"	2-5/8	601079	601084	601284	601089	601289	-	-
-	25	12 mm	10 mm-23 mm	3	540104	540114	541114	540124	541124	540134	540144
-	30	12 mm	12 mm-28 mm	3-1/2	540105	540115	541115	540125	541125	540135	540145
1-3/16	-	1/2"	0.47"-1.10"	3-1/2	601080	601085	601285	601090	601290	-	-
-	35	16 mm	14 mm-33 mm	4	*540106	*540116	541136	*540126	541126	*540136	*540146
-	40	16 mm	16 mm-38 mm	4-1/2	-	-	-	540127	-	-	-
-	50	16 mm	20 mm-48 mm	5	-	-	-	540128	-	-	-

∞ Double Ended

* Three gripping flats on shank

Inch & Metric – Cobalt M35 & TiN Coated – 5-Piece Sets

- Sizes included: Inch – 1/4", 7/16", 9/16", 13/16" and 1-3/16"
Metric – 10 mm, 15 mm, 20 mm, 25 mm and 30 mm
(for other dimension see above "Cobalt M35 – 60°, 82°, 90°, 100°, and 120° Angles")
- Supplied in fitted storage case



Included Angle	Inch Cobalt 35	Inch TiN Coated	Metric Cobalt 35	Metric TiN Coated
	Code	Code	Code	Code
60°	601091	601291	540151	541151
82°	601092	601292	540152	541152
90°	601093	601293	540153	541153
100°	-	-	540154	541154
120°	-	-	540155	541155

Countersinks – Single Flute

Cobalt M35 & TiN Coated



- Chamfers to outside diameter
- Up sharp cutting edge for smooth finish
- Lubrication is recommended
- Can be reground

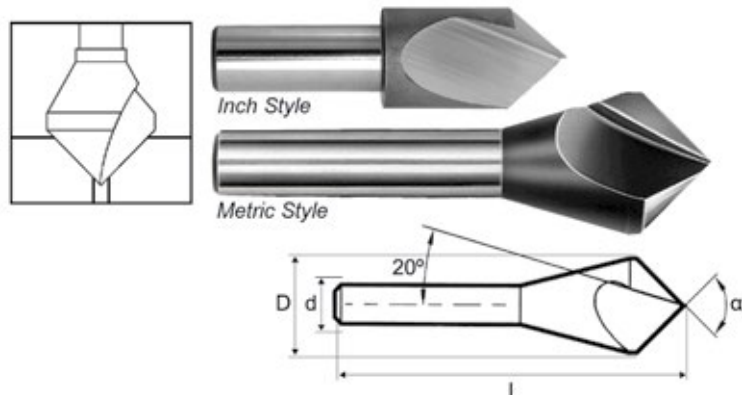

Inch & Metric – Cobalt M35 & TiN Coated – 60°, 82°, 90°, 100°, & 120° Angles

D Overall Diameter (Inch)	D Overall Diameter (mm)	d Shank Diameter	Chamfer Range Min/Max	L Overall Length (Inch)	60° Angle	82° Angle	82° Angle	90° Angle	90° Angle	100° Angle	120° Angle
					Series 422	Series 424	Series 4824 TiN	Series 421	Series 4821 TiN	Series 425	Series 423
					Code	Code	Code	Code	Code	Code	Code
1/8	–	1/8"	0"-1/8"	1-1/4	601094	601105	601305	601116	601416	–	–
3/16	–	3/16"	1/64"-3/16"	1-3/8	601095	601106	601306	601117	601417	–	–
1/4	–	1/4"	1/32"-1/4"	1-1/2	601096	601107	601307	601118	601418	–	–
5/16	–	1/4"	1/32"-5/16"	1-3/4	601097	601108	601308	601119	601419	–	–
3/8	–	1/4"	1/32"-3/8"	1-3/4	601098	601109	601309	601120	601420	–	–
–	10	6 mm	1 mm-10 mm	1-3/4	540201	540211	541211	540221	541221	540231	540241
–	12	8 mm	2 mm-12 mm	1-31/32	–	–	–	–	314505	–	–
–	12	8 mm	2 mm-12 mm	2-1/64	–	–	314500	–	–	–	–
1/2	–	1/4"	1/16"-1/2"	2	601099	601110	601310	601121	601421	–	–
–	15	8 mm	2 mm-15 mm	2-1/8	540202	540212	541212	540222	541222	540232	540242
5/8	–	3/8"	1/16"-5/8"	2-1/4	601100	601111	601311	601122	601422	–	–
3/4	–	1/2"	1/16"-3/4"	2-9/16	601101	601112	601312	601123	601423	–	–
–	20	10 mm	2 mm-20 mm	2-9/16	540203	540213	541213	540223	541223	540233	540243
7/8	–	1/2"	1/16"-7/8"	2-3/4	601102	601113	601313	601124	601424	–	–
–	25	12 mm	3 mm-25 mm	3	540204	540214	541214	540224	541224	540234	540244
1	–	1/2"	1/8"-1"	3	601103	601114	601314	601125	601425	–	–
–	30	12 mm	3 mm-30 mm	3-1/2	540205	540215	541215	540225	541225	540235	540245
1-1/4	–	1/2"	1/8"-1-1/4"	2-3/4	601104	601115	601315	601126	601426	–	–
–	35	16 mm	4 mm-35 mm	4	–	–	–	*540226	541226	–	–
–	40	16 mm	5 mm-40 mm	4-1/2	–	–	–	*540227	541227	–	–
–	50	16 mm	12 mm-50 mm	5	–	–	–	*540228	541228	–	–
–	63	MT3	12 mm-63 mm	7-5/32	–	–	–	540229	–	–	–

Inch & Metric – Cobalt M35 & TiN Coated – 5 & 6-Piece Sets

- Sizes included: Inch – 1/4", 5/16", 3/8", 1/2", 5/8" and 3/4"
Metric – 10mm, 15mm, 20mm, 25mm and 30mm
(for other dimension see above "Cobalt M35 – 60°, 82°, 90°, 100°, and 120° Angles")
- Supplied in fitted storage case



Included Angle	Inch 6-Piece Set Cobalt 35	Inch 6-Piece Set TiN Coated	Metric 5-Piece Set Cobalt 35	Metric 5-Piece Set TiN Coated
	Code	Code	Code	Code
60°	601127	601227	540251	541251
82°	601128	601228	540252	541252
90°	601129	601229	540253	541253
100°	–	–	540254	541254
120°	–	–	540255	541255

Countersinks – Chatterless – 6 Flute

High Speed Steel & Cobalt



- Designed for fast shearing cut

Inch – High Speed Steel & Cobalt – 60°, 82°, & 90° Angles

Diameter (Inch)	Shank Diameter (Inch)	Overall Length (Inch)	HSS			Cobalt		
			60° Angle	82° Angle	90° Angle	60° Angle	82° Angle	90° Angle
			Code	Code	Code	Code	Code	Code
1/4	1/4	2	601130	601142	601154	601166	601178	601190
5/16	1/4	2	601131	601143	601155	601167	601179	601191
3/8	1/4	2	601132	601144	601156	601168	601180	601192
1/2	1/4	2	601133	601145	601157	601169	601181	601193
5/8	1/2	2-3/4	601134	601146	601158	601170	601182	601194
3/4	1/2	2-3/4	601135	601147	601159	601171	601183	601195
7/8	1/2	2-3/4	601136	601148	601160	601172	601184	601196
1	1/2	2-3/4	601137	601149	601161	601173	601185	601197
1-1/4	3/4	3-3/8	601138	601150	601162	601174	601186	601198
1-1/2	3/4	3-1/2	601139	601151	601163	601175	601187	601199
1-3/4	1	4-1/4	601140	601152	601164	601176	601188	601200
2	1	4-3/8	601141	601153	601165	601177	601189	601201

COUNTERBORES & COUNTERSINKS

Countersinks – Single Flute

Carbide – Steel Shanks



- For mild steels

Inch – 82°, 90° Angles

Diameter (Inch)	Shank Diameter (Inch)	Overall Length (Inch)	82°	90°
			Included Angle	Included Angle
			Code	Code
1/8	1/8	1-1/2	950024	950048
3/16	3/16	1-1/2	950026	950050
1/4	1/4	2	950028	950052
3/8	1/4	2-7/16	950030	950054
1/2	1/4	2-1/2	950032	950056
5/8	1/4	2-5/8	950034	950058
3/4	3/8	2-7/8	950036	950060
1	1/2	3	950038	950062

Countersinks – 3 Flute

Carbide – Steel Shanks



Inch – 60°, 82°, 90° Angles

Diameter (Inch)	Shank Diameter (Inch)	Overall Length (Inch)	60°	82°	90°
			Included Angle	Included Angle	Included Angle
			Code	Code	Code
3/16	3/16	1-1/2	950074	950098	950122
1/4	1/4	2	950076	950100	950124
3/8	1/4	2-1/2	950078	950102	950126
1/2	1/4	2-1/2	950080	950104	950128
5/8	3/8	2-1/2	950082	950106	950130
3/4	3/8	2-3/4	950084	950108	950132
1	1/2	2-3/4	950086	950110	950134



If you can't find a product, or require a size not listed in our catalog contact us... One of our experienced Customer Service Representatives will be pleased to help you find it!



TORONTO



MONTRÉAL



EDMONTON

KAR is your ONE STOP SHOP for all your precision measuring, cutting tools, machine tool accessories and other manufacturing related supplies.

Visit us at WWW.KAR.CA to find current promotions, download supplier catalogs, check out inventory levels for all three warehouses and to find a local KAR Distributor.

Countersinks – 6 Flute

Carbide – Steel Shanks



Inch – 60°, 82°, & 90° Angles

Diameter (Inch)	Shank Diameter (Inch)	Overall Length (Inch)	60°	82°	90°	Diameter (Inch)	Shank Diameter (Inch)	Overall Length (Inch)	60°	82°	90°
			Included Angle	Included Angle	Included Angle				Included Angle	Included Angle	Included Angle
			Code	Code	Code				Code	Code	Code
1/4	1/4	2	950144	950166	950186	3/4	1/2	3	950152	950174	950194
3/8	1/4	2-13/16	950146	950168	950188	1	1/2	3-1/4	950154	950176	950196
1/2	1/4	2-7/8	950148	950170	950190	1-1/2	3/4	3-1/2	950156	-	-
5/8	3/8	3	950150	950172	950192						

COUNTERBORES & COUNTERSINKS

Machine Countersink Sets – 6 Flute

High Speed Steel



Included Angle	Description	Code
60°	SET – 5 Pieces – 1/4", 3/8", 1/2", 3/4", 1"	601202
60°	SET – 8 Pieces – 1/4", 5/16", 3/8", 1/2", 5/8", 3/4", 7/8", 1"	601203
82°	SET – 5 Pieces – 1/4", 3/8", 1/2", 3/4", 1"	601206
82°	SET – 8 Pieces – 1/4", 5/16", 3/8", 1/2", 5/8", 3/4", 7/8", 1"	601207
82°	SET – 11 Pieces – 3/16", 1/4", 5/16", 3/8", 1/2", 5/8", 3/4", 7/8", 1", 1-1/4", 1-1/2"	601209
90°	SET – 5 Pieces – 1/4", 3/8", 1/2", 3/4", 1"	601210
90°	SET – 8 Pieces – 1/4", 5/16", 3/8", 1/2", 5/8", 3/4", 7/8", 1"	601211
90°	SET – 10 Pieces – 1/4", 5/16", 3/8", 1/2", 5/8", 3/4", 7/8", 1", 1-1/4", 1-1/2"	601212



Center Reamers – 3 Flute

High Speed Steel

Included Angle	Description	Code
60°	SET – 5 Pieces – 1/4", 3/8", 1/2", 3/4", 1"	601214
82°	SET – 5 Pieces – 1/4", 3/8", 1/2", 3/4", 1"	601216
82°	SET – 6 Pieces – 1/4", 3/8", 1/2", 5/8", 3/4", 1"	601217



Hand Taps – Premium

Taper, Plug & Bottoming Style Taps

Inch Sizes

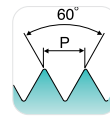
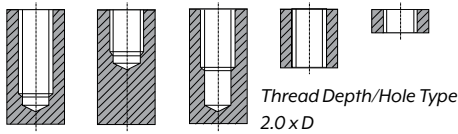

HSS

UNC
UNF
UNS

USCTI
302

9P/5P/2P

Bright

Size	Overall Length (Inch)	No. of Flutes	Thread Length (Inch)	Thread Limit	Taper Style	Plug Style	Bottoming Style
					Code	Code	Code
6-32	2	3	0.688	H3	915600	915628	915656
8-32	2-1/8	4	0.750	H3	915601	915629	915657
10-24	2-3/8	4	0.875	H3	915602	915630	915658
10-32	2-3/8	4	0.875	H3	915615	915643	915671
12-24	2-3/8	4	0.938	H3	915603	915631	915659
1/4-20	2-1/2	4	1.000	H3	915604	915632	915660
1/4-28	2-1/2	4	1.000	H3	915616	915644	915672
5/16-18	2-23/32	4	1.125	H3	915605	915633	915661
5/16-24	2-23/32	4	1.125	H3	915617	915645	915673
3/8-16	2-15/16	4	1.250	H3	915606	915634	915662
3/8-24	2-15/16	4	1.250	H3	915618	915646	915674
7/16-14	3-5/32	4	1.438	H3	915607	915635	915663
7/16-20	3-5/32	4	1.438	H3	915619	915647	915675
1/2-13	3-3/8	4	1.656	H3	915608	915636	915664
1/2-20	3-3/8	4	1.656	H3	915620	915648	915676
9/16-12	3-19/32	4	1.656	H3	915609	915637	915665
9/16-18	3-19/32	4	1.656	H3	915621	915649	915677
5/8-11	3-13/16	4	1.813	H3	915610	915638	915666
5/8-18	3-13/16	4	1.813	H3	915622	915650	915678
3/4-10	4-1/4	4	2.000	H3	915611	915639	915667
3/4-16	4-1/4	4	2.000	H3	915623	915651	915679
7/8-9	4-11/16	4	2.219	H3	915612	915640	915668
7/8-14	4-11/16	4	2.219	H4	915624	915652	915680
1-8	5-1/8	4	2.500	H3	915613	915641	915669
1-12	5-1/8	4	2.500	H4	915625	915653	915681
1-14	5-1/8	4	2.500	H4	915626	915654	915682
1-1/8-7	5-7/16	4	2.562	H3	915614	915642	915670
1-1/8-12	5-7/16	4	2.562	H4	915627	915655	915683

Metric Sizes

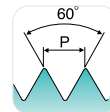
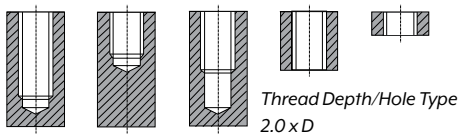

HSS

M
MF

USCTI
302

9P/5P/2P

Bright

Size & Pitch	Overall Length (Inch)	No. of Flutes	Thread Length (Inch)	Thread Limit	Taper Style	Plug Style	Bottoming Style
					Code	Code	Code
M1.6 x 0.35	1.63	3	0.310	D3	-	915817	-
M2 x 0.40	1.75	3	0.440	D3	-	915818	915847
M2.5 x 0.45	1.81	3	0.500	D3	-	915819	915848
M3 x 0.50	1.94	3	0.630	D3	915800	915820	915849
M3.5 x 0.60	2.00	3	0.690	D4	-	915821	915850
M4 x 0.70	2.13	4	0.750	D4	915801	915822	915851
M4.5 x 0.75	2.38	4	0.880	D4	-	915823	915852
M5 x 0.80	2.38	4	0.880	D4	915802	915824	915853
M6 x 1.00	2.50	4	1.000	D5	915803	915825	915854
M7 x 1.00	2.72	4	1.130	D5	-	915826	915855



Hand Taps – Premium

Taper, Plug & Bottoming Style Taps (continued)

Metric Sizes (continued)

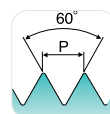
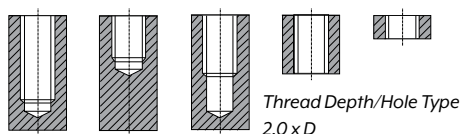

HSS

M
MF

USCTI
302

9P/5P/2P

Bright

Size & Pitch	Overall Length (Inch)	No. of Flutes	Thread Length (Inch)	Thread Limit	Taper Style	Plug Style	Bottoming Style
					Code	Code	Code
M8 x 1.25	2.72	4	1.130	D5	915804	915827	915856
M8 x 1.00	2.72	4	1.130	D5	-	915828	915857
M10 x 1.00	2.94	4	1.250	D5	-	915829	915858
M10 x 1.50	2.94	4	1.250	D6	915805	915830	915859
M10 x 1.25	2.94	4	1.250	D5	915806	915831	915860
M12 x 1.50	3.38	4	1.660	D6	-	915832	915861
M12 x 1.75	3.38	4	1.660	D6	915807	915833	915862
M12 x 1.25	3.38	4	1.660	D5	915808	915834	915863
M14 x 2.00	3.59	4	1.660	D7	915809	915835	915864
M14 x 1.50	3.59	4	1.660	D6	-	915836	915865
M14 x 1.25	3.59	4	1.660	D5	-	915837	915866
M16 x 2.00	3.81	4	1.810	D7	915810	915838	915867
M16 x 1.50	3.81	4	1.810	D6	915811	915839	915868
M18 x 2.50	4.03	4	1.810	D7	-	915840	915869
M18 x 1.50	4.03	4	1.810	D6	915812	915841	915870
M20 x 2.50	4.47	4	2.000	D7	915813	915842	915871
M20 x 1.50	4.47	4	2.000	D6	915814	915843	915872
M24 x 3.00	4.91	4	2.220	D8	915815	915844	915873
M30 x 3.50	5.44	4	2.560	D9	915816	915845	915874
M36 x 4.00	6.06	4	3.000	D9	-	915846	915875

TAPS, DIES & THREADING

Hand Taps – Value

Taper, Plug & Bottoming Style Taps



- For general use in production tapping or hand operations
- Taper, plug and bottoming styles provide great versatility in tough materials, blind and through-holes
- Sets include 1 taper tap, 1 plug tap and 1 bottoming tap

Inch Sizes

Size	No. of Flutes	Thread Limit	Taper Style	Plug Style	Bottoming Style	3-Piece Set
			Code	Code	Code	Code
1-64	2	1	828099	828100	828101	828350
1-72	2	1	828103	828104	828105	-
2-56	3	2	828107	828108	828109	828110
2-64	3	2	828112	828113	828114	828351
3-48	3	2	828117	828118	828119	828120
3-56	3	2	828122	828123	828124	828125
4-40	3	2	828128	828129	828130	828131
4-48	3	2	828133	828134	828135	828136
5-40	3	2	828140	828141	828142	828143
5-44	3	2	828145	828146	828147	828148
6-32	3	3	830000	830001	830002	828155
6-40	3	2	828157	828158	828159	828160
8-32	4	3	830003	830004	830005	828168
8-36	4	2	828170	828171	828172	828173
10-24	4	3	830006	830007	830008	828180
10-32	4	3	830009	828185	828186	828187
12-24	4	3	830010	828192	828193	828194
12-28	4	3	828196	828197	828198	828199
1/4-20	4	3	830011	830012	830013	828206
1/4-28	4	3	830014	830015	830016	828213
5/16-18	4	3	830017	830018	830019	828220
5/16-24	4	3	830020	830021	830022	828227
3/8-16	4	3	830023	830024	830025	828234
3/8-24	4	3	830026	830027	830028	828240
7/16-14	4	3	830029	830030	830031	828248
7/16-20	4	3	830032	830033	830034	828255
1/2-13	4	3	830035	830036	830037	828262
1/2-20	4	3	830038	830039	830040	828269
9/16-12	4	3	830041	830042	830043	828273
9/16-18	4	3	830044	830045	830046	828277
5/8-11	4	3	830047	830048	830049	828282
5/8-18	4	3	830050	830051	830052	828286
11/16-11	4	3	828287	828288	828289	828352
11/16-16	4	3	828290	828291	828292	828293
3/4-10	4	3	830053	830054	830055	828298
3/4-16	4	3	830056	830057	830058	828302
7/8-9	4	4	830059	830060	830061	828306
7/8-14	4	4	830062	830063	830064	828310
1-8	4	4	830065	830066	830067	830068
1-12	4	4	830069	830070	830071	828318
1-14	4	4	830072	830073	830074	828322
1-1/8-7	4	4	830075	830076	830077	828353
1-1/8-12	6	4	830078	830079	830080	828354
1-1/4-7	4	4	828329	828330	828331	828355
1-1/4-12	6	4	828332	828333	828334	828356
1-3/8-6	4	4	828335	828336	828337	828357
1-3/8-12	4	4	828338	828339	828340	-
1-1/2-6	4	4	828341	828342	828343	-
1-1/2-12	6	4	828344	828345	828346	-

TAPS, DIES & THREADING



Blue Colour Band Taps

Spiral Point Plug & Spiral Flute Bottoming Styles

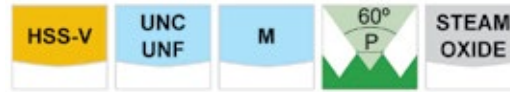

CUTTING CONDITIONS

Material	Material Sub-Group	Condition	Hardness (HRC)	Cutting Speed (FPM)
Low Carbon Steel	1018, 1010, 1035	normalized	<25	20-50
Medium Carbon Steel	1045, 1050, 1065	normalized	<25	20-40
Aluminum	unalloyed, cast	-	-	30-80
Brass/Bronze	-	-	-	30-80
Copper	-	-	-	25-60
Cast iron	-	as cast	<15	20-40

Inch Sizes

Size	Spiral Point					Spiral Flute				
	Overall Length (Inch)	No. of Flutes	Thread Length (Inch)	Thread Limit	Code	Overall Length (Inch)	No. of Flutes	Thread Length (Inch)	Thread Limit	Code
4-40	1-7/8	2	0.313	GH2	915170	1-7/8	2	0.313	GH2	915126
6-32	2	2	0.375	GH3	915172	2	3	0.375	GH3	915128
6-40	2	2	0.375	GH2	915174	2	-	0.375	GH2	-
8-32	2-1/8	2	0.375	GH3	915176	2-1/8	3	0.375	GH3	915130
10-24	2-3/8	2	0.500	GH3	915178	2-3/8	3	0.500	GH3	915132
10-32	2-3/8	2	0.500	GH3	915180	2-3/8	3	0.500	GH3	915134
12-24	2-3/8	2	0.500	GH3	915182	2-3/8	-	0.500	GH3	-
1/4-20	2-1/2	2	0.625	GH3	915184	2-1/2	3	0.625	GH3	915136
1/4-28	2-1/2	3	0.625	GH3	915186	2-1/2	3	0.625	GH3	915138
5/16-18	2-23/32	2	0.688	GH3	915188	2-23/32	3	0.688	GH3	915140
5/16-24	2-23/32	3	0.688	GH3	915190	2-23/32	3	0.688	GH3	915142
3/8-16	2-15/16	3	0.750	GH3	915192	2-15/16	3	0.750	GH3	915144
3/8-24	2-15/16	3	0.750	GH3	915194	2-15/16	3	0.750	GH3	915146
7/16-14	3-5/32	3	0.875	GH3	915196	3-5/32	3	0.875	GH3	915148
7/16-20	3-5/32	3	0.875	GH3	915198	3-5/32	3	0.875	GH3	-
1/2-13	3-3/8	3	0.938	GH3	915200	3-3/8	3	0.938	GH3	915150
1/2-20	3-3/8	3	0.938	GH3	915202	3-3/8	3	0.938	GH3	915152
5/8-11	3-13/16	3	1.094	GH3	915204	3-13/16	3	1.094	GH3	915154
5/8-18	3-13/16	3	1.094	GH3	915206	3-13/16	4	1.094	GH3	915156
3/4-10	4-1/4	3	1.219	GH3	915208	4-1/4	3	1.219	GH3	915158
3/4-16	4-1/4	3	1.219	GH3	915210	4-1/4	4	1.219	GH3	915160
7/8-9	4-11/16	3	1.344	GH4	915212	4-11/16	3	1.344	GH4	915162
7/8-14	4-11/16	3	1.344	GH4	915214	4-11/16	4	1.344	GH4	915164
1-8	5-1/8	3	1.500	GH4	915216	5-1/8	3	1.500	GH4	915166
1-12	5-1/8	3	1.500	GH4	915218	5-1/8	4	1.500	GH4	915168

Metric Sizes

Size & Pitch	Thread Limit	Overall Length (Inch)	Thread Length (Inch)	Spiral Point		Spiral Flute	
				No. of Flutes	Code	No. of Flutes	Code
M2 x 0.4	D3	1-15/16	0.313	2	915463	-	-
M2.5 x 0.45	D3	1-15/16	0.313	2	915465	-	-
M3 x 0.5	D3	1-15/16	0.313	2	915467	2	915419
M3.5 x 0.6	D4	2	0.375	2	915469	2	915421
M4 x 0.7	D4	2-1/8	0.375	2	915471	3	915423
M4.5 x 0.75	D4	2-3/8	0.500	2	915473	-	-
M5 x 0.8	D4	2-3/8	0.500	2	915475	3	915425
M6 x 1	D5	2-1/2	0.625	3	915477	3	915427
M7 x 1	D5	2-23/32	0.688	3	915479	3	915429
M8 x 1	D5	2-23/32	0.688	3	915483	3	915433

TAPS, DIES & THREADING



Blue Colour Band Taps

Spiral Point Plug & Spiral Flute Bottoming Styles



Metric Sizes (continued)

Size & Pitch	Thread Limit	Overall Length (Inch)	Thread Length (Inch)	Spiral Point		Spiral Flute	
				No. of Flutes	Code	No. of Flutes	Code
M8 x 1.25	D5	2-23/32	0.688	3	915481	3	915431
M10 x 1.25	D5	2-15/16	0.750	3	915487	3	915437
M10 x 1.5	D6	2-15/16	0.750	3	915485	3	915435
M12 x 1.25	D5	3-3/8	0.938	3	915491	3	915441
M12 x 1.75	D6	3-3/8	0.938	3	915489	3	915439
M14 x 1.5	D6	3-19/32	1.000	3	915495	3	915445
M14 x 2	D7	3-19/32	1.000	3	915493	3	915443
M16 x 1.5	D6	3-13/16	1.094	3	915499	4	915449
M16 x 2	D7	3-13/16	1.094	3	915497	3	915447
M18 x 1.5	D6	4-1/32	1.094	3	915503	4	915453
M18 x 2.5	D7	4-1/32	1.094	3	915501	4	915451
M20 x 1.5	D5	4-15/32	1.219	3	915507	4	915457
M20 x 2.5	D6	4-15/32	1.219	3	915505	4	915455
M22 x 1.5	D6	4-11/16	1.344	3	915511	4	915461
M22 x 2.5	D6	4-11/16	1.344	3	915509	4	915459
M24 x 1.5	D5	4-29/32	1.344	3	915515	-	-
M24 x 3	D7	4-29/32	1.344	3	915513	-	-

TAPS, DIES & THREADING

Yellow Colour Band Taps

Spiral Point Plug & Spiral Flute Bottoming Styles



Cutting Conditions

Material	Material Sub-Group	Condition	Hardness (HRC)	Cutting Speed (FPM)
Stainless Steel	200 Series	annealed	<28	20-35
	300 Series		<28	20-35
	17-4, 15-5		<25	15-25
	AM286		<25	15-25
	400 Series		<29	20-35
Tool Steel	01, A-2, D-2, H-13, P-20	annealed	<35	15-25
Medium Carbon Steel	1030, 1035, 1038, 1040, 1045, 1050	normalized	<28	20-40
Alloyed High Carbon Steel	1065, 1070, 1080, 1090, 1095, 1561, 1572	normalized	<32	20-30
High Strength Steel	4140, 4340	normalized	<32	20-30
Titanium	commercially pure	annealed	<32	15-30
Aluminum	cast, wrought		-	30-90

Inch Sizes

Size	Spiral Point					Spiral Flute				
	Overall Length (Inch)	No. of Flutes	Thread Length (Inch)	Thread Limit	Code	Overall Length (Inch)	No. of Flutes	Thread Length (Inch)	Thread Limit	Code
4-40	1-7/8	2	0.335	GH2	915060	1-7/8	2	0.236	GH2	915000
6-32	2	3	0.413	GH3	915062	2	3	0.276	GH2	915002
6-40	2	3	0.413	GH3	915064	2	3	-	-	-
8-32	2-1/8	3	0.453	GH3	915066	2-1/8	3	0.276	GH2	915004





Yellow Colour Band Taps

Spiral Point Plug & Spiral Flute Bottoming Styles



Inch Sizes (continued)

Size	Spiral Point					Spiral Flute				
	Overall Length (Inch)	No. of Flutes	Thread Length (Inch)	Thread Limit	Code	Overall Length (Inch)	No. of Flutes	Thread Length (Inch)	Thread Limit	Code
10-24	2-3/8	3	0.531	GH3	915068	2-3/8	3	0.354	GH2	915006
10-32	2-3/8	3	0.531	GH3	915070	2-3/8	3	0.276	GH3	915008
12-24	2-3/8	3	0.531	GH3	915072	2-3/8	3	-	-	-
1/4-20	2-1/2	3	0.591	GH3	915074	2-1/2	3	0.433	GH3	915010
1/4-28	2-1/2	3	0.591	GH3	915076	2-1/2	3	0.433	GH3	915012
5/16-18	2-23/32	3	0.669	GH3	915078	2-23/32	3	0.472	GH3	915014
5/16-24	2-23/32	3	0.669	GH3	915080	2-23/32	3	0.472	GH3	915016
3/8-16	2-15/16	3	0.748	GH3	915082	2-15/16	3	0.551	GH3	915018
3/8-24	2-15/16	3	0.748	GH3	915084	2-15/16	3	0.551	GH3	915020
7/16-14	3-5/32	3	0.866	GH3	915086	3-5/32	3	0.591	GH3	915022
7/16-20	3-5/32	3	0.866	GH3	915088	-	-	-	-	-
1/2-13	3-3/8	3	0.984	GH3	915090	3-3/8	3	0.630	GH3	915024
1/2-20	3-3/8	3	0.984	GH3	915092	3-3/8	3	0.630	GH3	915026
5/8-11	3-13/16	3	1.083	GH3	915094	3-13/16	4	0.478	GH3	915028
5/8-18	3-13/16	3	1.083	GH3	915096	3-13/16	3	0.572	GH3	915030
3/4-10	4-1/4	3	1.201	GH3	915098	4-1/4	4	0.827	GH3	915032
3/4-16	4-1/4	3	1.201	GH3	915100	4-1/4	4	0.591	GH3	915034
7/8-9	4-11/16	3	1.339	GH4	915102	4-11/16	4	0.827	GH4	915036
7/8-14	4-11/16	3	1.339	GH4	915104	4-11/16	4	0.709	GH4	915038
1-8	5-1/8	3	1.496	GH4	915106	5-1/8	4	0.764	GH4	915040
1-12	5-1/8	3	1.496	GH4	915108	5-1/8	4	0.984	GH4	915042
1-1/8-7	5-7/16	4	1.610	GH4	915110	5-7/16	4	1.115	GH4	915044
1-1/8-12	5-7/16	4	1.610	GH4	915112	5-7/16	4	0.984	GH4	915046
1-1/4-7	5-3/4	4	1.610	GH4	915114	5-3/4	4	1.115	GH4	915048
1-1/4-12	5-3/4	4	1.610	GH4	915116	5-3/4	4	0.984	GH4	915050
1-3/8-6	6-1/16	4	1.900	GH4	915118	5-3/4	4	1.115	GH4	915052
1-3/8-12	6-1/16	4	1.900	GH4	915120	5-3/4	4	1.115	GH4	915054
1-1/2-6	6-3/8	4	2.000	GH4	915122	6-3/8	4	1.350	GH4	915056
1-1/2-12	6-3/8	4	2.000	GH4	915124	6-3/8	4	1.350	GH4	915058

Metric Sizes

Size & Pitch	Spiral Point					Spiral Flute				
	Overall Length (Inch)	No. of Flutes	Thread Length (Inch)	Thread Limit	Code	Overall Length (Inch)	No. of Flutes	Thread Length (Inch)	Thread Limit	Code
M2 x 0.4	1-15/16	2	0.375	D3	915357	-	-	-	-	-
M2.5 x 0.45	1-15/16	2	0.375	D3	915359	-	-	-	-	-
M3 x 0.5	1-15/16	2	0.375	D3	915361	1-15/16	3	0.197	D3	915301
M3.5 x 0.6	2	2	0.375	D4	915363	2	3	0.276	D4	915303
M4 x 0.7	2-1/8	2	0.375	D4	915365	2-1/8	3	0.276	D4	915305
M4.5 x 0.75	2-3/8	2	0.500	D4	915367	-	-	-	-	-
M5 x 0.8	2-3/8	2	0.500	D4	915369	2-3/8	3	0.354	D4	915307
M6 x 1	2-1/2	2	0.625	D5	915371	2-1/2	3	0.433	D5	915309
M7 x 1	2-23/32	3	0.687	D5	915373	2-23/32	3	0.433	D5	915311
M8 x 1	2-23/32	3	0.687	D5	915377	2-23/32	3	0.472	D5	915315
M8 x 1.25	2-23/32	3	0.687	D5	915375	2-23/32	3	0.472	D5	915313
M10 x 1.25	2-15/16	3	0.750	D5	915381	2-15/16	3	0.472	D5	915319
M10 x 1.5	2-15/16	3	0.750	D6	915379	2-15/16	3	0.512	D6	915317
M12 x 1.25	3-3/8	3	0.937	D5	915385	3-3/8	3	0.551	D5	915323

TAPS, DIES & THREADING



Yellow Colour Band Taps

Spiral Point Plug & Spiral Flute Bottoming Styles



Metric Sizes (continued)

Size & Pitch	Spiral Point					Spiral Flute				
	Overall Length (Inch)	No. of Flutes	Thread Length (Inch)	Thread Limit	Code	Overall Length (Inch)	No. of Flutes	Thread Length (Inch)	Thread Limit	Code
M12 x 1.75	3-3/8	3	0.937	D6	915383	3-3/8	3	0.591	D6	915321
M14 x 1.5	3-19/32	3	1.000	D6	915389	3-19/32	3	0.709	D6	915327
M14 x 2	3-19/32	3	1.000	D7	915387	3-19/32	3	0.709	D7	915325
M16 x 1.5	3-13/16	3	1.093	D6	915393	3-13/16	3	0.551	D6	915331
M16 x 2	3-13/16	3	1.093	D7	915391	3-13/16	3	0.709	D7	915329
M18 x 1.5	4-1/32	3	1.093	D6	915397	4-1/32	4	0.551	D6	915335
M18 x 2.5	4-1/32	3	1.093	D7	915395	4-1/32	4	0.787	D7	915333
M20 x 1.5	4-1/4	3	1.201	D5	915401	4-1/32	4	0.551	D5	915339
M20 x 2.5	4-1/4	3	1.201	D6	915399	4-1/32	4	0.701	D6	915337
M22 x 1.5	4-11/16	3	1.343	D6	915405	4-11/16	4	0.551	D6	915343
M22 x 2.5	4-11/16	3	1.343	D6	915403	4-11/16	4	0.787	D6	915341
M24 x 1.5	4-29/32	3	1.496	D5	915409	4-11/16	4	0.551	D5	915347
M24 x 3	4-29/32	3	1.496	D7	915407	4-11/16	4	0.787	D7	915345
M27 x 1.5	5-1/8	3	1.540	D7	915413	5-1/8	4	0.690	D7	915351
M27 x 3	5-1/8	3	1.540	D7	915411	5-1/8	4	1.105	D7	915349
M30 x 1.5	5-1/8	3	1.540	D7	915417	5-7/16	4	0.690	D7	915355
M30 x 3.5	5-1/8	3	1.540	D7	915415	5-7/16	4	1.250	D7	915353

TAPS, DIES & THREADING

Red Colour Band Taps



Spiral Point Plug & Spiral Flute Bottoming Styles



Cutting Conditions

Material	Material Sub-Group	Condition	Hardness (HRC)	Cutting Speed (FPM)
Stainless Steel	17-4PH, 15-5, 17-7PH, AM350	hardened	<48	12-20
Tool Steel	O1, A-2, D-2, H-13, P-20	hardened	<48	10-20
High Strength Steel	4140, 4340, 50100	hardened	<48	15-20
Nickel Alloys	inconel, hastaloy, waspaloy, astraloy, rene, monel	annealed or hardened	<42	5-20
Titanium	6 AL 4	annealed or hardened	<42	8-15

Inch Sizes

Size	Spiral Point					Spiral Flute				
	Overall Length (Inch)	No. of Flutes	Thread Length (Inch)	Thread Limit	Code	Overall Length (Inch)	No. of Flutes	Thread Length (Inch)	Thread Limit	Code
4-40	1-7/8	2	0.335	H2	915258	1-7/8	2	0.236	H2	915220
5-40	1-15/16	3	0.374	H2	915260	1-15/16	3	-	-	-
6-32	2	3	0.413	H3	915262	2	3	0.276	H3	915222
8-32	2-1/8	3	0.453	H3	915264	2-1/8	3	0.276	H3	915224
10-24	2-3/8	3	0.531	H3	915266	2-3/8	3	0.354	H3	915226
10-32	2-3/8	3	0.531	H3	915268	2-3/8	3	0.276	H3	915228
1/4-20	2-1/2	3	0.591	H3	915270	2-1/2	3	0.433	H3	915230
1/4-28	2-1/2	3	0.591	H3	915272	2-1/2	3	0.354	H3	915232
5/16-18	2-23/32	3	0.669	H3	915274	2-23/32	3	0.472	H3	915234
5/16-24	2-23/32	3	0.669	H3	915276	2-23/32	3	0.394	H3	915236



Red Colour Band Taps

Spiral Point Plug & Spiral Flute Bottoming Styles



Inch Sizes (continued)

Size	Spiral Point					Spiral Flute				
	Overall Length (Inch)	No. of Flutes	Thread Length (Inch)	Thread Limit	Code	Overall Length (Inch)	No. of Flutes	Thread Length (Inch)	Thread Limit	Code
3/8-16	2-15/16	3	0.748	H3	915278	2-15/16	3	0.551	H3	915238
3/8-24	2-15/16	3	0.748	H3	915280	2-15/16	3	0.394	H3	915240
7/16-14	3-5/32	3	0.866	H3	915282	3-5/32	3	0.591	H3	915242
7/16-20	3-5/32	3	0.866	H3	915284	3-5/32	3	0.472	H3	915244
1/2-13	3-3/8	3	0.984	H3	915286	3-3/8	3	0.630	H3	915246
1/2-20	3-3/8	3	0.984	H3	915288	3-3/8	3	0.472	H3	915248
5/8-11	3-13/16	3	1.083	H3	915290	3-13/16	4	0.748	H3	915250
5/8-18	3-13/16	3	1.083	H3	915292	3-13/16	4	0.512	H3	915252
3/4-10	4-1/4	3	1.201	H3	915294	4-1/4	4	0.827	H3	915254
3/4-16	4-1/4	3	1.201	H3	915296	4-1/4	4	0.591	H3	915256

Metric Sizes

Size & Pitch	Overall Length (Inch)	Thread Limit	Spiral Point Plug Style			Spiral Flute Bottoming Style		
			No. of Flutes	Thread Length (Inch)	Code	No. of Flutes	Thread Length (Inch)	Code
M3 x 0.5	1-15/16	D3	3	0.374	915533	3	0.197	915517
M4 x 0.7	2-1/8	D4	3	0.453	915535	3	0.276	915519
M5 x 0.8	2-3/8	D4	3	0.531	915537	3	0.354	915521
M6 x 1.0	2-1/2	D5	3	0.591	915539	3	0.433	915523
M8 x 1.25	2-23/32	D5	3	0.669	915541	3	0.472	915525
M10 x 1.25	2-15/16	D5	3	0.748	915545	3	0.472	915529
M10 x 1.5	2-15/16	D6	3	0.748	915543	3	0.512	915527
M12 x 1.75	3-3/8	D6	3	0.984	915547	3	0.591	915531

Straight Taper Pipe Taps

High Speed Steel – Straight Flute – NPS – Ground Thread

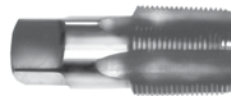

Size	Threads per Inch	Code	Size	Threads per Inch	Code	Size	Threads per Inch	Code
1/16	27	313131	1/2	14	313135	1-1/2	11-1/2	313139
1/8	27	313132	3/4	14	313136	2	11-1/2	313140
1/4	18	313133	1	11-1/2	313137			
3/8	18	313134	1-1/4	11-1/2	313138			

TAPS, DIES & THREADING



Pipe Taps

High Speed Steel – Straight Flute, Spiral Flute & Interrupted Thread



HSS – Straight Flute



- For cast iron and steel applications
- NPT and NPTF standards

HSSE-V3 – Spiral Flute



- For cast iron, steel and stainless steel applications
- NPT and NPTF standards
- High speed steel substrate with cobalt and 3% vanadium content for cutting stainless steels up to 29 HRC and tool steels up to 35 HRC

HSS – Interrupted Thread



- For cast iron and steel applications
- Reduces cutting pressure
- NPTF standards

Size (Inch)	Thread per Inch	No. of Flutes	Overall Length (Inch)	Thread Length (Inch)	Straight Flute	Spiral Flute	Interrupted Thread
					Code	Code	Code
1/16	27	4	2-1/8	0.688	915700	915716	-
1/8	27	4	2-1/8	0.750	915701	915717	915710
1/4	18	4	2-7/16	1.063	915702	915718	915711
3/8	18	4	2-9/16	1.063	915703	915719	915712
1/2	14	4	3-1/8	1.375	915704	915720	915713
3/4	14	5	3-1/4	1.375	915705	915721	915714
1	11-1/2	5	3-3/4	1.750	915706	915722	915715
1-1/4	11-1/2	5	4	1.750	915707	915723	-
1-1/2	11-1/2	7	4-1/4	1.750	915708	915724	-
2	11-1/2	7	4-1/2	1.750	915709	915725	-

Long Pipe Taps

High Speed Steel
Taper Pipe



Tap Size	No. of Flutes	6"	12"
		Overall Length Code	Overall Length Code
1/8 - 27	4	828900	-
1/4 - 18	4	828901	828905
3/8 - 18	4	828902	828906
1/2 - 14	4	828903	828907
3/4 - 14	5	828904	311522

Pulley Taps

High Speed Steel – Ground Thread



These taps have the same major and pitch diameters as standard fractional size taps, but with extended shanks for reaching locations inaccessible with regular hand taps.

Tap Size	Thread Length (Inch)	6"	8"	10"
		Overall Length Code	Overall Length Code	Overall Length Code
1/4 - 20	1	828077	828083	-
5/16 - 18	1-1/2	828078	828084	-
3/8 - 16	1-1/4	828079	828085	828089
7/16 - 14	1-7/16	828080	828086	828090
1/2 - 13	1-21/32	828081	828087	828091
5/8 - 11	1-13/16	828082	828088	828092
3/4 - 10	2	-	-	828093

Extension Taps

High Speed Steel – Ground Thread



- Plug chamfer
- Hand taps
- Spiral pointed
- Similar to a pulley tap but has a smaller shank diameter for long reach applications

Tap Size	Threads per Inch	6" Overall Length	
		Hand Tap	Spiral Point Tap
		Code	Code
#10	24	311775	311781
#10	32	311776	311782
1/4	20	311777	311783
5/16	18	311778	311784
3/8	16	311779	311785
1/2	13	311780	311786

Cutting Fluids



- Tapping, Drilling, Milling, Facing, Broaching, Boring, Turning, Engraving, Reaming, Threading, Sawing... Whatever the cut and whatever the metal - Tap Magic has the Fix!
- A fluid for all steps in machining any metal products:
 - Step 1 – Use any Tap Magic Cutting Fluid to extend tool life...
 - PROTAP, AQUEOUS, ECO-OIL, EP-EXTRA, ALUMINUM, XTRA-THICK, XTRA-FOAMY
 - Step 2 – Clean up with Multi-Purpose CLEANER/DEGREASER
 - Step 3 – Finish the job with CORROSION INHIBITOR
- Ozone and eco-friendly products – does not contain 1,1,1 trichloroethane



WIDE RANGE OF SIZES TO CHOOSE FROM



275 gal. Tote

TAPS, DIES & THREADING

Description	Size	Case Quantity	Code
EP-XTRA Ozone-friendly formula that provides outstanding performance on all cuts and all metals - even hard metals such as stainless steel. The proprietary additive, EP-Xtra, provides a synergistic boost in performance. A heavy duty and versatile formula that performs incredibly on all metals and in any operation.	12 oz. Aerosol	12	219201
XTRA-THICK Extreme performance heavyweight champion for hard metals – inconel, titanium, stainless... any metal up to 45 HRC! Virtually eliminates work hardening. Clinging action means it stays with the tool for deep cuts on heavy gauge materials and for lathe and mill work because it isn't prone to slinging of	16 oz.	12	219238
	1 gal.	1	219239
	5 gal.	1	219240
	30 gal.	1	219241
	55 gal.	1	219242
	275 gal. Tote	1	219243
XTRA-FOAMY With the added power of EP-X3, our extra foamy cutting fluid gives you high visibility on the most difficult metals and applications.	17 oz. Aerosol	12	219244
CLEANER/DEGREASER Expect the same great performance always provided for cleaning your tooling, workpieces, and equipment. After using Tap Magic cutting fluid, this is Step 2 in any machining operation for providing your customers with top quality parts	19 oz.	12	219245
CORROSION INHIBITOR After using Tap Magic cutting fluid and Cleaner, this is Step 3 in any machining operation for providing your customers with top quality parts.	1 gal.	1	219247

Cutting Fluids

(continued)



WIDE RANGE OF SIZES TO CHOOSE FROM



275 gal. Tote

Description	Size	Case Quantity	Code
PENETRATING FLUID Eliminate the "waiting time" when working with corroded or frozen parts. Tap Magic Penetrating Fluid works fast to save you time and money! This low viscosity fluid delivers corrosion inhibitors into the tightest of crevices quickly, breaking the bonds of rust	11 oz. Aerosol	12	219248
	4 oz.	24	219216
	12 oz. Aerosol	12	219217
	16 oz.	12	219218
PROTAP An eco-friendly cutting fluid that is totally biodegradable and can be applied to any and all cutting operations and metals. There is no operation or metal that will stand in your way with Tap Magic ProTap.	1 gal.	1	219219
	5 gal.	1	219220
	30 gal.	1	219221
	55 gal.	1	219222
	275 gal. Tote	1	219223
	16 oz.	12	219225
AQUEOUS This eco-friendly cutting fluid is a non-corrosive and water-based formula that is easy to clean up and totally biodegradable. This product can be applied to any and all cutting operations and metals with the exception of magnesium	1 gal.	1	219226
	5 gal.	1	219227
	30 gal.	1	219228
	55 gal.	1	219229
	275 gal. Tote	1	219230
	12 oz. Aerosol	12	219231
	16 oz.	12	219232
ECO-OIL Tap Magic Eco-Oil has been reformulated to meet the requirements of NSF's H1 Food Grade certification! It is still biodegradable and has a natural oil base that's remarkably low in odor and smoke – even on cuts that produce a lot of heat. Highly effective on all metals, especially stainless steel.	1 gal.	1	219233
	5 gal.	1	219234
	30 gal.	1	219235
	55 gal.	1	219236
	275 gal. Tote	1	219237

TAPS, DIES & THREADING

Combined Taps & Drills

High Speed Steel – 2 Flute – Ground Thread



- Designed to drill and tap through-holes in a single pass up to depths that are two times the tap diameter
- May be used on multiple spindle heads with reversing mechanisms

Machine Screw Sizes

Nominal Size	Drill Size (Inch)	Thread Length (Inch)	Overall Length (Inch)	Code	Nominal Size	Drill Size (Inch)	Thread Length (Inch)	Overall Length (Inch)	Code
4-40	0.0910	3/8	1-7/8	311537	8-32	0.1375	33/64	2-1/8	311544
4-48	0.0945	11/32	1-7/8	311538	10-24	0.1545	5/8	2-3/8	311545
5-40	0.1040	13/32	1-15/16	311540	10-32	0.1635	9/16	2-3/8	311546
6-32	0.1115	15/32	2	311541	12-24	0.1805	11/16	2-3/8	311547
6-40	0.1170	7/16	2	311543	12-28	0.1860	21/32	2-3/8	311548

Fractional Sizes

Nominal Size	Drill Size (Inch)	Thread Length (Inch)	Overall Length (Inch)	Code	Nominal Size	Drill Size (Inch)	Thread Length (Inch)	Overall Length (Inch)	Code
1/4-20	0.2080	13/16	2-1/2	311549	3/8-24	0.3395	1	3-3/8	311554
1/4-28	0.2200	23/22	2-1/2	311550	7/16-14	0.3770	1-5/16	3-3/4	311555
5/16-18	0.2660	31/32	2-27/32	311551	7/16-20	0.3955	1-3/16	4-3/4	311556
5/16-24	0.2770	7/8	2-27/32	311552	1/2-13	0.4350	1-15/32	4-1/16	311557
3/8-16	0.3225	1-1/8	3-3/8	311553	1/2-20	0.4580	1-15/16	4-1/16	311558

Metric Sizes

Nominal Size	Drill Size (Inch)	Thread Length (Inch)	Overall Length (Inch)	Code	Nominal Size	Drill Size (Inch)	Thread Length (Inch)	Overall Length (Inch)	Code
M3 x 0.50	M2.50	13/32	1-15/16	311559	M8 x 1.25	M6.75	15/16	2-27/32	311563
M4 x 0.70	M3.30	1/2	2-1/8	311560	M10 x 1.50	M8.50	1-1/16	3-3/8	311564
M5 x 0.80	M4.20	5/8	2-3/8	311561	M12 x 1.75	M10.25	1-3/8	4-1/16	311565
M6 x 1.00	M5.00	25/32	2-1/2	311562					

ACME Tandem Taps

High Speed Steel



- Tandem style tap eliminates the excessive cost of producing ACME threads
- Produces threads from 10° to 30° included angle in a single pass without a lead-screw
- The last few threads on the roughing section function as a guide for the short finishing section, which corrects the angles and brings the threads to size

Size (Inch)	Threads per Inch	Thread Length (Inch)	Overall Length (Inch)	Code
3/8	12	2-1/2	5	311566
1/2	10	2-9/16	5	311567
5/8	8	3-3/16	6-1/4	311568
3/4	6	4-5/16	7-15/16	311569
7/8	6	4-3/8	8-5/8	311570
1	5	5-1/4	10-1/8	311571
1-1/8	5	5-1/4	10-3/4	311572
1-1/4	5	5-1/4	11-1/8	311573
1-3/8	4	5-7/8	12-1/4	311574
1-1/2	4	5-7/8	12-5/8	311575



Tap Chucks

SJ Style – For Machine Screw, Hand & Pipe Tap Sizes

Tap Size	Morse Taper	Diameter of Tap Shank (Inch)	Dimension Across Flats of Square (Inch)	Depth Tap Enters Chuck (Inch)	Machine Screw Tap Sizes	Hand Tap Sizes	Pipe Tap Sizes
					Code	Code	Code
#0 to #6	1	0.1410	0.110	0.7125	826000	-	-
#8	1	0.1680	0.131	0.8250	826001	-	-
#10	1	0.1940	0.152	0.8875	826002	-	-
#12	1	0.2200	0.165	0.9125	826003	-	-
1/4	1	0.2550	0.191	0.9750	-	826004	-
1/4	2	0.2550	0.191	0.9750	-	826005	-
5/16	1	0.3180	0.238	1.0000	-	826006	-
5/16	2	0.3180	0.238	1.0000	-	826007	-
*3/8	1	0.2750	0.206	1.0500	-	826008	-
*3/8	2	0.2750	0.206	1.0500	-	826009	-
**3/8	2	0.3810	0.286	1.0500	-	826010	-
7/16	2	0.3230	0.242	1.0750	-	826011	-
1/2	2	0.3670	0.275	1.1000	-	826012	-
1/2	3	0.3670	0.275	1.1000	-	826013	-
9/16	2	0.4290	0.322	1.2750	-	826014	-
5/8	2	0.4800	0.360	1.4500	-	826015	-
5/8	3	0.4800	0.360	1.4500	-	826016	-
3/4	3	0.5900	0.442	1.8000	-	826017	-
3/4	4	0.5900	0.442	1.8000	-	826018	-
7/8	3	0.6970	0.523	1.9125	-	826019	-
7/8	4	0.6970	0.523	1.9125	-	826020	-
1	4	0.8000	0.600	2.0250	-	826021	-
1-1/8	5	0.8960	0.672	2.1375	-	826022	-
1-1/4	5	1.0210	0.766	2.3000	-	826023	-
1-3/8	5	1.1080	0.831	2.3500	-	826024	-
1-1/2	5	1.2330	0.925	2.4000	-	826025	-
1-3/4	5	1.4300	1.072	2.3750	-	826026	-
*1/16, 1/8	2	0.3125	0.234	1.0000	-	-	826027
**1/8	2	0.4375	0.328	1.0000	-	-	826028
1/4	3	0.5625	0.421	1.1250	-	-	826029
3/8	4	0.7000	0.531	1.3750	-	-	826030
1/2	4	0.6875	0.515	1.5000	-	-	826031
3/4	4	0.9063	0.679	1.6875	-	-	826032
3/4	5	0.9063	0.679	1.6875	-	-	826033
1	5	1.1250	0.843	1.8750	-	-	826034
1-1/4	5	1.3125	0.984	2.1250	-	-	826035
1-1/2	5	1.5000	1.125	2.2500	-	-	826036

*Small Shank **Large Shank 3/8 hand tap with small shank is not standard

Tap Drivers

Heavy Duty – For Hand & Pipe Tap Sizes

Broached square in holder is approximately 0.030" larger than tap square dimension "G"

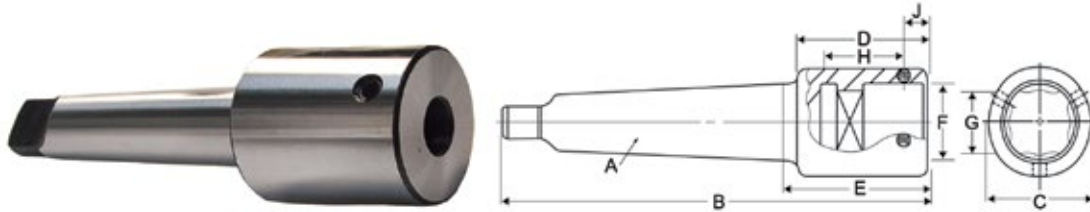

For Hand Tap Sizes

Tap Size (Inch)	A Morse Taper Shank	B Overall Length (Inch)	C Body Diameter (Inch)	D Body Length (Inch)	E Projection (Inch)	F Tap Shank (Inch)	G Tap Square (Inch)	H Depth Tap Enters Holder (Inch)	J Location of Set Screw (Inch)	Code
3/4	3	6	1-23/32	2-1/8	2-5/16	0.590	0.442	1-3/8	7/16	826037
3/4	4	7	1-23/32	2-1/8	2-3/8	0.590	0.442	1-3/8	7/16	826038
7/8	3	6	1-23/32	2-1/8	2-5/16	0.697	0.523	1-1/2	7/16	826039
7/8	4	7	1-23/32	2-1/8	2-3/8	0.697	0.523	1-1/2	7/16	826040
1	3	6	1-23/32	2-1/8	2-5/16	0.800	0.600	1-5/8	7/16	826041
1	4	7	1-23/32	2-1/8	2-3/8	0.800	0.600	1-5/8	7/16	826042
1-1/16 – 1-1/8	3	6	1-23/32	2-1/8	2-5/16	0.896	0.672	1-3/4	7/16	826043
1-1/16 – 1-1/8	4	7	1-23/32	2-1/8	2-3/8	0.896	0.672	1-3/4	7/16	826044
1-3/16 – 1-1/4	3	6-5/8	1-27/32	2-3/4	2-15/16	1.021	0.766	2-3/16	5/8	826045
1-3/16 – 1-1/4	4	7-5/8	1-27/32	2-3/4	3	1.021	0.766	2-3/16	5/8	826046
1-5/16 – 1-3/8	3	7-5/8	1-27/32	2-3/4	2-15/16	1.108	0.831	2-1/4	5/8	826047
1-5/16 – 1-3/8	4	9-1/8	1-27/32	2-3/4	3	1.108	0.831	2-1/4	5/8	826048
1-7/16 – 1-1/2	4	7-7/8	1-27/32	2-3/4	3	1.233	0.925	2-5/16	5/8	826049
1-7/16 – 1-1/2	5	9-1/8	2-19/32	3	3-1/4	1.233	0.925	2-5/16	5/8	826050
1-5/8	4	7-7/8	2-19/32	3	3-1/4	1.305	0.979	2-3/8	5/8	826051
1-5/8	5	9-1/8	2-19/32	3	3-1/4	1.305	0.979	2-3/8	5/8	826052
1-3/4	4	7-7/8	2-19/32	3	3-1/4	1.430	1.072	2-3/8	5/8	826053
1-3/4	5	9-1/8	2-19/32	3	3-1/4	1.430	1.072	2-3/8	5/8	826054
1-7/8	4	7-7/8	2-19/32	3	3-1/4	1.519	1.139	2-1/2	5/8	826055
1-7/8	5	9-1/8	2-19/32	3	3-1/4	1.519	1.139	2-1/2	5/8	826056
2	4	8	2-19/32	3-1/8	3-3/8	1.644	1.233	2-5/8	5/8	826057
2	5	9-5/8	2-23/32	3-1/2	3-3/4	1.644	1.233	2-5/8	3/4	826058
2-1/8	5	9-5/8	2-23/32	3-1/2	3-3/4	1.769	1.327	3	3/4	826059
2-1/4	5	10-3/16	2-31/32	4-1/16	4-5/16	1.894	1.420	3-1/8	7/8	826060
2-3/8	5	10-3/16	2-31/32	4-1/16	4-5/16	2.019	1.514	3-3/8	7/8	826061
2-1/2	5	10-1/2	3-11/32	4-3/8	4-5/8	2.100	1.575	3-1/2	1	826062
2-5/8	5	10-1/2	3-11/32	4-3/8	4-5/8	2.225	1.669	3-1/2	1	826063
2-3/4	5	10-1/2	3-11/32	4-3/8	4-5/8	2.350	1.762	3-5/8	1	826064
2-7/8	5	10-11/16	3-17/32	4-9/16	4-13/16	2.475	1.856	3-5/8	1	826065
3	5	10-11/16	3-17/32	4-9/16	4-13/16	2.543	1.907	3-3/4	1	826066

For Pipe Tap Sizes

Tap Size (Inch)	A Morse Taper Shank	B Overall Length (Inch)	C Body Diameter (Inch)	D Body Length (Inch)	E Projection (Inch)	F Tap Shank (Inch)	G Tap Square (Inch)	H Depth Tap Enters Holder (Inch)	J Location of Set Screw (Inch)	Code
3/4	3	6	1-23/32	2-1/8	2-5/16	0.9063	0.679	1-5/8	1/2	826067
3/4	4	7	1-23/32	2-1/8	2-3/8	0.9063	0.679	1-5/8	1/2	826068
1	3	6	1-23/32	2-1/8	2-5/16	1.1250	0.843	1-3/4	1/2	826069
1	4	7	1-23/32	2-1/8	2-3/8	1.1250	0.843	1-3/4	1/2	826070
1-1/4	4	7-9/16	2-7/32	2-11/16	2-15/16	1.3125	0.984	2	5/8	826071
1-1/4	5	8-13/16	2-7/32	2-11/16	2-15/16	1.3125	0.984	2	5/8	826072
1-1/2	4	7-9/16	2-7/32	2-11/16	2-15/16	1.5000	1.125	2-1/4	5/8	826073
1-1/2	5	8-13/16	2-7/32	2-11/16	2-15/16	1.5000	1.125	2-1/4	5/8	826074
1-3/4	4	7-7/8	2-19/32	3	3-1/4	1.6250	1.218	2-3/8	3/4	826075
1-3/4	5	9-1/8	2-19/32	3	3-1/4	1.6250	1.218	2-3/8	3/4	826076

Tap Drivers

Heavy Duty – For Hand & Pipe Tap Sizes (continued)

For Pipe Tap Sizes (continued)

Tap Size (Inch)	A Morse Taper Shank (Inch)	B Overall Length (Inch)	C Body Diameter (Inch)	D Body Length (Inch)	E Projection (Inch)	F Tap Shank (Inch)	G Tap Square (Inch)	H Depth Tap Enters Holder (Inch)	J Location of Set Screw (Inch)	Code
2	5	9-1/2	3-3/16	3-3/8	3-5/8	1.8750	1.406	2-1/2	3/4	826077
2-1/4	5	9-1/2	3-3/16	3-3/8	3-5/8	2.0000	1.500	2-5/8	3/4	826078
2-1/2	5	9-1/2	3-3/16	3-3/8	3-5/8	2.2500	1.687	2-3/4	3/4	826079
2-3/4	5	9-15/16	3-19/32	3-13/16	4-1/16	2.3750	1.781	2-7/8	3/4	826080
3	5	9-15/16	3-19/32	3-13/16	4-1/16	2.6250	1.968	3	3/4	826081

Tap Extensions

ANSI Standard



Tap Size	A Diameter (Inch)	B Square (Inch)	C Extension (Inch)	D	E Diameter (Inch)	Code
#0 – #6	0.141	0.110	2.000	1.000	0.440	685001
#8	0.168	0.131	2.000	1.000	0.440	685002
#10	0.194	0.152	2.000	1.000	0.440	685003
#12	0.220	0.165	2.000	1.000	0.440	685004
1/4	0.255	0.191	2.000	1.120	0.620	685005
5/16	0.318	0.238	2.000	1.120	0.620	685006
3/8	0.381	0.286	2.000	1.250	0.750	685007
7/16	0.323	0.242	2.000	1.250	0.750	685008
1/2	0.367	0.275	2.000	1.250	0.750	685009

Tap Size	A Diameter (Inch)	B Square (Inch)	C Extension (Inch)	D	E Diameter (Inch)	Code
9/16	0.429	0.322	3.000	1.380	0.750	685010
5/8	0.480	0.360	3.000	1.620	0.880	685011
3/4	0.590	0.442	3.000	1.750	1.000	685012
7/8	0.697	0.523	3.000	2.000	1.120	685013
1/8 P S S	0.312	0.234	2.000	1.250	0.620	685020
1/8 P L S	0.437	0.328	2.000	1.250	0.750	685021
1/4 P	0.562	0.421	2.000	1.250	0.880	685022
3/8 P	0.700	0.531	3.000	1.500	1.120	685023
1/2 P	0.687	0.515	3.000	1.500	1.120	685024

Tap Wrenches



For drill presses or lathes. Used for threading a drilled hole manually at one machine location without moving the workpiece. Better than a hand-held tap wrench.



Description	Range	Range (mm)	Length (Inch)	Code
T-Handle	#0 – #12	1.5 – 5.0	–	318001
	#10 – 1/4	4.0 – 6.0	–	318002
	#12 – 5/16	5.0 – 8.0	–	318003
	1/4 – 1/2	6.0 – 12.0	–	318004

Description	Range	Range (mm)	Length (Inch)	Code
Ratchet	#0 – 1/4	1.5 – 6.0	–	318006
	1/4 – 1/2	6.0 – 12.0	–	318007
Piloted Spindle	#0 – 1/4	1.5 – 6	–	318009
	1/4 – 1/2	6 – 12	–	318010
Adjustable Tap and Reamer	#0 – 1/4	1.5 – 6	7	318012
	#12 – 1/2	5 – 12	11	318013
	1/4 – 3/4	6 – 20	15	318014
	3/8 – 1	10 – 25	19	318015
	3/8 – 1-3/4	9.2 – 36	29	318017



Round Dies

High Speed Steel – Adjustable – Split

Machine Screw, Fractional, NPT Pipe & Metric Sizes

Machine Screw & Fractional Sizes

Size	Threads per Inch	Die Diameter (Inch)	Code
0	80	13/16	601500
1	64	13/16	601501
1	72	13/16	601502
2	56	13/16	601503
2	64	13/16	601504
3	48	13/16	601505
3	56	13/16	601506
4	48	13/16	601507
4	40	13/16	601508
4	36	13/16	601509
5	40	13/16	601510
5	44	13/16	601511
6	32	13/16	601512
6	40	13/16	601513
8	32	13/16	601514
8	36	13/16	601515
10	24	13/16	601516
10	32	13/16	601517
12	24	13/16	601518
12	28	13/16	601519
1/4	20	13/16	601520
1/4	28	13/16	601521
5/16	18	13/16	601522
5/16	24	13/16	601523
4	48	1	601524
4	40	1	601525
5	40	1	601526
6	32	1	601527
6	40	1	601528
8	32	1	601529

Size	Threads per Inch	Die Diameter (Inch)	Code
8	36	1	601530
10	24	1	601531
10	32	1	601532
12	24	1	601533
12	28	1	601534
1/4	20	1	601535
1/4	28	1	601536
5/16	18	1	601537
5/16	24	1	601538
3/8	16	1	601539
3/8	24	1	601540
7/16	14	1	601541
7/16	20	1	601542
1/2	13	1	601543
1/2	20	1	601544
1/4	20	1-1/2	601545
1/4	28	1-1/2	601546
5/16	18	1-1/2	601547
5/16	24	1-1/2	601548
3/8	16	1-1/2	601549
3/8	24	1-1/2	601550
7/16	14	1-1/2	601551
7/16	20	1-1/2	601552
1/2	13	1-1/2	601553
1/2	20	1-1/2	601554
9/16	12	1-1/2	601555
9/16	18	1-1/2	601556
5/8	11	1-1/2	601557
5/8	18	1-1/2	601558
11/16	11	1-1/2	601559

Size	Threads per Inch	Die Diameter (Inch)	Code
11/16	16	1-1/2	601560
3/4	10	1-1/2	601561
3/4	16	1-1/2	601562
1/4	20	2	601563
1/4	28	2	601564
5/16	18	2	601565
5/16	24	2	601566
3/8	16	2	601567
3/8	24	2	601568
7/16	14	2	601569
7/16	20	2	601570
1/2	13	2	601571
1/2	20	2	601572
9/16	12	2	601573
9/16	18	2	601574
5/8	11	2	601575
5/8	18	2	601576
3/4	10	2	601577
3/4	16	2	601578
7/8	9	2	601579
7/8	14	2	601580
1	8	2	601581
1	12	2	601582
1	14	2	601583
1-1/8	7	2-1/2	601584
1-1/8	12	2-1/2	601585
1-1/4	7	2-1/2	601586
1-1/4	12	2-1/2	601587
1-3/8	6	2-1/2	601588
1-3/8	12	2-1/2	601589
1-1/2	6	2-1/2	601590
1-1/2	12	2-1/2	601591

TAPS, DIES & THREADING

NPT Pipe Sizes

Size	Threads per Inch	Die Diameter (Inch)	Code
1/8	27	1	601592
1/8	27	1-1/2	601593

Size	Threads per Inch	Die Diameter (Inch)	Code
1/4	18	1-1/2	601594
3/8	18	1-1/2	601595

Size	Threads per Inch	Die Diameter (Inch)	Code
1/2	14	2	601596
3/4	14	2	601597
1	11-1/2	2-1/2	601598

Metric Sizes

Size (mm)	Pitch (mm)	Die Diameter (Inch)	Code
2	0.40	1	601599
2.2	0.45	1	601600
2.3	0.40	1	601601
2.5	0.45	1	601602
2.6	0.45	1	601603
3	0.50	1	601604
3.5	0.60	1	601605
4	0.50	1	601606

Size (mm)	Pitch (mm)	Die Diameter (Inch)	Code
4	0.70	1	601607
4.5	0.50	1	601608
4.5	0.75	1	601609
5	0.50	1	601610
5	0.80	1	601611
6	0.50	1	601612
6	0.75	1	601613
6	1.00	1	601614

Size (mm)	Pitch (mm)	Die Diameter (Inch)	Code
7	0.75	1	601615
7	1.00	1	601616
8	0.75	1	601617
8	1.00	1	601618
8	1.25	1	601619
9	1.25	1	601620
10	0.75	1	601621
10	1.00	1	601622



Round Dies

High Speed Steel – Adjustable – Split

Machine Screw, Fractional, NPT Pipe & Metric Sizes

Metric Sizes (continued)

Size (mm)	Pitch (mm)	Die Diameter (Inch)	Code	Size (mm)	Pitch (mm)	Die Diameter (Inch)	Code	Size (mm)	Pitch (mm)	Die Diameter (Inch)	Code
10	1.25	1	601623	14	1.00	1-1/2	601639	20	2.50	2	601655
10	1.50	1	601624	14	1.25	1-1/2	601640	22	1.00	2	601656
11	1.50	1	601625	14	1.50	1-1/2	601641	22	1.50	2	601657
12	1.00	1	601626	14	2.00	1-1/2	601642	22	2.00	2	601658
9	1.00	1-1/2	601627	15	1.50	1-1/2	601643	22	2.50	2	601659
9	1.25	1-1/2	601628	16	1.00	1-1/2	601644	24	1.50	2	601660
10	0.75	1-1/2	601629	16	1.50	1-1/2	601645	24	2.00	2	601661
10	1.00	1-1/2	601630	16	2.00	1-1/2	601646	24	3.00	2	601662
10	1.25	1-1/2	601631	17	1.50	1-1/2	601647	27	2.00	2	601663
10	1.50	1-1/2	601632	18	1.50	1-1/2	601648	27	3.00	2	601664
11	1.00	1-1/2	601633	18	2.00	1-1/2	601649	28	1.50	2	601665
11	1.50	1-1/2	601634	18	2.50	1-1/2	601650	30	1.50	2	601666
12	1.00	1-1/2	601635	20	1.50	1-1/2	601651	30	2.00	2	601667
12	1.25	1-1/2	601636	20	2.50	1-1/2	601652	30	3.50	2	601668
12	1.50	1-1/2	601637	20	1.50	2	601653				
12	1.75	1-1/2	601638	20	2.00	2	601654				

TAPS, DIES & THREADING



Hexagonal Dies

Carbon Steel – Rethreading

Machine Screw, Fractional, NPT Pipe & Metric Sizes

Machine Screw & Fractional Sizes

Size	Threads per Inch	Code	Size	Threads per Inch	Code	Size	Threads per Inch	Code	Size	Threads per Inch	Code
2	56	311787	12	28	311799	9/16	18	311811	1-1/8	7	311823
4	40	311788	1/4	20	311800	5/8	11	311812	1-1/8	12	311824
4	48	311789	1/4	28	311801	5/8	18	311813	1-1/4	7	311825
5	40	311790	5/16	18	311802	11/16	11	311814	1-1/4	12	311826
5	44	311791	5/16	24	311803	11/16	16	311815	1-3/8	6	311827
6	32	311792	3/8	16	311804	3/4	10	311816	1-3/8	12	311828
6	40	311793	3/8	24	311805	3/4	16	311817	1-1/2	6	311829
8	32	311794	7/16	14	311806	7/8	9	311818	1-1/2	12	311830
8	36	311795	7/16	20	311807	7/8	14	311819	1-3/4	5	311831
10	24	311796	1/2	13	311808	1	8	311820	2	4-1/2	311832
10	32	311797	1/2	20	311809	1	12	311821	2-1/4	4-1/2	311833
12	24	311798	9/16	12	311810	1	14	311822	2-1/2	4	311834

NPT Pipe Sizes

Size (Inch)	Threads per Inch	Code	Size (Inch)	Threads per Inch	Code	Size (Inch)	Threads per Inch	Code
1/8	27	311874	3/8	18	311876	3/4	14	311878
1/4	18	311875	1/2	14	311877	1	11-1/2	311879



Hexagonal Dies

Carbon Steel – Rethreading

Machine Screw, Fractional, NPT Pipe & Metric Sizes (continued)

Metric Sizes

Size (mm)	Pitch (mm)	Code	Size (mm)	Pitch (mm)	Code	Size (mm)	Pitch (mm)	Code	Size (mm)	Pitch (mm)	Code
3	0.50	311835	8	1.25	311845	14	2.00	311855	24	3.00	311865
3	0.60	311836	9	1.00	311846	16	1.50	311856	27	2.00	311866
4	0.70	311837	9	1.25	311847	16	2.00	311857	27	3.00	311867
4	0.75	311838	10	1.25	311848	18	1.50	311858	30	2.00	311868
5	0.80	311839	10	1.50	311849	18	2.50	311859	30	3.50	311869
5	0.90	311840	11	1.50	311850	20	1.50	311860	33	2.00	311870
6	1.00	311841	12	1.25	311851	20	2.50	311861	33	3.50	311871
6.3	1.00	311842	12	1.50	311852	22	1.50	311862	36	3.00	311872
7	1.00	311843	12	1.75	311853	22	2.50	311863	36	4.00	311873
8	1.00	311844	14	1.50	311854	24	2.00	311864			

Round Die Holders



Hand Type - Die Stock



Piloted Spindle



Floating

Description	Ø Die (Inch)	Ø Body (Inch)	Ø Shank (Inch)	Overall Length (Inch)	Code
Hand Type Die Stock	13/16	-	-	-	318020
	1	-	-	-	318021
	1-5/16	-	-	-	318022
	1-1/2	-	-	-	318023
	2	-	-	-	318024
	2-1/2	-	-	-	318025

Description	Ø Die (Inch)	Ø Body (Inch)	Ø Shank (Inch)	Overall Length (Inch)	Code
Piloted Spindle	13/16	1-1/2	-	3	318030
	1	1-1/2	-	3	318031
Floating	13/16	-	1/2	-	318027
	1	-	1/2	-	318028
	1-1/2	-	3/4	-	318029

Screw Extractors



• For removing broken screws, studs, pipe fittings, etc., without damaging the threads



Size	Sizes for Screws & Bolts (Inch)	Pipe Size (Inch)	Code	Size	Sizes for Screws & Bolts (Inch)	Pipe Size (Inch)	Code
1	3/16 – 1/4	-	311496	7	1 – 1-3/8	1/2	311502
2	1/4 – 5/16	-	311497	8	1-3/8 – 1-3/4	3/4	311503
3	5/16 – 7/16	-	311498	9	1-3/4 – 2-1/8	1	311504
4	7/16 – 9/16	1/8	311499	10	2-1/8 – 2-1/2	1-1/4	311505
5	9/16 – 3/4	1/4	311500	11	2-1/2 – 3	1-1/2	311506
6	3/4 – 1	3/8	311501	12	3 – 3-1/2	2	311507

Size	Sizes for Screws & Bolts (Inch)	Pipe Size (Inch)	Code
SETS – 5 Pieces – Sizes 1 to 5 Spiral/Helical Flutes			311508

Premium Bolt & Screw Extrator Sets

Spiral & Square – Left Hand – Gold Finish



Spiral – 10 Pieces

Description	Code
5 left hand drill sizes: 3/32", 1/8", 3/16", 1/4" and 5/16", and 5 spiral extrators Supplied in Metal Index	750008



Square – 8 Pieces

Description	Code
4 left hand drill sizes: 1/8", 3/16", 1/4" and 5/16", and 4 square extrators Supplied in Metal Index	750009

Tap & Drill Sets

- Larger drill diameters which reduce tap breakage
- Supplied in vinyl storage case

Fractional & Machine Screw



Taps (Plug)	Tap Drill
6 - 32	7/64
8 - 32	#29
10 - 24	#23
10 - 32	#20
1/4 - 20	13/64
5/16 - 18	17/64
3/8 - 16	P
1/2 - 13	7/16

Metric



Taps (Plug)	Tap Drill (mm)
M3 x 0.50	2.50
M3.5 x 0.60	2.90
M4 x 0.70	3.30
M5 x 0.80	4.20
M6 x 1.00	5.00
M8 x 1.25	6.75
M10 x 1.50	8.50
M12 x 1.75	10.25

Description	Code
16-Piece Set (8 taps and 8 drills) Supplied in Vinyl Pouch	311526

Description	Code
16-Piece Set (8 taps and 8 drills) Supplied in Vinyl Pouch	311527

Premium Tap & Drill Sets

Black & Gold – 18 Pieces

- These premium heavy duty drills have gold treatment for maximum lubricity and torsional strength



Description	Code
135° Split Point Drills: 5/16", 27/64", #7, #21, #25, #29, #36, F and U, and Spiral Point Taps: 6-32, 8-32, 10-24, 10-32, 1/4-20, 5/16-18, 3/8-16, 7/16-14 and 1/2-13 Supplied in Metal Index	750007

End Mills

Micrograin Solid Carbide – Uncoated & TiAlN Coated – 4 Flute – Center Cut

Regular Length



Cutter Diameter (Inch)	Shank Diameter (Inch)	Length of Cut (Inch)	Overall Length (Inch)	Uncoated	TiAlN Coated	Cutter Diameter (Inch)	Shank Diameter (Inch)	Length of Cut (Inch)	Overall Length (Inch)	Uncoated	TiAlN Coated
				Code	Code					Code	Code
1/32	1/8	3/32	1-1/2	932957	933186	5/16	5/16	13/16	2-1/2	933011	933240
3/64	1/8	1/8	1-1/2	932960	933189	21/64	3/8	7/8	2-1/2	933014	933243
1/16	1/8	3/16	1-1/2	932963	933192	11/32	3/8	7/8	2-1/2	933017	933246
5/64	1/8	3/16	1-1/2	932966	933195	23/64	3/8	7/8	2-1/2	933020	933249
3/32	1/8	3/8	1-1/2	932969	933198	3/8	3/8	7/8	2-1/2	933023	933252
7/64	1/8	3/8	1-1/2	932972	933201	25/64	7/16	1	2-3/4	933026	933255
1/8	1/8	1/2	1-1/2	932975	933204	13/32	7/16	1	2-3/4	933029	933258
9/64	3/16	9/16	2	932978	933207	27/64	7/16	1	2-3/4	933032	933261
5/32	3/16	9/16	2	932981	933210	7/16	7/16	1	2-3/4	933035	933264
11/64	3/16	5/8	2	932984	933213	29/64	1/2	1	3	933038	933267
3/16	3/16	5/8	2	932987	933216	15/32	1/2	1	3	933041	933270
13/64	1/4	5/8	2-1/2	932990	933219	31/64	1/2	1	3	933044	933273
7/32	1/4	5/8	2-1/2	932993	933222	1/2	1/2	1	3	933047	933276
15/64	1/4	3/4	2-1/2	932996	933225	9/16	9/16	1-1/4	3	933050	933279
1/4	1/4	3/4	2-1/2	932999	933228	5/8	5/8	1-1/4	3-1/2	933053	933282
17/64	5/16	3/4	2-1/2	933002	933231	11/16	3/4	1-1/2	4	933056	933285
9/32	5/16	3/4	2-1/2	933005	933234	3/4	3/4	1-1/2	4	933059	933288
19/64	5/16	13/16	2-1/2	933008	933237	7/8	7/8	1-1/2	4	933062	933291
						1	1	1-1/2	4	933065	933294

Metric – Regular Length



Cutter Diameter (mm)	Shank Diameter (mm)	Length of Cut (mm)	Overall Length (mm)	Uncoated
				Code
1.0	3.0	4.0	38.0	934373
1.5	3.0	4.5	38.0	934376
2.0	3.0	6.0	38.0	934379
2.5	3.0	8.0	38.0	934382
3.0	3.0	10.0	38.0	934385
3.5	4.0	12.0	50.0	934388
4.0	4.0	12.0	50.0	934391
4.5	5.0	14.0	50.0	934394
5.0	5.0	15.0	50.0	934397
6.0	6.0	18.0	63.0	934400
7.0	8.0	20.0	63.0	934403
8.0	8.0	20.0	63.0	934406
9.0	10.0	22.0	63.0	934409
10.0	10.0	22.0	63.0	934412
11.0	12.0	25.0	75.0	934415
12.0	12.0	25.0	75.0	934418
14.0	14.0	25.0	75.0	934421
16.0	16.0	32.0	90.0	934424
18.0	18.0	32.0	100.0	934427
20.0	20.0	38.0	100.0	934430
22.0	22.0	38.0	102.0	934433
25.0	25.0	38.0	100.0	934436

Stub Length



Cutter Diameter (Inch)	Shank Diameter (Inch)	Length of Cut (Inch)	Overall Length (Inch)	Uncoated
				Code
1/32	1/8	5/64	1-1/2	932070
3/64	1/8	3/32	1-1/2	932073
1/16	1/8	1/8	1-1/2	932076
5/64	1/8	5/32	1-1/2	932079
3/32	1/8	3/16	1-1/2	932082
7/64	1/8	7/32	1-1/2	932085
1/8	1/8	1/4	1-1/2	932088
9/64	3/16	9/32	2	932091
5/32	3/16	5/16	2	932094
11/64	3/16	5/16	2	932097
3/16	3/16	3/8	2	932100
13/64	1/4	3/8	2	932103
7/32	1/4	7/16	2	932106
15/64	1/4	7/16	2	932109
1/4	1/4	1/2	2	932112
5/16	5/16	1/2	2	932115
3/8	3/8	5/8	2	932118
7/16	7/16	5/8	2-1/2	932121
1/2	1/2	5/8	2-1/2	932124
5/8	5/8	3/4	3	932127
3/4	3/4	1	3	932130

END MILLS & ROUGHERS



End Mills

Micrograin Solid Carbide – Uncoated & TiAlN-Futura Coated – 4 Flute – Center Cut



- Suitable for cutting hardened and high alloy steels, steel casting, chill casting, malleable cast iron, CrNi-steels, brass, copper, aluminum with a high percentage of silicon and abrasive plastics

Tolerance: 0/-0.0012

Long Length



Extra Long Length



Cutter Diameter (Inch)	Shank Diameter (Inch)	Length of Cut (Inch)	Overall Length (Inch)	Uncoated	TiAlN-Futura Coated	Cutter Diameter (Inch)	Shank Diameter (Inch)	Length of Cut (Inch)	Overall Length (Inch)	Uncoated	TiAlN-Futura Coated
				Code	Code					Code	Code
1/8	1/8	3/4	2-1/4	932892	934580	1/8	1/8	1	3	932744	934620
3/16	3/16	3/4	2-1/4	932895	934900	3/16	3/16	1-1/8	3	932747	934911
1/4	1/4	1-1/8	3	932898	934582	1/4	1/4	1-1/2	4	932750	934622
5/16	5/16	1-1/8	3	932901	934583	5/16	5/16	1-5/8	4	932753	934623
3/8	3/8	1-1/8	3	932904	934901	3/8	3/8	1-3/4	4	932756	934912
7/16	7/16	2	4	932907	934585	7/16	7/16	3	6	932759	934625
1/2	1/2	2	4	932910	934586	1/2	1/2	3	6	932762	934626
5/8	5/8	2-1/4	5	932913	934902	5/8	5/8	3	6	932765	934913
3/4	3/4	2-1/4	5	932916	934588	3/4	3/4	3	6	932768	934628
1	1	2-1/4	5	932919	934589	1	1	3	6	932771	934629

End Mills

Micrograin Solid Carbide – Uncoated & TiAlN Coated – 4 Flute – Ball Nose

Regular Length



Cutter Diameter (Inch)	Shank Diameter (Inch)	Length of Cut (Inch)	Overall Length (Inch)	Uncoated	TiAlN Coated	Cutter Diameter (Inch)	Shank Diameter (Inch)	Length of Cut (Inch)	Overall Length (Inch)	Uncoated	TiAlN Coated
				Code	Code					Code	Code
1/32	1/8	3/32	1-1/2	933422	933658	5/16	5/16	13/16	2-1/2	933476	933712
3/64	1/8	1/8	1-1/2	933425	933661	21/64	3/8	7/8	2-1/2	933479	933715
1/16	1/8	3/16	1-1/2	933428	933664	11/32	3/8	7/8	2-1/2	933482	933718
5/64	1/8	3/16	1-1/2	933431	933667	23/64	3/8	7/8	2-1/2	933485	933721
3/32	1/8	3/8	1-1/2	933434	933670	3/8	3/8	7/8	2-1/2	933488	933724
7/64	1/8	3/8	1-1/2	933437	933673	25/64	7/16	1	2-3/4	933491	933727
1/8	1/8	1/2	1-1/2	933440	933676	13/32	7/16	1	2-3/4	933494	933730
9/64	3/16	9/16	2	933443	933679	27/64	7/16	1	2-3/4	933497	933733
5/32	3/16	9/16	2	933446	933682	7/16	7/16	1	2-3/4	933500	933736
11/64	3/16	5/8	2	933449	933685	29/64	1/2	1	3	933503	933739
3/16	3/16	5/8	2	933452	933688	15/32	1/2	1	3	933506	933742
13/64	1/4	5/8	2-1/2	933455	933691	31/64	1/2	1	3	933509	933745
7/32	1/4	5/8	2-1/2	933458	933694	1/2	1/2	1	3	933512	933748
15/64	1/4	3/4	2-1/2	933461	933697	9/16	9/16	1-1/4	3	933515	933751
1/4	1/4	3/4	2-1/2	933464	933700	5/8	5/8	1-1/4	3-1/2	933518	933754
17/64	5/16	3/4	2-1/2	933467	933703	11/16	3/4	1-1/2	4	933521	933757
9/32	5/16	3/4	2-1/2	933470	933706	3/4	3/4	1-1/2	4	933524	933760
19/64	5/16	13/16	2-1/2	933473	933709	7/8	7/8	1-1/2	4	933527	933763
						1	1	1-1/2	4	933530	933766

End Mills

Micrograin Solid Carbide – Uncoated – 4 Flute – Ball Nose (continued)

Metric – Regular Length



Stub Length



Cutter Diameter (mm)	Shank Diameter (mm)	Length of Cut (mm)	Overall Length (mm)	Uncoated	
				Code	
1.0	3.0	4.0	38.0	934519	
1.5	3.0	4.5	38.0	934521	
2.0	3.0	6.0	38.0	934523	
2.5	3.0	8.0	38.0	934525	
3.0	3.0	10.0	38.0	934527	
3.5	4.0	12.0	50.0	934529	
4.0	4.0	12.0	50.0	934531	
4.5	5.0	14.0	50.0	934533	
5.0	5.0	15.0	50.0	934535	
6.0	6.0	18.0	63.0	934537	
7.0	8.0	20.0	63.0	934539	
8.0	8.0	20.0	63.0	934541	
9.0	10.0	22.0	63.0	934543	
10.0	10.0	22.0	63.0	934545	
11.0	12.0	25.0	75.0	934547	
12.0	12.0	25.0	75.0	934549	
14.0	14.0	25.0	75.0	934551	
16.0	16.0	32.0	90.0	934553	
18.0	18.0	32.0	100.0	934555	
20.0	20.0	38.0	100.0	934557	
25.0	25.0	38.0	100.0	934561	

Cutter Diameter (Inch)	Shank Diameter (Inch)	Length of Cut (Inch)	Overall Length (Inch)	Uncoated	
				Code	
1/32	1/8	5/64	1-1/2	932210	
3/64	1/8	3/32	1-1/2	932213	
1/16	1/8	1/8	1-1/2	932216	
5/64	1/8	5/32	1-1/2	932219	
3/32	1/8	3/16	1-1/2	932222	
7/64	1/8	7/32	1-1/2	932225	
1/8	1/8	1/4	1-1/2	932228	
9/64	3/16	9/32	2	932231	
5/32	3/16	5/16	2	932234	
11/64	3/16	5/16	2	932237	
3/16	3/16	3/8	2	932240	
13/64	1/4	3/8	2	932243	
7/32	1/4	7/16	2	932246	
15/64	1/4	7/16	2	932249	
1/4	1/4	1/2	2	932252	
5/16	5/16	1/2	2	932255	
3/8	3/8	5/8	2	932258	
7/16	7/16	5/8	2-1/2	932261	
1/2	1/2	5/8	2-1/2	932264	
5/8	5/8	3/4	3	932267	
3/4	3/4	1	3	932270	

END MILLS & ROUGHERS

End Mills



Micrograin Solid Carbide – Uncoated & TiAlN-Futura Coated – 4 Flute – Ball Nose



- Suitable for cutting hardened and high alloy steels, steel casting, chill casting, malleable cast iron, CrNi-steels, brass, copper, aluminum with a high percentage of silicon and abrasive plastics

Tolerance: 0/-0.0012

Long Length



Extra Long Length



Cutter Diameter (Inch)	Shank Diameter (Inch)	Length of Cut (Inch)	Overall Length (Inch)	Uncoated		TiAlN-Futura Coated	
				Code		Code	
1/8	1/8	3/4	2-1/4	932670		934600	
3/16	3/16	3/4	2-1/4	932673		934601	
1/4	1/4	1-1/8	3	932676		934907	
5/16	5/16	1-1/8	3	932679		934603	
3/8	3/8	1-1/8	3	932682		934604	
7/16	7/16	2	4	932685		934605	
1/2	1/2	2	4	932688		934606	
5/8	5/8	2-1/4	5	932691		934607	
3/4	3/4	2-1/4	5	932694		934608	
1	1	2-1/4	5	932697		934609	

Cutter Diameter (Inch)	Shank Diameter (Inch)	Length of Cut (Inch)	Overall Length (Inch)	Uncoated	
				Code	
1/8	1/8	1	3	932818	
3/16	3/16	1-1/8	3	932821	
1/4	1/4	1-1/2	4	932824	
5/16	5/16	1-5/8	4	932827	
3/8	3/8	1-3/4	4	932830	
7/16	7/16	3	6	932833	
1/2	1/2	3	6	932836	
5/8	5/8	3	6	932839	
3/4	3/4	3	6	932842	
1	1	3	6	932845	

Roughers

Solid Carbide – Uncoated & TiAlN Coated – 4 Flute – Center Cut



Cutter Diameter (Inch)	Shank Diameter (Inch)	Length of Cut (Inch)	Overall Length (Inch)	Uncoated	TiAlN Coated
				Code	Code
1/4	1/4	3/4	2-1/2	934584	-
5/16	5/16	3/4	2-1/2	934587	934618
3/8	3/8	7/8	2-1/2	934590	934621
1/2	1/2	1	3	934593	-

Cutter Diameter (Inch)	Shank Diameter (Inch)	Length of Cut (Inch)	Overall Length (Inch)	Uncoated	TiAlN Coated
				Code	Code
5/8	5/8	1-1/4	3-1/2	934596	934627
3/4	3/4	1-1/2	4	934599	934630
1	1	1-3/4	4	934602	934633

End Mills

Micrograin Solid Carbide – Uncoated & TiAlN Coated – 2 Flute – Center Cut

TITANIUM ALUMINUM NITRIDE (TiAlN): A titanium based PVD coating having a high content of aluminum. About 30% harder than TiN, this coating provides a unique ability to work well in extremely high temperatures as it has the highest oxidation threshold temperature of any coating available today for solid round tools. TiAlN coated tools run extremely well in dry milling applications, potentially saving the user significant dollars from reduced coolant costs and related environmental issues.

TiAlN coated end mills produce excellent results in:

- Stainless steels
- Hardened materials
- Titanium alloys
- Cast irons
- Dry milling applications
- Applications with interrupted cutting
- High speed machining applications (HSM)

Regular Length



Cutter Diameter (Inch)	Shank Diameter (Inch)	Length of Cut (Inch)	Overall Length (Inch)	Uncoated	TiAlN Coated
				Code	Code
1/32	1/8	5/64	1-1/2	932920	933075
3/64	1/8	7/64	1-1/2	932921	933078
1/16	1/8	3/16	1-1/2	932922	933081
5/64	1/8	3/16	1-1/2	932923	933084
3/32	1/8	3/8	1-1/2	932924	933087
7/64	1/8	3/8	1-1/2	932925	933090
1/8	1/8	1/2	1-1/2	932926	933093
9/64	3/16	1/2	2	932927	933096
5/32	3/16	9/16	2	932928	933099
11/64	3/16	5/8	2	932929	933102
3/16	3/16	5/8	2	932930	933105
13/64	1/4	5/8	2-1/2	932931	933108
7/32	1/4	5/8	2-1/2	932932	933111
15/64	1/4	3/4	2-1/2	932933	933114
1/4	1/4	3/4	2-1/2	932934	933117
17/64	5/16	3/4	2-1/2	932935	933120
9/32	5/16	3/4	2-1/2	932936	933123
19/64	5/16	13/16	2-1/2	932937	933126
5/16	5/16	13/16	2-1/2	932938	933129
21/64	3/8	7/8	2-1/2	932939	933132

Cutter Diameter (Inch)	Shank Diameter (Inch)	Length of Cut (Inch)	Overall Length (Inch)	Uncoated	TiAlN Coated
				Code	Code
11/32	3/8	7/8	2-1/2	932940	933135
23/64	3/8	7/8	2-1/2	932941	933138
3/8	3/8	1	2-1/2	932942	933141
25/64	7/16	1	2-3/4	932943	933144
13/32	7/16	1	2-3/4	932944	933147
27/64	7/16	1	2-3/4	932945	933150
7/16	7/16	1	2-3/4	932946	933153
29/64	1/2	1	3	932947	933156
15/32	1/2	1	3	932948	933159
31/64	1/2	1	3	932949	933162
1/2	1/2	1	3	932950	933165
9/16	9/16	1-1/4	3	932951	933168
5/8	5/8	1-1/4	3-1/2	932952	933171
11/16	3/4	1-1/2	4	932953	933174
3/4	3/4	1-1/2	4	932954	933177
7/8	7/8	1-1/2	4	932955	933180
1	1	1-1/2	4	932956	933183

End Mills

Micrograin Solid Carbide – Uncoated & TiAlN Coated – 2 Flute – Center Cut (continued)

Metric – Regular Length



Stub Length



Cutter Diameter (mm)	Shank Diameter (mm)	Length of Cut (mm)	Overall Length (mm)	Uncoated	
				Code	
1.0	3.0	4.0	38.0	934300	
1.5	3.0	4.5	38.0	934303	
2.0	3.0	6.0	38.0	934306	
2.5	3.0	8.0	38.0	934309	
3.0	3.0	10.0	38.0	934312	
3.5	4.0	12.0	50.0	934315	
4.0	4.0	12.0	50.0	934318	
4.5	5.0	14.0	50.0	934321	
5.0	5.0	15.0	50.0	934324	
6.0	6.0	18.0	63.0	934327	
7.0	8.0	20.0	63.0	934330	
8.0	8.0	20.0	63.0	934333	
9.0	10.0	22.0	63.0	934336	
10.0	10.0	22.0	63.0	934339	
11.0	12.0	25.0	75.0	934342	
12.0	12.0	25.0	75.0	934345	
14.0	14.0	25.0	75.0	934348	
16.0	16.0	32.0	90.0	934351	
18.0	18.0	32.0	100.0	934354	
20.0	20.0	38.0	100.0	934357	
22.0	22.0	38.0	102.0	934360	
25.0	25.0	38.0	100.0	934363	

Cutter Diameter (Inch)	Shank Diameter (Inch)	Length of Cut (Inch)	Overall Length (Inch)	Uncoated	
				Code	
1/32	1/8	5/64	1-1/2	932000	
3/64	1/8	3/32	1-1/2	932003	
1/16	1/8	1/8	1-1/2	932006	
5/64	1/8	5/32	1-1/2	932009	
3/32	1/8	3/16	1-1/2	932012	
7/64	1/8	7/32	1-1/2	932015	
1/8	1/8	1/4	1-1/2	932018	
9/64	3/16	9/32	2	932021	
5/32	3/16	5/16	2	932024	
11/64	3/16	5/16	2	932027	
3/16	3/16	3/8	2	932030	
13/64	1/4	3/8	2	932033	
7/32	1/4	7/16	2	932036	
15/64	1/4	7/16	2	932039	
1/4	1/4	1/2	2	932042	
5/16	5/16	1/2	2	932045	
3/8	3/8	5/8	2	932048	
7/16	7/16	5/8	2-1/2	932051	
1/2	1/2	5/8	2-1/2	932054	
5/8	5/8	3/4	3	932057	
3/4	3/4	1	3	932060	

END MILLS & ROUGHERS

End Mills



Micrograin Solid Carbide – Uncoated & TiAlN-Futura Coated – 2 Flute – Center Cut



- Suitable for cutting hardened and high alloy steels, steel casting, chill casting, malleable cast iron, CrNi-steels, brass, copper, aluminum with a high percentage of silicon and abrasive plastics

Tolerance: 0/-0.0012

Long Length



Extra Long Length



Cutter Diameter (Inch)	Shank Diameter (Inch)	Length of Cut (Inch)	Overall Length (Inch)	Uncoated		TiAlN-Futura Coated	
				Code		Code	
1/8	1/8	3/4	2-1/4	932855		934570	
3/16	3/16	3/4	2-1/4	932858		934571	
1/4	1/4	1-1/8	3	932861		934572	
5/16	5/16	1-1/8	3	932864		934573	
3/8	3/8	1-1/8	3	932867		934574	
7/16	7/16	2	4	932870		934575	
1/2	1/2	2	4	932873		934576	
5/8	5/8	2-1/4	5	932876		934577	
3/4	3/4	2-1/4	5	932879		934578	
1	1	2-1/4	5	932882		934579	

Cutter Diameter (Inch)	Shank Diameter (Inch)	Length of Cut (Inch)	Overall Length (Inch)	Uncoated		TiAlN-Futura Coated	
				Code		Code	
1/8	1/8	1	3	932707		934610	
3/16	3/16	1-1/8	3	932710		934611	
1/4	1/4	1-1/2	4	932713		934908	
5/16	5/16	1-5/8	4	932716		934613	
3/8	3/8	1-3/4	4	932719		934614	
7/16	7/16	3	6	932722		934909	
1/2	1/2	3	6	932725		934616	
5/8	5/8	3	6	932728		934617	
3/4	3/4	3	6	932731		934910	
1	1	3	6	932734		934619	

End Mills

Micrograin Solid Carbide – Uncoated & TiAlN Coated – 2 Flute – Ball Nose

Regular Length



Cutter Diameter (Inch)	Shank Diameter (Inch)	Length of Cut (Inch)	Overall Length (Inch)	Uncoated	TiAlN Coated	Cutter Diameter (Inch)	Shank Diameter (Inch)	Length of Cut (Inch)	Overall Length (Inch)	Uncoated	TiAlN Coated
				Code	Code					Code	Code
1/32	1/8	3/32	1-1/2	933304	933540	5/16	5/16	13/16	2-1/2	933358	933594
3/64	1/8	1/8	1-1/2	933307	933543	21/64	3/8	7/8	2-1/2	933361	933597
1/16	1/8	3/16	1-1/2	933310	933546	11/32	3/8	7/8	2-1/2	933364	933600
5/64	1/8	3/16	1-1/2	933313	933549	23/64	3/8	7/8	2-1/2	933367	933603
3/32	1/8	3/8	1-1/2	933316	933552	3/8	3/8	7/8	2-1/2	933370	933606
7/64	1/8	3/8	1-1/2	933319	933555	25/64	7/16	1	2-3/4	933373	933609
1/8	1/8	1/2	1-1/2	933322	933558	13/32	7/16	1	2-3/4	933376	933612
9/64	3/16	9/16	2	933325	933561	27/64	7/16	1	2-3/4	933379	933615
5/32	3/16	9/16	2	933328	933564	7/16	7/16	1	2-3/4	933382	933618
11/64	3/16	5/8	2	933331	933567	29/64	1/2	1	3	933385	933621
3/16	3/16	5/8	2	933334	933570	15/32	1/2	1	3	933388	933624
13/64	1/4	5/8	2-1/2	933337	933573	31/64	1/2	1	3	933391	933627
7/32	1/4	5/8	2-1/2	933340	933576	1/2	1/2	1	3	933394	933630
15/64	1/4	3/4	2-1/2	933343	933579	9/16	9/16	1-1/4	3	933397	933633
1/4	1/4	3/4	2-1/2	933346	933582	5/8	5/8	1-1/4	3-1/2	933400	933636
17/64	5/16	3/4	2-1/2	933349	933585	11/16	3/4	1-1/2	4	933403	933639
9/32	5/16	3/4	2-1/2	933352	933588	3/4	3/4	1-1/2	4	933406	933642
19/64	5/16	13/16	2-1/2	933355	933591	7/8	7/8	1-1/2	4	933409	933645
						1	1	1-1/2	4	933412	933648

Metric – Regular Length



Cutter Diameter (mm)	Shank Diameter (mm)	Length of Cut (mm)	Overall Length (mm)	Uncoated
				Code
1.0	3.0	4.0	38.0	934446
1.5	3.0	4.5	38.0	934449
2.0	3.0	6.0	38.0	934452
2.5	3.0	8.0	38.0	934455
3.0	3.0	10.0	38.0	934458
3.5	4.0	12.0	50.0	934461
4.0	4.0	12.0	50.0	934464
4.5	5.0	14.0	50.0	934467
5.0	5.0	15.0	50.0	934470
6.0	6.0	18.0	63.0	934473
7.0	8.0	20.0	63.0	934476
8.0	8.0	20.0	63.0	934479
9.0	10.0	22.0	63.0	934482
10.0	10.0	22.0	63.0	934485
11.0	12.0	25.0	75.0	934488
12.0	12.0	25.0	75.0	934491
14.0	14.0	25.0	75.0	934494
16.0	16.0	32.0	90.0	934497
18.0	18.0	32.0	100.0	934500
20.0	20.0	38.0	100.0	934503
22.0	22.0	38.0	102.0	934506
25.0	25.0	38.0	100.0	934509

Stub Length



Cutter Diameter (Inch)	Shank Diameter (Inch)	Length of Cut (Inch)	Overall Length (Inch)	Uncoated
				Code
1/32	1/8	5/64	1-1/2	932140
3/64	1/8	3/32	1-1/2	932143
1/16	1/8	1/8	1-1/2	932146
5/64	1/8	5/32	1-1/2	932149
3/32	1/8	3/16	1-1/2	932152
7/64	1/8	7/32	1-1/2	932155
1/8	1/8	1/4	1-1/2	932158
9/64	3/16	9/32	2	932161
5/32	3/16	5/16	2	932164
11/64	3/16	5/16	2	932167
3/16	3/16	3/8	2	932170
13/64	1/4	3/8	2	932173
7/32	1/4	7/16	2	932176
15/64	1/4	7/16	2	932179
1/4	1/4	1/2	2	932182
5/16	5/16	1/2	2	932185
3/8	3/8	5/8	2	932188
7/16	7/16	5/8	2-1/2	932191
1/2	1/2	5/8	2-1/2	932194
5/8	5/8	3/4	3	932197
3/4	3/4	1	3	932200

End Mills



Micrograin Solid Carbide – Uncoated & TiAlN-Futura Coated – 2 Flute – Ball Nose



- Suitable for cutting hardened and high alloy steels, steel casting, chill casting, malleable cast iron, CrNi-steels, brass, copper, aluminum with a high percentage of silicon and abrasive plastics

Tolerance: 0/-0.0012

Long Length



Extra Long Length



Cutter Diameter (Inch)	Shank Diameter (Inch)	Length of Cut (Inch)	Overall Length (Inch)	Uncoated	TiAlN-Futura Coated
				Code	Code
1/8	1/8	3/4	2-1/4	932633	934903
3/16	3/16	3/4	2-1/4	932636	934591
1/4	1/4	1-1/8	3	932639	934592
5/16	5/16	1-1/8	3	932642	-
3/8	3/8	1-1/8	3	932645	934594
7/16	7/16	2	4	932648	934595
1/2	1/2	2	4	932651	934905
5/8	5/8	2-1/4	5	932654	934597
3/4	3/4	2-1/4	5	932657	934598
1	1	2-1/4	5	932660	934906

Cutter Diameter (Inch)	Shank Diameter (Inch)	Length of Cut (Inch)	Overall Length (Inch)	Uncoated	TiAlN-Futura Coated
				Code	Code
1/8	1/8	1	3	932781	934914
3/16	3/16	1-1/8	3	932784	934631
3/16	3/16	1	4	-	935426
1/4	1/4	1-1/2	4	932787	934632
1/4	1/4	1-1/2	6	-	935417
5/16	5/16	1-5/8	4	932790	934915
3/8	3/8	1-3/4	4	932793	934634
3/8	3/8	1-1/2	6	-	935420
7/16	7/16	3	6	932796	934635
1/2	1/2	1-1/2	6	-	935423
1/2	1/2	3	6	932799	934636
5/8	5/8	3	6	932802	934637
3/4	3/4	3	6	932805	934638
1	1	3	6	932808	934639

End Mills



Micrograin Solid Carbide – Uncoated & TiAlN-Futura Coated – 3 & 5 Flute – 45° Helix



Up to 5/16" 3/8" to 1"

Tolerance: 0/-0.0012

3 Flute – Regular Length



5 Flute – Regular Length



- Designed to machine stainless steel, inconel, titanium and other hard to machine materials
- The 3 flute design gives high stability and allows good chip removal in plunging and slotting operations
- The normal rake angle and 45° medium helix allows an extremely wide range of application

- Designed to machine stainless steels, inconels, and other alloys
- 5 flute and 45° medium helix allow harmonic balance and smooth cutting

Cutter Diameter (Inch)	Shank Diameter (Inch)	Shank Style	Length of Cut (Inch)	Overall Length (Inch)	Uncoated	TiAlN-Futura Coated
					Code	Code
1/8	1/8	Plain	3/8	1-1/2	935237	935864
3/16	3/16	Plain	9/16	2	935240	935867
1/4	1/4	Plain	3/4	2-1/2	935243	935870
5/16	5/16	Plain	13/16	2-1/2	935246	935873
3/8	3/8	Weldon	7/8	2-1/2	935249	935876
1/2	1/2	Weldon	1	3	935252	935879
9/16	9/16	Weldon	1-1/4	3-1/2	935255	935882
5/8	5/8	Weldon	1-1/4	3-1/2	935258	935885
3/4	3/4	Weldon	1-1/2	4	935261	935888
1	1	Weldon	1-1/2	4	935264	935891

Cutter Diameter (Inch)	Shank Diameter (Inch)	Shank Style	Length of Cut (Inch)	Overall Length (Inch)	Uncoated	TiAlN-Futura Coated
					Code	Code
1/8	1/8	Plain	1/2	1-1/2	935081	935708
5/32	3/16	Plain	9/16	2	935084	935711
3/16	3/16	Plain	9/16	2	935087	935714
7/32	1/4	Plain	3/4	2-1/2	935090	935717
1/4	1/4	Plain	3/4	2-1/2	935093	935720
5/16	5/16	Plain	13/16	2-1/2	935096	935723
3/8	3/8	Plain	1	2-1/2	935099	935726
7/16	7/16	Plain	1	2-3/4	935102	935729
1/2	1/2	Plain	1-1/4	3	935105	935732
5/8	5/8	Plain	1-5/8	3-1/2	935108	935735
3/4	3/4	Plain	1-5/8	4	935111	935738
7/8	7/8	Plain	2	4	935114	935741
1	1	Plain	2	4	935117	935744

END MILLS & ROUGHERS

Carbide End Mills – General Purpose

Speeds, Feeds & Technical Information – Uncoated & TiAlN Coated

Speeds & Feeds

Material	Inch							Metric						
	Speed (SFM)		Feed (Inches per Tooth)					Speed (SFM)		Feed (Inches per Tooth)				
	Uncoated	TiAlN	1/8	1/4	1/2	3/4	1	Uncoated	TiAlN	3.0	6.0	12.0	19.0	25.0
Aluminum	300-400	500-600	.0007	.0020	.0040	.0060	.0080	91-122	152-183	.0178	.0508	.1016	.1524	.2032
Aluminum Alloys	300-400	500-600	.0007	.0020	.0040	.0060	.0080	91-122	152-183	.0178	.0508	.1016	.1524	.2032
Brass and Bronze	225-275	400-600	.0010	.0020	.0030	.0040	.0050	69-84	122-183	.0254	.0508	.0762	.1016	.1270
Copper	275-350	350-450	.0010	.0010	.0020	.0040	.0060	84-107	107-137	.0254	.0254	.0508	.1016	.1524
Copper Alloys	275-350	350-450	.0010	.0010	.0020	.0040	.0060	84-107	107-137	.0254	.0254	.0508	.1016	.1524
Graphite	350-500	600-1000	.0015	.0025	.0035	.0050	.0070	107-152	183-305	.0381	.0635	.0889	.1270	.1778
Plastics	400-500	600-900	.0015	.0030	.0060	.0100	.0150	122-152	183-274	.0381	.0762	.1524	.2540	.3810
Magnesium	350-500	600-1000	.0010	.0020	.0040	.0060	.0100	107-152	183-305	.0254	.0508	.1016	.1524	.2540
Magnesium Alloys	350-500	600-1000	.0010	.0020	.0040	.0060	.0100	107-152	183-305	.0254	.0508	.1016	.1524	.2540
Cast Iron Grey	200-200	400-500	.0010	.0020	.0030	.0045	.0060	61-91	122-152	.0254	.0508	.0762	.1143	.1524
Cast Iron Ductile	200-250	275-400	.0004	.0008	.0020	.0035	.0045	61-76	84-122	.0102	.0203	.0508	.0889	.1143
Cast Iron Malleable	150-225	275-350	.0003	.0005	.0015	.0025	.0035	46-69	84-107	.0076	.0127	.0381	.0635	.0889
Steel-Low Carbon	225-275	275-400	.0010	.0020	.0030	.0045	.0060	69-84	84-122	.0254	.0508	.0762	.1143	.1524
Steel-Medium Carbon	175-225	250-325	.0006	.0012	.0025	.0040	.0050	53-69	76-99	.0152	.0305	.0635	.1016	.1270
Tool Steels (<38 RC)	175-225	250-325	.0006	.0012	.0025	.0040	.0050	53-69	76-99	.0152	.0305	.0635	.1016	.1270
Tool Steels (38-50 RC)	100-150	200-300	.0004	.0008	.0020	.0030	.0040	30-46	61-99	.0102	.0203	.0508	.0762	.1016
Tool Steels (>50 RC)	25-50	35-70	.0003	.0006	.0015	.0020	.0030	7-15	11-21	.0076	.0152	.0381	.0508	.0762
Stainless Steel 300 series	150-250	225-325	.0003	.0010	.0020	.0035	.0045	46-76	69-99	.0076	.0254	.0508	.0889	.1143
Stainless Steel 400 series	125-225	225-300	.0004	.0008	.0015	.0025	.0030	38-69	69-91	.0102	.0203	.0381	.0635	.0762
Stainless Steel PH series	60-90	100-225	.0003	.0007	.0015	.0025	.0030	18-27	30-69	.0076	.0178	.0381	.0635	.0762
Titanium	50-90	150-200	.0003	.0007	.0015	.0020	.0030	15-27	46-61	.0076	.0178	.0381	.0508	.0762
High Temp Alloys	25-50	50-80	.0002	.0005	.0008	.0013	.0016	7-15	15-24	.0051	.0127	.0203	.0330	.0406

NOTE: Speeds listed are starting parameters

General Recommendations for Speeds & Feeds

Lower Speeds are used for...	Higher Speeds are used for...	Less Feed is used for...	More Feed is used for...
Hard Materials	Soft Materials	Frail cutters	Lighter cuts
Abrasive Materials	Better Finishes	Better finishes	Abrasive materials
Sandy Castings	Small diameter cutters	Deep slotting cuts	Scaly surface conditions
Heavy Cuts	lighter cuts	Long chip materials	Excessive land wear
High Nickel Content	frail setups	Cutting edge chipping	Chatter problems
Excessive land wear	excessive chipping		Easy to machine materials

Troubleshooting

Condition	Causes	Solution
Tool deflection or uneven widths of cut	Tool size	Always select the largest diameter possible for the cut to be made
Poor surface finish	Number of flutes on tool Rigidity of setup Depth of cut	Increase the number of flutes Make a secure and rigid setup Take a lighter cut at a higher speed
Tool breakage	Setup Loose or worn toolholders Tool extension	End Mills should be mounted as true to the spindle as possible Replace loose or worn toolholders Keep overhang to a minimum
Tool Life	Heat End mill style Improper speeds and feeds	Use a coated tool Use tooling designed for specific materials and applications Increase the number of flutes Lighten the chip load Use proper speeds and feeds for tool style and material



End Mills

Cobalt M42 – 4 Flute – Center Cut – Weldon Shanks



Tolerance: +0.0010/0

Regular Length – Inch

Cutter Diameter (Inch)	Shank Diameter (Inch)	Length of Cut (Inch)	Overall Length (Inch)	Code
1/8	3/8	3/8	2-5/16	930260
5/32	3/8	1/2	2-3/8	930265
3/16	3/8	1/2	2-3/8	930270
7/32	3/8	5/8	2-7/16	930275
1/4	3/8	5/8	2-7/16	930280
9/32	3/8	3/4	2-1/2	930285
5/16	3/8	3/4	2-1/2	930290
11/32	3/8	3/4	2-1/2	930295
3/8	3/8	3/4	2-1/2	930300
13/32	3/8	1	2-11/16	930305
7/16	3/8	1	2-11/16	930310
15/32	3/8	1	2-11/16	930311
1/2	1/2	1-1/4	3-1/4	930315
9/16	1/2	1-3/8	3-3/8	930320
5/8	5/8	1-5/8	3-3/4	930325
11/16	5/8	1-5/8	3-3/4	930326
3/4	3/4	1-5/8	3-7/8	930330
13/16	3/4	1-7/8	4-1/8	930331
7/8	3/4	1-7/8	4-1/8	930335
7/8	7/8	1-7/8	4-1/8	930340
15/16	3/4	1-7/8	4-1/8	930341
1	3/4	1-7/8	4-1/8	930345
1	1	2	4-1/2	930350
1-1/8	1	2	4-1/2	930355

Regular Length – Metric

- Standard regular length in metric diameter
- End mills with center cutting are recommended for a wide range of cutting jobs, including slotting, shallow pocketing and tracer milling

Cutter Diameter (mm)	Shank Diameter (Inch)	Length of Cut (Inch)	Overall Length (Inch)	Code
12.5	1/2	1-1/4	3-1/4	931826
36	1	2	4-1/2	931828
40	1-1/4	2	4-1/2	931830
45	1-1/4	2	4-1/2	931832

Tolerance: k10

Cutter Diameter (mm)	Shank Diameter (mm)	Length of Cut (mm)	Overall Length (mm)	Code
2.0	6.0	7.0	51.0	931300
2.5	6.0	8.0	52.0	931301
3.0	6.0	8.0	52.0	931302
3.5	6.0	10.0	54.0	931303
4.0	6.0	11.0	55.0	931304
4.5	6.0	11.0	55.0	931305
5.0	6.0	13.0	57.0	931306
5.5	6.0	13.0	57.0	931307
6.0	6.0	13.0	57.0	931308
6.5	10.0	16.0	66.0	931309
7.0	10.0	16.0	66.0	931310
7.5	10.0	16.0	69.0	931311
8.0	10.0	19.0	69.0	931312
8.5	10.0	19.0	69.0	931313
9.0	10.0	19.0	69.0	931314
9.5	10.0	19.0	69.0	931315
10.0	10.0	22.0	72.0	931316
11.0	12.0	22.0	79.0	931317
12.0	12.0	26.0	83.0	931318
13.0	12.0	26.0	83.0	931319
14.0	12.0	26.0	83.0	931320
15.0	12.0	26.0	83.0	931321
16.0	16.0	32.0	92.0	931322
17.0	16.0	32.0	92.0	931323
18.0	16.0	32.0	92.0	931324
19.0	16.0	32.0	92.0	931325
20.0	20.0	38.0	104.0	931326

Long Length – Inch



Cutter Diameter (Inch)	Shank Diameter (Inch)	Length of Cut (Inch)	Overall Length (Inch)	Code
1/4	3/8	1-1/4	3-1/16	930375
5/16	3/8	1-3/8	3-1/8	930380
3/8	3/8	1-1/2	3-1/4	930385
7/16	1/2	1-3/4	3-3/4	930386
1/2	1/2	2	4	930390
5/8	5/8	2-1/2	4-5/8	930395
3/4	3/4	3	5-1/4	930400
7/8	7/8	3-1/2	5-3/4	930405
1	1	4	6-1/2	930410

Extra Long Length – Inch



Cutter Diameter (Inch)	Shank Diameter (Inch)	Length of Cut (Inch)	Overall Length (Inch)	Code
1/4	3/8	1-3/4	3-9/16	930420
3/8	3/8	2-1/2	4-1/4	930425
1/2	1/2	3	5	930430
5/8	5/8	4	6-1/8	930435
3/4	3/4	4	6-1/4	930440
1	1	6	8-1/2	930445
1-1/4	1-1/4	6	8-1/2	930450

END MILLS & ROUGHERS

End Mills



Cobalt M42 – Ball Nose – Weldon Shanks

4 Flute – Regular Length



2 Flute – Regular Length



Tolerance: +0.0010/0

Cutter Diameter (Inch)	Shank Diameter (Inch)	Length of Cut (Inch)	Overall Length (Inch)	Code
1/8	3/8	3/8	2-5/16	930455
3/16	3/8	1/2	2-3/8	930460
1/4	3/8	5/8	2-7/16	930465
5/16	3/8	3/4	2-1/2	930470
3/8	3/8	3/4	2-1/2	930475
1/2	1/2	1-1/4	3-1/4	930480
5/8	5/8	1-5/8	3-3/4	930485
3/4	3/4	1-5/8	3-7/8	930490
1	1	2	4-1/2	930495

- Designed for milling of radius bottom slots, fillets and special contours
- The end teeth are cut to center allowing these end mills to drill into material at the beginning of a slotting cut
- 2 flute design provides good chip removal ability in slotting

Cutter Diameter (Inch)	Shank Diameter (Inch)	Length of Cut (Inch)	Overall Length (Inch)	Code
1/8	3/8	3/8	2-5/16	930180
3/16	3/8	1/2	2-3/8	930185
1/4	3/8	5/8	2-7/16	930190
5/16	3/8	3/4	2-1/2	930195
3/8	3/8	3/4	2-1/2	930200
7/16	1/2	1	3	931668
1/2	1/2	1	3	930205
9/16	1/2	1-1/8	3-1/8	931670
5/8	1/2	1-1/8	3-1/8	931684
5/8	5/8	1-3/8	3-3/8	930210
3/4	1/2	1-5/16	3-5/16	931686
3/4	3/4	1-5/8	3-7/8	930215
7/8	3/4	2	4-1/4	931696
7/8	7/8	2	4-1/4	931672
1	3/4	2-1/4	4-1/2	931698
1	1	2-1/4	4-3/4	930220
1-1/8	3/4	1-5/8	3-7/8	931688
1-1/8	1	2-1/4	4-3/4	931674
1-1/4	3/4	1-5/8	3-7/8	931690
1-1/4	1-1/4	2-1/2	5	931676
1-3/8	3/4	1-5/8	4-1/8	931692
1-3/8	1-1/4	2-1/2	5	931678
1-1/2	3/4	1-5/8	4-1/8	931694
1-1/2	1-1/4	2-1/2	5	931680
2	1-1/4	2-1/2	5	931682

4 Flute – Long Length



Tolerance: +0.0010/0

- Longer flute length suitable for high efficient copying process and deep cutting of die mold corner radius

Cutter Diameter (Inch)	Shank Diameter (Inch)	Length of Cut (Inch)	Overall Length (Inch)	Code
1/4	3/8	1-1/4	3-1/16	931600
5/16	3/8	1-3/8	3-1/8	931602
3/8	3/8	1-1/2	3-1/4	931604
1/2	1/2	2	4	931606
5/8	5/8	2-1/2	4-5/8	931608
3/4	3/4	3	5-1/4	931610
7/8	7/8	3-1/2	5-3/4	931612
1	1	4	6-1/2	931614

End Mills

Cobalt M42 – 2 Flute – 3 Inch Cutting Length – Center Cut – Weldon Shanks



Cutter Diameter (Inch)	Shank Diameter (Inch)	Length of Cut (Inch)	Overall Length (Inch)	Code
1/2	1/2	3	5	930155
5/8	5/8	3	5-1/8	930160
3/4	3/4	3	5-1/4	930165
1	1	3	5-1/2	930170
1-1/4	1-1/4	3	5-1/2	930175
1-3/8	1	3	5-1/2	930176

Cutter Diameter (Inch)	Shank Diameter (Inch)	Length of Cut (Inch)	Overall Length (Inch)	Code
1-1/2	1-1/4	3	5-1/2	930177
1-5/8	1-1/4	3	5-1/2	930178
1-3/4	1-1/4	3	5-1/2	930179
1-7/8	1-1/4	3	5-1/2	930173
2	1-1/4	3	5-1/2	930174



End Mills

Cobalt M42 – 2 Flute – Center Cut – Weldon Shanks



Regular Length – Inch

Regular Length – Metric

Cutting Tolerance: e8

Cutter Diameter (Inch)	Shank Diameter (Inch)	Length of Cut (Inch)	Overall Length (Inch)	Code
1/8	3/8	3/8	2-5/16	930000
5/32	3/8	7/16	2-5/16	930005
3/16	3/8	7/16	2-5/16	930010
7/32	3/8	1/2	2-5/16	930015
1/4	3/8	1/2	2-5/16	930020
9/32	3/8	9/16	2-5/16	930025
5/16	3/8	9/16	2-5/16	930030
11/32	3/8	9/16	2-5/16	930035
3/8	3/8	9/16	2-5/16	930040
13/32	3/8	13/16	2-1/2	930045
7/16	3/8	13/16	2-1/2	930050
15/32	3/8	13/16	2-1/2	930051
1/2	1/2	1	3	930055
9/16	1/2	1-1/8	3-1/8	930060
5/8	5/8	1-5/16	3-7/16	930065
11/16	5/8	1-5/16	3-7/16	930070
3/4	3/4	1-5/16	3-9/16	930075
13/16	3/4	1-1/2	3-3/4	930080
7/8	3/4	1-1/2	3-3/4	930085
7/8	7/8	1-1/2	3-3/4	930090
15/16	3/4	1-1/2	3-3/4	930091
1	3/4	1-1/2	3-3/4	930095
1	1	1-5/8	4-1/8	930100
1-1/16	3/4	1-5/8	3-7/8	930101
1-1/8	1	1-5/8	4-1/8	930102
1-3/16	3/4	1-5/8	3-7/8	930103
1-1/4	1-1/4	1-5/8	4-1/8	930105
1-5/16	3/4	1-5/8	3-7/8	930106
1-3/8	1	1-5/8	4-1/8	930107
1-1/2	1-1/4	1-5/8	4-1/8	930110
1-5/8	1-1/4	1-5/8	4-1/8	930111
1-3/4	1-1/4	1-5/8	4-1/8	930112
1-7/8	1-1/4	1-5/8	4-1/8	930113
2	1-1/4	1-5/8	4-1/8	930115

Cutter Diameter (mm)	Shank Diameter (mm)	Length of Cut (mm)	Overall Length (mm)	Code
2.0	6.0	4.0	48.0	931250
2.5	6.0	5.0	49.0	931251
3.0	6.0	5.0	49.0	931252
3.5	6.0	6.0	50.0	931253
4.0	6.0	7.0	51.0	931254
4.5	6.0	7.0	51.0	931255
5.0	6.0	8.0	52.0	931256
5.5	6.0	8.0	52.0	931257
6.0	6.0	8.0	52.0	931258
6.5	10.0	10.0	60.0	931259
7.0	10.0	10.0	60.0	931260
7.5	10.0	10.0	60.0	931261
8.0	10.0	11.0	61.0	931262
8.5	10.0	11.0	61.0	931263
9.0	10.0	11.0	61.0	931264
9.5	10.0	11.0	61.0	931265
10.0	10.0	13.0	63.0	931266
11.0	12.0	13.0	70.0	931267
12.0	12.0	16.0	73.0	931268
13.0	12.0	16.0	73.0	931269
14.0	12.0	16.0	73.0	931270
15.0	12.0	16.0	73.0	931271
16.0	16.0	19.0	79.0	931272
17.0	16.0	19.0	79.0	931273
18.0	16.0	19.0	79.0	931274
19.0	16.0	19.0	79.0	931275
20.0	20.0	22.0	88.0	931276
22.0	20.0	22.0	88.0	931277
24.0	25.0	26.0	102.0	931278
25.0	25.0	26.0	102.0	931279
28.0	25.0	26.0	102.0	931280
30.0	25.0	26.0	102.0	931281
32.0	32.0	32.0	112.0	931282
*36.0	1"	50.0	112.0	931820
*40.0	1-1/4"	50.0	112.0	931822
*45.0	1-1/4"	32.0	112.0	931824

*Inch shank

Long Length



Extended Length



Tolerance: +0.0010/0

- Provided with the longest flute length and suitable for high accuracy machining of deep step

Cutter Diameter (Inch)	Shank Diameter (Inch)	Length of Cut (Inch)	Overall Length (Inch)	Code
1/4	3/8	1-1/4	3-1/8	930120
5/16	3/8	1-1/2	3-1/4	930125
3/8	3/8	1-1/2	3-1/4	930130
1/2	1/2	2	4	930135
5/8	5/8	2	4-1/8	930140
3/4	3/4	2-1/4	4-1/2	930145

Cutter Diameter (Inch)	Shank Diameter (Inch)	Length of Cut (Inch)	Overall Length (Inch)	Code
1/4	3/8	5/8	3-1/16	931700
5/16	3/8	3/4	3-5/16	931702
3/8	3/8	3/4	3-5/16	931704
1/2	1/2	1	4	931706
5/8	5/8	1-3/8	4-5/8	931708
3/4	3/4	1-5/8	5-3/8	931710

END MILLS & ROUGHERS



Throw Away Cutters

Cobalt M42 – 3 Flute – Center Cut – Weldon Shanks



Stub Length



Long Length



Cutter Diameter (Inch)	Shank Diameter (Inch)	Length of Cut (Inch)	Overall Length (Inch)	Code
1/16	1/4	3/32	31/32	313164
3/32	1/4	5/32	1-1/64	313165
1/8	1/4	3/16	1-3/32	313166
5/32	1/4	1/4	1-9/32	313167
3/16	1/4	9/32	1-11/32	313168
7/32	1/4	5/16	1-13/32	313169
1/4	1/4	3/8	1-13/32	313170

Cutter Diameter (Inch)	Shank Diameter (Inch)	Length of Cut (Inch)	Overall Length (Inch)	Code
1/16	1/4	5/32	1-3/32	313171
3/32	1/4	1/4	1-1/4	313172
1/8	1/4	5/16	1-11/32	313173
5/32	1/4	3/8	1-17/32	313174
3/16	1/4	7/16	1-21/32	313175
7/32	1/4	1/2	1-3/4	313176
1/4	1/4	5/8	1-3/4	313177

End Mills

Cobalt M42 – 6 Flute – Center Cut – Weldon Shanks

Regular Length – Inch



Long Length – Inch



Cutter Diameter (Inch)	Shank Diameter (Inch)	Length of Cut (Inch)	Overall Length (Inch)	Code
1-1/16	3/4	1-1/2	3-7/8	930351
1-3/16	3/4	2	4-1/4	930356
1-1/4	1-1/4	2	4-1/2	930360
1-5/16	3/4	2	4-3/8	930361
1-3/8	1	2	4-1/2	930362
1-1/2	1-1/4	2	4-1/2	930365
1-5/8	1-1/4	2	4-1/2	930366
1-3/4	1-1/4	2	4-1/2	930367
1-7/8	1-1/4	2	4-3/8	930368
2	1-1/4	2	4-1/2	930370

Cutter Diameter (Inch)	Shank Diameter (Inch)	Length of Cut (Inch)	Overall Length (Inch)	Code
1-1/16	3/4	2	4-1/4	930411
1-1/8	1	4	6-1/2	930412
1-3/4	1-1/4	4	6-1/2	930417

END MILLS & ROUGHERS



End Mills

Cobalt M42 – 6 Flute – Center Cut – Weldon Shanks



Regular Length – Metric



Cutting Tolerance: k10

Cutter Diameter (mm)	Shank Diameter (mm)	Length of Cut (mm)	Overall Length (mm)	Code
22.0	20.0	38.0	104.0	931327
24.0	25.0	45.0	121.0	931328
25.0	25.0	45.0	121.0	931329
28.0	25.0	45.0	121.0	931331
30.0	25.0	45.0	121.0	931332
32.0	32.0	53.0	133.0	931333

Long Length – Inch



Tolerance: +0.0010/0

- Longer flute length allows deeper cutting

Cutter Diameter (Inch)	Shank Diameter (Inch)	Length of Cut (Inch)	Overall Length (Inch)	Code
1/2	1/2	2	4	931740
5/8	5/8	2-1/2	4-5/8	931742
3/4	3/4	3	5-1/4	931744
7/8	7/8	3-1/2	5-3/4	931746
1	1	4	6-1/2	931748
1-1/4	1-1/4	4	6-1/2	930415
1-1/2	1-1/4	4	6-1/2	930416
2	1-1/4	4	6-1/2	931756
2	2	4	7-3/4	931754
2	2	6	9-3/4	931758

Extra Long Length – Inch



Tolerance: +0.0010/0

- Longest flute length suitable for high accuracy machining of deep step

Cutter Diameter (Inch)	Shank Diameter (Inch)	Length of Cut (Inch)	Overall Length (Inch)	Code
1/2	1/2	3	5	931782
5/8	5/8	4	6-1/8	931784
3/4	3/4	4	6-1/4	931786
7/8	7/8	5	7-1/4	931788
1	1	6	8-1/2	931790
1-1/2	1-1/4	8	10-1/2	931792
2	2	8	11-3/4	931794

END MILLS & ROUGHERS



Roughers

Cobalt M42 – Coarse Pitch – Non-Center Cut – Weldon Shanks

Regular Length – Uncoated & TiAlN Futura Coated



Cutter Diameter (Inch)	Shank Diameter (Inch)	Length of Cut (Inch)	Overall Length (Inch)	No. of Flutes	Cobalt	TiAlN-Futura Coated
					Code	Code
1/4	3/8	5/8	2-7/16	3	930530	930531
5/16	3/8	3/4	2-1/2	3	930535	930536
3/8	3/8	3/4	2-1/2	4	930540	930541
7/16	3/8	1	2-11/16	4	930545	930546
1/2	1/2	1-1/4	3-1/4	4	930550	930551
9/16	1/2	1-3/8	3-3/8	4	930555	930556
5/8	5/8	1-5/8	3-3/4	4	930560	930561
11/16	5/8	1-5/8	3-3/4	4	930565	930566
3/4	3/4	1-5/8	3-3/4	4	930570	930571
7/8	3/4	1-7/8	4-1/8	5	930575	930576
1	1	2	4-1/2	5	930580	930581
1-1/8	1	2	4-1/2	6	930585	930586
1-1/4	1-1/4	2	4-1/2	6	930590	930591
1-1/2	1-1/4	2	4-1/2	6	930595	930596
1-3/4	1-1/4	2	4-1/2	6	930597	-
2	1-1/4	2	4-1/2	8	930600	930601
2	2	2	5-3/4	8	930605	930606
2	2	3	6-3/4	8	930610	930611
2	2	4	7-3/4	8	930615	930616

Cobalt M42 – Fine Pitch – Non-Center Cut – Weldon Shanks

Regular Length – Uncoated & TiAlN Futura Coated



Cutter Diameter (Inch)	Shank Diameter (Inch)	Length of Cut (Inch)	Overall Length (Inch)	No. of Flutes	Cobalt	TiAlN-Futura Coated
					Code	Code
1/4	3/8	5/8	2-7/16	3	930620	930621
5/16	3/8	3/4	2-1/2	3	930625	930626
3/8	3/8	3/4	2-1/2	4	930630	930631
7/16	3/8	1	2-11/16	4	930635	930636
1/2	1/2	1-1/4	3-1/4	4	930640	930641
5/8	5/8	1-5/8	3-3/4	4	930645	930646
3/4	3/4	1-5/8	3-3/4	4	930650	930651
7/8	3/4	1-7/8	4-1/8	5	930653	-
1	1	2	4-1/2	5	930655	930656
1-1/8	1	2	4-1/2	6	930658	-
1-1/4	1-1/4	2	4-1/2	6	930660	930661
1-1/2	1-1/4	2	4-1/2	6	930665	930666
2	1-1/4	2	4-1/2	8	930670	930671

Roughers

Cobalt M42 – Coarse Pitch – Non-Center Cut – Weldon Shanks

Long & Extra Long Length – Uncoated & TiAlN Coated



Cutter Diameter (Inch)	Shank Diameter (Inch)	Length of Cut (Inch)	Overall Length (Inch)	No. of Flutes	Cobalt	TiAlN Coated
					Code	Code
1/4	3/8	1-3/8	3-1/8	3	930687	-
5/16	3/8	1-3/8	3-1/8	3	930688	-
3/8	3/8	1-5/8	3-3/16	4	930689	-
1/2	1/2	2	4	4	930690	930691
1/2	1/2	3	5	4	930695	930696
5/8	5/8	2-1/2	4-5/8	4	930700	930701
5/8	5/8	3-1/8	5-1/4	4	930705	930706
3/4	3/4	3	5-1/4	4	930710	930711
7/8	7/8	3-1/2	5-5/8	5	930715	930716
1	1	4	6-1/2	5	930720	930721
1	1	6	8-1/2	5	930725	930726
1-1/4	1-1/4	4	6-1/2	6	930735	930731
1-1/4	1-1/4	6	8-1/2	6	-	930736
1-1/2	1-1/4	4	6-1/2	6	930740	930741
1-3/4	1-1/4	4	6-1/2	6	930742	-
2	1-1/4	4	6-1/2	8	930745	930746
2	2	8	11-3/4	8	930750	930751

Cobalt M42 – Fine Pitch – Non-Center Cut – Weldon Shanks

Long & Extra Long Length – Uncoated & TiAlN Coated



Cutter Diameter (Inch)	Shank Diameter (Inch)	Length of Cut (Inch)	Overall Length (Inch)	No. of Flutes	Cobalt	TiAlN-Futura Coated
					Code	Code
5/16	3/8	1-3/8	3-1/8	3	930753	-
3/8	3/8	1-5/8	3-3/16	4	930754	-
1/2	1/2	2	4	4	930755	930756
5/8	5/8	2-1/2	4-5/8	4	930780	930781
3/4	3/4	3	5-1/4	4	930805	930806
7/8	7/8	3-1/2	5-5/8	5	930830	930831
1	1	4	6-1/2	5	930835	930836
1-1/4	1-1/4	4	6-1/2	6	930840	930841
1-1/2	1-1/4	4	6-1/2	6	930845	930846

Roughers



Cobalt M42 – For Aluminum – Coarse Pitch – Center Cut – 37° Helix – Weldon Shanks

3 Flute – Regular Length



3 Flute – Long Length



Cutter Diameter (Inch)	Shank Diameter (Inch)	Length of Cut (Inch)	Overall Length (Inch)	Code
1/4	3/8	5/8	2-7/16	930955
5/16	3/8	3/4	2-1/2	930960
3/8	3/8	3/4	2-1/2	930965
1/2	1/2	1-1/4	3-1/4	930970
5/8	5/8	1-5/8	3-3/4	930975
3/4	3/4	1-5/8	3-7/8	930980
1	1	2	4-1/2	930985
1-1/4	1-1/4	2	4-1/2	930990

Cutter Diameter (Inch)	Shank Diameter (Inch)	Length of Cut (Inch)	Overall Length (Inch)	Code
1/2	1/2	2	4	930995
5/8	5/8	2-1/2	4-5/8	931000
3/4	3/4	3	5-1/4	931005
1	1	4	6-1/2	931010
1-1/4	1-1/4	4	6-1/2	931015
1-1/2	1-1/4	4	6-1/2	931020

Finishers



Cobalt M42 – For Aluminum – Center Cut – 45° Hi-Helix – Weldon Shanks

3 Flute – Regular Length



Cutter Diameter (Inch)	Shank Diameter (Inch)	Length of Cut (Inch)	Overall Length (Inch)	Code
1/4	3/8	5/8	2-7/16	931145
5/16	3/8	3/4	2-1/2	931150
3/8	3/8	3/4	2-1/2	931155
1/2	1/2	1-1/4	3-1/4	931160
5/8	5/8	1-5/8	3-3/4	931165
3/4	3/4	1-5/8	3-7/8	931170
1	1	2	4-1/2	931180

Roughers



Cobalt M42 – Coarse Pitch – Center Cut – Weldon Shanks

Regular Length – Uncoated & TiAlN-Futura Coated



Cutter Diameter (Inch)	Shank Diameter (Inch)	Length of Cut (Inch)	Overall Length (Inch)	No. of Flutes	Cobalt	TiAlN-Futura Coated
					Code	Code
1/2	1/2	1-1/4	3-1/4	4	930850	930851
5/8	5/8	1-5/8	3-3/4	4	930855	930856
3/4	3/4	1-5/8	3-3/4	4	930860	930861
1	1	2	4-1/2	5	930865	930866
1-1/4	1-1/4	2	4-1/2	6	930870	930871
1-1/2	1-1/4	2	4-1/2	6	930875	930876

Roughers

Cobalt M42 – Coarse Pitch – Center Cut – Weldon Shanks

Long Length – Uncoated & TiAlN Coated



Cutter Diameter (Inch)	Shank Diameter (Inch)	Length of Cut (Inch)	Overall Length (Inch)	No. of Flutes	Cobalt	TiAlN Coated
					Code	Code
1/2	1/2	2	4	4	930880	930881
5/8	5/8	2-1/2	4-5/8	4	930885	930886
3/4	3/4	3	5-1/4	4	930890	930892
7/8	3/4	3-1/2	5-5/8	5	930891	930893
1	1	4	6-1/2	5	930895	930896

Roughers



Regular Length – Fine & Coarse Pitch – Center Cut – Weldon Shanks – PMX-TiAlN Coated



Cutter Diameter (Inch)	Shank Diameter (Inch)	Length of Cut (Inch)	Overall Length (Inch)	No. of Flutes	PMX-TiAlN Coarse Pitch	PMX-TiAlN Fine Pitch
					Code	Code
1/4	3/8	5/8	2-7/16	3	931065	931025
5/16	3/8	3/4	2-1/2	3	931070	931030
3/8	3/8	3/4	2-1/2	4	931075	931035
1/2	1/2	1-1/4	3-1/4	4	931080	931040
5/8	5/8	1-5/8	3-3/4	4	931085	931045
3/4	3/4	1-5/8	3-3/4	4	931090	931050
1	1	2	4-1/2	5	931095	931055
1-1/4	1-1/4	2	4-1/2	6	931100	931060

PMX = Powdered Metal

PMX-TiAlN End Mills

Work Conditions for Longer End Mill Life

Machining Material			Application Group			Conditions		
Denomination	Tensile Strength N/mm ²		N 7600 N Flutes	NR-F 7644 N Flutes	NR 7640 N Flutes	V _C +TiAlN (SFM)	Feed material group	Cooling E = Emulsion O = Oil D = Dry
	From	To						
Easy Machining Steel	370	660	●	○	●	180/279	1	E
	550	1000	●	●	○	148/246	2/3	E
General Construction Steel	-	600	●	○	●	180/246	2	E
	500	900	●	○	●	148/213	3	E
Unalloyed Case Hardening Steel	-	600	●	○	●	180/246	2	E
Alloyed Case Hardening Steel	500	800	●	○	●	148/213	3	E
Martensitic Stainless Steel	450	950	●	●	●	98/148	5	O
Austenitic Stainless Steel	450	800	○	●	●	98/148	5	O
Heat-Resistant Steel	800	-	○	●	●	49/66	5	O
Nitriding Steel	700	900	●	○	●	115/180	3	E
Tempering Steel	800	1250	●	●	○	66/115	5	O
Soft or Normalized Heat-Treatable Steel	500	750	●	○	●	148/213	2	E
Unalloyed Heat-Treated Heat-Treatable Steel	700	1000	●	●	○	98/148	4	E
Alloyed Heat-Treated Heat-Treatable Steel	700	1000	●	●	○	98/148	4	E
	900	1250	●	●	○	66/115	5	O
Alloyed - Heat Treated Tool Steel	900	1250	●	●	○	66/115	5	O
Unalloyed or Alloyed	Brinell Hardness (HB)							
Dead Annealed Tool Steel	180	240	●	○	●	98/148	4	E
High Carbon and/or High-Alloy	Brinell Hardness (HB)							
Dead Annealed Tool Steel	220	300	●	●	○	66/115	5	O

Machining Material			Application Group			Conditions		
Denomination	Brinell Hardness HB		N 7600 N Flutes	NR-F 7644 N Flutes	NR 7640 N Flutes	V _C +TiAlN (SFM)	Feed Material Group	Cooling E = Emulsion O = Oil D = Dry
	From	To						
Cast Iron with Lamellar Graphite	100	240	●	○	●	115/213	2	E/D
	230	320	●	○	●	82/148	4	E/D
Cast Iron with Spheroidal Graphite	100	240	●	○	●	115/213	2	E/D
	230	320	●	○	●	82/148	4	E/D
Malleable Cast Iron	100	270	●	○	●	82/148	2	E/D

Machining Material			Application Group			Conditions		
Denomination	Tensile Strength N/mm ²		N 7600 N Flutes	NR-F 7644 N Flutes	NR 7640 N Flutes	V _C +TiAlN (SFM)	Feed Material Group	Cooling E = Emulsion O = Oil D = Dry
	From	To						
Wrought and Cast Aluminum Alloys Silicon Contents up to 10%	-	180	○	-	○	951/1378	8	E
Cast Aluminum Alloys Silicon Contents up to 10%	150	250	●	-	●	295/558	1	E
Copper	200	400	○	-	○	361/689	1/8	E
Short Chips Brass up to 650	200	550	●	-	○	295/623	2	E
Short Chips Bronze up to 850	250	850	●	-	○	295/623	2	E/O
Long Chips Bronze up to 850	250	500	●	-	○	295/623	2	O
Wrought and Cast Magnesium Alloys	150	300	○	-	○	951/1378	2	D
Medium Strength Titanium Alloys	-	700	●	○	●	98/148	9	O
High Strength Titanium Alloys	600	1100	○	●	○	49/115	10	O

On Long Length End Mills it is recommend to reduce the feed by 50%
When an End Mill is Drilling, a reduction on the feed of 1/2 - 1/3 is recommended

● POSSIBLE APPLICATION ○ VERY SUITABLE

PMX-TiAlN End Mills

Feed per Tooth

MATERIAL GROUP	5/32"	1/4"	5/16"	3/8"	1/2"	5/8"	3/4"	1"	1-1/4"	1-1/2"	2"	2-1/2"
1	0,0008	0,0012	0,0014	0,0023	0,0027	0,0045	0,0045	0,0045	0,0045	0,0045	0,0045	0,0045
2	0,0008	0,0012	0,0014	0,0023	0,0027	0,0045	0,0045	0,0045	0,0045	0,0045	0,0045	0,0045
3	0,0008	0,0012	0,0014	0,0023	0,0027	0,0045	0,0045	0,0045	0,0045	0,0045	0,0045	0,0045
4	0,0006	0,0012	0,0014	0,0023	0,0027	0,0045	0,0045	0,0045	0,0045	0,0045	0,0045	0,0045
5	0,0005	0,0010	0,0012	0,0020	0,0020	0,0030	0,0030	0,0030	0,0030	0,0030	0,0030	0,0030
6	0,0010	0,0024	0,0031	0,0036	0,0045	0,0068	0,0068	0,0068	0,0068	0,0068	0,0068	0,0068
7	0,0006	0,0008	0,0011	0,0017	0,0021	0,0032	0,0041	0,0041	0,0041	0,0041	0,0041	0,0041
8	0,0010	0,0017	0,0024	0,0030	0,0036	0,0050	0,0059	0,0059	0,0059	0,0059	0,0059	0,0059
9	0,0010	0,0017	0,0024	0,0030	0,0036	0,0050	0,0059	0,0059	0,0059	0,0059	0,0059	0,0059
10	0,0006	0,0008	0,0011	0,0017	0,0021	0,0032	0,0041	0,0041	0,0041	0,0041	0,0041	0,0041

★ For LONG SERIES End Mills $fz = fz/2$

$$Vc = 0.262 \times d \times \text{RPM}$$

$$\text{RPM} = \frac{Vc}{d \times 0.262}$$

$$Vf = \text{RPM} \times z \times fz \times k$$

Vc = Cutting Speed

d = Diameter of End Mill

z = Number of Teeth

fz = Feed per Tooth

K = Constant to multiply depending on the work conditions

ae = Axis Cut Depth

vf = Feed in inch per minute

Constant (K) Chart

Multiply by K depending on conditions shown

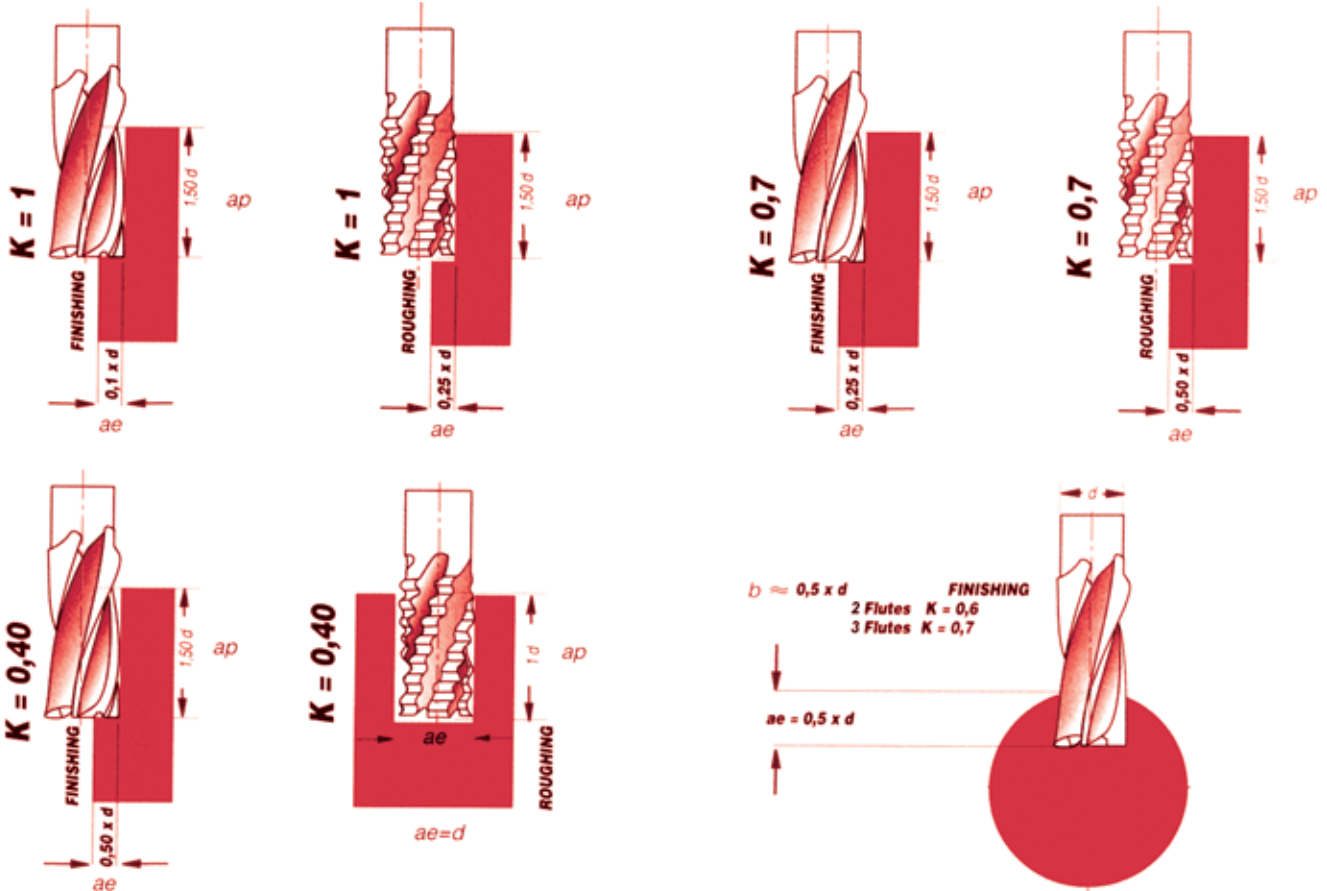

End Mills

High Speed Steel – Multi Flute – Non-Center Cut

Regular Length



Cutter Diameter (Inch)	Shank Diameter (Inch)	Length of Cut (Inch)	Overall Length (Inch)	No. of Flutes	Code
1/8	3/8	3/8	2-5/16	4	704000
5/32	3/8	7/16	2-5/16	4	704001
3/16	3/8	1/2	2-3/8	4	704002
7/32	3/8	5/8	2-1/4	4	704003
1/4	3/8	5/8	2-1/2	4	704004
9/32	3/8	11/16	2-1/2	4	704005
5/16	3/8	3/4	2-1/2	4	704006
11/32	3/8	3/4	2-1/2	4	704007
3/8	3/8	3/4	2-1/2	4	704008
13/32	3/8	1	2-11/16	4	704009
7/16	3/8	1	2-11/16	4	704010
15/32	3/8	1	2-11/16	4	704011
1/2	3/8	1	2-11/16	4	704012
1/2	1/2	1-1/4	3-1/4	4	704013
9/16	1/2	1-3/8	3-3/8	4	704014
5/8	1/2	1-3/8	3-3/8	4	704015
5/8	5/8	1-5/8	3-3/4	4	704016
11/16	1/2	1-5/8	3-5/8	4	704017
11/16	5/8	1-5/8	3-3/4	4	704018
3/4	1/2	1-5/8	3-5/8	4	704019
3/4	5/8	1-5/8	3-3/4	4	704020
3/4	3/4	1-5/8	3-7/8	4	704021
13/16	5/8	1-7/8	4	4	704022
13/16	3/4	1-7/8	4-1/8	4	704023

Cutter Diameter (Inch)	Shank Diameter (Inch)	Length of Cut (Inch)	Overall Length (Inch)	No. of Flutes	Code
7/8	5/8	1-7/8	4	6	704024
7/8	3/4	1-7/8	4-1/8	4	704025
7/8	7/8	1-7/8	4-1/8	4	704026
15/16	5/8	1-7/8	4	4	704027
15/16	3/4	1-7/8	4-1/8	4	704028
1	1/2	1-7/8	3-7/8	4	704029
1	5/8	1-7/8	4	4	704030
1	3/4	1-7/8	4-1/8	4	704031
1	1	2	4-1/2	4	704032
1-1/8	1	2	4-1/2	6	704033
1-1/4	1-1/4	2	4-1/2	4	704034
1-1/4	1	2	4-1/2	6	704035
1-1/4	1-1/4	2	4-1/2	6	704036
1-3/8	1	2	4-1/2	6	704037
1-1/2	1	2	4-1/2	6	704038
1-1/2	1-1/4	2	4-1/2	4	704039
1-1/2	1-1/4	2	4-1/2	6	704040
1-5/8	1-1/4	2	4-1/2	6	704041
1-3/4	1-1/4	2	4-1/2	6	704042
1-7/8	1-1/4	2	4-1/2	6	704043
2	1-1/4	2	4-1/2	6	704044
2	1-1/4	2	4-1/2	8	704045

Long Length



Cutter Diameter (Inch)	Shank Diameter (Inch)	Length of Cut (Inch)	Overall Length (Inch)	No. of Flutes	Code
1/4	3/8	1-1/4	3-1/16	4	704046
5/16	3/8	1-3/8	3-1/8	4	704047
3/8	3/8	1-1/2	3-1/4	4	704048
7/16	1/2	1-3/4	3-3/4	4	704049
1/2	1/2	2	4	4	704050
5/8	5/8	2-1/2	4-5/8	4	704051
3/4	3/4	3	5-1/4	4	704052
7/8	7/8	3-1/2	5-3/4	4	704053

Cutter Diameter (Inch)	Shank Diameter (Inch)	Length of Cut (Inch)	Overall Length (Inch)	No. of Flutes	Code
1	1	4	6-1/2	4	704054
1-1/8	1	4	6-1/2	6	704055
1-1/4	1	4	6-1/2	6	704056
1-1/4	1-1/4	4	6-1/2	6	704057
1-1/2	1	4	6-1/2	6	704058
1-1/2	1-1/4	4	6-1/2	6	704059
1-3/4	1-1/4	4	6-1/2	6	704060
2	1-1/4	4	6-1/2	6	704061

Extra Long Length



Cutter Diameter (Inch)	Shank Diameter (Inch)	Length of Cut (Inch)	Overall Length (Inch)	No. of Flutes	Code
1/4	3/8	1-3/4	3-9/16	4	704062
5/16	3/8	2	3-3/4	4	704063
3/8	3/8	2-1/2	4-1/4	4	704064
1/2	1/2	3	5	4	704065

Cutter Diameter (Inch)	Shank Diameter (Inch)	Length of Cut (Inch)	Overall Length (Inch)	No. of Flutes	Code
5/8	5/8	4	6-1/8	4	704066
3/4	3/4	4	6-1/4	4	704067
7/8	7/8	5	7-1/4	4	704068
1	1	6	8-1/2	4	704069
1-1/4	1-1/4	6	8-1/2	4	704070
1-1/2	1-1/4	8	10-1/2	4	704071

End Mills

High Speed Steel

Heavy Duty – Non-Center Cut – Combination Shank

4 Flute



6 Flute



Cutter Diameter (Inch)	Shank Diameter (Inch)	Length of Cut (Inch)	Overall Length (Inch)	Code
2	2	2	5-3/4	704077
2	2	4	7-3/4	704078
2	2	6	9-3/4	704079
2	2	8	11-3/4	704080

Cutter Diameter (Inch)	Shank Diameter (Inch)	Length of Cut (Inch)	Overall Length (Inch)	Code
2	2	4	7-3/4	704072
2	2	6	9-3/4	704073
2	2	8	11-3/4	704074
2	2	10	13-3/4	704075
2	2	12	15-3/4	704076

2 Flute – Regular Length



Cutter Diameter (Inch)	Shank Diameter (Inch)	Length of Cut (Inch)	Overall Length (Inch)	Code
3/32	3/8	5/16	2-1/4	704081
1/8	3/8	3/8	2-5/16	704082
5/32	3/8	7/16	2-5/16	704083
3/16	3/8	7/16	2-5/16	704084
7/32	3/8	1/2	2-5/16	704085
1/4	3/8	1/2	2-5/16	704086
9/32	3/8	9/16	2-5/16	704087
5/16	3/8	9/16	2-5/16	704088
11/32	3/8	9/16	2-5/16	704089
3/8	3/8	9/16	2-5/16	704090
13/32	3/8	13/16	2-1/2	704091
7/16	3/8	13/16	2-1/2	704092
15/32	3/8	13/16	2-1/2	704093
1/2	3/8	13/16	2-1/2	704094
1/2	1/2	1	3	704095
9/16	1/2	1-1/8	3-1/8	704096
5/8	1/2	1-1/8	3-1/8	704097
5/8	5/8	1-5/16	3-7/16	704098
11/16	1/2	1-5/16	3-5/16	704099
11/16	5/8	1-5/16	3-7/16	704100
3/4	1/2	1-5/16	3-5/16	704101
3/4	5/8	1-5/16	3-7/16	704102
3/4	3/4	1-5/16	3-9/16	704103
13/16	5/8	1-5/16	3-5/8	704104

Cutter Diameter (Inch)	Shank Diameter (Inch)	Length of Cut (Inch)	Overall Length (Inch)	Code
13/16	3/4	1-5/16	3-3/4	704105
7/8	5/8	1-5/16	3-5/8	704106
7/8	3/4	1-5/16	3-3/4	704107
7/8	7/8	1-1/2	3-3/4	704108
15/16	5/8	1-1/2	3-5/8	704109
15/16	3/4	1-1/2	3-3/4	704110
1	1/2	1-1/2	3-1/2	704111
1	5/8	1-1/2	3-5/8	704112
1	3/4	1-1/2	3-3/4	704113
1	7/8	1-5/8	3-3/4	704114
1	1	1-5/8	4-1/8	704115
1-1/8	1	1-5/8	4-1/8	704116
1-1/4	7/8	1-5/8	3-7/8	704117
1-1/4	1	1-5/8	4-1/8	704118
1-1/4	1-1/4	1-5/8	4-1/8	704119
1-3/8	1	1-5/8	4-1/8	704120
1-1/2	1	1-5/8	4-1/8	704121
1-1/2	1-1/4	1-5/8	4-1/8	704122
1-5/8	1-1/4	1-5/8	4-1/8	704123
1-3/4	1-1/4	1-5/8	4-1/8	704124
1-7/8	1-1/4	1-5/8	4-1/8	704125
2	1-1/4	1-5/8	4-1/8	704126

2 Flute – Long Length



Cutter Diameter (Inch)	Shank Diameter (Inch)	Length of Cut (Inch)	Overall Length (Inch)	Code
1/4	3/8	1-1/4	3-1/16	704127
5/16	3/8	1-3/8	3-1/8	704128
3/8	3/8	1-1/2	3-1/4	704129
1/2	1/2	2	4	704130
5/8	5/8	2	4-1/8	704131
3/4	3/4	2-1/4	4-1/2	704132

Cutter Diameter (Inch)	Shank Diameter (Inch)	Length of Cut (Inch)	Overall Length (Inch)	Code
7/8	7/8	2-1/2	4-3/4	704133
1	1	3	5-1/2	704134
1-1/4	1	3	5-1/2	704135
1-1/4	1-1/4	3	5-1/2	704136
1-1/2	1-1/4	3	5-1/2	704137
2	1-1/4	3	5-1/2	704138

END MILLS & ROUGHERS

End Mills

High Speed Steel

4 Flute – Regular Length – Ball Nose



2 Flute – Regular Length – Ball Nose



Cutter Diameter (Inch)	Shank Diameter (Inch)	Length of Cut (Inch)	Overall Length (Inch)	Code
1/8	3/8	3/8	2-5/16	704162
3/16	3/8	1/2	2-3/8	704163
1/4	3/8	5/8	2-7/16	704164
5/16	3/8	3/4	2-1/2	704165
3/8	3/8	3/4	2-1/2	704166
1/2	1/2	1-1/4	3-1/4	704167
5/8	5/8	1-5/8	3-3/4	704168
3/4	3/4	1-5/8	3-7/8	704169
7/8	7/8	1-7/8	4-1/2	704170
1	1	2	4-1/2	704171
1-1/4	1-1/4	2	4-1/2	704172
1-1/2	1-1/4	2	4-1/2	704173

Cutter Diameter (Inch)	Shank Diameter (Inch)	Length of Cut (Inch)	Overall Length (Inch)	Code
1/8	3/8	1/2	2-3/8	704148
3/16	3/8	1/2	2-3/8	704149
1/4	3/8	5/8	2-7/16	704150
5/16	3/8	3/4	2-1/2	704151
3/8	3/8	3/4	2-1/2	704152
7/16	1/2	1	3	704153
1/2	1/2	1	3	704154
9/16	1/2	1-1/8	3-1/8	704155
5/8	5/8	1-1/8	3-1/2	704156
3/4	3/4	1-1/8	3-7/8	704157
7/8	7/8	2	4-1/4	704158
1	1	2-1/4	4-3/4	704159
1-1/4	1-1/4	2-1/2	5	704160
1-1/2	1-1/4	2-1/2	5	704161

2 Flute – Extended Length



Cutter Diameter (Inch)	Shank Diameter (Inch)	Length of Cut (Inch)	Overall Length (Inch)	Code
1/4	3/8	5/8	3-1/16	704139
5/16	3/8	3/4	3-5/16	704140
3/8	3/8	3/4	3-5/16	704141
1/2	1/2	1	4	704142

Cutter Diameter (Inch)	Shank Diameter (Inch)	Length of Cut (Inch)	Overall Length (Inch)	Code
5/8	5/8	1-3/8	4-5/8	704143
3/4	3/4	1-5/8	5-3/8	704144
7/8	7/8	2	6	704145
1	1	2-1/2	7-1/4	704146
1-1/4	1-1/4	3	7-1/4	704147

Metric – 2 Flute – Regular Length – Center Cut – Inch Weldon Shanks



Cutter Diameter (mm)	Shank Diameter (Inch)	Length of Cut (Inch)	Overall Length (Inch)	Code
3.0	3/8	5/16	2-5/16	704223
4.0	3/8	7/16	2-5/16	704224
5.0	3/8	1/2	2-5/16	704225
6.0	3/8	1/2	2-5/16	704226
7.0	3/8	9/16	2-5/16	704227
8.0	3/8	9/16	2-5/16	704228
9.0	3/8	9/16	2-5/16	704229
10.0	3/8	13/16	2-1/2	704230
11.0	3/8	13/16	2-1/2	704231
12.0	3/8	13/16	2-1/2	704232
13.0	1/2	1-1/8	3-1/8	704233
14.0	1/2	1-1/8	3-1/8	704234

Cutter Diameter (mm)	Shank Diameter (Inch)	Length of Cut (Inch)	Overall Length (Inch)	Code
16.0	1/2	1-5/16	3-7/16	704235
18.0	1/2	1-5/16	3-7/16	704236
20.0	3/4	1-1/2	3	704237
22.0	3/4	1-1/2	3-3/4	704238
24.0	3/4	2	4-1/2	704239
25.0	3/4	2	4-1/2	704240
26.0	3/4	1-5/8	3-7/8	704241
30.0	1	1-5/8	4-1/8	704242
32.0	1	1-5/8	4-1/8	704243
36.0	1	1-5/8	4-1/8	704244

High Helix Cutters

High Speed Steel – 2 Flute – For Machining Aluminum

Regular Length



Cutter Diameter (Inch)	Shank Diameter (Inch)	Length of Cut (Inch)	Overall Length (Inch)	Code	Cutter Diameter (Inch)	Shank Diameter (Inch)	Length of Cut (Inch)	Overall Length (Inch)	Code
1/4	3/8	5/8	2-7/16	704264	3/4	3/4	1-5/8	3-7/8	704270
5/16	3/8	3/4	2-1/2	704265	7/8	7/8	1-7/8	4-1/8	704271
3/8	3/8	3/4	2-1/2	704266	1	1	2	4-1/2	704272
7/16	3/8	1	2-11/16	704267	1-1/4	1-1/4	2	4-1/2	704273
1/2	1/2	1-1/4	3-1/4	704268	1-1/2	1-1/4	2	4-1/2	704274
5/8	5/8	1-5/8	3-3/4	704269	1-3/4	1-1/4	2	4-1/2	704275
					2	1-1/4	2	4-1/2	704276

Long Length



Cutter Diameter (Inch)	Shank Diameter (Inch)	Length of Cut (Inch)	Overall Length (Inch)	Code	Cutter Diameter (Inch)	Shank Diameter (Inch)	Length of Cut (Inch)	Overall Length (Inch)	Code
1/4	3/8	1-1/4	3-1/8	704277	3/4	3/4	3	5-1/4	704283
5/16	3/8	1-3/8	3-1/8	704278	1	1	4	6-1/2	704284
3/8	3/8	1-1/2	3-1/4	704279	1-1/4	1-1/4	4	6-1/2	704285
7/16	1/2	1-3/4	3-3/4	704280	1-1/2	1-1/4	4	6-1/2	704286
1/2	1/2	2	4	704281	2	1-1/4	4	6-1/2	704287
5/8	5/8	2-1/2	4-5/8	704282					

Extra Long Length



Cutter Diameter (Inch)	Shank Diameter (Inch)	Length of Cut (Inch)	Overall Length (Inch)	Code	Cutter Diameter (Inch)	Shank Diameter (Inch)	Length of Cut (Inch)	Overall Length (Inch)	Code
1/4	3/8	1-3/4	3-9/16	704288	5/8	5/8	4	6-1/8	704292
5/16	3/8	2	3-3/4	704289	3/4	3/4	4	6-1/4	704293
3/8	3/8	2-1/2	4-1/4	704290	1	1	6	8-1/2	704294
1/2	1/2	3	5	704291	1-1/4	1-1/4	6	8-1/2	704295
					1-1/2	1-1/4	8	10-1/2	704296

END MILLS & ROUGHERS



End Mills – High Performance V7 INOX

Micrograin Solid Carbide – NANO AlTiN Coated – 4 Flute – Square End & Corner Radius



- Minimizes tool deflection
- Low amplitude – eliminates vibration
- Allows deeper cuts and faster speeds
- Increases metal removal rates
- Supreme surface finish
- For machining of most materials under 40HRC



Regular Length

Tolerance of Cutting Diameter: 0/-0.0012
Tolerance of Shank Diameter: h6

Cutter Diameter (Inch)	Shank Diameter (Inch)	Shank Style	Length of Cut (Inch)	Overall Length (Inch)	Square End	Corner Radius	
					Code	*Radius (Inch)	Code
1/8	1/8	Plain	3/8	1-1/2	888000	0.015	888034
5/32	3/16	Plain	7/16	2	888002	0.015	-
3/16	3/16	Plain	7/16	2	888004	0.015	888036
7/32	1/4	Plain	7/16	2-1/2	888006	-	-
1/4	1/4	Plain	1/2	2-1/2	888008	0.020	888038
5/16	5/16	Plain	13/16	2-1/2	888012	0.020	888040
3/8	3/8	Flat	7/8	2-1/2	888016	0.020	888042
7/16	7/16	Flat	1	2-3/4	888020	0.020	888044
1/2	1/2	Flat	1	3	888024	0.030	888046
9/16	9/16	Flat	1-1/8	3-1/2	888026	0.030	888048
5/8	5/8	Flat	1-1/4	3-1/2	888028	0.040	888050
3/4	3/4	Flat	1-1/2	4	888030	0.040	888052
1	1	Flat	1-1/2	4	888032	0.040	888054

*Radius +0 -0.005"

Metric – Regular Length

Tolerance of Cutting Diameter: 0/-0.03
Tolerance of Shank Diameter: h6

Cutter Diameter (mm)	Shank Diameter (mm)	Shank Style	Length of Cut (mm)	Overall Length (mm)	Square End	Corner Radius	
					Code	*Radius (mm)	Code
3	6	Plain	8	57	888056	0.38	888080
4	6	Plain	11	57	888058	0.38	888082
5	6	Plain	13	57	888060	0.38	888084
6	6	Plain	13	57	888062	0.51	888086
8	8	Plain	19	63	888064	0.51	888088
10	10	Plain	22	72	888066	0.51	888090
12	12	Flat	26	83	888068	0.76	888092
14	14	Flat	26	83	888070	0.76	888094
16	16	Flat	32	92	888072	1.02	888096
18	18	Flat	32	92	888074	1.02	888098
20	20	Flat	38	104	888076	1.02	888100
25	25	Flat	38	104	888078	1.02	888102

*Radius +0 -0.13"



Technical Information – High Performance V7 INOX

Micrograin Solid Carbide – NANO AlTiN Coated – 4 Flute – Square End & Corner Radius

Square End & Corner Radius V7 End Mills

Material	Alloy Steels Cast Iron		Stainless Steel 300 Series		Stainless Steel 400 Series		Titanium		Inconel	
Hardness	HRC 20									
Strength	1000N/mm ²									
Cutting Diameter (Inch)	RPM	Feed (Inch/Min.)	RPM	Feed (Inch/Min.)	RPM	Feed (Inch/Min.)	RPM	Feed (Inch/Min.)	RPM	Feed (Inch/Min.)
1/8	12,735	10.23	9,625	7.25	13,475	7.63	8,320	7.63	2,565	2.05
3/16	8,490	10.91	6,385	8.27	12,000	8.43	5,550	8.43	1,685	1.82
1/4	6,370	11.46	4,810	9.60	6,815	9.60	4,160	9.61	1,285	2.48
5/16	5,100	12.95	3,850	10.71	5,390	10.71	3,330	10.71	1,025	2.83
3/8	4,245	18.35	3,210	15.38	4,490	15.38	2,770	15.38	855	4.13
7/16	4,010	24.45	2,750	20.90	3,850	20.90	2,380	20.73	735	5.49
1/2	3,500	25.85	2,400	21.02	3,370	21.02	2,080	21.02	640	5.58
9/16	3,110	26.01	2,140	21.16	2,990	21.16	1,850	21.16	570	5.73
5/8	2,800	26.11	1,925	21.20	2,700	21.20	1,660	21.20	510	5.58
3/4	2,340	23.96	1,600	19.43	2,250	19.43	1,390	19.43	425	5.17
1	1,755	17.44	1,200	14.73	1,685	15.11	1,040	15.11	315	4.26

D
[0.6D]

1.5D
(1.2D)
[0.6D]

0.5D

* () : Short length Type
* [] : Stub length Type

0.5D

D

1.0D
[0.6D]

0.35D

*1.2 x D Axial cutting depth should be applied for Short length series – diameter over 5/16”
*0.6 x D Axial cutting depth should be applied for Stub length series

END MILLS & ROUGHERS

TITANIUM MACHINING: On full slot cuts reduce RPM and FEED by 35%. Speeds and feeds subject to coolant quality, quantity and pressure.



End Mills – ALU-POWER

Micrograin Solid Carbide – 2 & 3 Flute – 42° & 45° Helix

- For high velocity milling of aluminum and other non-ferrous materials
- Provides improved surface roughness
- Tightly controlled cylindrical margin

2 Flute – 42° Helix – Regular Length – “Banshee”

- Excellent plunging capabilities
- Excellent chip removal due to higher rake angle, higher helix angle (42°) and bigger chip pocket



Tolerance: 0/-0.0012

Cutter Diameter (Inch)	Shank Diameter (Inch)	Length of Cut (Inch)	Overall Length (Inch)	Code	Cutter Diameter (Inch)	Shank Diameter (Inch)	Length of Cut (Inch)	Overall Length (Inch)	Code
1/16	1/8	1/8	1-1/2	888310	1/2	1/2	1	3	888318
1/8	1/4	5/16	1-3/4	888312	1/2	1/2	2	4	888319
3/16	1/4	7/16	2	888313	5/8	5/8	1-1/4	3-1/2	888320
1/4	3/8	3/4	2-1/2	888314	3/4	3/4	1-1/2	4	888321
5/16	3/8	13/16	2-1/2	888315	1	1	1-1/2	4	888323
3/8	3/8	1	2-1/2	888316	1	1	3	5-1/2	888324
7/16	7/16	1	2-3/4	888317					

3 Flute – 45° Helix

- 3 flute and 45° helix allow harmonic balance at high speed conditions and smooth cutting
- Maximum material removal, chip evacuation, and stability



Tolerance: 0/-0.0005

Regular Length



Long Length



Cutter Diameter (Inch)	Shank Diameter (Inch)	Length of Cut (Inch)	Overall Length (Inch)	Code	Cutter Diameter (Inch)	Shank Diameter (Inch)	Length of Cut (Inch)	Overall Length (Inch)	Code
1/8	1/8	3/8	1-1/2	888409	1/4	1/4	1-1/4	3-1/4	888419
3/16	3/16	9/16	2	888410	5/16	5/16	1-1/4	3-1/2	888420
1/4	1/4	5/8	2-1/2	888411	3/8	3/8	1-1/2	3-1/2	888421
5/16	5/16	5/8	2-1/2	888412	7/16	7/16	2	4	888422
3/8	3/8	1	2-1/2	888413	1/2	1/2	2	4	888423
7/16	7/16	1-1/4	2-3/4	888414	5/8	5/8	2-1/2	5	888424
1/2	1/2	1-1/4	3	888415	1	1	3-1/4	6	888426
5/8	5/8	1-5/8	3-1/2	888416					
3/4	3/4	1-5/8	4	888417					
1	1	2	5	888418					



Technical Information – ALU-POWER

Micrograin Solid Carbide – 2 & 3 Flute – 42° & 45° Helix

2 Flute – 42° Helix – “Banshee”

Slotting		
Material	Aluminum Non-Ferrous Metals	
Cutting Diameter (Inch)	RPM	Feed (Inch/Minute)
1/8	10,000	27.56
5/32	10,000	35.43
3/16	10,000	39.37
1/4	10,000	47.24
5/16	8,000	55.12
3/8	8,000	66.93
1/2	8,000	82.68
9/16	6,000	70.87
5/8	6,000	74.80
11/16	4,000	55.12
13/16	4,000	62.99

Side Cutting		
Material	Aluminum Non-Ferrous Metals	
Cutting Diameter (Inch)	RPM	Feed (Inch/Minute)
1/8	10,000	35.43
5/32	10,000	43.31
3/16	10,000	51.18
1/4	10,000	59.06
5/16	8,000	70.387
3/8	8,000	82.68
1/2	8,000	102.40
9/16	6,000	86.61
5/8	6,000	94.49
11/16	4,000	70.87
13/16	4,000	74.80

A: $\varnothing 1/8 - \varnothing 3/8 = 0.25 \times D$
 $\varnothing 1/2 - \varnothing 13/16 = 0.5 \times D$

FEED: In long and extra-long types the feed should be reduced by approximately 50%

3 Flute – 45° Helix – Finish

Slotting		
Material	Aluminum Non-Ferrous Metals	
Cutting Diameter (Inch)	RPM	Feed (Inch/Minute)
1/8	10,000	33.05
5/32	10,000	42.50
3/16	10,000	47.25
1/4	10,000	56.70
5/16	8,000	66.15
3/8	8,000	80.30
1/2	8,000	99.15
9/16	6,000	85.05
5/8	6,000	89.75
11/16	4,000	66.15
13/16	4,000	75.60

Side Cutting		
Material	Aluminum Non-Ferrous Metals	
Cutting Diameter (Inch)	RPM	Feed (Inch/Minute)
1/8	10,000	42.50
5/32	10,000	52.00
3/16	10,000	61.40
1/4	10,000	70.90
5/16	8,000	85.05
3/8	8,000	99.20
1/2	8,000	122.90
9/16	6,000	103.95
5/8	6,000	113.40
11/16	4,000	85.05
13/16	4,000	89.75

A: $\varnothing 1/8 - \varnothing 3/8 = 0.25 \times D$
 $\varnothing 1/2 - \varnothing 13/16 = 0.5 \times D$

FEED: In long and extra-long types the feed should be reduced by approximately 50%

END MILLS
& ROUGHERS

Tapered End Mills

Micrograin Solid Carbide – 3 Flute



• Center cut

Ball End available
Please inquire

1/2° per Side

Tip Diameter (Inch)	Flute Length (Inch)	Shank Diameter (Inch)	Overall Length (Inch)	Code
3/32	3/4	1/8	2-1/2	313707
1/8	3/4	1/4	2-1/2	313708

Tip Diameter (Inch)	Flute Length (Inch)	Shank Diameter (Inch)	Overall Length (Inch)	Code
1/8	1	1/4	3	313709
3/16	3/4	1/4	2-1/2	313710

Tip Diameter (Inch)	Flute Length (Inch)	Shank Diameter (Inch)	Overall Length (Inch)	Code
3/16	1-1/4	1/4	3	313711
1/4	3/4	3/8	2-1/2	313712
1/4	1-1/4	3/8	3	313713

1° per Side

Tip Diameter (Inch)	Flute Length (Inch)	Shank Diameter (Inch)	Overall Length (Inch)	Code
3/32	1/2	1/8	2-1/2	313714
3/32	1	1/4	3	313715
1/8	3/4	1/4	2-1/2	313716
1/8	1	1/4	3	313717

Tip Diameter (Inch)	Flute Length (Inch)	Shank Diameter (Inch)	Overall Length (Inch)	Code
1/8	1-1/2	1/4	3	313718
3/16	3/4	1/4	2-1/2	313719
3/16	1-1/4	1/4	3	313720
3/16	1-3/4	1/4	3-1/2	313721

Tip Diameter (Inch)	Flute Length (Inch)	Shank Diameter (Inch)	Overall Length (Inch)	Code
1/4	3/4	3/8	2-1/2	313722
1/4	1-1/4	3/8	3	313723
1/4	2	3/8	4	313724

1-1/2° per Side

Tip Diameter (Inch)	Flute Length (Inch)	Shank Diameter (Inch)	Overall Length (Inch)	Code
3/32	1	1/4	3	313725
1/8	3/4	1/4	2-1/2	313726

Tip Diameter (Inch)	Flute Length (Inch)	Shank Diameter (Inch)	Overall Length (Inch)	Code
1/8	1-1/2	1/4	3	313727
3/16	1-1/4	3/8	3	313728

Tip Diameter (Inch)	Flute Length (Inch)	Shank Diameter (Inch)	Overall Length (Inch)	Code
3/16	1-3/4	3/8	3-1/2	313729
1/4	3/4	3/8	2-1/2	313730
1/4	1-1/4	3/8	3	313731

2° per Side

Tip Diameter (Inch)	Flute Length (Inch)	Shank Diameter (Inch)	Overall Length (Inch)	Code
3/32	3/4	1/4	2-1/2	313732
3/32	1	1/4	3	313733
1/8	3/4	1/4	2-1/2	313734
1/8	1-1/4	1/4	3	313735

Tip Diameter (Inch)	Flute Length (Inch)	Shank Diameter (Inch)	Overall Length (Inch)	Code
3/16	3/4	1/4	2-1/2	313736
3/16	1-1/4	3/8	3	313737
3/16	1-3/4	3/8	3-1/2	313738
1/4	3/4	3/8	2-1/2	313739

Tip Diameter (Inch)	Flute Length (Inch)	Shank Diameter (Inch)	Overall Length (Inch)	Code
1/4	1-1/4	3/8	3	313740
1/4	2	1/2	4	313741

3° per Side

Tip Diameter (Inch)	Flute Length (Inch)	Shank Diameter (Inch)	Overall Length (Inch)	Code
3/32	1	1/4	3	313742
3/32	1-1/2	1/4	3	313743
1/8	3/4	1/4	2-1/2	313744
1/8	1	1/4	3	313745

Tip Diameter (Inch)	Flute Length (Inch)	Shank Diameter (Inch)	Overall Length (Inch)	Code
1/8	1-1/2	3/8	3-1/2	313746
1/8	2	3/8	3-1/2	313747
5/32	1-1/4	3/8	3	313748
5/32	1-3/4	3/8	3-1/2	313749

Tip Diameter (Inch)	Flute Length (Inch)	Shank Diameter (Inch)	Overall Length (Inch)	Code
3/16	3/4	3/8	2-1/2	313750
3/16	1-1/4	3/8	3	313751
1/4	3/4	3/8	2-1/2	313752
1/4	1-1/4	3/8	3	313753
1/4	2	1/2	4	313754

4° per Side

Tip Diameter (Inch)	Flute Length (Inch)	Shank Diameter (Inch)	Overall Length (Inch)	Code
3/32	1	1/4	3	313755
1/8	3/4	1/4	2-1/2	313756

Tip Diameter (Inch)	Flute Length (Inch)	Shank Diameter (Inch)	Overall Length (Inch)	Code
1/8	1	3/8	3	313757
3/16	3/4	3/8	2-1/2	313758

Tip Diameter (Inch)	Flute Length (Inch)	Shank Diameter (Inch)	Overall Length (Inch)	Code
3/16	1-1/4	3/8	3	313759
1/4	3/4	1/2	2-1/2	313760
1/4	1-1/4	1/2	3-1/2	313761

Tapered End Mills

Micrograin Solid Carbide – 3 Flute (continued)

5° per Side

Tip Diameter (Inch)	Flute Length (Inch)	Shank Diameter (Inch)	Overall Length (Inch)	Code
3/32	3/4	1/4	2-1/2	313762
3/32	1	3/8	3	313763
3/32	1-1/2	3/8	3-1/2	313764
1/8	3/4	1/4	2-1/2	313765

Tip Diameter (Inch)	Flute Length (Inch)	Shank Diameter (Inch)	Overall Length (Inch)	Code
1/8	1	3/8	3	313766
1/8	1-1/2	3/8	3-1/2	313767
3/16	3/4	3/8	2-1/2	313768
3/16	1-1/4	1/2	3	313769

Tip Diameter (Inch)	Flute Length (Inch)	Shank Diameter (Inch)	Overall Length (Inch)	Code
1/4	3/4	1/2	2-1/2	313770
1/4	1	1/2	3	313771
1/4	1-1/4	1/2	3-1/2	313772
1/4	2	5/8	4	313773

7° per Side

Tip Diameter (Inch)	Flute Length (Inch)	Shank Diameter (Inch)	Overall Length (Inch)	Code
3/32	1	3/8	3	313774
1/8	1/2	3/8	2-1/2	313775
1/8	3/4	3/8	2-1/2	313776
1/8	1	3/8	3	313777

Tip Diameter (Inch)	Flute Length (Inch)	Shank Diameter (Inch)	Overall Length (Inch)	Code
1/8	1-1/2	1/2	3-1/2	313778
5/32	3/4	3/8	2-1/2	313779
3/16	1-1/4	1/2	3-1/2	313780
1/4	3/4	1/2	2-1/2	313781

Tip Diameter (Inch)	Flute Length (Inch)	Shank Diameter (Inch)	Overall Length (Inch)	Code
1/4	1-1/4	5/8	3-1/2	313782

10° per Side

Tip Diameter (Inch)	Flute Length (Inch)	Shank Diameter (Inch)	Overall Length (Inch)	Code
3/32	1/2	3/8	2-1/2	313784
3/32	1-1/2	5/8	3-1/2	313785
1/8	3/4	3/8	2-1/2	313786
1/8	1	1/2	3	313787

Tip Diameter (Inch)	Flute Length (Inch)	Shank Diameter (Inch)	Overall Length (Inch)	Code
1/8	1-1/4	5/8	3-1/2	313788
3/16	1-1/4	5/8	3-1/2	313789

Tip Diameter (Inch)	Flute Length (Inch)	Shank Diameter (Inch)	Overall Length (Inch)	Code
1/4	3/4	5/8	2-1/2	313790
1/4	1	5/8	3	313791

Tapered End Mills

High Speed Steel



- For extrusion dies, die cast dies and molds
- Center cut
- Shanks within 0.0005"
- Hollow ground
- Polished flutes

1/2° per Side

Tip Diameter (Inch)	Flute Length (Inch)	Shank Diameter (Inch)	Overall Length (Inch)	Code
3/32	1/2	3/8	2-1/2	313377
3/32	3/4	3/8	2-1/2	313378
3/32	1-1/4	3/8	3-1/8	313379
1/8	1/4	3/8	2-1/2	313380
1/8	1/2	3/8	2-1/2	313381
1/8	3/4	3/8	2-1/2	313382
1/8	1	3/8	2-7/8	313383
1/8	1-1/4	3/8	3-1/8	313384
3/16	3/4	3/8	2-1/2	313385
3/16	1-1/4	3/8	3-1/8	313386

Tip Diameter (Inch)	Flute Length (Inch)	Shank Diameter (Inch)	Overall Length (Inch)	Code
1/4	3/4	3/8	2-1/2	313384
1/4	1-1/4	3/8	3-1/8	313388
1/4	2-1/4	1/2	4-1/4	313389
1/4	3-1/4	1/2	5-1/2	313390
3/8	1-1/4	1/2	3-1/8	313391
3/8	2-1/4	1/2	4-1/4	313392
3/8	3-1/4	1/2	5-1/2	313393
1/2	1-1/4	1/2	3-1/8	313394
1/2	2-1/4	1/2	4-1/4	313395
1/2	3-1/4	1/2	5-1/2	313396

Tip Diameter (Inch)	Flute Length (Inch)	Shank Diameter (Inch)	Overall Length (Inch)	Code
5/8	2-1/4	5/8	4-1/2	313397
5/8	3-1/4	5/8	5-1/2	313398
5/8	4-1/4	5/8	6-1/2	313399
3/4	2-1/4	3/4	4-1/2	313400
3/4	3-1/4	3/4	5-3/4	313401
3/4	4-1/4	3/4	7-3/4	313402
3/4	5-1/4	3/4	7-3/4	313403

Tapered End Mills

High Speed Steel (continued)



1° per Side

Tip Diameter (Inch)	Flute Length (Inch)	Shank Diameter (Inch)	Overall Length (Inch)	Code
3/32	1/2	3/8	2-1/2	313404
3/32	3/4	3/8	2-1/2	313405
3/32	1-1/4	3/8	3-1/8	313406
1/8	1/4	3/8	2-1/2	313407
1/8	1/2	3/8	2-1/2	313408
1/8	3/4	3/8	2-1/2	313409
1/8	1	3/8	2-7/8	313410
1/8	1-1/4	3/8	3-1/8	313411
3/16	3/4	3/8	2-1/2	313412
3/16	1-1/4	3/8	3-1/8	313413

Tip Diameter (Inch)	Flute Length (Inch)	Shank Diameter (Inch)	Overall Length (Inch)	Code
1/4	3/4	3/8	2-1/2	313414
1/4	1-1/4	3/8	3-1/8	313415
1/4	2-1/4	1/2	4-1/4	313416
1/4	3-1/4	1/2	5-1/2	313417
3/8	1-1/4	1/2	3-1/8	313418
3/8	2-1/4	1/2	4-1/4	313419
3/8	3-1/4	1/2	5-1/2	313420
1/2	1-1/4	1/2	3-1/8	313421
1/2	2-1/4	1/2	4-1/4	313422
1/2	3-1/4	5/8	5-3/8	313423

Tip Diameter (Inch)	Flute Length (Inch)	Shank Diameter (Inch)	Overall Length (Inch)	Code
5/8	2-1/4	5/8	4-1/2	313424
5/8	3-1/4	5/8	5-1/2	313425
5/8	4-1/4	5/8	6-1/2	313426
3/4	2-1/4	3/4	4-1/2	313427
3/4	3-1/4	3/4	5-3/4	313428
3/4	4-1/4	3/4	7-3/4	313429
3/4	5-1/4	3/4	7-3/4	313430

1-1/2° per Side

Tip Diameter (Inch)	Flute Length (Inch)	Shank Diameter (Inch)	Overall Length (Inch)	Code
3/32	1/2	3/8	2-1/2	313431
3/32	1	3/8	2-7/8	313432
3/32	1-1/4	3/8	3-1/8	313433
3/32	1-1/2	3/8	3-1/4	313434
7/64	1	3/8	2-7/8	313435
7/64	1-1/2	3/8	3-1/4	313436
7/64	2	3/8	3-7/8	313437
1/8	1/2	3/8	2-1/2	313438
1/8	3/4	3/8	2-1/2	313439
1/8	1	3/8	2-7/8	313440
1/8	1-1/4	3/8	3-1/8	313441
1/8	1-1/2	3/8	3-1/4	313442

Tip Diameter (Inch)	Flute Length (Inch)	Shank Diameter (Inch)	Overall Length (Inch)	Code
1/8	2	3/8	3-7/8	313443
5/32	1	3/8	2-7/8	313444
5/32	1-1/2	3/8	3-1/4	313445
3/16	3/4	3/8	2-1/2	313446
3/16	1-1/4	3/8	3-1/8	313447
3/16	2-1/4	3/8	4-1/4	313448
1/4	3/4	3/8	2-1/2	313449
1/4	1-1/4	3/8	3-1/8	313450
1/4	2-1/4	1/2	4-1/4	313451
1/4	3-1/4	1/2	5-1/2	313452

Tip Diameter (Inch)	Flute Length (Inch)	Shank Diameter (Inch)	Overall Length (Inch)	Code
3/8	1-1/4	1/2	3-1/8	313453
3/8	2-1/4	1/2	4-1/4	313454
3/8	3-1/4	5/8	5-1/2	313455
1/2	1-1/4	1/2	3-1/8	313456
1/2	2-1/4	5/8	4-1/4	313457
1/2	3-1/4	5/8	5-1/2	313458
5/8	2-1/4	3/4	5-1/2	313460
5/8	3-1/4	3/4	6-1/2	313461
3/4	2-1/4	3/4	4-3/4	313462
3/4	5-1/4	1	7-3/4	313463

2° per Side

Tip Diameter (Inch)	Flute Length (Inch)	Shank Diameter (Inch)	Overall Length (Inch)	Code
3/32	1/2	3/8	2-1/2	313464
3/32	3/4	3/8	2-1/2	313465
1/8	1/2	3/8	2-1/2	313466
1/8	3/4	3/8	2-1/2	313467
1/8	1	3/8	2-7/8	313468
1/8	1-1/4	3/8	3-1/8	313469
1/8	1-1/2	3/8	3-1/4	313470
3/16	3/4	3/8	2-1/2	313471

Tip Diameter (Inch)	Flute Length (Inch)	Shank Diameter (Inch)	Overall Length (Inch)	Code
3/16	1-1/4	3/8	3-1/8	313472
1/4	3/4	3/8	2-1/2	313473
1/4	1-1/4	3/8	3-1/8	313474
1/4	2-1/4	1/2	4-1/4	313475
1/4	3-1/4	1/2	5-1/2	313476
3/8	1-1/4	1/2	3-1/8	313477
3/8	2-1/4	1/2	4-1/4	313478
3/8	3-1/4	5/8	5-1/2	313479

Tip Diameter (Inch)	Flute Length (Inch)	Shank Diameter (Inch)	Overall Length (Inch)	Code
1/2	1-1/4	1/2	3-1/8	313480
1/2	2-1/4	1/2	4-1/4	313481
1/2	3-1/4	5/8	5-1/2	313482
5/8	2-1/4	3/4	4-1/2	313483
5/8	3-1/4	3/4	5-1/2	313484
5/8	4-1/4	3/4	6-1/2	313485
3/4	3-1/4	1	5-3/4	313486
3/4	5-1/4	1	7-3/4	313487

Tapered End Mills

High Speed Steel (continued)



7° per Side

Tip Diameter (Inch)	Flute Length (Inch)	Shank Diameter (Inch)	Overall Length (Inch)	Code
0.062	1	3/8	2-7/8	313615
0.070	1	3/8	2-3/4	313616
3/32	1	3/8	2-7/8	313617
3/32	1-1/4	1/2	3-1/8	313618
3/32	1-1/2	1/2	3-1/4	313619
1/8	3/4	3/8	2-1/2	313621
1/8	1	3/8	2-7/8	313622
1/8	1-1/4	1/2	3-1/4	313623
1/8	2	5/8	4-1/8	313624
1/8	3	3/4	5-1/4	313625

Tip Diameter (Inch)	Flute Length (Inch)	Shank Diameter (Inch)	Overall Length (Inch)	Code
3/16	1-1/4	1/2	3-1/8	313626
3/16	3	3/4	5-1/4	313627
1/4	3/4	1/2	2-1/2	313628
1/4	1-1/4	1/2	3-1/8	313629
1/4	2-1/4	3/4	4-1/2	313630
1/4	3-1/4	1	5-3/4	313631
1/4	4	1	6-1/2	313632
5/16	3-1/4	1	5-3/4	313633
3/8	2-1/4	3/4	4-1/4	313634
3/8	3-1/4	1	5-3/4	313635

Tip Diameter (Inch)	Flute Length (Inch)	Shank Diameter (Inch)	Overall Length (Inch)	Code
3/8	4	1-1/4	6-1/2	313636
1/2	1-1/4	3/4	3-1/2	313637
1/2	2-1/4	1	4-3/4	313638
1/2	3-1/4	1-1/4	5-3/4	313639
1/2	4	1-1/4	6-1/2	313640
5/8	4	1-1/4	6-1/2	313641
3/4	4	1-1/4	5-3/4	313642
3/4	4	1-1/4	6-1/2	313643

10° per Side

Tip Diameter (Inch)	Flute Length (Inch)	Shank Diameter (Inch)	Overall Length (Inch)	Code
3/32	1/2	3/8	2-1/2	313644
3/32	1-1/2	1/2	3-3/8	313645
1/8	3/4	3/8	2-1/2	313646
1/8	1-1/4	1/2	3-1/8	313647
3/16	1-1/4	1/2	2-1/8	313648
1/4	3/4	1/2	2-1/2	313649

Tip Diameter (Inch)	Flute Length (Inch)	Shank Diameter (Inch)	Overall Length (Inch)	Code
1/4	1-1/4	1/2	3-1/8	313650
1/4	2-1/4	3/4	4-1/4	313651
3/8	1-1/4	5/8	3-1/4	313652
3/8	2-1/4	1	4-5/8	313653

Tip Diameter (Inch)	Flute Length (Inch)	Shank Diameter (Inch)	Overall Length (Inch)	Code
3/8	3-1/4	1-1/4	4-3/4	313654
1/2	1-1/4	3/4	3-3/8	313655
1/2	2-1/4	1	4-5/8	313656
1/2	3-1/4	1-1/4	4-3/4	313657

15° per Side

Tip Diameter (Inch)	Flute Length (Inch)	Shank Diameter (Inch)	Overall Length (Inch)	Code
3/32	3/4	1/2	2-3/4	313658
3/32	1	1/2	2-7/8	313659
3/32	1-1/2	1/2	3-7/16	313660
1/8	1/2	3/8	2-1/2	313661
1/8	3/4	1/2	2-1/2	313662
1/8	1	1/2	3	313663
1/8	1-1/4	1/2	3-1/8	313664
3/16	1	1/2	3	313665

Tip Diameter (Inch)	Flute Length (Inch)	Shank Diameter (Inch)	Overall Length (Inch)	Code
3/16	1-1/4	3/4	3-1/2	313666
3/16	1-1/4	1/2	3-1/4	313667
1/4	1	1/2	3	313668
1/4	1-1/4	3/4	3-1/2	313669
1/4	1-1/4	1/2	3-1/4	313670
1/4	1-1/2	3/4	3-3/4	313671
1/4	2-1/4	1	4-3/8	313672
5/16	1	3/4	3-1/4	313673

Tip Diameter (Inch)	Flute Length (Inch)	Shank Diameter (Inch)	Overall Length (Inch)	Code
3/8	1-1/4	3/4	3-1/2	313674
3/8	2-1/4	1-1/4	4-3/4	313675
1/2	1	3/4	3-1/4	313676
1/2	1-1/4	3/4	3-1/2	313677
1/2	1-3/4	1	4-1/4	313678
1/2	2-1/4	1-1/4	4-3/4	313679

20° per Side

Tip Diameter (Inch)	Flute Length (Inch)	Shank Diameter (Inch)	Overall Length (Inch)	Code
1/8	1/2	3/8	2-1/2	313680
1/8	1	1/2	3	313681
3/16	1	1/2	3	313682
1/4	1	1/2	3	313683

Tip Diameter (Inch)	Flute Length (Inch)	Shank Diameter (Inch)	Overall Length (Inch)	Code
1/4	1-1/2	3/4	3-3/4	313684
5/16	1	3/4	3-1/4	313685
5/16	1-1/2	3/4	3-3/4	313686
3/8	1-1/2	3/4	3-3/4	313687

Tip Diameter (Inch)	Flute Length (Inch)	Shank Diameter (Inch)	Overall Length (Inch)	Code
3/8	2	1	4-1/2	313688

Tapered End Mills

High Speed Steel (*continued*)

25° per Side

Tip Diameter (Inch)	Flute Length (Inch)	Shank Diameter (Inch)	Overall Length (Inch)	Code
1/8	1/2	1/2	2-1/2	313689
1/8	1	1/2	3	313690
1/4	1	5/8	3-1/4	313691
1/4	1-1/2	3/4	3-3/4	313692

Tip Diameter (Inch)	Flute Length (Inch)	Shank Diameter (Inch)	Overall Length (Inch)	Code
5/16	3/4	5/8	3	313693
5/16	1	3/4	3-1/4	313694
5/16	1-1/2	1	4	313695
3/8	3/4	5/8	3	313696

Tip Diameter (Inch)	Flute Length (Inch)	Shank Diameter (Inch)	Overall Length (Inch)	Code
3/8	1	3/4	3-1/4	313697
3/8	1-1/2	1	4	313698
1/2	1-1/4	1	3-3/4	313699

30° per Side

Tip Diameter (Inch)	Flute Length (Inch)	Shank Diameter (Inch)	Overall Length (Inch)	Code
1/8	1/2	1/2	2-1/2	313700
1/8	1	1/2	3	313701

Tip Diameter (Inch)	Flute Length (Inch)	Shank Diameter (Inch)	Overall Length (Inch)	Code
1/4	1	3/4	3-1/4	313702
1/4	1-1/2	1	4	313703

Tip Diameter (Inch)	Flute Length (Inch)	Shank Diameter (Inch)	Overall Length (Inch)	Code
3/8	1-1/4	1	3-3/4	313704
3/8	1-1/2	1	4	313705
1/2	1-1/4	1	3-3/4	313706

Side Milling Cutters

High Speed Steel – Plain & Staggered Tooth

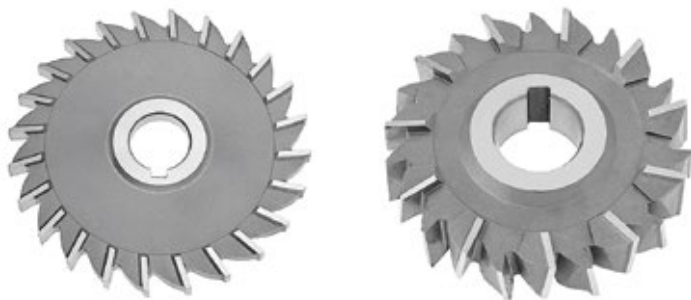

Diameter (Inch)	Hole Size (Inch)	Face Width (Inch)	Plain		Staggered		Diameter (Inch)	Hole Size (Inch)	Face Width (Inch)	Plain		Staggered	
			No. of Teeth	Code	No. of Teeth	Code				No. of Teeth	Code	No. of Teeth	Code
2	1/2	3/16	14	603220	–	–	3	1	13/16	18	603262	16	603021
2	1/2	1/4	14	603221	–	–	3	1	7/8	18	603263	16	–
2	1/2	5/16	14	603222	–	–	3	1	15/16	18	603264	–	–
2	1/2	3/8	14	603223	–	–	3	1	1	18	603265	–	–
2	5/8	3/16	14	603224	–	–	3	1-1/4	3/16	18	603266	16	603025
2	5/8	1/4	14	603225	–	–	3	1-1/4	7/32	18	603267	–	–
2	5/8	5/16	14	603226	–	–	3	1-1/4	1/4	18	603268	16	603026
2	5/8	3/8	14	603227	–	–	3	1-1/4	9/32	18	603269	–	–
2	7/8	1/4	14	603228	–	–	3	1-1/4	5/16	18	603270	16	603027
2	7/8	5/16	14	603229	–	–	3	1-1/4	3/8	18	603272	16	603028
2	7/8	3/8	14	603230	–	–	3	1-1/4	13/32	18	603273	–	–
2	7/8	7/16	14	603231	–	–	3	1-1/4	7/16	18	603274	16	603029
2-1/2	7/8	3/16	16	603232	16	603000	3	1-1/4	1/2	18	603275	16	603030
2-1/2	7/8	1/4	16	603233	16	603001	3	1-1/4	9/16	18	603276	–	–
2-1/2	7/8	5/16	16	603234	16	603002	3	1-1/4	5/8	18	603277	16	603032
2-1/2	7/8	3/8	16	603235	16	603003	3	1-1/4	11/16	18	603278	16	603033
2-1/2	7/8	7/16	16	603236	–	–	3	1-1/4	3/4	18	603279	16	603034
2-1/2	7/8	1/2	16	603237	16	603004	3	1-1/4	13/16	18	603280	16	603035
2-1/2	7/8	9/16	16	603238	–	–	3	1-1/4	7/8	18	603281	16	603036
2-1/2	7/8	5/8	16	603239	–	–	3	1-1/4	15/16	18	603282	16	603037
2-1/2	1	3/16	16	603240	–	–	3	1-1/4	1	18	603283	16	603038
2-1/2	1	1/4	16	603241	16	603005	3-1/2	1	3/16	20	603284	–	–
2-1/2	1	5/16	16	603242	–	–	3-1/2	1	1/4	20	603285	18	603039
2-1/2	1	3/8	16	603243	–	–	3-1/2	1	5/16	20	603286	–	–
2-1/2	1	7/16	16	603244	16	603006	3-1/2	1	3/8	20	603287	18	603040
2-1/2	1	1/2	16	603245	16	603007	3-1/2	1	7/16	20	603288	–	–
2-1/2	1	9/16	16	603246	–	–	3-1/2	1	1/2	20	603289	18	603041
2-1/2	1	5/8	16	603247	–	–	3-1/2	1	5/8	20	603290	18	603042
3	1	3/16	18	603248	16	603008	3-1/2	1-1/4	1/2	20	603292	–	–
3	1	7/32	18	603249	16	603009	4	1	3/16	22	603293	18	603044
3	1	1/4	18	603250	16	603010	4	1	7/32	22	603294	18	603045
3	1	9/32	18	603251	16	603011	4	1	1/4	22	603295	18	603046
3	1	5/16	18	603252	16	603012	4	1	9/32	22	603296	18	603047
3	1	11/32	18	603253	–	–	4	1	5/16	22	603297	18	603048
3	1	3/8	18	603254	16	603014	4	1	11/32	22	603298	18	603049
3	1	13/32	18	603255	–	–	4	1	3/8	22	603299	18	603050
3	1	7/16	18	603256	16	603015	4	1	7/16	22	603300	18	603051
3	1	1/2	18	603257	16	603016	4	1	13/32	22	603301	–	–
3	1	9/16	18	603258	16	603017	4	1	1/2	22	603302	18	603052
3	1	5/8	18	603259	16	603018	4	1	9/16	22	603303	18	603053
3	1	11/16	18	603260	16	603019	4	1	5/8	22	603304	18	603054
3	1	3/4	18	603261	16	603020	4	1	11/16	22	603305	–	–

Side Milling Cutters

High Speed Steel – Staggered & Plain Tooth (continued)



Diameter (Inch)	Hole Size (Inch)	Face Width (Inch)	Plain		Staggered		Diameter (Inch)	Hole Size (Inch)	Face Width (Inch)	Plain		Staggered	
			No. of Teeth	Code	No. of Teeth	Code				No. of Teeth	Code	No. of Teeth	Code
4	1	3/4	22	603306	18	603055	5	1-1/4	5/16	24	603355	22	603095
4	1	13/16	22	603307	18	603056	5	1-1/4	11/32	24	603356	-	-
4	1	7/8	22	603308	18	603057	5	1-1/4	3/8	24	603357	22	603096
4	1	15/16	22	603309	18	603058	5	1-1/4	13/32	24	603358	-	-
4	1	1	22	603310	18	603059	5	1-1/4	7/16	24	603359	22	603097
4	1	1-1/8	22	603311	-	-	5	1-1/4	1/2	24	603360	22	603098
4	1	1-1/2	22	603313	-	-	5	1-1/4	9/16	24	603361	-	-
4	1-1/4	3/16	22	603314	18	603060	5	1-1/4	5/8	24	603362	22	603100
4	1-1/4	7/32	22	603315	18	603061	5	1-1/4	11/16	24	603363	22	603101
4	1-1/4	1/4	22	603316	18	603062	5	1-1/4	3/4	24	603364	22	603102
4	1-1/4	9/32	22	603317	18	603063	5	1-1/4	13/16	24	603365	-	-
4	1-1/4	5/16	22	603318	18	603064	5	1-1/4	7/8	24	603366	-	-
4	1-1/4	11/32	22	603319	-	-	5	1-1/4	15/16	24	603367	-	-
4	1-1/4	3/8	22	603320	18	603066	5	1-1/4	1	24	603368	22	603105
4	1-1/4	7/16	22	603321	18	603067	5	1-1/4	1-1/4	24	603369	-	-
4	1-1/4	13/32	22	603322	-	-	6	1	1/4	26	603370	24	603106
4	1-1/4	1/2	22	603323	18	603068	6	1	5/16	26	603371	24	603108
4	1-1/4	9/16	22	603324	18	603069	6	1	3/8	26	603372	24	603109
4	1-1/4	5/8	22	603325	18	603070	6	1	7/16	26	603373	24	603110
4	1-1/4	11/16	22	603326	-	-	6	1	1/2	26	603374	24	603111
4	1-1/4	3/4	22	603327	18	603072	6	1	9/16	26	603375	24	-
4	1-1/4	13/16	22	603328	18	603073	6	1	5/8	26	603376	-	-
4	1-1/4	7/8	22	603329	18	603074	6	1	11/16	26	603377	-	-
4	1-1/4	15/16	22	603330	18	603075	6	1	3/4	26	603378	24	603115
4	1-1/4	1	22	603331	18	603076	6	1	13/16	26	603379	-	-
4	1-1/4	1-1/8	22	603332	-	-	6	1	7/8	26	603380	24	603117
4	1-1/4	1-3/16	-	-	18	603078	6	1	15/16	-	-	24	603118
4	1-1/4	1-1/4	22	603333	18	603079	6	1	1	26	603382	24	603119
4	1-1/4	1-1/2	22	603334	18	-	6	1	1-1/4	26	603383	-	-
4-1/2	1	1/2	-	-	20	603081	6	1-1/4	1/4	26	603384	24	603120
4-1/2	1-1/4	3/8	24	603335	-	-	6	1-1/4	9/32	26	603385	24	603121
4-1/2	1-1/4	1/2	24	603336	20	603082	6	1-1/4	5/16	26	603386	24	603122
5	1	1/4	24	603337	22	603083	6	1-1/4	11/32	26	603387	-	-
5	1	9/32	24	603338	-	-	6	1-1/4	3/8	26	603388	24	603123
5	1	5/16	24	603339	22	603084	6	1-1/4	13/32	26	603389	-	-
5	1	11/32	24	603340	-	-	6	1-1/4	7/16	26	603390	24	603124
5	1	3/8	24	603341	22	603085	6	1-1/4	1/2	26	603391	24	603125
5	1	13/32	24	603342	-	-	6	1-1/4	9/16	26	603392	24	603126
5	1	7/16	24	603343	22	603086	6	1-1/4	5/8	26	603393	24	603127
5	1	1/2	24	603344	22	603087	6	1-1/4	11/16	26	603394	24	603128
5	1	9/16	24	603345	-	-	6	1-1/4	3/4	26	603395	24	603129
5	1	5/8	24	603346	22	603089	6	1-1/4	13/16	26	603396	-	-
5	1	11/16	24	603347	-	-	6	1-1/4	7/8	26	603397	24	603131
5	1	3/4	24	603348	22	603091	6	1-1/4	15/16	26	603398	24	603132
5	1	13/16	24	603349	-	-	6	1-1/4	1	26	603399	24	603133
5	1	7/8	24	603350	22	603093	6	1-1/4	1-1/8	26	603400	-	-
5	1	15/16	24	603351	-	-	6	1-1/4	1-1/4	26	603401	24	603136
5	1	1	24	603352	-	-	6	1-1/4	1-1/2	-	-	24	603137
5	1-1/4	1/4	24	603353	22	603094							
5	1-1/4	9/32	24	603354	-	-							

MILLING CUTTERS & SAWS



Metal Slitting Saws

High Speed Steel
With Side Chip Clearance
Plain & Staggered Tooth



Diameter (Inch)	Thickness (Inch)	Bore Diameter (Inch)	Plain		Staggered		Diameter (Inch)	Thickness (Inch)	Bore Diameter (Inch)	Plain		Staggered	
			No. of Teeth	Code	No. of Teeth	Code				No. of Teeth	Code	No. of Teeth	Code
2-1/2	3/32	7/8	28	602000	-	-	5	3/32	1	40	602017	-	-
2-1/2	1/8	7/8	28	602001	-	-	5	3/32	1-1/4	40	602018	-	-
3	5/64	1	32	602002	-	-	5	1/8	1	40	602019	-	-
3	3/32	1	32	602003	-	-	5	1/8	1-1/4	40	602020	38	602041
3	7/64	1	32	602004	-	-	5	5/32	1	40	602021	-	-
3	1/8	1	32	602005	32	602032	5	5/32	1-1/4	40	602022	-	-
3	9/64	1	32	602006	-	-	5	3/16	1	40	602023	38	602042
3	5/32	1	32	602007	32	602033	5	3/16	1-1/4	40	602024	38	602043
3	3/16	1	32	602008	32	602034	5	1/4	1	-	-	38	602044
3	1/4	1	-	-	32	602035	6	1/8	1	42	602025	-	-
3	7/32	1	32	602009	-	-	6	1/8	1-1/4	42	602026	42	602045
4	3/32	1	36	602010	-	-	6	5/32	1-1/4	-	-	42	602046
4	7/64	1	36	602011	-	-	6	3/16	1	42	602027	42	602047
4	1/8	1	36	602012	-	-	6	3/16	1-1/4	42	602028	42	602048
4	9/64	1	36	602013	34	602036	6	1/4	1	-	-	42	602049
4	5/32	1	36	602014	34	602037	6	1/4	1-1/4	-	-	42	602050
4	3/16	1	36	602015	34	602038	8	1/8	1-1/4	48	602029	-	-
4	3/16	1-1/4	36	602016	-	-	8	3/16	1-1/4	48	602030	50	602051
4	1/4	1	-	-	34	602039	8	1/4	1-1/4	48	602031	-	-
4	1/4	1-1/4	-	-	34	602040	10	1/4	1-1/4	-	-	50	602053

Plain Metal Slitting Saws

High Speed Steel



Diameter (Inch)	Width of Face (Inch)	Bore Diameter (Inch)	No. of Teeth	Code	Diameter (Inch)	Width of Face (Inch)	Bore Diameter (Inch)	No. of Teeth	Code	Diameter (Inch)	Width of Face (Inch)	Bore Diameter (Inch)	No. of Teeth	Code
2	1/16	1/2	28	602054	2-1/2	1/16	1	28	602062	3	1/8	1	30	602070
2	1/8	1/2	28	602055	3	1/64	1	30	602063	3	9/64	1	30	602071
2-1/2	3/64	3/8	28	602056	3	1/32	1	30	602064	3	5/32	1	30	602072
2-1/2	1/32	7/8	28	602057	3	3/64	1	30	602065	3	3/16	1	30	602073
2-1/2	3/64	7/8	28	602058	3	1/16	1	30	602066	3-1/2	1/32	1	30	602074
2-1/2	1/16	7/8	28	602059	3	5/64	1	30	602067	3-1/2	3/64	1	30	602075
2-1/2	3/32	7/8	28	602060	3	3/32	1	30	602068	3-1/2	1/16	1	30	602076
2-1/2	1/8	7/8	28	602061	3	7/64	1	30	602069	3-1/2	3/32	1	30	602077

Plain Metal Slitting Saws

High Speed Steel (continued)

Diameter (Inch)	Width of Face (Inch)	Bore Diameter (Inch)	No. of Teeth	Code	Diameter (Inch)	Width of Face (Inch)	Bore Diameter (Inch)	No. of Teeth	Code	Diameter (Inch)	Width of Face (Inch)	Bore Diameter (Inch)	No. of Teeth	Code
3-1/2	1/8	1	30	602078	5	3/64	1	40	602096	6	7/64	1	42	602114
3-1/2	3/16	1	30	602079	5	1/16	1	40	602097	6	1/8	1	42	602115
4	1/64	1	36	602080	5	5/64	1	40	602098	6	9/64	1	42	602116
4	1/32	1	36	602081	5	3/32	1	40	602099	6	5/32	1	42	602117
4	3/64	1	36	602082	5	7/64	1	40	602100	6	3/16	1	42	602118
4	1/16	1	36	602083	5	1/8	1	40	602101	6	1/16	1-1/4	42	602119
4	5/64	1	36	602084	5	9/64	1	40	602102	6	1/8	1-1/4	42	602121
4	3/32	1	36	602085	5	5/32	1	40	602103	6	5/32	1-1/4	42	602122
4	7/64	1	36	602086	5	3/16	1	40	602104	8	1/8	1	48	602124
4	1/8	1	36	602087	5	1/16	1-1/4	40	602105	8	3/16	1	48	602125
4	9/64	1	36	602088	5	3/32	1-1/4	40	602106	8	3/32	1-1/4	48	602126
4	5/32	1	36	602089	5	1/8	1-1/4	40	602107	8	1/8	1-1/4	48	602127
4	3/16	1	36	602090	5	5/32	1-1/4	40	602108	8	3/16	1-1/4	48	602128
4-1/2	1/32	1	36	602091	5	3/16	1-1/4	40	602109	10	1/8	1-1/4	56	602129
4-1/2	3/64	1	36	602092	6	3/64	1	42	602110	10	3/16	1-1/4	56	602130
4-1/2	1/16	1	36	602093	6	1/16	1	42	602111	10	3/32	1-1/4	56	602131
4-1/2	3/32	1	36	602094	6	5/64	1	42	602112	10	1/4	1-1/4	56	602132
4-1/2	1/8	1	36	602095	6	3/32	1	42	602113					

Slotting Saws

High Speed Steel – Jeweler's Type – Ground Teeth & Sides

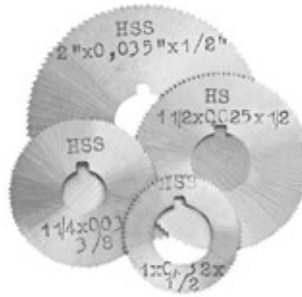

- For slotting very thin material, or cutting wire, thin tubing, extrusions, etc.

Diameter (Inch)	Width of Face (Inch)	Hole Size (Inch)	No. of Teeth	Code	Diameter (Inch)	Width of Face (Inch)	Hole Size (Inch)	No. of Teeth	Code	Diameter (Inch)	Width of Face (Inch)	Hole Size (Inch)	No. of Teeth	Code
1	0.032	3/8	76	602133	1-1/2	0.023	1/2	110	602151	2	0.025	1/2	152	602169
1	0.025	3/8	76	602134	1-1/2	0.020	1/2	110	602152	2	0.020	1/2	152	602170
1	0.020	3/8	76	602135	1-1/2	0.016	1/2	110	602153	2	0.018	1/2	152	602171
1	0.018	3/8	76	602136	1-1/2	0.012	1/2	140	602154	2	0.014	1/2	152	602172
1	0.014	3/8	76	602137	1-1/2	0.010	1/2	140	602155	2	0.012	1/2	190	602173
1	0.012	3/8	98	602138	1-1/2	0.008	1/2	140	602156	2	0.010	1/2	190	602174
1	0.010	3/8	98	602139	1-3/4	0.032	1/2	132	602157	2	0.008	1/2	190	602175
1	0.008	3/8	98	602140	1-3/4	0.025	1/2	132	602158	2-1/2	0.051	1/2	140	602176
1-1/4	0.032	3/8	98	602141	1-3/4	0.020	1/2	132	602159	2-1/2	0.045	1/2	140	602177
1-1/4	0.025	3/8	98	602142	1-3/4	0.016	1/2	132	602160	2-1/2	0.040	1/2	140	602178
1-1/4	0.020	3/8	98	602143	1-3/4	0.014	1/2	132	602161	2-1/2	0.032	1/2	140	602179
1-1/4	0.016	3/8	98	602144	1-3/4	0.012	1/2	160	602162	2-1/2	0.025	1/2	190	602180
1-1/4	0.014	3/8	98	602145	1-3/4	0.010	1/2	160	602163	2-1/2	0.020	1/2	190	602181
1-1/4	0.012	3/8	120	602146	1-3/4	0.008	1/2	160	602164	2-1/2	0.016	1/2	190	602182
1-1/4	0.010	3/8	120	602147	2	0.057	1/2	110	602165	2-1/2	0.012	1/2	240	602183
1-1/4	0.008	3/8	120	602148	2	0.051	1/2	110	602166	2-1/2	0.010	1/2	240	602184
1-1/2	0.032	1/2	110	602149	2	0.045	1/2	110	602167	3	0.057	1/2	168	602185
1-1/2	0.025	1/2	110	602150	2	0.032	1/2	110	602168	3	0.057	1	168	602186

Slotting Saws

High Speed Steel – Jeweler’s Type – Ground Teeth & Sides (continued)

Diameter (Inch)	Width of Face (Inch)	Hole Size (Inch)	No. of Teeth	Code	Diameter (Inch)	Width of Face (Inch)	Hole Size (Inch)	No. of Teeth	Code	Diameter (Inch)	Width of Face (Inch)	Hole Size (Inch)	No. of Teeth	Code
3	0.045	1/2	168	602187	3	0.012	1/2	280	602205	5	0.040	1	280	602228
3	0.045	1	168	602188	3	0.010	1/2	280	602207	5	0.032	1/2	280	602229
3	0.040	1/2	168	602189	4	0.051	1/2	220	602211	5	0.032	1	280	602230
3	0.040	1	168	602190	4	0.045	1	220	602213	5	0.025	1/2	380	602231
3	0.032	1/2	168	602191	4	0.040	1	220	602215	5	0.025	1	380	602232
3	0.032	1	168	602192	4	0.020	1/2	310	602218	6	0.102	1	232	602233
3	0.025	1/2	230	602193	4	0.018	1/2	310	602220	6	0.091	1	232	602234
3	0.025	1	230	602194	4	0.018	1	310	602221	6	0.081	1	232	602235
3	0.023	1/2	230	602195	4	0.016	1/2	310	602222	6	0.072	1	232	602236
3	0.023	1	230	602196	4	0.016	1	310	602223	6	0.064	1	232	602237
3	0.020	1/2	230	602197	5	0.064	1	280	602224	6	0.057	1	232	602238
3	0.020	1	230	602198	5	0.057	1	280	602225	6	0.051	1/2	232	602239
3	0.018	1/2	230	602199	5	0.051	1	280	602226	6	0.051	1	232	602240
3	0.016	1/2	230	602201	5	0.045	1	280	602227	6	0.045	1	340	602241
										6	0.040	1	340	602242
										6	0.035	1	340	602243

Screw Slotting Saws

High Speed Steel – 56, 60, 72 & 90 Teeth



TOLERANCES:
 Outside diameter ±0.015"
 Hole diameter ±0.001"
 Width ±0.001"

Diameter (Inch)	Width of Face (Inch)	Hole Size (Inch)	No. of Teeth	Code	Diameter (Inch)	Width of Face (Inch)	Hole Size (Inch)	No. of Teeth	Code	Diameter (Inch)	Width of Face (Inch)	Hole Size (Inch)	No. of Teeth	Code
1-3/4	0.010	1/2	90	602244	2-1/4	0.014	5/8	60	602268	2-3/4	0.025	3/4	72	602292
1-3/4	0.013	1/2	90	602245	2-1/4	0.016	5/8	60	602269	2-3/4	0.028	3/4	72	602293
1-3/4	0.020	1/2	90	602246	2-1/4	0.018	5/8	60	602270	2-3/4	0.032	3/4	72	602294
1-3/4	0.008	5/8	90	602247	2-1/4	0.020	5/8	60	602271	2-3/4	0.036	3/4	72	602295
1-3/4	0.010	5/8	90	602248	2-1/4	0.023	5/8	60	602272	2-3/4	0.040	3/4	72	602296
1-3/4	0.012	5/8	90	602249	2-1/4	0.025	5/8	60	602273	2-3/4	0.045	3/4	72	602297
1-3/4	0.014	5/8	90	602250	2-1/4	0.028	5/8	60	602274	2-3/4	0.051	3/4	72	602298
1-3/4	0.016	5/8	90	602251	2-1/4	0.032	5/8	60	602275	2-3/4	0.057	3/4	72	602299
1-3/4	0.018	5/8	90	602252	2-1/4	0.036	5/8	60	602276	2-3/4	0.064	3/4	72	602300
1-3/4	0.020	5/8	90	602253	2-1/4	0.040	5/8	60	602277	2-3/4	0.072	3/4	72	602301
1-3/4	0.023	5/8	90	602254	2-1/4	0.045	5/8	60	602278	2-3/4	0.081	3/4	72	602302
1-3/4	0.025	5/8	90	602255	2-1/4	0.051	5/8	60	602279	2-3/4	0.091	3/4	72	602303
1-3/4	0.028	5/8	90	602256	2-1/4	0.057	5/8	60	602280	2-3/4	0.102	3/4	72	602304
1-3/4	0.032	5/8	90	602257	2-1/4	0.064	5/8	60	602281	2-3/4	0.162	3/4	72	602307
1-3/4	0.036	5/8	90	602258	2-1/4	0.072	5/8	60	602282	2-3/4	0.182	3/4	72	602308
1-3/4	0.040	5/8	90	602259	2-1/4	0.081	5/8	60	602283	2-3/4	0.010	1	72	602309
1-3/4	0.045	5/8	90	602260	2-1/4	0.091	5/8	60	602284	2-3/4	0.013	1	72	602311
1-3/4	0.051	5/8	90	602261	2-1/4	0.102	5/8	60	602285	2-3/4	0.014	1	72	602312
1-3/4	0.057	5/8	90	602262	2-3/4	0.010	3/4	72	602286	2-3/4	0.016	1	72	602313
1-3/4	0.064	5/8	90	602263	2-3/4	0.012	3/4	72	602287	2-3/4	0.018	1	72	602314
1-3/4	0.072	5/8	90	602264	2-3/4	0.016	3/4	72	602288	2-3/4	0.020	1	72	602315
2-1/4	0.008	5/8	60	602265	2-3/4	0.018	3/4	72	602289	2-3/4	0.023	1	72	602316
2-1/4	0.010	5/8	60	602266	2-3/4	0.020	3/4	72	602290	2-3/4	0.025	1	72	602317
2-1/4	0.012	5/8	60	602267	2-3/4	0.023	3/4	72	602291	2-3/4	0.028	1	72	602318

Screw Slotting Saws

High Speed Steel – 56, 60, 72 & 90 Teeth (continued)

Diameter (Inch)	Width of Face (Inch)	Hole Size (Inch)	No. of Teeth	Code	Diameter (Inch)	Width of Face (Inch)	Hole Size (Inch)	No. of Teeth	Code	Diameter (Inch)	Width of Face (Inch)	Hole Size (Inch)	No. of Teeth	Code
2-3/4	0.032	1	72	602319	2-3/4	0.144	1	72	602333	2-3/4	0.036	1	56	602347
2-3/4	0.035	1	72	602320	2-3/4	0.162	1	72	602334	2-3/4	0.040	1	56	602348
2-3/4	0.036	1	72	602321	2-3/4	0.182	1	72	602335	2-3/4	0.045	1	56	602349
2-3/4	0.040	1	72	602322	2-3/4	0.010	1	56	602336	2-3/4	0.051	1	56	602350
2-3/4	0.045	1	72	602323	2-3/4	0.012	1	56	602337	2-3/4	0.057	1	56	602351
2-3/4	0.051	1	72	602324	2-3/4	0.013	1	56	602338	2-3/4	0.064	1	56	602352
2-3/4	0.057	1	72	602325	2-3/4	0.014	1	56	602339	2-3/4	0.072	1	56	602353
2-3/4	0.064	1	72	602326	2-3/4	0.016	1	56	602340	2-3/4	0.081	1	56	602354
2-3/4	0.072	1	72	602327	2-3/4	0.018	1	56	602341	2-3/4	0.091	1	56	602355
2-3/4	0.081	1	72	602328	2-3/4	0.020	1	56	602342	2-3/4	0.102	1	56	602356
2-3/4	0.091	1	72	602329	2-3/4	0.023	1	56	602343	2-3/4	0.114	1	56	602357
2-3/4	0.102	1	72	602330	2-3/4	0.025	1	56	602344	2-3/4	0.144	1	56	602359
2-3/4	0.114	1	72	602331	2-3/4	0.028	1	56	602345					
2-3/4	0.128	1	72	602332	2-3/4	0.032	1	56	602346					

Saw Arbors

Slitting & Slotting Saws

- Hardened and precisely ground
- Rigid arbors with extended length can reach areas that standard short arbors cannot
- Each arbor is ground for precision within 0.002" on diameter
- Super low profile cup allows cutter to get closer to working area
- Plug style cup gives extra support and rigidity when working with larger diameter saws

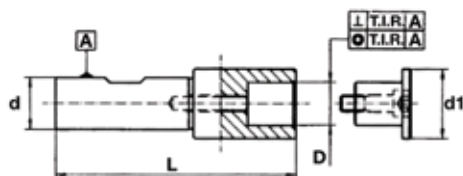

0.002" T.I.R.



MILLING CUTTERS & SAWS

d Shank Diameter (Inch)	D Hole Size (Inch)	d1 (Inch)	L (Inch)	Code
0.500	0.250	0.500	2.700	602362
0.500	0.375	0.625	2.880	602363
0.500	0.500	0.750	3.070	602364

d Shank Diameter (Inch)	D Hole Size (Inch)	d1 (Inch)	L (Inch)	Code
SETS – 3 Pieces – Sizes 0.250", 0.375" and 0.500"				602365
0.750	0.625	1.000	3.530	602366
0.750	1.000	1.500	3.780	602367
0.750	1.250	1.750	4.030	602368
SETS – 3 Pieces – Sizes 0.625", 0.375" and 1.250"				602369



Weldon & R8 Shanks

- Rigid and precision design
- This versatile arbor offers flexibility in sawing operations
- The spring loaded mechanism accepts saw blades with hole diameters from 1/2" to 1"
- The saw blades are firmly secured in position with a hex socket screw
- Rust resistant, black oxide finish
- Arbors are provided with one hex wrench and one screw

Shank Size	Inside Hole Diameters (Inch)	Overall Length (Inch)	Code
1/2" Weldon	1/2, 5/8, 3/4, 7/8, 1	2-9/16	41710
R8	1/2, 5/8, 3/4, 7/8, 1	5-3/32	602378

STUB ARBOR ADAPTERS ON PAGE 405



Woodruff Keyseat Cutters

High Speed Steel

1/2" Shanks

Straight & Staggered Tooth



American Standard	Diameter (Inch)	Face Width (Inch)	Straight Tooth	Staggered Tooth	American Standard	Diameter (Inch)	Face Width (Inch)	Straight Tooth	Staggered Tooth
			Code	Code				Code	Code
202	1/4	1/16	603529	603570	608	1	3/16	603549	603590
202-1/2	5/16	1/16	603530	603571	708	1	7/32	603550	603591
302-1/2	5/16	3/32	603531	603572	1208	1	3/8	603551	603592
203	3/8	1/16	603532	603573	609	1-1/8	3/16	603552	603593
303	3/8	3/32	603533	603574	807	7/8	1/4	603553	603594
403	3/8	1/8	603534	603575	808	1	1/4	603554	603595
204	1/2	1/16	603535	603576	709	1-1/8	7/32	603555	603596
304	1/2	3/32	603536	603577	809	1-1/8	1/4	603556	603597
305	5/8	3/32	603537	603578	610	1-1/4	3/16	603557	603598
404	1/2	1/8	603538	603579	710	1-1/4	7/32	603558	603599
405	5/8	1/8	603539	603580	810	1-1/4	1/4	603559	603600
406	3/4	1/8	603540	603581	811	1-3/8	1/4	603560	603601
505	5/8	5/32	603541	603582	812	1-1/2	1/4	603561	603602
605	5/8	3/16	603542	603583	1008	1	5/16	603562	603603
506	3/4	5/32	603543	603584	1009	1-1/8	5/16	603563	603604
806	3/4	1/4	603544	603585	1010	1-1/4	5/16	603564	603605
507	7/8	5/32	603545	603586	1011	1-3/8	5/16	603565	603606
606	3/4	3/16	603546	603587	1012	1-1/2	5/16	603566	603607
607	7/8	3/16	603547	603588	1210	1-1/4	3/8	603567	603608
707	7/8	7/32	603548	603589	1211	1-3/8	3/8	603568	603609
					1212	1-1/2	3/8	603569	603610

Slotting Cutters

Cobalt M42 – Staggered Tooth – Weldon Shank



- Used for a wide variety of slotting and milling operations in both ferrous and nonferrous materials
- For use on manual and CNC machines
- M42 cobalt for difficult-to-machine materials

Cutter Diameter (Inch)	Cutter Width (Inch)	Shank Diameter (Inch)	No. of Teeth	Overall Length (Inch)	Code	Cutter Diameter (Inch)	Cutter Width (Inch)	Shank Diameter (Inch)	No. of Teeth	Overall Length (Inch)	Code
1	1/8	5/8	8	4-15/16	546101	2	3/16	1	10	5-11/16	546115
1	3/16	5/8	8	4-15/16	546102	2	1/4	1	10	5-11/16	546116
1	1/4	5/8	8	4-15/16	546103	2	5/16	1	10	5-11/16	546117
1	5/16	5/8	8	4-15/16	546104	2	3/8	1	10	5-11/16	546118
1	3/8	5/8	8	4-15/16	546105	2	1/2	1	10	5-11/16	546119
1	1/2	5/8	8	4-15/16	546106	2	5/8	1	10	5-11/16	546120
1	5/8	5/8	8	4-15/16	546107	2	3/4	1	10	5-11/16	546121
1-1/2	1/8	1	8	5-5/16	546108	2-1/2	1/4	1	12	6-5/8	546122
1-1/2	3/16	1	8	5-5/16	546109	2-1/2	5/16	1	12	6-5/8	546123
1-1/2	1/4	1	8	5-5/16	546110	2-1/2	3/8	1	12	6-5/8	546124
1-1/2	5/16	1	8	5-5/16	546111	2-1/2	1/2	1	12	6-5/8	546125
1-1/2	3/8	1	8	5-5/16	546112	2-1/2	5/8	1	12	6-5/8	546126
1-1/2	1/2	1	8	5-5/16	546113	2-1/2	3/4	1	12	6-5/8	546127
1-1/2	5/8	1	8	5-5/16	546114	2-1/2	7/8	1	12	6-5/8	546128
						2-1/2	1	1	12	6-5/8	546129



T-Slot Cutters

Cobalt – Staggered Tooth & Roughers

- Right hand cut
- Regular length
- Weldon shank



Bolt Size (Inch)	Cutter Diameter (Inch)	Cutter Thickness (Inch)	Neck Diameter (Inch)	Overall Length (Inch)	Shank Diameter (Inch)	Staggered Tooth	Rougher
						Code	Code
1/4	9/16	15/64	17/64	2-19/32	1/2	603836	-
5/16	21/32	17/64	21/64	2-11/16	1/2	603837	-
3/8	25/32	21/64	13/32	3-1/4	3/4	603838	-
1/2	31/32	25/64	17/32	3-7/16	3/4	603839	603845
5/8	1-1/4	31/64	21/32	3-15/16	1	603840	603846
3/4	1-15/32	5/8	25/32	4-7/16	1	603841	603847
1	1-27/32	53/64	1-1/32	4-13/16	1-1/4	603842	603848
1-1/4	2-7/32	1-3/32	1-9/32	5-3/8	1-1/4	603843	603849
1-1/2	2-21/32	1-11/32	1-17/32	5-29/32	1-1/4	603844	603850

Corner Rounding End Mills

High Speed Steel & Cobalt – 4 Flute



- Right hand cut
- Regular length
- Weldon shank



Radius (Inch)	Shank Diameter (Inch)	HSS	Cobalt	Radius (Inch)	Shank Diameter (Inch)	HSS	Cobalt	Radius (Inch)	Shank Diameter (Inch)	HSS	Cobalt
		Code	Code			Code	Code			Code	Code
1/32	3/8	513201	-	*1/4	1/2	513217	516517	1/2	1	513233	516533
*1/16	3/8	513203	516503	1/4	3/4	513219	516519	5/8	3/4	513235	516535
*3/32	3/8	513205	516505	*5/16	1/2	513221	516521	5/8	1	513237	516537
*1/8	1/2	513207	516507	5/16	3/4	513223	516523	3/4	1	513239	516539
*5/32	1/2	513209	516509	*3/8	1/2	513225	516525	7/8	1	513241	-
*3/16	1/2	513211	516511	3/8	3/4	513227	516527	1	1	513243	-
3/16	3/4	513213	516513	7/16	3/4	513229	516529	SETS - *8 Pieces Wooden Block		513245	516545
7/32	1/2	513215	-	1/2	3/4	513231	516531				

MILLING CUTTERS & SAWS

Rounding Cutters

High Speed Steel

Concave



Convex



Radius (Inch)	Shank Diameter (Inch)	Overall Length (Inch)	Cutter Diameter (Inch)	No. of Flutes	Code
1/32	1/2	3	3/4	6	603851
1/16	1/2	3	3/4	6	603852
3/32	1/2	3	3/4	6	603853
1/8	3/4	3-1/2	1	6	603854
5/32	3/4	3-1/2	1	6	603855
3/16	3/4	3-1/2	1	6	603856
1/4	3/4	4	1-1/4	4	603857
5/16	3/4	4	1-1/4	4	603858
3/8	3/4	4-3/16	1-1/2	4	603859

Radius (Inch)	Shank Diameter (Inch)	Overall Length (Inch)	Cutter Diameter (Inch)	No. of Flutes	Code
1/32	1/2	3	3/4	6	603860
1/16	1/2	3	3/4	6	603861
3/32	1/2	3	7/8	6	603862
1/8	3/4	3-1/2	1-1/4	6	603863
5/32	3/4	3-1/2	1-5/16	6	603864
3/16	3/4	3-1/2	1-3/8	6	603865
1/4	3/4	4	1-1/2	6	603866
5/16	3/4	4	1-5/8	6	603867
3/8	3/4	4	1-3/4	6	603868

Angle Cutters – Chamfering

High Speed Steel – Multi Flute – 45° & 60° Angles



Cutter Diameter (Inch)	Cutter Width (Inch)	Shank Diameter (Inch)	Overall Length (Inch)	Angle	Code	Cutter Diameter (Inch)	Cutter Width (Inch)	Shank Diameter (Inch)	Overall Length (Inch)	Angle	Code
1/2	1/8	3/8	2-1/8	45°	603711	1/2	7/32	3/8	2-1/8	60°	603715
3/4	3/16	3/8	2-1/8	45°	603712	3/4	5/16	3/8	2-1/8	60°	603716
1	5/16	1/2	2-1/2	45°	603713	1	7/16	1/2	2-1/2	60°	603717
1-1/2	1/2	3/4	2-3/4	45°	603714	1-1/2	5/8	3/4	2-3/4	60°	603718

Angle Cutters – Dovetail

High Speed Steel & Cobalt – 45° & 60° Angles

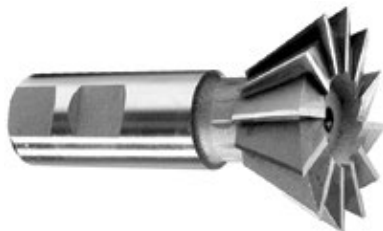

Cutter Diameter (Inch)	Shank Diameter (Inch)	Angle	HSS	Cobalt	Cutter Diameter (Inch)	Shank Diameter (Inch)	Angle	HSS	Cobalt
			Code	Code				Code	Code
3/8	3/8	45°	525200	525220	3/8	3/8	60°	525190	525210
1/2	3/8	45°	525201	525221	1/2	3/8	60°	525191	525211
3/4	3/8	45°	525202	525222	3/4	3/8	60°	525192	525212
1-3/8	5/8	45°	525203	525223	1-3/8	5/8	60°	525193	525213
1-7/8	7/8	45°	525204	525224	1-7/8	7/8	60°	525194	525214
2-1/4	1	45°	525205	525225	2-1/4	1	60°	525195	525215

Angle Cutters – Double Angle

High Speed Steel – Right Hand Cut – 60° & 90° Included Angles



Cutter Diameter (Inch)	Shank Diameter (Inch)	Overall Length (Inch)	Cutter Thickness (Inch)	Included Angle	Code	Cutter Diameter (Inch)	Shank Diameter (Inch)	Overall Length (Inch)	Cutter Thickness (Inch)	Included Angle	Code
3/4	3/8	2-3/8	3/16	60°	603869	2-1/4	3/4	3-1/8	1/2	60°	603875
1	1/2	2-27/32	5/16	60°	603870	3/4	3/8	2-7/16	1/4	90°	603876
1-3/8	5/8	3-7/32	7/16	60°	603871	1	1/2	2-29/32	3/8	90°	603877
1-1/2	5/8	3-3/8	1/2	60°	603872	1-3/8	5/8	3-9/32	1/2	90°	603878
1-7/8	3/4	3-25/32	5/8	60°	603873	1-1/2	5/8	3-7/16	9/16	90°	603879
2-1/4	7/8	4-5/32	3/4	60°	603874	1-7/8	3/4	3-25/32	5/8	90°	603880
						2-1/4	7/8	4-5/32	3/4	90°	603881
						2-1/4	3/4	3-1/8	1/2	90°	603882



Angle Cutters

High Speed Steel

Single Right Hand Cut & Double

45°. 60° & 90° Included Angles



Diameter (Inch)	Face Width (Inch)	Hole Diameter (Inch)	Included Angle	No. of Teeth	Single Cutter	Double Cutter
					Code	Code
2-1/2	1/2	7/8	45°	18	603611	-
2-1/2	1/2	7/8	60°	18	603612	-
2-3/4	1/2	1	45°	18	603613	603677
2-3/4	1/2	1	60°	18	603614	603678
2-3/4	1/2	1	90°	18	-	603679
3	1/2	1	45°	22	603615	-
3	1/2	1	60°	22	603616	-
3	1/2	1-1/4	45°	22	603617	-
3	1/2	1-1/4	60°	22	603618	-
3	5/8	1	45°	22	603619	603680
3	5/8	1	60°	22	603620	603681
3	5/8	1	90°	22	-	603682
3	5/8	1-1/4	45°	22	603621	-
3	5/8	1-1/4	60°	22	603622	-
3	3/4	1	45°	22	603623	-
3	3/4	1	60°	22	603624	603683
3	3/4	1	90°	22	-	603684
3	3/4	1-1/4	60°	22	603625	-
4	1/2	1	45°	26	603626	-
4	1/2	1	60°	26	603627	-

Diameter (Inch)	Face Width (Inch)	Hole Diameter (Inch)	Included Angle	No. of Teeth	Single Cutter	Double Cutter
					Code	Code
4	1/2	1-1/4	45°	26	603628	603685
4	1/2	1-1/4	60°	26	603629	603686
4	1/2	1-1/4	90°	26	-	603687
4	3/4	1	45°	26	603630	603688
4	3/4	1	60°	26	603631	603689
4	3/4	1	90°	26	-	603690
4	3/4	1-1/4	45°	26	603632	603691
4	3/4	1-1/4	60°	26	603633	603692
4	3/4	1-1/4	90°	26	-	603693
4	1	1-1/4	45°	26	603634	-
4	1	1-1/4	60°	26	603635	603694
4	1	1-1/4	90°	26	-	603695
5	3/4	1-1/4	45°	28	603636	603696
5	3/4	1-1/4	60°	28	603637	603697
5	3/4	1-1/4	90°	28	-	603698
5	1	1-1/4	45°	28	603638	603699
5	1	1-1/4	60°	28	603639	603700
6	3/4	1-1/4	45°	30	603640	603702
6	3/4	1-1/4	60°	30	603641	-
6	1	1-1/4	45°	30	603642	-
6	1	1-1/4	60°	30	603643	-

Boring Bars – Boring & Chamfering



High Speed Steel & Carbide

2 Piece Style ASB

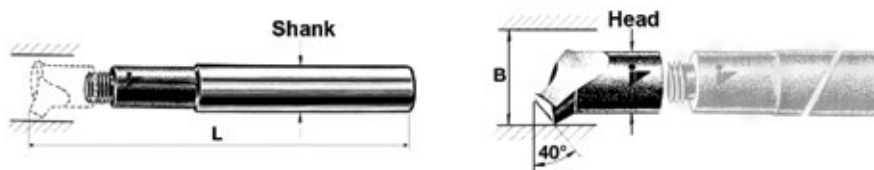

Head and shank sold separately

Tool No.	B Minimum Bore (mm)	S Shank Diameter (mm)	HSS Head		Carbide Head		Shank Code
			L Length (mm)	Code	L Length (mm)	Code	
3	17	10	-	-	-	-	500202
3	17	12	200	500007	200	500034	500203
4	21	13	230	500008	230	500035	500204
5	24	15	260	500009	260	500036	500205
6	28	17	280	500010	280	500037	500206
7	31	19	310	500011	310	500038	500207
8	34	20	330	500012	330	500039	500208
9	37	22	360	500013	360	500040	500209
10	42	25	390	500014	390	500041	500210
11	50	30	430	500015	430	500042	500211
12	60	35	500	500016	500	500043	500212

Boring Bars – Boring & Facing



High Speed Steel & Carbide

Single Piece Style ECS



Tool No.	B Minimum Bore (mm)	S Shank Diameter (mm)	HSS Regular Length		HSS Long Length		Carbide	
			L Length (mm)	Code	L Length (mm)	Code	L Length (mm)	Code
0000	3.5	8	45	500051	52	500070	45	500078
000	4.5	8	49	500052	58	500071	49	500079
00	5.5	8	52	500053	64	500072	64	500080
0	7	8	56	500054	69	500073	69	500081
1	11	8	65	500055	82	500074	82	500082
2	13	8	72	500056	100	500075	72	500083

Boring Bars – Boring & Facing (continued)



High Speed Steel & Carbide

2 Piece Style ECS



Head and shank sold separately

Tool No.	B Minimum Bore (mm)	S Shank Diameter (mm)	HSS Head		Carbide Head		Shank
			L Length (mm)	Code	L Length (mm)	Code	Code
3	17	10	-	-	-	-	500202
3	17	12	-	-	-	-	500203
4	21	13	230	500058	230	500085	500204
5	24	15	260	500059	260	500086	500205
6	28	17	280	500060	280	500087	500206
7	31	19	310	500061	310	500088	500207
8	34	20	330	500062	330	500089	500208
9	37	22	360	500063	360	500090	500209
10	42	25	390	500064	390	500091	500210
11	50	30	430	500065	430	500092	500211
12	60	35	500	500066	500	500093	500212

Threading Bars – 60° Threading



High Speed Steel & Carbide

Single Piece Style GWS

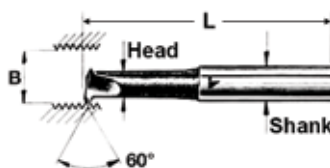

Tool No.	B Minimum Bore (mm)	S Shank Diameter (mm)	HSS Regular Length		HSS Long Length		Carbide	
			L Length (mm)	Code	L Length (mm)	Code	L Length (mm)	Code
000	5	8	46	500102	59	500122	46	500129
00	6.5	8	50	500103	64	500123	50	500130
0	9	8	52	500104	-	-	64	500131
1	11	8	56	500105	70	500124	70	500132
2	13	8	64	500106	80	500125	80	500133

BORING BARS

Threading Bars – 60° Threading (continued)



High Speed Steel & Carbide

2 Piece Style GWS

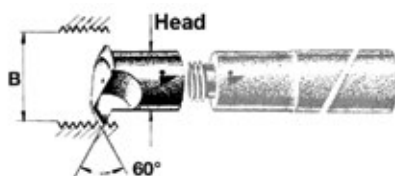

Head and shank sold separately

Tool No.	B Minimum Bore (mm)	S Shank Diameter (mm)	HSS Head		Carbide Head		Shank
			L Length (mm)	Code	L Length (mm)	Code	Code
3	17	10	–	–	–	–	500202
3	17	12	–	–	–	–	500203
4	21	13	230	500108	230	500135	500204
5	24	15	260	500109	260	500136	500205
6	28	17	280	500110	280	500137	500206
7	31	19	310	500111	310	500138	500207
8	34	20	330	500112	330	500139	500208
9	37	22	360	500113	360	500140	500209
10	42	25	390	500114	390	500141	500210
11	50	30	430	500115	430	500142	500211

Grooving Bars – Thread Relieving Tools



High Speed Steel

Single Piece Style GRS

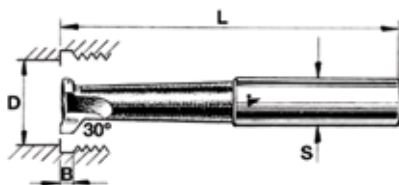

Tool No.	D Minimum Bore (mm)	B Groove Width (mm)	S Shank Diameter (mm)	L Length (mm)	Code	Tool No.	D Minimum Bore (mm)	B Groove Width (mm)	S Shank Diameter (mm)	L Length (mm)	Code
00	6	1.5	8	50	500173	1	11	2	8	55	500175
0	8	1.8	8	50	500174	2	14	2	8	64	500176

Grooving Bars – Thread Relieving Tools *(continued)*

High Speed Steel

2 Piece Style GRS

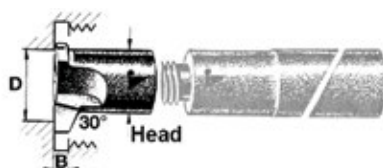

Head and shank sold separately

Tool No.	D Minimum Bore (mm)	B Groove Width (mm)	S Shank Diameter (mm)	L Length (mm)	Head	Shank
					Code	Code
3	17	2.5	10	100	500177	500202
4	21	2.7	13	230	500178	500204
5	24	3	15	260	500179	500205
6	28	3.5	17	280	500180	500206
7	31	4	19	310	500181	500207
8	34	4.5	20	330	500182	500208
10	42	5	25	390	500184	500210
11	50	5.5	30	430	500185	500211

Grooving Bars – Circlip Grooving Tools

High Speed Steel

Single Piece Style SEN

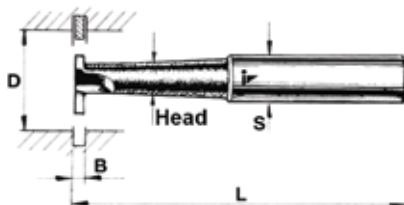

Tool No.	D Minimum Bore (mm)	B Groove Width (mm)	S Shank Diameter (mm)	L Length (mm)	Code	Tool No.	D Minimum Bore (mm)	B Groove Width (mm)	S Shank Diameter (mm)	L Length (mm)	Code
0	8	0.9	8	52	500197	1	10	1.1	8	55	500192

2 Piece Style SEN

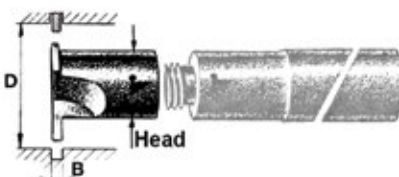

Head and shank sold separately

Tool No.	D Minimum Bore (mm)	B Groove Width (mm)	S Shank Diameter (mm)	L Length (mm)	Head	Shank
					Code	Code
3	17	1	10	100	500193	500202
4	23	1.2	13	230	-	500204
6	34	1.5	17	280	500195	500206
8	50	2	20	330	500196	500208

Grooving Bars – Groove Finishing Tools



High Speed Steel

Single Piece Style HAS

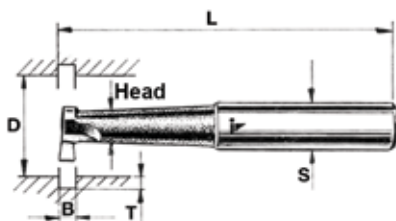

Tool No.	D Minimum Bore (mm)	B Groove Width (mm)	T Groove Depth (mm)	S Shank Diameter (mm)	L Length (mm)	Code
2	17	3.0	4	10	80	500186

Tool No.	D Minimum Bore (mm)	B Groove Width (mm)	T Groove Depth (mm)	S Shank Diameter (mm)	L Length (mm)	Code
3	21	3.5	6	10	80	500187

2 Piece Style HAS

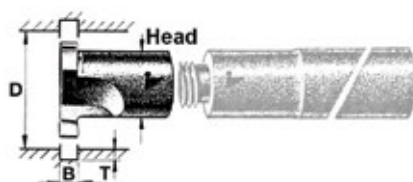

Head and shank sold separately

Tool No.	D Minimum Bore (mm)	B Groove Width (mm)	T Groove Depth (mm)	S Shank Diameter (mm)	L Length (mm)	Head	Shank
						Code	Code
4	25	4	7	13	230	500188	500204
6	34	5	10	17	280	500189	500206
8	40	6.5	11.5	20	330	500190	500208
10	48	8	13	25	390	500191	500210

Boring Bar Holders



Series KGI



Model	Shank Size (mm)	Bore Size (mm)	Code
KGI	16 x 16 x 125	8/10	500230
KGI-A	12 x 12 x 100	8	500231
KGI-B	14 x 10 x 100	8	500232

Series IDH

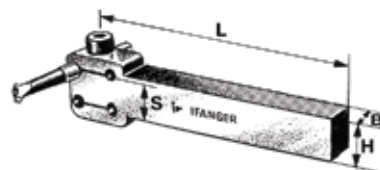

Model	Shank Size H x B x L (mm)	S (mm)	Bore Size (mm)	Code
IDH-A	13.2 x 21 x 150	13	8/10	500233
IDH-B	25.0 x 22 x 175	23	8/10	500234

Boring Bar Holders (continued)



Series IDH



Upper/Lower Support

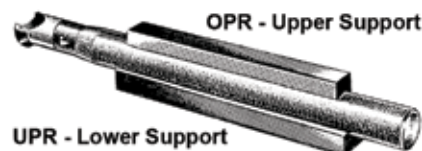

Model	Shank Size H x B x L (mm)	Bore Size (mm)	Code
IDH-C	20 x 10 x 100	8	500235

For B Bar Shank Diameter (mm)	OPR – Upper Support		UPR – Lower Support	
	Size (mm)	Code	Size (mm)	Code
8	8 x 10 x 50	500236	8 x 10 x 50	500239
10 - 20	8 x 14 x 100	500237	12 x 22 x 130	500240
20 - 30	8 x 14 x 150	500238	20 x 25 x 180	500241

Grooving Tools & Blades



High Speed Steel

Shanks

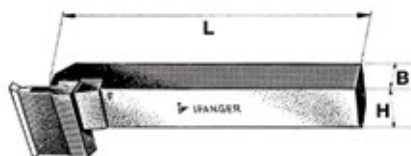

Blades

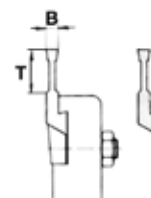

Tool No.	Size H x B x L (mm)	Code
1	16 x 12 x 110	500351
2	20 x 15 x 140	500352
3	25 x 18 x 160	500353
4	30 x 21 x 180	500354
5	36 x 25 x 200	500355

For Tool No.	B (mm)	Regular Length		Long Length	
		T (mm)	Code	T (mm)	Code
1	3	11	500361	16	500371
2	3.5	14	500362	19	500372
3	4	17	500363	24	500373
4	4.5	23.5	500364	33.5	500374
5	5.5	30	500365	40	500375

Threading Tools & Blades



High Speed Steel & Carbide

Shanks – Thread at 60°

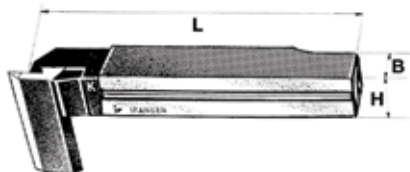

Blades

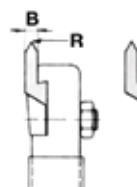

Tool No.	Size H x B x L (mm)	Code
0	16 x 12 x 100	500300
1	18 x 15 x 110	500301
2	20 x 18 x 140	500302
3	25 x 22 x 160	500303
4	32 x 25 x 180	500304
5	36 x 28 x 200	500305

For Tool No.	HSS Regular Width			Carbide Regular Width		HSS Extra Width		
	B (mm)	R (mm)	Code	B (mm)	Code	B (mm)	R (mm)	Code
1	2.5	0.07	500310	-	-	3.5	0.3	500320
2	3	0.1	500312	3.5	500332	4.5	0.35	500322
3	3.5	0.12	500313	4.5	500333	5.5	0.45	500323
4	4.5	0.2	500314	5.5	500334	6.5	0.6	500324
5	5.5	0.2	500315	6.5	500335	8.5	0.75	500325

BORING BARS



Boring Bar Sets

Cobalt

Shank Diameter (Inch)	No. of Bars	Minimum Bore (Inch)	Length of Cut (Inch)	Overall Length (Inch)	Code
1/2	10	1/4 – 1/2	3/4 – 2-1/2	2-1/8 – 3-7/8	513150
5/8	10	3/8 – 5/8	1-1/8 – 3-1/8	2-5/8 – 4-5/8	513162
3/4	14	3/8 – 3/4	1-1/8 – 3-3/4	2-7/8 – 5-1/2	513175

Boring Bars with Precision Ground Shanks

Alloy Steel – Carbide Tipped



- High quality alloy steel for greater rigidity
- Offset taper to provide greater rigidity at cutting point

3/8" Shank – C6 for Steel

Min. Diameter (Inch)	Length of Cut (Inch)	Overall Length (Inch)	Code	Min. Diameter (Inch)	Length of Cut (Inch)	Overall Length (Inch)	Code
5/16	3/4	2	617025	3/8	1-13/32	2-21/32	617029
5/16	1-1/8	2-3/8	617026	3/8	1-7/8	3-1/8	617030
5/16	1-1/2	2-3/4	617027	7/16	1-1/8	2-3/8	617031
3/8	1-15/16	2-3/16	617028	7/16	1-11/16	3-15/16	617032
				7/16	2-1/4	3-1/2	617033

1/2" Shank – C6 for Steel

Min. Diameter (Inch)	Length of Cut (Inch)	Overall Length (Inch)	Code	Min. Diameter (Inch)	Length of Cut (Inch)	Overall Length (Inch)	Code
5/16	3/4	2-1/4	617043	7/16	1-11/16	3-3/16	617047
5/16	1-1/8	2-5/8	617044	7/16	2-1/4	3-3/4	617048
5/16	1-1/2	3	617045	9/16	1-1/2	3	617049
7/16	1-1/8	2-5/8	617046	9/16	2-1/4	3-3/4	617050
				9/16	3	4-1/2	617051

5/8" Shank

C2 for Non-Ferrous – C6 for Steel

Minimum Diameter (Inch)	Length of Cut (Inch)	Overall Length (Inch)	C2	C6
			Code	Code
5/16	3/4	2-1/4	617052	617064
5/16	1-1/8	2-5/8	617053	617065
5/16	1-1/2	3	617054	617066
7/16	1-1/8	2-5/8	617055	617067
7/16	1-11/16	3-3/16	617056	617068
7/16	2-1/4	3-3/4	617057	617069
9/16	1-1/2	3	617058	617070
9/16	2-1/4	3-3/4	617059	617071
9/16	3	4-1/2	617060	617072
11/16	1-7/8	3-3/8	617061	617073
11/16	2-13/16	4-3/16	617062	617074
11/16	3-3/4	5-1/4	617063	617075

3/4" Shank

C2 for Non-Ferrous – C6 for Steel

Minimum Diameter (Inch)	Length of Cut (Inch)	Overall Length (Inch)	C2	C6
			Code	Code
7/16	1-1/8	3-1/8	617076	617088
7/16	1-11/16	3-11/16	617077	617089
7/16	2-1/4	4-1/4	617078	617090
9/16	1-1/2	3-1/2	617079	617091
9/16	2-1/4	4-1/4	617080	617092
9/16	3	5	617081	617093
11/16	1-7/8	3-7/8	617082	617094
11/16	2-13/16	4-13/16	617083	617095
11/16	3-3/4	5-3/4	617084	617096
13/16	2-1/4	4-1/4	617085	617097
13/16	3-3/8	5-3/8	617086	617098
13/16	4-1/2	6-1/2	617087	617099



Boring Bar Sets

Carbide Tipped

Shank Diameter (Inch)	No. of Pieces	Overall Length (Inch)	Minimum Bore (Inch)	Bore Depth (Inch)	Code
3/8	9	2 - 3-1/2	5/16 - 7/16	3/4 - 2-1/4	510405
1/2	9	2-1/4 - 4-1/2	5/16 - 9/16	3/4 - 3	510406
5/8	12	2-1/4 - 5-1/4	5/16 - 11/16	3/4 - 3-3/4	510407
3/4	12	3-1/8 - 6-1/2	7/16 - 13-16	1-1/8 - 4-1/2	510408
1	5	4 - 9-1/2	9/16 - 1-5/8	1-3/4 - 7-1/2	510409

Miniature Bores

Solid Carbide Stems with Steel Shanks



3/8" Shank

1/2" Shank

Minimum Bore (Inch)	Bore Depth (Inch)	Overall Length (Inch)	Code	Minimum Bore (Inch)	Bore Depth (Inch)	Overall Length (Inch)	Code
1/16	5/16	1-9/16	606250	1/16	5/16	1-13/16	606256
3/32	15/32	1-23/32	606251	3/32	15/32	1-15/16	606257
1/8	5/8	1-7/8	606252	1/8	5/8	2-1/8	606258
5/32	25/32	2-1/32	606253	5/32	25/32	2-1/4	606259
3/16	15/16	2-3/16	606254	3/16	15/16	2-7/16	606260
1/4	1-1/4	2-1/2	606255	1/4	1-1/4	2-13/16	606261

Boring Bars – Tool Bit Mounted

Single & Double Ended – 45° & 90°

- The tool bits are firmly held in place by a set screw
- These popular boring bars have precision broached holes that accept standard high speed, carbide, or stellite tool bits

Single End – 45°



Single End – 90°



Bar Diameter (Inch)	Overall Length (Inch)	Tool Bit (Inch)	Code	Bar Diameter (Inch)	Overall Length (Inch)	Tool Bit (Inch)	Code
3/8	3	3/16 sq.	513270	3/8	3	1/8 sq.	513280
1/2	4	3/16 sq.	513271	1/2	4	3/16 sq.	513281
5/8	5	1/4 sq.	513272	5/8	5	1/4 sq.	513282
3/4	5	1/4 sq.	513273	3/4	5	1/4 sq.	513283
3/4	7	1/4 sq.	513274	3/4	7	1/4 sq.	513284
1	8	5/16 sq.	513275	1	8	5/16 sq.	513285

Double End – 45° & 90°



Double End – 45° & 90° – 5 Piece Set

Bar Diameter (Inch)	Overall Length (Inch)	Tool Bit (Inch)	Code
3/8	6	3/16 sq.	513260
1/2	8	3/16 sq.	513261
5/8	10	1/4 sq.	513262
3/4	12	1/4 sq.	513263
1	16	5/16 sq.	513264
1-1/2	18	1/2 sq.	513266



Set Includes...	Code
513260	513268
513261	
513262	
513263	
513264	

BORING BARS

Keyway Broaches

High Speed Steel & TiN Coated



Broach Size	Broach Dimensions (Inch)	No. of Shims Included	Tooth Pitch (Inch)	No. of Teeth	Minimum Length of Cut (Inch)	Maximum Length of Cut (Inch)	HSS	TiN Coated
							Code	Code
1/16 A	1/8 x 5	0	3/16	18	13/64	1-1/8	605515	-
3/32 A	1/8 x 5	0	3/16	18	13/64	1-1/8	605516	605537
1/8 A	1/8 x 5	1	3/16	18	13/64	1-1/8	605517	605538
3/32 B	3/16 x 6-3/4	0	9/32	16	19/64	1-11/16	605518	605539
1/8 B	3/16 x 6-3/4	1	9/32	16	19/64	1-11/16	605519	605540
5/32 B	3/16 x 6-3/4	1	9/32	16	19/64	1-11/16	605520	605541
3/16 B	3/16 x 6-3/4	1	9/32	16	19/64	1-11/16	605521	605542
3/16 C	3/8 x 11-3/4	1	3/8	20	25/64	2-1/2	605522	605543
1/4 C	3/8 x 11-3/4	1	3/8	20	25/64	2-1/2	605523	605544
5/16 C	3/8 x 11-3/4	2	3/8	20	25/64	2-1/2	605524	605545
3/8 C	3/8 x 11-3/4	2	3/8	20	25/64	2-1/2	605525	605546
5/16 D	9/16 x 13-7/8	2	5/8	17	1	6	605526	605547
3/8 D	9/16 x 13-7/8	2	5/8	17	1	6	605527	605548
7/16 D	9/16 x 13-7/8	3	5/8	17	1	6	605528	605549
1/2 D	9/16 x 13-7/8	3	5/8	17	1	6	605529	605550
5/8 E	3/4 x 15-1/2	4	5/8	20	1	6	605530	605551
3/4 E	3/4 x 15-1/2	5	5/8	20	1	6	605531	605552
7/8 F	1 x 20-1/4	6	5/8	26	1	6	605532	605553
1 F	1 x 20-1/4	7	5/8	26	1	6	605533	605554
1-1/8	1-1/8 x 20-1/4	8	5/8	26	1	6	605534	-
1-1/4	1-1/4 x 20-1/4	9	3/4	22	1-1/2	8	605535	-

Broach Shims



Broach Size	Shim Thickness (Inch)	Code	Broach Size	Shim Thickness (Inch)	Code	Broach Size	Shim Thickness (Inch)	Code
1/8 A	0.0310	605555	5/16 C	0.0550	605561	5/8 E	0.0625	605567
1/8 B	0.0310	605556	3/8 C	0.0625	605562	3/4 E	0.0625	605568
5/32 B	0.0420	605557	5/16 D	0.0560	605563	7/8 F	0.0625	605569
3/16 B	0.0500	605558	3/8 D	0.0625	605564	1 F	0.0625	605570
3/16 C	0.0500	605559	7/16 D	0.0560	605565	1-1/8	0.0625	605571
1/4 C	0.0625	605560	1/2 D	0.0625	605566	1-1/4	0.0625	605572

Broach Bushings

Collared & Plain Types



Diameter (Inch)	Collared Bushings						Plain Bushings			
	A Bushings for A Broaches		B Bushings for B Broaches		C Bushings for C Broaches		D Bushings for D Broaches		E Bushings for E Broaches	
	Length (Inch)	Code	Length (Inch)	Code	Length (Inch)	Code	Length (Inch)	Code	Length (Inch)	Code
1/4	1-1/8	605573	-	-	-	-	-	-	-	-
5/16	1-1/8	605574	-	-	-	-	-	-	-	-
3/8	1-1/8	605575	-	-	-	-	-	-	-	-
7/16	1-1/8	605576	-	-	-	-	-	-	-	-
1/2	1-1/8	605577	1-11/16	605578	-	-	-	-	-	-
9/16	-	-	1-11/16	605579	-	-	-	-	-	-
5/8	-	-	1-11/16	605580	-	-	-	-	-	-
11/16	-	-	1-11/16	605581	-	-	-	-	-	-
3/4	-	-	1-11/16	605582	2-1/2	605585	-	-	-	-
13/16	-	-	1-11/16	605583	2-1/2	605586	-	-	-	-
7/8	-	-	1-11/16	605584	2-1/2	605587	-	-	-	-
15/16	-	-	-	-	2-1/2	605588	-	-	-	-
1	-	-	-	-	2-1/2	605589	-	-	-	-
1-1/16	-	-	-	-	2-1/2	605590	-	-	-	-
1-1/8	-	-	-	-	2-1/2	605591	-	-	-	-
1-3/16	-	-	-	-	2-1/2	605592	-	-	-	-
1-1/4	-	-	-	-	2-1/2	605593	-	-	-	-
1-5/16	-	-	-	-	2-1/2	605594	-	-	-	-
1-3/8	-	-	-	-	2-1/2	605595	-	-	-	-
1-7/16	-	-	-	-	2-1/2	605596	4	605599	-	-
1-1/2	-	-	-	-	2-1/2	605597	4	605600	-	-
1-9/16	-	-	-	-	2-1/2	605598	4	605601	-	-
1-5/8	-	-	-	-	-	-	4	605602	-	-
1-11/16	-	-	-	-	-	-	4	605603	-	-
1-3/4	-	-	-	-	-	-	4	605604	-	-
1-13/16	-	-	-	-	-	-	5	605605	-	-
1-7/8	-	-	-	-	-	-	5	605606	-	-
1-15/16	-	-	-	-	-	-	5	605607	-	-
2	-	-	-	-	-	-	5	605608	-	-
2-1/16	-	-	-	-	-	-	5	605609	-	-
2-1/8	-	-	-	-	-	-	5	605610	-	-
2-3/16	-	-	-	-	-	-	5	605611	-	-
2-1/4	-	-	-	-	-	-	5	605612	-	-
2-5/16	-	-	-	-	-	-	5	605613	6	605625
2-3/8	-	-	-	-	-	-	6	605614	6	605626
2-7/16	-	-	-	-	-	-	6	605615	6	605627
2-1/2	-	-	-	-	-	-	6	605616	6	605628
2-9/16	-	-	-	-	-	-	6	605617	6	605629
2-5/8	-	-	-	-	-	-	6	605618	6	605630
2-11/16	-	-	-	-	-	-	6	605619	6	605631
2-3/4	-	-	-	-	-	-	6	605620	6	605632
2-13/16	-	-	-	-	-	-	6	605621	6	605633
2-7/8	-	-	-	-	-	-	6	605622	6	605634
2-15/16	-	-	-	-	-	-	6	605623	6	605635
3	-	-	-	-	-	-	6	605624	6	605636

BROACHES

Metric Keyway Broaches

High Speed Steel & TiN Coated



Keyway Width (mm)	Broach Dimensions (Inch)	Standard Keys (mm)	No. of Shims Included	Tooth Pitch (Inch)	Minimum Length of Cut (Inch)	Maximum Length of Cut (Inch)	HSS	TiN Coated
							Code	Code
2 A	1/8 x 5	2 x 2	0	3/16	13/64	1-1/8	605637	605653
3 A	1/8 x 5	3 x 3	1	3/16	13/64	1-1/8	605638	605654
4 BI	1/4 x 6-3/4	4 x 4	1	9/32	19/64	1-11/16	605639	605655
5 BI	1/4 x 6-3/4	5 x 5	1	9/32	19/64	1-11/16	605640	605656
5 C	3/8 x 11-3/4	5 x 5	1	3/8	25/64	2-1/2	605641	605657
6 C	3/8 x 11-3/4	6 x 6	1	3/8	25/64	2-1/2	605642	605658
8 C	3/8 x 11-3/4	8 x 7	2	3/8	25/64	2-1/2	605643	605659
10 D	9/16 x 13-7/8	10 x 8	2	5/8	1	6	605644	605660
12 D	9/16 x 13-7/8	12 x 8	2	5/8	1	6	605645	605661
14 D	9/16 x 13-7/8	14 x 9	2	5/8	1	6	605646	605662
16 E	3/4 x 15-1/2	16 x 10	3	5/8	1	6	605647	605663
18 E	3/4 x 15-1/2	18 x 11	3	5/8	1	6	605648	605664
20 F	1 x 20-1/4	20 x 12	3	5/8	1	6	605649	605665
22 F	1 x 20-1/4	22 x 14	4	5/8	1	6	605650	605666
24 F	1 x 20-1/4	24 x 14	5	5/8	1	6	605651	-
25 F	1 x 20-1/4	25 x 14	4	5/8	1	6	605652	-

Metric Broach Shims



Broach Size	Shim Thickness (Inch)	Code	Broach Size	Shim Thickness (Inch)	Code	Broach Size	Shim Thickness (Inch)	Code
3 A	0.0310	605667	10 D	0.0560	605673	22 F	0.0560	605679
4 BI	0.0380	605668	12 D	0.0560	605674	24 F	0.0625	605680
5 BI	0.0500	605669	14 D	0.0625	605675	25 F	0.0560	605681
5 C	0.0470	605670	16 E	0.0560	605676			
6 C	0.0625	605671	18 E	0.0560	605677			
8 C	0.0500	605672	20 F	0.0625	605678			

Metric Square Broaches

High Speed Steel

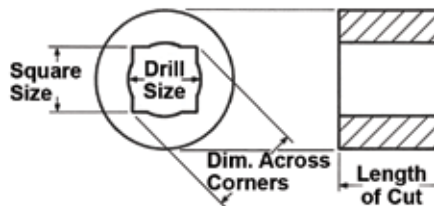

Square Size (mm)	Tolerances Dec. Equiv. (Inch)	Broach Length (Inch)	Pilot Diameter (Inch)	Drill Size (mm)	Minimum Length of Cut (Inch)	Maximum Length of Cut (Inch)	Code
4	0.1575 - 0.1580	5-1/8	0.1614	4.10	1/4	1/2	605682
5	0.1968 - 0.1973	6-1/2	0.2047	5.20	1/4	1/2	605683
6	0.2362 - 0.2367	6-11/16	0.2510	6.40	1/4	3/4	605684
7	0.2756 - 0.2764	8	0.2913	7.40	3/8	1	605685
8	0.3150 - 0.3156	7-1/8	0.3307	8.40	3/8	1	605686
10	0.3937 - 0.3943	10-1/8	0.4094	10.40	3/8	1-1/4	605687
12	0.4724 - 0.4731	12	0.5039	12.80	1/2	1-3/8	605688
14	0.5512 - 0.5519	14-3/4	0.5826	14.80	1/2	1-1/2	605689

Metric Broach Bushings

Collared & Plain Types



Diameter (mm)	Collared Bushings			Plain Bushings		Diameter (mm)	Collared Bushings			Plain Bushings	
	A Bushings for A Broaches	BI Bushings for BI Broaches	C Bushings for C Broaches	D Bushings for D Broaches	E Bushings for E Broaches		A Bushings for A Broaches	BI Bushings for BI Broaches	C Bushings for C Broaches	D Bushings for D Broaches	E Bushings for E Broaches
6	605690	-	-	-	-	40	-	-	-	605720	-
8	605691	-	-	-	-	42	-	-	-	605721	-
10	605692	-	-	-	-	44	-	-	-	605722	-
12	605693	605695	-	-	-	45	-	-	-	605723	-
14	-	605696	-	-	-	46	-	-	-	605724	-
15	605694	605697	-	-	-	48	-	-	-	605725	-
16	-	605698	-	-	-	50	-	-	-	605726	-
17	-	605699	-	-	-	52	-	-	-	605727	605730
18	-	605700	605702	-	-	54	-	-	-	605728	605731
19	-	605701	605703	-	-	55	-	-	-	-	605732
20	-	-	605704	-	-	56	-	-	-	605729	605733
22	-	-	605705	-	-	58	-	-	-	-	605734
24	-	-	605706	-	-	60	-	-	-	-	605735
25	-	-	605707	-	-	62	-	-	-	-	605736
26	-	-	605708	-	-	63	-	-	-	-	605737
28	-	-	605709	-	-	64	-	-	-	-	605738
30	-	-	605710	-	-	65	-	-	-	-	605739
32	-	-	605711	605715	-	66	-	-	-	-	605740
34	-	-	605712	605716	-	68	-	-	-	-	605741
35	-	-	605713	605717	-	70	-	-	-	-	605742
36	-	-	605714	605718	-	72	-	-	-	-	605743
38	-	-	-	605719	-						



Square Broaches

High Speed Steel



Square Size (Inch)	Broach Length (Inch)	Pilot Diameter (Inch)	Drill Size	Minimum Length of Cut (Inch)	Maximum Length of Cut (Inch)	Code
1/8	4-1/8	0.1285	No. 30	3/16	1/2	605744
5/32	5-1/8	0.1590	No. 21	1/4	1/2	605745
3/16	5-9/16	0.1935	No. 10	1/4	5/8	605746
7/32	6-1/2	0.2280	No. 1	1/4	3/4	605747
1/4	6-1/2	0.2656	17/64	1/4	3/4	605748
9/32	7-3/4	0.2969	19/64	5/16	1	605749
5/16	7-7/8	0.3281	21/64	3/8	1	605750
11/32	9-3/8	0.3594	23/64	3/8	1-1/4	605751
3/8	9-3/8	0.3906	25/64	3/8	1-1/4	605752
13/32	10-5/8	0.4219	27/64	1/2	1-3/8	605753
7/16	10-7/8	0.4531	29/64	1/2	1-3/8	605754
15/32	12	0.5000	1/2	1/2	1-3/8	605755
1/2	12	0.5312	17/32	1/2	1-3/8	605756
9/16	14-3/4	0.5938	19/32	1/2	1-1/2	605757
5/8	16-5/16	0.6562	21/32	5/8	1-5/8	605758
11/16	17-3/4	0.7500	3/4	5/8	1-5/8	605759
3/4	17-3/4	0.8125	13/16	5/8	1-5/8	605760
7/8	22-3/4	0.9375	15/16	5/8	2	605761
1	24-1/8	1.0938	1-3/32	5/8	2	605762

BROACHES

Round Broaches

High Speed Steel



Diameter (Inch)	Broach Length (Inch)	Pilot Diameter (Inch)	Drill Size (Inch)	Minimum Length of Cut (Inch)	Maximum Length of Cut (Inch)	Code
1/4	5-7/8	15/64	15/64	5/16	3/4	605763
5/16	5-7/8	19/64	19/64	5/16	3/4	605764
3/8	6-7/8	23/64	23/64	3/8	1	605765
7/16	6-7/8	27/64	27/64	3/8	1	605766
1/2	8	31/64	31/64	1/2	1-1/4	605767
5/8	8-1/2	39/64	39/64	1/2	1-1/4	605769
3/4	9-1/8	47/64	47/64	5/8	1-1/2	605771
7/8	9-1/4	55/64	55/64	5/8	1-1/2	605773
1	10-1/4	63/64	63/64	5/8	1-3/4	605775

Hexagonal Broaches

High Speed Steel



Hex Size (Inch)	Broach Length (Inch)	Pilot Diameter (Inch)	Drill Size (Inch)	Minimum Length of Cut (Inch)	Maximum Length of Cut (Inch)	Code
1/8	4-1/8	1/8	1/8	3/16	3/8	605776
5/32	4-15/16	5/32	5/32	1/4	1/2	605777
3/16	5-1/16	3/16	3/16	1/4	5/8	605778
7/32	5-3/8	7/32	7/32	1/4	3/4	605779
1/4	6	1/4	1/4	1/4	3/4	605780
9/32	7-1/4	9/32	9/32	5/16	1	605781
5/16	7-3/4	5/16	5/16	3/8	1	605782
11/32	7-3/4	11/32	11/32	3/8	1-1/4	605783
3/8	8-1/2	3/8	3/8	3/8	1-1/4	605784
13/32	9-5/8	13/32	13/32	1/2	1-3/8	605785
7/16	10-5/8	7/16	7/16	1/2	1-3/8	605786
15/32	11-7/8	15/32	15/32	1/2	1-3/8	605787
1/2	11-7/8	1/2	1/2	1/2	1-3/8	605788
9/16	13-3/4	9/16	9/16	1/2	1-5/8	605789
5/8	16-1/4	5/8	5/8	5/8	2	605790
11/16	16-3/4	11/16	11/16	5/8	2	605791
3/4	17-1/4	3/4	3/4	5/8	2	605792
7/8	18-1/2	7/8	7/8	5/8	2	605793
1	19-3/4	1	1	5/8	2	605794

Keyseating Broaches

High Speed Steel



Keyway Width (Inch)	Broach Length (Inch)	Tooth Pitch (Inch)	Height at Teeth (Inch)	Body Width (Inch)	Code
1/16	16	3/8	3/8	3/16	605795
3/32	16	3/8	3/8	3/16	605796
1/8	16	3/8	7/16	3/16	605797
5/32	16	3/8	1/2	5/32	605798
3/16	16	3/8	5/8	3/16	605799
1/4	16	3/8	3/4	1/4	605800
1/4	20	3/8	1	1/4	605801
5/16	16	3/8	7/8	5/16	605802
5/16	20	3/8	1	5/16	605803
3/8	16	17/32	7/8	3/8	605804
3/8	20	17/32	1	3/8	605805
7/16	20	17/32	1	7/16	605806
1/2	20	17/32	1	1/2	605807
9/16	20	17/32	1	9/16	605808
5/8	20	17/32	1	5/8	605809
3/4	20	17/32	1	3/4	605810
7/8	20	17/32	1	7/8	605811
1	20	17/32	1	1	605812

Production Broaches

High Speed Steel



Shims or bushing not required

Broach Size (Inch)	Body Diameter (Inch)	Dimension (Inch)	Broach Length (Inch)	Minimum Length of Cut (Inch)	Maximum Length of Cut (Inch)	Code
1/16	3/16	0.224	5-5/8	13/64	1	605813
1/16	1/4	0.287	6-3/16	13/64	1	605814
1/8	3/8	0.437	8-1/2	17/64	1-1/4	605815
1/8	1/2	0.565	11-3/4	25/64	2-1/2	605816
1/8	9/16	0.630	11-3/4	25/64	2-1/2	605817
1/8	5/8	0.693	11-3/4	25/64	2-1/2	605818
3/16	5/8	0.716	14-3/4	25/64	2-1/2	605819
3/16	3/4	0.844	14-3/4	25/64	2-1/2	605820
3/16	7/8	0.970	14-3/4	25/64	2-1/2	605821
1/4	1	1.121	18	25/64	2-1/2	605822

One-Pass Broaches

High Speed Steel



Style C bushings required

Broach Size (Inch)	Broach Dimensions (Inch)	Minimum Length of Cut (Inch)	Maximum Length of Cut (Inch)	Code
1/8 C	3/8 x 14-1/8	19/64	2	605823
5/32 C	3/8 x 14-1/8	19/64	2	605824
3/16 C	3/8 x 17	19/64	2	605825
1/4 C	3/8 x 17	19/64	2	605826
5/16 C	3/8 x 18-1/2	19/64	2	605827
3/8 C	3/8 x 18-1/2	19/64	2	605828

Metric Keyseating Broaches

High Speed Steel



Broach Size (mm)	Keyway Width Tolerance (Inch)	Body Dimensions W x H x L	Minimum Length of Cut (Inch)	Maximum Length of Cut (Inch)	Code
2	0.0787 - 0.0792	3/16 x 3/8 x 16	5/8	1-7/8	605829
3	0.1181 - 0.1186	3/16 x 7/16 x 16	5/8	1-7/8	605830
4	0.1575 - 0.1580	3/16 x 1/2 x 16	5/8	1-7/8	605831
5	0.1968 - 0.1973	5 mm x 9/16 x 16	5/8	1-7/8	605832
6	0.2362 - 0.2367	6 mm x 3/4 x 16	5/8	1-7/8	605833
6	0.2362 - 0.2367	6 mm x 3/4 x 20	5/8	3-1/8	605834
8	0.3150 - 0.3155	8 mm x 7/8 x 16	1-1/16	3-3/16	605835
8	0.3150 - 0.3155	8 mm x 7/8 x 20	1-1/16	5-5/16	605836
10	0.3937 - 0.3942	10 mm x 7/8 x 20	1-1/16	5-5/16	605837
12	0.4724 - 0.4730	12 mm x 1 x 20	1-1/16	5-5/16	605838
13	0.5118 - 0.5125	13 mm x 1 x 20	1-1/16	5-5/16	605839
14	0.5612 - 0.5519	14 mm x 1 x 20	1-1/16	5-5/16	605840
16	0.8299 - 0.6306	16 mm x 1 x 20	1-1/16	5-5/16	605841
18	0.7087 - 0.7093	18 mm x 1 x 20	1-1/16	5-5/16	605842
20	0.7874 - 0.7883	20 mm x 1 x 20	1-1/16	5-5/16	605843
22	0.8661 - 0.8669	22 mm x 1 x 20	1-1/16	5-5/16	605844
24	0.9449 - 0.9458	24 mm x 1 x 20	1-1/16	5-5/16	605845
25	0.9843 - 0.9853	25 mm x 1 x 20	1-1/16	5-5/16	605846



Broach Sets



- All Minute Man® Broach Sets are supplied in storage boxes, and come complete with precision broaches, slotted bushings, and necessary shims
- Collared bushings are recommended are supplied unless plain bushings are specified on your order

TiN coated sets available on request

No. 00 Precision Set

The most common keyway combinations for small keyways and bores.
3 broaches and 5 bushings = 15 keyway combinations

Collared bushings only

Keyway Sizes	Broach Style	Bushing Diameters (Bore Sizes)	Code
1/16 3/32 1/8	A	1/4, 5/16, 3/8, 7/16, 1/2	605500

No. 10 Standard Set

Our best selling broach set.
4 broaches and 9 bushings = 18 keyway combinations

Collared bushings only

Keyway Sizes	Broach Style	Bushing Diameters (Bore Sizes)	Code
1/8 3/16	B	1/2, 5/8, 3/4, 7/8	605501
1/4 3/8	C	1, 1-1/8, 1-1/4, 1-3/8, 1-1/2	

No. 10A Standard Set

Same as No. 10 Set, but for sixteenth-sized bores.
4 broaches and 9 bushings = 18 keyway combinations

Collared bushings only

Keyway Sizes	Broach Style	Bushing Diameters (Bore Sizes)	Code
1/8 3/16	B	9/16, 11/16, 13/16	605502
1/4 3/8	C	15/16, 1-1/16, 1-3/16, 1-5/16, 1-7/16, 1-9/16	

No. 10-10A Combination Set

Combines 10 and 10A sets features all bore sizes in 1/16 inch increments for keyways 1/8 to 3/8 inches.
4 broaches and 18 bushings = 36 keyway combinations

Collared bushings only

Keyway Sizes	Broach Style	Bushing Diameters (Bore Sizes)	Code
1/8 3/16	B	1/2, 9/16, 5/8, 11/16, 3/4, 13/16, 7/8	605503
1/4 3/8	C	15/16, 1, 1-1/16, 1-1/8, 1-3/16, 1-1/4, 1-5/16, 1-3/8, 1-7/16, 1-1/2, 1-9/16	

No. 20 Combination Set

Same as No. 10-10A combination set plus a 5/16" keyway for 11 extra combinations
5 broaches and 18 bushings = 47 keyway combinations

Collared bushings only

Keyway Sizes	Broach Style	Bushing Diameters (Bore Sizes)	Code
1/8 3/16	B	1/2, 9/16, 5/8, 11/16, 3/4, 13/16, 7/8	605504
1/4 5/16 3/8	C	15/16, 1, 1-1/16, 1-1/8, 1-3/16, 1-1/4, 1-5/16, 1-3/8, 1-7/16, 1-1/2, 1-9/16	

No. 40A Set

The most common keyway combinations for medium sized keyways and bores.
4 broaches and 8 bushings = 32 keyway combinations

Plain bushings only

Keyway Sizes	Broach Style	Bushing Diameters (Bore Sizes)	Code
5/16 3/8 7/16 1/2	D	1-1/2, 1-5/8, 1-3/4, 1-7/8, 2, 2-1/8, 2-1/4, 2-1/2	605505

No. 40 Set

Same as No. 40A, but for sixteenth sized bores.
4 broaches and 8 bushings = 32 keyway combinations

Plain bushings only

Keyway Sizes	Broach Style	Bushing Diameters (Bore Sizes)	Code
5/16 3/8 7/16 1/2	D	1-7/16, 1-9/16, 1-11/16, 1-13/16, 1-15/16, 2-3/16, 2-7/16, 2-15/16	605506

No. 40-1/2A Heavy Duty Set

The most common keyway combinations for large keyways and bores.
2 broaches and 6 bushings = 12 keyway combinations

Plain bushings only

Keyway Sizes	Broach Style	Bushing Diameters (Bore Sizes)	Code
5/8 3/4	E	2-3/8, 2-1/2, 2-5/8, 2-3/4, 2-7/8, 3	605507

Broach Sets (continued)



No. 40-1/2 Heavy Duty Set

Same as No. 40-1/2A
but for sixteenth sized bores.
2 broaches and 6 bushings = 12 keyway combinations
Plain bushings only

Keyway Sizes	Broach Style	Bushing Diameters (Bore Sizes)	Code
5/8 3/4	E	2-5/16, 2-7/16, 2-9/16, 2-11/16, 2-13/16, 2-15/16	605508

No. 50 Heavy Duty Set

Includes the most common keyway combinations for medium and large keyways.
3 broaches and 17 bushings = 29 keyway combinations
Plain bushings only

Keyway Sizes	Broach Style	Bushing Diameters (Bore Sizes)	Code
1/2	D	2, 2-1/16, 2-1/8, 2-3/16, 2-1/4	605509
5/8	E	2-5/16, 2-3/8, 2-7/16, 2-1/2,	
3/4		2-9/16, 2-5/8, 2-11/16, 2-3/4, 2-13/16, 2-7/8, 2-15/16, 3	

No. 60 Metric Set

The most common metric keyway combination for small keyways and bores.
2 broaches and 3 bushings = 6 keyway combinations
Collared bushings only

Keyway Sizes	Broach Style	Bushing Diameters (Bore Sizes)	Code
2 mm 3 mm	A	6, 8, 10 mm	605510

No. 70 Metric Set

Our most popular metric broach set.
4 broaches and 13 bushings = 26 keyway combinations
Collared bushings only

Keyway Sizes	Broach Style	Bushing Diameters (Bore Sizes)	Code
4 mm 5 mm	B-1	12, 14, 15, 16 mm	605511
6 mm 8 mm	C	18, 19, 20, 22, 24, 25, 26, 28, 30 mm	

No. 80 Metric Set

The most common metric keyway combination for medium-sized keyways and bores.
3 broaches and 12 bushings = 36 keyway combinations
Plain bushings only

Keyway Sizes	Broach Style	Bushing Diameters (Bore Sizes)	Code
10 mm 12 mm 14 mm	D	32, 34, 35, 36, 38, 40, 42, 44, 45, 46, 48, 50 mm	605512

No. 90 Metric Set

The most common metric keyway combination for large keyways and bores.
2 broaches and 8 bushings = 16 keyway combinations
Plain bushings only

Keyway Sizes	Broach Style	Bushing Diameters (Bore Sizes)	Code
16 mm 18 mm	E	52, 54, 55, 56, 58, 60, 62, 65	605513

No. 100 Heavy Duty Combination Set

The most complete Minute Man® Broach Set available including all popular combinations without duplication. This set is supplied in three wood boxes for convenient handling and storage, and comes with broaches, slotted bushings, and necessary shims.
9 broaches and 44 bushings = 102 keyway combinations

*Collared bushings B & C
Plain bushings D & E*

Keyway Sizes	Broach Style	Bushing Diameters (Bore Sizes)	Code
1/8 3/16	B	1/2, 9/16 5/8, 11/16, 3/4, 13/16, 7/8	605514
1/4 5/16	C	15/16, 1, 1-1/16, 1-1/8, 1-3/16, 1-1/4 1-5/16, 1-3/8, 1-7/16, 1-1/2, 1-9/16	
3/8 7/16	D	1-7/16, 1-1/2, 1-9/16, 1-5/8 1-11/16, 1-3/4	
1/2	E	1-13/16, 1-7/8, 1-15/16, 2, 2-1/16, 2-1/8, 2-3/16, 2-1/4 2-5/16, 2-3/8, 2-7/16, 2-1/2, 2-9/16, 2-5/8, 2-11/16, 2-3/4	
5/8 3/4		2-13/16, 2-7/8, 2-15/16, 3	

Set B – The Workhorse

- Popular set for holes, slots and edges
- Supports all B blades
- Blades can be inserted axially or perpendicular to holder
- Mango II handle provides maximum comfort
- Deburrs steel, aluminum, copper, brass, cast iron, stainless steel and plastics

Mango II – B Blades

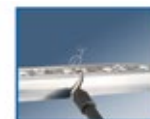

Set Name	Handle	Holder	Blades	Code
Mango II Set B	Mango II	B	B10 B20	550600

Classic – B Blades



Set Name	Handle	Holder	Blades	Code
Shaviv Set B	Classic A	B	B10 B20	550801

Aluminum – B Blades



Set Name	Handle	Holder	Blades	Code
Shaviv Set B Aluminum	Aluminum	B	B10 B20	550807

Set E – Heavy Deburr

- Rugged deburring set for heavy-duty deburring of holes, slots and edges
- Supports all E blades
- Mango II handle provides maximum comfort
- Deburrs steel, aluminum, copper, brass, cast iron, stainless steel and plastics

Mango II – E Blades

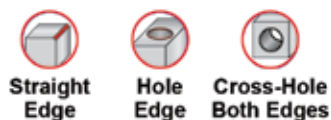

Set Name	Handle	Holder	Blades	Code
Mango II Set E	Mango II	E	E100 E200 E300	550601

Classic – E Blades



Set Name	Handle	Holder	Blades	Code
Shaviv Set E	Classic A	E	E100 E200 E300	550804

Mango II Extra Close Sets

- Sets for extra close jobs and applications when you need to get up tight to the workpiece
- Popular for deburring holes, slots and edges on most types of materials
- Mango IIB + 2 set contains two high speed steel standard duty B blades and the Mango IIB quality ergonomic handle
- Mango IIE + 3 set contains three high speed steel heavy duty blades and the Mango IIE quality ergonomic handle
- Mango IIB and Mango IIE handles are designed for extra-close and heavy duty applications with a safety lock that prevents losing blades while working



Set Name	Handle	Blades	Code
Mango IIB+2	Mango IIB	B10 B20	550602
Mango IIE+3	Mango IIE	E100 E200 E300	550603

Mango II Extra Close Bonus Pack Sets



- Sets for extra close jobs and applications when you need to get up tight to the workpiece
- Popular for deburring holes, slots and edges on most types of materials
- Includes 10 high speed steel blades and a Mango IIB or Mango IIE handle
- Mango IIB and Mango IIE handles are designed for extra-close and heavy duty applications with a safety lock that prevents losing blades while working

Set Name	Handle	Blades	Code
Mango IIB Bonus Pack	Mango IIB	10 x B10	550992
Mango IIE Bonus Pack	Mango IIE	10 x E100	550993

Mango II Long Reach Bonus Pack Sets



- Telescopic holder B or E for long reach applications
- Popular for deburring holes, slots and edges on most types of materials
- Includes 10 high speed steel blades and a Mango II handle

Set Name	Handle	Holder	Blades	Code
Mango II Set B Bonus Pack	Mango II	B	10 x B10	550996
Mango II Set E Bonus Pack	Mango II	E	10 x E100	550997

Golden Flex Sets

TiN Coated Blades



- Set B for standard deburring with five different pair of TiN coated multi-purpose B blades
- Set E for heavy duty deburring with five different pair of TiN coated multi-purpose E blades

Set Name	Handle	Holder	Blades	Code
Shaviv Golden Flex Set B	Aluminum	B	2 x B10P 2 x B11P 2 x B12P 2 x B20P 2 x B30P	551002
Shaviv Golden Flex Set E	Aluminum	E	2 x E100P 2 x E110P 2 x E111P 2 x E200P 2 x E300P	551003

Mango II AeroBurr Sets

TiN Coated Blades



- For aviation, aerospace, and medical industries
- Deburrs curves and small holes down to 1/16" in aluminum, steel, copper, stainless steel and plastics
- Set B for standard deburring with five B11P TiN coated blades
- Set E for heavy duty deburring with five E111P TiN coated blades

Set Name	Handle	Holder	Blades	Code
AeroBurr Set B	Mango II	B	5 x B11P	551004
AeroBurr Set E	Mango II	E	5 x E111P	551005

Set M – The 2 in 1

- Deburrs holes, slots and edges
- Mango II handle provides maximum comfort
- Holder M supports both B and E blades
- Deburrs steel, aluminum, copper, brass, cast iron, stainless steel, and plastics



Set Name	Handle	Holder	Blades	Code
Mango II Set M	Mango II	M	B10 B20 B30 E100 E200 E111	550605

Classic – B & E Blades



Set Name	Handle	Holder	Blades	Code
Shaviv Set M	Classic A	M	B10 B20 B30 E100 E200 E111	550809

Set HC – Handy Chuck

- Delivers pin vise versatility for finishing & scraping applications
- Also used for gripping miniature files, drills, reamers, taps, wires, countersinks and other small objects - 0.04" to 0.32" (1 to 8mm) in diameter
- Handy for assembling electronic components and watch repair
- Deburrs steel, aluminum, copper, brass, cast iron, stainless steel and plastics



Set Name	Handle	Blades	Code
Shaviv Set HC5	Handy Chuck Pin Vise	C50	550937

Set U – Finishing Scraper

- Precision scraper contains three mini scraper blades and a specially designed holder for extra precision work for linear movement
- Ideal for die makers
- Mango II handle provides maximum comfort
- Deburrs steel, aluminum, copper, brass, cast iron, stainless steel and plastics

Mango II - U (BUS) Blades



Set Name	Handle	Holder	Blades	Code
Mango II Set U	Mango II	U	U1 (BUS1) U31 (BUS31) U4 (BUS4)	550606

Classic – U (BUS) Blades



Set Name	Handle	Holder	Blades	Code
Shaviv Set U	Classic A	U	U1 (BUS1) U31 (BUS31) U4 (BUS4)	550941

Set D – The Sheet Cleaner

- Perfect for sheet metal up to 0.12" thick (3mm)
- Blade deburrs both sides of sheet in one pass
- Blade also functions as a surface cleaner
- Mango II handle provides maximum comfort
- For added safety use with handguard (Code 550815)
- Deburrs steel, aluminum, copper, brass, cast iron, hardened steel and plastics

Mango II – D Blades



Set Name	Handle	Holder	Blades	Code
Mango II Set D	Mango II	D	D80C	550607

Classic – D Blades



Set Name	Handle	Holder	Blades	Code
Shaviv Set D	Classic A	D	D80C	550803

Set C – The Scraper

- Features triangular blades with 3 cutting edges (C42) for high quality finishing and scraping
- Telescopic blade holder enables getting in to difficult-to-reach areas
- Includes key for safely removing blades
- Mango II handle provides maximum comfort
- Deburrs steel, aluminum, copper, brass, cast iron, stainless steel and plastics

Mango II – C Blades



Set Name	Handle	Holder	Blades	Code
Mango II Set C	Mango II	C	C42	550609
Mango II Set C40	Mango II	C	C40	550610

Classic – C Blades



Set Name	Handle	Holder	Blades	Code
Shaviv Set C	Classic A	C	C42	550802

Set Burr-Bi – Heavy Duty Sheet Cleaner

- For heavy-duty deburring of materials with single or double straight edges up to 0.56" (14mm) thick
- Holder can take two R10, R20 or R30 blades for arc shape finishes on workpieces up to 0.63" (16mm) thick
- Handguard attached for worker safety
- Deburrs steel, aluminum, copper, brass, cast iron, stainless steel, and plastics

Mango II – R Blades

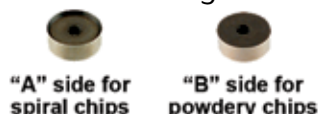

Set Name	Handle	Holder	Blades	Code
Mango II Set Burr-Bi	Mango II	BR	R10 x 2	550611

Classic – R Blades



Set Name	Handle	Holder	Blades	Code
Shaviv Set Burr-Bi	Classic A	BR	R10 x 2	550931

Set F – The Countersink

- Powerful tool, excellent for chamfering and countersinking
- Used for hole edge applications with up to 0.79" (20mm) diameter
- Get the Mango II handle for maximum comfort
- Deburrs steel, aluminum, copper, brass, cast iron, stainless steel, and plastics

Mango II – F Blades



Hole Edge



Set Name	Handle	Holder	Blades	Code
Mango II Set F	Mango II	F	F20	550612

Classic – F Blades



Set Name	Handle	Holder	Blades	Code
Shaviv Set F	Classic A	F	F20	550805

Set FR – Ratchet-Burr for ID

- Features FR ratchet holder, ideal for rotational chamfering, even when workspace is limited
- Inside diameter (ID) up to 0.79" (20mm)
- Deburrs steel, aluminum, copper, brass, cast iron, stainless steel and plastics

Mango – F Blades



Hole Edge



Set Name	Handle	Holder	Blades	Code
Mango Set FR	Mango	FR	F20	550613

Classic – F Blades



Set Name	Handle	Holder	Blades	Code
Shaviv Set FR	Classic A	FR	F20	550806

Set Burr-Ex – Ratchet-Burr for OD

- Features FR ratchet holder, ideal for rotational chamfering, even when workspace is limited
- Outside diameter (OD) up to 1" (26mm)
- Deburrs steel, aluminum, copper, brass, cast iron, stainless steel and plastics

Mango II – F Blades



Outer Edge



Set Name	Handle	Holder	Blades	Code
Mango II Set Burr-Ex	Mango II	FR	F26X	550614

Classic – F Blades



Set Name	Handle	Holder	Blades	Code
Shaviv Set Burr-Ex	Classic A	FR	F26X	550710

Set G – Slot Edge Cleaner

- Ideal for deburring and cleaning edges of internal and external keyways and slots up to 0.6" (15mm) wide
- Blade features 8 cutting edges
- Get the Mango II handle for maximum comfort
- Deburrs steel, aluminum, copper, brass, cast iron, stainless steel and plastics

Mango II – G Blades



Set Name	Handle	Holder	Blades	Code
Mango II Set G	Mango II	G	G10	550619

Classic – G Blades



Set Name	Handle	Holder	Blades	Code
Shaviv Set G	Classic A	G	G10	550888

Set G3 – Triple Corner Cleaner

- Cleans corners and removes unwanted radii after machining to ensure smooth flush mating of adjoining faces
- Special angled blade holder enables easy access to work area
- Blades feature 3 cutting corners
- Get the Mango handle for maximum comfort
- Deburrs steel, aluminum, copper, brass, cast iron, stainless steel and plastics

Mango – G Blades



Set Name	Handle	Holder	Blades	Code
Mango Set G3	Mango	G3	G30	550616

Classic – G Blades



Set Name	Handle	Holder	Blades	Code
Shaviv Set G3	Classic A	G3	G30	550915

Set L – External Pipe Edge Cleaner

- External curved edge cleaner for pipes and tubes
- Deburrs steel, aluminum, copper, brass, cast iron, stainless steel and plastics

Mango II – L Blades



Set Name	Handle	Holder	Blades	Code
Mango II Set L	Mango II	L	L10	550617

Classic – L Blades



Set Name	Handle	Holder	Blades	Code
Shaviv Set L	Classic A	L	L10	550920

Glo-Burrs

The Rainbow Series – B & E Blades

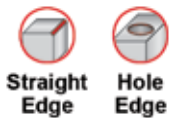

- Popular, easy-to-grip deburring tools
- Strong, yet lightweight
- Features convenient pocket clip and blade storage
- Deburrs steel, aluminum, copper, and plastics



Glo-Burr B

- Supplied with a B10 blade, and holds other popular B blades

Color	Code	Color	Code
Yellow	550961	Green	550962
Red	550960	Blue	550963

Glo-Burr E

- Supplied with a heavy-duty E100 blade, and holds other popular E blades

Color	Code	Color	Code
Yellow	550966	Green	550967
Red	550965	Blue	550968

Uniburrs



- Popular, slim-grip deburring tools
- Strong, yet lightweight
- Features convenient pocket clip
- Deburrs steel, aluminum, copper and plastics

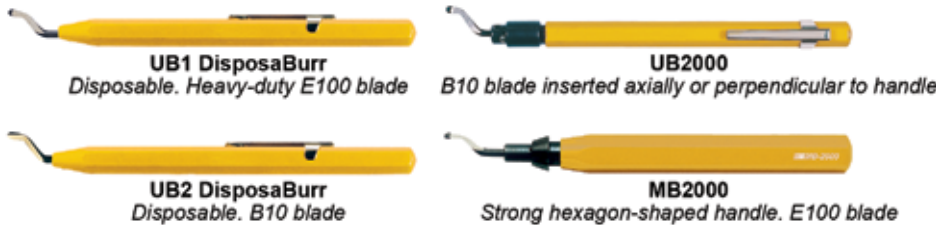

Description	Code	Description	Code
UB1 DisposaBurr	550884	UB2000	550883
UB2 DisposaBurr	550885	MB2000	550882

Scrape-Burrs

Scrape-Burr 42 – The Heavy Duty Scraper

- Durable and secure
- Permanent heavy duty triangular blade with three cutting edges for high quality finishing and scraping



Set Name	Handle	Blades	Code
Scrape-Burr 42	Glo-Burr	C42	550975

Scrape-Burr 40 – The All-Purpose Scraper

- Useful and convenient all-purpose standard scraper
- Permanent heavy duty triangular blade with three cutting edges for high quality finishing and scraping



Set Name	Handle	Blades	Code
Scrape-Burr 40	Glo-Burr	C40	550974

Scrape-Burr 400 – The Fine Finish Scraper

- Miniature tool for a fine finish on precision work pieces
- Extra thin, heavy duty triangular blade with three cutting edges for high quality and accurate finishing and scraping



Set Name	Handle	Blades	Code
Scrape-Burr E400	Glo-Burr	E400	550976

Set Ceramix Q10

Heavy Duty Handle with Ceramic Q10 Blade

- Adjust cutting angle between the blade and the material for best results and to prevent scratches
- Blade can be flipped for two types of jobs

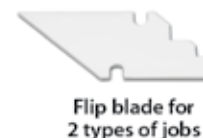
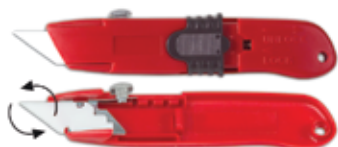
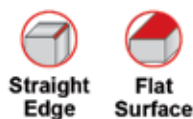

Set Name	Handle	Blades	Code
Set Ceramix Q10	Ceramic	Q10	550722

Set Ceramix Q12

Heavy Duty Handle with Curved Ceramic Q11 Blade

- Adjust cutting angle between the blade and the material for best results and to prevent scratches
- Blade can be flipped for two types of jobs

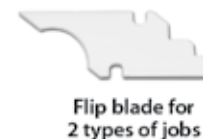

Set Name	Handle	Blades	Code
Set Ceramix Q12	Ceramic	Q11	550726

Ceramix Blades

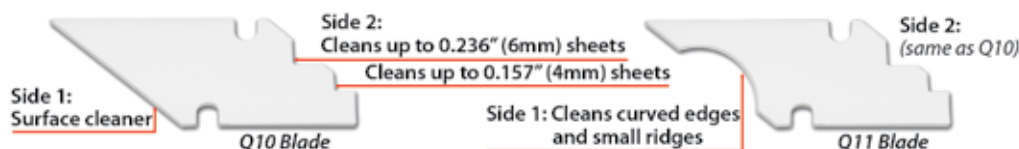

Description	Blades	Code
Ceramix Blade Q10	Q10	550723
Ceramix Curved Blade Q11	Q11	550728

Plum-Burrs

Heavy Duty & Standard Pipe Cleaners

- For deburring aluminum, copper and brass tubing on both inner and outer edges
- Used by plumbers, installers, electricians, etc.

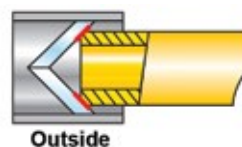
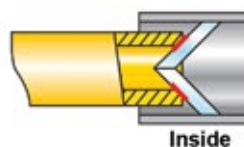

Description	Tubing Range Inch (mm)	Code
Plum-Burr Metal	1/4 to 1-5/8 (6 to 41)	550999
Plum-Burr Plastic	3/16 to 1-1/2 (4.8 to 38)	550998

Set TD – Tool & Die Maker’s Set



Professional, miniature deburring and scraping tools for providing a quality finish to dies and molds

Contains:

- UF1 - Flat diamond coated file
- US1 - Triangular scraper
- US2 - Flat scraper
- US3 - Round scraper
- US4 - Hooked corner scraper
- US38 - Miniature rotational deburring tool for minimum hole diameter of 0.08" (2mm)

Set Name	Code
Set TD	550813

Universal Sheet Cleaner Set

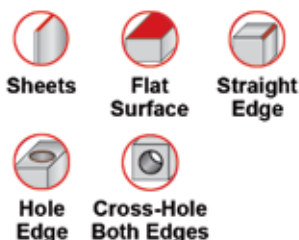

- Perfect for a wide variety of deburring applications including deburring sheets made of practically any material: metal, plastic, acrylic, etc.
- Removes ragged edges from one side at a time or both sides at once

Set Contains:

- Mango II handle
- Holders - B, BR, D, D5 and E
- Blades - B10, B20, B30, B70, E100, E200, E300, D80C, D82C, D85, 2 x R10 and 2 x R30
- Handguard

Set Name	Code
Sheet Cleaner Set	550622

Set KWC – The Universal Box

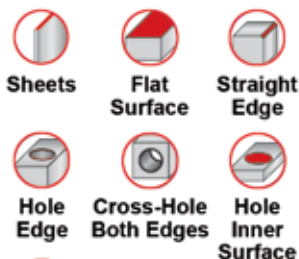

- Excellent all-around deburring set for your workshop
- You get all the tools you need for 1000+ applications

Set Contains:

- Handle
- Holders - B, C, D, E and F
- Blades - B10, B20, B30, B50C, B60, B70, C40, C42, D80C, E100, E200, E300, E350, E600 and F20



Set Name	Code
Mango II Set KWC	550623
Classic KWC in plastic case	550810
Classic KWC in wood case	550812

Set U – Ultra-Fine Finish

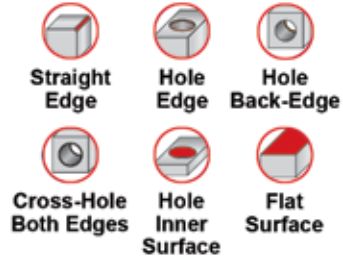

- Ultra-fine finish kit for precision workpieces
- **Set Contains:**
 - Aluminum handle
 - Non-rotating U holder
 - Rotating B holder
 - Four B blades for rotational deburring - B10, B11, B20 and B30
 - Four interchangeable U scrapers - BUS1, BUS2, BUS31 and BUS4
 - E500C scribe

Set Name	Code
Set U	550940

Set KPC2 – The Favourite 5

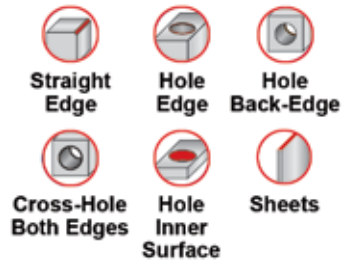

- Five extremely popular sets with the Classic A handle, provided in one handy kit
- **Set Contains:**
 - Set B: The Workhorse
 - Set C: The Scraper
 - Set D: The Sheet Cleaner
 - Set E: The Heavy Deburr Set
 - Set F: The Countersink

Set Name	Code
Classic KPC2	550811

Set KPA – Plastics Deflashing



Classic Handle A



- The complete kit for deflashing plastics
- **Set Contains:**
 - Mango II handle
 - UB38 deburring tool
 - Holders - B, E, G3 and LP
 - Blades - B12, B25, E110, E700, G30C and L10

Set Name	Code
Mango KPA	550626
Classic KPA	550814

Handles

Mango II Handle - Long Reach



- The most recommended handle for comfort and control in deburring
- Works with all Shaviv blade holders
- Simple holder mechanism
- Comfortable ergonomic handle for standard size hands

Code

550621

Classic Handle A



- Classic universal handle
- Accepts all Shaviv blade holders
- To store spare blades inside handle simply unscrew the back cap

Code

550821

Handle 1



- Non-telescopic handle, excellent for heavy-duty deburring tasks
- All E blades fit directly into handle

Code

550879

Handle A (Aluminum)



- Classic universal handle made of heavy-duty aluminum
- Accepts all Shaviv blade holders

Code

550880

Handy Chuck Pin Vise



- Holds small files, drills, reamers, taps, mold polishing stones, wires, countersinks, etc.
- Grips objects with 0.04" (1mm) to 0.32" (8mm) diameter
- May be used with C50 and C60 scrapers
- Useful for repairing and assembling watches, electrical appliances and miniature electronic equipment

Code

550887

Holder

Holder B



- Holds all B blades
- Use axially or perpendicular to holder

Code

550822

Holder E



- Holds all E blades

Code

550825

Holder M



- Holds all B or E blades

Code

550808

Holder C



- Holds C40 and C42 blades

Code

550823

Holder D



- Holds D80C and D82C blades

Code

550824

Holder D5



- Holds D85 blade

Code

550629

Holder (continued)

Holder F



- Holds all F blades

Code

550826

Holder FR



- Ratchet holder for all F blades

Code

550827

Holder U



- Holds all U (BUS) blades

Code

550942

Holder L



- Holds L10 blade

Code

550921

Holder G



- Holds G10, G20 and G40C blades

Code

550890

Holder G4



- Holds G10, G20 and G40C blades
- Angled to offer easy access to the work area

Code

550892

Holder G3



- Holds G30C blade
- Angled to offer easy access to the work area

Code

550916

Holder BURR-BI BR



Code

550932

Multi-Purpose Blade Sets

TiN Coated B & E Blades

Set B



- Multi-Purpose Blade Set B for standard deburring
- Includes five pair of blades: 2 x B10P, 2 x B11P, 2 x B12P, 2 x B20P and 2 x B30P

Code

551001

Multi-Purpose Blade Set B

Set E

















- Multi-Purpose Blade Set E for heavy duty deburring
- Includes five pair of blades: 2 x E100P, 2 x E110P, 2 x E111P, 2 x E200P and 2 x E300P

Code

551000



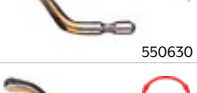











Multi-Purpose Blade Set E

Blade Index













Blade Name	Description	Blade <i>Work direction shown</i>	Applications										Materials								
			Straight Edge	Hole Edge	Outer Edge	Cross Hole Both Edges	Hole Back Edge	Hole Inner Surface	Flat Surface	Sheet	Slot/Keyway	Inner Straight Corners	Steel	Aluminum	Copper	Brass	Cast Iron	Stainless Steel	Hardened Steel	Plastics	Carbide and Glass
B1	Tough, long lift cobalt blade. NI geometry.	 550631	●	●										●	●	●			●	●	
B-NI	High speed steel. NI geometry.	 550831	●	●										●	●	●				●	
B10	High speed steel. Deburrs materials with spiral chips.	 550832	●	●										●	●	●				●	
B10C	Solid carbide. B10 geometry.	 550833	●	●										●	●	●			●	●	
B10D	Diamond coated. B10 geometry.	 550835	●	●																	●
B10L	B10 for left-handed users.	 550644	●	●										●	●	●				●	
B10P	PVD TiN coated for high wear resistance. B10 geometry.	 550633	●	●										●	●	●			●	●	
B10PL	B10 coated with PVD TiN for left-handed users.	 550647	●	●										●	●	●			●	●	
B10S	Long lasting, cobalt enriched. B10 geometry.	 550632	●	●										●	●	●			●	●	
B11	Extra thin, high speed steel. Deburrs holes with minimum diameter of 0.08" (2mm).	 550834	●	●										●	●	●				●	
B11P	PVD TiN coated for high wear resistance. B11 geometry.	 550729	●	●										●	●	●			●	●	
B12	Short nose, high speed steel.	 550836	●	●										●	●	●				●	
B12P	Short nose, PVD TiN coated for high wear resistance.	 550630	●	●										●	●	●			●	●	
B20	High speed steel. Rotates clockwise and counterclockwise.	 550838	●	●												●	●			●	

Blade Index (continued)







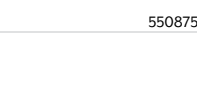









Blade Name	Description	Blade Work direction shown	Applications											Materials							
			Straight Edge	Hole Edge	Outer Edge	Cross Hole Both Edges	Hole Back Edge	Hole Inner Surface	Flat Surface	Sheet	Slot/Keyway	Inner Straight Corners	Steel	Aluminum	Copper	Brass	Cast Iron	Stainless Steel	Hardened Steel	Plastics	Carbide and Glass
B20C	Solid carbide. Rotates clockwise and counterclockwise.	 550839	●	●														●	●	●	●
B20P	PVD TiN coated for high wear resistance. Rotates clockwise and counterclockwise.	 550634	●	●														●	●	●	●
B25	Thin nose. Special design for plastics.	 550841	●	●								●	●	●							●
B25C	Solid carbide, thin nose. Special design for abrasive plastics.	 550843	●	●								●	●	●							●
B30	Simultaneously deburrs inside and outside holes up to 0.16" (4mm) thick.	 550840				●						●	●	●							●
B30P	PVD TiN coated for high wear resistance. B30 geometry.	 550845				●						●	●			●					●
B32	Rotates clockwise and counterclockwise. B30 geometry.	 550635				●									●	●					●
B50C	Carbide tipped scriber. May be reground.	 550842								●		●	●	●	●	●	●	●	●	●	●
B60	High speed steel. Removes burrs from back edge of holes up to 0.78" (20mm) thick.	 550844					●					●	●	●							●
B70	Carbide tipped. Deburrs sheet metal up to 0.14" (3.5mm) thick.	 550846								●		●	●	●	●	●	●	●	●	●	●
C40	Small, 0.16" (4mm), triangular high speed steel scraper for precision work.	 550848					●	●	●			●	●	●	●	●	●				●
C42	Standard size, 0.31" (8mm), triangular high speed steel scraper.	 550850					●	●	●			●	●	●	●	●	●				●
C50	Double-sided, 0.30" (7.8mm), triangular scraper.	 550938					●	●	●			●	●	●	●	●	●				●
C60	Double-sided, 0.19" (4.8mm), triangular scraper.	 550939					●	●	●			●	●	●	●	●	●				●

Blade Index (continued)

Blade Name	Description	Blade <i>Work direction shown</i>	Applications									Materials													
			Straight Edge	Hole Edge	Outer Edge	Cross Hole Both Edges	Hole Back Edge	Hole Inner Surface	Flat Surface	Sheet	Slot/Keyway	Inner Straight Corners	Steel	Aluminum	Copper	Brass	Cast Iron	Stainless Steel	Hardened Steel	Plastics	Carbide and Glass				
D80C	Solid carbide, six cutting edges. Scrapes surfaces and deburrs sheet metal up to 0.12" (3mm) thick.	 550852										●	●			●	●	●	●	●	●	●			
D82C	Heavy duty, double edged carbide blade. Deburrs sheet metal up to 0.35" (9mm) thick.	 550856															●	●	●	●	●	●	●		
D85	Tough high speed steel with chip-breaker and six cutting edges. Deburrs sheet metal up to 0.24" (6mm) thick.	 550854															●	●	●	●				●	
E100	Heavy duty high speed steel. Deburrs materials with spiral chips.	 550858	●	●																				●	
E100C	Wear resistant carbide. E100 geometry.	 550859	●	●																				●	
E100D	Diamond coated. E100 geometry.	 550639	●	●																					●
E100L	E100 for left handers.	 550645	●	●																					●
E100P	PVD TiN coated for high wear resistance. E100 geometry.	 550638	●	●																					●
E100S	Long lasting, cobalt enriched. E100 geometry.	 550637	●	●																					●
E110	E shaft, B10 cutting edge for materials with spiral chips. Deburrs holes with minimum diameter of 0.08" (2mm).	 550863	●	●																					●
E110P	PVD TiN coated for high wear resistance. E110 geometry.	 550643	●	●																					●
E111	Thin nose, high speed steel. Deburrs holes with minimum diameter of 0.06" (1.5mm).	 550869	●	●																					●
E111P	PVD TiN coated for high wear resistance. E111 geometry.	 550730	●	●																					●
E120	E shaft, B20 cutting edge for materials with powdery chips. Rotates clockwise and counterclockwise	 550875	●	●																					●

Blade Index (continued)



Blade Name	Description	Blade <i>Work direction shown</i>	Applications										Materials										
			Straight Edge	Hole Edge	Outer Edge	Cross Hole Both Edges	Hole Back Edge	Hole Inner Surface	Flat Surface	Sheet	Slot/Keyway	Inner Straight Corners	Steel	Aluminum	Copper	Brass	Cast Iron	Stainless Steel	Hardened Steel	Plastics	Carbide and Glass		
E200	High speed steel for materials with powdery chips. Rotates clockwise and counterclockwise.	 550860	●	●														●	●		●		
E200P	PVD TiN coated for high wear resistance. E200 geometry.	 550640	●	●															●	●		●	
E200C	Wear resistant carbide. E200 geometry.	 550861	●	●															●	●		●	
E250	Special design for plastics. Very thin, heavy duty.	 550867	●	●									●	●	●							●	
E300	High speed steel for materials with spiral chips. Simultaneous deburring of inside and outside holes up to 0.24" (6mm) thick.	 550862				●							●	●	●								
E300P	PVD TiN coated for high wear resistance. E300 geometry.	 550641				●							●	●	●				●			●	
E320	HSS for materials with powdery chips. Simultaneous deburring of inside and outside holes up to 0.24" (6mm) thick. Rotates clockwise and counterclockwise.	 550642				●													●	●		●	
E350	High speed steel for materials with powdery chips. Rotates clockwise and counterclockwise	 550864	●																	●	●		●
E500C	Carbide tipped scriber. May be reground.	 550865																				●	●
E600	High speed steel. Removes burrs from back edges of holes up to 0.78" (20mm) thick.	 550866					●															●	
E601	Extra long high speed steel. Removes burrs from back edges of holes up to 1.57" (40mm) thick.	 550868					●															●	
E700	High speed steel for materials with spiral chips. Excellent for deburring and scraping inside thick-walled holes and cross-holes.	 550876					●	●														●	
E720	HSS for materials with powdery chips. For deburring and scraping inside thick-walled holes and cross-holes. Rotates clockwise and counterclockwise.	 550877					●	●														●	
E750	High speed steel. Special design for deburring rubber and soft plastics without poking or sticking into workpiece.	 550878	●	●																			●

DEBURRING TOOLS & BURRS









Blade Index (continued)

Blade Name	Description	Blade <i>Work direction shown</i>	Applications								Materials									
			Straight Edge	Hole Edge	Outer Edge	Cross Hole Both Edges	Hole Back Edge	Hole Inner Surface	Flat Surface	Sheet	Slot/Keyway	Inner Straight Corners	Steel	Aluminum	Copper	Brass	Cast Iron	Stainless Steel	Hardened Steel	Plastics
E755	High speed steel for deburring corner edges of 0.04" (1mm) high steps.	 550970	●									●	●	●	●	●	●		●	
E800	High speed steel for materials with spiral chips. Removes burrs from corner edges of shallow steps.	 550971	●	●								●	●	●		●			●	
E10	Long lasting, cobalt enriched for materials with spiral chips. Ideal for heavy duty jobs.	 550636	●	●								●	●	●		●			●	
ES10	High speed steel durable blade. S10 geometry.	 550857	●	●								●	●	●					●	
F12	Countersink for hole edges with up to 0.47" (12mm) diameter.	 550870		●								●	●	●	●	●			●	
F20	Countersink for hole edges with up to 0.78" (20mm) diameter.	 550872		●								●	●	●	●	●			●	
F30	Countersink for hole edges with up to 1.18" (30mm) diameter.	 550874		●								●	●	●	●	●			●	
F26X	For external chamfering of pipes, tubes and other items with up to 1.02" (26mm) diameter.	 550973			●							●	●	●	●	●			●	
G10	High speed steel. Deburrs slots up to 0.6" (15mm) wide.	 550889								●		●	●	●	●	●			●	
G20	High speed steel, four cutting corners. For slots up to 0.4" (10mm) wide.	 550891								●		●	●	●	●	●			●	
G30C	Solid carbide, three cutting corners. Cleans corners and removes radii after machining for smooth flush mating of adjoining faces.	 550914									●	●	●	●	●	●	●	●	●	●
G40C	Carbide, four cutting corners. For slots up to 0.4" (10mm) wide.	 550893								●		●	●	●	●	●	●	●	●	●
K10C	Double-edged, carbide. Deburrs surfaces up to 1.91" (50mm) wide.	 550899							●			●	●	●	●	●			●	
L10	HSS, four cutting edges. Removes burrs from external edges, OD 0.78" (20mm) and up. A-side - spiral chips, B-side - powdery chips.	 550922		●								● A	● A	● A	● B	● B	● A		● A	● B

DEBURRING TOOLS & BURRS

Blade Index (continued)



Blade Name	Description	Blade Work direction shown	Applications										Materials									
			Straight Edge	Hole Edge	Outer Edge	Cross Hole Both Edges	Hole Back Edge	Hole Inner Surface	Flat Surface	Sheet	Slot/Keyway	Inner Straight Corners	Steel	Aluminum	Copper	Brass	Cast Iron	Stainless Steel	Hardened Steel	Plastics	Carbide and Glass	
R10	Double-sided, round high speed steel blade. A-side for spiral chips and B-side for powdery chips.	 550933	●									●			A	A	A	B	B	A	A	B
R20	Double-edged, round high speed steel blade for massive deburring tasks on materials with spiral chips.	 550934	●									●			●	●	●			●		●
R30	Produces arc-shaped finish on materials up to 0.63" (16mm) thick. Use 1xR30 for one straight edge or two at once to deburr both edges simultaneously.	 550935	●									●			●	●	●			●		●
BUS1 (US1)	Fine finishing triangular scraper.	 550943													●	●	●	●	●	●		●
BUS2 (US2)	Fine finishing flat scraper.	 550944													●	●	●	●	●	●		●
BUS4 (US4)	Fine finishing hooked corner scraper.	 550946													●	●	●	●	●	●		●
Q10	Double sided deburring ceramic blade.	 550723	●																			●
Q11	Double sided deburring. Curved ceramic blade for curved edges and small ridges.	 550728	●																			●

Blade Name	Code	Blade Name	Code	Blade Name	Code	Blade Name	Code
BI	550631	B32	550635	E11P	550730	F12	550870
B-NI	550831	B50C	550842	E120	550875	F20	550872
BIO	550832	B60	550844	E200	550860	F30	550874
BIOC	550833	B70	550846	E200P	550640	F26X	550973
BIOD	550835	C40	550848	E200C	550861	G10	550889
B10L	550644	C42	550850	E250	550867	G20	550891
B10P	550633	C50	550938	E300	550862	G30C	550914
B10PL	550647	C60	550939	E300P	550641	G40C	550893
B10S	550632	D80C	550852	E320	550642	K10C	550899
B11	550834	D82C	550856	E350	550864	L10	550922
B11P	550729	D85	550854	E500C	550865	R10	550933
B12	550836	E100	550858	E600	550866	R20	550934
B12P	550630	E100C	550859	E601	550868	R30	550935
B20	550838	E100D	550639	E700	550876	BUS1 (US1)	550943
B20C	550839	E100L	550645	E720	550877	BUS2 (US2)	550944
B20P	550634	E100P	550638	E750	550878	BUS4 (US4)	550946
B25	550841	E100S	550637	E755	550970	Q10	550723
B25C	550843	E110	550863	E800	550971	Q11	550728
B30	550840	E110P	550643	E10	550636		
B30P	550845	E111	550869	ES10	550857		

DEBURRING TOOLS & BURRS

Burrs

Carbide

Fluting Styles

Double Cut

Most popular fluting style. Has both right and left hand flutes which combine to produce a chisel type cutting edge. The chisel edge permits faster penetration and stock removal while the reduced pull of the tool allows better control and reduces operator fatigue. Chips produced by the double cut are smaller than spiral cut which allows the tool to be run at slower speeds if necessary.

Spiral Cut

Second most popular fluting style. Has only right hand spiral flutes and is intended for general purpose use on cast iron, steel, copper and brass alloys, and other ferrous materials. Offers good stock removal and excellent surface finishes

Aluminum Cut

Outstanding for rapid stock removal on soft or non-ferrous type materials. The wide flute design permits easy chip disposal. Aluminum cut burrs have special flute relief design for added strength and longer tool life. Use the aluminum cut design on aluminum, magnesium, brass, zinc alloys, lead, hard rubber and most plastics.

Style SA Cylindrical



Head Size (Inch)	Shank Diameter (Inch)	Length of Cut (Inch)	Overall Length (Inch)	Style SA Cylindrical					
				Double Cut		Spiral Cut		Aluminum Cut	
				IND Code	Code	IND Code	Code	IND Code	Code
1/16	1/8	1/4	1-1/2	SA41	938118	SA41	938056	-	-
3/32	1/8	7/16	1-1/2	SA42	938122	SA42	938058	-	-
1/8	1/8	9/16	1-1/2	SA43	938126	SA43	938062	-	-
1/8	1/8	9/16	2	SA43L2	938125	SA43L2	938061	-	-
1/8	1/8	9/16	3	SA43L3	938127	SA43L3	938063	-	-
1/8	1/4	1/2	2	SA11	938124	SA11	938060	-	-
5/32	1/8	1/2	1-1/2	SA52	938130	SA52	938066	-	-
3/16	1/8	1/2	1-1/2	SA53	938134	SA53	938070	-	-
3/16	1/4	5/8	2	SA14	938138	SA14	938074	-	-
1/4	1/8	3/16	1-7/16	SA50	938140	SA50	938076	-	-
1/4	1/8	1/2	1-3/4	SA51	938144	SA51	938080	-	-
1/4	1/4	5/8	2	SA1	938148	SA1	938084	-	-
1/4	1/4	3/4	2	-	-	-	-	SAINF	938000
1/4	1/4	5/8	6	SAIL6	938151	SAIL6	938087	-	-
5/16	1/4	3/4	2-1/2	SA2	938152	SA2	938088	-	-
3/8	1/4	3/4	2-1/2	SA3	938154	SA3	938090	SA3NF	938002
3/8	1/4	3/4	6	SA3L6	938155	SA3L6	938093	-	-
7/16	1/4	1	2-3/4	SA4	938158	SA4	938094	-	-
1/2	1/4	1	2-3/4	SA5	938160	SA5	938096	SA5NF	938004
1/2	1/4	1	6	SA5L6	938161	SA5L6	938097	-	-
5/8	1/4	1	2-3/4	SA6	938162	SA6	938098	SA6NF	938006
3/4	1/4	1	2-3/4	SA7	938168	SA7	938104	SA7NF	938008
1	1/4	1	2-3/4	SA9	938170	SA9	938106	-	-

Burrs (continued)

Carbide

Style SB with End Cut



Head Size (Inch)	Shank Diameter (Inch)	IND Code	Length of Cut (Inch)	Overall Length (Inch)	Style SB with End Cut	
					Double Cut	Spiral Cut
					Code	Code
1/16	1/8	SB41	1/4	1-1/2	938242	938180
3/32	1/8	SB42	7/16	1-1/2	938246	938184
1/8	1/8	SB43	9/16	1-1/2	938250	938188
1/8	1/4	SB11	1/2	2	938248	938186
3/16	1/4	SB14	5/8	2	938262	938200
1/4	1/8	SB50	3/16	1-3/4	-	938202
1/4	1/8	SB51	1/2	1-3/4	938268	938206
1/4	1/4	SBI	5/8	2	938272	938210
5/16	1/4	SB2	3/4	2-1/2	938276	938214
3/8	1/4	SB3	3/4	2-1/2	938278	938216
7/16	1/4	SB4	1	2-3/4	938282	938220
1/2	1/4	SB5	1	2-3/4	938284	938222
5/8	1/4	SB6	1	2-3/4	938286	938224
3/4	1/4	SB7	1	2-3/4	938292	938230

Style SC Radius Cylindrical



Head Size (Inch)	Shank Diameter (Inch)	Length of Cut (Inch)	Overall Length (Inch)	Style SC Radius Cylindrical					
				Double Cut		Spiral Cut		Aluminum Cut	
				IND Code	Code	IND Code	Code	IND Code	Code
3/32	1/8	7/16	1-1/2	SC41	938350	SC41	938304	-	-
1/8	1/8	9/16	1-1/2	SC42	938354	SC42	938308	-	-
1/8	1/8	9/16	2	SC42L2	938353	SC42L2	938307	-	-
1/8	1/8	9/16	3	SC42L3	938355	SC42L3	938309	-	-
1/8	1/4	1/2	2	SC11	938352	SC11	938306	-	-
5/32	1/8	1/2	1-1/2	SC52	938368	SC52	938322	-	-
3/16	1/8	1/2	1-1/2	SC53	938360	SC53	938314	-	-
3/16	1/4	5/8	2	SC14	938364	SC14	938318	-	-
1/4	1/8	1/2	1-3/4	SC51	938366	SC51	938320	-	-
1/4	1/4	5/8	2	SC1	938370	SC1	938324	-	-
1/4	1/4	3/4	2	-	-	-	-	SC1NF	938010
1/4	1/4	5/8	6	SC1L6	938371	SC1L6	938325	-	-
5/16	1/4	3/4	2-1/2	SC2	938374	SC2	938328	-	-
3/8	1/4	3/4	2-1/2	SC3	938376	SC3	938330	SC3NF	938012
3/8	1/4	3/4	6	SC3L6	938379	SC3L6	938331	-	-
7/16	1/4	1	2-3/4	SC4	938380	SC4	938334	-	-
1/2	1/4	1	2-3/4	SC5	938382	SC5	938336	SC5NF	938014
1/2	1/4	1	6	SC5L6	938383	SC5L6	938337	-	-
5/8	1/4	1	2-3/4	SC6	938384	SC6	938338	SC6NF	938016
3/4	1/4	1	2-3/4	SC7	938386	SC7	938340	SC7NF	938018

DEBURRING TOOLS & BURRS

Burrs (continued)

Carbide

Style SD Ball



Head Size (Inch)	Shank Diameter (Inch)	Overall Length (Inch)	Style SD Ball						
			Double Cut		Spiral Cut		Aluminum Cut		
			IND Code	Code	IND Code	Code	Length of Cut (Inch)	IND Code	Code
3/32	1/8	1-1/2	SD41	938436	SD41	938396	-	-	-
1/8	1/8	1-1/2	SD42	938438	SD42	938398	-	-	-
1/8	1/8	2	SD42L2	938437	SD42L2	938397	-	-	-
1/8	1/8	3	SD42L3	938439	SD42L3	938399	-	-	-
1/8	1/4	2	SD11	938440	SD11	938400	-	-	-
3/16	1/8	1-1/2	SD53	938442	SD53	938402	-	-	-
3/16	1/4	2	SD14	938446	SD14	938406	-	-	-
1/4	1/8	1-1/2	SD51	938448	SD51	938408	-	-	-
1/4	1/4	2	SD1	938452	SD1	938412	3/16	SD1NF	938020
1/4	1/4	6	SD1L6	938453	SD1L6	938413	-	-	-
5/16	1/4	2-1/32	SD2	938454	SD2	938414	-	-	-
3/8	1/4	2-5/64	SD3	938456	SD3	938416	5/16	SD3NF	938022
3/8	1/4	6	SD3L6	938457	SD3L6	938417	-	-	-
7/16	1/4	2-9/64	SD4	938458	SD4	938418	-	-	-
1/2	1/4	2-13/64	SD5	938460	SD5	938420	-	-	-
1/2	1/4	2-1/4	-	-	-	-	7/16	SD5NF	938024
1/2	1/4	6	SD5L6	938461	SD5L6	938421	-	-	-
5/8	1/4	2-5/16	SD6	938462	SD6	938422	9/16	SD6NF	938026
3/4	1/4	2-7/16	SD7	938464	SD7	938424	11/16	SD7NF	938028
1	1/4	2-11/16	SD9	938466	SD9	938426	-	-	-

Style SE Oval/Egg Shape



Head Size (Inch)	Shank Diameter (Inch)	Length of Cut (Inch)	Overall Length (Inch)	Style SE Oval/Egg Shape					
				Double Cut		Spiral Cut		Aluminum Cut	
				IND Code	Code	IND Code	Code	IND Code	Code
1/8	1/8	7/32	1-1/2	SE41	938504	SE41	938476	-	-
3/16	1/8	9/32	1-1/2	SE53	938506	SE53	938478	-	-
1/4	1/8	3/8	1-5/8	SE51	938510	SE51	938482	-	-
1/4	1/4	3/8	2	SE1	938514	SE1	938486	-	-
3/8	1/4	5/8	2-3/8	SE3	938516	SE3	938488	SE3NF	938030
1/2	1/4	7/8	2-5/8	SE5	938518	SE5	938490	-	-
1/2	1/4	7/8	2-3/4	-	-	-	-	SE5NF	938032
5/8	1/4	1	2-3/4	SE6	938520	SE6	938492	SE6NF	938034
3/4	1/4	1	2-1/4	SE7	938522	SE7	938494	-	-
3/4	1/4	1	2-3/4	-	-	-	-	SE7NF	938036

Burrs (continued)

Carbide

Style SG Pointed Tree



Head Size (Inch)	Shank Diameter (Inch)	IND Code	Length of Cut (Inch)	Overall Length (Inch)	Style SG Pointed Tree	
					Double Cut	Spiral Cut
					Code	Code
1/8	1/8	SG41	1/4	1-1/2	938654	938614
1/8	1/8	SG42	5/16	1-1/2	938656	938616
1/8	1/8	SG43	3/8	1-1/2	938658	938618
1/8	1/8	SG44	1/2	1-1/2	938660	938620
3/16	1/8	SG53	1/2	1-1/2	938662	938622
1/4	1/8	SG51	1/2	1-3/4	938666	938626
1/4	1/4	SG1	5/8	2	938670	938630
5/16	1/4	SG2	3/4	2-1/2	938672	938632
3/8	1/4	SG3	3/4	2-1/2	938674	938634
1/2	1/4	SG13	3/4	2-1/2	938676	938636
1/2	1/4	SG5	1	2-3/4	938678	938638
5/8	1/4	SG6	1	2-3/4	938680	938640
3/4	1/4	SG7	1	2-3/4	938682	938642

Style SF Radius Tree



Head Size (Inch)	Shank Diameter (Inch)	Length of Cut (Inch)	Overall Length (Inch)	Style SF Radius Tree					
				Double Cut		Spiral Cut		Aluminum Cut	
				IND Code	Code	IND Code	Code	IND Code	Code
1/8	1/8	1/4	1-1/2	SF41	938572	SF41	938532	-	-
1/8	1/8	1/2	1-1/2	SF42	938574	SF42	938534	-	-
3/16	1/8	1/2	1-1/2	SF53	938578	SF53	938538	-	-
1/4	1/8	1/2	1-3/4	SF51	938582	SF51	938542	-	-
1/4	1/4	5/8	2	SF1	938586	SF1	938546	-	-
1/4	1/4	3/4	2	-	-	-	-	SFINF	938038
1/4	1/4	5/8	6	SFIL6	938587	SFIL6	938547	-	-
3/8	1/4	3/4	2-1/2	SF3	938588	SF3	938548	SF3NF	938040
3/8	1/4	3/4	6	SF3L6	938589	SF3L6	938549	-	-
7/16	1/4	1	2-3/4	SF4	938590	SF4	938550	-	-
1/2	1/4	3/4	2-1/2	SF13	938592	SF13	938552	-	-
1/2	1/4	1	2-3/4	SF5	938594	SF5	938554	SF5NF	938042
1/2	1/4	1	6	SF5L6	938595	SF5L6	938555	-	-
5/8	1/4	1	2-3/4	SF6	938596	SF6	938556	SF6NF	938044
3/4	1/4	1	2-3/4	SF7	938598	SF7	938558	-	-
3/4	1/4	1-1/4	3	SF14	938600	SF14	938560	SF7NF	938046
3/4	1/4	1-1/2	3-3/4	SF15	938602	SF15	938562	-	-

DEBURRING TOOLS & BURRS

Burrs (continued)

Carbide

Style SH Flame



Head Size (Inch)	Shank Diameter (Inch)	IND Code	Length of Cut (Inch)	Overall Length (Inch)	Style SH Flame	
					Double Cut	Spiral Cut
					Code	Code
1/8	1/8	SH41	1/4	1-1/2	938718	938694
3/16	1/8	SH53	3/8	1-1/2	938720	938696
1/4	1/4	SH1	3/8	1-1/2	938724	938700
5/16	1/4	SH2	3/4	2-1/2	938726	938702
1/2	1/4	SH5	1-1/4	3	938728	938704
5/8	1/4	SH6	1-7/16	3-3/16	938730	938706
3/4	1/4	SH7	1-5/8	3-3/8	938732	938708

Style SL 8°/14° Included Angles



Head Size (Inch)	Shank Diameter (Inch)	Length of Cut (Inch)	Overall Length (Inch)	Included Angle	Style SL 8°/14° Included Angles					
					Double Cut		Spiral Cut		Aluminum Cut	
					IND Code	Code	IND Code	Code	IND Code	Code
1/8	1/8	3/8	1-1/2	8°	SL41	938808	SL41	938782	-	-
1/8	1/8	1/2	1-1/2	8°	SL42	938810	SL42	938784	-	-
3/16	1/8	1/2	1-1/2	14°	SL53	938812	SL53	938786	-	-
1/4	1/4	5/8	2	14°	SL1	938814	SL1	938788	-	-
1/4	1/4	5/8	6	14°	SL1L6	938815	SL1L6	938789	-	-
5/16	1/4	7/8	2-3/4	14°	SL2	938816	SL2	938790	-	-
3/8	1/4	1-1/16	2-15/16	14°	SL3	938818	SL3	938792	SL3NF	938050
3/8	1/4	1-1/16	6	14°	SL3L6	938819	SL3L6	938793	-	-
1/2	1/4	1-1/8	3	14°	SL4	938820	SL4	938794	SL4NF	938051
1/2	1/4	1-1/8	6	14°	SL4L6	938821	SL4L6	938795	-	-
5/8	1/4	1-5/16	3-3/16	14°	SL6	938822	SL6	938796	SL6NF	938053
3/4	1/4	1-1/2	3-3/8	14°	SL7	938824	SL7	938798	SL7NF	938054

Style SM Cone



Head Size (Inch)	Shank Diameter (Inch)	IND Code	Length of Cut (Inch)	Overall Length (Inch)	Included Angle	Style SM Cone	
						Double Cut	Spiral Cut
						Code	Code
1/8	1/8	SM41	3/8	1-1/2	12°	938864	938834
1/8	1/8	SM42	7/16	1-1/2	14°	938866	938836
1/8	1/8	SM43	5/8	1-1/2	7°	938868	938838
3/16	1/8	SM53	1/2	1-1/2	16°	938870	938840
1/4	1/8	SM51	1/2	1-7/8	22°	938872	938842
1/4	1/4	SM1	1/2	2	22°	938874	938844
1/4	1/4	SM2	3/4	2	14°	938876	938846
1/4	1/4	SM3	1	2	10°	938878	938848
3/8	1/4	SM4	5/8	2-1/2	28°	938880	938850
1/2	1/4	SM5	7/8	2-3/4	28°	938882	938852
5/8	1/4	SM6	1	2-7/8	31°	938884	938854

Burrs (continued)

Carbide

Style SN Inverted Taper



Head Size (Inch)	Shank Diameter (Inch)	IND Code	Length of Cut (Inch)	Overall Length (Inch)	Included Angle	Style SN Inverted Taper	
						Double Cut	Spiral Cut
						Code	Code
3/32	1/8	SN41	1/8	1-1/2	10°	938916	938894
1/8	1/8	SN42	3/16	1-1/2	10°	938918	938896
3/16	1/8	SN53	1/4	1-1/2	10°	938920	938898
1/4	1/8	SN51	1/4	1-1/2	10°	938922	938900
1/4	1/4	SNI	5/16	2	10°	938924	938902
1/2	1/4	SN4	1/2	2-1/4	28°	938926	938904

Style SK Cone – 90°



Diameter (Inch)	Shank Diameter (Inch)	Length of Cut (Inch)	Code	Diameter (Inch)	Shank Diameter (Inch)	Length of Cut (Inch)	Code
1/4	1/4	1/8	938762	3/4	1/4	3/8	938770
3/8	1/4	3/16	938764	1	1/4	1/2	938772
1/2	1/4	1/4	938766				
5/8	1/4	5/16	938768				

Burr Sets – Double Cut

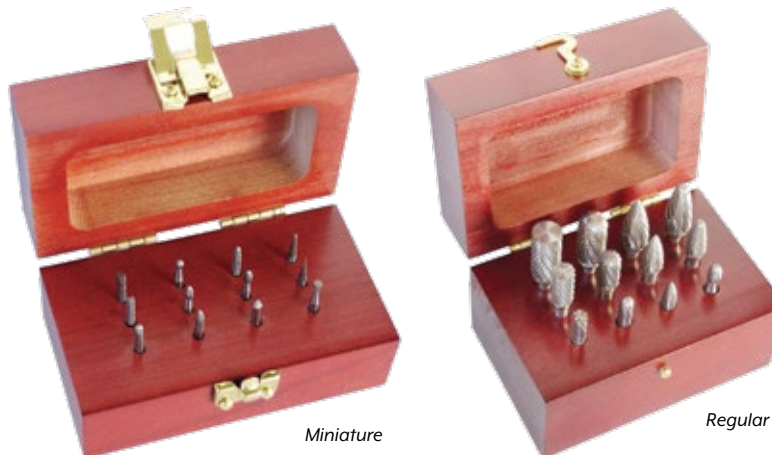

Shank Diameter (Inch)	Set Style	Burrs Included	No. of Pieces	Code
1/8	Miniature	SA42; SA43; SC42; SD42; SE41; SF41; SF42; SG41; SH41; SL41; SM43; SN42	12	938928
1/4	Regular	SA14; SA1; SC14; SC1; SD14; SD1; SE1; SF1; SG1; SM1; SM2; SNI	12	938930
1/4	Regular	SBI; SB3; SB5; SD1; SD3; SD5; SE1; SE3; SE5	9	938931
1/4	Regular	SB3; SC3; SD3; SE3; SF3; SG3; SK3; SL3; SM3	9	939032

DEBURRING TOOLS & BURRS

Brazed Tools

For Cast Iron/Non-Ferrous (C2) and Steel (C5/C6)

<p>STYLE A</p>	<p>STYLE B</p>	<p>STYLE C</p>
<p>STYLE D</p>	<p>STYLE F</p>	<p>STYLE G</p>
<p>STYLE E</p>	<p>STYLE CT</p>	<p>STYLE ER 60° Offset V-Threading</p>

Brazed Tools (continued)

For Cast Iron/Non-Ferrous (C2) and Steel (C5/C6)

A (Inch)	B (Inch)	C (Inch)	W (Inch)	Right Hand			Left Hand		
				Type	C5/C6	C2	Type	C5/C6	C2
					Code	Code		Code	Code
1/4	1/4	2	-	AR4	313208	313215	AL4	313222	313229
5/16	5/16	2-1/4	-	AR5	313209	313216	AL5	313223	313230
3/8	3/8	2-1/2	-	AR6	313210	313217	AL6	313224	313231
7/16	7/16	3	-	AR7	313211	313218	AL7	313225	313232
1/2	1/2	3-1/2	-	AR8	313212	313219	AL8	313226	313233
5/8	5/8	4	-	ARI0	313213	313220	ALI0	313227	313234
3/4	3/4	4-1/2	-	ARI2	313214	313221	ALI2	313228	313235
1/4	1/4	2	-	BR4	313236	313243	BL4	313250	313257
5/16	5/16	2-1/4	-	BR5	313237	313244	BL5	313251	313258
3/8	3/8	2-1/2	-	BR6	313238	313245	BL6	313252	313259
7/16	7/16	3	-	BR7	313239	313246	BL7	313253	313260
1/2	1/2	3-1/2	-	BR8	313240	313247	BL8	313254	313261
5/8	5/8	4	-	BR10	313241	313248	BL10	313255	313262
3/4	3/4	4-1/2	-	BR12	313242	313249	BL12	313256	313263
1/4	1/4	2	-	C4	313278	313285	C4	313278	313285
5/16	5/16	2-1/4	-	C5	313279	313286	C5	313279	313286
3/8	3/8	2-1/2	-	C6	313280	313287	C6	313280	313287
7/16	7/16	3	-	C7	313281	313288	C7	313281	313288
1/2	1/2	3-1/2	-	C8	313282	313289	C8	313282	313289
5/8	5/8	4	-	C10	313283	313290	C10	313283	313290
3/4	3/4	4-1/2	-	C12	313284	313291	C12	313284	313291
1/4	1/4	2	-	D4	313292	313299	D4	313292	313299
5/16	5/16	2-1/4	-	D5	313293	313300	D5	313293	313300
3/8	3/8	2-1/2	-	D6	313294	313301	D6	313294	313301
7/16	7/16	3	-	D7	313295	313302	D7	313295	313302
1/2	1/2	3-1/2	-	D8	313296	313303	D8	313296	313303
5/8	5/8	4	-	D10	313297	313304	D10	313297	313304
3/4	3/4	4-1/2	-	D12	313298	313305	D12	313298	313305
1/2	1/2	3-1/2	-	FR8	313322	313326	FL8	313330	313334
5/8	5/8	4	-	FR10	313323	313327	FL10	313331	313335
3/4	3/4	4-1/2	-	FR12	313324	313328	FL12	313332	313336
1	1	7	-	FR16	313325	313329	FL16	313333	313337
1/2	1/2	3-1/2	-	GR8	313338	313342	GL8	313346	313350
5/8	5/8	4	-	GR10	313339	313343	GL10	313347	313351
3/4	3/4	4-1/2	-	GR12	313340	313344	GL12	313348	313352
1	1	7	-	GR16	313341	313345	GL16	313349	313353
1/4	1/4	2	-	E4	313264	313271	E4	313264	313271
5/16	5/16	2-1/4	-	E5	313265	313272	E5	313265	313272
3/8	3/8	2-1/2	-	E6	313266	313273	E6	313266	313273
7/16	7/16	3	-	E7	313267	313274	E7	313267	313274
1/2	1/2	3-1/2	-	E8	313268	313275	E8	313268	313275
5/8	5/8	4	-	E10	313269	313276	E10	313269	313276
3/4	3/4	4-1/2	-	E12	313270	313277	E12	313270	313277
1/2	1	5	1/8	CTR11	313306	313307	CTL11	313308	313309
1/2	1	5	3/16	CTR22	313310	313311	CTL22	313312	313313
1/2	1	5	1/4	CTR33	313314	313315	CTL33	313316	313317
1/2	1	5	5/16	CTR44	313318	313319	CTL44	313320	313321
1/4	1/4	2	-	ER4	313354	313360	EL4	021824	313371
5/16	5/16	2-1/4	-	ER5	313355	313361	EL5	313366	313372
3/8	3/8	2-1/2	-	ER6	313356	313362	EL6	313367	313373
1/2	1/2	3-1/2	-	ER8	313357	313363	EL8	313368	313374
5/8	5/8	4	-	ER10	313358	313364	EL10	313369	313375
3/4	3/4	4-1/2	-	ER12	313359	313365	EL12	313370	313376

Fly Cutter Sets

Hardened Steel



- No need for expensive end mills and end mill sharpening
- Counterbalanced for smoother finishes and faster feeds
- 3 sizes per set
- Machines up to a 6" wide surface with a standard tool bit

Shank Diameter (Inch)	Head Diameter (Inch)	Tool Bit Size (Inch)	Code
1/2	3/4; 1-1/8; 1-1/2	3/16; 1/4; 5/16	505400
3/4	1-1/2; 2; 2-1/2	5/16; 5/16; 5/16	505401

Turning Tool Holders

For High Speed Steel Toolbits



Model	Holder Size (Inch)	Square Tool (Inch)	Approx. Swing	Right Hand	Left Hand	Straight
				Code	Code	
TH/3	3/16 x 3/4 x 4-1/2	3/16	7-10	577470	577483	577484
TH/4	3/8 x 7/8 x 5	1/4	10-12	577471	577485	577486
TH/5	1/2 x 1-1/8 x 6	5/16	14-16	577472	577487	577488
TH/6	5/8 x 1-3/8 x 7	3/8	16-18	577473	577489	577490
TH/7	3/4 x 1-5/8 x 8	7/16	18-20	577474	577491	577492
TH/8	7/8 x 1-3/4 x 9	1/2	24-36	577475	577493	577494

Part-Off Tool Holders

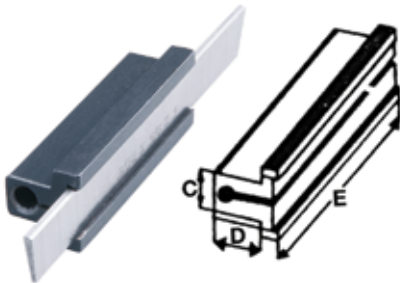

Model	Blade Size (Inch)	Blade Reference	C (Inch)	D (Inch)	E (Inch)	Code
PT/1	3/32 x 1/2 x 4	180274	1/2	1/2	2-3/4	180271
PT/2	3/32 x 5/8 x 5	180275	1/2	9/16	2-3/4	180272
PT/3	1/8 x 3/4 x 6	180276	11/16	3/4	3-3/8	180273

Replacement Blades

Model	Blade Size (Inch)	Code
COB/0-2	3/32 x 1/2 x 4	180274
COB/0-3	3/32 x 5/8 x 5	180275
COB/0-4	1/8 x 3/4 x 6	180276

Part-Off Tool Holders



Model	Shank Size (Inch)	Blade Size (Inch)	Blade Reference	Right Hand	Left Hand	Straight
				Code	Code	
CT/0	5/16 x 9/16 x 3-11/16	1/16 x 5/16	-	577476	577495	577496
CT/1	5/16 x 3/4 x 4-1/2	3/32 x 1/2	516120	577477	577497	577498
CT/2	3/8 x 7/8 x 5	3/32 x 5/8	516121	577478	577499	577500
CT/3	1/2 x 1-1/8 x 6	1/8 x 3/4	516122	577479	577501	577502
CT/4	5/8 x 1-3/8 x 7	1/8 x 7/8	516123	577480	577503	577504
CT/5	3/4 x 1-5/8 x 8	3/16 x 1	516124	577481	577505	577506
CT/6	7/8 x 1-3/4 x 9	3/16 x 1-1/8	516125	577482	577507	577508

Boring Bar Holders

Square



Model	Holder Size (Inch)	Bar Size (Inch)	Code
BH/1-2	3/4 x 3/4 x 3	1/2	180282
BH/5-8	7/8 x 7/8 x 3-1/4	5/8	180283
BH/3-4	1 x 1 x 3-1/4	3/4	180284

Part-Off Tools

Holder & Blades



Holders – Model 259

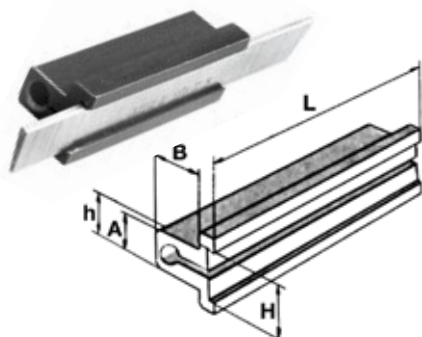

Size	H (Inch)	h (Inch)	A (Inch)	B (Inch)	L (Inch)	Code
1	1/2	1/2	1/2	9/16	2-3/4	515411
2	11/16	1/2	1/2	1/2	2-3/4	515412
3	1	7/8	13/16	3/4	3-1/8	515413

Blades – for Model 259

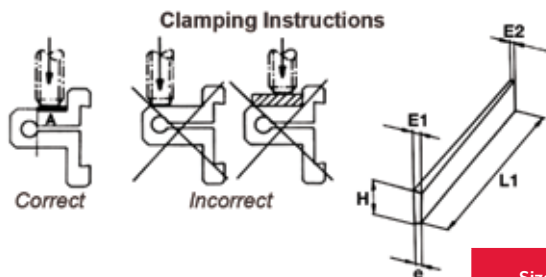

- Made of a special high speed steel with 5% cobalt
- Extremely wear resistant
- Side clearance and back tapered from front to back for minimum friction on deep cuts

Size	H (Inch)	L1 (Inch)	E1 (Inch)	E2 (Inch)	e (Inch)	Code
1	1/2	4	0.118	0.087	0.085	515421
2	11/16	5-1/2	0.157	0.110	0.107	515422
3	1	6	0.177	0.125	0.108	515423

Blade size 3 will fit holder size 3

Part-Off Blades

High Speed Steel

- T-shaped
- Ground



Not compatible with holders above

Style	Size W x H (Inch)	Length (Inch)	Code	Style	Size W x H (Inch)	Length (Inch)	Code
P1	1/16 x 1/2	4-1/2	516101	P5N	5/32 x 7/8	6	516111
P2	3/32 x 1/2	4-1/2	516102	P4X	5/32 x 1-1/8	6-1/2	516112
P3N	3/32 x 11/16	5	516103	P5S	3/16 x 11/16	5	516113
P3S	1/8 x 1/2	4-1/2	516104	P5W	3/16 x 3/4	5	516114
P3	1/8 x 11/16	5	516105	P5	3/16 x 7/8	6	516115
P3W	1/8 x 3/4	5	516106	P8	3/16 x 1-1/8	6-1/2	516116
P5X	1/8 x 7/8	6	516107	P6	1/4 x 7/8	6	516117
P8X	1/8 x 1-1/8	6-1/2	516108	P9	1/4 x 1-1/8	6-1/2	516118
P4	5/32 x 11/16	5	516109				
P4W	5/32 x 3/4	5	516110				

Part-Off Blades

Cobalt

• Ground



End View

Size W x H (Inch)	Length (Inch)	Code
3/32 x 1/2	4	516120
3/32 x 5/8	5	516121

Size W x H (Inch)	Length (Inch)	Code
1/8 x 3/4	5	516122
1/8 x 7/8	6	516123

Size W x H (Inch)	Length (Inch)	Code
3/16 x 1	6	516124
3/16 x 1-1/8	6	516125

Tool Bits

High Speed Steel M2 & Cobalt

• Ground

Square



Size Square x Length (Inch)	HSS	Cobalt
	Code	Code
1/8 x 2-1/2	516130	516230
3/16 x 2-1/2	516131	516231
1/4 x 2-1/2	516132	516232
5/16 x 2-1/2	516133	516233

Size Square x Length (Inch)	HSS	Cobalt
	Code	Code
3/8 x 3	516134	516234
7/16 x 3-1/2	516135	516235
1/2 x 4	516136	516236
5/8 x 4-1/2	516137	516237

Size Square x Length (Inch)	HSS	Cobalt
	Code	Code
3/4 x 5	516138	516238
3/4 x 6	516139	516239
7/8 x 6	516140	516240
1 x 6	516141	516241
1 x 7	516142	516242
1 x 8	-	516243

Rectangular



Size W x H x L (Inch)	HSS
	Code
1/4 x 3/8 x 2-1/2	516350
1/4 x 1/2 x 4	516351
1/4 x 3/4 x 5	516352
1/4 x 1 x 6	516353

Size W x H x L (Inch)	HSS
	Code
5/16 x 1/2 x 4	516354
5/16 x 3/4 x 5	516355
3/8 x 1/2 x 4	516356
3/8 x 3/4 x 5	516357

Size W x H x L (Inch)	HSS
	Code
3/8 x 1 x 6	516358
1/2 x 3/4 x 5	516359
1/2 x 1 x 7	516360
5/8 x 1 x 7	516361
3/4 x 1 x 7	516362

Round



Size Diameter x Length (Inch)	HSS	Cobalt
	Code	Code
1/8 x 2-3/4	516370	516390
3/16 x 3-1/2	516371	516391
1/4 x 2-1/2	516372	516392
1/4 x 4	516373	516393

Size Diameter x Length (Inch)	HSS	Cobalt
	Code	Code
5/16 x 2	516374	516394
5/16 x 4	516375	516395
3/8 x 3	516376	516396
3/8 x 5	516377	516397

Size Diameter x Length (Inch)	HSS	Cobalt
	Code	Code
1/2 x 4	516378	516398
1/2 x 6	516379	516399
5/8 x 3	516380	516400
5/8 x 6	516381	516401
3/4 x 6	516382	516402
1 x 6	516383	-

Knurling Tools

Knurling Tool Holders



- KT2/KT6 requires RH and LH knurls to produce diamond pattern
- KTO produces diamond pattern with D knurls

Model	Shank Size (Inch)	Knurl Dimensions (Inch)	Code
KT/0-1	4 x 1/2 x 1/2	3/4 x 1/4 x 1/4	606100
KT/2-2	6-1/2 x 1-1/8 x 1/2	3/4 x 1/4 x 3/8	606101
KT/2-3	5-1/2 x 7/8 x 3/8	5/8 x 7/32 x 5/16	606102
KT/2-4	5 x 3/4 x 5/16	5/8 x 7/32 x 5/16	606103
KT/2-5	4-1/2 x 1/2 x 1/2	3/4 x 1/4 x 3/8	606104
KT/6-1	7-1/2 x 1-3/8 x 5/8	3/4 x 1/4 x 3/8	606105

Model	Shank Size (Inch)	Knurl Dimensions (Inch)	Code
KT/6-2	6-1/2 x 1-1/8 x 1/2	3/4 x 1/4 x 3/8	606106
KT/6-3	5-1/2 x 7/8 x 3/8	5/8 x 7/32 x 5/16	606107
KT/6-4	5 x 3/4 x 5/16	5/8 x 7/32 x 5/16	606108
KT/6-5M	20 x 27 x 18	20 x 6 x 8	606109

High Speed Steel – Cutters



Type	Diameter	Hole Diameter	Width	TPI	Code
Right Hand	5/8"	7/32"	5/16"	Fine	606143
Right Hand	5/8"	7/32"	5/16"	Medium	606146
Right Hand	5/8"	7/32"	5/16"	Coarse	606149
Right Hand	3/4"	1/4"	3/8"	Fine	606152
Right Hand	3/4"	1/4"	3/8"	Medium	606155
Right Hand	3/4"	1/4"	3/8"	Coarse	606158
Right Hand	1"	5/16"	3/8"	Fine	606161
Right Hand	1"	5/16"	3/8"	Medium	606164
Right Hand	1"	5/16"	3/8"	Coarse	606167
Right Hand	20 mm	6 mm	8 mm	Fine	606170
Right Hand	20 mm	6 mm	8 mm	Medium	606173
Right Hand	20 mm	6 mm	8 mm	Coarse	606176
Left Hand	5/8"	7/32"	5/16"	Fine	606142
Left Hand	5/8"	7/32"	5/16"	Medium	606145
Left Hand	5/8"	7/32"	5/16"	Coarse	606148
Left Hand	3/4"	1/4"	3/8"	Fine	606151
Left Hand	3/4"	1/4"	3/8"	Medium	606154
Left Hand	3/4"	1/4"	3/8"	Coarse	606157
Left Hand	1"	5/16"	3/8"	Fine	606160
Left Hand	1"	5/16"	3/8"	Medium	606163
Left Hand	1"	5/16"	3/8"	Coarse	606166
Left Hand	20 mm	6 mm	8 mm	Fine	606169
Left Hand	20 mm	6 mm	8 mm	Medium	606172
Left Hand	20 mm	6 mm	8 mm	Coarse	606175
Diamond	3/4"	1/4"	1/4"	Fine	606110
Diamond	3/4"	1/4"	1/4"	Medium	606111
Diamond	3/4"	1/4"	1/4"	Coarse	606112
Diamond	5/8"	7/32"	5/16"	Fine	606113

Type	Diameter	Hole Diameter	Width	TPI	Code
Diamond	5/8"	7/32"	5/16"	Medium	606114
Diamond	5/8"	7/32"	5/16"	Coarse	606115
Diamond	3/4"	1/4"	3/8"	Fine	606116
Diamond	3/4"	1/4"	3/8"	Medium	606117
Diamond	3/4"	1/4"	3/8"	Coarse	606118
Diamond	1"	5/16"	3/8"	Fine	606119
Diamond	1"	5/16"	3/8"	Medium	606120
Diamond	1"	5/16"	3/8"	Coarse	606121
Diamond	20 mm	6 mm	8 mm	Fine	606122
Diamond	20 mm	6 mm	8 mm	Medium	606123
Diamond	20 mm	6 mm	8 mm	Coarse	606124
Straight	3/4"	1/4"	1/4"	Fine	606137
Straight	3/4"	1/4"	1/4"	Medium	606140
Straight	3/4"	1/4"	1/4"	Coarse	606141
Straight	5/8"	7/32"	5/16"	Fine	606144
Straight	5/8"	7/32"	5/16"	Medium	606147
Straight	5/8"	7/32"	5/16"	Coarse	606150
Straight	3/4"	1/4"	3/8"	Fine	606153
Straight	3/4"	1/4"	3/8"	Medium	606156
Straight	3/4"	1/4"	3/8"	Coarse	606159
Straight	1"	5/16"	3/8"	Fine	606162
Straight	1"	5/16"	3/8"	Medium	606165
Straight	1"	5/16"	3/8"	Coarse	606168
Straight	20 mm	6 mm	8 mm	Fine	606171
Straight	20 mm	6 mm	8 mm	Medium	606174
Straight	20 mm	6 mm	8 mm	Coarse	606177

Knurling Tools



Form Knurling & Cut Knurling

Model M10 – Straight – Form Knurling

- Recommended for RAA type knurling
- Straight knurling up to face
- High speed steel bushing
- Able to fit on right hand or left hand
- Wear resistant tool surface
- Adjustment of tool clearance angle by threaded studs integrated in the shank
- Supplied with a high speed steel hardened washer to prevent tool wear

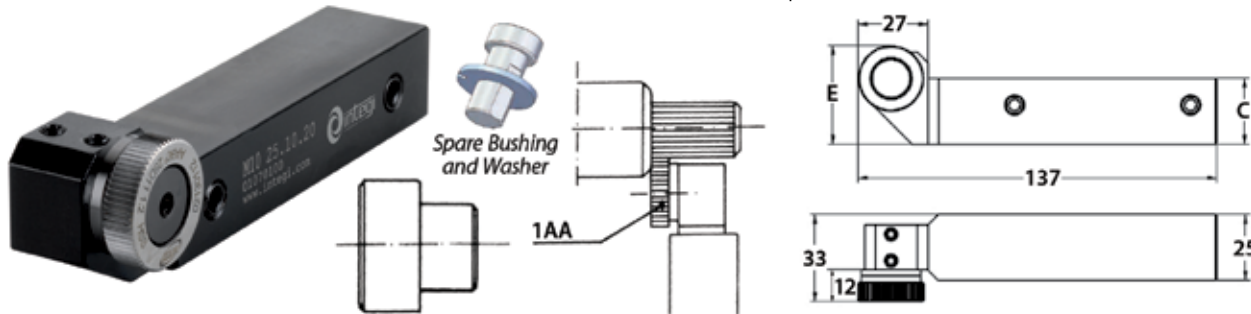

Model	Version	Capacity (mm)	Knurl Size (mm)	C (mm)	E (mm)	Weight (kg)	Spare Bushing/Washer Code	Code
M10 25.10.20	R+L	Ø8-200	25 x 10 x 11 (or 15)	20	30	0.7	180198	180305
M10 25.10.25	R+L	Ø8-200	25 x 10 x 11 (or 15)	25	35	0.8	180198	180307

Form Knurls – Type AA for Model M10 Knurling Tools – High Speed Steel



- Knurls according to DIN403 for knurlings as DIN82
- HRC 61±1 standard
- High speed steel 180421 Ground faces and central bore
- Knurls sold separately

Pitch (mm)	Size (mm)	Code	Pitch (mm)	Size (mm)	Code
0.4	25 x 10 x 11	180310	1.2	25 x 10 x 11	180322
0.5		180312	1.4		180324
0.6		180314	1.5		180326
0.7		180316	1.6		180328
0.8		180318	1.8		180330
1.0		180320	2.0		180332

Model M2 – Form Knurling

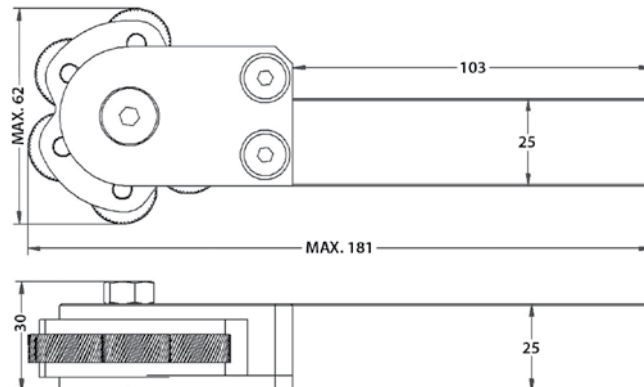

- For conventional lathes
- Recommended for RGE type knurling
- Revolving head for knurles self-centering
- For non-repetitive works
- High speed steel pins
- Knurls sold separately



Model	Version	Capacity (mm)	Knurl Size (mm)	Weight (kg)	Spare Pin Code	Code
M2 20.08.25	R+L	Ø8-200	20 x 8 x 6	1.0	180174	180405



Knurling Tools

Form Knurling & Cut Knurling (continued)

Model M3 – Form Knurling

- For conventional lathes
- Recommended for RGE type knurling
- Knurls self-centering by threaded spindle
- Double position of the arms for higher working capacity
- Lower risk of bending the workpiece as tool does not make radial pressure
- Suitable for non-repetive work
- High speed steel pins fixed by circlip
- Knurls sold separately

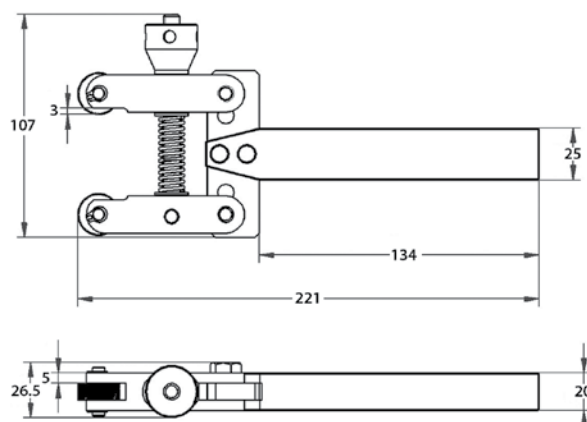

Model	Version	Capacity (mm)	Knurl Size (mm)	Weight (kg)	Spare Pin/Circlip Set Code	Code
M3 20.08.25	R+L	Pos A: Ø5-40 Pos B: Ø30-50	20 x 8 x 6	1.2	180201	180177

Form Knurls – Type AA, BL30° and BR30° for Models M2 & M3

- Knurls according to DIN403 for knurlings as DIN82
- HRC 61±1 standard
- High speed steel
- Ground faces and central bore
- Knurls sold separately

Pitch (mm)	Size (mm)	AA Straight	BL30°	BR30°
		Code	Code	Code
0.5	20 x 8 x 6		–	–
0.6		180403	180414	180422
0.8		180406	180415	180423
1.0		180407	180416	180424
1.2		180408	180417	180425
1.5		180409	180418	180426
1.6		180410	180419	180427
1.8		180411	180420	180428
2.0		180412	180421	180429

Model MF14 – Cut Knurling



- Recommended for RGE type knurling
- Easy setting to the workpiece diameter by means of a graduated scale
- Pivoting head for knurls self-centering
- High speed steel TiN coated bushing
- Adjustment of tool clearance angle by threaded studs integrated in the shank

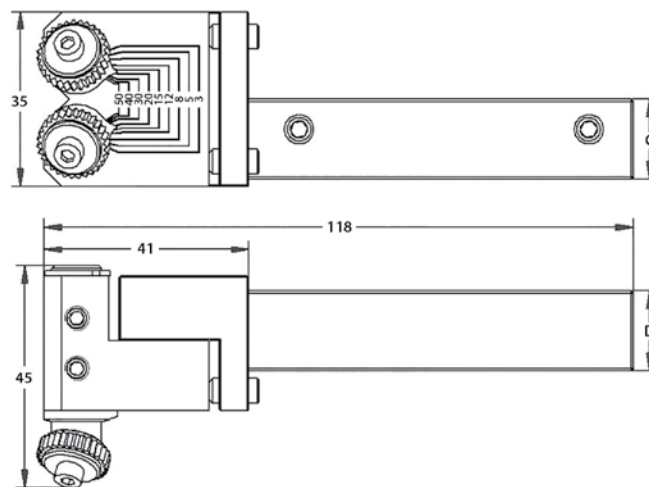

Model	Version	Capacity (mm)	Knurl Size (mm)	C (mm)	D (mm)	Weight (kg)	Spare Bushing/Washer Code	Code
MF14.53.16R	R	Ø3+50	14.5 x 3 x 5	16	16	0.5	175390	180178
MF14.53.16L	L	Ø3+50	14.5 x 3 x 5	16	16	0.5	175390	180179

Knurling Tools



Form Knurling & Cut Knurling (continued)

Model MF21 – Cut Knurling

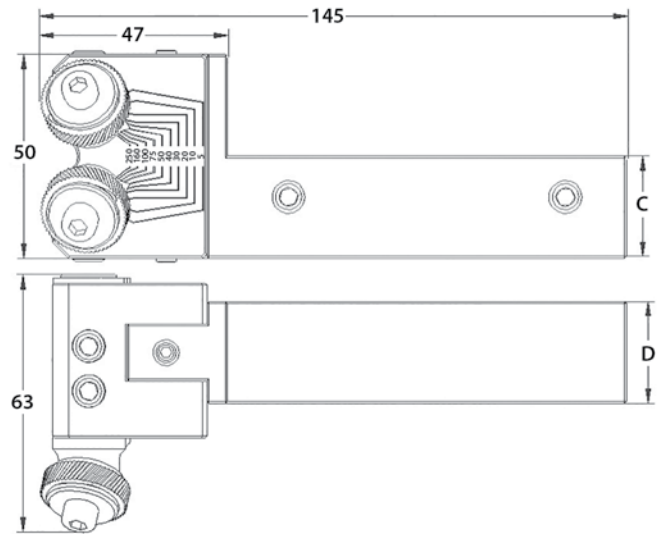

- Recommended for RGE type knurling
- Easy setting to the workpiece diameter by means of a graduated scale
- Up and down tool head alignment for knurls centering
- Tool with reversible head able to fit on left hand or right hand lathes
- High speed steel TiN coated bushing
- Adjustment of tool clearance angle by threaded studs integrated in the shank

Model	Version	Capacity (mm)	Knurl Size (mm)	C (mm)	D (mm)	Weight (kg)	Spare Bushing/Washer Code	Code
MF21.55.20	R+L	Ø5÷250	21.5 x 5 x 8	20	25	1.3	175490	180180
MF21.55.25	R+L	Ø5÷250	21.5 x 5 x 8	25	25	1.4	175490	180182

Model MFS14 – Cut Knurling

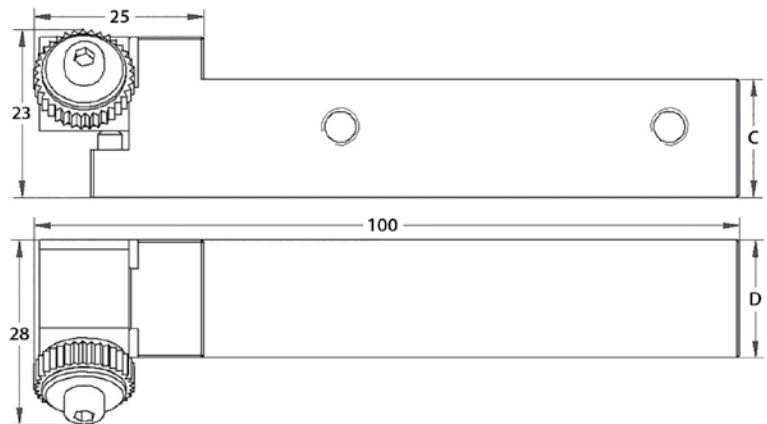
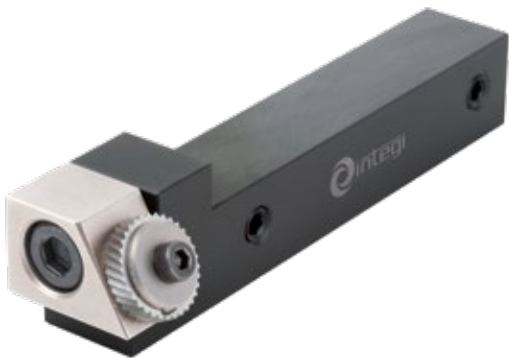

- Recommended for RAA type knurling
- Pivoting head for knurl alignment
- Tool with reversible head able to fit on left hand or right hand lathes
- High speed steel TiN coated bushing
- Adjustment of tool clearance angle by threaded studs integrated in the shank

Model	Version	Capacity (mm)	Knurl Size (mm)	C (mm)	D (mm)	Weight (kg)	Spare Bushing/Washer Code	Code
MFS14.53.16	R+L	Ø3÷50	14.5 x 3 x 5	16	16	0.2	175390	180184

Knurling Tools

Form Knurling & Cut Knurling (continued)

Model MFS21 – Cut Knurling

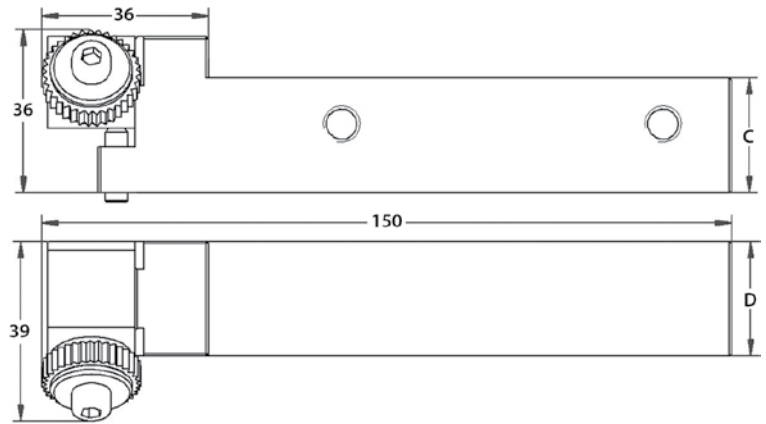

- Recommended for RAA type knurling
- Pivoting head for knurl alignment
- Tool with reversible head able to fit on left hand or right hand lathes
- High speed steel TiN coated bushing
- Adjustment of tool clearance angle by threaded studs integrated in the shank

Model	Version	Capacity (mm)	Knurl Size (mm)	C (mm)	D (mm)	Weight (kg)	Spare Bushing/Washer Code	Code
MFS21.55.20	R+L	Ø4÷250	21.5 x 5 x 8	20	25	0.8	175490	180185
MFS21.55.25	R+L	Ø4÷250	21.5 x 5 x 8	25	25	0.8	175490	180187

Cut Knurls – Type AA and BR30° for Models MFS14 & MFS21

- Knurls according to DIN403 for knurlings as DIN82
- HRC 61±1 standard
- High speed steel
- Ground faces and central bore
- Knurls sold individually

Pitch (mm)	Ø 14.5 BR30°	Ø 14.5 AA	Ø 21.5 BR30°	Ø 21.5 AA
	Code	Code	Code	Code
0.3	-	-	175433	-
0.4	175295	175304	175434	175404
0.5	175296	175305	175435	175405
0.6	175297	175306	175436	175406
0.8	175298	175308	175438	175408
1.0	175299	175310	175440	175410
1.2	175300	175312	175442	175412
1.5	-	-	175445	175415
1.6	-	-	175446	175416
2.0	-	-	175450	175420

Spare Bushing, Washer & Screw Sets for Cut Knurling Cutters



For Cutter Diameter...	Code
14.5	175390
21.5	175490

Annular Cutters

High Speed Steel

- Eliminates multi-step drilling
- Lower cost per hole
- Better finish
- More accurate and cleaner holes
- Longer tool life
- 3/4" shank diameter with two flats
- Cutters are interchangeable with other standard hole cutting systems

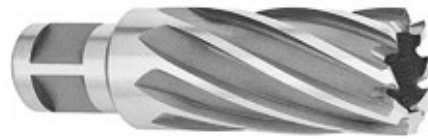

Size (Inch)	Depth			Size (Inch)	Depth		
	1 Inch	2 Inch	3 Inch		1 Inch	2 Inch	3 Inch
	Code	Code	Code		Code	Code	Code
7/16	606332	606359	-	1-5/16	606346	606373	606393
1/2	606333	606360	-	1-3/8	606347	606374	606394
9/16	606334	606361	-	1-7/16	606348	606375	606395
5/8	606335	606362	-	1-1/2	606349	606376	606396
11/16	606336	606363	-	1-9/16	606350	606377	606397
3/4	606337	606364	-	1-5/8	606351	606378	606398
13/16	606338	606365	-	1-11/16	606352	606379	-
7/8	606339	606366	606386	1-3/4	606353	606380	606400
15/16	606340	606367	606387	1-13/16	606354	606381	-
1	606341	606368	606388	1-7/8	606355	606382	-
1-1/16	606342	606369	606389	1-15/16	606356	606383	-
1-1/8	606343	606370	606390	2	606357	606384	606403
1-3/16	606344	606371	606391	2-1/16	606358	606385	-
1-1/4	606345	606372	606392				

Ejectors

Description	Code
Ejector - Pilot, Short 1/4" x 3" (For all 1" cutter depths except 7/16" diameter)	606406
Ejector - Pilot, Long 1/4" x 4" (For all 2" cutter depths except 7/16" diameter)	606407
Ejector - Pilot, Extra Long 1/4" x 5" (For all 3" cutter depths)	606408

Annular Cutter Holders

Straight, Morse Taper & R8 Shanks

- Holder shanks allow different machines drive cutters
- Easily reach difficult places
- Selected adapter lengths reduce the number of machine set ups



Straight Shank – 3 Flats – Series 7980

Type	Shank Size (Inch)	Cutter Shank Size (Inch)	Gage Length (Inch)	Code
HEN-1	1/2	3/4	2-1/8	606300
HEN-2	3/4	3/4	2	606301
HEN-2-6	3/4	3/4	6	606302
HEN-2-12	3/4	3/4	12	606303

Straight Shank – 2 Flats – Series 7983

Type	Shank Size (Inch)	Cutter Shank Size (Inch)	Gage Length (Inch)	Code
HEN-9-6	3/4	3/4	6	606307

CUTTERS SOLD SEPARATELY

Annular Cutter Holders

Straight, Morse Taper & R8 Shanks (*continued*)

Morse Taper Shank – Series 7981

Type	Shank Size (Inch)	Cutter Shank Size (Inch)	Gage Length (Inch)	Code
HEN-3	MT2	3/4	2	606309
HEN-3-6	MT2	3/4	6	606310
HEN-3-12	MT2	3/4	12	606311
HEN-4	MT3	3/4	2	606312
HEN-4-6	MT3	3/4	6	606313
HEN-4-12	MT3	3/4	12	606314

R8 Shank – Series 7982

Type	Shank Size (Inch)	Cutter Shank Size (Inch)	Gage Length (Inch)	Code
HEN-5	R8	3/4	1-3/4	606318
HEN-5-12	R8	3/4	12	606320

Annular Cutters



M42 Cobalt – 3/4 Inch Shank



Size (mm)	Cobalt M42	
	Depth	
	25 mm Code	50 mm Code
12	620100	620154
13	620101	620155
14	620102	620156
15	620103	620157
16	620104	620158
17	620105	620159
18	620106	620160
19	620107	620161
20	620108	620162
21	620109	620163
22	620110	620164
23	620111	620165
24	620112	620166
25	620113	620167
26	620114	620168
27	620115	620169
28	620116	620170
29	620117	620171
30	620118	620172
31	620119	620173
32	620120	620174
33	620121	620175
34	620122	620176
35	620123	620177
36	620124	620178
37	620125	620179
38	620126	620180
39	620127	620181

Size (mm)	Cobalt M42	
	Depth	
	25 mm Code	50 mm Code
40	620128	620182
41	620129	620183
42	620130	620184
43	620131	620185
44	620132	620186
45	620133	620187
46	620134	620188
47	620135	620189
48	620136	620190
49	620137	620191
50	620138	620192
51	620139	620193
52	620140	620194
53	620141	620195
54	620142	620196
55	620143	620197
56	620144	620198
57	620145	620199
58	620146	620200
59	620147	620201
60	620148	620202
61	620149	620203
62	620150	620204
63	620151	620205
64	620152	620206
65	620153	620207

Ejectors

Description	Code
Pilot Short for 25 mm depth cutters	620316
Pilot Long for 50 mm depth cutters	620317

Bridge Reamer Holders

Square & Spline Drives

- No need to weld a nut to the back of bridge reamers
- Tools last longer by keeping reamer straight and rigid in the bridge reamer adapter
- Reamer is securely held in the bridge reamer holder until removed



Square Drive

Type	Drive Size (Inch)	Reamer Shank	Overall Length (Inch)	Code
HEN-2BRA	3/4	MT3	6	606325
HEN-3BRA	3/4	MT4	7	606326
HEN-4BRA	1	MT2	5-1/2	606327
HEN-5BRA	1	MT3	6-1/2	606328
HEN-6BRA	1	MT4	7-1/2	606329

Spline Drive

Type	Drive Size (Inch)	Reamer Shank	Overall Length (Inch)	Code
HEN-7BRA	#5	MT3	7-1/4	606330
HEN-8BRA	#5	MT4	8-1/2	606331

Hole Cutters

High Speed Steel

- Pilot drill supplied with each cutter
- Recommended for use in hand-held air or electric drill motors, as well as light drill press applications in sheet metal, thin wall tubing, steel plate, or any other large diameter shallow hole cutting
- Centers quickly and is held securely in position after the pilot drill has entered the work piece - cutter body then cuts a clean, burr-free hole
- With normal care tool life is significantly longer than other hole cutting tools
- Inexpensive resharpening will allow repeat use



Size (Inch)	No. of Flutes	3/8" Shank/ 3/16" Pilot	1/2" Shank/ 1/4" Pilot
		Code	Code
1/2	4	311041	311044
9/16	4	311042	311045
5/8	4	311043	311046
11/16	4	-	311047
3/4	4	-	311048
13/16	4	-	311049
7/8	4	-	311050
29/32	4	-	311051

Size (Inch)	No. of Flutes	3/8" Shank/ 3/16" Pilot	1/2" Shank/ 1/4" Pilot
		Code	Code
15/16	5	-	311052
1	5	-	311053
1-1/16	5	-	311054
1-1/8	5	-	311055
1-3/16	5	-	311056
1-1/4	5	-	311057
1-5/16	5	-	311058
1-3/8	5	-	311059

Size (Inch)	No. of Flutes	3/8" Shank/ 3/16" Pilot	1/2" Shank/ 1/4" Pilot
		Code	Code
1-1/2	5	-	311060
1-5/8	6	-	311061
1-3/4	6	-	311062
1-7/8	6	-	311063
2	6	-	311064

32nd, 64th and Metric sizes available

Turning

216-260



Grooving

253-257



Parting

258-259



Threading

260-266



Milling

267-292



Thread Milling

283-294



For Indexable Cutting Tool
Technical Information
see pages 295-298

External Tool Holder Identification Guide

Insert Mounting Method	Insert Shape		Insert Clearance Angle	Hand of Tool
 C - Clamp Lock	 80°	 55°	 5° B	 L - Left Hand
 M - Multi Lock	 55°	 R	 7° C	
 P - Lever Lock	 S	 T	 15° D	 N - Neutral
 S - Screw Lock	 35°	 80°	 20° E	
			 10° N	 R - Right Hand
			 11° P	

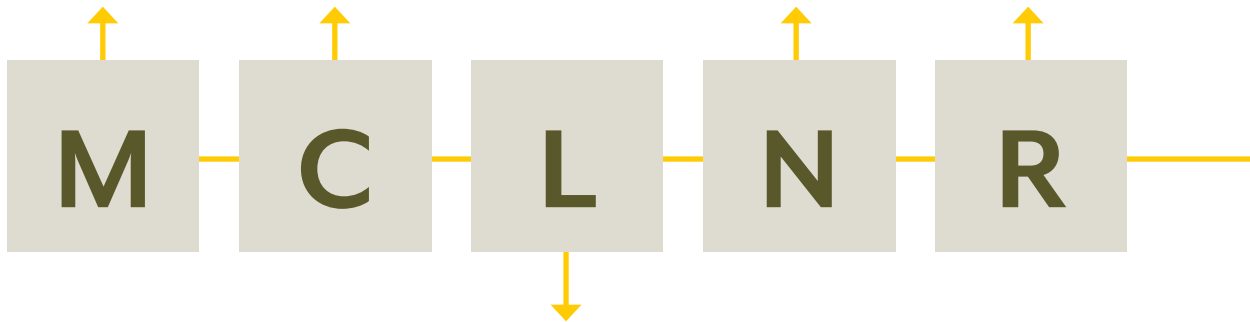

Tool Holder Style							
A	B	C	D	E	F	G	H
 90°	 75°	 90°	 45°	 60°	 90°	 90°	 107° 30'
 93°	 75°	 95°	 50°	 63°	 117° 30'	 62° 30'	 107° 30'
 75°	 45°	 60°	 93°	 72° 30'	 60°	 120°	

External Tool Holder Identification Guide

Tool Holder Size

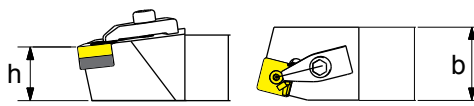

ANSI					
No.	b	h	No.	b	h
	Width	Height		Width	Height
05	0.3125	0.3125	24	1.50	1.50
06	0.375	0.375	32	2.00	2.00
08	0.50	0.50	64	0.75	1.00
10	0.625	0.625	66	0.75	1.50
12	0.75	0.75	85	1.00	1.25
16	1.00	1.00	86	1.00	1.50
20	1.25	1.25	91	1.25	1.50

Insert I.C. Size

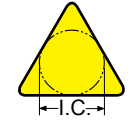

Number of 1/8" of inscribed circle

- 2 = 0.250"
- 3 = 0.375"
- 4 = 0.500"
- 5 = 0.625"
- 6 = 0.750"
- 7 = 0.875"
- 8 = 1.000"



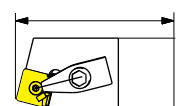



Qualified Tool Length



ANSI (Inch)

- J = 3-1/2
- A = 4
- B = 4-1/2
- C = 5
- D = 6
- E = 7
- F = 8



		Cutting Edge Length						
Number of 1/8" of I.C.	I.C. Inch	C	D	R	S	T	V	W
								
						09		
2	1/4	06	07			11	11	
3	3/8	09	11	09	09	16	16	06
4	1/2	12	15	12	12	22	22	08
5	5/8	16	19	15	15	27		
6	3/4	19		19	19	33		
8	1	25		25	25	44		

External Tool Holders

MCLNR/L for Negative 80° Rhombic CN_ Inserts

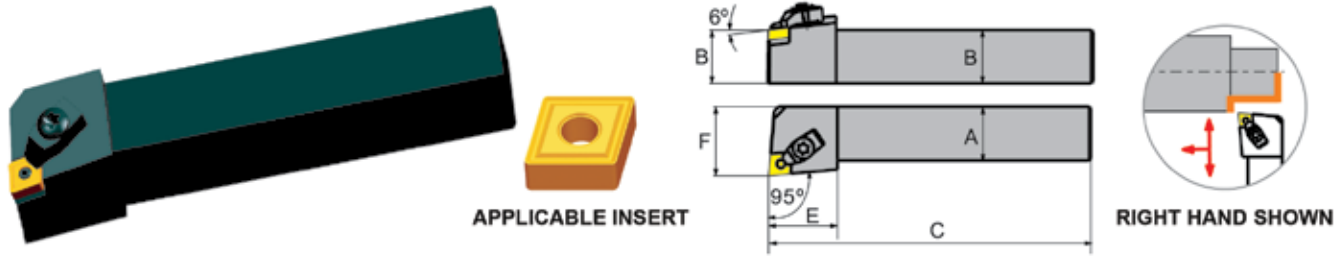

MCLNR/L	A (Inch)	B (Inch)	C (Inch)	E (Inch)	F (Inch)	Right Hand Code	Left Hand Code	Accessories				
								Applicable Insert	Clamp Code	Clamp Screw Code	Lock Pin Code	Shim Code
12-4B	0.75	0.75	4.50	1.25	1.00	534101	534111	CN_43_	534240	534250	534230	534260
16-4D	1.00	1.00	6.00	1.25	1.25	534102	534112	CN_43_	534240	534250	534230	534260
20-4D	1.25	1.25	6.00	1.25	1.50	534103	534113	CN_43_	534240	534251	534230	534260
16-5D	1.00	1.00	6.00	1.38	1.25	534104	534114	CN_54_	534241	534251	534231	534261
20-5D	1.25	1.25	6.00	1.38	1.50	534105	534115	CN_54_	534241	534251	534231	534261
20-6D	1.25	1.25	6.00	1.50	1.50	534106	534116	CN_64_	534241	534251	534232	534262
24-6D	1.50	1.50	6.00	1.50	2.00	534107	534117	CN_64_	534241	534251	534232	534262

MDJNR/L for Negative 55° Rhombic DN_ Inserts

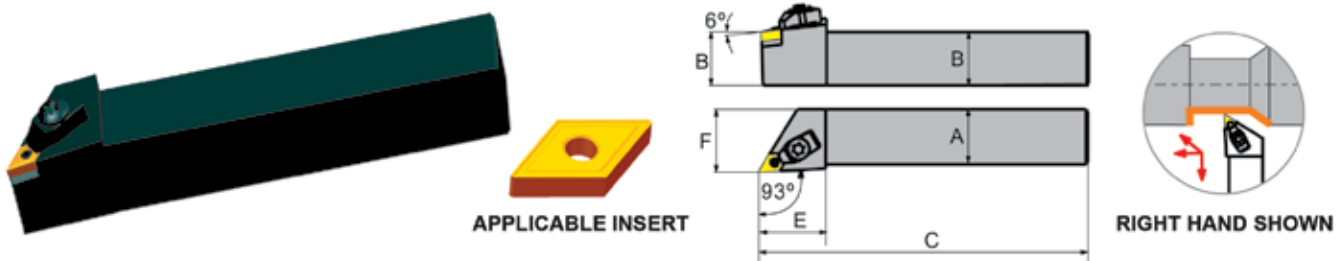

MDJNR/L	A (Inch)	B (Inch)	C (Inch)	E (Inch)	F (Inch)	Right Hand Code	Left Hand Code	Accessories				
								Applicable Insert	Clamp Code	Clamp Screw Code	Lock Pin Code	Shim Code
12-4B	0.75	0.75	4.50	1.25	1.00	534121	534131	DN_43_	534241	534251	534230	534267
16-4D	1.00	1.00	6.00	1.25	1.25	534122	534132	DN_43_	534241	534251	534230	534267
20-4D	1.25	1.25	6.00	1.25	1.50	534123	534133	DN_43_	534241	534251	534230	534267
20-5D	1.25	1.25	6.00	1.50	1.50	-	534134	DN_54_	534241	534251	534231	534268
24-6D	1.50	1.50	6.00	1.50	2.00	534125	534135	DN_54_	534241	534251	534231	534268

External Tool Holders

MTJNR/L for Negative Triangle TN_ _ Inserts

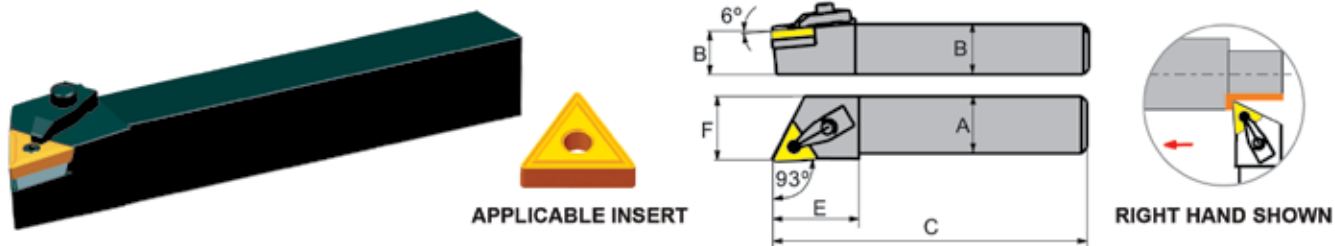

MTJNR/L	A (Inch)	B (Inch)	C (Inch)	E (Inch)	F (Inch)	Right Hand Code	Left Hand Code	Accessories				
								Applicable Insert	Clamp Code	Clamp Screw Code	Lock Pin Code	Shim Code
10-3B	0.62	0.62	4.50	1.00	0.675	534145	534155	TN_33_	534244	534253	534233	534270
12-3B	0.75	0.75	4.50	1.00	1.000	534146	534156	TN_33_	534244	534253	534233	534270
16-3D	1.00	1.00	6.00	1.00	1.250	534140	534157	TN_33_	534244	534253	534233	534270
16-4D	1.00	1.00	6.00	1.25	1.250	534141	534151	TN_43_	534240	534250	534230	534271
20-4D	1.25	1.25	6.00	1.25	1.500	534142	534152	TN_43_	534240	534250	534230	534271
20-5D	1.25	1.25	6.00	1.50	1.500	534143	534153	TN_54_	534240	534250	534231	534272
24-5D	1.50	1.50	6.00	1.50	2.000	534144	534154	TN_54_	534240	534250	534231	534272

MSSNR/L for Negative Square SN_ _ Inserts

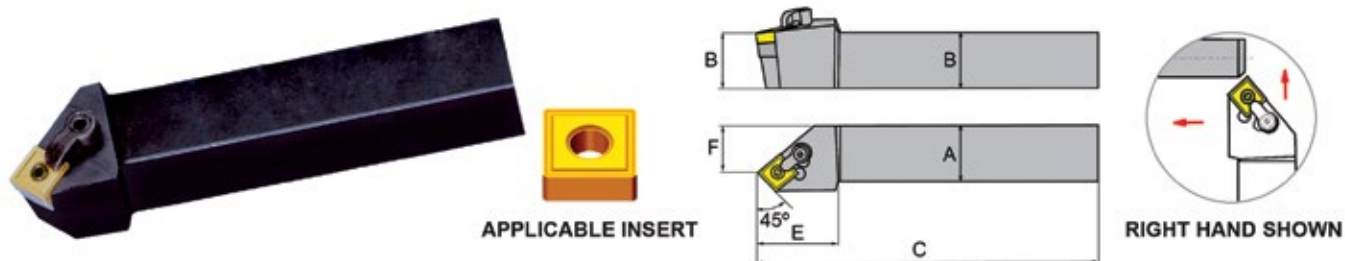

MSSNR/L	A (Inch)	B (Inch)	C (Inch)	E (Inch)	F (Inch)	Right Hand Code	Left Hand Code	Accessories				
								Applicable Insert	Clamp Code	Clamp Screw Code	Lock Pin Code	Shim Code
12-4B	0.75	0.75	4.50	1.25	0.63	534161	534171	SN_43_	534240	534250	534230	534273
16-4D	1.00	1.00	6.00	1.25	0.93	534162	534172	SN_43_	534240	534250	534230	534273

External Tool Holders

MWLNLR/L for Negative Trigon WN_ _ Inserts

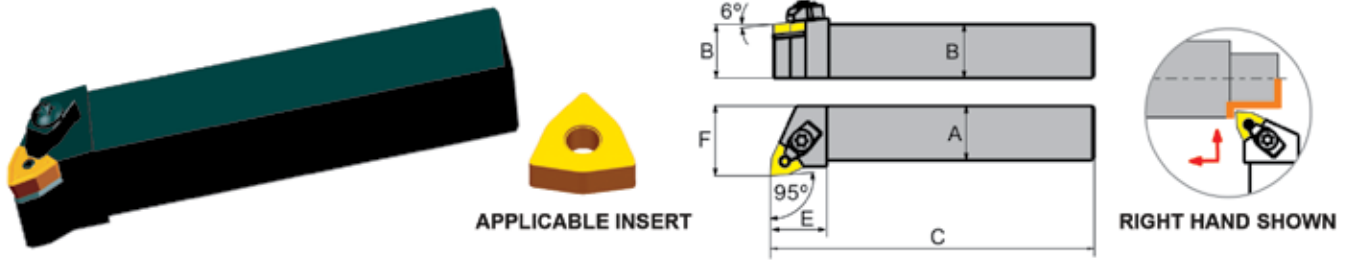

MWLNLR/L	A (Inch)	B (Inch)	C (Inch)	E (Inch)	F (Inch)	Right Hand Code	Left Hand Code	Accessories				
								Applicable Insert	Clamp Code	Clamp Screw Code	Lock Pin Code	Shim Code
12-3B	0.75	0.75	4.50	1.00	1.00	534180	-	WN_33_	534244	534253	534233	534277
12-4B	0.75	0.75	4.50	1.25	1.00	534181	534191	WN_43_	534240	534250	534230	534275
16-4D	1.00	1.00	6.00	1.25	1.25	534182	534192	WN_43_	534240	534250	534230	534275
20-4D	1.25	1.25	6.00	1.25	1.50	534183	534193	WN_43_	534240	534250	534230	534275

MVJNR/L for Negative 35° Rhombic VN_ _ Inserts

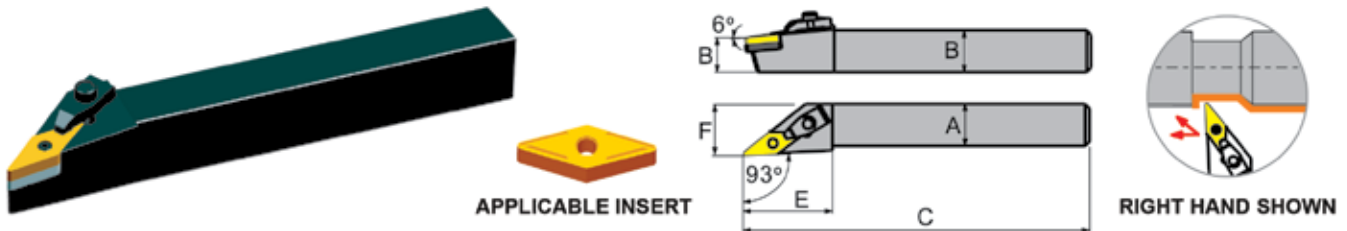

MVJNR/L	A (Inch)	B (Inch)	C (Inch)	E (Inch)	F (Inch)	Right Hand Code	Left Hand Code	Accessories				
								Applicable Insert	Clamp Code	Clamp Screw Code	Lock Pin Code	Shim Code
12-3B	0.75	0.75	4.50	1.69	1.00	534201	534211	VN_33_	534243	534251	534233	534280
16-3D	1.00	1.00	6.00	1.69	1.25	534202	534212	VN_33_	534243	534251	534233	534280
20-3D	1.25	1.25	6.00	1.69	1.50	534203	534213	VN_33_	534243	534251	534233	534280

External Tool Holders

SCLCR/L for 7° Positive 80° Rhombic CC_ _ Inserts

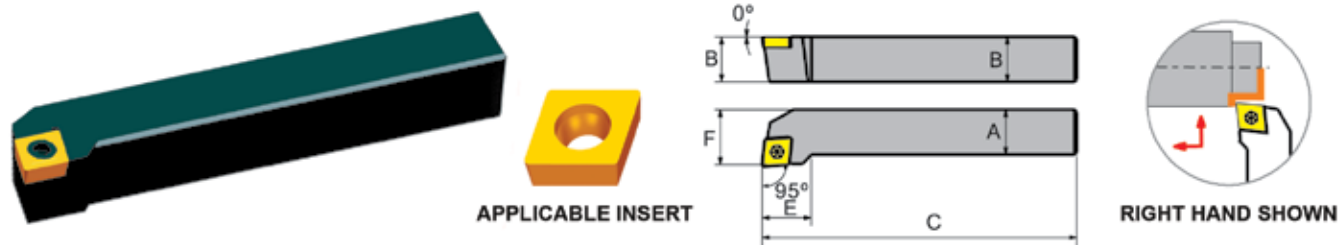

SCLCR/L	A (Inch)	B (Inch)	C (Inch)	E (Inch)	F (Inch)	Right Hand Code	Left Hand Code	Accessories		
								Applicable Insert	Screw Code	Torx® Key Code
06-2J	0.375	0.375	3.50	0.49	0.500	534001	534011	CC_21.5_	210350	549505
08-3A	0.500	0.500	4.00	0.69	0.625	534002	534012	CC_32.5_	210351	302319
10-3B	0.625	0.625	4.50	0.69	0.750	534003	534013	CC_32.5_	210351	302319
12-3B	0.750	0.750	4.50	0.69	1.000	534004	534014	CC_32.5_	210351	302319
16-3D	1.000	1.000	6.00	0.69	1.250	534005	534015	CC_32.5_	210351	302319
12-4B	0.750	0.750	4.50	0.83	1.000	534006	534016	CC_43_	210352	718401
16-4D	1.000	1.000	6.00	0.83	1.250	534007	534017	CC_43_	210352	718401

SDJCR/L for 7° Positive 55° Rhombic DC_ _ Inserts

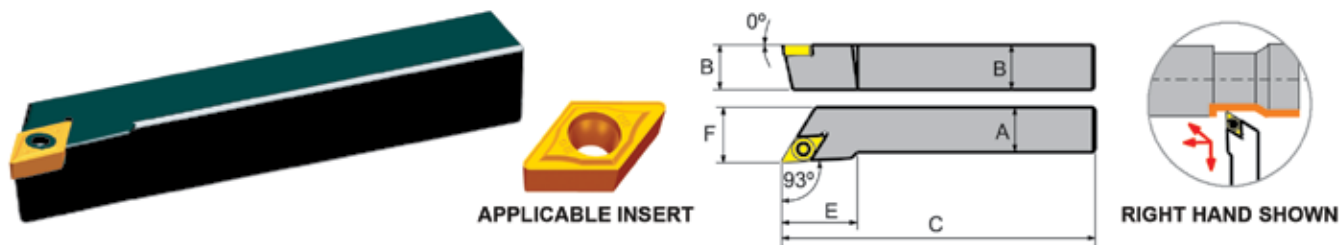

SDJCR/L	A (Inch)	B (Inch)	C (Inch)	E (Inch)	F (Inch)	Right Hand Code	Left Hand Code	Accessories		
								Applicable Insert	Screw Code	Torx® Key Code
06-2J	0.375	0.375	3.50	0.68	0.500	534031	534041	DC_21.5_	210350	549505
08-2A	0.500	0.500	4.00	0.68	0.625	534032	534042	DC_21.5_	210350	549505
08-3A	0.500	0.500	4.00	1.00	0.625	534033	534043	DC_32.5_	210351	302319
10-3B	0.625	0.625	4.50	1.00	0.750	534034	534044	DC_32.5_	210351	302319
12-3B	0.750	0.750	4.50	1.00	1.000	534035	534045	DC_32.5_	210351	302319
16-3D	1.000	1.000	6.00	1.00	1.250	534036	534046	DC_32.5_	210351	302319
12-4B	0.750	0.750	4.50	1.25	1.000	534037	-	DC_43_	210352	718401
16-4D	1.000	1.000	6.00	1.25	1.250	534038	534048	DC_43_	210352	718401

External Tool Holders

STGCR for Positive Triangular TC__ Inserts



APPLICABLE INSERT

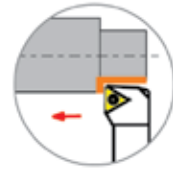
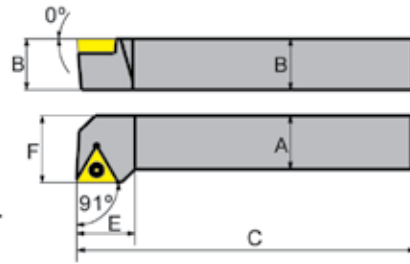

RIGHT HAND SHOWN

STGCR/L	A (Inch)	B (Inch)	C (Inch)	E (Inch)	F (Inch)	Right Hand Code	Accessories		
							Applicable Insert	Screw Code	Torx® Key Code
06-2J	0.375	0.375	2.50	0.50	0.500	534051	TC__21.5_	210350	549505
08-2J	0.500	0.500	3.50	0.50	0.625	534052	TC__21.5_	210350	549505
10-2A	0.625	0.625	4.00	0.50	0.750	534053	TC__21.5_	210350	549505
10-3B	0.625	0.625	4.50	0.83	0.750	534054	TC__32.5_	210351	302319
12-3B	0.750	0.750	4.50	0.83	0.875	534055	TC__32.5_	210351	302319
16-3D	1.000	1.000	6.00	0.83	1.125	534056	TC__32.5_	210351	302319

SVJCR for 7° Positive 35° Rhombic VC__ Inserts



APPLICABLE INSERT

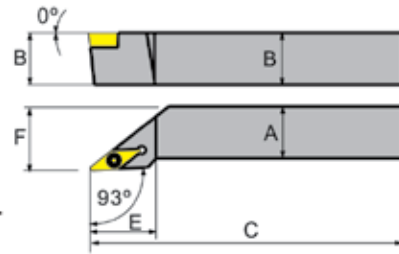

RIGHT HAND SHOWN

SVJCR/L	A (Inch)	B (Inch)	C (Inch)	E (Inch)	F (Inch)	Right Hand Code	Accessories		
							Applicable Insert	Screw Code	Torx® Key Code
06-2J	0.375	0.375	3.50	1.00	0.500	534081	VC__22_	210350	549505
08-2A	0.500	0.500	4.00	1.00	0.625	534082	VC__22_	210350	549505
10-2B	0.625	0.625	4.50	1.00	0.750	534083	VC__22_	210350	549505
12-3B	0.750	0.750	4.50	1.25	1.000	534084	VC__33_	210353	302319
16-3C	1.000	1.000	5.00	1.25	1.250	534085	VC__33_	210353	302319
16-3D	1.000	1.000	6.00	1.25	1.250	534086	VC__33_	210353	302319



INSIZE Precision Measuring Tools









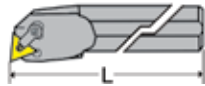

INSIZE is a worldwide company with over 25+ years engineering focuses on quality and innovation. These products have been sold into many industries including aerospace, automotive, military and other major manufacturing environments in Canada and the world over.

Each INSIZE tool comes with:
Serialization for traceability
Most supplied with inspection certificate
1-year warranty
Rugged patented storage case (most product)
Coolant proof options available
Replacement parts available as needed

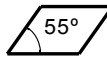

Product Categories include:

Calipers
Indicators
Micrometers
Depth Gages
Height Gages
Bore Gages
Gage Blocks, Plug and Ring Gages
Rules, Scribes, Angle and Taper Gages
Levels
Layout Tools
Tool Sets
Hardness Testers
Microscopes and Magnifiers
Digital Scales
Force Gages
Small Portable Instruments: Thickness gages, Thermometers, Refractometers
Roughness Testers



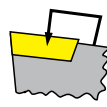
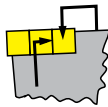
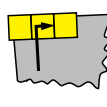

Boring Bar Identification Guide

Bar Type	Bar Diameter	Bar Length	Insert Shape	
Steel with Coolant-Thru A	Round Shanks: (D) shown in 1/16" increments  ANSI 04 = 0.250" 05 = 0.3125" 06 = 0.375" 08 = 0.500" 10 = 0.625" 12 = 0.750" 16 = 1.000" 20 = 1.250" 24 = 1.500" 32 = 2.000" 40 = 2.500"	 ANSI H = 4" J = 4-1/2" K = 5" M = 6" R = 8" S = 10" T = 12" U = 14" V = 16" Y = 18"	 C	 D
Carbide C			 K	 R
Carbide with Coolant-Thru E			 S	 T
Steel S			 V	 W

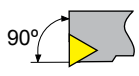
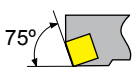
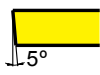

Insert Mounting Method	
 C - Clamp Lock	 M - Multi Lock
 P - Lever Lock	 S - Screw Lock

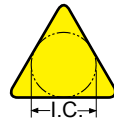
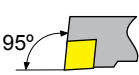
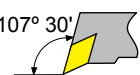
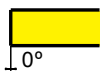
Boring Bar Identification Guide

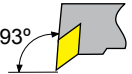
Bar Style		Insert Clearance Angle		Insert I.C. Size
 90° F	 75° K	 5° B	 7° C	 Number of 1/8" of inscribed circle 2 = 0.250" 3 = 0.375" 4 = 0.500" 5 = 0.625" 6 = 0.750" 7 = 0.875" 8 = 1.000"
 95° L	 107° 30' P	 0° N	 11° P	
 93° U				

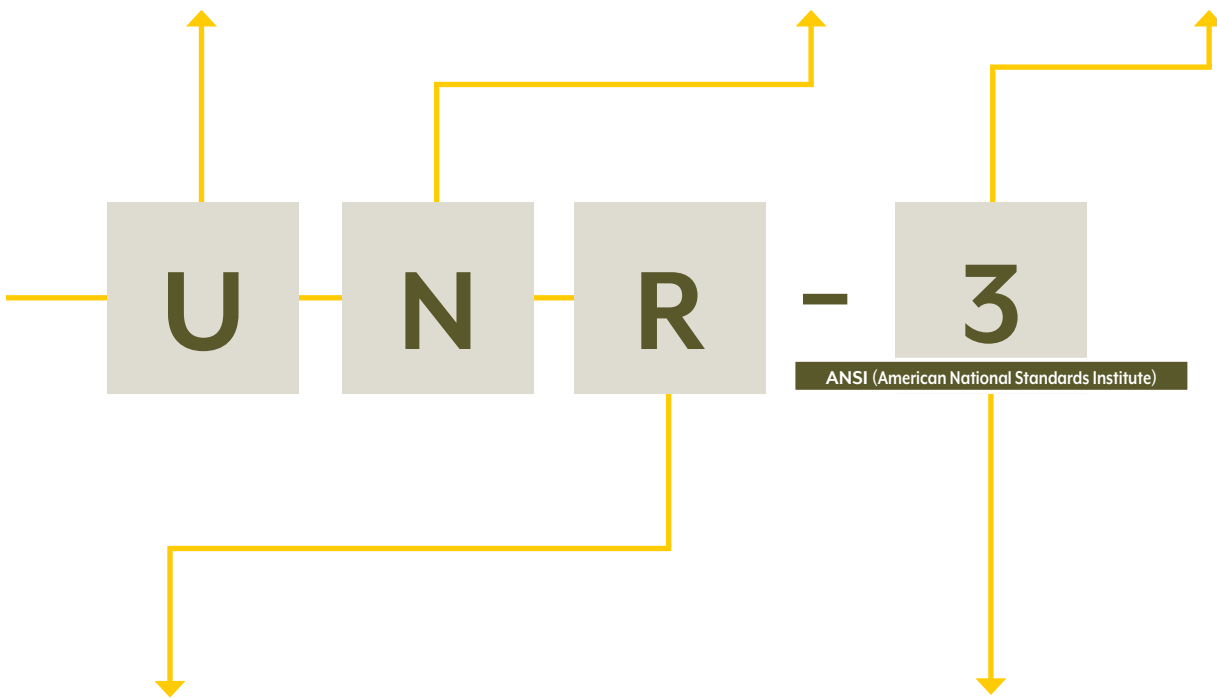



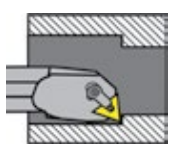

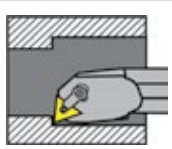

Hand of Tool



L - Left Hand



R - Right Hand

		Cutting Edge Length						
No. of 1/8" of I.C.	I.C. Inch	C	D	R	S	T	V	W
								
						09		
2	1/4	06	07			11	11	
3	3/8	09	11	09	09	16	16	06
4	1/2	12	15	12	12	22	22	08
5	5/8	16	19	15	15	27		
6	3/4	19		19	19	33		
8	1	25		25	25	44		

Boring Bars

S-MCLNR/L for Negative 80° Rhombic CN_ _ Inserts

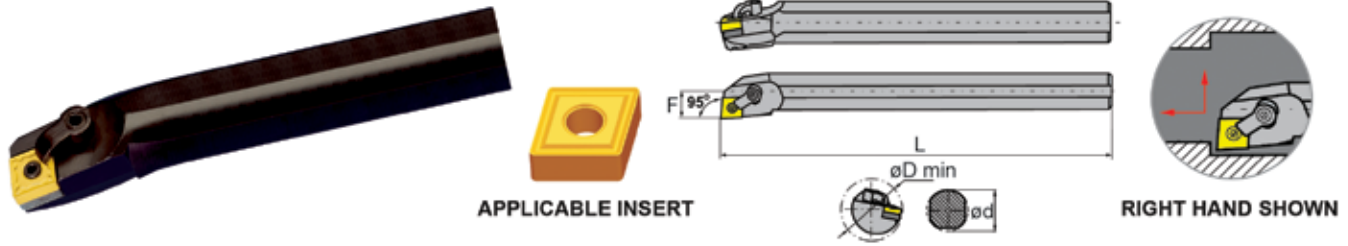

S-MCLNR/L	Ød (Inch)	L (Inch)	ØD (Inch)	F (Inch)	Right Hand Code	Left Hand Code	Accessories				
							Applicable Insert	Clamp Code	Clamp Screw Code	Lock Pin Code	Shim Code
16-4	1.00	12	1.28	0.640	534401	534411	CN_43_	534240	534250	534230	534260
20-4	1.25	14	1.53	0.765	534402	534412	CN_43_	534240	534250	534230	534260
24-4	1.50	14	1.78	0.890	534403	534413	CN_43_	534240	534250	534230	534260

S-MDUNR/L for Negative 55° Rhombic DN_ _ Inserts

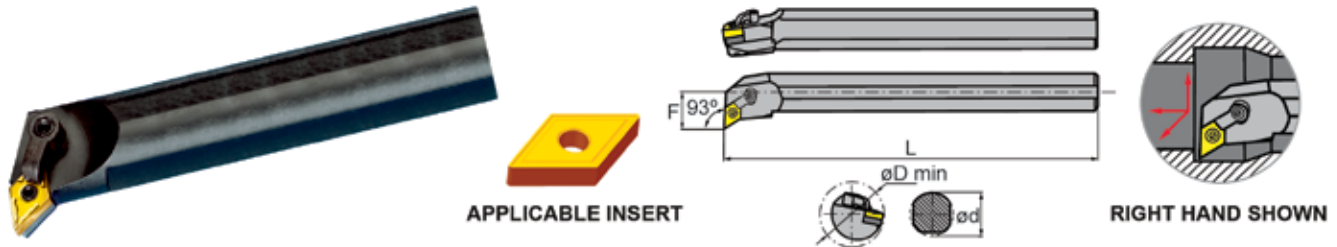

S-MDUNR/L	Ød (Inch)	L (Inch)	ØD (Inch)	F (Inch)	Right Hand Code	Left Hand Code	Accessories				
							Applicable Insert	Clamp Code	Clamp Screw Code	Lock Pin Code	Shim Code
20-4	1.25	14	2.00	1.00	534421	534431	DN_43_	534241	534251	534230	534267
24-4	1.50	14	2.25	1.25	534422	534432	DN_43_	534241	534251	534230	534267

S-MTUNR/L for Negative Triangular TN_ _ Inserts

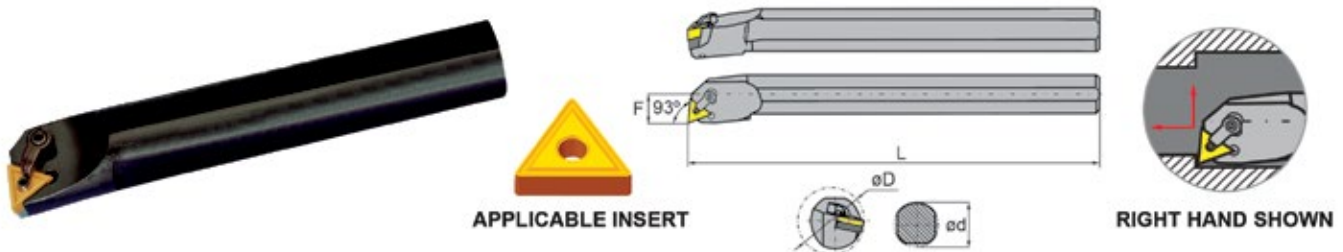

S-MTUNR/L	Ød (Inch)	L (Inch)	ØD (Inch)	F (Inch)	Right Hand Code	Left Hand Code	Accessories				
							Applicable Insert	Clamp Code	Clamp Screw Code	Lock Pin Code	Shim Code
16-3	1.00	12	1.28	0.640	534442	534452	TN_33_	534244	534253	534233	534270
20-4	1.25	14	1.53	0.765	534443	534453	TN_43_	534240	534250	534230	534271
24-4	1.50	14	2.06	0.890	534444	534454	TN_43_	534240	534250	534230	534271

Boring Bars

S-MWLN/L for Negative Trigon WN_ _ Inserts

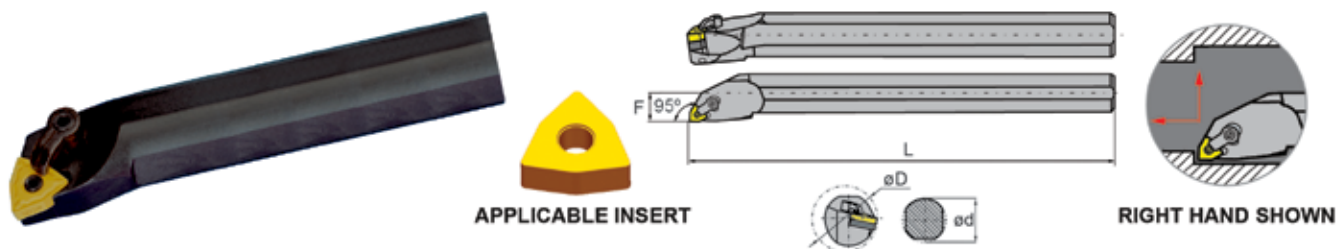

APPLICABLE INSERT

RIGHT HAND SHOWN

S-MWLN/L	Ød (Inch)	L (Inch)	ØD (Inch)	F (Inch)	Right Hand Code	Left Hand Code	Accessories				
							Applicable Insert	Clamp Code	Clamp Screw Code	Lock Pin Code	Shim Code
12-3	0.75	10	0.93	0.500	534459	534469	WN_ _33_	534234	-	534244	534252
12-4	0.75	10	0.93	0.500	534460	534470	WN_ _43_	534235	-	534240	534254
16-4	1.00	12	1.28	0.640	534461	534471	WN_ _43_	534235	-	534240	534254
20-4	1.25	14	1.53	0.785	534462	534472	WN_ _43_	534230	534250	534240	534275
24-4	1.50	14	1.78	0.890	534463	534473	WN_ _43_	534230	534250	534240	534275

S-SCLCR/L for 7° Positive 80° Rhombic CC_ _ Inserts

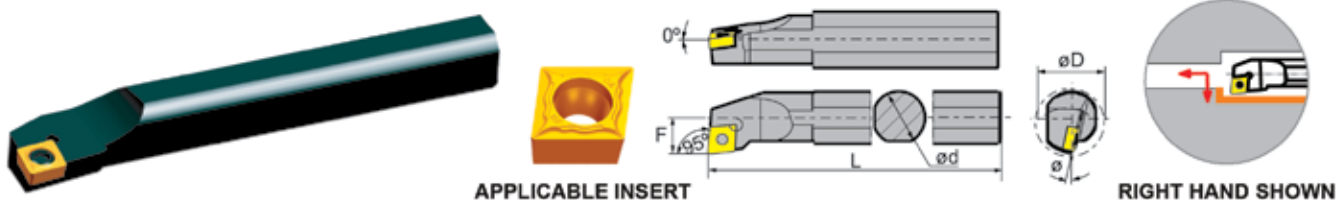

APPLICABLE INSERT

RIGHT HAND SHOWN

S-SCLCR/L	Ød (Inch)	L (Inch)	ØD (Inch)	F (Inch)	Right Hand Code	Left Hand Code	Accessories		
							Applicable Insert	Screw Code	Torx® Key Code
4-2	0.315	4	0.354	0.188	534301	534311	CC_ _21.5_	210354	549505
6-2	0.375	6	0.468	0.250	534302	534312	CC_ _21.5_	210350	549505
8-2	0.500	7	0.560	0.290	534303	534313	CC_ _21.5_	210350	549505
8-3	0.500	7	0.600	0.312	534304	534314	CC_ _32.5_	210351	302319
10-3	0.625	8	0.866	0.406	534305	534315	CC_ _32.5_	210351	302319
12-3	0.750	10	0.920	0.500	534306	534316	CC_ _32.5_	210351	302319
16-3	1.000	12	1.120	0.609	534307	534317	CC_ _32.5_	210351	302319

Boring Bars

S-SDUCR for 7° Positive 55° Rhombic DC_ _ Inserts



APPLICABLE INSERT

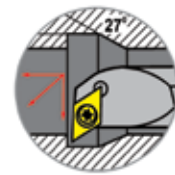
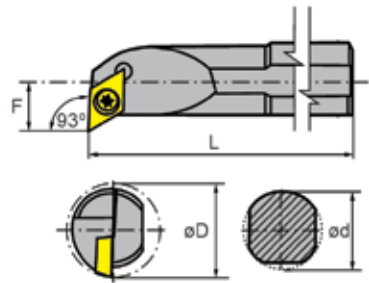

RIGHT HAND SHOWN

S-SDUCR	Ød (Inch)	L (Inch)	ØD (Inch)	F (Inch)	Right Hand Code	Accessories		
						Applicable Insert	Screw Code	Torx® Key Code
6-2	0.375	6	0.625	0.375	534331	DC_ _21.5_	210350	549505
8-2	0.500	6	0.780	0.437	534332	DC_ _21.5_	210350	549505
10-2	0.625	8	0.840	0.500	534333	DC_ _21.5_	210350	549505
12-3	0.750	10	1.125	0.562	534334	DC_ _32.5_	210351	302319
16-3	1.000	12	1.500	0.750	534335	DC_ _32.5_	210351	302319

S-STUCR for 7° Positive Triangular TC_ _ Inserts



APPLICABLE INSERT

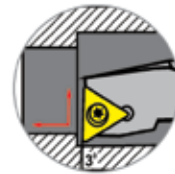
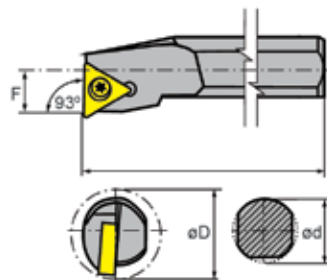

RIGHT HAND SHOWN

S-STUCR	Ød (Inch)	L (Inch)	ØD (Inch)	F (Inch)	Right Hand Code	Accessories		
						Applicable Insert	Screw Code	Torx® Key Code
8-2	0.500	6	0.590	0.287	534351	TC_ _21.5_	210350	549505
10-2	0.625	8	0.750	0.350	534352	TC_ _21.5_	210350	549505
12-3	0.750	10	0.845	0.422	534353	TC_ _32.5_	210351	302319
16-3	1.000	12	1.115	0.555	534354	TC_ _32.5_	210351	302319

S-SCLCR for 80° Rhombic CC_ _ Inserts

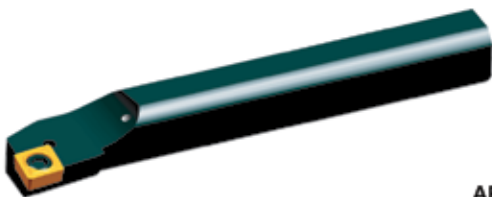

APPLICABLE INSERT

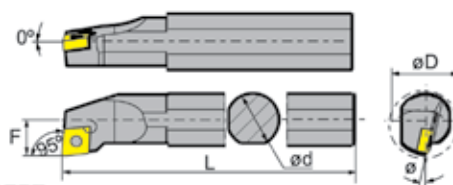

RIGHT HAND SHOWN

S-SCLCR	Ød (Inch)	L (Inch)	ØD (Inch)	F (Inch)	Right Hand Code	Accessories		
						Applicable Insert	Screw Code	Torx® Key Code
A04F-02	0.250	3.14	0.330	0.177	533001	CC_ _21.5_	-	210354
A06J-02	0.375	4.50	0.489	0.275	533002	CC_ _21.5_	-	210354
A08K-02	0.500	4.92	0.629	0.353	533003	CC_ _21.5_	-	210354
A10M-02	0.625	5.90	0.775	0.432	533004	CC_ _21.5_	-	210354
A08K-03	0.500	4.92	0.629	0.353	533006	CC_ _32.5_	302319	210351
A10M-03	0.625	5.90	0.775	0.432	533007	CC_ _32.5_	302319	210351

Boring Bars

S-SDUCR for 55° Rhombic DC_ _ Inserts

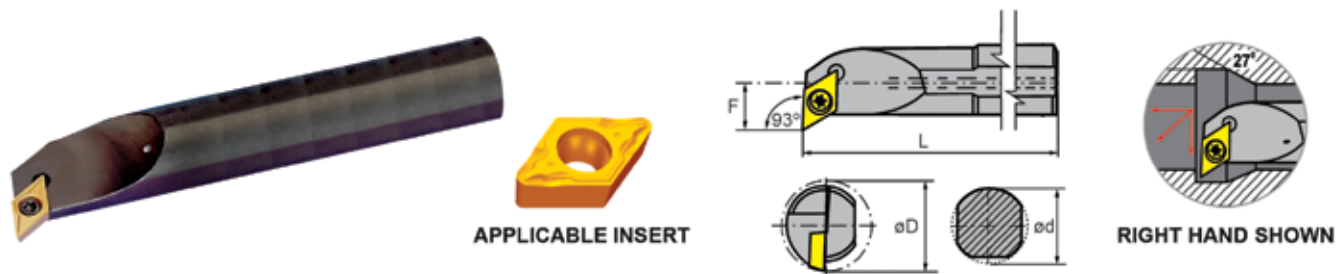

S-SDUCR	Ød (Inch)	L (Inch)	ØD (Inch)	F (Inch)	Right Hand Code	Accessories		
						Applicable Insert	Screw Code	Torx® Key Code
A12K-07	0.500	5	0.750	0.354	533021	DC_21.5_	210354	-
A16M-07	0.625	6	0.875	0.433	533022	DC_21.5_	210354	-

S-STFCR for Triangular TC_ _ Inserts

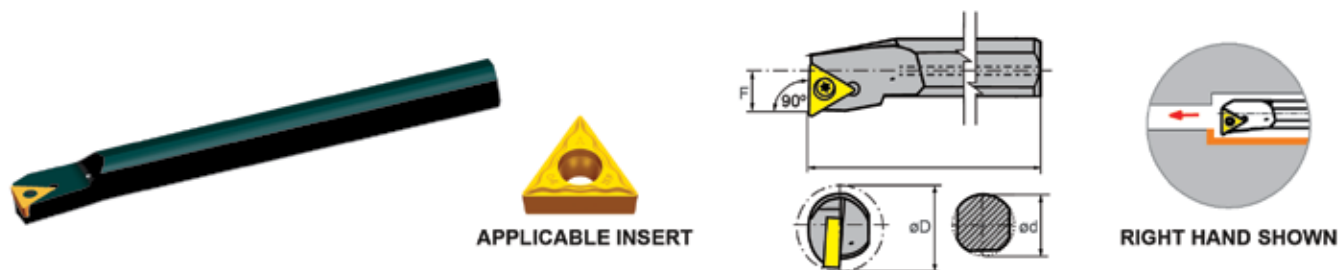

S-STFCR	Ød (Inch)	L (Inch)	ØD (Inch)	F (Inch)	Right Hand Code	Accessories		
						Applicable Insert	Screw Code	Torx® Key Code
A10J-II	0.375	4.30	0.625	0.275	533041	TC_21.5_	210354	-
A12K-II	0.500	5.00	0.750	0.354	533042	TC_21.5_	210354	-
A16M-II	0.625	6.00	0.875	0.433	533043	TC_21.5_	210354	-

Boring Bar Sets



534319



534320



534321



534322

Description	Boring Bars Included (Inch)	TIN Inserts Included	No. of Torx® Keys Included	No. of Spare Screws Included	Code
3pc. Right Hand	0.315, 3/8, 1/2	CCMT21.51 (6pcs)	1	1	534319
3pc. Right Hand	3/8, 1/2, 5/8	CCMT21.51 (2pcs) and CCMT32.52 (4pcs)	2	2	534320
3pc. Right Hand	1/2, 5/8, 3/4	CCMT32.52 (6pcs)	1	1	534321
5pc. Right Hand	0.315, 3/8, 1/2, 5/8, 3/4	CCMT21.51 (4pcs) and CCMT32.52 (6pcs)	2	2	534322

Steel Boring Bars



Criterion® CB-Style CB203D Indexable Boring Bars

- Minimum bore ranges from 1/4" to 1-1/4"
- Standard length for greater bore depths
- 4 parallel flats designed to place the cutting edge on the centerline
- Works equally as well in machining centers and turning centers
- Uses industry standard inserts

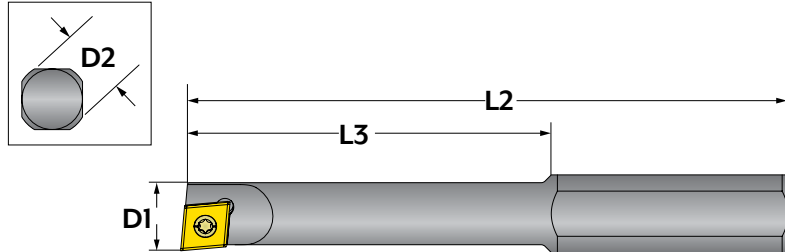

D1 Minimum Bore Ø (Inch)	L2 Overall Length (Inch)	L3 Length (Inch)	D2 Shank Ø (Inch)	Weight (lbs)	Applicable Insert	Code
0.250	1.062	2.500	* 0.500	0.080	WBGX0301_ _	250320
0.312	1.437	2.570	* 0.500	0.080	WBGX0301_ _	250321
0.375	1.750	3.062	* 0.500	0.100	WBGX0301_ _	250322
0.437	2.062	3.375	* 0.500	0.110	CC _ _215 _ _	250323
0.500	2.187	3.500	* 0.500	0.140	CC _ _215 _ _	250324
0.500	2.500	4.250	0.750	0.280	CC _ _215 _ _	250325
0.750	3.000	4.687	0.750	0.430	CC _ _325 _ _	250326
1.000	3.500	5.125	0.750	0.570	CC _ _325 _ _	250327
1.250	4.000	5.562	0.750	0.570	CC _ _325 _ _	250328

* Reducing sleeve required

Applicable Inserts



Coated Diamond 80° CCMT0602 _ _ and CCMT 0903 _ _

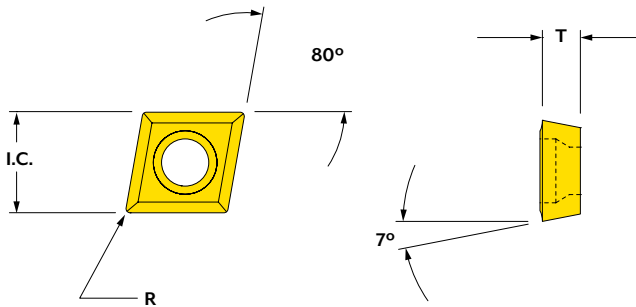

Insert	I.C. (Inch)	R Radius (Inch)	T Thickness (Inch)	Code
WBGX030101	-	0.004	-	250253
CCMT060202	0.250	0.008	0.094	250254
CCMT060204	0.250	0.016	0.094	250255
CCMT060208	0.250	0.031	0.094	250256
CCMT090302	0.375	0.008	0.156	250257
CCMT090304	0.375	0.016	0.156	250258
CCMT090308	0.375	0.031	0.156	250259



Indexable Insert Boring Bar Sets



Size (Inch)	No. of Pieces	Code
3/4	4	250351

Boring Bars

Indexable Insert Boring Bars for Boring Heads

- Supplied with grade C5 inserts



Shank Size (Inch)	Minimum Bore (Inch)	Bore Depth (Inch)	Overall Length (Inch)	Tool Reference	Code	
1/2	7/16	1-1/4	2-3/4	NB7S	210365	
1/2	7/16	1-7/8	3-3/8	NB7M	210366	
1/2	7/16	2-1/2	4	NB7L	210367	
1/2	1/2	1-1/2	3	NB8S	210368	
1/2	1/2	2-1/8	3-5/8	NB8M	210369	
1/2	1/2	2-3/4	4-1/4	NB8L	210370	
1/2	9/16	1-3/4	3-1/4	NB9S	210371	
1/2	9/16	2-3/8	3-7/8	NB9M	210372	
1/2	9/16	3	4-1/2	NB9L	210373	
5/8	7/16	1-1/4	3	NC7S	210374	
5/8	7/16	1-7/8	3-5/8	NC7M	210375	
5/8	7/16	2-1/2	4-1/4	NC7L	210376	
5/8	1/2	1-1/2	3-1/4	NC8S	210377	
5/8	1/2	2-1/8	3-7/8	NC8M	210378	
5/8	1/2	2-3/4	4-1/2	NC8L	210379	
5/8	9/16	1-3/4	3-1/2	NC9S	210380	
5/8	9/16	2-3/8	4-1/8	NC9M	210381	
5/8	9/16	3	4-3/4	NC9L	210382	
5/8	5/8	2	3-3/4	NC10S	210383	
5/8	5/8	2-5/8	4-3/8	NC10M	210384	
5/8	5/8	3-1/4	5	NC10L	210385	
5/8	11/16	2-1/4	4	NC11S	210386	
5/8	11/16	2-7/8	4-5/8	NC11M	210387	
5/8	11/16	3-1/2	5-1/4	NC11L	210388	
3/4	7/16	1-1/4	3-1/4	ND7S	210389	
3/4	7/16	1-7/8	3-7/8	ND7M	210390	
3/4	7/16	2-1/2	4-1/2	ND7L	210391	
3/4	1/2	1-1/2	3-1/2	ND8S	210392	
3/4	1/2	2-1/8	4-1/8	ND8M	210393	
3/4	1/2	2-3/4	4-3/4	ND8L	210394	
3/4	9/16	1-3/4	3-3/4	ND9S	210395	
3/4	9/16	2-3/8	4-3/8	ND9M	210396	
3/4	9/16	3	5	ND9L	210397	
3/4	5/8	2	4	ND10S	210398	
3/4	5/8	2-5/8	4-5/8	ND10M	210399	
3/4	5/8	3-1/4	5-1/4	ND10L	210400	
3/4	11/16	2-1/4	4-1/4	ND11S	210401	
3/4	11/16	2-7/8	4-7/8	ND11M	210402	
3/4	11/16	3-1/2	5-1/2	ND11L	210403	
3/4	3/4	2-1/2	4-1/2	ND12S	210404	
3/4	3/4	3-1/4	5-1/4	ND12M	210405	
3/4	3/4	4	6	ND12L	210406	
3/4	13/16	2-3/4	4-3/4	ND13S	210407	
3/4	13/16	4	6	ND13M	210408	
3/4	13/16	4-1/2	6-1/2	ND13L	210409	
5/8 – 12pc Set					Included Sizes: 1/2 to 11/16 Inch	210411



Applicable Carbide Inserts

- Triangle - Positive rake
- Ground all over with chip groove on one side
- 3/32" thick

Insert I/C (Inch)	Insert	Radius (Inch)	Grade C2 Code	TiN Coated Code
1/4	TPGH 21.50	0.008	-	210357
1/4	TPGH 21.51	1/64	-	577463
1/4	TPGH 21.52	1/32	210355	-

Replacement Parts

Description	Code
Torx® drive flat head screw for 1/4" I/C	577457

Turning Inserts Identification Guide – ANSI vs. ISO



TURNING

Insert Shape			
A	B	C	D
E	K	L	M
H	O	P	R
S	T	V	W

- ▶ d: Theoretical diameter of inscribed circle
- ▶ t: Insert thickness
- ▶ m: See diagram

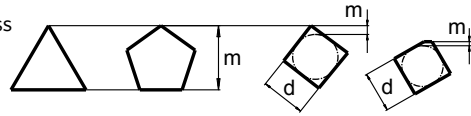

Tolerances in Inch			
Class	d	m	t
A	±0.0010	±0.0002	±0.0010
C	±0.0010	±0.0005	±0.0010
H	±0.0005	±0.0005	±0.0010
E	±0.0010	±0.0010	±0.0010
G	±0.0010	±0.0010	±0.005
J	±0.002 – ±0.006	±0.0002	±0.001
K	±0.002 – ±0.006	±0.0005	±0.001
L	±0.002 – ±0.006	±0.0010	±0.001
★M	±0.002 – ±0.006	±0.003 – ±0.008	±0.005
★U	±0.003 – ±0.01	±0.005 – ±0.015	±0.005

★ Exact tolerance is determined by the shape and size of the insert. For a complete listing of tolerances, refer to ANSI (B212.4-1995)

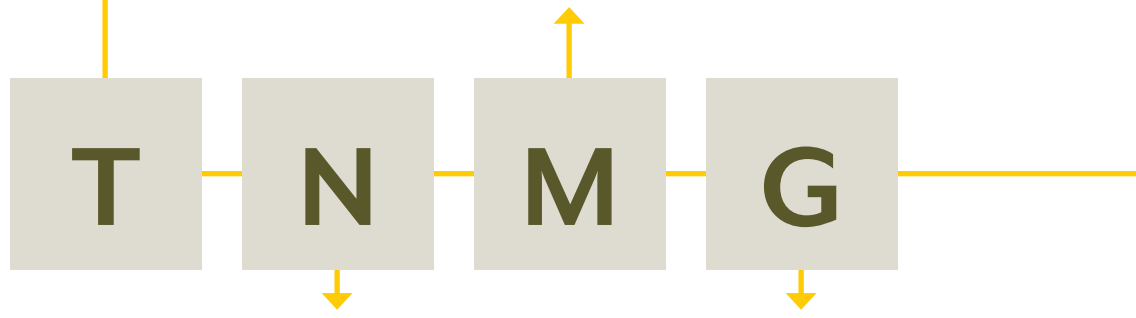







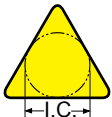

Insert Clearance Angle	
A	B
C	D
E	F
G	N
P	SPECIAL O

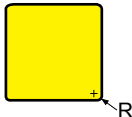
Geometry and Clamping Type	
A	B
C	F
G	H
J	M
N	Q
R	T
U	W

Turning Inserts Identification Guide – ANSI vs. ISO



Insert I.C. Size	Insert Thickness	Insert Radius	Chipbreaker Style (Negative)	
 <p>(I.C.) shown in 1/32" increments on inserts less than 1/4" I.C.</p> <p>(I.C.) shown in 1/8" increments on inserts 1/4" and over</p> <p>(5) = 5/32 5 = 5/8 2 = 1/4 6 = 3/4 3 = 3/8 8 = 1 4 = 1/2</p>	 <p>(T) shown in 1/32" increments on inserts less than 1/4" I.C.</p> <p>(T) shown in 1/16" increments on inserts 1/4" and over</p> <p>1 = 1/16 3 = 3/16 (1.2) = 5/64 4 = 1/4 (1.5) = 3/32 5 = 5/16 2 = 1/8 6 = 3/8 (2.5) = 5/32</p>	 <p>(R) shown in 1/64" increments</p> <p>0 = 1/128 4 = 1/16 1 = 1/64 5 = 5/64 2 = 1/32 6 = 3/32 3 = 3/64 8 = 1/8</p>	 <p>-DF</p>	 <p>-DM</p>
			 <p>-DR</p>	 <p>-PM</p>
			 <p>-EF</p>	 <p>-EM</p>

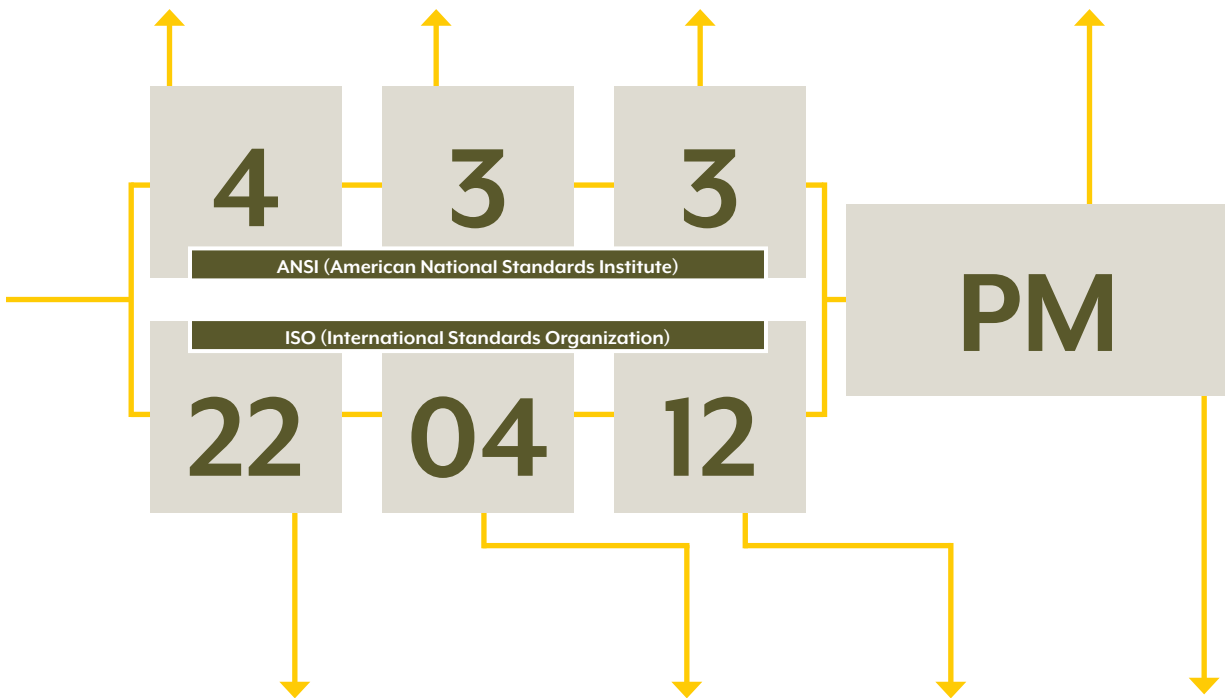

Insert Cutting Edge Length

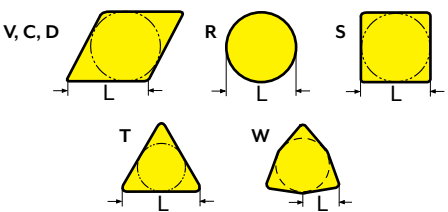

I.C.		Cutting Edge Length by Shape (mm) Designated using insert shape symbol						
mm	Inch	C	D	R	S	T	V	W
3.97	5/32	-	-	-	-	06	-	-
6.35	1/4	06	07	-	-	11	11	04
9.53	3/8	09	11	09	09	16	16	06
12.70	1/2	12	15	12	12	22	22	08
15.88	5/8	16	19	15	15	27	-	-
19.05	3/4	-	-	19	19	33	-	-
25.40	1	-	-	-	25	-	-	-

Insert Thickness



(T) shown in 1 mm increments, single integers are to be preceded by a "0"

	mm	Ref. Inch
01	1.59	1/16
T1	1.98	5/64
02	2.38	3/32
03	3.18	1/8
T3	3.97	5/32
04	4.76	3/16
06	6.34	1/4
07	7.94	5/16
09	9.52	3/8

Insert Radius

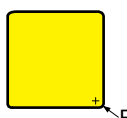

(R) shown in 1/10 mm increments

	mm	Ref. Inch
00	Sharp Point	
02	0.2	1/128
04	0.4	1/64
08	0.8	1/32
12	1.2	3/64
16	1.6	1/16
24	2.4	3/32
32	3.2	1/8
00	Round insert inch	
M0	Round insert metric	

Chipbreaker Style (Positive)



-HF



-HM



-HR

Turning Inserts Main Grades & Applications



YBC151
CVD COATED

P05-P25

An optimal combination of MT-TiCN, thick layers of Al₂O₃, and a TiN coating on a very hard substrate provides excellent wear resistance. It is an ideal grade for finishing steel, cast steel and stainless steel under high speed and dry machining.

YBC251
CVD COATED

P10-P35

An optimal combination of MT-TiCN, thick layers of Al₂O₃, and a TiN coating on a hard substrate provides a cutting edge with superior strength and toughness. It is suitable for a wide range of applications such as finishing, semi-finishing and light roughing of steel, cast steel and stainless steel.

M05-M20

YBC351
CVD COATED

P20-P45

An optimal combination of MT-TiCN, thick layers of Al₂O₃, and a TiN coating on an extremely hard substrate provides superior strength. It is well suited for light to medium roughing of steel, cast steel and stainless steel.

M15-M30

YBM151
CVD COATED

P20-P30

A combination of TiCN, thin layers Al₂O₃, and a TiN coating on a tough substrate provides excellent resistance against flank wear and plastic deformation. It is well suited for finishing and semi-finishing (turning as well as boring) of stainless steel.

M05-M25

YBM251
CVD COATED

P25-P40

An optimal combination of TiCN, thin layers Al₂O₃, and a TiN coating on a very fine substrate provides superb strength and toughness. It is a premium grade for semi-finishing to light roughing (turning and boring) of stainless steel at continuous and intermittent machining conditions.

M15-M35

YBM351
CVD COATED

P15-P35

A combination of TiN and TiAlN coated carbide provides this grade with excellent strength and impact resistance. It is well suited for rough turning and milling of stainless steels at low to moderate cutting speeds with interrupted cuts. Also suitable for high cutting speeds and heavy cutting in P30 range.

M25-M40

YBD102
CVD COATED

K01-K20

A combination of thick Al₂O₃, thick TiCN coating on a very hard substrate provides an optimized balance in wear resistance and flaking resistance when machining nodular cast iron at high speeds.

YBD151
CVD COATED

K10-K20

An optimal combination of MT-TiCN, thick layers of Al₂O₃, TiN coating on a tough substrate provides superb wear resistance. It is a premiere choice for medium to rough machining of cast iron and nodular cast iron under high cutting speeds.

YBD152
CVD COATED

K10-K25

A combination of medium thick Al₂O₃ and medium thick TiCN coatings provide excellent flake resistance. This general grade is suitable for turning in cast iron from moderate to high cutting speeds, and capable of demanding interrupted cutting conditions at moderate cutting speeds. It can also be used for milling cast iron.

YD101
UNCOATED

K10-K20

Uncoated carbide grade with fine size grain. Good for fine and semi-finishing machining of cast iron and non-ferrous materials. Ideal for machining aluminum.

N05-N25

YD201
UNCOATED

K10-K30

Uncoated carbide grade with good wear resistance and toughness. Suitable for roughing and semi-finishing of cast iron and heat-resistant alloys, as well as plastic and wood. Ideal for the aviation industry. Medium cutting speeds and a large feed rate is recommended.

N05-N25

Turning Inserts Main Grades & Applications



YBG102
PVD COATED

K01-K10

A combination of 2-4 μ nc-TiAlN coating and fine carbide substrate is ideal for cast iron from light to medium load and turning of high-temperature alloys from finishing to semi-finishing.

S10-S20

YBG202
PVD COATED

P01-P20

A combination of 2-4 μ nc-TiAlN coating on an ultra-fine carbide substrate of high tensile strength and toughness is suitable for milling from light to medium load and bore machining of many materials, turning of stainless steel from finishing to semi-finishing and rough turning of high-temperature alloys.

M10-M20

K10-K20

S20-S30

YBG302
PVD COATED

P10-P40

A combination of 2-4 μ nc-TiAlN coating and a tough substrate. It is suitable for medium load milling, bore machining, parting and grooving in a wide range of materials. It is also suitable for turning of stainless steel from semi-finishing to roughing.

M10-M30

K20-K40

S20-S30

YNG151
CERMET

P05-P15

TiCN based cermet, with superb resistance to thermoplastic transmutation and resistant built-up-edge is suitable for semi-finishing and finishing steel, stainless steel and cast iron.

M05-M15

K10-K30

YCB011
PCBN

K01-K10

PCBN tipped inserts provide high wear resistance and high tensile strength. They are suitable for high speed and high precision machining of cast iron, heat resistant alloys, Fe-based P/M materials.

H01-H10

YCB012
PCBN

K01-K10

PCBN tipped inserts provide very high tensile hardness and heat stability. They are most suitable for the continuous and slightly intermittent finishing of hardened steel (HRC 45-65) and cast iron.

H05-H15

YCD011
PCD

K01-K10

PCD tipped inserts exhibit high tensile hardness, good wear resistance, low friction and heat conductivity. They are suitable for machining non-ferrous metals (e.g. Cu, Al, Mg, Ti, Al-alloys with high silicon), and non-metallic materials (e.g. fiberglass, ceramics, reinforced plastic).

N01-N10

Turning Inserts Application Guide



	ISO-P	ISO-M	ISO-K	ISO-N	ISO-S	ISO-H
<p>Wear Resistance</p>	YNG151 Cermet		YNG151 Cermet			
	YBC151 CVD Coated		YBD151 CVD Coated			
	YBC251 CVD Coated	YBC251 CVD Coated	YBC151 CVD Coated			
	YBM151 CVD Coated	YBM151 CVD Coated	YD101 Uncoated	YCD011 PCD	YD201 Uncoated	YCB011 PCBN
	YBC351 CVD Coated	YBC351 CVD Coated	YD201 Uncoated	YD101 Uncoated	YBG202 PVD Coated	YCB012 PCBN
	YBM251 CVD Coated	YBM251 CVD Coated	YBD152 CVD Coated	YD201 Uncoated	YBG302 PVD Coated	YBC151 CVD Coated
	YBG202 PVD Coated	YBM351 CVD Coated	YBD102 CVD Coated			YD201 Uncoated
	YBG302 PVD Coated	YBG203 PVD Coated	YBG202 PVD Coated			
<p>Toughness</p>		YBG202 PVD Coated	YBG302 PVD Coated			
		YBG302 PVD Coated				

P	M	K	N	S	H
Steel	Stainless Steel	Cast Iron	Non-Ferrous Materials	High-Temperature Alloys & Titanium	Hard Materials

Negative Insert Chipbreaker Identification Guide



DF

Finishing

Unique super-finishing chipbreaker enables optimum chip flow in axial and radial cutting operations at very low feeds and cutting depths. Low cutting forces provide superb surface finish.

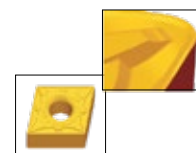

DM

Medium Machining

A premiere choice for turning applications of steel and stainless steel. It is ideal for semi-finishing to light roughing applications. Delivers high productivity and trouble-free machining. Provides good surface finish.



DR

Roughing

All purpose chipbreaker for roughing applications. Provides excellent value and high productivity, great chip flow control and the best combination of edge strength and low cutting force.

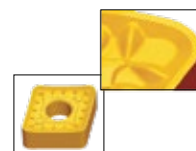

PM

Intermittent Cutting



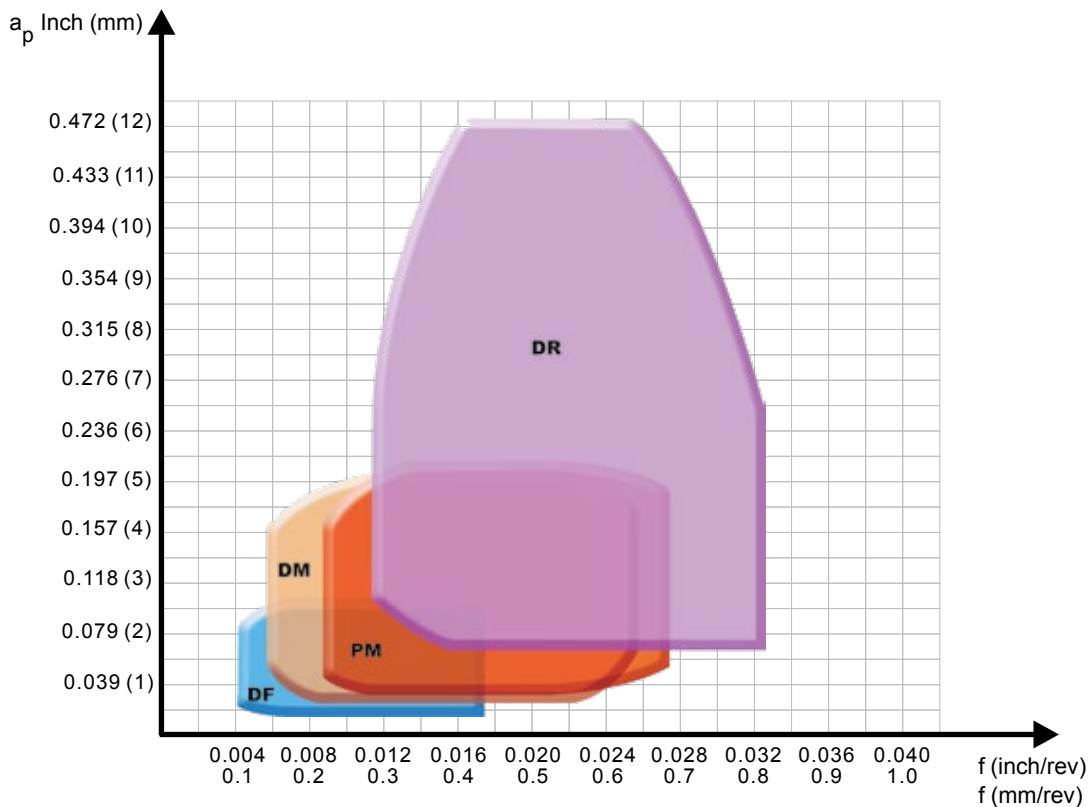
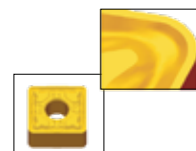



































All purpose chipbreaker with the broadest working area for intermittent cuts. The stronger cutting edge enables intermittent cutting.



Application Guide for Various Negative Chipbreakers

























































FOR FINISHING: ▶ a_p = Depth of Cut ▶ f_n = Feed per Revolution

Recommended Data	Workpiece Material	Recommended Geometry Inserts with Negative Angle						
$a_p=0.1-2.0$ mm $a_p=0.004-0.080$ inch $f_n=0.05-0.35$ mm/rev. $f_n=0.002-0.014$ inch/rev.	P	-DF						
$a_p=0.1-2.0$ mm $a_p=0.004-0.080$ inch $f_n=0.1-0.3$ mm/rev. $f_n=0.004-0.012$ inch/rev.	M	-DF						
$a_p=0.5-2.0$ mm $a_p=0.020-0.080$ inch $f_n=0.075-0.4$ mm/rev. $f_n=0.003-0.016$ inch/rev.	K	-DF						
		RCMX						
$a_p=0.1-2.0$ mm $a_p=0.004-0.080$ inch $f_n=0.05-0.35$ mm/rev. $f_n=0.002-0.014$ inch/rev.	N	RCMX						
$a_p=0.1-2.0$ mm $a_p=0.004-0.080$ inch $f_n=0.1-0.3$ mm/rev. $f_n=0.004-0.012$ inch/rev.	S	-DF						
		RCMX						
$a_p=0.1-1.5$ mm $a_p=0.004-0.060$ inch $f_n=0.1-0.2$ mm/rev. $f_n=0.004-0.008$ inch/rev.	H	_NGA						
		PCBN/ PCD						

Application Guide for Various Negative Chipbreakers



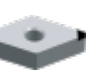



















FOR FINISHING: ▶ a_p = Depth of Cut ▶ f_n = Feed per Revolution

Recommended Data	Workpiece Material	Recommended Geometry Inserts with Negative Angle						
$a_p=1.5-5.0$ mm $a_p=0.060-0.200$ inch $f_n=0.2-0.5$ mm/rev. $f_n=0.008-0.020$ inch/rev.	P	-DM	 CNMG	 DNMG	 SNMG	 TNMG	 VNMG	 WNMG
		-PM	 CNMG	 DNMG	 SNMG	 TNMG	 VNMG	 WNMG
		RCMX	 RCMX	 RNMG				
$a_p=1.5-4.0$ mm $a_p=0.060-0.160$ inch $f_n=0.2-0.4$ mm/rev. $f_n=0.008-0.016$ inch/rev.	M	-DM	 CNMG	 DNMG	 SNMG	 TNMG	 VNMG	 WNMG
		NGA	 CNGA	 SNGA	 DNGA	 TNGA	 RNGA	
$a_p=1.5-4.0$ mm $a_p=0.060-0.160$ inch $f_n=0.2-0.4$ mm/rev. $f_n=0.008-0.016$ inch/rev.	K	-PM	 DNMG	 SNMG	 TNMG	 VNMG	 WNMG	
		RCMX	 RCMX					
		RCMX	 RCMX					
$a_p=1.5-4.0$ mm $a_p=0.060-0.160$ inch $f_n=0.2-0.5$ mm/rev. $f_n=0.008-0.020$ inch/rev.	S	-DM	 CNMG	 DNMG	 SNMG	 TNMG	 VNMG	 WNMG
		-PM	 DNMG	 SNMG	 TNMG	 VNMG	 WNMG	
$a_p=0.5-3.5$ mm $a_p=0.020-0.140$ inch $f_n=0.2-0.4$ mm/rev. $f_n=0.008-0.020$ inch/rev.	H	_NGA	 CNGA	 SNGA	 DNGA	 TNGA	 RNGA	
		PCBN/ PCD	 CCGW	 CNGA	 DCGW	 TCGW	 DNGA	 SNGA

Application Guide for Various Negative Chipbreakers



FOR FINISHING: ▶ a_p = Depth of Cut ▶ f_n = Feed per Revolution

Recommended Data	Workpiece Material	Recommended Geometry Inserts with Negative Angle					
$a_p=3.0-12.0$ mm $a_p=0.125-0.500$ inch $f_n=0.3-0.8$ mm/rev. $f_n=0.012-0.032$ inch/rev.	P	-DR	 CNMM	 DNMM	 SNMM		
		RCMX	 RCMX				
$a_p=3.0-10.0$ mm $a_p=0.125-0.375$ inch $f_n=0.4-0.7$ mm/rev. $f_n=0.16-0.280$ inch/rev.	M	-DR	 CNMM	 DNMM	 SNMM	 TNMM	
$a_p=3.0-9.0$ mm $a_p=0.125-0.360$ inch $f_n=0.4-0.7$ mm/rev. $f_n=0.012-0.028$ inch/rev.	K	_NGA	 CNGA	 SNGA	 DNGA	 TNGA	 RNGA
$a_p=2.0-12.0$ mm $a_p=0.080-0.500$ inch $f_n=0.3-0.7$ mm/rev. $f_n=0.012-0.028$ inch/rev.	N	RCMX	 RCMX				
$a_p=2.0-7.0$ mm $a_p=0.080-0.28$ inch $f_n=0.3-0.7$ mm/rev. $f_n=0.012-0.028$ inch/rev.	S	RCMX	 RCMX				
$a_p=2.0-7.0$ mm $a_p=0.080-0.028$ inch $f_n=0.3-0.6$ mm/rev. $f_n=0.012-0.024$ inch/rev.	H	_NGA	 CNGA	 SNGA	 DNGA	 TNGA	 RNGA

Turning Inserts

Carbide – Negative Chipbreakers – CVD Coated



CNMG – Negative 80° Rhombic



ANSI	CVD Coated Grade	Chipbreaker	ØI.C. (Inch)	Thickness (Inch)	Radius (Inch)	Code
CNMG432DF	YBC251	DF	0.500	0.187	0.031	573614
CNMG432DF	YBC351	DF	0.500	0.187	0.031	573616
CNMG432DF	YBM251	DF	0.500	0.187	0.031	573624
CNMG432DM	YBC151	DM	0.500	0.187	0.031	573632
CNMG432DM	YBC251	DM	0.500	0.187	0.031	573634
CNMG433DM	YBC251	DM	0.500	0.187	0.047	573674
CNMG643DM	YBC251	DM	0.750	0.250	0.047	573744
CNMG643PM	YBD102	PM	0.750	0.250	0.047	573758

DNMG – Negative 55° Rhombic



ANSI	CVD Coated Grade	Chipbreaker	ØI.C. (Inch)	Thickness (Inch)	Radius (Inch)	Code
DNMG432DF	YBC251	DF	0.500	0.187	0.031	574088
DNMG432DM	YBC251	DM	0.500	0.187	0.031	574096
DNMG431PM	YBC151	PM	0.500	0.187	0.016	574082
DNMG431PM	YBC251	PM	0.500	0.187	0.016	574084

TNMG – Negative Triangular



ANSI	CVD Coated Grade	Chipbreaker	ØI.C. (Inch)	Thickness (Inch)	Radius (Inch)	Code
TNMG432PM	YBC251	PM	0.500	0.187	0.031	575490
TNMG432GP	YBC251	GP	0.500	0.187	0.031	575458

VNMG – Negative 35° Rhombic



ANSI	CVD Coated Grade	Chipbreaker	ØI.C. (Inch)	Thickness (Inch)	Radius (Inch)	Code
VNMG331DF	YBC151	DF	0.375	0.187	0.016	575752
VNMG331DF	YBC251	DF	0.375	0.187	0.016	575754
VNMG332DF	YBC251	DF	0.375	0.187	0.031	575784
VNMG332DM	YBC251	DM	0.375	0.187	0.031	575794
VNMG-331PM	YBC251	PM	0.375	0.187	0.016	575764

WNMG – Negative 80° Trigon



ANSI	CVD Coated Grade	Chipbreaker	ØI.C. (Inch)	Thickness (Inch)	Radius (Inch)	Code
WNMG432DF	YBC251	DF	0.500	0.187	0.031	575968
WNMG432DM	YBC251	DM	0.500	0.187	0.031	575980
WNMG432DM	YBC351	DM	0.500	0.187	0.031	575982
WNMG433DM	YBC251	DM	0.500	0.187	0.047	575703
WNMG432PM	YBC251	PM	0.500	0.187	0.031	575717
WNMG432PM	YBC351	PM	0.500	0.187	0.031	575719
WNMG433PM	YBC251	PM	0.500	0.187	0.047	575729

Positive Insert Chipbreaker Identification Guide



HF

Finishing

Optimized chipbreaker for precision finishing applications with sharp cutting edge. Provides excellent chip control and surface finish at small depths of cut and small feed rates.

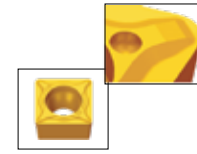

HM

Medium Machining

Premiere choice for semi-finishing bores. Unique chipbreaker enables the chips to flow smoothly.

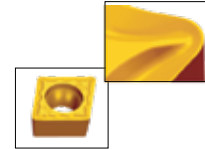

HR

Roughing



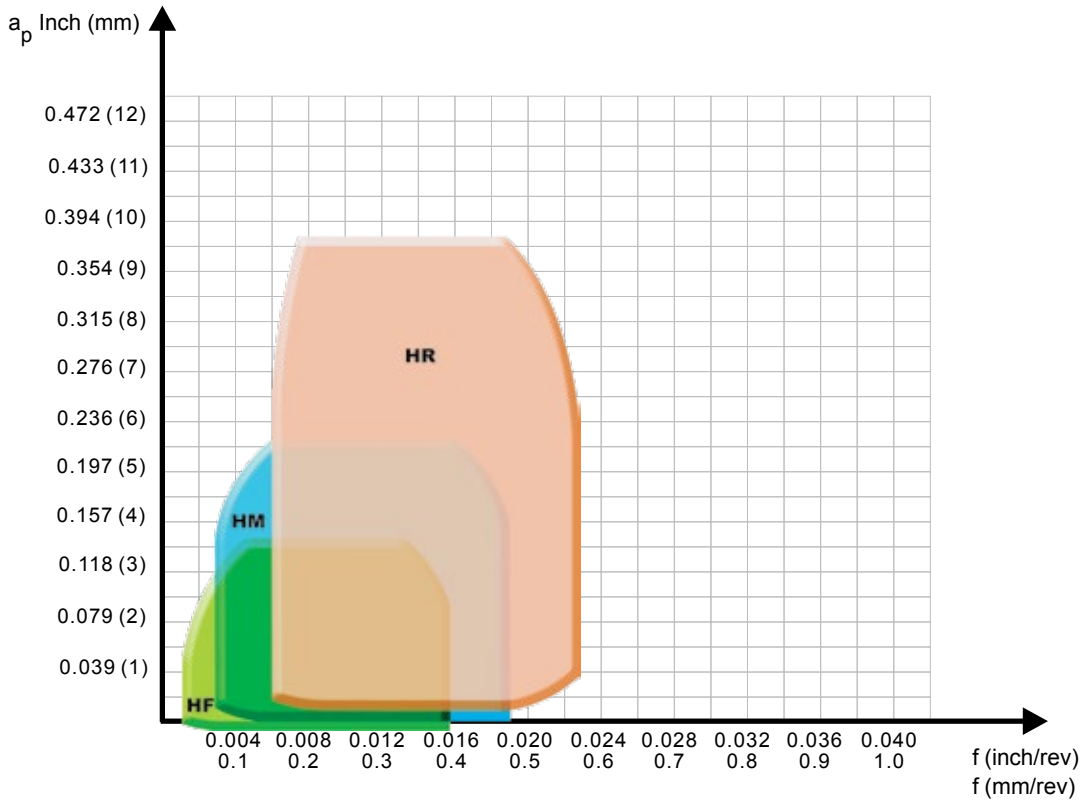
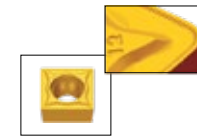































Chipbreaker with a strong cutting edge, for tough operations like interrupted cuts and castings.



Application Guide for Various Positive Chipbreakers





































FOR FINISHING: ▶ a_p = Depth of Cut ▶ f_n = Feed per Revolution

Recommended Data	Workpiece Material	Recommended Geometry Inserts with Positive Angle					
$a_p=0.1-2.0$ mm $a_p=0.004-0.080$ inch $f_n=0.05-0.30$ mm/rev. $f_n=0.002-0.012$ inch/rev.	P	-HF	 CCMT	 DCMT	 SCMT	 TCMT	 VBMT
$a_p=0.1-2.0$ mm $a_p=0.004-0.080$ inch $f_n=0.1-0.3$ mm/rev. $f_n=0.004-0.012$ inch/rev.	M	-HF	 CCMT	 DCMT	 SCMT	 TCMT	 VBMT
$a_p=0.1-1.5$ mm $a_p=0.004-0.060$ inch $f_n=0.1-0.3$ mm/rev. $f_n=0.004-0.012$ inch/rev.	K	-HF	 CCMT	 DCMT	 SCMT	 TCMT	 VBMT
$a_p=0.1-2.0$ mm $a_p=0.004-0.080$ inch $f_n=0.05-0.4$ mm/rev. $f_n=0.002-0.016$ inch/rev.	N	-LH	 CCGX	 DCGX	 TCGX	 VCGX	
$a_p=0.1-1.5$ mm $a_p=0.004-0.060$ inch $f_n=0.1-0.3$ mm/rev. $f_n=0.004-0.012$ inch/rev.	S	-HF	 CCMT	 DCMT	 SCMT	 TCMT	 VBMT
$a_p=0.1-1.5$ mm $a_p=0.004-0.060$ inch $f_n=0.05-0.25$ mm/rev. $f_n=0.002-0.010$ inch/rev.	H	-HF	 CCMT	 DCMT	 SCMT	 TCMT	 VBMT
		PCBN/ PCD	 CCGW	 DCGW	 TCGW	 TPGN	 SPGN

Application Guide for Various Positive Chipbreakers































FOR FINISHING: ▶ a_p = Depth of Cut ▶ f_n = Feed per Revolution

Recommended Data	Workpiece Material		Recommended Geometry Inserts with Positive Angle					
$a_p=1.0-4.0$ mm $a_p=0.040-0.160$ inch $f_n=0.2-0.5$ mm/rev. $f_n=0.008-0.020$ inch/rev.	P	-HM	 CCMT	 DCMT	 SCMT	 TCMT	 VBMT	
$a_p=1.0-3.5$ mm $a_p=0.040-0.140$ inch $f_n=0.2-0.4$ mm/rev. $f_n=0.008-0.016$ inch/rev.	M	-HM	 CCMT	 DCMT	 SCMT	 TCMT	 VBMT	
$a_p=1.0-3.0$ mm $a_p=0.040-0.120$ inch $f_n=0.2-0.4$ mm/rev. $f_n=0.008-0.016$ inch/rev.	K	-HM	 CCMT	 DCMT	 SCMT	 TCMT	 VBMT	
$a_p=1.0-4.0$ mm $a_p=0.040-0.160$ inch $f_n=0.2-0.4$ mm/rev. $f_n=0.008-0.016$ inch/rev.	N	-LH	 CCGX	 DCGX	 TCGX	 VCGX		
$a_p=1.0-3.5$ mm $a_p=0.040-0.140$ inch $f_n=0.2-0.4$ mm/rev. $f_n=0.008-0.016$ inch/rev.	S	-HM	 CCMT	 DCMT	 SCMT	 TCMT	 VBMT	
$a_p=1.0-3.0$ mm $a_p=0.040-0.120$ inch $f_n=0.2-0.4$ mm/rev. $f_n=0.008-0.016$ inch/rev.	H	-HM	 CCMT	 DCMT	 SCMT	 TCMT	 VBMT	
		PCBN/ PCD	 CCGW	 DCGW	 TCGW	 TPGN	 SPGN	 VCGW

Application Guide for Various Positive Chipbreakers



FOR FINISHING: ▶ **ap** = Depth of Cut ▶ **fn** = Feed per Revolution

Recommended Data	Workpiece Material		Recommended Geometry Inserts with Positive Angle				
ap=3.0-7.0 mm ap=0.120-0.280 inch fn=0.3-0.7 mm/rev. fn=0.012-0.028 inch/rev.	P	-HR	 CCMT	 DCMT	 SCMT	 TCMT	 VBMT
ap=2.0-5.0 mm ap=0.080-0.200 inch fn=0.3-0.6 mm/rev. fn=0.012-0.024 inch/rev.	M	-HR	 CCMT	 DCMT	 SCMT	 TCMT	 VBMT
ap=3.0-6.0 mm ap=0.120-0.240 inch fn=0.3-0.6 mm/rev.fn=0.012-0.024 inch/rev.	K	-HR	 CCMT	 DCMT	 SCMT	 TCMT	 VBMT
ap=0.5-5.0 mm ap=0.020-0.200 inch fn=0.2-0.6 mm/rev. fn=0.008-0.024 inch/rev.	N	-LH	 CCGX	 DCGX	 TCGX	 VCGX	
ap=2.0-6.0 mm ap=0.080-0.240 inch fn=0.3-0.6 mm/rev. fn=0.012-0.024 inch/rev.	S	-HR	 CCMT	 DCMT	 SCMT	 TCMT	 VBMT
ap=2.0-5.0 mm ap=0.080-0.200 inch fn=0.3-0.5 mm/rev. fn=0.012-0.020 inch/rev.	H	-HR	 CCMT	 DCMT	 SCMT	 TCMT	 VBMT

Turning Inserts

Carbide – Positive Chipbreakers – CVD Coated



CCMT & CCMW – Positive 80° Rhombic



ANSI	CVD Coated Grade	Chipbreaker	Ø.I.C. (Inch)	Thickness (Inch)	Radius (Inch)	Code
CCMT2(1.5)1HF	YBC151	HF	0.250	0.094	0.016	573166
CCMT2(1.5)1HM	YBC151	HM	0.250	0.094	0.016	573182
CCMT2(1.5)2HM	YBC151	HM	0.250	0.094	0.031	573212
CCMT3(2.5)2HM	YBC251	HM	0.375	0.156	0.031	573290
CCMT432HR	YBD152	HR	0.500	0.187	0.031	573384

DCMT – Positive 55° Rhombic



ANSI	CVD Coated Grade	Chipbreaker	Ø.I.C. (Inch)	Thickness (Inch)	Radius (Inch)	Code
DCMT2(1.5)1HM	YBC251	HM	0.250	0.094	0.016	573840

SCMT – Positive Square



ANSI	CVD Coated Grade	Chipbreaker	Ø.I.C. (Inch)	Thickness (Inch)	Radius (Inch)	Code
SCMT3(2.5)1HM	YBC251	HM	0.375	0.156	0.016	574560

TCMT – Positive Triangular



ANSI	CVD Coated Grade	Chipbreaker	Ø.I.C. (Inch)	Thickness (Inch)	Radius (Inch)	Code
TCMT2(1.5)1HF	YBC251	HF	0.250	0.094	0.016	575150
TCMT2(1.5)1HM	YBC251	HM	0.250	0.094	0.016	575160

VBMT – Positive 35° Rhombic



ANSI	CVD Coated Grade	Chipbreaker	Ø.I.C. (Inch)	Thickness (Inch)	Radius (Inch)	Code
VBMT331HM	YBC251	HM	0.375	0.187	0.016	575656
VBMT332HM	YBC251	HM	0.375	0.187	0.031	575678



Turning Inserts

For Machining Aluminum – Uncoated

CCGX – Positive 80° Rhombic



ANSI	Uncoated Grade	ØI.C. (Inch)	Thickness (Inch)	Radius (Inch)	Code
CCGX2(1.5)0	YDI01	0.250	0.094	0.008	573144
CCGX2(1.5)1	YDI01	0.250	0.094	0.016	573146
CCGX2(1.5)2	YDI01	0.250	0.094	0.031	573148
CCGX3(2.5)0	YDI01	0.375	0.156	0.008	573150
CCGX3(2.5)1	YDI01	0.375	0.156	0.016	573152
CCGX3(2.5)2	YDI01	0.375	0.156	0.031	573154
CCGX432	YDI01	0.500	0.187	0.031	573156

DCGX – Positive 55° Rhombic



ANSI	Uncoated Grade	ØI.C. (Inch)	Thickness (Inch)	Radius (Inch)	Code
DCGX2(1.5)0	YDI01	0.250	0.094	0.008	573802
DCGX2(1.5)1	YDI01	0.250	0.094	0.016	573804
DCGX3(2.5)0	YDI01	0.375	0.156	0.008	573806
DCGX3(2.5)1	YDI01	0.375	0.156	0.016	573808
DCGX3(2.5)2	YDI01	0.375	0.156	0.031	573810

TCGX – Positive Triangular



ANSI	Uncoated Grade	ØI.C. (Inch)	Thickness (Inch)	Radius (Inch)	Code
TCGX2(1.5)1	YDI01	0.250	0.094	0.016	575096
TCGX3(2.5)1	YDI01	0.375	0.156	0.016	575098
TCGX3(2.5)2	YDI01	0.375	0.156	0.031	575100

VCGX – Positive 35° Rhombic



ANSI	Uncoated Grade	ØI.C. (Inch)	Thickness (Inch)	Radius (Inch)	Code
VCGX2(1.5)1	YDI01	0.250	0.094	0.016	575732
VCGX331	YDI01	0.375	0.187	0.016	575734
VCGX333	YDI01	0.375	0.187	0.047	575753

Turning Inserts Identification Guide



1 Insert Shape

A	B	C	D	E	H	K	L
							Special
O	P	R	S	T	V	W	X

2 Clearance Angle

	5°	7°	15°	20°	25°	30°	0°	11°
	B	C	D	E	F	G	N	P

3 Tolerance

	Tolerance			I.C. Size					
	m	t	I.C.	.250	.375	.500	.625	.750	1
A	±.0002	±.0001	±.0001	•	•	•	•	•	•
C	±.0005	±.0010	±.0010	•	•	•	•	•	•
E	±.0010	±.0010	±.0010	•	•	•	•	•	•
F	±.0020	±.0010	±.0010	•	•	•	•	•	•
G	±.0010	±.0005	±.0010	•	•	•	•	•	•
H	±.0005	±.0010	±.0010	•	•	•	•	•	•
K	±.0005	±.0010	±.0020	•	•				
			±.0030			•			
			±.0040				•	•	
			±.0050						•
M	±.0050	±.0050	±.0020	•	•				
			±.0030			•			
			±.0040				•	•	
			±.0050						•

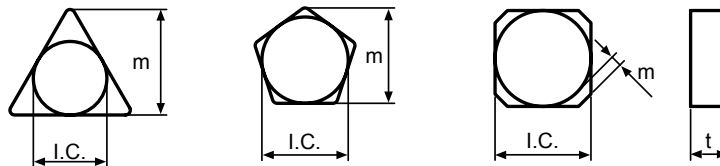

4 Cross Section Shape

								Special
A	F	G	M	N	R	T	W	X

Turning Inserts Identification Guide



5
Cutting Edge Length

I.C. Size	Symbol	C	D	S	R	T	V	W	H
Inch		Metric							
5/32	1.2(5)	03	04	03	03	06		02	
3/16	1.5(6)	04	05	04	04	08	08		
7/32	1.8(7)	05	06	05	05	09	09	03	
1/4	2	06	07	06	06	11	11	04	
5/16	2.5	08	09	07	07	13	13	05	
3/8	3	09	11	09	09	16	16	06	
1/2	4	12	15	12	12	22	22	08	05
5/8	5	16	19	15	15	27	27	10	09
3/4	6	19	23	19	19	33	33	13	10
1	8	25	31	25	25	44	44	17	

*() symbol for small size insert

6
Thickness

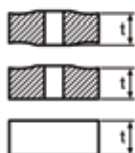

Symbol(t)	Inch
1.5(3)	3/32
2	1/8
2.5	5/32
3	3/16
4	1/4
5	5/16
6	3/8

7
Nose Radius



Symbol(t)	Inch
0.5	.008
1	1/64
2	1/32
3	3/64
4	1/16
5	5/64
6	3/32
00	Round insert

8
Chip Breaker

For Application

YG Turn Chip Breakers Application area

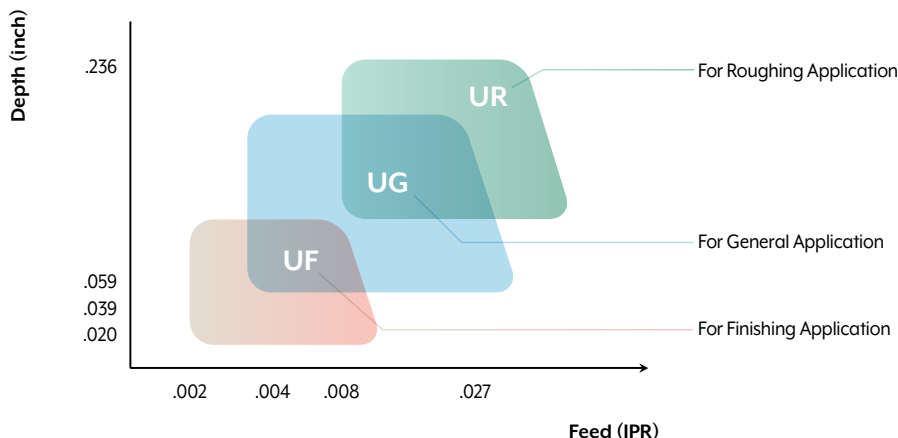

Turning Inserts

Carbide



CCMT



ANSI	Grade	Chipbreaker	Ø.I.C. (Inch)	Thickness (Inch)	Radius (Inch)	Code
CCMT2(1.5)1UF	YG801	UF	0.254	0.094	0.016	577510
CCMT2(1.5)2UG	YG801	UG	0.254	0.094	0.031	577511
CCMT3(2.5)1UR	YG801	UR	0.381	0.156	0.016	577512
CCMT3(2.5)2UG	YG801	UG	0.381	0.156	0.031	577513
CCMT432UG	YG801	UG	0.508	0.187	0.031	577514

DCMT



ANSI	Grade	Chipbreaker	Ø.I.C. (Inch)	Thickness (Inch)	Radius (Inch)	Code
DCMT2(1.5)1UF	YG801	UF	0.305	0.094	0.016	577515
DCMT3(2.5)1UF	YG801	UF	0.458	0.156	0.016	577516
DCMT3(2.5)2UG	YG801	UG	0.458	0.156	0.031	577517

RCMT



ANSI	Grade	Chipbreaker	Ø.I.C. (Inch)	Thickness (Inch)	Radius (Inch)	Code
RCMT0602M0	YG801	-	-	0.094	-	577518
RCMT0803M0	YG801	-	-	0.125	-	577519
RCMT10T3M0	YG801	-	-	3.970	-	577520
RCMT1204M0	YG801	-	-	0.187	-	577521

SCMT



ANSI	Grade	Chipbreaker	Ø.I.C. (Inch)	Thickness (Inch)	Radius (Inch)	Code
SCMT3(2.5)1UF	YG801	UF	0.375	0.156	0.016	577522
SCMT3(2.5)2UG	YG801	UG	0.375	0.156	0.031	577523

TCMT



ANSI	Grade	Chipbreaker	Ø.I.C. (Inch)	Thickness (Inch)	Radius (Inch)	Code
TCMT2(1.5)1UF	YG801	UF	0.433	0.094	0.016	577524
TCMT3(2.5)1UF	YG801	UF	0.650	0.156	0.016	577525
TCMT3(2.5)2UG	YG801	UG	0.650	0.156	0.031	577526

VBMT



ANSI	Grade	Chipbreaker	Ø.I.C. (Inch)	Thickness (Inch)	Radius (Inch)	Code
VBMT331UF	YG801	UF	0.654	0.187	0.016	577527
VBMT332UG	YG801	UG	0.654	0.187	0.031	577528

Turning Inserts

Carbide



CNMA & CNMG



ANSI	Grade	Chipbreaker	ØI.C. (Inch)	Thickness (Inch)	Radius (Inch)	Code
CNMA432UC	YG1001	UC	0.508	0.187	0.031	577529
CNMA433UC	YG1001	UC	0.508	0.187	0.047	577530
CNMA543UC	YG1001	UC	0.635	0.250	0.047	577531
CNMG431UF	YG801	UF	0.508	0.187	0.016	577532
CNMG432UG	YG801	UG	0.508	0.187	0.031	577533
CNMG433UR	YG801	UR	0.508	0.187	0.047	577534

DNMG



ANSI	Grade	Chipbreaker	ØI.C. (Inch)	Thickness (Inch)	Radius (Inch)	Code
DNMG431UF	YG801	UF	0.610	0.187	0.016	577535
DNMG432UG	YG801	UG	0.610	0.187	0.031	577536
DNMG441UF	YG801	UF	0.610	0.250	0.016	577537
DNMG442UG	YG801	UG	0.610	0.250	0.031	577538
DNMG443UR	YG801	UR	0.610	0.250	0.047	577539

SNMA & SNMG



ANSI	Grade	Chipbreaker	ØI.C. (Inch)	Thickness (Inch)	Radius (Inch)	Code
SNMA432UC	YG1001	UC	0.500	0.187	0.031	577540
SNMA433UC	YG1001	UC	0.500	0.187	0.047	577541
SNMG431UF	YG801	UF	0.500	0.187	0.016	577542
SNMG432UG	YG801	UG	0.500	0.187	0.031	577543
SNMG433UR	YG801	UR	0.500	0.187	0.047	577544

TNMA, TNMG & TNUX



ANSI	Grade	Chipbreaker	ØI.C. (Inch)	Thickness (Inch)	Radius (Inch)	Code
TNMA332UC	YG1001	UC	0.650	0.187	0.031	577545
TNMA333UC	YG1001	UC	0.650	0.187	0.047	577546
TNMG331UF	YG801	UF	0.650	0.187	0.016	577547
TNMG332UG	YG801	UG	0.650	0.187	0.031	577548
TNMG333UR	YG801	UR	0.650	0.187	0.047	577549
TNMG431UF	YG801	UF	0.866	0.187	0.016	577550
TNMG432UG	YG801	UG	0.866	0.187	0.031	577551
TNMG433UR	YG801	UR	0.866	0.187	0.047	577552
TNUX331L	YG801	-	0.650	0.187	0.016	577553
TNUX332L	YG801	-	0.650	0.187	0.031	577554
TNUX331R	YG801	-	0.650	0.187	0.016	577555
TNUX332R	YG801	-	0.650	0.187	0.031	577556

VNMG



ANSI	Grade	Chipbreaker	ØI.C. (Inch)	Thickness (Inch)	Radius (Inch)	Code
VNMG331UF	YG801	UF	0.650	0.375	0.016	577557
VNMG332UG	YG801	UG	0.654	0.375	0.031	577558
VNMG333UR	YG801	UR	0.650	0.375	0.047	577559

Turning Inserts

Carbide



WNMA & WNMG

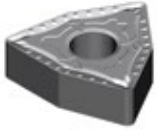

ANSI	Grade	Chipbreaker	ØI.C. (Inch)	Thickness (Inch)	Radius (Inch)	Code
WNMA431UC	YG1001	UC	0.342	0.187	0.016	577560
WNMA432UC	YG1001	UC	0.342	0.187	0.031	577561
WNMA433UC	YG1001	UC	0.342	0.187	0.047	577562
WNMG331UF	YG801	UF	0.254	0.187	0.016	577563
WNMG332UG	YG801	UG	0.254	0.187	0.031	577564
WNMG431UF	YG801	UF	0.342	0.187	0.016	577565
WNMG432UG	YG801	UG	0.342	0.187	0.031	577566
WNMG433UR	YG801	UR	0.320	0.187	0.047	577567

Call your Local KAR Distributor
for all your KAR needs!

Find them at WWW.KAR.CA,
click FIND A DISTRIBUTOR

Grooving Inserts

Carbide – Internal & External



CARBIDE GRADE BXC: P30-P50
K25-K40

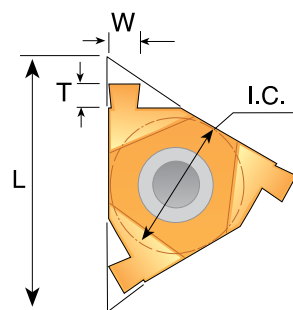

External Right Hand
or Internal Left Hand

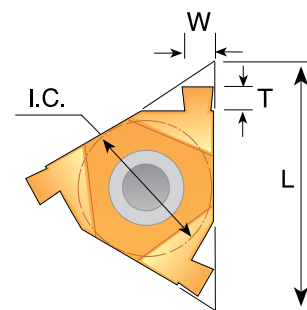

Internal Right Hand
or External Left Hand

- PVD TiN coated grade for low cutting speed
- Works well with a wide range of steel and stainless steel

NOTE: Shim must be changed to AE 16-0 or AI 16-0

Change shim from threading to grooving and use the same threading toolholder

Internal IR/EL

Description	I.C. (Inch)	W ±0.001" (Inch)	T (Inch)	L (mm)	Code
16 IR/EL 0.039	3/8	0.039	0.055	16	570685
16 IR/EL 0.047	3/8	0.047	0.063	16	570686
16 IR/EL 0.055	3/8	0.055	0.071	16	570687
16 IR/EL 0.067	3/8	0.067	0.079	16	570688
16 IR/EL 0.077	3/8	0.077	0.079	16	570689
16 IR/EL 0.089	3/8	0.089	0.089	16	570690
SHIM -- AI 16-0	-	-	-	-	570691

External ER/IL

Description	I.C. (Inch)	W ±0.001" (Inch)	T (Inch)	L (mm)	Code
16 ER/IL 0.039	3/8	0.039	0.055	16	570675
16 ER/IL 0.047	3/8	0.047	0.063	16	570676
16 ER/IL 0.055	3/8	0.055	0.071	16	570677
16 ER/IL 0.067	3/8	0.067	0.079	16	570678
16 ER/IL 0.077	3/8	0.077	0.079	16	570679
16 ER/IL 0.089	3/8	0.089	0.089	16	570680
SHIM -- AE 16-0	-	-	-	-	570681

Recommended Cutting Speeds

ISO	Materials	Cutting Speed m/min (ft/min)
P	Low and medium carbon steels	20-100 (66-330)
	High carbon steels	30-80 (100-265)
	Alloy steels, treated steels	40-90 (132-300)
M	Stainless steels	30-80 (100-265)
	Cast steels	30-90 (100-300)
K	Cast Iron	30-90 (100-300)
N	Non-ferrous and Aluminum	20-200 (66-660)

Tiny Tools Identification Guide

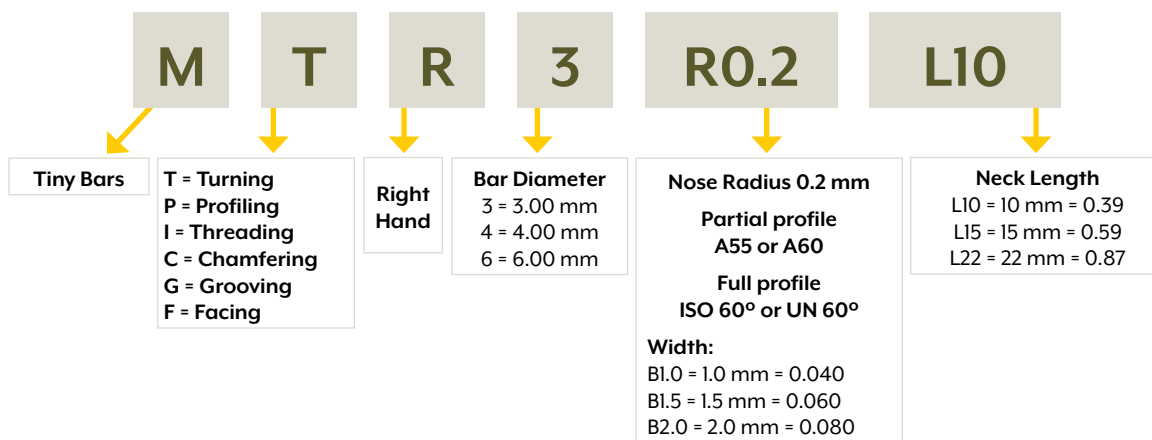

Tiny Bar Holders Identification Guide

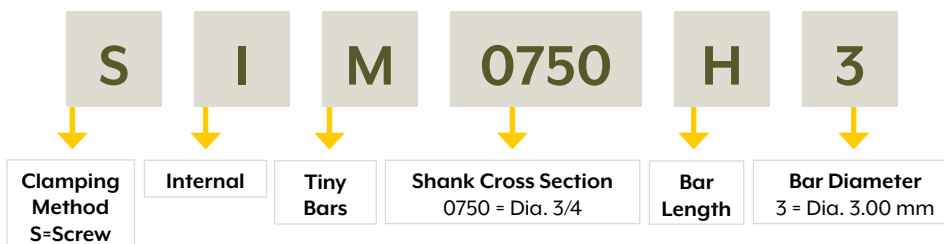

Recommended Cutting Speeds

ISO	Materials	Cutting Speed ft/min
P	Low and medium carbon steels	65-460
	High carbon steels	100-330
	Alloy steels, treated steels	130-300
M	Stainless steels	65-300
	Cast steels	130-300
K	Cast iron	130-390
N	Non-ferrous and aluminum	160-390
H	Hardened materials	40-100
S	Super alloy and titanium	50-100

Threading Passes

Pitch		Number of Passes
mm	TPI	
0.50	48	6-12
0.70	36	7-14
0.80	32	7-16
1.00	24	8-18
1.25	20	8-20
1.50	16	10-22

RECOMMENDED FEED RATE:

0.0005-0.001 inch/rev

Tiny Tools

Solid Carbide Grade BXC – For Working on Small Bores

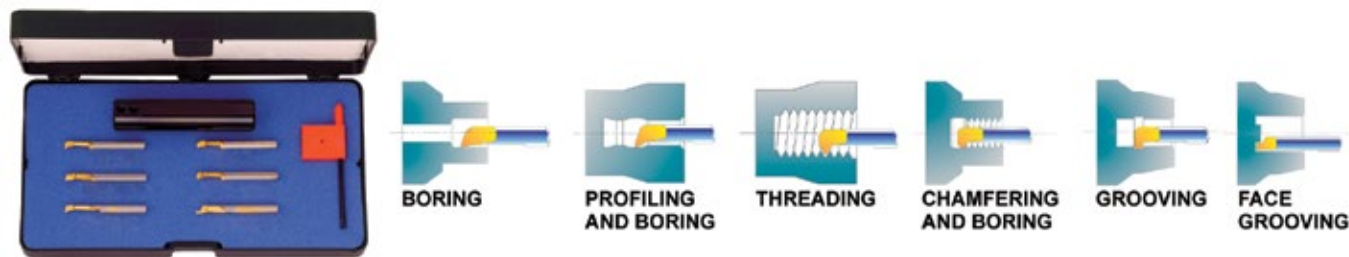

CARBIDE GRADE BXC: **P30-P50**
K25-K40

- Bar diameter: 4mm
- PVD TiN coated grade for low cutting speed
- Works well with a wide range of steel and stainless steel

Complete Set Includes: Boring bar 570093, profiling bar 570071, threading bar 570078, chamfering bar 570084, grooving bar 570088, face grooving bar 570091, bar holder 570104, and a Torx®15 key

Description	Code
Tiny Tools Complete Set	570110
Boring Bar	570093
Profiling Bar	570071
Threading Bar	570078
Chamfering Bar	570084
Grooving Bar	570088
Face Grooving Bar	570091
Bar Holder	570104

BAR HOLDER

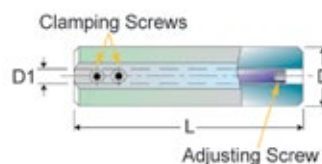

Bar Holders

DI (mm)	L Inch (mm)	D Inch (mm)	Reference Key	Code
3.0	3.5 (88)	0.75 (19.05)	Torx®15	570102
4.0	3.5 (88)	0.75 (19.05)	Torx®15	570104
6.0	3.5 (88)	0.75 (19.05)	Torx®15	570106

Screws

Description	Reference Key	Code
Clamping Screw for Bar Holders	Torx®15	570S25
Adjusting Screw for Bar Holders	Torx®15	570S35

Grooving Bars – Coolant Through

MGR - GROOVING BARS

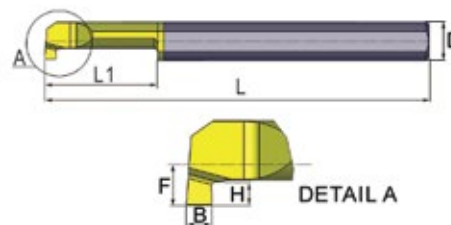

D (mm)	L Inch (mm)	L1 Inch (mm)	B Inch (mm)	H Inch (mm)	F Inch (mm)	Minimum Bore Diameter Inch (mm)	Reference Holders	Code
4.0	2.0 (50)	0.39 (10)	0.06 (1.5)	0.04 (1.0)	0.07 (1.7)	0.16 (4.1)	570104	570088
6.0	2.0 (50)	0.59 (15)	0.08 (2.0)	0.06 (1.5)	0.11 (2.8)	0.24 (6.1)	570106	570090

Tiny Tools



Solid Carbide – For Working on Small Bores (continued)

Boring Bars – Coolant Through

MTR - BORING BARS

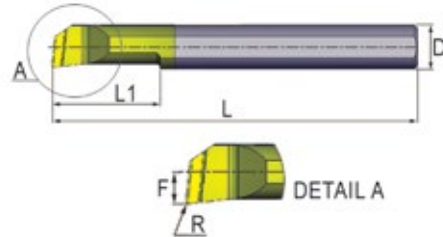

D (mm)	L Inch (mm)	L1 Inch (mm)	R Inch (mm)	F Inch (mm)	Minimum Bore Diameter Inch (mm)	Reference Holders	Code
3.0	1.5 (39)	0.39 (10)	0.006 (0.15)	0.03 (0.8)	0.08 (2.1)	570102	570092
4.0	2.0 (51)	0.39 (10)	0.008 (0.20)	0.07 (1.7)	0.16 (4.1)	570104	570093
4.0	2.0 (51)	0.59 (15)	0.008 (0.20)	0.07 (1.7)	0.16 (4.1)	570104	570094
6.0	2.0 (51)	0.87 (22)	0.008 (0.20)	0.11 (2.8)	0.24 (6.1)	570106	570096

Face Grooving Bars – Coolant Through

MFR - FACE GROOVING BARS

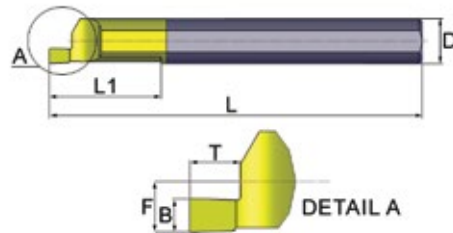

D (mm)	L Inch (mm)	L1 Inch (mm)	B Inch (mm)	T Inch (mm)	F Inch (mm)	Minimum Bore Diameter Inch (mm)	Reference Holders	Code
4.0	2.0 (50)	0.59 (15)	0.04 (1.00)	0.06 (1.5)	0.08 (2.1)	0.20 (5.0)	570104	570091
6.0	2.0 (50)	0.87 (22)	0.04 (1.00)	0.06 (1.5)	0.12 (3.0)	0.31 (8.0)	570106	570101

Profiling Boring Bars – Coolant Through

MPR - PROFILING BORING BARS

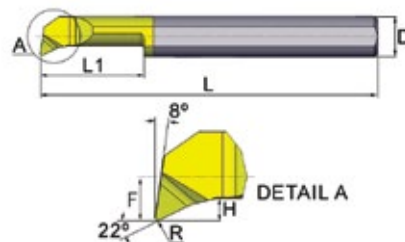

D (mm)	L Inch (mm)	L1 Inch (mm)	R Inch (mm)	H Inch (mm)	F Inch (mm)	Minimum Bore Diameter Inch (mm)	Reference Holders	Code
3.0	1.5 (39)	0.39 (10)	0.006 (0.15)	0.02 (0.5)	0.03 (0.8)	0.08 (2.1)	570102	570070
4.0	2.0 (51)	0.39 (10)	0.008 (0.20)	0.03 (0.8)	0.07 (1.7)	0.16 (4.1)	570104	570071
4.0	2.0 (51)	0.59 (15)	0.008 (0.20)	0.03 (0.8)	0.07 (1.7)	0.16 (4.1)	570104	570072
6.0	2.0 (51)	0.87 (22)	0.008 (0.20)	0.06 (1.5)	0.11 (2.8)	0.24 (6.1)	570106	570074

Tiny Tools

Solid Carbide – For Working on Small Bores (*continued*)

Threading Bars – Partial Profile 60° – Coolant Through

MIR - THREADING BARS - PARTIAL PROFILE 60°

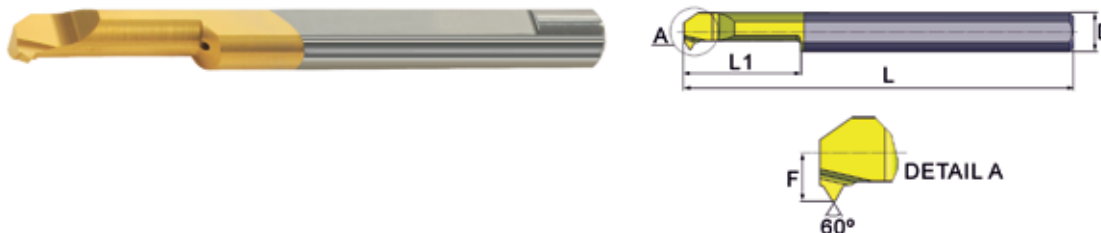

D (mm)	L Inch (mm)	L1 Inch (mm)	Pitch Range (TPI)	Pitch Range (mm)	F Inch (mm)	Minimum Bore Diameter Inch (mm)	Reference Holders	Code
3.0	1.5 (39)	0.59 (15)	32-24	0.8-1.0	0.06 (1.4)	0.13 (3.2)	570102	570076
4.0	2.0 (50)	0.59 (15)	32-24	0.8-1.0	0.07 (1.7)	0.16 (4.1)	570104	570078
6.0	2.0 (50)	0.59 (15)	24-16	1.0-1.5	0.09 (2.2)	0.24 (6.1)	570106	570080

Chamfering Boring Bars – Coolant Through

MCR - CHAMFERING BORING BARS

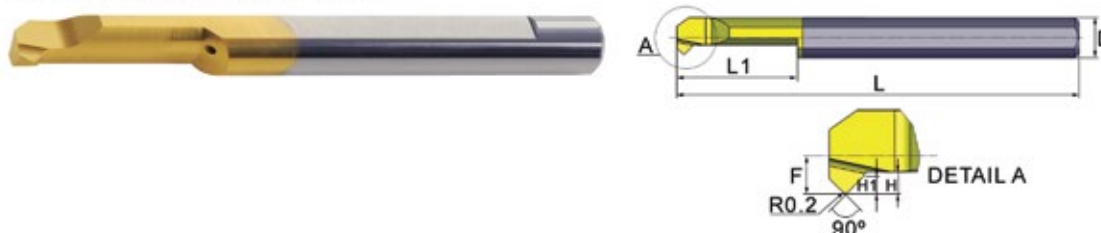

D (mm)	L Inch (mm)	L1 Inch (mm)	R Inch (mm)	H Inch (mm)	H1 Inch (mm)	F Inch (mm)	Minimum Bore Diameter Inch (mm)	Reference Holders	Code
3.0	1.5 (39)	0.39 (10)	0.008 (0.20)	0.03 (0.8)	0.01 (0.3)	0.05 (1.3)	0.12 (3.1)	570102	570082
4.0	2.0 (50)	0.59 (15)	0.008 (0.20)	0.03 (0.8)	0.02 (0.4)	0.07 (1.7)	0.16 (4.1)	570104	570084
6.0	2.0 (50)	0.59 (15)	0.008 (0.20)	0.06 (1.5)	0.03 (0.7)	0.11 (2.8)	0.24 (6.1)	570106	570086

Blade Holders

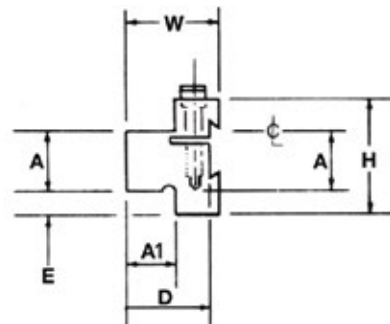
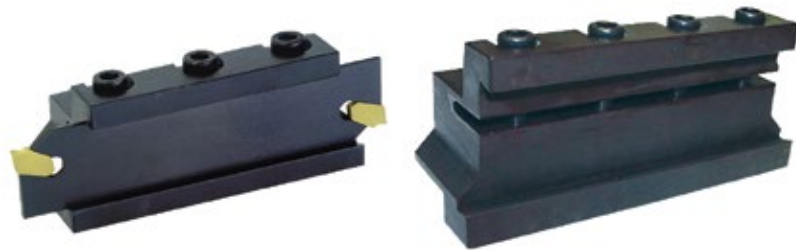

Interchangeable with most popular brands

A (Inch)	A1 (Inch)	D (Inch)	E (Inch)	H (Inch)	W (Inch)	Overall Length (Inch)	Reference Blade	Reference Blade Height Inch (mm)	Code
5/8	5/8	31/32	11/64	1-3/16	1-1/16	3	577049	0.787 (20)	577001
5/8	5/8	1-1/32	7/16	1-1/2	1-3/16	3	577051, 577053, 577055, 577057, 577059	1.020 (26)	577003
3/4	3/4	1-1/8	21/64	1-17/32	1-5/16	3-3/8	577051, 577053, 577055, 577057, 577059	1.020 (26)	577005
3/4	3/4	1-1/8	1/2	1-7/8	1-3/8	4	577061, 577063, 577066, 577067, 577069	1.260 (32)	577011
1	1	1-13/32	5/16	1-7/8	1-5/8	4-3/8	577061, 577063, 577066, 577067, 577069	1.260 (32)	577007
1-1/4	1-1/4	1-11/16	1/8	1-7/8	1-5/8	4-11/16	577061, 577063, 577066, 577067, 577069	1.260 (32)	577009

Blades

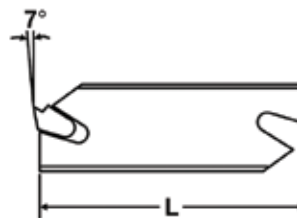
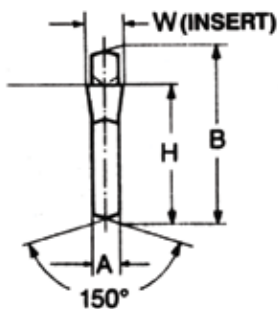

A (Inch)	L (Inch)	H (Inch)	B Inch (mm)	Max Ø (Inch)	Insert Width Reference (Inch)	Model	Code
1/16	3-3/8	39/64	0.787 (20)	1-1/2	0.087 + 0.094	GIH19-2	577049
1/16	4-5/16	53/64	1.020 (26)	2	0.087 + 0.094	GIH26-2	577051
3/32	4-5/16	53/64	1.020 (26)	3	0.120	GIH26-3	577053
1/8	4-5/16	53/64	1.020 (26)	3	0.160	GIH26-4	577055
5/32	4-5/16	53/64	1.020 (26)	4	0.187 + 0.200	GIH26-5	577057
13/64	4-5/16	53/64	1.020 (26)	4	0.250	GIH26-6	577059
3/32	5-7/8	63/64	1.260 (32)	4	0.120	GIH32-3	577061
1/8	5-7/8	63/64	1.260 (32)	4	0.160	GIH32-4	577063
5/32	5-7/8	63/64	1.260 (32)	5	0.187 + 0.200	GIH32-5	577065
13/64	5-7/8	63/64	1.260 (32)	5	0.250	GIH32-6	577067
5/16	5-7/8	63/64	1.260 (32)	5-1/2	0.375	GIH32-9	577069

Inserts

Neutral



Neutral shown



NEUTRAL

CARBIDE GRADES:

C2 - Uncoated for non-ferrous materials

C6 - Uncoated for steel

TiN - TiN coated for steel

Insert Width (Inch)	C2	C6	TiN
	Code	Code	Code
0.087	577071	577073	577075
0.094	577077	577079	577081
0.120	577083	577085	577087
0.160	577089	577091	577093
0.187	577095	577097	577099
0.200	577101	577103	577105
0.250	577107	577109	577111
0.375	577113	577115	577117

Parting Information Guide

90° Mounting

It is very important that the insert is mounted at 90° to the center line of the workpiece in order to obtain perpendicular surfaces and reduce the risk of vibration.

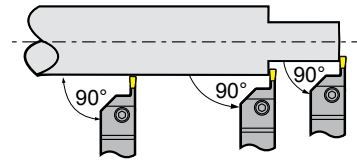

Correct Center Height Setting

Height tolerance between cutting edge of an insert and the center of the workpiece should be kept to $\pm 0.004''$, especially for the parting of rods and grooving of materials with small diameters. It also provides longer tool life and reduces cutting resistance and burrs.

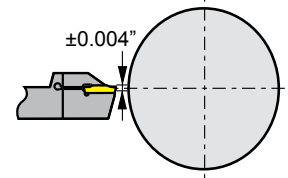

Parting

1. To minimize risk of vibration and deflection, always choose a toolholder with the smallest possible overhang.
2. When parting to center, reduce the feed rate by up to 75%, 0.08"-0.12" (2 mm-3 mm) prior to the part dropping off.

External Grooving, Turning & Profiling

MACHINING BETWEEN WALLS

To achieve the best results, the following sequence is recommended:

1. Plunge to required depth of cut (ap max 0.75 x insert width)
2. Pull back 0.004" radially
3. Turn longitudinally to opposite shoulder position
4. Retract at the end of the cut diagonally 0.020"
5. Feed axially to finish position
6. Plunge again to required depth of cut and retract radially 0.004"

Continue sequence for subsequent roughing passes. Axial turn in both directions to use both corners of the insert and to maximize tool life.

MACHINING INTO A RADIUS OR CHAMFER

To reduce vibration follow the machining sequence 1 to 4 above.

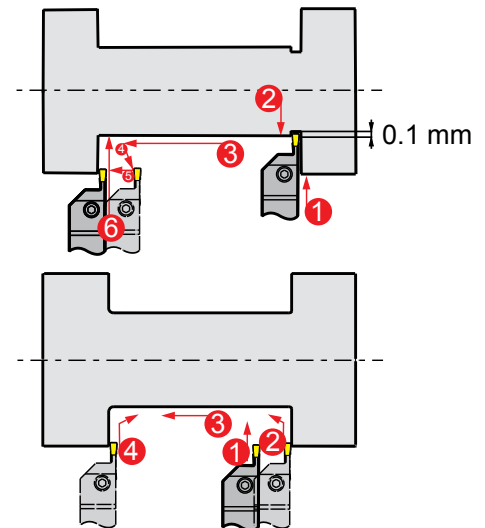

Internal Grooving & Turning

CUTTING AS SHOWN

The swarf will always flow in the same direction as the feed. It is therefore recommended to feed out towards the opening of the hole.

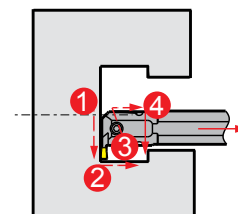

Threading & Anvil Sets



Threading sets are a versatile solution for those who cut a variety of thread types in limited quantity and do not want to sacrifice thread quality.

METRIC AND OTHER SIZES AVAILABLE UPON REQUEST

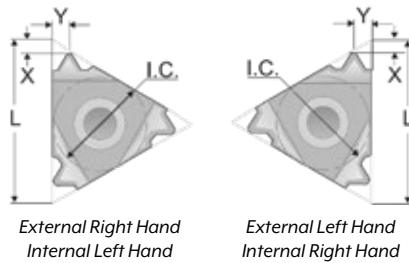

Anvil Set

Set Contents	
External UN Inserts	Internal UN Inserts
16ER A60 BMA	16IR A60 BMA
16ER G60 BMA	16IR G60 BMA
16ER AG60 BMA	16IR AG60 BMA
16ER 8UN BMA	16IR 8UN BMA
16ER 12UN BMA	16IR 12UN BMA
16ER 14UN BMA	16IR 14UN BMA
16ER 16UN BMA	16IR 16UN BMA
16ER 18UN BMA	16IR 18UN BMA
16ER 20UN BMA	16IR 20UN BMA
16ER 24UN BMA	16IR 24UN BMA
Tool Holder	
0.75 or 1.00" square	0.75 or 1.00" diameter

Sets

Conversion Sets & Anvil Set

Reference	Shank Size	External/Internal	Code
KEU	0.75" square	External	570001
KEU10	1.00" square	External	570002
KIU	0.75" diameter	Internal	570003
KIU10	1.00" diameter	Internal	570004

Reference	Description	Code
*KAE S16N	External Conversion Set	570220
*KAI S16N	Internal Conversion Set	570221
KA 16	Anvil Set	570222

*Sandvik Conversion Set: To convert your Sandvik tool holder to take Carmex inserts – 3/8 I.C.

Carbide Threading Insert Grades



Interchangeable with VARDEX, ISCAR, KENNAMETAL, SECO, *SANDVIK and many other laydown style threading inserts



CARBIDE INSERT GRADES:

- MXC** P10-P25 PVD TiN coated micrograin for free cutting untreated alloy steels (below 30 HRC), for stainless steels, cast iron and aluminum.
- K10-K20
- BMA** P20-P40 PVD TiAlN coated sub-micrograin grade for stainless steels and exotic materials at medium to high cutting speeds
- K20-K30
- P25C** P15-P35 PVD TiN coated grade for treated and hard alloy steels (25 HRC and up) at medium to low cutting speeds

Tool Holders & Accessories



Internal Tool Holders

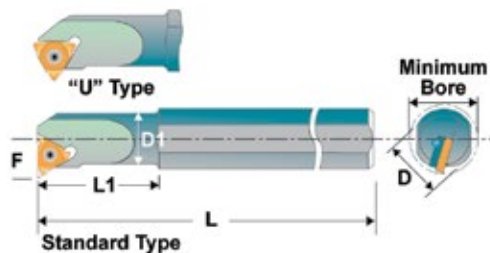

Style Right Hand	Insert I/C Reference Inch (mm)	D (Inch)	D1 (Inch)	L (Inch)	L1 (Inch)	Minimum Bore (Inch)	F (Inch)	Code
*SIR 0375 H11	0.250 (11)	0.38	0.38	4.0	-	0.47	0.28	570360
*SIR 0375 K11	0.250 (11)	0.62	0.38	5.0	1.00	0.47	0.28	570361
*SIR 0500 L11	0.250 (11)	0.62	0.50	5.5	1.25	0.58	0.34	570362
*SIR 0500 M16	0.375 (16)	0.62	0.50	6.0	1.25	0.64	0.39	570363
*SIR 0625 P16	0.375 (16)	0.75	0.62	7.0	1.57	0.75	0.45	570364
SIR 0750 P16	0.375 (16)	0.75	0.75	7.0	-	0.90	0.51	570365
SIR 1000 R16	0.375 (16)	1.00	1.00	8.0	-	1.16	0.65	570366
SIR 1250 S16	0.375 (16)	1.25	1.25	10.0	-	1.40	0.77	570367
SIR 1500 T16	0.375 (16)	1.50	1.50	12.0	-	1.65	0.90	570368
*SIR 0750 P22	0.500 (22)	0.75	0.75	7.0	-	0.90	0.59	570369
SIR 1000 R22	0.500 (22)	1.00	1.00	8.0	-	1.16	0.71	570370
SIR 1250 S22	0.500 (22)	1.25	1.25	10.0	-	1.50	0.85	570371
SIR 1500 T22	0.500 (22)	1.50	1.50	12.0	-	1.75	0.98	570372

External Tool Holders

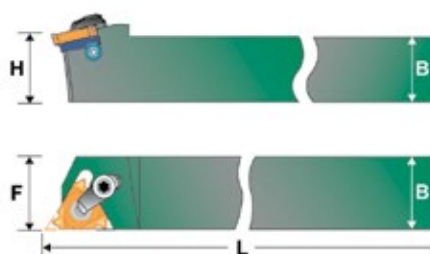

Style Right Hand	Insert I/C Reference Inch (mm)	B=H (Inch)	L (Inch)	F (Inch)	Code
*SER 0310 H11	0.250 (11)	0.31	4.00	0.43	570373
*SER 0375 H11	0.250 (11)	0.38	4.00	0.43	570374
SER 0375 D16	0.375 (16)	0.38	2.50	0.63	570375
SER 0500 F16	0.375 (16)	0.50	3.25	0.63	570376
SER 0625 H16	0.375 (16)	0.63	4.00	0.63	570377
SER 0750 K16	0.375 (16)	0.75	5.00	0.75	570378
SER 1000 M16	0.375 (16)	1.00	6.00	1.00	570379
SER 1250 P16	0.375 (16)	1.25	7.00	1.25	570380
SER 1000 M22	0.500 (22)	1.00	6.00	1.00	570381
SER 1250 P22	0.500 (22)	1.25	7.00	1.25	570382
SER 1500 R22	0.500 (22)	1.50	8.00	1.50	570383



NOTE: *TOOL HOLDERS WITHOUT SHIMS. All tool holders are made with 1.5° Helix angle. For other Helix angles, please inquire. Left hand tool holders also available.

Tool Holders & Accessories



Accessories

Type	External /Internal	Insert Size L I/C	Insert Screw		Torx® Key		Shim Screw	
								
			Style	Code	Style	Code	Style	Code
Threading	-	11 (0.250")	S11	570385	K11	549500	-	-
Threading	External Internal	16 (0.375")	S16	570386	K16	549501	A16	570388
Threading	External Internal	22 (0.500")	S22	570387	K22	570392	A22	570389
Grooving	External Internal	16 (0.375")	S16	570386	K16	549501	A16	570388

Type	External /Internal	Insert Size L I/C	Right Hand Shim		Left Hand Shim	
						
			Style	Code	Style	Code
Threading	External	16 (0.375")	AE16	570393	AI16	570394
Threading	Internal	16 (0.375")	AI16	570394	AE16	570393
Threading	External	22 (0.500")	AE22	570395	AI22	570396
Threading	Internal	22 (0.500")	AI22	570396	AE22	570395
Grooving	External	16 (0.375")	AE16-0	570397	AE16-0	570397

THREADING

Threading Inserts

Carbide – Partial Profile 60°

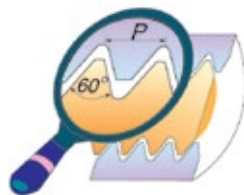

External



Internal



L mm I.C. (Inch)	Pitch TPI	External RH	Grade	Code	L mm I.C. (Inch)	Pitch TPI	Internal RH	Grade	Code
11 (1/4)	48-16	11 ER A60	BMA	578000	11 (1/4)	48-16	11 IR A60	BMA	578030
16 (3/8)	48-16	16 ER A60	BMA	578006	16 (3/8)	48-16	16 IR A60	BMA	578038
16 (3/8)	14-8	16 ER G60	BMA	578012	16 (3/8)	14-8	16 IR G60	BMA	578044
16 (3/8)	48-8	16 ER AG60	BMA	578018	16 (3/8)	48-8	16 IR AG60	BMA	578050
22 (1/2)	7-5	22 ER N60	BMA	578024	22 (1/2)	7-5	22 IR N60	BMA	578056

Type B

External and Internal Peripherally Ground with Sintered Chipbreaker

- These inserts combine sintered chipbreaker with precision ground profile. This combination ensures consistently high quality thread with precise shape and dimensions
- Two different unique styles of chipbreakers were designed. Both tailored to suit the different specific requirements of internal and external threading
- Type B inserts are made of grade BMA, a PVD TiAlN coated sub-micrograin carbide for alloy steels, stainless steels and exotic materials at medium to high cutting speeds

Advantages:

- High profile accuracy
- Unique chipbreaker that allows excellent performance
- Extends insert tool life

External Right Hand – Type B Inserts



Internal Right Hand – Type B Inserts



L mm I.C. (Inch)	Pitch TPI	Right Hand	Grade	Code	L mm I.C. (Inch)	Pitch TPI	Right Hand	Grade	Code
16 (3/8)	48 - 16	16 ER B A60	BMA	578062	16 (3/8)	48 - 16	16 IR B A60	BMA	578068
16 (3/8)	14 - 8	16 ER B G60	BMA	578064	16 (3/8)	14 - 8	16 IR B G60	BMA	578070
16 (3/8)	48 - 8	16 ER B AG60	BMA	578066	16 (3/8)	48 - 8	16 IR B AG60	BMA	578072

Threading Inserts



Carbide – Full Profile

UN, ISO Metric, NPT Pipe, Stub ACME & ACME

Other forms, multi tooth and left hand also available upon request

UN – Grade BMA

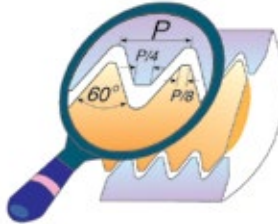

THREADING

L mm I.C. (Inch)	Pitch TPI	Right Hand	External Code	Internal Code	L mm I.C. (Inch)	Pitch TPI	Right Hand	External Code	Internal Code
11 (1/4)	72	11ER/11IR	578074	578314	16 (3/8)	40	16ER/16IR	578194	578434
11 (1/4)	64	11ER/11IR	578080	578320	16 (3/8)	36	16ER/16IR	578200	578440
11 (1/4)	56	11ER/11IR	578086	578326	16 (3/8)	32	16ER/16IR	578206	578446
11 (1/4)	48	11ER/11IR	578092	578332	16 (3/8)	28	16ER/16IR	578212	578452
11 (1/4)	44	11ER/11IR	578098	578338	16 (3/8)	27	16ER/16IR	578218	578458
11 (1/4)	40	11ER/11IR	578104	578344	16 (3/8)	24	16ER/16IR	578224	578464
11 (1/4)	36	11ER/11IR	578110	578350	16 (3/8)	20	16ER/16IR	578230	578470
11 (1/4)	32	11ER/11IR	578116	578356	16 (3/8)	18	16ER/16IR	578236	578476
11 (1/4)	28	11ER/11IR	578122	578362	16 (3/8)	16	16ER/16IR	578242	578482
11 (1/4)	27	11ER/11IR	578128	578368	16 (3/8)	14	16ER/16IR	578248	578488
11 (1/4)	24	11ER/11IR	578134	578374	16 (3/8)	13	16ER/16IR	578254	578494
11 (1/4)	20	11ER/11IR	578140	578380	16 (3/8)	12	16ER/16IR	578260	578500
11 (1/4)	18	11ER/11IR	578146	578386	16 (3/8)	11.5	16ER/16IR	578266	578506
11 (1/4)	16	11ER/11IR	578152	578392	16 (3/8)	11	16ER/16IR	578272	578512
11 (1/4)	14	11ER/11IR	578158	578398	16 (3/8)	10	16ER/16IR	578278	578518
16 (3/8)	72	16ER/16IR	578164	578404	16 (3/8)	9	16ER/16IR	578284	578524
16 (3/8)	64	16ER/16IR	578170	578410	16 (3/8)	8	16ER/16IR	578290	578530
16 (3/8)	56	16ER/16IR	578176	578416	22 (1/2)	7	22ER/22IR	578296	578536
16 (3/8)	48	16ER/16IR	578182	578422	22 (1/2)	6	22ER/22IR	578302	578542
16 (3/8)	44	16ER/16IR	578188	578428	22 (1/2)	5	22ER/22IR	578308	578548

ISO Metric – Grade BMA

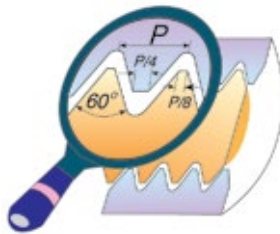

L mm I.C. (Inch)	Pitch mm	Right Hand	External Code	Internal Code	L mm I.C. (Inch)	Pitch mm	Right Hand	External Code	Internal Code
16 (3/8)	0.35	16ER/16IR	578558	578666	16 (3/8)	1.75	16ER/16IR	578618	578726
16 (3/8)	0.4	16ER/16IR	578564	578672	16 (3/8)	2.0	16ER/16IR	578624	578732
16 (3/8)	0.45	16ER/16IR	578570	578678	16 (3/8)	2.5	16ER/16IR	578630	578738
16 (3/8)	0.5	16ER/16IR	578576	578684	16 (3/8)	3.0	16ER/16IR	578636	578744
16 (3/8)	0.6	16ER/16IR	578582	578690	22 (1/2)	3.5	22ER/22IR	578642	578750
16 (3/8)	0.75	16ER/16IR	578588	578696	22 (1/2)	4.0	22ER/22IR	578648	578756
16 (3/8)	0.8	16ER/16IR	578594	578702	22 (1/2)	4.5	22ER/22IR	578654	578762
16 (3/8)	1.0	16ER/16IR	578600	578708	22 (1/2)	5.0	22ER/22IR	578660	578768
16 (3/8)	1.25	16ER/16IR	578606	578714					
16 (3/8)	1.5	16ER/16IR	578612	578720					

Threading Inserts

Carbide – Full Profile (continued)

UN, ISO Metric, NPT Pipe, Stub ACME & ACME

Other forms, multi tooth and left hand also available upon request

NPT Pipe – Grade BMA

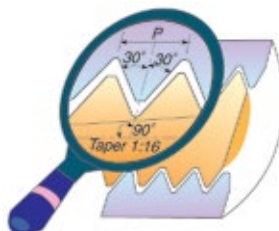

L mm I.C. (Inch)	Pitch TPI	Right Hand	External Code	Internal Code	L mm I.C. (Inch)	Pitch TPI	Right Hand	External Code	Internal Code
16 (3/8)	27	16ER/16IR	578774	578804	16 (3/8)	14	16ER/16IR	578786	578816
16 (3/8)	18	16ER/16IR	578780	578810	16 (3/8)	11.5	16ER/16IR	578792	578822
					16 (3/8)	8	16ER/16IR	578798	578828

Stub ACME – Grade BMA



L mm I.C. (Inch)	Pitch TPI	Right Hand	External Code	Internal Code	L mm I.C. (Inch)	Pitch TPI	Right Hand	External Code	Internal Code
11 (1/4)	16	11ER/11IR	578919	-	16 (3/8)	10	16ER/16IR	578936	578976
16 (3/8)	16	16ER/16IR	578918	-	16 (3/8)	8	16ER/16IR	578942	578982
16 (3/8)	14	16ER/16IR	578924	578964	16 (3/8)	6	16ER/16IR	578948	578988
16 (3/8)	12	16ER/16IR	578930	578970	22 (1/2)	5	22ER/22IR	578954	578994

ACME – Grade BMA

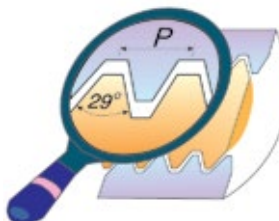

L mm I.C. (Inch)	Pitch TPI	Right Hand	External Code	Internal Code	L mm I.C. (Inch)	Pitch TPI	Right Hand	External Code	Internal Code
16 (3/8)	16	16ER/16IR	578834	578876	16 (3/8)	8	16ER/16IR	578858	578900
16 (3/8)	14	16ER/16IR	578840	578882	22(1/2)	6	22ER/22IR	578864	578906
16 (3/8)	12	16ER/16IR	578846	578888	22(1/2)	5	22ER/22IR	578870	578912
16 (3/8)	10	16ER/16IR	578852	578894					

Tool Holder Identification Guide

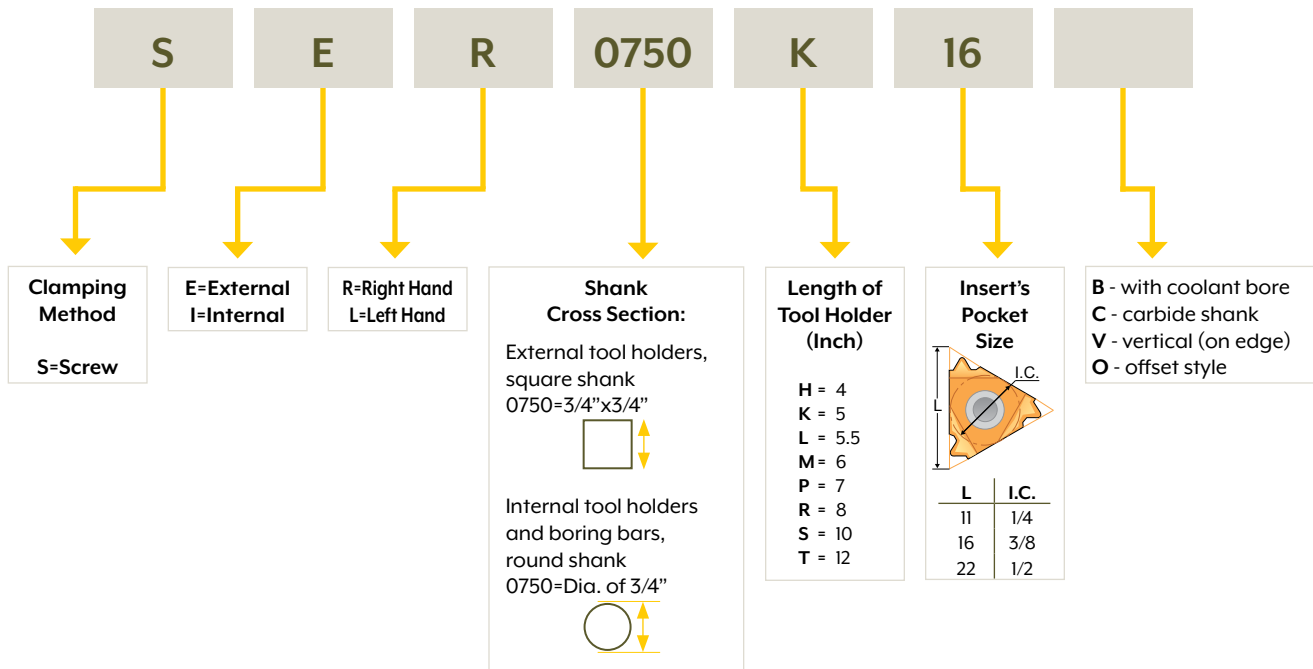

Recommended Cutting Speeds

Thread Turning Inserts				
ISO	Materials	Cutting Speed ft/min		
		MXC	BMA	P25C
P	Steel: low and medium carbon steels	330-590	295-520	260-520
	High carbon steels	260-520	260-490	260-390
	Alloy steels, treated steels	260-390	260-390	160-330
	Cast steel	390-520	330-460	260-460
M	Stainless steel: cast steels stainless austenitic and austenitic ferritic steel and cast steel	295-390	230-430	
K	Cast iron: grey cast iron, cast iron with spherical graphite, malleable cast iron	260-490	260-430	
N	Non-ferrous metal: aluminum and other non-ferrous metals, copper alloys non-metallic	980-1970	980-2620	
H	Hard materials: hardened steel, hardened cast iron materials, chilled cast iron	65-130	65-160	
S	Super-alloys and titanium: heat resistant special alloys based on iron, nickel and cobalt, titanium and titanium alloys	130-260	130-330	

Conversion of Cutting Speed to Rotational Speed

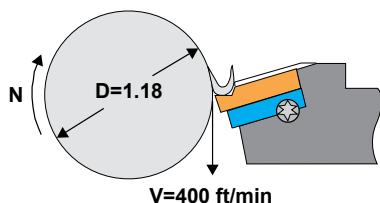

Conversion of selected cutting speed to rotational speed is calculated by the following formula:

$$N = \frac{V \times 12}{\pi \times D} = \frac{400 \times 12}{3.14 \times 1.18} = 1,294 \text{ RPM}$$

Milling Cutter Identification Guide

FMA01-100-B1.25-SE12-07L

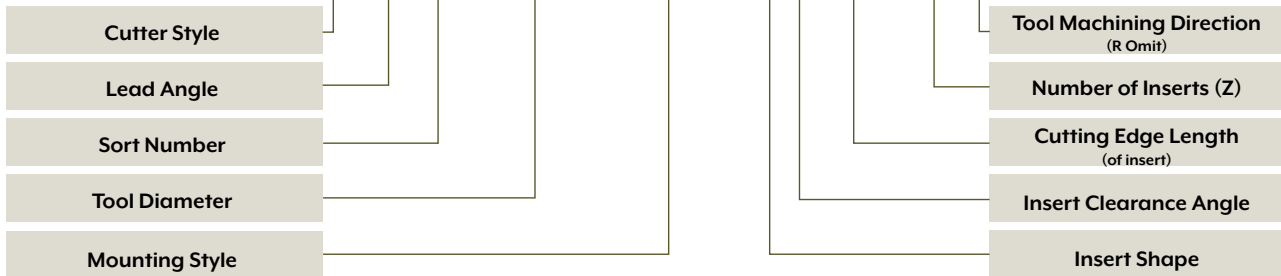

Cutter Style	
FM	Face Milling Tools
EM	Shoulder Face Milling Tools
HM	Helix End Milling Tools
SM	Side and Face Milling Tools
BM	Profile Milling Tools
CM	Chamfering End Milling Tools
XM	Special Milling Tools

Lead Angle		
P	90°	
E	75°	
D	60°	
A	45°	
R		

Insert Clearance Angle	
N	0°
B	5°
P	11°
D	15°
E	20°

Mounting Style			
Style	Structure	Style	Structure
A	Cutter $\phi 1.97$ (50) - $\phi 3.15$ (80)	B	Cutter $\phi 3.15$ (80) - $\phi 6.30$ (160)
C	Cutter $\phi 6.30$ (160) - $\phi 9.84$ (250)	D	Cutter $\geq \phi 12.40$ (315)
BT	BT	JT	JT
G	Cylindrical	XP	Weldon
MW	Morse		

Insert Shape					Cutting Edge Length of Insert				
A	L	R	S	T	A	L	R	S	T

MILLING

Face Mills



FMA01 Milling Cutters Lead Angle 45°

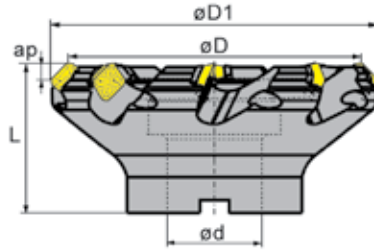
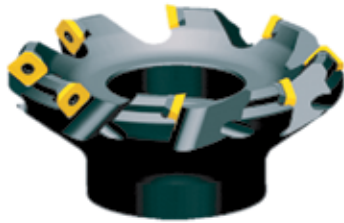

First choice for general purpose milling and mixed production

Type FMA01 Fine Pitch	ØD Inch (mm)	ØD1 Inch (mm)	Ød (Inch)	L (Inch)	ap Max. (Inch)	No. of Inserts	Insert Ref.	Code	Accessories			
									Shim Code	Shim Screw Code	Shim Key Code	Insert Screw Code
050-A0.75"-SE12-04	1.97 (50)	2.48 (63)	0.75	1.57	0.236	4	SEET12	574256	-	-	-	576304
063-A0.75"-SE12-05	2.48 (63)	2.99 (76)	0.75	1.57	0.236	5	SEET12	574258	-	-	-	576304
100-B1.25"-SE12-07	3.94 (100)	4.45 (113)	1.25	1.97	0.236	7	SEET12	574262	-	-	-	576304
125-B1.50"-SE12-08	4.92 (125)	5.43 (138)	1.50	2.48	0.236	8	SEET12	574264	576300	576302	576310	576306
160-C2.00"-SE12-10	6.30 (160)	6.81 (173)	2.00	2.48	0.236	10	SEET12	574266	576300	576302	576310	576306
200-C2.50"-SE12-12	7.87 (200)	8.38 (213)	2.50	2.48	0.236	12	SEET12	574268	576300	576302	576310	576306

FMA02 Milling Cutters Lead Angle 45°

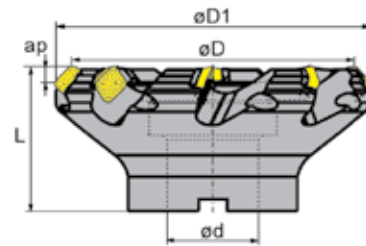
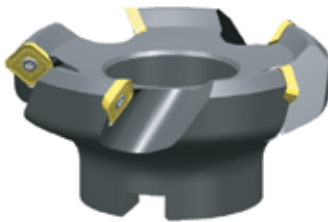

Reduced number of inserts with a differential pitch for best productivity when stability and power are limited (Long overhang/small machines)

Type FMA02 Differential Coarse Pitch	ØD Inch (mm)	ØD1 Inch (mm)	Ød (Inch)	L (Inch)	ap Max. (Inch)	No. of Inserts	Insert Reference	Code	Accessories
									Insert Screw Code
2.00"-A0.75"-SE12-04	2.00 (50.8)	2.51 (63.75)	0.75	1.50	0.236	4	SEET12	574270	576304
3.00"-A1.00"-SE12-04	3.00 (80)	3.51 (89.15)	1.00	2.00	0.236	5	SEET12	574274	576304
4.00"-B1.25"-SE12-05	4.00 (101.6)	4.51 (113)	1.25	2.00	0.236	7	SEET12	574276	576304

FMA04 Milling Cutters Lead Angle 45°

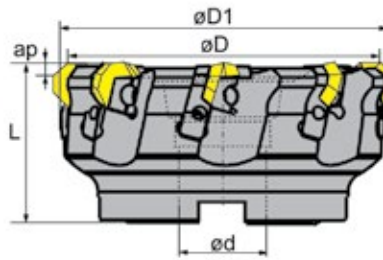

Type FMA04	ØD Inch (mm)	ØD1 Inch (mm)	Ød (Inch)	L (Inch)	ap Max. (Inch)	No. of Inserts	Insert Ref.	Code	Accessories					
									Locator Code	Locator Screw Code	Locator Key Code	Wedge Code	Wedge Screw Code	Wedge Key Code
125-B1.50"-OF07-08	4.92 (125)	5.34 (135.52)	1.50	2.48	0.200	8	OFMT07	574290	576324	576318	576316	576326	576322	576320
160-B2.00"-OF07-10	6.30 (160)	6.73 (171.11)	2.00	2.48	0.200	10	OFMT07	574292	576324	576318	576316	576326	576322	576320
200-C2.50"-OF07-12	7.87 (200)	8.31 (211.10)	2.50	2.48	0.200	12	OFMT07	574294	576324	576318	576316	576326	576322	576320



Face Mills

EMP02 Milling Cutters Lead Angle 90°

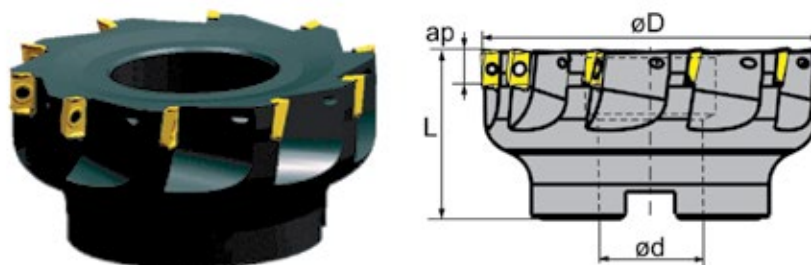

Type EMP02	ØD Inch (mm)	Ød (Inch)	L (Inch)	ap Max. (Inch)	No. of Inserts	Insert Reference	Code	Accessories
								Insert Screw Code
063-A1.00"-API1-08	2.48 (63)	1.00	1.57	0.43	8	APKT11/APKT16	574234	576356
080-A1.00"-API1-08	3.15 (80)	1.00	1.97	0.43	8	APKT11/APKT16	574236	576356
100-B1.25"-API1-10	3.94 (100)	1.25	1.97	0.43	10	APKT11/APKT16	574240	576356
050-A0.75"-API6-05	1.97 (50)	0.75	1.57	0.63	5	APKT11/APKT16	574230	576346
063-A1.00"-API6-06	2.48 (63)	1.00	1.57	0.63	6	APKT11/APKT16	574232	576346
080-A1.00"-API6-07	3.15 (80)	1.00	1.97	0.63	7	APKT11/APKT16	574238	576346
100-B1.25"-API6-08	3.94 (100)	1.25	1.97	0.63	8	APKT11/APKT16	574242	576346
125-B1.50"-API6-09	4.92 (150)	1.50	2.48	0.63	9	APKT11/APKT16	574244	576346

Face Mills



TP90SM Milling Cutters Lead Angle 90°

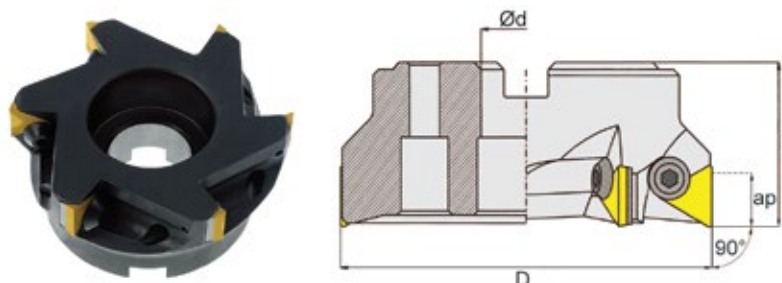

Type TP90SM	ØD (Inch)	Ød (Inch)	L (Inch)	ap Max. (Inch)	No. of Inserts	Insert Reference	Code	Accessories		
								Locator Screw Code	Shim Code	Shim Screw Code
1.5"-0.50"-0.37-03	1.50	0.50	1.58	0.375	3	TP_32	535712	535731	-	-
2.0"-0.75"-0.37-03	2.00	0.75	1.66	0.375	3	TP_32	535713	535731	-	-
2.5"-1.00"-0.50-03	2.50	1.00	1.85	0.500	3	TP_32	535714	535732	-	-
3.0"-1.00"-0.50-04	3.00	1.00	1.96	0.500	4	TP_43	535715	535732	535735	535736
4.0"-1.50"-0.50-05	4.00	1.50	1.96	0.500	5	TP_43	535716	535732	535735	535736
5.0"-1.50"-0.50-06	5.00	1.50	2.84	0.500	6	TP_43	535717	535732	535735	535736
6.0"-2.00"-0.50-07	6.00	2.00	2.84	0.500	7	TP_43	535718	535732	535735	535736

Face Mills



FMR01 Milling Cutters

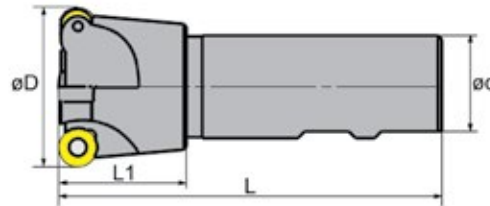

Type FMR01	$\varnothing D$ Inch (mm)	$\varnothing d$ (Inch)	L (Inch)	L1 (Inch)	ap Max. (Inch)	No. of Inserts	Insert Reference	Code	Accessories	
									Insert Screw Code	
1.00"-XP0.75"-RC10-02	1.00 (25.4)	0.75	4.75	1.50	0.196	2	RCMT	574302	576336	576336
1.25"-XP1.00"-RC10-02	1.25 (31.75)	1.00	4.75	1.50	0.196	2	RCMT	574306	576336	576336
1.50"-XP1.25"-RC12-03	1.50 (38.1)	1.25	4.75	1.50	0.236	3	RCMT	574304	576304	576304
2.00"-XP1.25"-RC12-03	2.00 (50.8)	1.25	4.75	1.50	0.236	3	RCMT	574308	576304	576304

FMR02 Milling Cutters

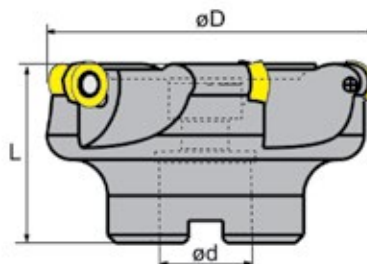

Type FMR02	$\varnothing D$ Inch (mm)	$\varnothing d$ (Inch)	L (Inch)	ap Max. (Inch)	No. of Inserts	Insert Reference	Code	Accessories	
								Insert Screw Code	
2.50"-A0.75"-RC12-04	2.50 (63.50)	0.75	1.97	0.236	4	RCMT	574310	576304	576304
3.00"-A1.00"-RC12-05	3.00 (76.20)	1.00	1.97	0.236	5	RCMT	574312	576304	576304
4.00"-B1.25"-RC12-06	4.00 (101.60)	1.25	2.48	0.236	6	RCMT	574314	576304	576304
5.00"-B1.50"-RC12-07	5.00 (127.00)	1.50	2.48	0.236	7	RCMT	574316	576304	576304
6.00"-C2.00"-RC12-08	6.00 (152.40)	2.00	2.48	0.236	8	RCMT	574318	576304	576304

FMR03 Milling Cutters

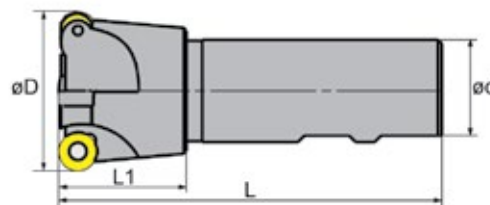

Type FMR03	$\varnothing D$ Inch (mm)	$\varnothing d$ (Inch)	L (Inch)	L1 (Inch)	ap Max. (Inch)	No. of Inserts	Insert Ref.	Code	Accessories	
									Insert Screw Code	Insert Key Code
1.00"-XP1.00"-RD08-02	1.00 (25.40)	1.00	4.00	1.50	0.157	2	RDMT	574320	576344	718407
1.25"-XP1.25"-RD10-02	1.25 (31.75)	1.25	4.75	1.50	0.197	2	RDMT	574324	576336	-
1.50"-XP1.25"-RD12-03	1.50 (38.10)	1.25	4.75	1.50	0.236	3	RDMT	574322	576336	-
2.00"-XP1.25"-RD12-04	2.00 (50.80)	1.25	4.75	1.50	0.236	4	RDMT	574326	576336	-



Face Mills

FMR04 Milling Cutters

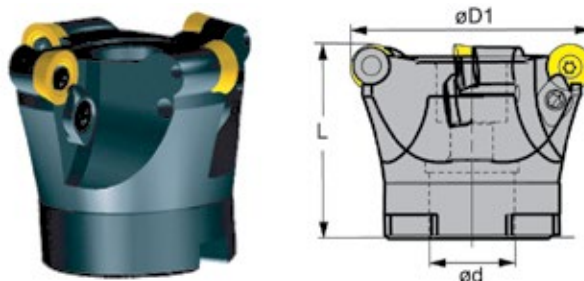

Type FMR04	ØD1 Inch (mm)	Ød (Inch)	L (Inch)	ap Max. (Inch)	No. of Inserts	Insert Ref.	Code	Accessories				
								Clamp Code	Clamp Screw Code	Clamp Key Code	Insert Screw Code	Insert Key Code
2.00"-A0.75"-RD12-03	2.00 (50.80)	0.75	1.77	0.236	3	RDMT	574328	576352	576354	718401	576350	-
2.50"-A0.75"-RD12-04	2.50 (63.50)	0.75	1.96	0.236	4	RDMT	574330	576352	576338	718401	576304	-
3.00"-A1.00"-RD16-05	3.00 (76.20)	1.00	1.96	0.315	5	RDMT	574332	-	-	-	576338	718401
4.00"-B1.25"-RD16-06	4.00 (101.60)	1.25	1.96	0.315	6	RDMT	574334	-	-	-	576338	718401
5.00"-B1.50"-RD20-06	5.00 (127.00)	1.50	2.48	0.394	6	RDMT	574336	-	-	-	576340	718401
6.00"-C2.00"-RD20-07	6.00 (152.40)	2.00	2.48	0.394	7	RDMT	574338	-	-	-	576340	718401

End Mills



EMP01 Milling Cutters Lead Angle 90° - Weldon & R8 Shanks

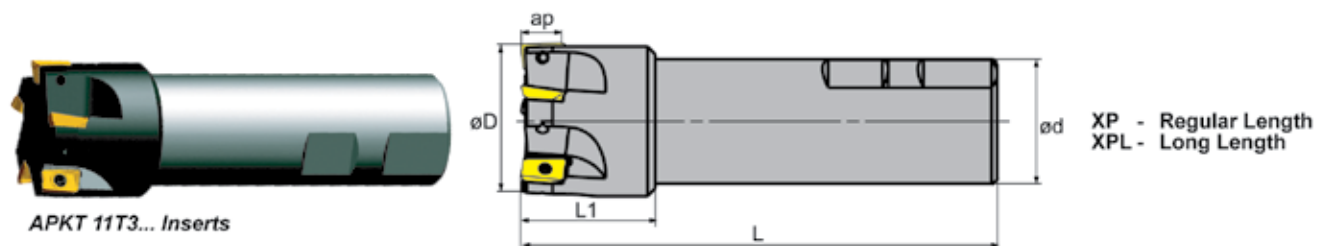

Type EMP01 APKT 11T3... Inserts	ØD Inch (mm)	Ød (Inch)	L (Inch)	L1 (Inch)	ap Max. (Inch)	No. of Inserts	Insert Reference	Code	Accessories
									Insert Screw Code
0.50"-XP0.62"-APII-01	0.50 (12.70)	0.625	3.50	1.00	0.400	1	APKT11/APKT16	574194	576356
0.75"-XPL0.75"-APII-02	0.75 (19.05)	0.750	6.50	1.18	0.400	2	APKT11/APKT16	574224	576356
1.00"-XPL1.00"-APII-03	1.00 (25.40)	1.000	6.50	1.38	0.400	3	APKT11/APKT16	574186	576356
1.00"-XPR8-APII-03	1.00 (25.40)	R8	5.50	1.38	0.400	3	APKT11/APKT16	574190	576356
1.25"-XPR8-APII-03	1.25 (31.75)	R8	5.50	1.75	0.400	3	APKT11/APKT16	574208	576356

End Mills



EMP01 Milling Cutters Lead Angle 90° - Weldon Shank

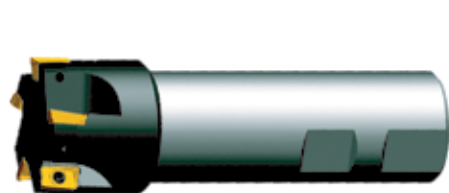

APKT 160408 Inserts

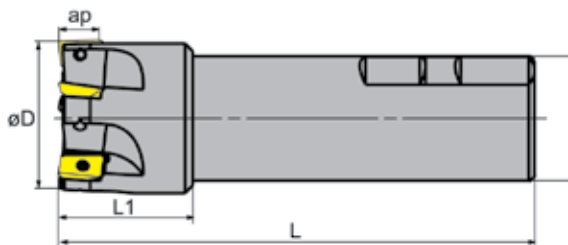

XP - Regular Length
XPL - Long Length
XPXL - Extra Long Length

Type EMP01 APKT 160408 Inserts	ØD Inch (mm)	Ød (Inch)	L (Inch)	L1 (Inch)	ap Max. (Inch)	No. of Inserts	Insert Reference	Code	Accessories
									Insert Screw Code
1.00"-XP0.75"-API6-02	1.00 (25.40)	0.750	4.00	1.38	0.600	2	APKT16	574184	576336
1.00"-XPL1.00"-API6-02	1.00 (25.40)	1.000	4.50	1.38	0.600	2	APKT16	574182	576336
1.00"-XPXL1.00"-API6-02	1.00 (25.40)	1.000	8.00	1.38	0.600	2	APKT16	574192	576336
1.25"-XP0.75"-API6-03	1.25 (31.75)	0.750	5.00	1.58	0.600	3	APKT16	574214	576336
1.25"-XPL1.25"-API6-03	1.25 (31.75)	1.250	5.00	1.57	0.600	3	APKT16	574204	576336
1.25"-XPXL1.25"-API6-03	1.25 (31.75)	1.250	6.50	1.57	0.600	3	APKT16	574206	576336
1.25"-XPXL1.25"-API6-03	1.25 (31.75)	1.250	8.50	1.58	0.600	3	APKT16	574210	576336
1.50"-XPL1.00"-API6-04	1.50 (38.10)	1.000	5.00	1.65	0.600	4	APKT16	574200	576336
1.50"-XPL1.25"-API6-04	1.50 (38.10)	1.250	5.00	1.65	0.600	4	APKT16	574198	576336
2.00"-XPL1.25"-API6-05	2.00 (50.80)	1.250	5.50	1.77	0.600	5	APKT16	574220	576336

MILLING

End Mills



TP90EM Milling Cutters Lead Angle 90° - Weldon Shank

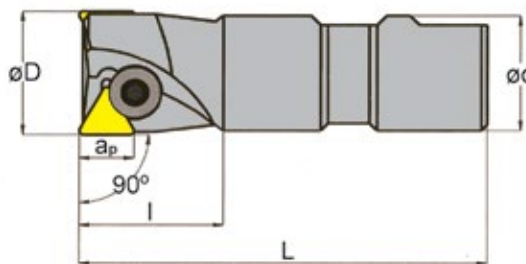

Type TP90EM Weldon Shank	ØD (Inch)	Ød (Inch)	L (Inch)	l (Inch)	ap Max. (Inch)	No. of Inserts	Insert Reference	Code	Accessories
									Clamp Screw Code
1.00"-0.75-0.18"-02	1.00	0.75	2.78	1.22	0.18	2	TPU22	535702	535730
1.25"-0.75-0.37"-02	1.25	0.75	3.25	1.22	0.37	2	TPU32	535703	535731
1.50"-0.75-0.37"-03	1.50	0.75	3.25	1.22	0.37	3	TPU32	535720	535733
2.00"-0.75-0.37"-03	2.00	0.75	3.25	1.22	0.37	3	TPU32	535722	535731
1.50"-1.00-0.37"-03	1.50	1.00	3.25	1.40	0.37	3	TPU32	535704	535733
2.00"-1.00-0.37"-03	2.00	1.00	3.25	1.40	0.37	3	TPU32	535706	535731

End Mills

TP90EM Milling Cutters Lead Angle 90° - R8 Shank

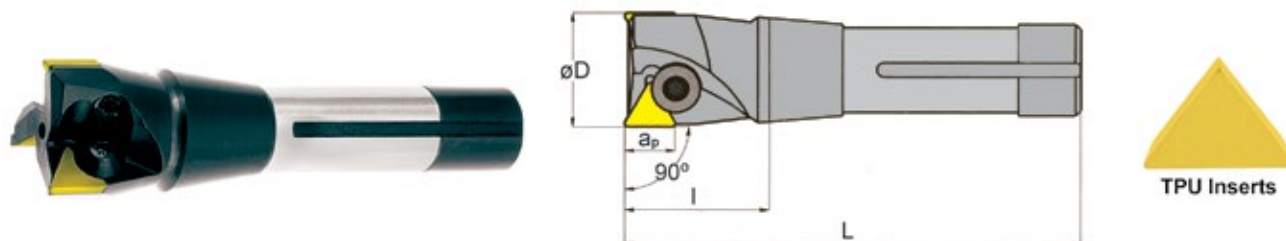

Type TP90EM R8 Shank	ØD (Inch)	Ød (Inch)	L (Inch)	l (Inch)	ap Max. (Inch)	No. of Inserts	Insert Reference	Code	Accessories	
									Clamp Screw Code	
1.00"-R8-0.18"-02	1.00	R8	3.48	1.33	0.18	2	TPU22	535726		535730
1.00"-R8-0.18"-02	1.25	R8	3.69	1.52	0.37	2	TPU32	535727		535730
1.50"-R8-0.37"-03	1.50	R8	3.69	1.52	0.37	3	TPU32	535705		535733
1.75"-R8-0.37"-03	1.75	R8	3.69	1.52	0.37	3	TPU32	535728		535731
2.00"-R8-0.37"-03	2.00	R8	3.69	1.52	0.37	3	TPU32	535707		535731
2.50"-R8-0.37"-04	2.50	R8	3.69	1.52	0.37	4	TPU32	535709		535731
3.00"-R8-0.37"-05	3.00	R8	3.69	1.52	0.37	5	TPU32	535711		535731

Milling Cutter Sets – 3 Pieces – Lead Angle 90°



R8 set shown

Type TP90EM (Inch)	Shank Diameter (Inch)	Cutting Diameters (Inch)	Code
0.75 Set	0.75	1.25, 1.50, 2.00	535771
1.25-2.00 Set	R8	1.25, 1.50, 2.00	535773
2.00-3.00 Set	R8	2.00, 2.50, 3.00	535774

These end mills take TPU inserts

Chamfer Tools

CMA01 Chamfer Cutters Lead Angle 45° - Weldon Shank

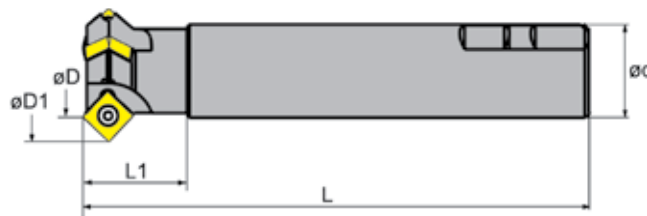

Type CMA01	ØD Inch (mm)	ØD1 Inch (mm)	Ød (Inch)	L (Inch)	L1 (Inch)	No. of Inserts	Insert Reference	Code	Accessories	
									Insert Screw Insert	Torx® Key Code
0.50"-XP0.75"-SPI2-01	0.50 (12.7)	1.206 (30.60)	0.75	4.00	1.57	1	SPMT	573444	576360	718401
1.00"-XPI.00"-SPI2-02	1.00 (25.4)	1.706 (43.33)	1.00	5.00	1.57	2	SPMT	573448	576360	718401
1.25"-XPI.00"-SPI2-03	1.25 (31.75)	1.956 (49.68)	1.25	7.00	1.57	3	SPMT	573446	576360	718401

Chamfer Tools

Indexable Countersinks & Chamfer Cutters – Positive Rake – 60°, 82°, 90° & 100°

- Uncoated C5 carbide insert and Torx® wrench included with each tool
- Positive rake for smooth cutting without chatter
- Carbide indexable - no tool resharping needed
- Uses standard triangular and square inserts



"S" Style For 0.500 (12.75) to 2.50 (63.50) diameters, using SPGH insert



"T" Style For 0.125 (3.18) to 0.750 (19.05) diameters, using TPGH insert

Individual Chamfer Cutters

Angle	Chamfer Range Minimum Inch (mm)	Chamfer Range Maximum Inch (mm)	Shank Diameter (Inch)	Insert Reference	Code
60°	0.125 (3.18)	0.500 (12.70)	0.375	TPGH2151	577401
60°	0.250 (6.35)	0.750 (19.05)	0.500	TPGH321	577415
60°	0.500 (12.70)	1.750 (44.45)	0.500	SPGH433	577417
60°	1.250 (31.75)	2.500 (63.50)	0.750	SPGH433	577419
82°	0.125 (3.18)	0.500 (12.70)	0.375	TPGH2151	577403
82°	0.250 (6.35)	0.750 (19.05)	0.500	TPGH321	577421
82°	0.500 (12.70)	1.750 (44.45)	0.500	SPGH433	577423
82°	1.250 (31.75)	2.500 (63.50)	0.750	SPGH433	577425
90°	0.125 (3.18)	0.500 (12.70)	0.375	TPGH2151	577405
90°	0.250 (6.35)	0.750 (19.05)	0.500	TPGH321	577427
90°	0.500 (12.70)	1.750 (44.45)	0.500	SPGH433	577429
90°	1.250 (31.75)	2.500 (63.50)	0.750	SPGH433	577431

3 Piece Sets



4 Piece Set



Angle	Contents of Set	Code
82°	One of each: 0.25", 0.50", and 1.25" (min.)	577447
90°	One of each: 0.25", 0.50", and 1.25" (min.)	577449

Contents of Set	Code
One of each: 1/8" (min.) 60°, 82°, 90°, 100°	577453

Also included: Inserts, Torx® wrench, wooden block

Carbide Inserts



TPGH



SPGH

Type	Grade/ Coating	Ø.I.C. (Inch)	Radius (Inch)	Code
SPGH433	C5	0.500	0.047	577439
TPGH321	TiN	0.375	0.016	577437
SPGH433	TiN	0.500	0.047	577441

Chamfer Tools

Indexable Insert Chamfer Cutters - Weldon Shank

- Versatile tool that can be used for countersinking, chamfer milling and face milling
- Extra length of cut with parallelogram inserts
- All holders use the same insert – APLT-347-CV6
- Sets include three holders, 10 coated inserts and a wrench

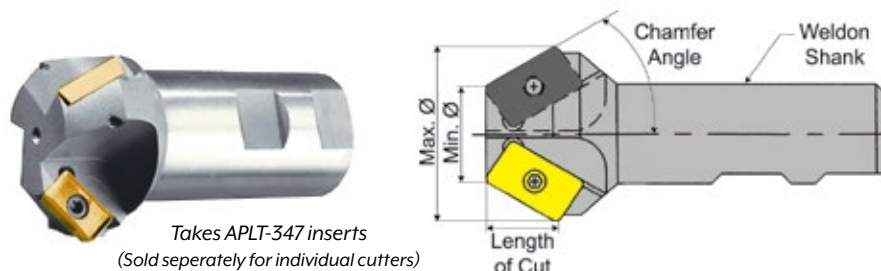

Takes APLT-347 inserts
(Sold separately for individual cutters)

Individual Chamfer Cutters

Chamfer Angle	Minimum Diameter (Inch)	Maximum Diameter (Inch)	Shank Diameter (Inch)	No. of Flutes	Length of Cut (Inch)	Insert Reference	Code
30°	0.750	1.303	3/4	2	0.479	APLT-347	543001
41°	0.688	1.414	3/4	2	0.418		543002
45°	0.688	1.471	3/4	2	0.391		543003
60°	0.500	1.458	3/4	2	0.277		543004
30°	1.000	1.553	1	3	0.479		543010
41°	0.938	1.664	1	3	0.418		543011
45°	0.938	1.721	1	3	0.391		543012
60°	0.750	1.708	1	3	0.277		543013
30°	1.250	1.803	1-1/4	3	0.479		543020
41°	1.188	1.914	1-1/4	3	0.418		543021
45°	1.188	1.971	1-1/4	3	0.391		543022
60°	1.000	1.958	1-1/4	3	0.277		543023
30°	1.500	2.053	1-1/2	3	0.479		543030
41°	1.438	2.164	1-1/2	3	0.418		543031
45°	1.438	2.221	1-1/2	3	0.391		543032
60°	1.250	2.208	1-1/2	3	0.277		543033

Replacement Insert



Type	Grade	Length (Inch)	I.C. (Inch)	Thickness (Inch)	Ø Hole (Inch)	Radius (Inch)	Code
APLT-347	CV6	0.591	0.375	0.187	0.173	0.015	543048

3 Piece Sets



Sets include:
3 holders
10 APLT-347 inserts
1 wrench

Chamfer Angle	Minimum Diameter (Inch)	Maximum Diameter (Inch)	Shank Diameter (Inch)	No. of Flutes	Code
30°	0.750	1.303	0.750	2	543040
CHM-30	1.000	1.553	1.000	3	
(60° Included angle)	1.250	1.803	1.250	3	
41°	0.688	1.414	0.750	2	543042
CHM-41	0.938	1.664	1.000	3	
(82° Included angle)	1.188	1.914	1.250	3	
45°	0.688	1.471	0.750	2	543045
CHM-45	0.938	1.721	1.000	3	
(90° Included angle)	1.188	1.971	1.250	3	
60°	0.500	1.458	0.750	2	543047
CHM-60	0.750	1.708	1.000	3	
(120° Included angle)	1.000	1.958	1.250	3	

Replacement Screw

Code
576336

Milling Inserts ANSI vs. ISO Identification Guide



Insert Shape		Insert Type		Insert I.C. Size	Insert Thickness
A	C	A	B	<p>(I.C.) shown in 1/32" increments on inserts less than 1/4" I.C.</p> <p>(I.C.) shown in 1/8" increments on inserts 1/4" and over</p> <p>5 = 5/32 5 = 5/8 2 = 1/4 6 = 3/4 3 = 3/8 8 = 1 4 = 1/2</p>	<p>(T) shown in 1/32" increments on inserts less than 1/4" I.C.</p> <p>(T) shown in 1/16" increments on inserts 1/4" and over</p> <p>2 = 1/16 3 = 3/16 (1.5) = 3/32 4 = 1/4 2 = 1/8 5 = 5/16 (2.5) = 5/32 6 = 3/8</p>
O	R	F	G		
S	T	H	M		
		N	R		
		T	W		

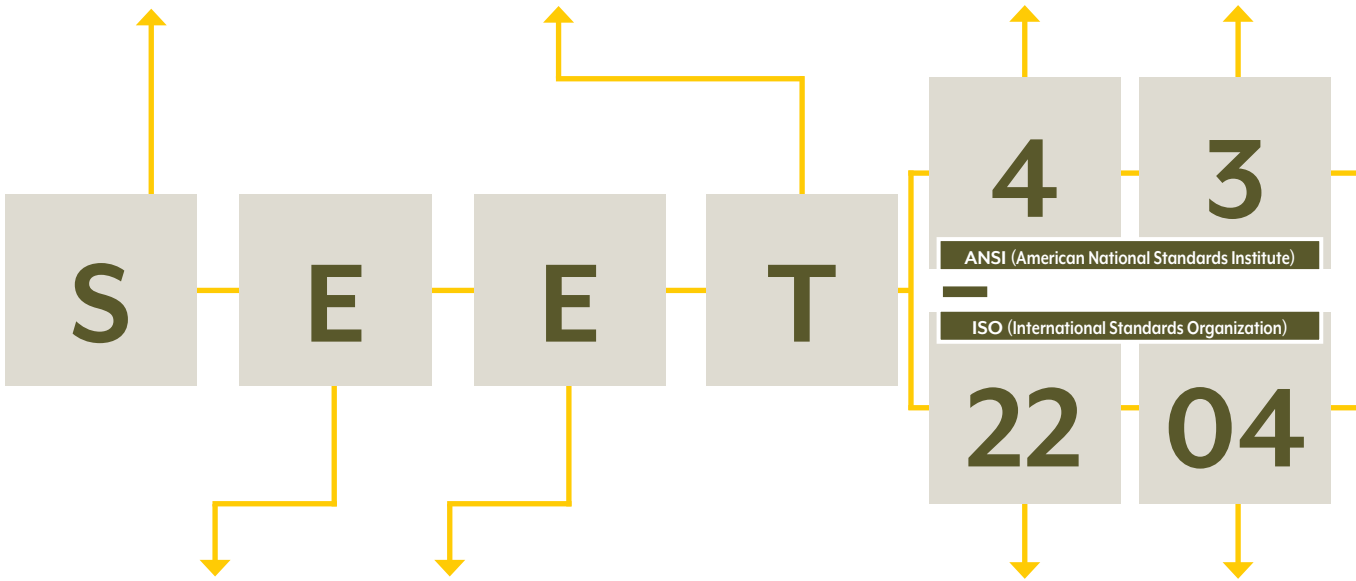

Insert Clearance Angle	
A	B
C	D
E	F
G	N
P	

Insert Tolerance		
I.C.	M	T
S	S	M
	I.C.	I.C.
A = 0.0010	0.0002	0.0010
C = 0.0010	0.0005	0.0010
E = 0.0010	0.0010	0.0010
F = 0.0005	0.0002	0.0010
G = 0.0010	0.0010	0.0050
H = 0.0005	0.0005	0.0001
J = 0.002-0.006	0.0002	0.0010
K = 0.002-0.006	0.0005	0.0010
L = 0.002-0.006	0.0010	0.0010
M = 0.002-0.006	0.003-0.008	0.0050
N = 0.002-0.006	0.003-0.008	0.0010
U = 0.003-0.010	0.005-0.015	0.0050

Exact tolerance is determined by the shape and size of the insert

Insert Cutting Edge Length		Cutting Edge Length by Shape (mm)							
I.C.		Designated using insert shape symbol							
mm	Inch	C	D	O	R	S	T	V	W
3.97	5/32	-	-	-	-	06	-	-	-
6.35	1/4	06	07	-	-	11	11	04	-
9.53	3/8	09	11	-	09	09	16	16	06
12.70	1/2	12	15	05	12	12	22	22	08
15.88	5/8	16	19	-	15	15	27	-	-
19.05	3/4	-	-	-	19	19	33	-	-
25.40	1	-	-	-	-	25	-	-	-

Insert Thickness	
	(T) shown in 1 mm increments, single integers are to be preceded by a "0"
01 = 1.59	1/16
T1 = 1.98	5/64
02 = 2.38	3/32
03 = 3.18	1/8
T3 = 3.97	5/32
04 = 4.76	3/16
06 = 6.34	1/4
07 = 7.94	5/16
09 = 9.52	3/8

Milling Inserts ANSI vs. ISO Identification Guide

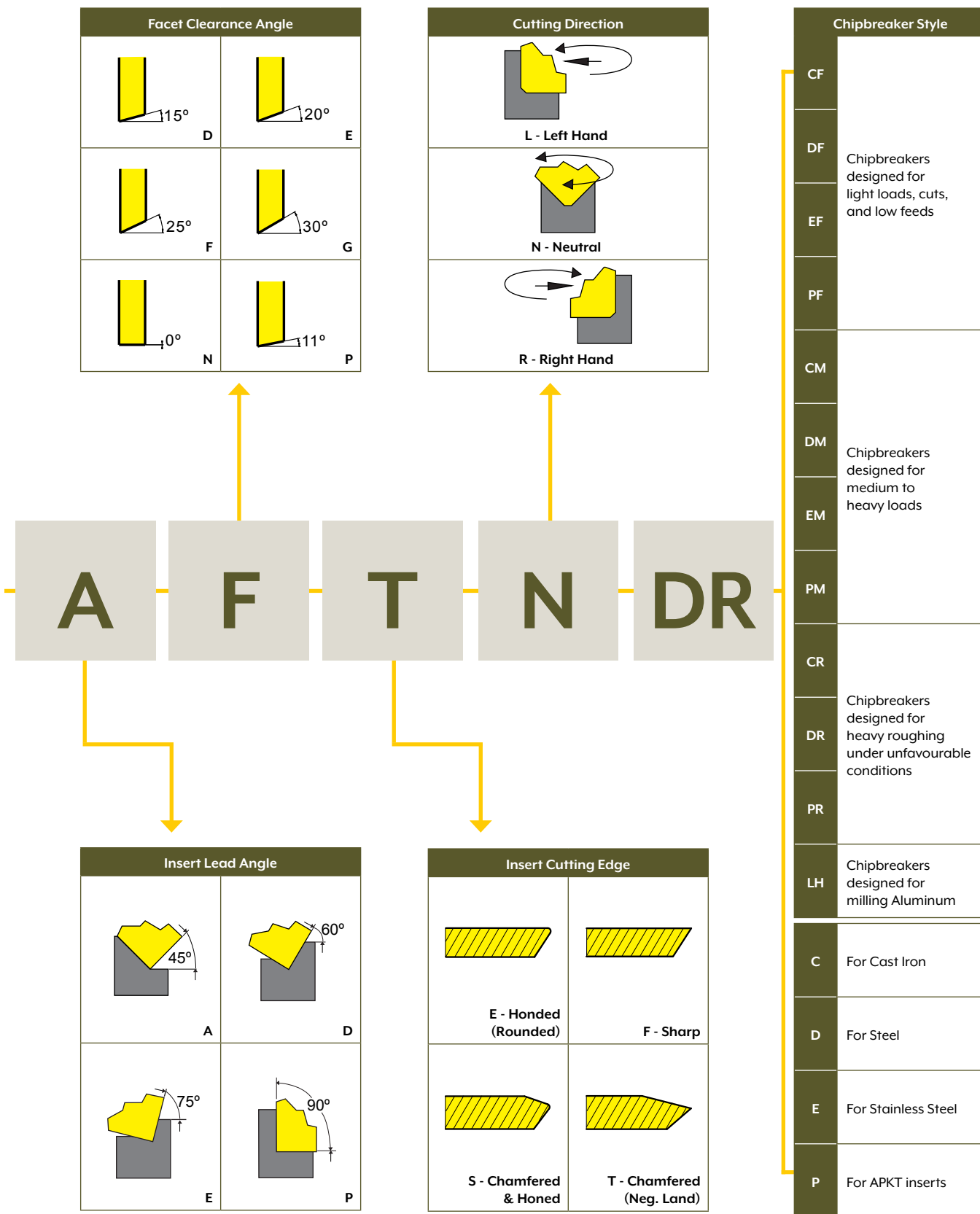

MILLING

Milling Inserts Main Grades & Applications



YBC301
CVD COATED

P10-P40
M15-M35

A combination of TiCN, thin layer of Al₂O₃, and a TiN coating on a substrate with high strength is suitable for light to heavy milling (both wet and dry) in unalloyed and low alloyed steels with hardness up to 300 HB at medium to high speeds. Also for martensitic stainless steels.

YBM251
CVD COATED

P10-P20
M10-M20

An optimal combination of TiCN, thin layers of Al₂O₃, and a TiN coating on a substrate provides a cutting edge with superior strength and toughness. It is a premium grade for semi-finishing to light roughing of stainless steel at continuous and intermittent machining conditions.

YBM351
CVD COATED

M20-M40
S25-S40

A combination of TiN and TiAlN coated carbide provides this grade with good strength and impact resistance. It is well suited in medium to rough milling stainless steel, heat resistant alloys and low carbon steel at low speeds.

YD201
UNCOATED

K15-K30
N10-N20
S15-S25

Uncoated carbide grade with good wear resistance and toughness for light to medium milling at moderate cutting speeds. Ideal choice for milling of ferritic nodular cast iron. Works well in non-metallic materials such as plastic, wood, etc. Ideal in the aerospace industry on aluminum with sharp edged inserts. Capable of wet or dry machining.

Milling Inserts Chipbreaker Identification Guide

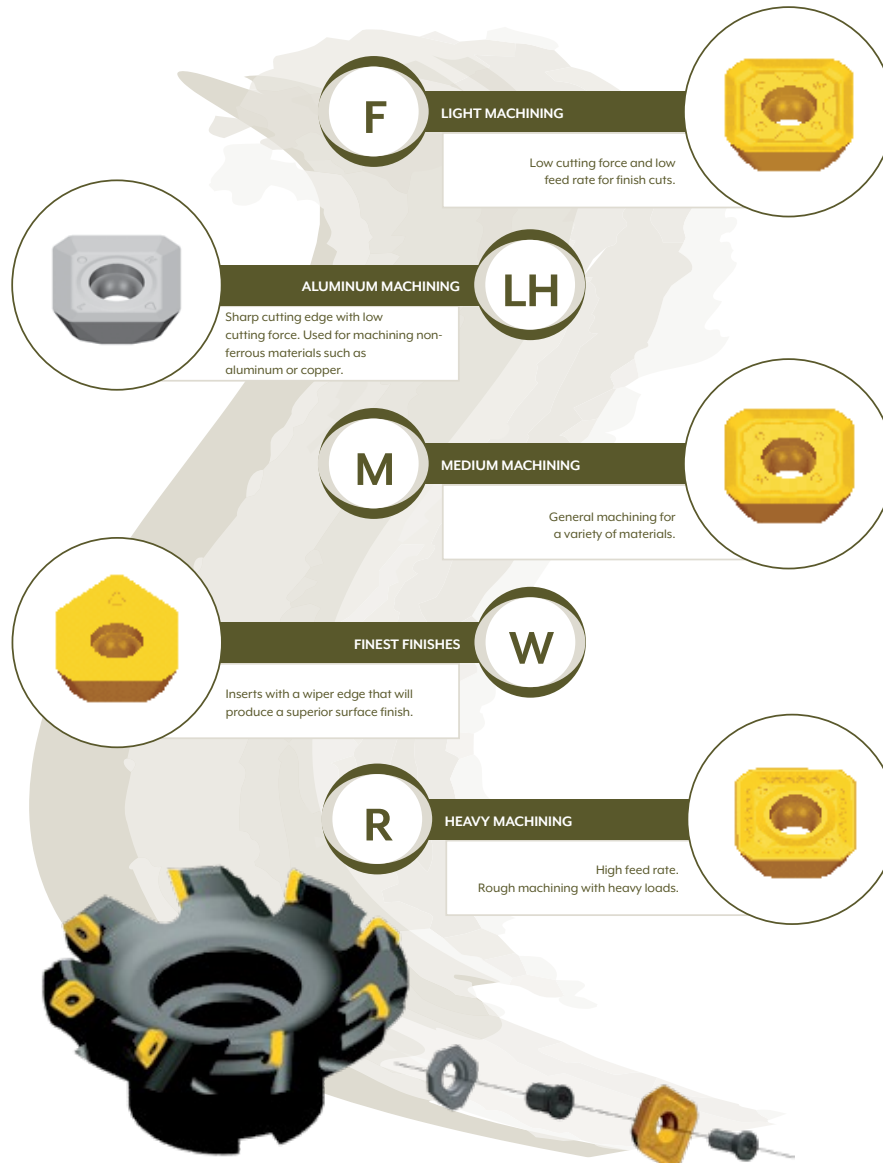

Milling Inserts



APKT



Type	Grade	Length (Inch)	Width (Inch)	Thickness (Inch)	Ø Hole (Inch)	Radius (Inch)	Code
APKTIIT304PM	YBC301	0.482	0.256	0.142	0.262	0.016	573008
APKTIIT308PF	YBM251	0.482	0.256	0.142	0.262	0.031	573035
APKTIIT308PM	YBM251	0.482	0.256	0.142	0.262	0.031	573028
APKT160408PF	YBC301	0.704	0.367	0.226	0.173	0.031	573040
APKT160408PF	YBM251	0.704	0.367	0.226	0.173	0.031	573044
APKT160408PM	YBM251	0.704	0.367	0.226	0.173	0.031	573054

OFKR



Type	Grade	Length (Inch)	Ø.I.C. (Inch)	Thickness (Inch)	Radius (Inch)	Code
OFKR0704DM	YBM251	0.293	0.706	0.187	0.031	574348
OFKR0704DM	YBM351	0.293	0.706	0.187	0.031	574350

RCKT & RDKW



Type	Grade	Ø.I.C. (Inch)	Thickness (Inch)	Ø Hole (Inch)	Code
RCKTI204M0DM	YBM251	0.472	0.187	0.157	574456
RCKTI204M0DM	YBM351	0.472	0.187	0.157	574458
RDKW0803M0	YBC301	0.315	0.125	0.134	574512
RDKWI0T3M0	YBC301	0.394	0.156	0.173	574518

SEET, SEKN & SPKN



Type	Grade	Ø.I.C. (Inch)	Width (Inch)	Thickness (Inch)	Code
SEETI2T3DM	YBM251	0.527	0.527	0.156	574678
SEETI2T3LH	YD201	0.527	0.527	0.156	574692
SEKNI203AFN	YBC301	0.500	0.500	0.125	574696
SEKNI203AFTN	YBC301	0.500	0.500	0.125	574710
SEKNI203AFTN	YBM251	0.500	0.500	0.125	574714
SPKNI203EDR	YBC301	0.500	0.500	0.125	574982

TPU



Type	Grade	Ø.I.C. (Inch)	Width (Inch)	Thickness (Inch)	Radius (Inch)	Code
TPU322	YBM251	0.375	0.650	0.125	0.031	576186
TPU322	YC30S	0.375	0.650	0.125	0.031	576184
TPU323	YC30S	0.375	0.650	0.125	0.047	576188
TPU432	YBM251	0.500	0.866	0.187	0.031	576194
TPU432	YC30S	0.500	0.866	0.187	0.031	576192
TPU433	YC30S	0.500	0.866	0.187	0.047	576196

All YBC251 and YC30S inserts have 0.002" hone

Milling Inserts Identification Guide



1

2

3

4

1
Insert Shape

A	B	C	D	E	H	K	L
						Special	
O	P	R	S	T	W	X	

2
Clearance Angle

	5°	7°	15°	20°	25°	30°	0°	11°
	B	C	D	E	F	G	N	P

3
Tolerance

	Tolerance			I.C. Size						
	m	t	I.C.	.250	.375	.500	.625	.750	1	
A	±.0002	±.0001	±.0001	•	•	•	•	•	•	
C	±.0005	±.0010	±.0010	•	•	•	•	•	•	
E	±.0010	±.0010	±.0010	•	•	•	•	•	•	
F	±.0020	±.0010	±.0010	•	•	•	•	•	•	
G	±.0010	±.0005	±.0010	•	•	•	•	•	•	
H	±.0005	±.0010	±.0010	•	•	•	•	•	•	
K	±.0005	±.0010	±.0020	•	•					
			±.0030			•				
			±.0040					•	•	
			±.0050							•
M	±.0050	±.0050	±.0020	•	•					
			±.0030			•				
			±.0040					•	•	
			±.0050							•

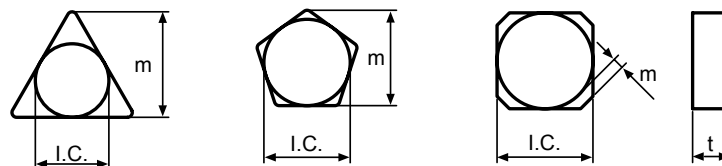

4
Cross Section Shape

								Special
A	F	G	M	N	R	T	W	X



Milling Inserts Identification Guide



5 6 7 8 9 10

5
Cutting
Edge
Length

I.C. Size	Symbol	C	S	R	T	H	O
Inch		Metric					
7/32	1.8(7)	05	05	05	09		
1/4	2	06	06	06	11		
5/16	2.5	08	07	07	13		
3/8	3	09	09	09	16		
1/2	4	12	12	12	22	05	05
5/8	5	16	15	15	27	09	06
3/4	6	19	19	19	33	10	
1	8	25	25	25	44		

*() symbol for small size insert

6
Thickness

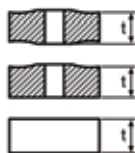

Symbol(t)	Inch
1.5(3)	3/32
2	1/8
2.5	5/32
3	3/16
4	1/4
5	5/16
6	3/8

7
Lead Angle &
Relief Angle
of Minor Cutting
Edge

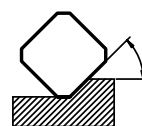

Lead Angle	
A	45°
D	60°
E	75°
F	85°
P	90°
Z	Special

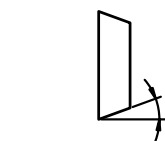

Relief Angle of minor cutting edge	
B	5°
C	7°
D	15°
E	20°
F	25°
G	30°
N	0°
P	11°
Z	Special

8
Edge
Preparation

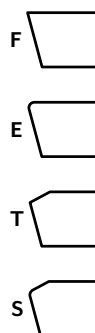

9
Cutting
Direction

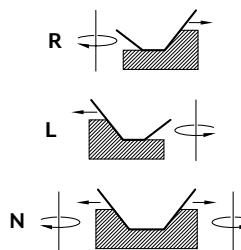

10
Chip Breaker

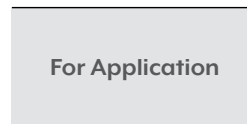

Milling Inserts



APKT & APMT



Type	Grade	Ø.I.C. (Inch)	Width (Inch)	Thickness (Inch)	Radius (Inch)	Code
APKT100305PDTR	YG602	0.525	0.264	0.143	0.020	577570
APKT100308PDTR	YG602	0.525	0.264	0.143	0.031	577571
APKT160404PDTR	YG602	0.672	0.370	0.207	0.016	577572
APKT160408PDTR	YG602	0.672	0.370	0.207	0.031	577573
APKT160412PDTR	YG602	0.672	0.370	0.207	0.472	577574
APKT160416PDTR	YG602	0.672	0.370	0.207	0.063	577575
APMT113504PDTR	YG602	0.440	0.244	0.138	0.157	577576
APMT113508PDTR	YG602	0.440	0.244	0.138	0.031	577577
APMT160408PDTR	YG602	0.670	0.363	0.187	0.031	577578

ODMT, ODMW & OFMT



Type	Grade	Ø.I.C. (Inch)	Width (Inch)	Thickness (Inch)	Radius (Inch)	Code
ODMT060508	YG602	-	0.626	0.217	-	577579
ODMW060508	YG602	-	0.626	0.217	-	577580
OFMT05T305TN	YG602	-	0.500	0.157	-	577581

RDKT, RDKW, RPMT & RPMW



Type	Grade	Ø.I.C. (Inch)	Width (Inch)	Thickness (Inch)	Radius (Inch)	Code
RDKT0802M0	YG602	-	0.315	0.094	-	577582
RDKT10T3M0	YG602	-	0.394	0.156	-	577583
RDKT1204M0	YG602	-	0.472	0.187	-	577584
RDKW0802M0	YG602	-	0.315	0.094	-	577585
RDKW10T3M0	YG602	-	0.394	0.156	-	577586
RDKW1204M0	YG602	-	0.472	0.187	-	577587
RPMT08T2M0	YG602	-	0.315	0.109	-	577588
RPMT10T3M0	YG602	-	0.394	0.156	-	577589
RPMT1204M0	YG602	-	0.472	0.187	-	577590
RPMW1204M0	YG602	-	0.472	0.187	-	577591

SDKN, SEKN, SEKR, SEKT. SPKN & SPKR



Type	Grade	Ø.I.C. (Inch)	Width (Inch)	Thickness (Inch)	Radius (Inch)	Code
SDKN42AETN	YG602	-	0.500	0.125	-	577592
SDKN56AETN	YG602	-	0.625	0.187	-	577593
SEKN42AFTN	YG602	-	0.500	0.125	-	577594
SEKR42AFTN	YG602	-	0.500	0.125	-	577595
SEKT1204AFTN	YG602	-	0.509	0.199	-	577596
SEKT12T3AGTN	YG602	-	0.528	0.157	-	577597
SPKN42EDTR	YG602	-	0.500	0.125	-	577598
SPKN53EDTR	YG602	-	0.625	0.187	-	577599
SPKR42EDTR	YG602	-	0.500	0.125	-	577600

TPKN & TPKR



Type	Grade	Ø.I.C. (Inch)	Width (Inch)	Thickness (Inch)	Radius (Inch)	Code
TPKN32PDTR	YG602	0.568	0.375	0.125	-	577601
TPKN43PDTR	YG602	0.789	0.500	0.187	-	577602
TPKR32PDTR	YG602	0.569	0.375	0.125	-	577603
TPKR43PDTR	YG602	0.789	0.500	0.187	-	577604

Thread Milling Identification Guide

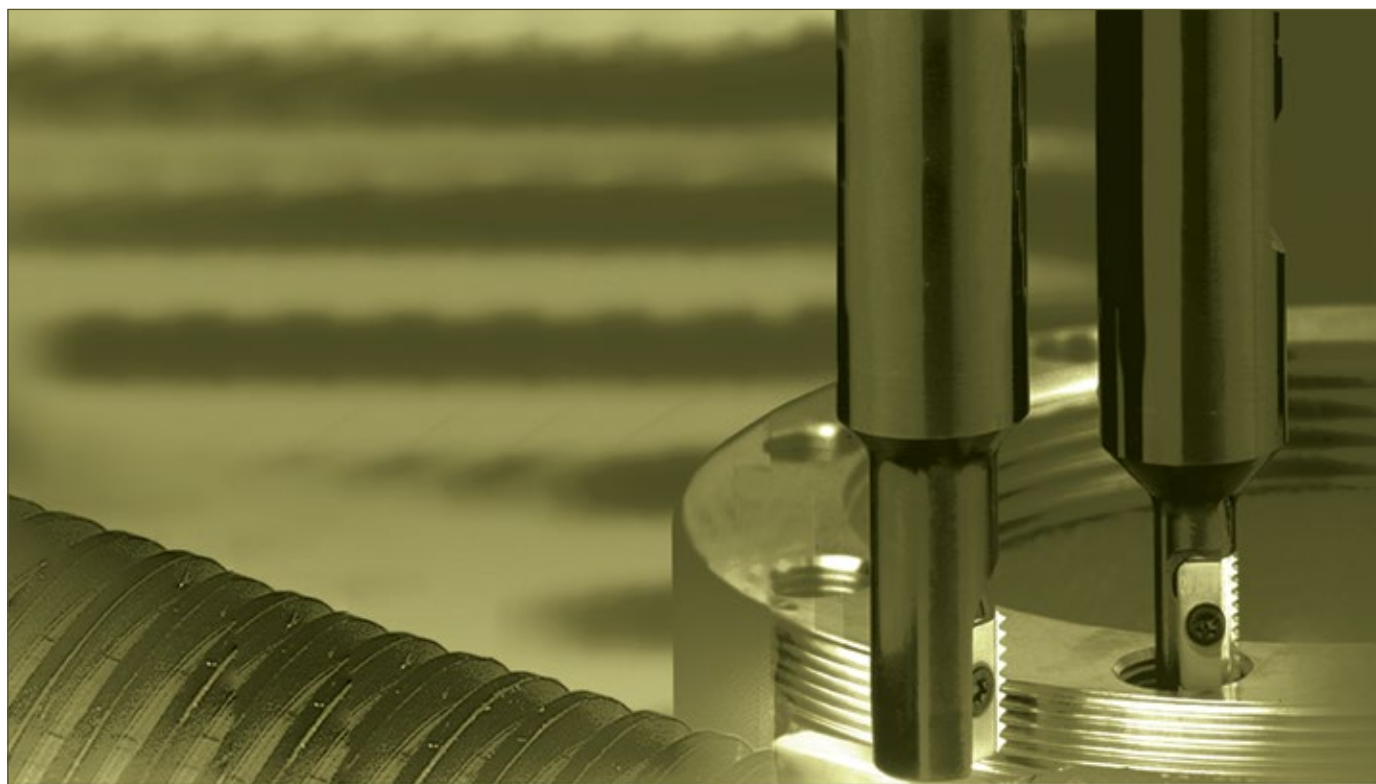

FOR THREADING ON CNC MILLING MACHINES BY USING HELICAL INTERPOLATION PROGRAMS

- ADVANTAGES:**
- ▶ Thread is produced in one tool pass
 - ▶ Same tool holder and insert can produce both right hand and left hand threads
 - ▶ A single insert and tool holder can produce a given thread on many diameters (External and Internal)
 - ▶ Prismatic shape ensures exact and reliable clamping in the tool holder
 - ▶ Most inserts are double sided, having two cutting edges
 - ▶ Longer tool life due to a special multi-layer coating process
 - ▶ Capable of producing tapered threads
 - ▶ Improved productivity due to increased cutting speeds and multitooth type carbide inserts
 - ▶ Threading to within one pitch of the bottom in a blind hole
 - ▶ Considerably less expensive than using taps and dies, lowering tooling costs
 - ▶ Since lower machine power is required, a smaller machine can produce larger threads in a single operation with less idle time and tool changes

Product Identification													
Inserts	Cutters												
<div style="display: flex; justify-content: space-around; margin-bottom: 10px;"> <div style="border: 1px solid gray; padding: 5px;">E</div> <div style="border: 1px solid gray; padding: 5px;">12</div> <div style="border: 1px solid gray; padding: 5px;">UN</div> </div> <div style="display: flex; justify-content: space-between;"> <div style="width: 15%;"> <p>Insert Size</p> <table border="1"> <tr><td>A</td></tr> <tr><td>12</td></tr> <tr><td>14</td></tr> <tr><td>21</td></tr> <tr><td>30</td></tr> <tr><td>40</td></tr> </table> </div> <div style="width: 20%;"> <p>E = External I = Internal - = EXT. + INT.</p> </div> <div style="width: 20%;"> <p>Thread Pitch</p> </div> <div style="width: 20%;"> <p>Thread Profile</p> <p>ISO UN WHIT NPT NPTF BSPT</p> </div> <div style="width: 25%;"> <p>Carbide Grades</p> <p>MT5 MT7</p> </div> </div>	A	12	14	21	30	40	<div style="display: flex; justify-content: space-around; margin-bottom: 10px;"> <div style="border: 1px solid gray; padding: 5px;">S</div> <div style="border: 1px solid gray; padding: 5px;">R</div> <div style="border: 1px solid gray; padding: 5px;">1180</div> <div style="border: 1px solid gray; padding: 5px;">J</div> <div style="border: 1px solid gray; padding: 5px;">21</div> <div style="border: 1px solid gray; padding: 5px;">C</div> <div style="border: 1px solid gray; padding: 5px;">2</div> </div> <div style="display: flex; justify-content: space-between;"> <div style="width: 15%;"> <p>R = Right Hand L = Left Hand</p> </div> <div style="width: 20%;"> <p>Cutting Diameter</p> <p>Inch: 1180 = 1.18"</p> </div> <div style="width: 20%;"> <p>Length of Tool Holder</p> </div> <div style="width: 20%;"> <p>Insert Size</p> <table border="1"> <tr><td>A</td></tr> <tr><td>12</td></tr> <tr><td>14</td></tr> <tr><td>21</td></tr> <tr><td>30</td></tr> <tr><td>40</td></tr> </table> </div> <div style="width: 25%;"> <p>Carbide Shank</p> <p>No. of Inserts</p> </div> </div>	A	12	14	21	30	40
A													
12													
14													
21													
30													
40													
A													
12													
14													
21													
30													
40													

Indexable Thread Milling Cutters



Single, Double & Multi-Insert

• Minimum bore should be one-third greater than D

Single Insert
Coolant-Thru

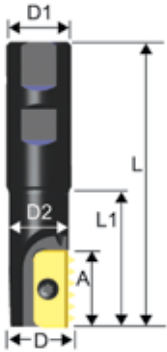

Single Insert Cutters

Type	Insert Size A=mm	D (Inch)	D1 (Inch)	D2 (Inch)	L (Inch)	L1 (Inch)	Code
SR0500F14	14	0.50	0.75	0.37	2.95	0.70	570900
SR0540F14	14	0.54	0.75	0.38	2.98	0.77	570901
SR0570H14	14	0.57	0.75	0.41	3.20	1.00	570902
SR0670H14	14	0.67	0.75	0.53	3.35	1.18	570903
SR0790H21	21	0.79	0.75	0.61	3.66	1.57	570904
SR1140J30	30	1.14	1.00	0.91	4.25	1.85	570905
SR1730M40	40	1.73	1.50	1.38	6.02	3.19	570906

Single Insert
Coolant-Thru
Long Carbide Shank



Single Insert Cutters (Carbide Shank/Long Length)

For holders with long overhang reduce cutting speed and feed rate between 20% to 40%

Type	Insert Size A=mm	D (Inch)	D1 (Inch)	D2 (Inch)	L (Inch)	Code
SR0500J14C	14	0.50	0.375	0.375	6.0	570920
SR0620K14C	14	0.62	0.500	0.500	7.0	570921
SR0820M21C	21	0.82	0.625	0.625	8.0	570922

THREAD MILLING

Double Insert
Coolant-Thru

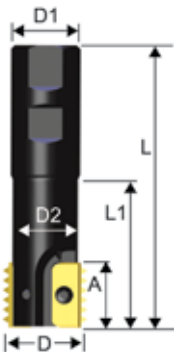

Double Insert Cutters (2 Inserts)

Type	Insert Size A=mm	D (Inch)	D1 (Inch)	D2 (Inch)	L (Inch)	L1 (Inch)	Code
SR0790H14-2	14	0.79	0.75	0.63	3.66	1.57	570910
SR1180J21-2	21	1.18	1.00	0.94	4.25	1.97	570911
SR1580L30-2	30	1.57	1.25	1.18	5.12	2.80	570912
SR1970M40-2	40	1.97	1.50	1.49	6.02	3.35	570913

Multi-Insert

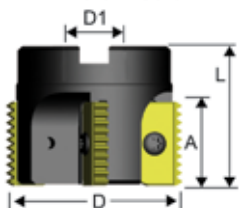

Multi-Insert Shell Mill Cutters

Type	Insert Size A=mm	D (Inch)	D1 (Inch)	L (Inch)	No. of Inserts	Code
SR2480C21-5	21	2.48	0.75	1.97	5	570914
SR2480C30-4	30	2.48	0.75	1.97	4	570915
SR3150D30-4	30	3.15	1.00	2.16	4	570916
SR3940D30-4	30	3.94	1.25	2.36	4	570917
SR3150D40-4	40	3.15	1.00	2.56	4	570918
SR3940E40-4	40	3.94	1.25	2.76	4	570919

Indexable Thread Milling Cutters



Indexable Thread Milling Cutter Accessories

Insert Screws

Torx® Keys

Insert Size A=mm	Insert Screw	Code
14	S14	570890
21	S21	570891
30	S30	570892
40	S40	570893

Insert Size A=mm	Torx® Key	Code
14	K14	570895
21	K21	570896
30	K30	570897
40	K40	570898

Indexable Thread Milling Inserts



UN, ISO & NPT – Internal & External



CARMEX series inserts also fit STELLRAM, ISCAR, GREENFIELD, STS, and XACTFORM/DURAMET

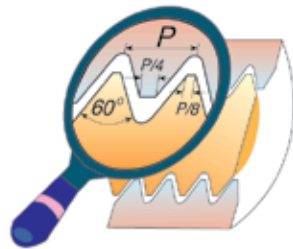

UN and ISO: Thread milling operation is applicable for thread cutting in non-symmetrical parts, utilizing the advantage of helical interpolation programs of modern machining centers

Insert Dimensions					
Insert Size A		H		T	
Inch	mm	Inch	mm	Inch	mm
0.551	14	0.295	7.5	0.122	3.1
0.827	21	0.472	12.0	0.185	4.7
1.181	30	0.630	16.0	0.217	5.5
1.575	40	0.787	20.0	0.248	6.3

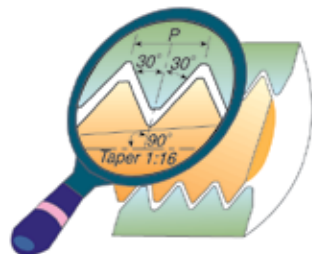
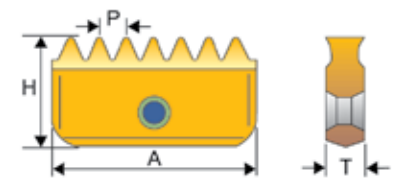

NPT: Conical pipe thread inserts are single-sided and may be used for both external and internal threading. Thread milling operation is applicable for thread cutting in non-symmetrical parts, utilizing the advantage of helical interpolation programs of modern machining centers.

Insert Dimensions					
Insert Size A		H		T	
Inch	mm	Inch	mm	Inch	mm
0.551	14	0.295	7.5	0.122	3.1
0.827	21	0.472	12.0	0.185	4.7
1.181	30	0.630	16.0	0.217	5.5
1.575	40	0.787	20.0	0.248	6.3

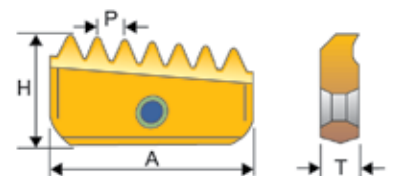

UN

Pitch (TPI)	A Insert Size	Internal		External	
		Insert Reference	Code	Insert Reference	Code
32	14 mm (0.551")	14I 32 UN	570750	14E 32 UN	570700
28	14 mm (0.551")	14I 28 UN	570751	14E 28 UN	570701
24	14 mm (0.551")	14I 24 UN	570752	14E 24 UN	570702
20	14 mm (0.551")	14I 20 UN	570753	14E 20 UN	570703
18	14 mm (0.551")	14I 18 UN	570754	14E 18 UN	570704
16	14 mm (0.551")	14I 16 UN	570755	14E 16 UN	570705
14	14 mm (0.551")	14I 14 UN	570756	14E 14 UN	570706
12	14 mm (0.551")	14I 12 UN	570757	14E 12 UN	570707
24	21 mm (0.827")	21I 24 UN	570762	21E 24 UN	570712

THREAD MILLING

Indexable Thread Milling Inserts



UN, ISO & NPT – Internal & External (continued)

UN (continued)

Pitch (TPI)	A Insert Size	Internal		External	
		Insert Reference	Code	Insert Reference	Code
20	21 mm (0.827")	2I1 20 UN	570763	2IE 20 UN	570713
18	21 mm (0.827")	2I1 18 UN	570764	2IE 18 UN	570714
16	21 mm (0.827")	2I1 16 UN	570765	2IE 16 UN	570715
14	21 mm (0.827")	2I1 14 UN	570766	2IE 14 UN	570716
12	21 mm (0.827")	2I1 12 UN	570767	2IE 12 UN	570717
10	21 mm (0.827")	2I1 10 UN	570768	2IE 10 UN	570718
8	21 mm (0.827")	2I1 8 UN	570769	–	–
20	30 mm (1.181")	30I 20 UN	570773	30E 20 UN	570723
18	30 mm (1.181")	30I 18 UN	570774	30E 18 UN	570724
16	30 mm (1.181")	30I 16 UN	570775	30E 16 UN	570725
14	30 mm (1.181")	30I 14 UN	570776	30E 14 UN	570726
12	30 mm (1.181")	30I 12 UN	570777	30E 12 UN	570727
10	30 mm (1.181")	30I 10 UN	570778	30E 10 UN	570728
8	30 mm (1.181")	30I 8 UN	570779	30E 8 UN	570729
6	30 mm (1.181")	30I 6 UN	570780	30E 6 UN	570730
16	40 mm (1.575")	40I 16 UN	570785	40E 16 UN	570735
14	40 mm (1.575")	40I 14 UN	570786	40E 14 UN	570736
12	40 mm (1.575")	40I 12 UN	570787	40E 12 UN	570737
10	40 mm (1.575")	40I 10 UN	570788	40E 10 UN	570738
8	40 mm (1.575")	40I 8 UN	570789	40E 8 UN	570739
6	40 mm (1.575")	40I 6 UN	570790	40E 6 UN	570740

ISO

Pitch (TPI)	A Insert Size	Internal		External	
		Insert Reference	Code	Insert Reference	Code
0.5	14 mm (0.551")	14I 0.5 ISO	570850	–	–
0.75	14 mm (0.551")	14I 0.75 ISO	570851	14E 0.75 ISO	570801
1.0	14 mm (0.551")	14I 1.0 ISO	570852	14E 1.0 ISO	570802
1.25	14 mm (0.551")	14I 1.25 ISO	570853	14E 1.25 ISO	570803
1.5	14 mm (0.551")	14I 1.5 ISO	570854	14E 1.5 ISO	570804
2.0	14 mm (0.551")	14I 2.0 ISO	570855	14E 2.0 ISO	570805
2.5	14 mm (0.551")	14I 2.5 ISO	570856	14E 2.5 ISO	570806
1.0	21 mm (0.827")	21I 1.0 ISO	570862	21E 1.0 ISO	570812
1.5	21 mm (0.827")	21I 1.5 ISO	570864	21E 1.5 ISO	570814
2.0	21 mm (0.827")	21I 2.0 ISO	570865	21E 2.0 ISO	570815
2.5	21 mm (0.827")	21I 2.5 ISO	570866	21E 2.5 ISO	570816
3.0	21 mm (0.827")	21I 3.0 ISO	570867	21E 3.0 ISO	570817
1.5	30 mm (1.181")	30I 1.5 ISO	570874	30E 1.5 ISO	570824
2.0	30 mm (1.181")	30I 2.0 ISO	570875	30E 2.0 ISO	570825
3.0	30 mm (1.181")	30I 3.0 ISO	570877	30E 3.0 ISO	570827
4.0	30 mm (1.181")	30I 4.0 ISO	570878	30E 4.0 ISO	570828
1.5	40 mm (1.575")	40I 1.5 ISO	570884	40E 1.5 ISO	570834
2.0	40 mm (1.575")	40I 2.0 ISO	570885	40E 2.0 ISO	570835
3.0	40 mm (1.575")	40I 3.0 ISO	570887	40E 3.0 ISO	570837
4.0	40 mm (1.575")	40I 4.0 ISO	570888	40E 4.0 ISO	570838

NPT

Pitch (TPI)	A Insert Size	Insert Reference	Code
18	14 mm (0.551")	14-18 NPT	570791
14	14 mm (0.551")	14-14 NPT	570792
14	21 mm (0.827")	21-14 NPT	570793
11.5	21 mm (0.827")	21-11.5 NPT	570794
11.5	30 mm (1.181")	30-11.5 NPT	570795
8	30 mm (1.181")	30-8 NPT	570796
11.5	40 mm (1.575")	40-11.5 NPT	570797
8	40 mm (1.575")	40-8 NPT	570798

Thread Milling Cutters



Solid Carbide – Helical – UN & NPT

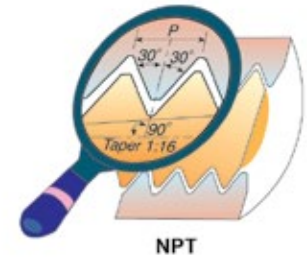
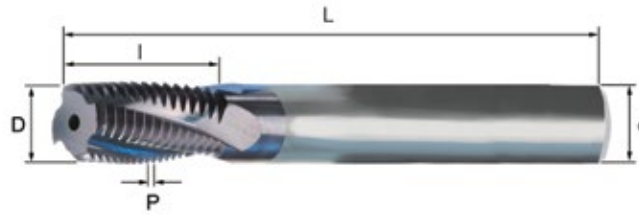
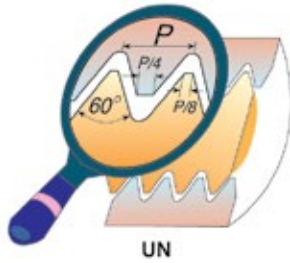

UN with Coolant-Thru

Pitch (TPI)	Standard Tap Size UNC	Standard Tap Size UNF	Standard Tap Size UNEF	Ød (Inch)	ØD (Inch)	No. of Flutes	l (Inch)	L (Inch)	Description	Code
32	8	10	12	1/4	0.126	3	0.27	2.50	MTB0250C02 32 UN	570120
28	-	1/4	-	1/4	0.197	3	0.44	2.50	MTB0250C04 28 UN	570122
28	-	-	7/16 - 1/2	1/4	0.250	3	0.56	2.50	MTB0250C05 28 UN	570124
24	-	5/16	-	5/16	0.260	3	0.56	2.50	MTB0312C05 24 UN	570126
24	-	3/8	9/16 - 5/8	5/16	0.312	4	0.81	2.50	MTB0312D08 24 UN	570128
20	1/4	-	-	1/4	0.185	3	0.48	2.50	MTB0250C04 20 UN	570130
20	-	7/16	-	5/16	0.312	3	0.83	2.50	MTB0312C08 20 UN	570132
20	-	1/2	-	3/8	0.375	4	0.88	3.00	MTB0375D08 20 UN	570134
20	-	-	3/4 - 1	1/2	0.500	5	1.07	4.00	MTB0500E10 20 UN	570136
18	5/16	-	-	1/4	0.220	3	0.58	2.50	MTB0250C05 18 UN	570138
18	-	9/16 - 5/8	1-1/8 - 1-5/8	1/2	0.445	4	1.03	4.00	MTB0500D10 18 UN	570140
16	3/8	-	-	5/16	0.264	3	0.66	2.50	MTB0312C06 16 UN	570142
16	-	3/4	-	1/2	0.500	4	1.22	4.00	MTB0500D12 16 UN	570144
14	7/16	-	-	5/16	0.303	3	0.82	2.50	MTB0312C08 14 UN	570146
14	2-1/2	7/8	-	5/8	0.625	5	1.46	4.00	MTB0625E14 14 UN	570148
13	1/2	-	-	3/8	0.362	3	0.89	3.00	MTB0375C08 13 UN	570150
12	9/16	-	-	1/2	0.413	3	1.04	4.00	MTB0500C10 12 UN	570152
12	-	1 - 1-1/2	-	5/8	0.625	5	1.63	4.00	MTB0625E16 12 UN	570154
11	5/8	-	-	1/2	0.449	3	1.14	4.00	MTB0500C11 11 UN	570156
10	3/4	-	-	5/8	0.567	4	1.35	4.00	MTB0625D13 10 UN	570158
9	7/8	-	-	5/8	0.625	3	1.50	4.00	MTB0625C15 9 UN	570160

NPT with Coolant-Thru

Pitch (TPI)	Standard Tap Size (Inch)	Ød (Inch)	ØD (Inch)	No. of Flutes	l (Inch)	L (Inch)	Description	Code
27	1/8	5/16	0.299	3	0.43	2.50	MTB0312C04 27 NPT	570060
18	1/4 - 3/8	3/8	0.375	4	0.64	3.00	MTB0375D06 18 NPT	570061
14	1/2 - 3/4	5/8	0.610	4	0.89	4.00	MTB0625D08 14 NPT	570062
11.5	1 - 2	3/4	0.750	4	1.17	4.00	MTB0750D11 11.5 NPT	570063
8	2-1/2 and larger	3/4	0.750	4	1.56	4.00	MTB0750D15 8 NPT	570064

THREAD MILLING

Thread Milling Information Guide

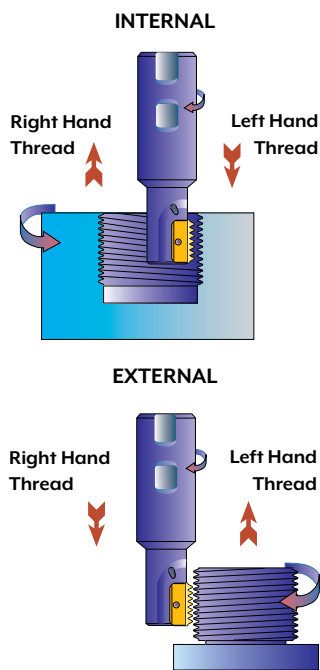

- ▶ Carbide grade MT7 (Sub-micron grade with Titanium Aluminum Nitride multi-layer coating - ISO K10-K20)
- ▶ Thread milling is good for thread cutting in asymmetrical parts, utilizing the advantages of helical interpolation programs of modern machining centers

NOTE RECOMMENDED FEED RATE: 0.002" - 0.006" (0.05 - 0.15 mm)
Cutting speed is shown in range terms. In most standard cases choosing a speed in the middle of the range would be a good choice for a start.
For hard metals reduce cutting speed.

Speed Selection		
ISO	Materials	Grade
		MT7
		ft/min
P	Low and Medium Carbon Steels	380-920
	High Carbon Steels	430-660
	Alloy Steels, Treated Steels	340-590
M	Stainless Steels	430-620
	Cast Steels	490-620
K	Cast Iron	260-560
N	Non-ferrous and Aluminum	590-1120
	Synthetics, Duroplastics, Thermoplastics	380-1500
S	Nickel Alloys, Titanium Alloys	80-300

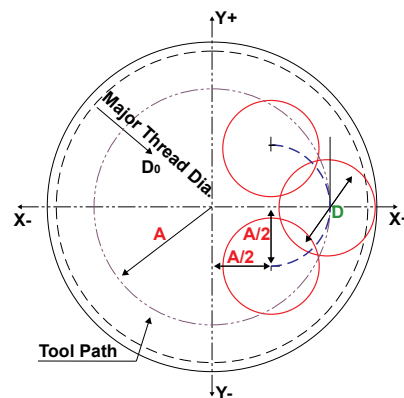

```

General Program
G90 G00 G54 G43 HIX0 Y0 Z10 S- - -
G00 Z- (to thread depth)
G01 G91 G41 D1 X(A/2) Y-(A/2) Z0 F- - -
G03 X(A/2) Y(A/2) R(A/2) Z(1/8 pitch)
G03 X0 Y0 I-(A) J0 Z(pitch)
G03 X-(A/2) Y(A/2) R(A/2) Z(1/8 pitch)
G01 G40 X-(A/2) Y-(A/2) Z0
G90 X0 Y0 Z0
    
```

```

EXAMPLE: Internal Thread
INTERNAL: 1-1/4 - 12UN x 0.71 depth
TOOL HOLDER: 570-904
CUTTING DIAMETER: 0.79
INSERT: 21 I 12 UN (570-767)
PITCH = 1/12 = 0.0833"
PITCH / 8 = 0.0104"
DEPTH: 0.71
A = (1.25 - 0.79) / 2 = 0.23"
A / 2 = 0.1150"

G90 G00 G54 G43 HIX0 Y0 Z 0.39 S2800
G00 Z- 0.71
G01 G91 G41X 0.1150 Y-0.1150 Z0 F3.35 D1
G03 X0.1150 Y0.1150 R0.1150 Z0.0104
G03 X0 Y0 I-0.23 J0 Z0.0833
G03 X-0.1150 Y0.1150 R0.1150 Z0.0104
G01 G40 X-0.1150 Y-0.1150 Z0
G90 G0 X0 Y0 Z0
    
```

Thread Milling CNC Program for Internal Thread

Right hand thread (climb milling) from bottom up. Program is based on tool center. This method of programming needs no tool radius compensation value, other than an offset for wear.

$$A = \frac{D_0 - D}{2}$$

A = Radius of tool path
D₀ = Major thread diameter
D = Cutting diameter

Conversion of Cutting Speed to Rotational Speed

EXAMPLE: V=120 m/min (394 ft/min)
D=30 mm (1.18")
D=Cutting Diameter

Conversion of selected cutting speed to rotational speed is calculated by the following formula:

ISO

$$N = \frac{V \times 1000}{\pi \times D} = \frac{120 \times 1000}{3.14 \times 1.25} = 1,274 \text{ RPM}$$

ANSI

$$N = \frac{V}{0.262 \times D} = \frac{394}{0.262 \times 1.18} = 1,274 \text{ RPM}$$

Thread Milling Cutter Tool Selection

For Indexable and Solid Carbide Thread Milling Cutters

- ▶ The following chart is meant to provide a fairly accurate visual selection tool for internal threading
- ▶ This chart is suitable for the following thread forms: ISO, UN, WHIT, NPT, NPTF, BSPT

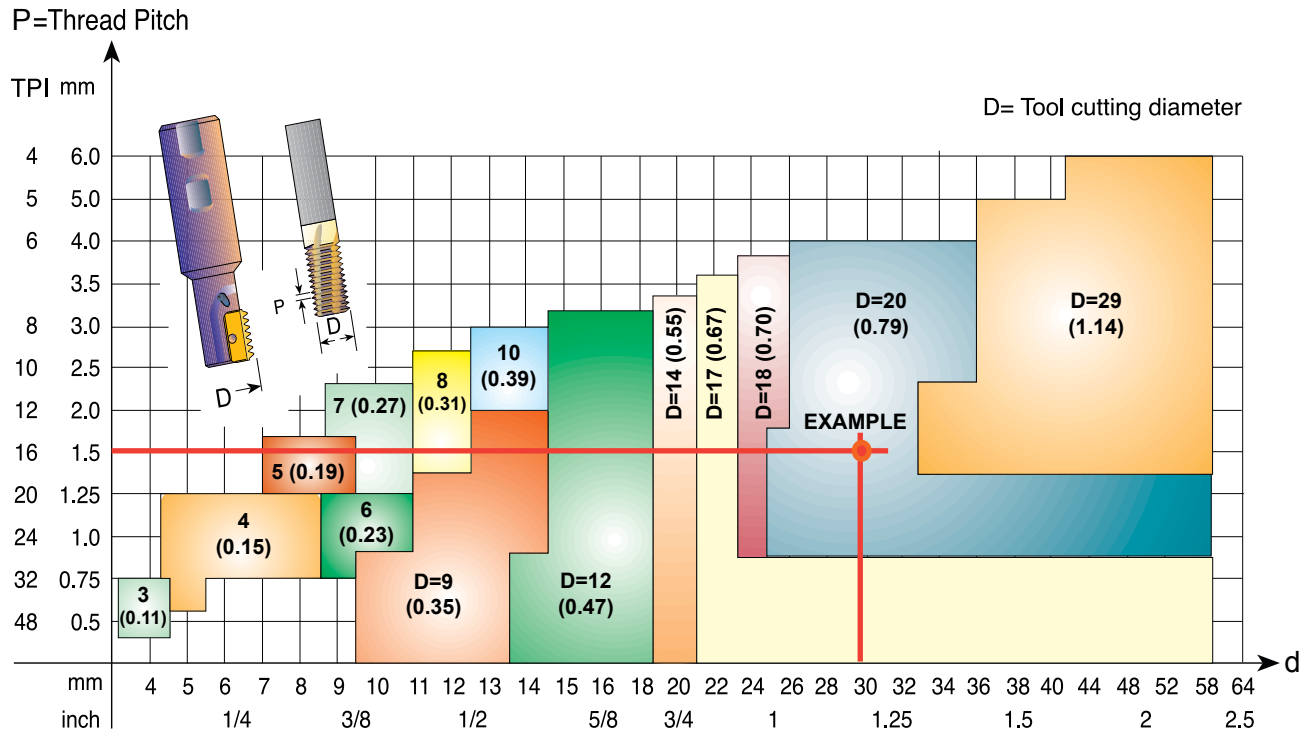

Any tool having a small cutting diameter can produce large diameter threads.

EXAMPLE: Internal thread 1-1/4 x 16UN

- ▶ Find a milling tool to produce d=1.25" internal right hand UN thread having thread pitch P=1/16"
- ▶ As can be seen from the chart above, the two red lines intersect at selected tool having cutting diameter of D=0.79"
- ▶ **CHOSEN:**

Holder	SR0790H21	(570-904)
Insert	2III6UNMT7	(570-765)

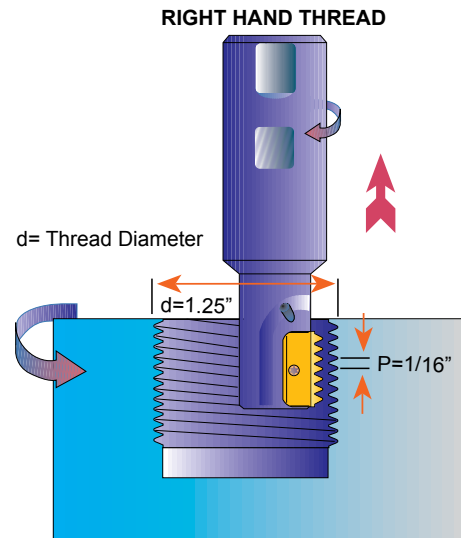

NOTE

TO ASSIST YOU,
a CD-ROM is available on request. This will help guide you to tool selection, machining recommendations, and a CNC program generator for most thread milling tools.

Thread Milling Information Guide

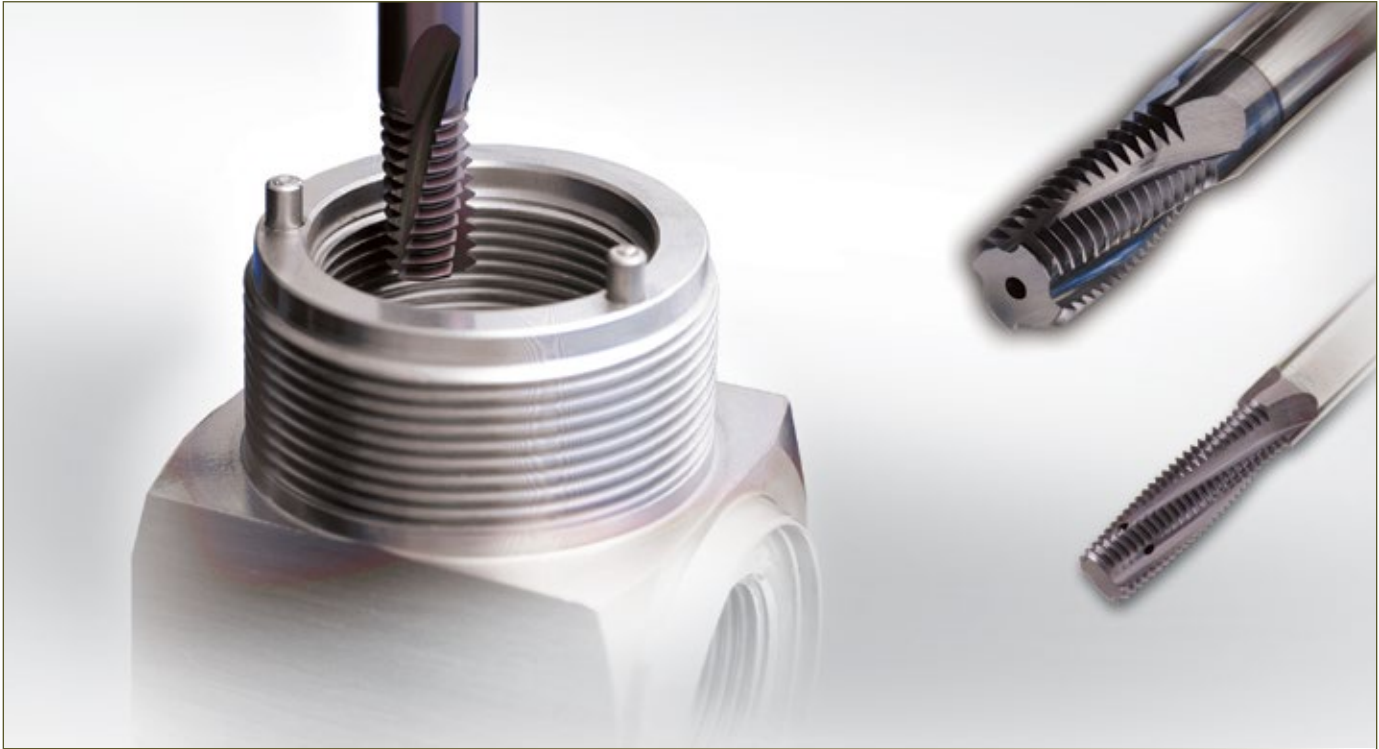

Recommended Cutting Parameters

ISO	Materials	Cutting Speed ft/min	Feed inch/tooth										
			Cutting ØD										
			Ø3/32	Ø1/8	Ø5/32	Ø1/4	Ø5/16	Ø3/8	Ø1/2	Ø5/8	Ø3/4	Ø1	Ø1.25
P	Low and medium carbon steels	330-820	0.0012	0.0014	0.0020	0.002	0.003	0.003	0.004	0.005	0.005	0.007	0.009
	High carbon steels	360-590	0.0009	0.0011	0.0010	0.002	0.002	0.003	0.003	0.004	0.005	0.006	0.007
	Alloy steels, treated steels	300-520	0.0008	0.0009	0.0010	0.001	0.002	0.002	0.002	0.003	0.003	0.004	0.005
M	Stainless steels	360-560	0.0008	0.0009	0.0010	0.001	0.002	0.002	0.002	0.003	0.003	0.004	0.005
	Cast steels	430-560	0.0008	0.0009	0.0010	0.001	0.002	0.002	0.002	0.003	0.003	0.004	0.005
K	Cast iron	230-500	0.0012	0.0014	0.0020	0.002	0.003	0.003	0.004	0.005	0.005	0.007	0.009
N	Aluminum	520-980	0.0012	0.0014	0.0020	0.002	0.003	0.003	0.004	0.005	0.005	0.007	0.009
	Synthetics, duroplastics, thermoplastics	330-1300	0.0020	0.0024	0.0030	0.004	0.004	0.004	0.005	0.006	0.007	0.009	0.010
S	Nickel alloys, titanium alloys	70-760	0.0008	0.0008	0.0008	0.001	0.001	0.001	0.001	0.002	0.002	0.002	0.002

Product Identification

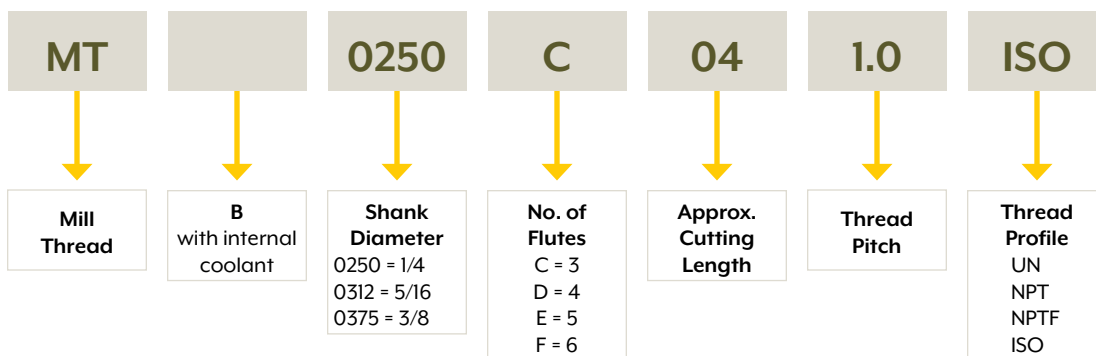

Miniature Thread Milling Cutters

UN & Metric/ISO

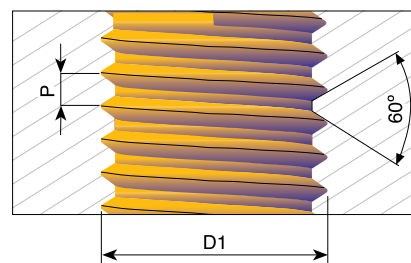
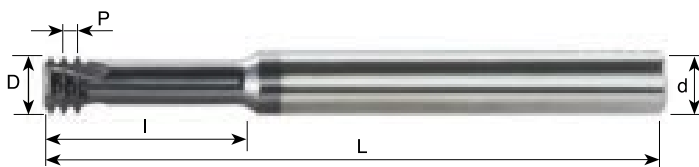

UN for Thread Depth up to 2xD1

Pitch (TPI)	Standard Tap Size UNC	Standard Tap Size UNF	Ød (Inch)	ØD (Inch)	No. of Flutes	l (Inch)	L (Inch)	Description	Code
72	-	1	1/4	0.057	3	0.15	2.5	MTS0250CI5 72 UN	570165
64	1	2	1/4	0.055	3	0.15	2.5	MTS0250CI5 64 UN	570166
56	2	3	1/4	0.065	3	0.17	2.5	MTS0250CI7 56 UN	570167
48	3	4	1/4	0.075	3	0.20	2.5	MTS0250C20 48 UN	570168
40	4	-	1/4	0.083	3	0.25	2.5	MTS0250C25 40 UN	570169
40	5	6	1/4	0.096	3	0.28	2.5	MTS0250C28 40 UN	570170
36	-	8	1/4	0.130	3	0.35	2.5	MTS0250C35 36 UN	570171
32	6	-	1/4	0.100	3	0.28	2.5	MTS0250C28 32 UN	570172
32	8	-	1/4	0.126	3	0.37	2.5	MTS0250C37 32 UN	570173
28	-	1/4	1/4	0.197	3	0.57	2.5	MTS0250C57 28 UN	570174
24	10, 12	-	1/4	0.138	3	0.42	2.5	MTS0250C42 24 UN	570175
24	-	5/16	5/16	0.260	3	0.67	2.5	MTS0312C67 24 UN	570176
20	1/4	-	1/4	0.187	3	0.55	2.5	MTS0250C55 20 UN	570177

UN for Thread Depth up to 3xD1

Pitch (TPI)	Standard Tap Size UNC	Standard Tap Size UNF	Ød (Inch)	ØD (Inch)	No. of Flutes	l (Inch)	L (Inch)	Description	Code
40	5	6	1/4	0.096	3	0.38	2.5	MTS0250C38 40 UN	570180
32	8	-	1/4	0.126	3	0.49	2.5	MTS0250C49 32 UN	570181
28	-	1/4	1/4	0.197	3	0.75	2.5	MTS0250C75 28 UN	570182
24	-	5/16	5/16	0.260	3	0.94	2.5	MTS0312C94 24 UN	570183
20	1/4	-	1/4	0.187	3	0.75	2.5	MTS0250C75 20 UN	570184

THREAD MILLING

Miniature Thread Milling Cutters



UN & Metric/ISO (continued)

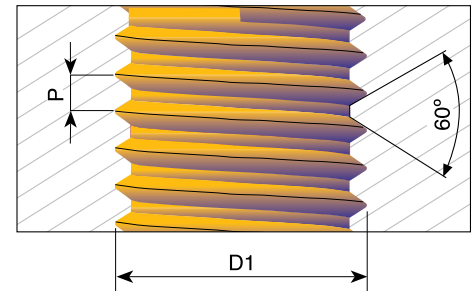
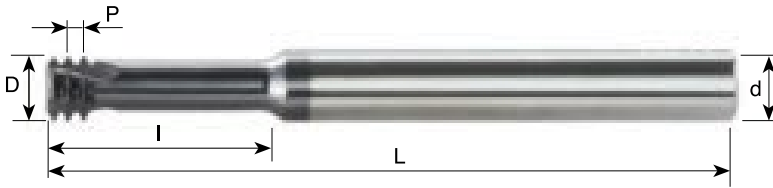

Metric/ISO for Thread Depth up to 2xD1

Pitch (TPI)	D1	Ød (Inch)	ØD (Inch)	No. of Flutes	I (Inch)	L (Inch)	Description	Code
0.4	M2	1/4	0.061	3	0.18	2.5	MTS0250C18 0.4 ISO	570185
0.45	M2.2	1/4	0.065	3	0.20	2.5	MTS0250C20 0.45 ISO	570186
0.45	M2.5	1/4	0.077	3	0.22	2.5	MTS0250C22 0.45 ISO	570187
0.5	M3	1/4	0.093	3	0.26	2.5	MTS0250C26 0.5 ISO	570188
0.6	M3.5	1/4	0.108	3	0.30	2.5	MTS0250C30 0.6 ISO	570189
0.7	M4	1/4	0.122	3	0.35	2.5	MTS0250C35 0.7 ISO	570190
0.8	M5	1/4	0.150	3	0.49	2.5	MTS0250C49 0.8 ISO	570191
1.0	M6	1/4	0.183	3	0.55	2.5	MTS0250C55 1.0 ISO	570192
1.25	M8	1/4	0.234	3	0.71	2.5	MTS0250C71 1.25 ISO	570193

Metric/ISO for Thread Depth up to 3xD1

Pitch (TPI)	D1	Ød (Inch)	ØD (Inch)	No. of Flutes	I (Inch)	L (Inch)	Description	Code
0.45	M2.5	1/4	0.077	3	0.30	2.5	MTS0250C30 0.45 ISO	570194
0.5	M3	1/4	0.093	3	0.37	2.5	MTS0250C37 0.5 ISO	570195
0.7	M4	1/4	0.122	3	0.49	2.5	MTS0250C49 0.7 ISO	570196
0.8	M5	1/4	0.150	3	0.63	2.5	MTS0250C63 0.8 ISO	570197
1.0	M6	1/4	0.183	3	0.79	2.5	MTS0250C79 1.0 ISO	570198
1.25	M8	1/4	0.234	3	0.94	2.5	MTS0250C94 1.25 ISO	570199

THREAD MILLING

Miniature Thread Milling Information Guide

Recommended Cutting Parameters

- ▶ Solid Carbide Grade MT7 (Sub-micron grade with Titanium Aluminum Nitride multi-layer coating - ISO K10-K20)
- ▶ To be run at medium to high cutting speeds
- ▶ General purpose for all materials

ADVANTAGES: Specially designed solid carbide thread mills for the production of internal threads in very small bores. Due to the unique tool design, accurate geometries and high quality sub-micron carbide grade with Titanium Aluminum Nitride (TiAlN) coating, the following are achieved:

- ▶ Threading from 0-80UNF (bore diameter 0.05)
- ▶ Working in high cutting speed
- ▶ Short machine time
- ▶ Low cutting forces thanks to the short profile
- ▶ No broken taps
- ▶ Threading up to shoulder in blind holes
- ▶ Machining of hardened materials

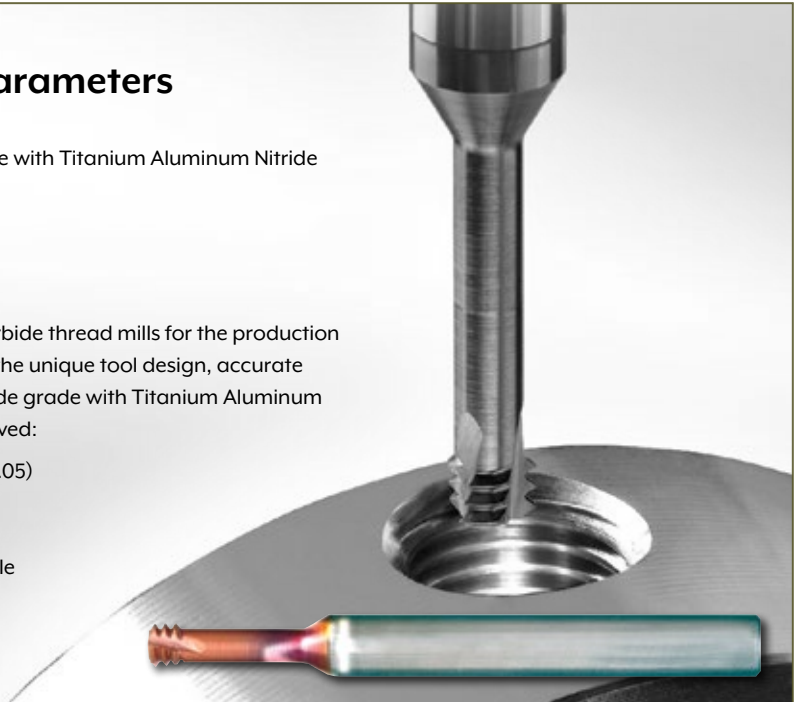

ISO	Materials	Cutting Speed ft/min	Feed inch/tooth												
			Cutting ØD												
			Ø0.06	Ø0.08	Ø0.12	Ø0.16	Ø0.20	Ø0.24	Ø0.28	Ø0.31	Ø0.35	Ø0.39	Ø0.47	Ø0.55	Ø0.59
P	Low and medium carbon steels	200-390	0.0018	0.0021	0.0028	0.0035	0.0043	0.0050	0.0057	0.0060	0.0062	0.0064	0.0067	0.0070	0.0071
	High carbon steels	200-300	0.0016	0.0019	0.0024	0.0030	0.0035	0.0041	0.0046	0.0050	0.0054	0.0057	0.0062	0.0067	0.0069
	Alloy steels, treated steels	160-260	0.0015	0.0017	0.0019	0.0021	0.0024	0.0026	0.0028	0.0033	0.0037	0.0041	0.0047	0.0052	0.0055
M	Stainless steels	200-300	0.0011	0.0013	0.0016	0.0019	0.0022	0.0025	0.0026	0.0031	0.0035	0.0038	0.0044	0.0049	0.0051
	Cast steels	230-300	0.0015	0.0017	0.0019	0.0021	0.0024	0.0026	0.0028	0.0033	0.0037	0.0041	0.0047	0.0052	0.0055
K	Cast iron	130-260	0.0018	0.0021	0.0028	0.0035	0.0043	0.0050	0.0057	0.0060	0.0062	0.0064	0.0067	0.0070	0.0071
N	Aluminum	260-490	0.0018	0.0021	0.0028	0.0035	0.0043	0.0050	0.0057	0.0060	0.0062	0.0064	0.0067	0.0070	0.0071
	Synthetics, duroplastics, thermoplastics	160-660	0.0038	0.0042	0.0049	0.0056	0.0063	0.0070	0.0073	0.0074	0.0075	0.0075	0.0077	0.0078	0.0078
S	Nickel alloys, titanium alloys	70-130	0.0011	0.0013	0.0015	0.0017	0.0020	0.0022	0.0024	0.0025	0.0026	0.0027	0.0029	0.0031	0.0031

Product Identification

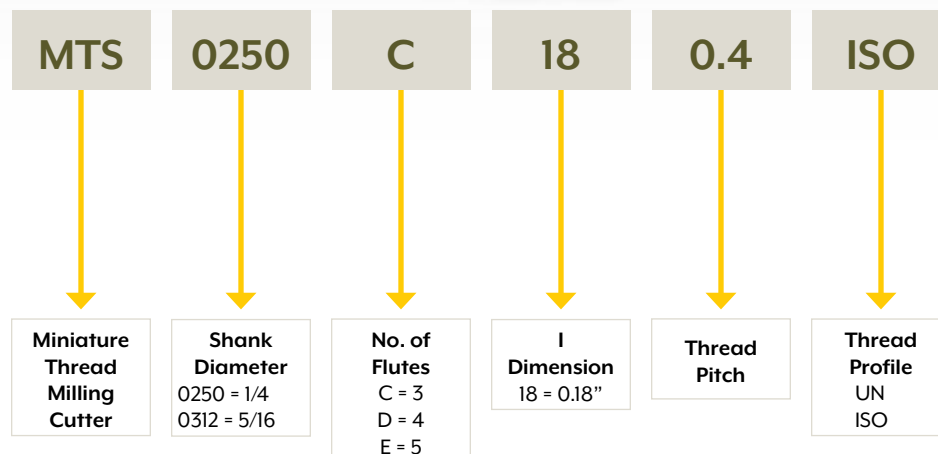

THREAD MILLING

Thread Milling Information Guide

Thread Milling Inserts and Tool Holders

- | Threading on CNC milling machines by using helical interpolation programs
- | Prismatic shape of insert's tail ensures exact and reliable clamping in the tool holder
- | Most inserts are double sided with two cutting edges
- | Longer tool life due to a special multi-layer coating process

Solid Carbide Thread Mill

- | Sub-micron grade with Titanium Aluminum Nitride multi-layer coating (ISO K10-K20)
- | Ideal at medium to high cutting speeds
- | Suitable for general purpose applications and for all materials
- | Spiral flutes allow smooth cutting action
- | Shorter machining time due to multi spiral flutes (three to six)
- | 2.2 mm and larger cutting diameters
- | Longer tool life due to special multi-layer coating

Thread Mills with Coolant-Thru

- | Coolant fluid washes the chips out of hole
- | Increased tool life



Insert Trouble Shooting

Common Problems & Corrective Actions

TURNING									
Common Problems	Corrective Action								
	Reduce Speed (SFM)	Increase Speed (SFM)	Reduce Feed Rate	Increase Feed Rate	Reduce Depth of Cut (DOC)	Increase Depth of Cut (DOC)	Use Higher Wear Resistant (Harder) Grade	Use Tougher Grade	Check Rigidity of System
★ Flank and notch wear	■			■			■		■
Cratering	■		■		■		■		
Chipping		■	■		■			■	■
Plastic deformation	■		■		■		■		
Built-up-edge (BUE)		■		■					
Thermal cracking	■		■		■			■	
Insert breakage			■		■			■	■
Curling of long chips	■			■		■			
Chattering (Vibration)	■			■	■				■
Poor surface finish		■	■		■				

MILLING										
Common Problems	Corrective Action									
	Reduce Speed (SFM)	Increase Speed (SFM)	Reduce Feed/Tooth	Increase Feed/Tooth	Reduce Depth of Cut (DOC)	Use Higher Wear Resistant (Harder) Grade	Use Tougher Grade	Use Coarse Pitch Cutter	Change the Cutter Position	Do Not Use Coolant
★ Flank and notch wear	■			■		■				
Cratering	■		■		■	■				
Chipping		■	■				■			
Built-up-edge (BUE)		■		■	■	■				■
Insert breakage			■				■		■	
Chattering (Vibration)				■	■			■	■	
Poor surface finish	■		■		■	■				

NOTE ★ A uniform flank wear is the optimum type of insert wear. Generally, inserts should be indexed when 0.030" (0.7 mm) flank wear is reached. For finishing operations, index at 0.016" (0.4 mm) flank wear or sooner.

THREAD MILLING

PVD Grade Application

TURNING				
ISO	Grade			
	YBG102	YBG202	YBG203	YBG302
SFM ft/min				
K01-K10	984-1148-1476			
S10-S20	98-197-295			
P01-P20		656-918-1181		
M10-M20		492-722-918		
K10-K20		820-984-1148		
S20-S30		148-197-246		
M10-M30			590-853-1050	
P10-P40				590-787-984
M10-M30				459-656-853
K20-K40				787-918-1050
S20-S30				82-131-180

MILLING				
ISO	Grade			
	YBG102	YBG202	YBG203	YBG302
SFM ft/min				
K01-K20	787-918-1050			
H01-H10	131-164-197			
P01-P30		558-722-886		
M10-M30		590-754-918		
K20-K30		656-787-918		
S10-S20		164-197-230		
H10-H20		131-148-164		
M10-M30			590-787-918	
S10-S20			164-197-230	
H10-H20			131-148-164	
P20-P40				492-656-820
M20-M30				525-689-853
K20-K40				590-722-853
S20-S30				115-131-148



CVD Grade Application



TURNING						
ISO	CVD Grade					
	YBC151	YBC251	YBC351	YBM151	YBM251	YBM351
	SFM ft/min					
P05-P35	900-1200-1500					
P10-P35		850-1100-1300				
M20-M40		390-600-850				
P15-P35			720-900-1100			
M20-M40			390-500-780			
P20-P30				820-1000-1150		
M10-M25				520-720-900		
P25-P40					720-900-1050	
M15-M35					390-600-780	
M25-M40						520-750-900

TURNING								
ISO	CVD Grade					Cermet	PCBN	PCD
	YBD102	YBD151	YBD152	YD101	YD201	YNG151	YCB011/2	YCD011
	SFM ft/min							
K10-K25	650-1000-1300							
K05-K25		520-750-900						
K10-K30			590-800-980		650-1300-2600			
K05-K20				490-3300-6500				
P05-P15						1050-1300-1500		
M10-M20						520-720-900		
K05-K15						520-700-850		
K01-K10							650-1300-2600	2000-6000-8200

MILLING						
ISO	CVD Grade				Uncoated	Cermet
	YBC301	YBC401	YBM251	YBD151	YD201	YNG151
	SFM ft/min					
P25-P45	520-750-980					
M25-M40	390-520-780					
P25-P50		520-650-780				
K30-K40		500-600-750				
P25-P40			720-900-1050			
M15-M40			390-600-780			
K02-K15				300-600-900		
K20-K30					150-210-280	
P05-P15						1050-1300-1500
M10-M20						520-720-900
K05-K15						520-700-850

TECHNICAL INFORMATION

Basic Turning & Milling Formulas

Parameters	Units	Description
d	in	Workpiece diameter or cutter diameter in inches
D.O.C. or ap	in	Depth of Cut in inches
W.O.C.	in	Width of Cut in inches
L	in	Machined length in inches
t	min	Cutting time
N		Number of effective inserts
IPM or Feed Rate	ipm = in/min	Feed rate in inches per minute
IPR or apr	ipr = in/rev	Inches of cutter advance every revolution
IPT or apt	ipt = in/tooth	Inches of cutter advance for each effective insert every revolution
RPM	rev/min	Revolutions per minute
SFM	ft/min	Cutting speed in surface feet per minute
Q	in ³ /min	Metal removal rate in cubic inches per minute
HP _s	HP _s	Horsepower required at the machine spindle
k [*]		k [*] factors are available from reference books

TURNING			
	Find	Units	Given
Cutting Speed	$SFM = 0.262 \times d \times RPM$	ft/min	d, RPM
Spindle Speed	$RPM = 3.82 \times (SFM/d)$	rev/min	d, SFM
Feed Rate	$IPM = IPR \times RPM$	in/min	IPR, RPM
Metal Removal Rate	$Q = 12 \times ap \times IPR \times SFM$	in ³ /min	SFM, ap, IPR
Cutting Time	$t = L / (IPR \times RPM)$	min	
Power Requirement	$HP_s = Q \times k^*$	HP _s	

MILLING			
	Find	Units	Given
Cutting Speed	$SFM = 0.262 \times d \times RPM$	ft/min	d, RPM
Spindle Speed	$RPM = 3.82 \times (SFM/d)$	rev/min	d, SFM
Feed Rate	$IPM = IPR \times RPM$	in/min	IPR, RPM
	$IPM = IPT \times N \times RPM$	in/min	RPM, N, IPT
Inches per Revolution	$IPR = IPM/RPM$	in/rev	IPM, RPM
Spindle Speed	$RPM = IPM/IPR$	rev/min	IPM, IPR
Spindle Speed	$RPM = IPM / (N \times IPT)$	rev/min	IPM, N, IPT
Number of Effective Inserts	$N = IPM / (RPM \times IPT)$		IPM, RPM, IPT
Inches per Tooth	$IPT = IPM / (RPM \times N)$	in/tooth	IPM, N, RPM
Metal Removal Rate	$Q = D.O.C. \times W.O.C. \times IPM$		
Horsepower	$HP = Q \times k^*$	HP	Q, k [*]

TECHNICAL
INFORMATION

Abrasives

301-305



Files

306



Sharpening

306

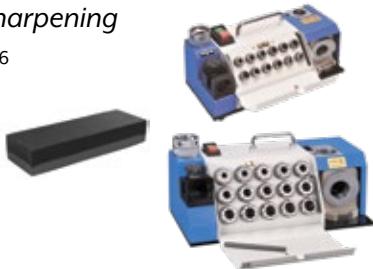



Mounted Flap Wheels

1/4" Shank

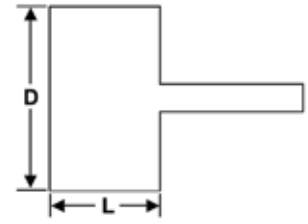

Size D x L (Inch)	Grit	RPM	Code	Size D x L (Inch)	Grit	RPM	Code	Size D x L (Inch)	Grit	RPM	Code
3/4 x 3/4	40	-	705180	1-1/2 x 3/4	240	18000	705246	2 x 1-1/2	60	17000	705321
3/4 x 3/4	60	-	705181	1-1/2 x 3/4	320	18000	705247	2 x 1-1/2	80	17000	705322
3/4 x 3/4	80	-	705182	1-1/2 x 1	40	18000	705260	2 x 1-1/2	120	17000	705323
3/4 x 3/4	120	-	705183	1-1/2 x 1	60	18000	705261	2 x 1-1/2	150	17000	705324
3/4 x 3/4	150	-	705184	1-1/2 x 1	80	18000	705262	2 x 1-1/2	180	17000	705325
3/4 x 3/4	180	-	705185	1-1/2 x 1	120	18000	705263	2 x 1-1/2	240	17000	705326
3/4 x 3/4	240	-	705186	1-1/2 x 1	150	18000	705264	2 x 1-1/2	320	17000	705327
3/4 x 3/4	320	-	705187	1-1/2 x 1	180	18000	705265	2-1/2 x 1/2	40	15000	705330
1 x 1	40	-	705190	1-1/2 x 1	240	18000	705266	2-1/2 x 1/2	60	15000	705331
1 x 1	60	-	705191	1-1/2 x 1	320	18000	705267	2-1/2 x 1/2	80	15000	705332
1 x 1	80	-	705192	2 x 3/8	40	17000	705270	2-1/2 x 1/2	120	15000	705333
1 x 1	120	-	705193	2 x 3/8	60	17000	705271	2-1/2 x 1/2	150	15000	705334
1 x 1	150	-	705194	2 x 3/8	80	17000	705272	2-1/2 x 1/2	180	15000	705335
1 x 1	180	-	705195	2 x 3/8	120	17000	705273	2-1/2 x 1/2	240	15000	705336
1 x 1	240	-	705196	2 x 3/8	150	17000	705274	2-1/2 x 1/2	320	15000	705337
1 x 1	320	-	705197	2 x 3/8	180	17000	705275	2-1/2 x 3/4	40	15000	705340
1-3/16 x 3/16	60	25000	705201	2 x 3/8	240	17000	705276	2-1/2 x 3/4	60	15000	705341
1-3/16 x 3/16	80	25000	705202	2 x 3/8	320	17000	705277	2-1/2 x 3/4	80	15000	705342
1-3/16 x 3/16	120	25000	705203	2 x 1/2	40	17000	705280	2-1/2 x 3/4	120	15000	705343
1-3/16 x 3/16	150	25000	705204	2 x 1/2	60	17000	705281	2-1/2 x 3/4	150	15000	705344
1-3/16 x 3/16	180	25000	705205	2 x 1/2	80	17000	705282	2-1/2 x 3/4	180	15000	705345
1-3/16 x 3/16	240	25000	705206	2 x 1/2	120	17000	705283	2-1/2 x 3/4	240	15000	705346
1-3/16 x 3/16	320	25000	705207	2 x 1/2	150	17000	705284	2-1/2 x 3/4	320	15000	705347
1-3/16 x 3/8	40	25000	705210	2 x 1/2	180	17000	705285	2-1/2 x 1	40	15000	705350
1-3/16 x 3/8	60	25000	705211	2 x 1/2	240	17000	705286	2-1/2 x 1	60	15000	705351
1-3/16 x 3/8	80	25000	705212	2 x 1/2	320	17000	705287	2-1/2 x 1	80	15000	705352
1-3/16 x 3/8	120	25000	705213	2 x 5/8	40	17000	705290	2-1/2 x 1	120	15000	705353
1-3/16 x 3/8	150	25000	705214	2 x 5/8	60	17000	705291	2-1/2 x 1	150	15000	705354
1-3/16 x 3/8	180	25000	705215	2 x 5/8	80	17000	705292	2-1/2 x 1	180	15000	705355
1-3/16 x 3/8	240	25000	705216	2 x 5/8	120	17000	705293	2-1/2 x 1	240	15000	705356
1-3/16 x 3/8	320	25000	705217	2 x 5/8	150	17000	705294	2-1/2 x 1	320	15000	705357
1-1/2 x 1/2	40	18000	705220	2 x 5/8	180	17000	705295	2-1/2 x 1-1/2	40	15000	705360
1-1/2 x 1/2	60	18000	705221	2 x 5/8	240	17000	705296	2-1/2 x 1-1/2	60	15000	705361
1-1/2 x 1/2	80	18000	705222	2 x 5/8	320	17000	705297	2-1/2 x 1-1/2	80	15000	705362
1-1/2 x 1/2	120	18000	705223	2 x 3/4	40	17000	705300	2-1/2 x 1-1/2	120	15000	705363
1-1/2 x 1/2	150	18000	705224	2 x 3/4	60	17000	705301	2-1/2 x 1-1/2	150	15000	705364
1-1/2 x 1/2	180	18000	705225	2 x 3/4	80	17000	705302	2-1/2 x 1-1/2	180	15000	705365
1-1/2 x 1/2	240	18000	705226	2 x 3/4	120	17000	705303	2-1/2 x 1-1/2	240	15000	705366
1-1/2 x 1/2	320	18000	705227	2 x 3/4	150	17000	705304	2-1/2 x 1-1/2	320	15000	705367
1-1/2 x 5/8	60	18000	705231	2 x 3/4	180	17000	705305	3 x 1/2	40	14000	705370
1-1/2 x 5/8	80	18000	705232	2 x 3/4	240	17000	705306	3 x 1/2	60	14000	705371
1-1/2 x 5/8	120	18000	705233	2 x 3/4	320	17000	705307	3 x 1/2	80	14000	705372
1-1/2 x 5/8	150	18000	705234	2 x 1	40	17000	705310	3 x 1/2	120	14000	705373
1-1/2 x 5/8	180	18000	705235	2 x 1	60	17000	705311	3 x 1/2	150	14000	705374
1-1/2 x 3/4	40	18000	705240	2 x 1	80	17000	705312	3 x 1/2	180	14000	705375
1-1/2 x 3/4	60	18000	705241	2 x 1	120	17000	705313	3 x 1/2	240	14000	705376
1-1/2 x 3/4	80	18000	705242	2 x 1	150	17000	705314	3 x 1/2	320	14000	705377
1-1/2 x 3/4	120	18000	705243	2 x 1	180	17000	705315	3 x 3/4	40	14000	705390
1-1/2 x 3/4	150	18000	705244	2 x 1	240	17000	705316	3 x 3/4	60	14000	705391
1-1/2 x 3/4	180	18000	705245	2 x 1	320	17000	705317	3 x 3/4	80	14000	705392
				2 x 1-1/2	40	17000	705320	3 x 3/4	120	14000	705393

Mounted Flap Wheels

1/4" Shank (continued)

Size D x L (Inch)	Grit	RPM	Code	Size D x L (Inch)	Grit	RPM	Code	Size D x L (Inch)	Grit	RPM	Code
3 x 3/4	150	14000	705394	3 x 1	240	14000	705406	3 x 1-1/2	320	9000	705417
3 x 3/4	180	14000	705395	3 x 1	320	14000	705407	3 x 2	40	8000	705420
3 x 3/4	240	14000	705396	3 x 1-1/2	40	9000	705410	3 x 2	60	8000	705421
3 x 3/4	320	14000	705397	3 x 1-1/2	60	9000	705411	3 x 2	80	8000	705422
3 x 1	40	14000	705400	3 x 1-1/2	80	9000	705412	3 x 2	120	8000	705423
3 x 1	60	14000	705401	3 x 1-1/2	120	9000	705413	3 x 2	150	8000	705424
3 x 1	80	14000	705402	3 x 1-1/2	150	9000	705414	3 x 2	180	8000	705425
3 x 1	120	14000	705403	3 x 1-1/2	180	9000	705415	3 x 2	240	8000	705426
3 x 1	150	14000	705404	3 x 1-1/2	240	9000	705416	3 x 2	320	8000	705427
3 x 1	180	14000	705405								

Mounted Points

General Purpose – W Shapes – 1/8", 1/4" & 3/8" Shanks

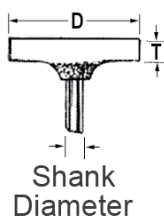

Style	Shank (Inch)	ØD (Inch)	T (Inch)	Code	Style	Shank (Inch)	ØD (Inch)	T (Inch)	Code
W141	1/8	3/32	5/32	725241	W162	1/4	1/4	3/8	718709
W142	1/8	3/32	1/4	725242	W163	1/8	1/4	1/2	725263
W143	1/8	1/8	1/8	725243	W163	1/4	1/4	1/2	718710
W144	1/8	1/8	1/4	725244	W164	1/8	1/4	3/4	725264
W145	1/8	1/8	3/8	725245	W164	1/4	1/4	3/4	718711
W146	1/8	1/8	1/2	725246	W165	1/8	5/16	1/16	725265
W147	1/8	5/32	1/32	725247	W165	1/4	5/16	1/16	718712
W148	1/8	5/32	1/16	725248	W166	1/8	5/16	1/8	725266
W149	1/8	5/32	1/4	725249	W167	1/8	5/16	1/4	725267
W149	1/4	5/32	1/4	718701	W168	1/8	5/16	5/16	725268
W150	1/8	3/16	1/16	725250	W169	1/8	5/16	3/8	725269
W151	1/8	3/16	1/8	725251	W169	1/4	5/16	3/8	718713
W152	1/8	3/16	1/4	725252	W170	1/8	5/16	1/2	725270
W152	1/4	3/16	1/4	718702	W170	1/4	5/16	1/2	718714
W153	1/8	3/16	3/8	725253	W171	1/8	5/16	3/4	725271
W153	1/4	3/16	3/8	718703	W172	1/8	3/8	1/16	725272
W154	1/8	3/16	1/2	725254	W173	1/8	3/8	1/8	725273
W154	1/4	3/16	1/2	718704	W173	1/4	3/8	1/8	718715
W155	1/8	13/64	1/4	725255	W174	1/8	3/8	1/4	725274
W155	1/4	13/64	1/4	718705	W174	1/4	3/8	1/4	718716
W156	1/8	1/4	1/32	725256	W175	1/8	3/8	3/8	725275
W157	1/8	1/4	1/16	725257	W175	1/4	3/8	3/8	718717
W157	1/4	1/4	1/16	718706	W176	1/8	3/8	1/2	725276
W158	1/8	1/4	1/8	725258	W176	1/4	3/8	1/2	718718
W159	1/8	1/4	3/16	725259	W177	1/8	3/8	3/4	725277
W160	1/8	1/4	1/4	725260	W177	1/4	3/8	3/4	718719
W160	1/4	1/4	1/4	718707	W178	1/8	3/8	1	725278
W161	1/8	1/4	5/16	725261	W178	1/4	3/8	1	718720
W161	1/4	1/4	5/16	718708	W180	1/8	1/2	1/32	725280
W162	1/8	1/4	3/8	725262	W181	1/8	1/2	1/16	725281
					W181	1/4	1/2	1/16	718721

Mounted Points

General Purpose – W Shapes – 1/8", 1/4" & 3/8" Shanks (continued)

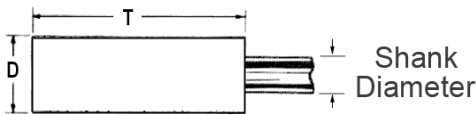
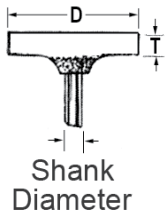

Style	Shank (Inch)	ØD (Inch)	T (Inch)	Code
W182	1/8	1/2	1/8	725282
W182	1/4	1/2	1/8	718722
W183	1/8	1/2	1/4	725283
W183	1/4	1/2	1/4	718723
W184	1/8	1/2	3/8	725284
W184	1/4	1/2	3/8	718724
W185	1/8	1/2	1/2	725285
W185	1/4	1/2	1/2	718725
W186	1/8	1/2	3/4	725286
W186	1/4	1/2	3/4	718726
W187	1/8	1/2	1	725287
W187	1/4	1/2	1	718727
W190	1/8	5/8	1/16	725290
W191	1/8	5/8	1/8	725291
W191	1/4	5/8	1/8	718728
W192	1/8	5/8	1/4	725292
W192	1/4	5/8	1/4	718729
W193	1/8	5/8	3/8	725293
W193	1/4	5/8	3/8	718730
W194	1/8	5/8	1/2	725294
W194	1/4	5/8	1/2	718731
W195	1/8	5/8	3/4	725295
W195	1/4	5/8	3/4	718732
W196	1/8	5/8	1	725296
W198	1/4	5/8	2-1/2	718733
W199	1/8	3/4	1/16	725299
W199	1/4	3/4	1/16	718734
W200	1/8	3/4	1/8	725300
W200	1/4	3/4	1/8	718735
W201	1/8	3/4	1/4	725301
W201	1/4	3/4	1/4	718736
W202	1/8	3/4	3/8	725302
W202	1/4	3/4	3/8	718737
W203	1/8	3/4	1/2	725303
W203	1/4	3/4	1/2	718738
W204	1/8	3/4	3/4	725304
W204	1/4	3/4	3/4	718739
W205	1/8	3/4	1	725305
W205	1/4	3/4	1	718740
W210	1/8	7/8	1/16	725310

Style	Shank (Inch)	ØD (Inch)	T (Inch)	Code
W210	1/4	7/8	1/16	718742
W211	1/8	7/8	1/8	725311
W211	1/4	7/8	1/8	718743
W212	1/8	7/8	1/4	725312
W212	1/4	7/8	1/4	718744
W213	1/8	7/8	3/8	725313
W213	1/4	7/8	3/8	718745
W214	1/8	15/16	1/4	725314
W214	1/4	15/16	1/4	718746
W215	1/8	1	1/8	725315
W215	1/4	1	1/8	718747
W216	1/8	1	1/4	725316
W216	1/4	1	1/4	718748
W218	1/4	1	1/2	725318
W219	1/4	1	3/4	725319
W220	1/4	1	1	725320
W221	1/4	1	1-1/2	725321
W222	1/4	1	2	725322
W223	1/4	1	2-1/2	725323
W224	1/4	1	3	725324
W224	3/8	1	3	718771
W225	1/4	1-1/4	1/4	725325
W226	1/4	1-1/4	3/8	725326
W227	1/4	1-1/4	1/2	725327
W228	1/4	1-1/4	3/4	725328
W229	1/4	1-1/4	1	725329
W230	1/4	1-1/4	1-1/4	725330
W231	1/4	1-1/4	1-1/2	725331
W232	1/4	1-1/4	2	718764
W233	3/8	1-1/4	2-1/2	718772
W234	3/8	1-1/4	3	718773
W235	1/4	1-1/2	1/4	725335
W236	1/4	1-1/2	1/2	725336
W237	1/4	1-1/2	1	725337
W238	1/4	1-1/2	1-1/2	718768
W239	1/4	1-1/2	2	718769
W239	3/8	1-1/2	2	718774
W240	3/8	1-1/2	2-1/2	718775
W241	1/4	1-1/2	3	725341
W241	3/8	1-1/2	3	718776

Mounted Points

General Purpose – A Shapes – 1/4" Shank



Shape	Shank (Inch)	ØD (Inch)	Length (Inch)	Code
A1	1/4	3/4	2-1/2	725101
A2	1/4	1	1-1/4	725102
A3	1/4	1	2-3/4	725103
A4	1/4	1-1/4	1-1/4	725104
A5	1/4	3/4	1-1/8	725105
A6	1/4	3/4	1-1/8	725106
A11	1/4	7/8	2	725111
A12	1/4	11/16	1-1/4	725112
A13	1/4	1-1/8	1-1/8	725113
A14	1/4	11/16	7/8	725114
A15	1/4	1/4	1-1/16	725115
A21	1/4	1	1	725121
A22	1/4	3/4	5/8	725122
A23	1/4	3/4	1	725123

Shape	Shank (Inch)	ØD (Inch)	Length (Inch)	Code
A24	1/4	1/4	3/4	725124
A25	1/4	1	-	725125
A26	1/4	5/8	-	725126
A31	1/4	1-3/8	1	725131
A32	1/4	1	5/8	725132
A33	1/4	1	1/2	725133
A34	1/4	1-1/2	3/8	725134
A35	1/4	1	3/8	725135
A36	1/4	1-5/8	3/8	725136
A37	1/4	1-1/4	1/4	725137
A38	1/4	1	1	725138
A39	1/4	3/4	3/4	725139
A40	1/4	3/4	-	725140

Mounted Points

General Purpose – B Shapes – 1/8" & 1/4" Shanks



Shape	Shank (Inch)	ØD (Inch)	Length (Inch)	Code	Shape	Shank (Inch)	ØD (Inch)	Length (Inch)	Code
B41	1/8	5/8	5/8	725141	B51	1/4	7/16	3/4	718782
B41	1/4	5/8	5/8	718777	B52	1/8	3/8	3/4	725152
B42	1/8	1/2	3/4	725142	B52	1/4	3/8	3/4	718783
B42	1/4	1/2	3/4	718778	B53	1/8	1/4	5/8	725153
B43	1/8	1/4	5/16	725143	B53	1/4	1/4	5/8	718784
B43	1/4	1/4	5/16	718779	B54	1/8	1/4	1/2	725154
B44	1/8	7/32	3/8	725144	B54	1/4	1/4	1/2	718785
B44	1/4	7/32	3/8	718780	B55	1/8	3/8	1/4	725155
B45	1/8	3/16	5/16	725145	B61	1/8	3/4	5/16	725161
B45	1/4	3/16	5/16	718781	B61	1/4	3/4	5/16	718786
B46	1/8	1/8	5/16	725146	B62	1/8	1/2	3/8	725162
B47	1/8	1/8	5/32	725147	B62	1/4	1/2	3/8	718787
B51	1/8	7/16	3/4	725151	B63	1/8	1/4	3/16	725163

Mounted Points

General Purpose – B Shapes – 1/8" & 1/4" Shanks (continued)

Shape	Shank (Inch)	ØD (Inch)	Length (Inch)	Code	Shape	Shank (Inch)	ØD (Inch)	Length (Inch)	Code
B63	1/4	1/4	3/16	718788	B103	1/4	5/8	1/4	718801
B64	1/8	1/4	1/16	725164	B104	1/8	5/16	3/8	725204
B65	1/8	1/8	1/8	725165	B104	1/4	5/16	3/8	718802
B71	1/8	5/8	1/8	725171	B105	1/8	1/4	1/4	725205
B71	1/4	5/8	1/8	718789	B105	1/4	1/4	1/4	718803
B72	1/8	1/2	1/8	725172	B106	1/8	1/8	7/64	725206
B72	1/4	1/2	1/8	718790	B111	1/8	7/16	11/16	725211
B73	1/8	1/2	1/8	725173	B111	1/4	7/16	11/16	718804
B73	1/4	1/2	1/8	718791	B112	1/8	3/8	1/2	725212
B74	1/8	7/32	3/32	725174	B112	1/4	3/8	1/2	718805
B81	1/8	3/4	3/16	725181	B113	1/8	1/4	1/4	725213
B81	1/4	3/4	3/16	718792	B113	1/4	1/4	1/4	718806
B82	1/8	1/2	1/4	725182	B114	1/8	7/32	3/8	725214
B82	1/4	1/2	1/4	718793	B114	1/4	7/32	3/8	718807
B83	1/8	3/8	3/16	725183	B115	1/8	1/8	3/32	725215
B84	1/8	5/16	3/16	725184	B121	1/8	1/2	-	725221
B84	1/4	5/16	3/16	718794	B121	1/4	1/2	-	718808
B90	1/8	1/2	1/2	725190	B122	1/8	3/8	-	725222
B90	1/4	1/2	1/2	718795	B122	1/4	3/8	-	718809
B91	1/8	1/2	5/8	725191	B123	1/8	3/16	-	725223
B91	1/4	1/2	5/8	718796	B123	1/4	3/16	-	718810
B92	1/8	1/4	1/4	725192	B124	1/8	1/8	-	725224
B92	1/4	1/4	1/4	718797	B125	1/8	1/4	-	725225
B93	1/8	3/16	3/16	725193	B131	1/8	1/2	1/2	725231
B93	1/4	3/16	3/16	718798	B131	1/4	1/2	1/2	718811
B94	1/8	11/64	3/32	725194	B132	1/8	3/8	1/2	725232
B95	1/8	1/8	3/16	725195	B132	1/4	3/8	1/2	718812
B96	1/8	1/8	1/4	725196	B133	1/8	3/8	3/8	725233
B97	1/8	1/8	3/8	725197	B133	1/4	3/8	3/8	718813
B98	1/8	3/32	1/4	725198	B134	1/8	5/16	3/8	725234
B101	1/8	5/8	11/16	725201	B134	1/4	5/16	3/8	718814
B101	1/4	5/8	11/16	718799	B135	1/8	1/4	1/2	725235
B102	1/8	5/8	1/2	725202	B135	1/4	1/4	1/2	718815
B102	1/4	5/8	1/2	718800	B136	1/8	1/4	5/16	725236
B103	1/8	5/8	1/4	725203	B136	1/4	1/4	5/16	718816

Diamond Needle Files



604210

Description	Code
Equalling	604200
Round	604201
Square	604202
Three Square	604203
Half Round	604204
5 Piece Set: Equalling, Round, Square, Three Square, Half Round	604205
10 Piece Set: Equalling, Round, Square, Three Square, Half Round, Flat, Crossing, Barette, Marking, Slitting	604210

Steel Needle Files



Description	Code
6 Piece Set – #2 Cut – 2mm x 100mm – Vinyl Pouch	718275
12 Piece Set – #0 Cut – 2mm x 100mm – Vinyl Pouch	718277

Sharpening Stones

- Coarse 120 grit and fine 150 grit combined into one stone
- Size: 1 x 2 x 6 Inch

Material	Code
Aluminum Oxide	604230
Silicon Carbide	604231



Drill Resharpener Machines

For High Speed Steel, Cobalt and Carbide Straight Shank Drills

- Grind HSS, cobalt and carbide straight shank drills from 2-26 mm
(Carbide grinding wheel optional)
- Reduce wear with double-bearing grinding unit
- Precision drill tightening fixture
- Adjustable 85° to 140° point angle



These products evaluated to the model code SPE-1000 by the Electrical Safety Authority



2-13 mm Model DM-213 Code 620001



12-26 mm Model DM-1226 Code 620002

	MODEL DM-213 Code 620001	MODEL DM-1226 Code 620002
DRILL DIAMETER	2 - 13 mm	12 - 26 mm
POINT ANGLE	85°-140°	
POWER SUPPLY	110V	
MOTOR	150 W	373 W
RPM	6000	4000
WEIGHT	10 kg	29 kg
DIMENSIONS L X W X H	305 x 172 x 180 mm	470 x 260 x 235 mm
ER COLLETS INCLUDED	12 pcs. ER20 2.5 mm - 13 mm	15 pcs. ER40 12 mm - 26 mm
CBN DIAMOND WHEEL	1 pc. #200 (HSS drill)	1 pc. #150 (HSS drill)
HEXAGON WRENCH	4 mm and 5 mm	4 mm and 6 mm

Live & Dead Centers

308-318



Lathe Chucks & Accessories

319-368



Turning Tools

369-380



Milling Tools

393-427



Machine Accessories

410-418



Vises & Accessories

419-423



*Dividing Heads
& Indexing Spacers*

424-428



Clamping Components

429-468



Drilling

452-459



Tapping

461-465



Boring

466-467



Fluid Accessories

468-474



Live Centers



High Speed Steel – Main Line | Types N, V, L, A, D-AN

MAIN-LINE: Reliable top of the range live center for CNC and conventional lathes, and grinding machines

- Surface-hardened body
- Ground tapers conform to DIN228AT3
- Through-hardened spindle constructed from high-grade steel
- Spindle mounted by two needle bearings
- Thrust ball bearings to accommodate axial loads
- Over-pressure security through disc springs
- Reliable lip seal
- Continuous lubrication provided by a high quality grease

BODY AND SPINDLE MODELS

- SM | Small body for light pieces and higher turning rate
- ST | Standard for normal loads
- SU | Super for heavy duty loads and low turning rates

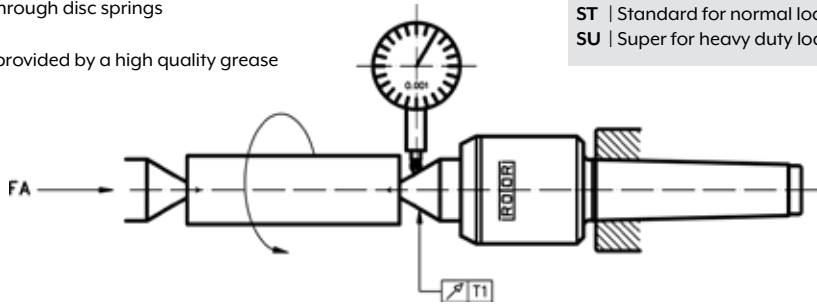

Accuracy of Mainline

Morse Taper	Type	FA daN min.	T1 mm max.	T1 inch max.
1-6 ST	N, V, L, A	20-50	0.005	0.0002
6 SU, 7 SU	N, A	100	0.008	0.0003

Type N – Standard Point 60°

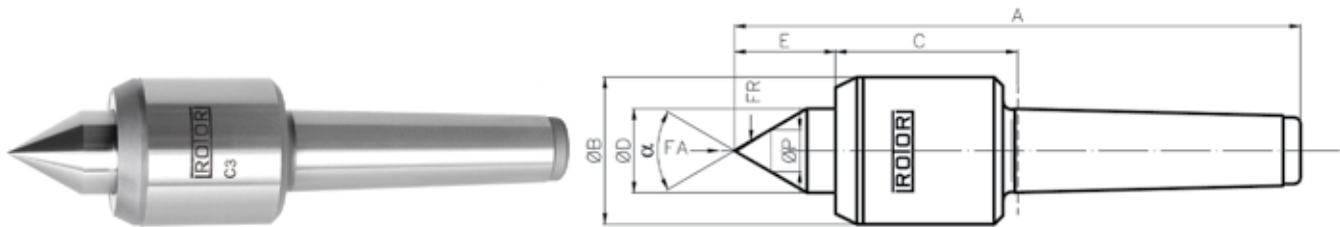

Morse Taper	Model	A (Inch)	B (Inch)	C (Inch)	D (Inch)	E (Inch)	ØP (Inch) C/T Only	Workpiece Maximum (lbs)	Maximum RPM	Code
MT1	1 ST	4.41	1.10	1.54	0.47	0.63	0.28	220	8000	100101
MT2	2 ST	5.16	1.34	1.57	0.63	0.87	0.28	484	7000	100102
MT2	2 SU	5.79	1.65	1.93	0.95	1.14	0.43	704	5800	100112
MT3	3 SM	5.83	1.34	1.57	0.63	0.87	0.28	880	7000	100133
MT3	3 ST	6.56	1.65	1.93	0.95	1.14	0.43	1120	5800	100103
MT3	3 SU	6.93	2.05	2.13	1.18	1.42	0.55	1540	4800	100113
MT4	4 SM	7.32	1.65	1.93	0.95	1.14	0.43	1540	5800	100134
MT4	4 ST	7.80	2.05	2.13	1.18	1.42	0.55	2420	4800	100104
MT4	4 SU	8.35	2.52	2.32	1.58	1.77	0.71	3960	4000	100114
MT5	5 SM	8.94	2.13	2.13	1.18	1.42	0.55	3124	4500	100135
MT5	5 ST	9.53	2.60	2.36	1.58	1.77	0.71	4620	4000	100105
MT5	5 SU	10.55	3.35	3.03	1.97	2.17	0.95	6600	2800	100115
MT6	6 ST	12.67	3.39	3.07	1.97	2.17	0.71	8800	2800	100106
MT6	6 SU	13.98	4.96	4.32	2.36	2.56	0.95	13200	1500	100116
MT7	7 SU	19.06	5.67	5.51	3.15	3.11	1.20	31000	1200	100117

Live Centers



High Speed Steel – Main Line | Types N, V, L, A, D-AN (continued)

Type V – Extended Point 60°

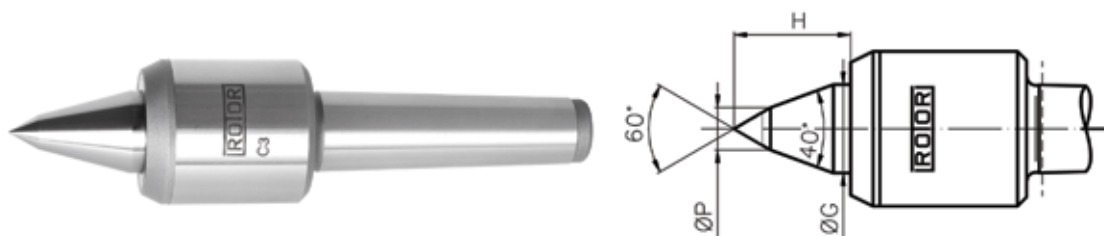

For body dimensions see Main-Line: Type N

Morse Taper	Model	ØG (Inch)	H (Inch)	ØP (Inch)	Workpiece Maximum (lbs)	Maximum RPM	Code
MT1	1 ST	0.47	0.79	0.26	190	8000	100151
MT2	2 ST	0.63	1.02	0.35	390	7000	100152
MT2	2 SU	0.94	1.50	0.39	460	5800	100162
MT3	3 SM	0.63	1.02	0.35	680	7000	100173
MT3	3 ST	0.94	1.50	0.39	970	5800	100153
MT3	3 SU	1.18	1.89	0.55	1450	4800	100163
MT4	4 SM	0.94	1.50	0.39	1150	5800	100174
MT4	4 ST	1.18	1.89	0.55	1900	4800	100154
MT4	4 SU	1.57	2.52	0.59	2400	4000	100164
MT5	5 SM	1.18	1.89	0.55	2300	4500	100175
MT5	5 ST	1.57	2.52	0.59	3200	4000	100155
MT5	5 SU	1.97	3.15	0.71	5300	2800	100165
MT6	6 ST	1.97	3.23	0.71	6800	2800	100156

Type L – Slim Extended Point 60°



For body dimensions see Main-Line: Type N

Morse Taper	Model	ØD (Inch)	E (Inch)	H (Inch)	ØP (Inch)	Workpiece Maximum (lbs)	Maximum RPM	Code
MT2	2 ST	0.63	1.14	0.47	0.23	220	7000	100180
MT3	3 SM	0.63	1.14	0.47	0.23	220	7000	100181
MT3	3 ST	0.94	1.65	0.63	0.31	441	5800	100182
MT4	4 SM	0.94	1.65	0.63	0.31	441	5800	100183
MT4	4 ST	1.18	2.01	0.75	0.39	772	4800	100184
MT5	5 SM	1.18	2.01	0.75	0.39	772	4800	100185
MT5	5 ST	1.57	2.56	0.87	0.46	1190	4000	100186

Live Centers



High Speed Steel – Main Line | Types N, V, L, A, D-AN (continued)

Type A – Morse Taper Point



For body dimensions see Main-Line: Type N

Morse Taper	Model	Shank Dimensions (Inch)		Code	Morse Taper	Model	Shank Dimensions (Inch)		Code
MT1	1 ST	Z1	0.47 x 0.59	100201	5	5 ST	Z3	1.42 x 1.38	100205
MT2	2 SU	Z2	0.94 x 1.18	100212	5	5 SU	Z3	1.42 x 1.38	100215
MT3	3 ST	Z2	0.94 x 1.18	100203	6	6 ST	Z3	1.42 x 1.38	100206
MT3	3 SU	Z2	0.94 x 1.18	100213	6	6 SU	Z4	1.97 x 1.89	100216
MT4	4 ST	Z2	0.94 x 1.18	100204	7	7 SU	Z4	1.97 x 1.89	100217
MT4	4 SU	Z3	1.42 x 1.38	100214					

Cones for Type A Morse Taper Point

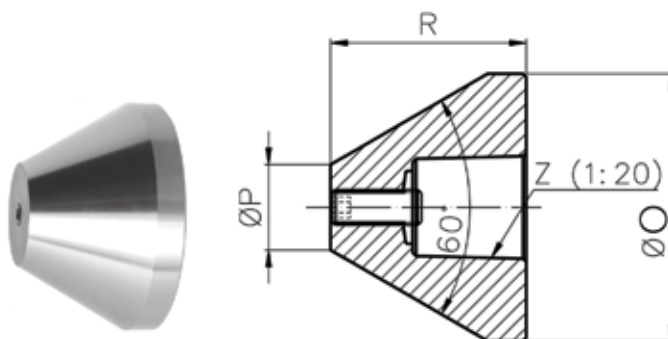

Suitable for...	Shank Dimensions (Inch)		ØO (Inch)	ØP (Inch)	R (Inch)	Code
MT1 ST	Z1	0.47 x 0.59	1.97	0.79	1.38	100421
MT2 SU - MT4 ST	Z2	0.94 x 1.18	2.95	0.94	2.17	100432
MT2 SU - MT4 ST	Z2	0.94 x 1.18	3.94	1.77	2.36	100441
MT2 SU - MT4 ST	Z2	0.94 x 1.18	5.91	2.76	3.15	100452
MT4 SU - MT6 ST	Z3	1.42 x 1.38	3.94	1.77	2.36	100442
MT4 SU - MT6 ST	Z3	1.42 x 1.38	5.91	2.76	3.15	100461
MT4 SU - MT6 ST	Z3	1.42 x 1.38	7.87	4.33	3.54	100481
MT6 SU - MT7SU	Z4	1.97 x 1.77	4.72	1.77	2.95	100451
MT6 SU - MT7SU	Z4	1.97 x 1.77	5.91	2.76	3.15	100462
MT6 SU - MT7SU	Z4	1.97 x 1.77	7.87	4.33	3.54	100482

Live Centers



High Speed Steel – Main Line | Types N, V, L, A, D-AN (continued)

Type DA-N – Standard 60° with Pressure Indicator

APPLICATION: A pressure indicator with different colour bands permits rapid setting and monitoring of the optimum pressure. Length tolerances and different centre bores are compensated through a travel stroke at fixed positions. Correspondingly light work pieces can be clamped very finely.

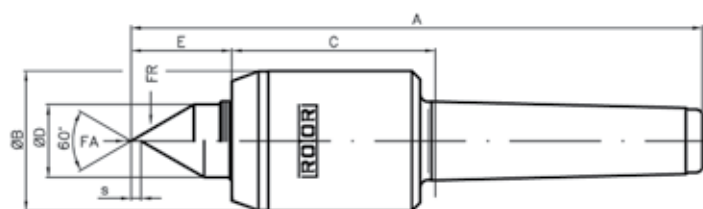

TYPE DA WITH PRESSURE INDICATOR AND LONG TRAVEL STROKE

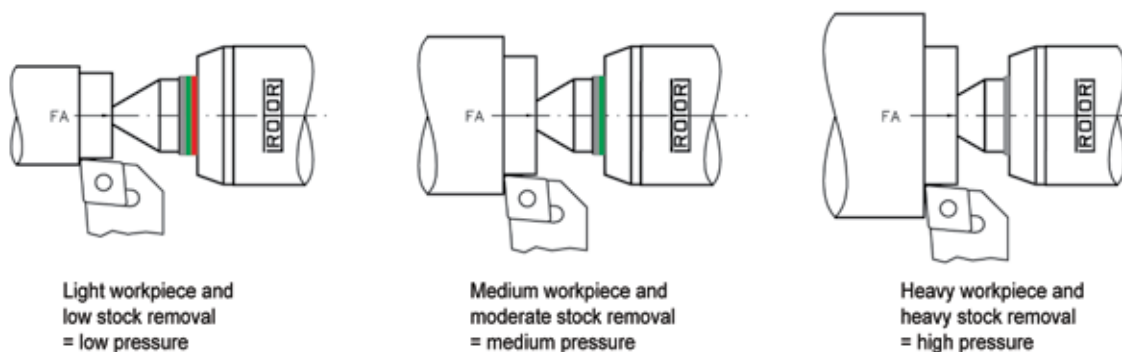

Morse Taper	Model	FA daN	FR daN	A (mm)	ØB (mm)	C (mm)	ØD (mm)	E (mm)	S (mm)	Workpiece Maximum (kgs)	Max RPM	Code
MT2	2 STD.	11-110	24-240	136	34	53	14	19	2.7	190	7000	100090
MT3	3 STD.	20-200	40-420	174	42	62	22	31	3.0	440	5800	100091
MT4	4 STD.	23-230	50-500	209	53	72	28	34	4.3	900	4800	100092
MT5	5 STD.	80-800	150-1500	259	64	87	38	42	5.2	1850	4000	100093
-	cyl. Ø20x40	11-110	24-240	108	34	48	14	19	2.7	190	7000	826375
-	cyl. Ø25x50	20-200	40-420	139	42	58	22	31	3.0	190	5800	826376
-	cyl. Ø1x2	20-200	40-420	139	42	58	22	31	3.0	440	5800	826377
-	cyl. Ø32x63	23-230	50-500	165	53	68	28	33	4.3	900	4800	826378
-	VDI20	11-110	24-240	108	34	48	14	19	2.7	190	7000	826379
-	VDI30	20-200	40-420	144	42	58	22	31	3.0	440	5800	826380
-	VDI40	23-230	50-500	165	53	68	28	34	4.3	900	4800	826381
-	VDI50	80-800	150-1500	201	64	81	38	42	5.2	1850	4000	826382

Live Centers



High Speed Steel – Speed-Line

SPEED-LINE: Precise live centers for high turning rates

- Suitable for CNC/manual turning and grinding machines
- Optimal protection against splash and dirt
- Ground tapers conform to DIN 228 AT3
- Through-hardened 60° point
- Mounted with an angular contact ball bearing and deep grooved ball bearing

Accuracy of Speed-Line

Morse Taper	Tl mm Maximum	Tl inch Maximum
2 ST, 2 SU, 3 ST	0.002	0.0001
3 SU, 4 ST, 4 SU, 5 ST	0.002	0.0001
5 SU, 6 ST	0.004	0.0002

Type EV – 60°

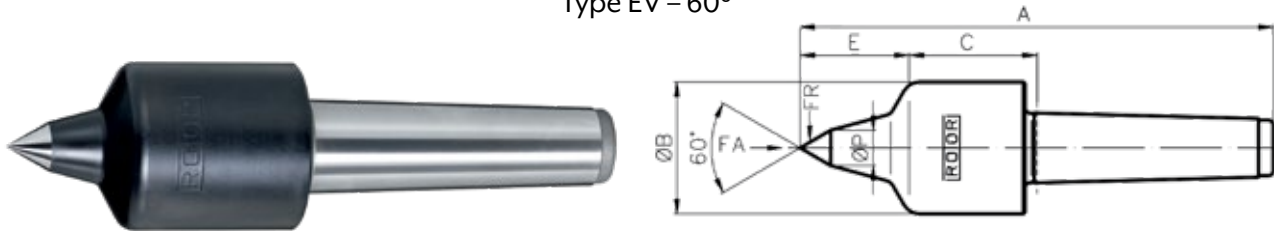

Morse Taper	Model	A (mm)	ØB (mm)	C (mm)	E (mm)	ØP (mm)	Workpiece Maximum (kgs)	FR Maximum daN	FA Maximum daN	Maximum RPM	Code
MT2	2 ST	134	38	38	31	8	180	90	90	13,500	826213
MT2	2 SU	147	45	44	37	12	260	130	115	11,000	826214
MT3	3 ST	164	45	45	37	12	260	130	115	11,000	826215
MT3	3 SU	183	55	61	39	16	440	220	260	8,500	826216
MT4	4 ST	206	55	62	39	16	440	220	260	8,500	826217
MT4	4 SU	233	70	68	50	20	670	335	440	6,700	826218
MT5	5 ST	250	70	70	50	20	670	335	440	6,700	826219
MT5	5 SU	268	82	84	53	20	950	475	925	5,300	826220
MT6	6 ST	322	82	84	53	20	950	475	925	5,300	826221



Live Centers

Bull Nose

- Designed for turning pipes, tubes, and parts with extra-large center holes
- $\pm 0.00005''$ total indicator runout guaranteed
- Two matched angular contact bearings provide good thrust and radial load ratings
- Head diameter is $1/8''$ over nominal size, enabling these centers to cover a wider range of work pieces
- Head and shank are hardened for strength and durability
- Pipe head models also available

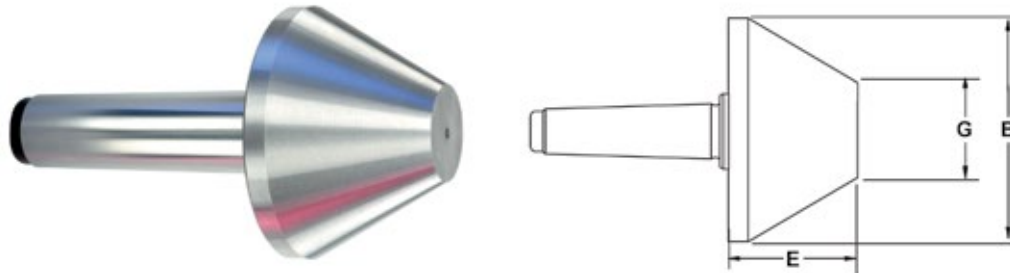

Morse Taper	B (Inch)	E (Inch)	G (Inch)	Maximum RPM	Weight (lbs)	Thrust Load	Code
3	3-1/8	2-1/2	1	5000	615	1780	826341
4	4-1/8	3	1-1/4	4500	860	2550	826343
5	4-1/8	3	1-1/4	4500	860	2550	826344
5	5-1/8	3-3/16	2	4000	1145	3450	826346
5	6-1/8	3-5/8	2-1/2	3500	1450	4500	826347
6	6-1/8	3-5/8	2-1/2	3500	1450	4500	826348

Live Centers

Bull Nose

- Bull Nose - CR-MO steel hardened to RC60
- Combination of roller and ball bearings

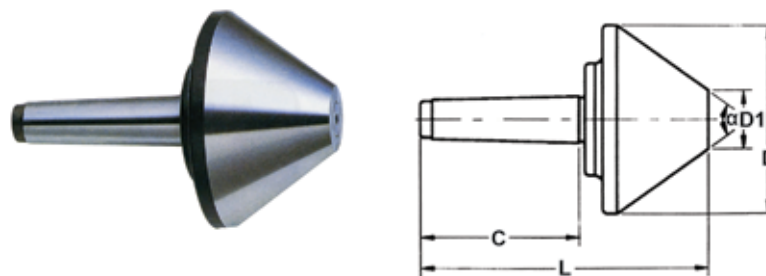

Morse Taper	D Large Diameter (Inch)	D1 Small Diameter (Inch)	L (Inch)	C (Inch)	Included Angle	Load Weight (lbs)	Maximum RPM	Weight (lbs)	Code
2	2.50	0.50	5.50	3.30	60°	450	4000	2	120132
2	3.00	0.75	5.79	3.30	60°	450	4000	2	826359
3	3.00	0.75	6.30	3.78	60°	450	4000	2	826360
3	4.00	1.25	6.30	3.78	70°	800	3300	3	120133
3	5.00	1.38	7.00	3.78	70°	1100	3000	6	826361
4	4.00	1.25	7.08	4.52	70°	1100	3000	7	826362
4	5.00	1.38	7.75	4.52	70°	1400	2000	10	826363
4	6.00	2.00	8.00	4.52	70°	1760	1900	17	120134
5	5.00	1.38	9.00	5.86	70°	1430	2000	13	826364
5	6.00	2.00	9.25	5.86	70°	1760	1900	19	826365
5	8.00	2.00	10.35	5.86	75°	3520	1500	40	120135

Live Centers



High Speed Precision

- A true high-speed live center — up to 12,000 rpm
- Lubricated with lightweight spindle oil instead of grease for reduced turning resistance and lower operating temperatures
- $\pm 0.00005''$ total indicator runout guaranteed
- Three precision angular contact bearings are secured to the point with a locknut to form a rigid, preloaded assembly
- The point extends into the body where it is supported by a needle roller bearing, which further increases rigidity, reduces point deflection, and dampens vibration
- Low profile head provides excellent tool clearance
- Body and point are hardened for strength and durability

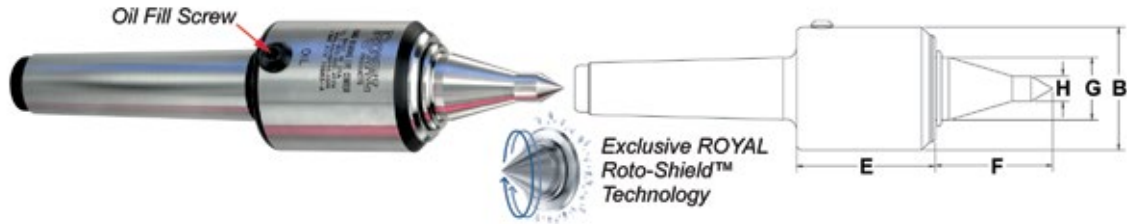

Morse Taper	B (Inch)	E (Inch)	F (Inch)	G (Inch)	H (Inch)	Maximum RPM	Weight (lbs)	Thrust Load	Code
3	1-3/4	2-3/64	1-3/4	7/8	3/8	12000	180	650	826262
4	2-1/2	2-11/16	2-11/32	1-1/4	1/2	12000	525	1380	826263
5	2-1/2	2-11/16	2-11/32	1-1/4	1/2	12000	525	1380	826264

Live Centers



Heavy-Duty Spindle Type – Standard Point & CNC Point

- An excellent heavy-duty live center designed to handle most turning applications
- $\pm 0.00005"$ total indicator runout guaranteed
- Heavy-duty precision bearings provide exceptional thrust and radial load capacities
- The substantial point extends into the shank where it is supported by a large needle bearing for increased strength and rigidity
- Body and point are hardened for strength and durability
- On the CNC model, the extended point provides great tool clearance

Standard Point



Morse Taper	B (Inch)	E (Inch)	F (Inch)	G (Inch)	Maximum RPM	Weight (lbs)	Thrust Load	Code
2	1-3/4	1-7/16	1-1/32	7/8	6000	725	2360	826270
3	2-3/8	1-3/4	1-1/4	1	5000	970	3900	826271
4	2-11/16	1-31/32	1-1/2	1-1/4	4500	1720	4050	826272
5	3-1/2	2-13/16	1-7/8	1-1/2	3500	3260	5700	826273
6	4	3-5/32	2-5/16	2	3500	4080	6000	826274

CNC Point for Extra Tool Clearance

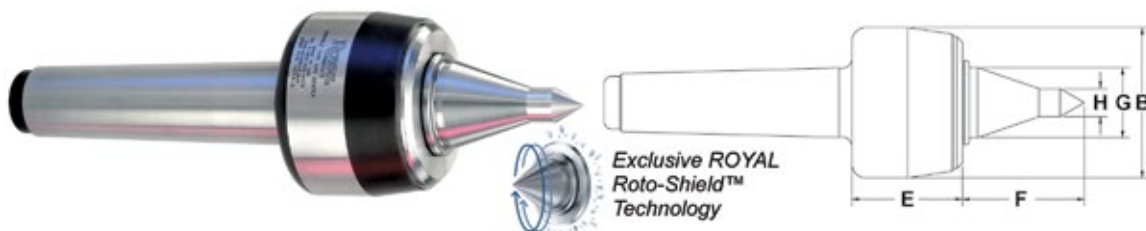

Morse Taper	B (Inch)	E (Inch)	F (Inch)	G (Inch)	H (Inch)	Maximum RPM	Weight (lbs)	Thrust Load	Code
2	1-3/4	1-7/16	1-3/8	7/8	3/8	6000	375	2360	826275
3	2-3/8	1-3/4	1-7/8	1	3/8	5000	740	3900	826276
4	2-11/16	1-31/32	2-7/32	1-1/4	1/2	4500	1120	4050	826277
5	3-1/2	2-13/16	2-5/8	1-1/2	1/2	3500	1930	5700	826278

Live Centers



High Precision Quad-Bearing – Standard Point & CNC Point

- Great for grinding and tight tolerance turning
- ± 0.00005 " total indicator runout guaranteed
- Three precision angular contact bearings are secured to the point with a locknut to form a rigid, preloaded assembly
- The point extends into the body where it is supported by a needle roller bearing, which further increases rigidity, reduces point deflection, and dampens vibration
- Low profile head provides excellent tool clearance
- Body and point are hardened for strength and durability

Standard Point



Morse Taper	B (Inch)	E (Inch)	F (Inch)	G (Inch)	Maximum RPM	Weight (lbs)	Thrust Load	Code
3	1-3/4	2-1/8	1-1/16	7/8	6000	885	1270	826279
4	2-1/2	2-3/4	1-1/2	1-1/4	5000	2240	2150	826280
5	2-1/2	2-3/4	1-1/2	1-1/4	5000	2240	2150	826281
* 5 HD	3-7/8	3-7/8	2-5/16	2	3000	5240	5300	826282
* 6 HD	3-7/8	3-7/8	2-5/16	2	3000	5240	5300	826283

*Heavy Duty

CNC Point for Extra Tool Clearance



Morse Taper	B (Inch)	E (Inch)	F (Inch)	G (Inch)	H (Inch)	Maximum RPM	Weight (lbs)	Thrust Load	Code
3	1-3/4	2-1/8	1-3/4	7/8	3/8	6000	465	1270	826284
4	2-1/2	2-25/32	2-11/32	1-1/4	1/2	5000	1230	2150	826285
5	2-1/2	2-25/32	2-11/32	1-1/4	1/2	5000	1230	2150	826286

Live Centers



Spring Type – Standard Point

- Unique spring-loaded point compensates for work piece thermal expansion
- $\pm 0.00005"$ total indicator runout guaranteed
- Low-profile design provides outstanding tool clearance
- Heavy disc springs ensure that the point remains seated in the work piece
- Point and shank are hardened for strength and durability

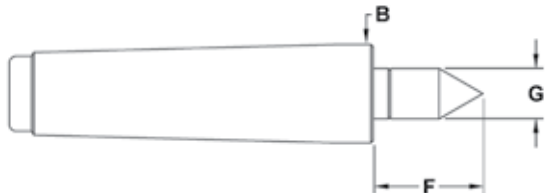

Morse Taper	B (Inch)	F (Inch)	G (Inch)	Spring Travel (Inch)	Maximum RPM	Weight (lbs)	Thrust Load	Code
2	0.700	7/8	3/8	0.11	5000	540	150	826349
3	0.938	1-5/32	9/16	0.14	5000	940	315	826350
4	1.231	1-3/8	5/8	0.18	4500	1400	435	826351
5	1.748	2	1-3/32	0.19	4500	2340	785	826352

Versa-Turn

- A great multi-purpose live center designed to handle most common turning jobs-
 - Extended point provides good tool clearance
 - Bull head is great for tubes and parts with large center holes
- $\pm 0.00005"$ total indicator runout guaranteed on both sections of rotating point
- The Royal Versa-Turn is extremely free turning excellent for thin parts that cannot take high thrust loads
- Head and shank are hardened for strength and durability

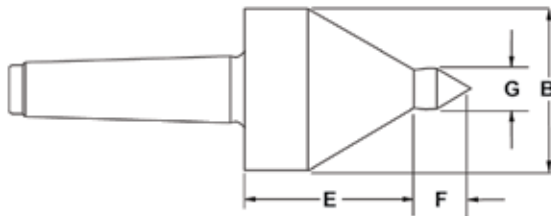

Morse Taper	B (Inch)	E (Inch)	F (Inch)	G (Inch)	Maximum RPM	Weight (lbs)	Thrust Load	Code
2	2-1/8	2-7/32	3/4	1/2	5000	330	2160	826353
3	2-1/8	2-7/32	3/4	1/2	5000	330	2160	826354
* 3 HD	2-1/2	2-5/8	15/16	5/8	4000	685	5000	826355
4	2-1/2	2-5/8	15/16	5/8	4000	685	5000	826356
* 4 HD	3-3/8	3-1/8	1-1/8	3/4	3500	1165	5700	826357
5	3-3/8	3-1/8	1-1/8	3/4	3500	1165	5700	826358

*Heavy Duty

Live Center Sets

7 Interchangeable Points

- Construction consists of double rows of ball bearings and thrust bearings
- Ground for higher accuracy
- 60° point

SET INCLUDES:

- 5 male centers
- 1 female center
- 1 bull center
- 1 extractor
- Supplied In fitted storage case

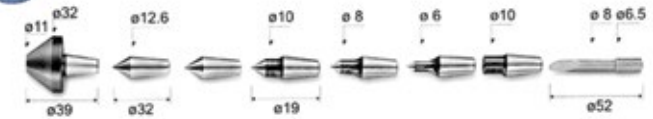
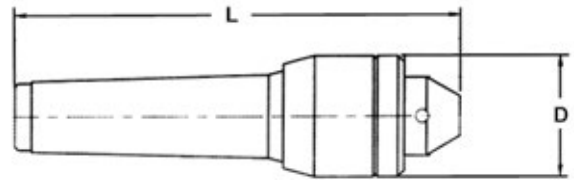

Morse Taper	D Outside Diameter (Inch)	L Length (Inch)	Code
2	1.57	5.20	120122
3	1.81	6.22	120123
4	1.81	7.08	120124
5	2.50	9.21	120125

Dead Centers

Solid Centers – High Speed Steel & Carbide Tipped



Morse Taper	HSS	Carbide Tipped
	Code	Code
1	125101	125111
2	125102	125112
3	125103	125113
4	125104	125114
5	125105	125115
6	125106	125116

Dead Centers with Nut

Solid Centers – Alloy Steel & Carbide Tipped

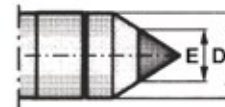
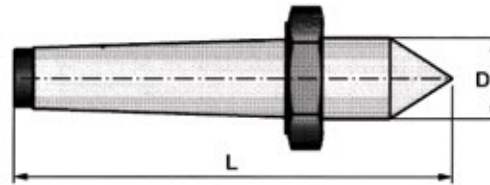

Morse Taper	L (Inch)	D (Inch)	Spare Nut		Series 8725 Alloy Steel	Series 8726 Carbide Tipped	
			Size (Inch)	Code	Code	E (Inch)	Code
1	3.54	0.48	0.94	826335	826323	0.28	826329
2	4.41	0.71	1.26	826336	826324	0.28	826330
3	5.43	0.95	1.61	826337	826325	0.43	826331
4	6.89	1.24	2.17	826338	826326	0.55	826332
5	8.54	1.76	2.95	-	826327	0.71	826333
6	11.42	2.51	3.94	826340	826328	0.71	826334



Lathe Chuck Technical Information

Determining Proper Spindle Nose Type & Size

NOTE: Bison chucks meet all requirements of ASA Standard B5.9-1960. For spindle nose accuracy (T.I.R.)

Selecting the Chuck Mount

Choose from the types shown below:

- For the short taper spindle noses Type A, D and C (DIN) measure the pilot diameter and length (sizes B and C), bolt circle diameter (size F1 and F2) and diameter of the holes (size E1 and E2). In the case of Type A mount check the number of bolt circles (one for A2 mount or two for A1 mount). All chucks with A1 mount can be installed on A1 spindle nose only. All chucks with A2 mount can be installed on A1 or A2 spindle noses.
- For the long taper spindle noses Type L, check pilot diameter, length and thread size (size A, C and B)
- For the threaded spindle noses, check the thread diameter, number of threads per inch and length (sizes A and E), pilot diameter and length (sizes B and D), plus overall length (size F1)

Spindle Type A1 & A2

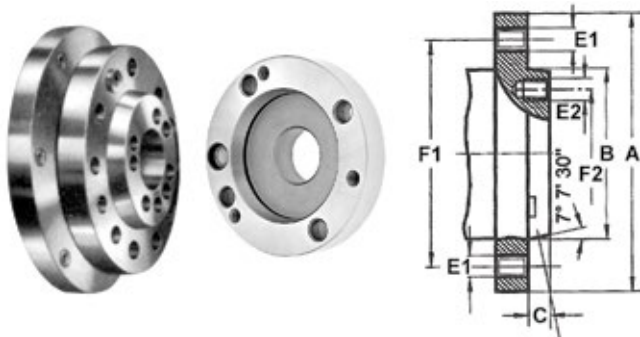

Spindle Nose	F1	F2	B	C Maximum	Thread E1=E2 UNC-3B
A4	3.250	-	2.5005 + 0.0005	0.4375	7/16 - 14
A5	4.125	2.4374	3.2505 + 0.0005	0.5625	7/16 - 14
A6	5.250	3.2500	4.1880 + 0.0005	0.6250	1/2 - 13
A8	6.750	4.3750	5.5007 + 0.0005	0.6875	5/8 - 11
A11	9.250	6.5000	7.7507 + 0.0005	0.7500	3/4 - 10
A15	13.000	9.7500	11.2510 + 0.0010	0.8125	7/8 - 9
A20	18.250	14.5000	16.2510 + 0.0010	0.8750	1 - 6

TYPE A1 is exactly as shown with tapped holes in both inner and outer bolt circles.

TYPE A2 is same as shown except omit holes in inner bolt circle.

Spindle Type D1 – Camlock

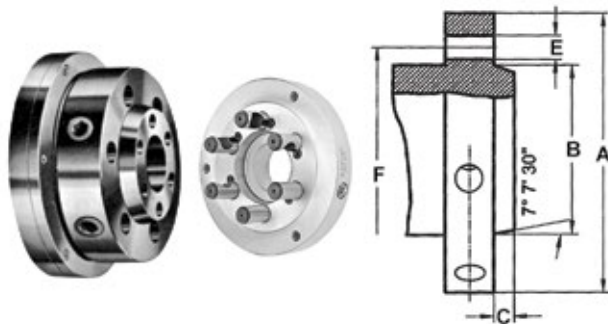

Spindle Nose	A	F	B	C Maximum	E	No. of Holes
DI-3	3.622	2.7820	2.1250 + 0.00025	7/16	0.5938	3
DI-4	4.606	3.2500	2.5005 + 0.00050	7/16	0.6562	3
DI-5	5.748	4.1250	3.2505 + 0.00050	1/2	0.8750	6
DI-6	7.126	5.2500	4.1880 + 0.00050	9/16	1.0000	6
DI-8	8.858	6.7500	5.5007 + 0.00050	5/8	1.1250	6
DI-11	11.732	9.2520	7.7507 + 0.00050	11/16	1.2500	6
DI-15	15.866	13.0000	11.2510 + 0.0010	3/4	1.3750	6

NOTE: Camlock stud length is adjustable to suit spindle cam

Threaded Spindle

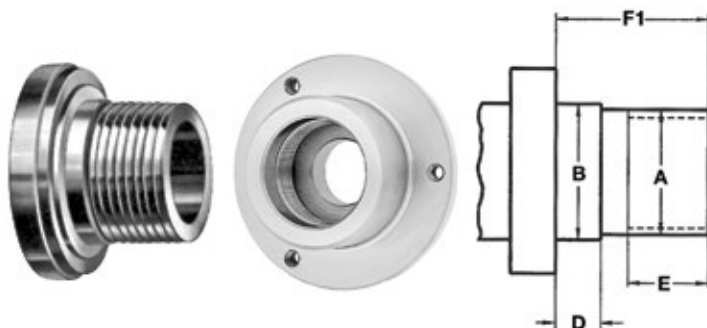

A Spindle Nose	B	F1	D	E
1 - 10 UNS-2B	1.0150	1.5000	0.4375	1.0000
1-1/2 - 8 UN-2B	1.5150	1.5000	0.4375	1.0000
2-3/16 - 10 UN-2B	2.2025	1.7500	0.5625	1.1250
2-1/4 - 8 UN-2B	2.2600	1.7500	0.5625	1.1250
2-3/16 - 6 UN-2B	2.2025	1.7500	0.5625	1.1250
2-3/4 - 8 UN-2B	2.7600	2.0625	0.6875	1.3125

Lathe Chuck Technical Information

Determining Proper Spindle Nose Type & Size (*continued*)



Spindle Type C – DIN Standard 55027

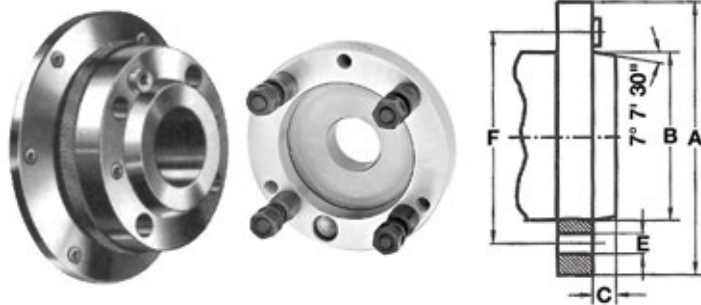

Spindle Nose	F	B	C Maximum	E	No. of Holes
C4	3.2500	2.50050	0.4331	0.83	3
C5	4.1250	3.25050	0.5118	0.83	4
C6	5.2500	4.18800	0.5512	0.91	4
C8	6.7500	5.50075	0.6299	1.14	4
C11	9.2520	7.75075	0.7087	1.42	6

This spindle nose is provided with a short tapered flange like the American spindle noses A and D. Spindle flange has a number of mounting holes (3, 4 or 6) into which the lock studs of the chuck can be inserted and locked.

Spindle Type L – Long Taper Key Drive

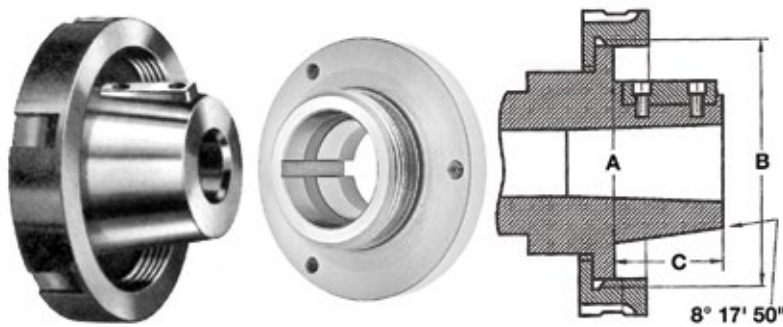

Spindle Nose	B Thread	C	A	Key
L00	3-3/4 - 6	2	2.750	3/8 x 3/8 x 1-1/2
L0	4-1/2 - 6	2-3/8	3.250	3/8 x 3/8 x 1-3/4
L1	6 - 6	2-7/8	4.125	5/8 x 5/8 x 2-3/8
L2	7-3/4 - 5	3-3/8	5.250	3/4 x 3/4 x 2-7/8
L3	10-3/8 - 4	3-7/8	6.500	1 x 1 x 3-1/4



Lathe Chuck Grease

- 16 oz. can
- For manual and power chucks, fasteners, press fits, wear-in guides and ways

Code

355326



Universal Lathe Chucks

Cast Iron – 2-Piece Jaws – 3-Jaw Self-Centering

Plain Back – Series 3205

- Cast iron
- Plain back (Back plates required)
- Ground working surfaces

Standard Accessories:

- 1 set of hard top jaws
- 1 set of hard master jaws
- 1 wrench
- 1 hex key

See 322 for Clamping Ranges

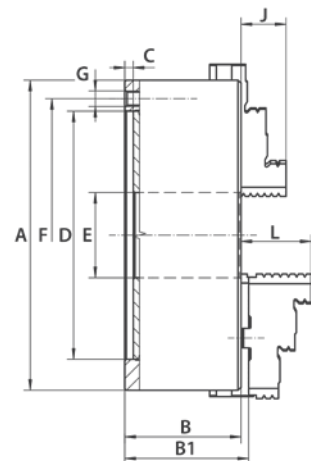

A (Inch)	B (Inch)	B1 (Inch)	C (Inch)	D H7 (Inch)	E (Inch)	F (Inch)	G	J (Inch)	L (Inch)	Weight (lbs)	Code
4.92	2.20	2.39	0.16	3.74	1.26	4.25	3 x M8	0.79	1.57	11.02	355000
6.30	2.54	2.73	0.16	4.92	1.65	5.51	6 x M10	1.26	1.69	22.05	355001
7.87	2.95	3.14	0.16	6.30	2.17	6.93	6 x M10	1.14	1.77	38.58	355002
9.84	3.35	3.50	0.20	7.87	2.99	8.82	6 x M12	1.34	2.09	63.93	355003
12.40	3.70	3.90	0.20	10.24	4.06	11.26	6 x M16	1.69	2.24	110.23	355004
15.75	4.13	4.48	0.20	12.99	5.35	14.25	6 x M16	2.17	2.64	187.39	355005
19.69	4.72	5.15	0.20	16.54	7.48	18.03	6 x M16	2.36	3.11	319.67	355006
24.80	5.31	5.76	0.28	21.46	9.92	23.07	6 x M16	2.76	3.43	551.16	355007

Plain Back – Large Diameter – Series 3205

See 322 for Clamping Ranges

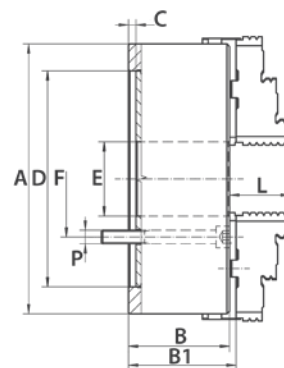

A (Inch)	B (Inch)	B1 (Inch)	C (Inch)	D H7 (Inch)	E (Inch)	F (Inch)	P	L (Inch)	Weight (lbs)	Taper (optional)	Code
31.50	5.51	5.96	0.47	14.96	11.08	13.00	6 x M24	3.43	848	8 11 15	355008

Universal Lathe Chucks



Clamping Ranges for Hard 2-Piece Jaws

- Do not exceed the maximum allowable clamping ranges



3-Jaw & 4-Jaw Scroll Chucks – Hard 2pc. Jaws – Series 32**, 35**, 36**, 37**

Chuck Diameter (Inch)	d1 (Inch)	d2 (Inch)	d3 (Inch)	d4 (Inch)	d5 (Inch)	Maximum Swing Diameter (Inch)
5	0.12 - 1.97	2.05 - 3.78	3.75 - 4.92	1.34 - 2.99	2.95 - 4.65	5.94
6	0.12 - 2.52	2.44 - 4.76	4.53 - 6.3	1.65 - 3.82	3.46 - 5.75	8.03
8	0.16 - 3.54	2.83 - 6.14	5.24 - 7.87	1.97 - 5.12	4.13 - 7.48	9.69
10	0.2 - 4.65	3.39 - 7.76	6.3 - 9.84	2.28 - 6.5	4.92 - 9.25	12.05
12	0.39 - 5.16	4.06 - 8.9	7.48 - 12.4	2.56 - 7.17	5.7 - 10.4	15.12
16	0.4 - 7.1	5 - 11.6	9.1 - 15.7	2.8 - 9	6.5 - 13	18.58
20	0.8 - 9.3	4.3 - 15.7	7.5 - 19.7	4.7 - 16.1	7.9 - 19.1	23.62
25	1.2 - 13.2	4.7 - 22.4	7.9 - 24.8	5.5 - 23.2	8.3 - 24.8	30.31
32	5.9 - 19	9.4 - 28.5	12.4 - 31.5	9.9 - 29	12.9 - 31.5	37.01

Cast Iron – 2-Piece Jaws – 3-Jaw Self-Centering

Type A – Series 3215

- Cast iron
- Direct mount
- Ground working surfaces

Standard Accessories:

- 1 set of hard top jaws
- 1 set of hard master jaws
- 1 wrench

See 322 for Clamping Ranges

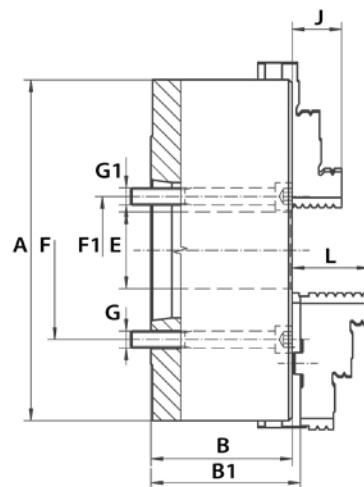

A (Inch)	Taper Size	B (Inch)	B1 (Inch)	E (Inch)	F (Inch)	F1 (Inch)	No. of Bolts	G	G1	J (Inch)	L (Inch)	Weight (lbs)	Code
6.30	5	3.21	3.40	1.65	-	2.44	3	-	7/16-14	0.63	1.69	22.05	355009
7.87	5	3.58	3.77	1.65	-	2.44	3	-	7/16-14	1.14	1.77	41.89	355010
7.87	6	3.58	3.77	2.17	-	3.25	3	-	1/2-13	1.14	1.77	41.89	355011
9.84	5	4.07	4.22	2.99	4.13	-	6	7/16-14	-	1.34	2.09	70.55	355012
12.40	6	4.63	4.83	4.06	5.25	-	6	1/2-13	-	1.69	2.24	121.25	355015
12.40	8	4.63	4.83	3.15	-	4.37	6	-	5/8-11	1.69	2.24	121.25	355016
15.75	6	5.06	5.41	4.06	5.25	-	6	1/2-13	-	2.17	2.64	202.83	355017
15.75	11	5.06	5.41	5.12	-	6.50	6	-	3/4-10	2.17	2.64	202.83	355018
19.69	11	5.75	6.19	7.48	9.25	-	6	3/4-10	-	2.36	3.11	352.74	355019
24.80	11	6.50	6.92	7.48	9.25	-	6	3/4-10	-	2.76	3.43	628.32	355020
24.80	15	6.50	6.92	7.48	-	9.75	6	-	7/8-9	2.76	3.43	628.32	355021



Universal Lathe Chucks

Cast Iron – 2-Piece Jaws – 3-Jaw Self-Centering

Type D – Series 3245

- Cast iron
- Direct mount
- Ground working surfaces

Standard Accessories:

- 1 set of hard top jaws
- 1 set of hard master jaws
- 1 wrench

See 322 for Clamping Ranges

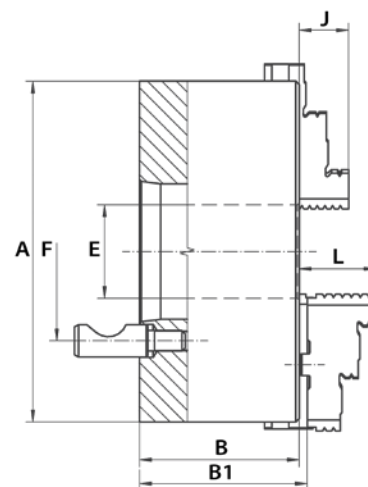

LATHE CHUCKS & ACCESSORIES

A (Inch)	Taper Size	B (Inch)	B1 (Inch)	E (Inch)	F (Inch)	No. of Stud Bolts	J (Inch)	L (Inch)	Weight (lbs)	Code
4.92	4	2.76	2.94	1.26	3.25	3	0.79	1.57	11.02	355023
6.30	3	3.21	3.40	1.65	2.78	3	1.26	1.69	19.84	355024
6.30	4	3.21	3.40	1.65	3.25	3	1.26	1.69	19.84	355025
6.30	3	3.21	3.40	1.65	2.78	3	1.26	1.69	19.84	355026
7.87	4	3.58	3.77	2.03	3.25	3	1.14	1.77	41.89	355027
7.87	5	3.58	3.77	2.17	4.13	6	1.14	1.77	41.89	355028
7.87	6	3.58	3.77	2.17	5.25	6	1.14	1.77	41.89	355029
7.87	5	3.58	3.77	2.17	4.13	6	1.14	1.77	41.89	355030
9.84	6	4.07	4.22	2.99	5.25	6	1.34	2.09	70.55	355031
9.84	8	4.07	4.22	2.99	6.75	6	1.34	2.09	70.55	355032
12.40	6	4.63	4.83	4.06	5.25	6	1.69	2.24	112.44	355033
12.40	8	4.63	4.83	4.06	6.75	6	1.69	2.24	112.44	355034
12.40	11	4.92	5.12	4.06	9.25	6	1.69	2.24	112.44	355035
15.75	6	5.06	5.41	4.06	5.25	6	2.17	2.64	222.67	355036
15.75	8	5.06	5.41	5.35	6.75	6	2.17	2.64	222.67	355037
15.75	11	5.06	5.41	5.35	9.25	6	2.17	2.64	222.67	355038
19.69	8	5.75	6.17	5.35	6.75	6	2.36	3.11	330.69	355039
19.69	11	5.75	6.17	7.48	9.25	6	2.36	3.11	330.69	355040
24.80	11	6.50	6.94	7.48	9.25	6	2.75	3.43	604.07	355041

Universal Lathe Chucks

Cast Iron – 2-Piece Jaws – 3-Jaw Self-Centering



Threaded – Series 3285

- Cast iron
- Ground working surfaces

Standard Accessories:

- 1 set of hard top jaws
- 1 set of hard master jaws
- 1 wrench

See 322 for Clamping Ranges

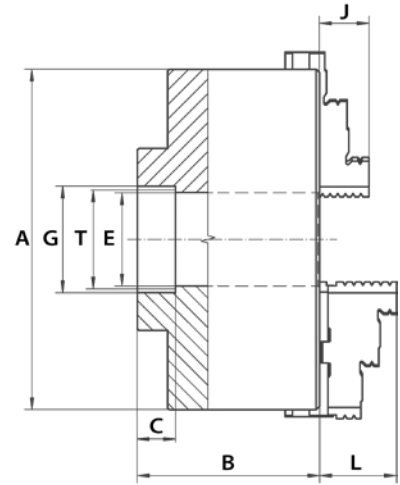

A (Inch)	B (Inch)	C (Inch)	E (Inch)	G (Inch)	J (Inch)	L (Inch)	T (Inch)	Weight (lbs)	Code
4.92	3.74	0.500	1.26	1.015	–	1.57	1 - 10	12.0	355055
4.92	3.74	0.500	1.26	1.515	–	1.57	1-1/2 - 8	12.0	355056
6.30	4.13	0.500	1.65	1.515	–	1.69	1-1/2 - 8	23.0	355057
6.30	4.33	0.625	1.65	2.260	–	1.69	2-1/4 - 8	23.0	355058
7.87	4.53	0.500	2.17	1.515	–	1.77	1-1/2 - 8	45.0	355059
7.87	4.72	0.625	2.17	2.260	–	1.77	2-1/4 - 8	45.0	355060
7.87	4.92	0.750	2.17	2.385	–	1.77	2-3/8 - 6	45.0	355061
9.84	5.51	0.625	2.99	2.260	–	2.09	2-1/4 - 8	78.0	355062



Universal Lathe Chucks

Cast Iron – 2-Piece Jaws – 3-Jaw Self-Centering

Oil Country Chucks– Plain Back – Series 3295

- Cast iron
- With large through-hole designed for gripping long work pieces or pipes during machining
- Hardened and ground working surfaces
- High gripping force
- High accuracy
- Chucks can work individually or in pairs, mounted on opposite sides of the lathe spindle

Standard Accessories:

- 1 set of soft top jaws
- 1 set of hard master jaws
- 1 wrench

See 322 for Clamping Ranges

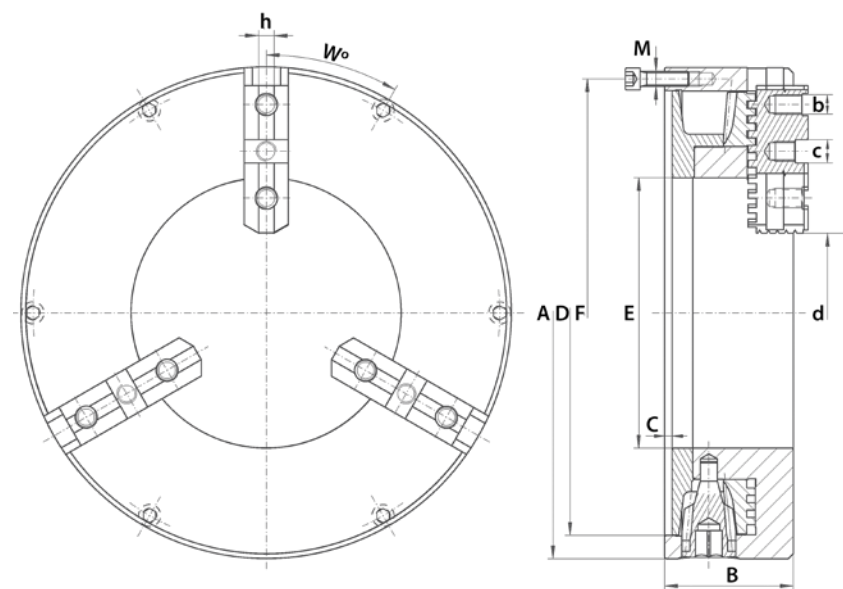
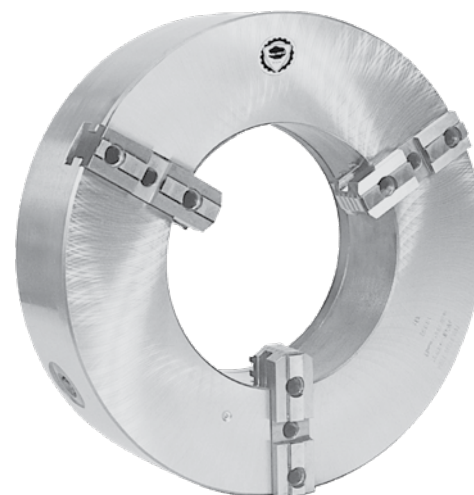

A (Inch)	B (Inch)	C (Inch)	D (Inch)	E (Inch)	F (Inch)	M	W	a (Inch)	b	c (Inch)	h (Inch)	d Clamping Range (Inch)	Max RPM	Weight (lbs)	Code
15.75	4.13	0.24	14.25	8.66	15.00	6 x M12	30°	4.72	5/8-11	0.75	0.5	5.43 - 10.08	500	127.21	355065
20.00	4.72	0.31	18.19	12.60	18.96	6 x M16	30°	4.72	3/4-10	0.75	0.5	9.84 - 14.96	350	167.11	355066
25.98	5.31	0.55	22.83	15.98	24.41	6 x M16	30°	5.00	3/4-10	0.75	0.5	14.80 - 19.57	250	284.18	355067

LATHE CHUCKS & ACCESSORIES

Universal Lathe Chucks

Cast Iron – Solid Jaws – 3-Jaw Self-Centering



Plain Back – Series 3204

- Cast iron
- Plain back (Backplates required)
- Ground working surfaces

Standard Accessories:

- 1 set of hard solid ID jaws
- 1 set of hard solid OD jaws
- 1 wrench
- 1 hex key

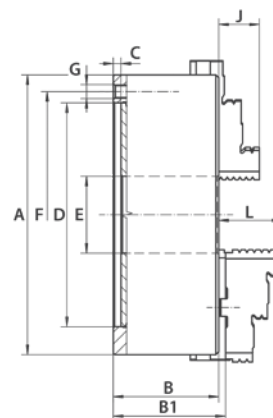

See 336 for Clamping Ranges

A (Inch)	B (Inch)	BI (Inch)	C (Inch)	D H7 (Inch)	E (Inch)	F (Inch)	G	J (Inch)	L (Inch)	Weight (lbs)	Code
3.15	1.73	-	0.12	2.20	0.63	2.64	3 x M6	0.51	-	3.31	355068
3.94	1.97	-	0.12	2.76	0.79	3.27	3 x M8	0.63	-	6.17	355069
4.92	2.20	2.39	0.16	3.74	1.26	4.25	3 x M8	0.79	1.57	11.02	355070
6.30	2.54	2.73	0.16	4.92	1.65	5.51	6 x M10	1.26	1.69	22.05	355071
7.87	2.95	3.14	0.16	6.30	2.17	6.93	6 x M10	1.14	1.77	38.58	355072
9.84	3.35	3.50	0.20	7.87	2.99	8.82	6 x M12	1.34	2.09	63.93	355073
12.40	3.70	3.90	0.20	10.24	4.06	11.26	6 x M16	1.69	2.24	110.23	355074
15.75	4.13	4.48	0.20	12.99	5.35	14.25	6 x M16	2.17	2.64	187.39	355075
19.69	4.72	5.15	0.20	16.54	7.48	18.03	6 x M16	2.36	3.11	319.67	355076
24.80	5.31	5.76	0.28	21.46	9.92	23.07	6 x M16	2.76	3.43	551.16	355077

Clamping Ranges for Hard Solid Jaws

- Do not exceed the maximum allowable clamping ranges



3-Jaw & 4-Jaw Scroll Chucks – Hard Solid Jaws – Series 32**, 35**, 36**, 37**

Chuck Diameter (Inch)	d1 (Inch)	d2 (Inch)	d3 (Inch)	d4 (Inch)	d5 (Inch)	Maximum Swing Diameter (Inch)
3	0.08 - 1.06	0.98 - 1.97	1.89 - 2.8	0.87 - 1.81	1.77 - 2.72	3.54
4	0.12 - 1.3	1.26 - 2.44	2.44 - 3.66	0.98 - 2.2	2.2 - 3.43	4.51
5	0.12 - 1.97	1.54 - 3.27	3.15 - 4.92	1.34 - 2.91	2.83 - 4.53	5.94
6	0.12 - 2.52	1.97 - 4.21	3.86 - 6.3	1.65 - 3.94	3.7 - 6.06	8.03
8	0.16 - 3.54	2.36 - 5.71	5.12 - 7.87	2.05 - 5.31	4.72 - 7.95	9.69
10	0.2 - 4.6	3 - 7.4	6.3 - 9.8	2.4 - 6.9	5.7 - 10.1	12.05
12	0.4 - 5.2	3.5 - 8.5	7.5 - 12.4	3.1 - 7.9	6.8 - 11.8	15.12
16	0.4 - 7.1	4.1 - 10.7	9.1 - 15.7	3.3 - 9.9	8.3 - 15	18.58
20	0.8 - 9.3	5.5 - 14.1	10.9 - 19.7	4.7 - 13.2	9.6 - 18.7	23.62
25	1.2 - 13.2	7.1 - 19.2	13.9 - 24.8	6.3 - 18.3	12.8 - 24.8	30.31
32	5.9 - 19	11.9 - 25	18.4 - 31.5	11.1 - 24.2	17.6 - 30.7	37.01



Precision Lathe Chucks

Steel – 2-Piece Jaws – 3-Jaw Self-Centering

Plain Back – Series 3505

- Steel
- Plain back (Backplates required)
- Hardened and ground working surfaces
- Balanced scroll plate
- Chucks with 20" diameter and above have additional T-slots

Standard Accessories:

- 1 set of hard top jaws
- 1 set of hard master jaws
- 1 wrench
- 1 hex key

See 322 for Clamping Ranges

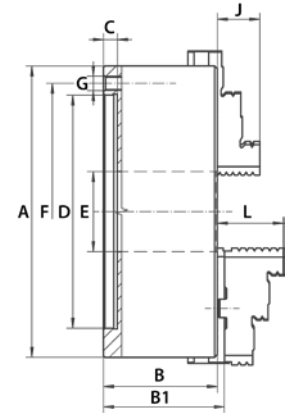

A (Inch)	B (Inch)	B1 (Inch)	C (Inch)	D H7 (Inch)	E (Inch)	F (Inch)	G	J (Inch)	L (Inch)	Weight (lbs)	Code
4.92	2.34	2.53	0.16	3.74	1.40	4.25	3 x M8	20	0.79	1.57	355089
6.30	2.68	2.87	0.16	4.92	1.65	5.51	6 x M10	32	1.26	1.69	355090
7.87	3.07	3.26	0.16	6.30	2.17	6.93	6 x M10	29	1.14	1.77	355091
9.84	3.50	3.65	0.20	7.87	2.99	8.82	6 x M12	34	1.34	2.09	355092
12.40	3.79	3.99	0.20	10.24	4.06	11.26	6 x M16	43	1.69	2.24	355093
15.75	4.29	4.60	0.20	12.99	5.35	14.25	6 x M16	55	2.17	2.64	355094
19.69	4.69	5.11	0.20	16.54	7.48	18.03	6 x M16	60	2.36	3.11	355095
24.80	5.08	5.52	0.28	21.46	9.92	23.07	6 x M16	70	2.76	3.43	355096

Type D – Series 3545

- Steel
- Direct mount
- Hardened and ground working surfaces
- Balanced scroll plate
- Chucks with 20" diameter and above have additional T-slots

Standard Accessories:

- 1 set of hard top jaws
- 1 set of hard master jaws
- 1 wrench

See 322 for Clamping Ranges

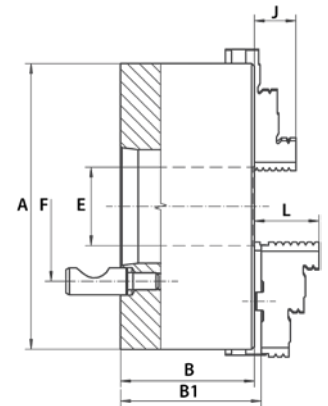

A (Inch)	Taper Size	B (Inch)	B1 (Inch)	E (Inch)	F (Inch)	No. of Stud Bolts	J (Inch)	L (Inch)	Weight (lbs)	Code
6.30	3	3.21	3.40	1.65	2.78	3	1.26	1.69	19.84	355097
6.30	4	3.21	3.40	1.65	3.25	3	1.26	1.69	19.84	355098
6.30	5	3.21	3.40	1.65	4.13	6	1.26	1.69	19.84	355099
7.87	5	3.58	3.77	2.17	4.13	6	1.14	1.77	41.89	355100
7.87	6	3.58	3.77	2.17	5.25	6	1.14	1.77	41.89	355101
9.84	6	4.07	4.22	2.99	5.25	6	1.34	2.09	70.55	355102
9.84	8	4.07	4.22	2.99	6.75	6	1.34	2.09	70.55	355103
12.40	6	4.63	4.83	4.06	5.25	6	1.69	2.24	112.44	355104
12.40	8	4.63	4.83	4.06	6.75	6	1.69	2.24	112.44	355105
12.40	11	4.92	5.12	4.06	9.25	6	1.69	2.24	112.44	355106
15.75	8	5.06	5.41	5.35	6.75	6	2.17	2.64	222.67	355107
15.75	11	5.06	5.41	5.35	9.25	6	2.17	2.64	222.67	355108
19.69	8	5.75	6.17	5.35	6.75	6	2.36	3.11	330.69	355109
19.69	11	5.75	6.17	7.48	9.25	6	2.36	3.11	330.69	355110
24.80	11	6.50	6.94	7.48	9.25	6	2.76	3.43	604.07	355112

Precision Lathe Chucks

Steel – 2-Piece Jaws – 3-Jaw & 6-Jaw Set Tru



- Hardened and ground working surfaces
- Balanced scroll plate
- Repeatability: 0.0006"
- Fine adjustment radially set screws provide nearly 0 run-out
- Clamped workpiece is adjusted to the required concentricity by means of 4 (8 for sizes 16", 20" and 25") radially arranged adjusting screws
- Made for universal use, but particularly advantageous for grinding machines, indexing heads and lathes
- Mounted on the machine tool spindle from the back of the chuck by using a back plate

Standard Accessories:

- 1 set of hard top jaws
- 1 set of hard master jaws
- 1 wrench
- 1 hex key

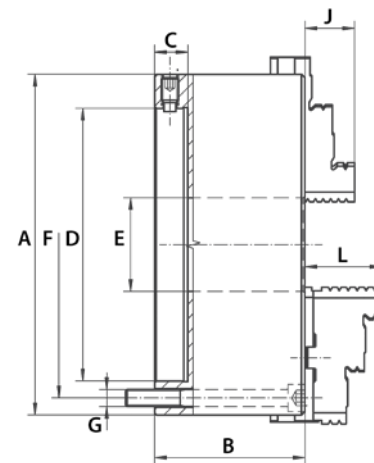

See 322 for Clamping Ranges

3-Jaw Set Tru – Series 3565 / 6-Jaw Set Tru – Series 3865

A (Inch)	B (Inch)	C (Inch)	D (Inch)	E (Inch)	F (Inch)	G	J (Inch)	L (Inch)	3-Jaw		6-Jaw	
									Weight (lbs)	Code	Weight (lbs)	Code
6.30	2.70	0.71	3.39	1.65	5.51	3 x M10	1.26	1.69	20.06	355120	23.15	355113
7.87	3.07	0.79	4.33	2.17	6.93	3 x M10	1.14	1.77	34.17	355121	38.58	355114
9.84	3.50	0.79	5.71	2.99	8.92	3 x M12	1.34	2.09	57.76	355122	72.75	355115
12.40	3.79	0.79	7.09	4.06	11.26	3 x M16	1.69	2.24	102.51	355123	123.46	355116
15.75	4.84	0.87	11.78	5.35	6.75	6 x M16	2.17	2.64	198.42	355124	218.26	355117
19.69	5.67	1.18	16.03	7.48	9.25	6 x M20	2.36	3.11	376.99	355125	396.83	355118
24.80	5.91	1.18	16.03	9.92	13.00	6 x M20	2.76	3.43	665.80	355126	718.71	355119



Precision Lathe Chucks

Steel – 2-Piece Jaws – 3-Jaw & 6-Jaw Set Tru (continued)

Back Plates for Set Tru Chucks

- Fully machined
- Set Tru chucks only take Set Tru back plates

Type A – Series 8215

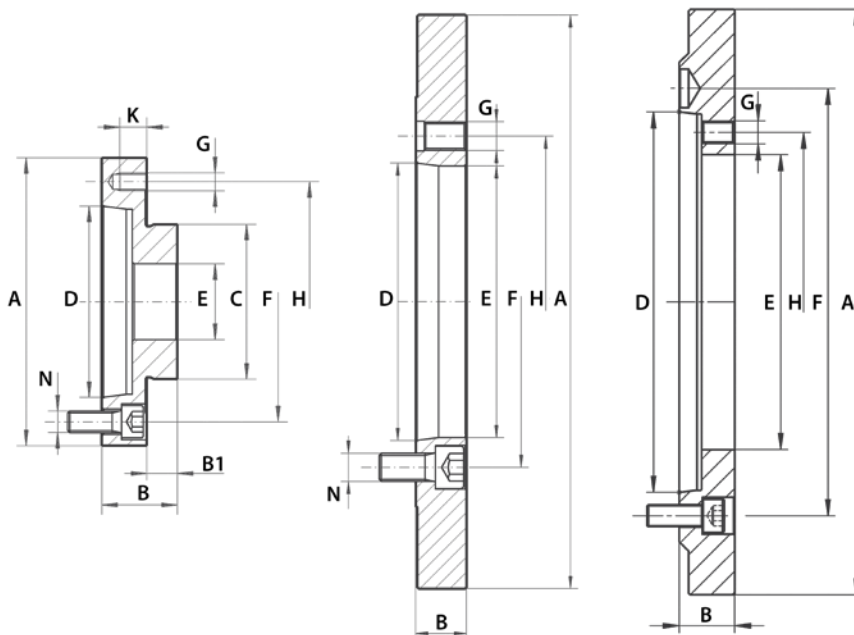

Chuck Dia. (Inch)	Taper Size	Sketch Ref.	A (Inch)	B (Inch)	B1 (Inch)	C (Inch)	D (Inch)	E (Inch)	F (Inch)	G	H (Inch)	K (Inch)	Weight (lbs)	Code
6	5	I	6.30	1.46	0.63	3.39	3.25	1.65	4.13	M10	5.51	0.83	6.83	355147
8	5	I	7.87	1.30	0.67	4.33	3.25	2.17	4.13	M10	6.93	0.63	9.26	355148
8	6	I	7.87	1.77	0.67	4.33	4.19	2.17	5.25	M10	6.93	1.10	13.67	355149
10	5	I	9.84	1.50	0.75	5.71	3.25	2.99	4.13	M12	8.82	0.75	17.20	355150
10	6	I	9.84	1.50	0.75	5.71	4.19	2.99	5.25	M12	9.82	0.75	17.42	355151
10	8	I	9.84	1.81	0.75	5.71	5.50	2.99	6.75	M12	8.82	1.02	20.28	355152
12	6	I	12.40	1.50	0.75	7.09	4.19	4.06	5.25	M16	11.26	0.75	27.12	355153
12	8	I	12.40	1.81	0.75	7.09	5.50	4.06	6.75	M16	11.26	1.06	35.27	355154
12	11	I	12.40	2.17	0.75	7.09	7.75	4.06	9.25	M16	11.26	1.42	41.23	355155
16	8	II	11.75	1.46	-	11.75	5.50	5.35	6.75	M16	6.75	1.14	28.22	355156
16	11	II	11.75	1.89	-	11.75	7.75	5.35	9.25	M16	6.75	1.06	35.71	355157
20	8	II	16.02	1.42	-	16.02	5.50	5.35	6.75	M20	9.25	1.42	69.45	355158
20	11	II	16.02	1.42	-	16.02	7.75	7.59	9.25	M20	9.25	1.42	60.85	355159
20	15	II	16.02	2.05	-	16.02	11.25	7.48	13.00	M20	9.25	2.05	76.28	355160
25	8	II	16.02	1.42	-	16.02	5.50	5.35	6.75	M20	13.00	1.42	69.45	355161
25	11	II	16.02	1.42	-	16.02	7.75	7.59	9.25	M20	13.00	1.42	60.85	355162
25	15	II	16.02	2.05	-	16.02	11.25	9.92	13.00	M20	13.00	2.05	65.26	355163

LATHE CHUCKS & ACCESSORIES

Precision Lathe Chucks

Steel – 2-Piece Jaws – 3-Jaw & 6-Jaw Set Tru (continued)



Back Plates for Set Tru Chucks (continued)

Type D – Series 8245

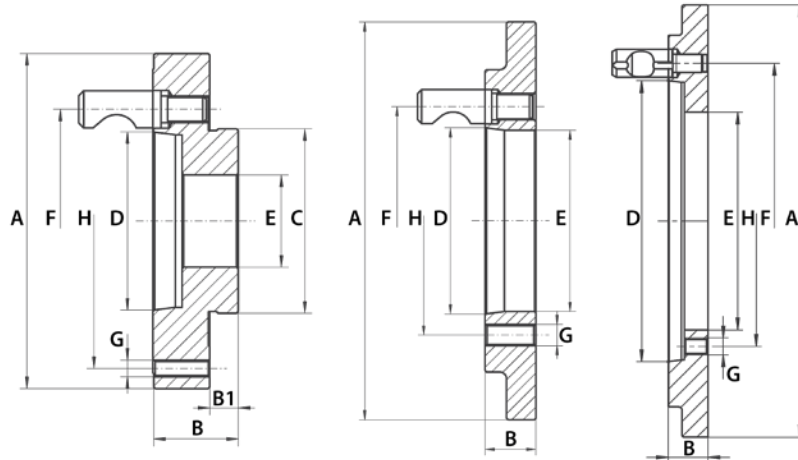

Chuck Dia. (Inch)	Taper Size	Sketch Ref.	A (Inch)	B (Inch)	B1 (Inch)	C (Inch)	D (Inch)	E (Inch)	F (Inch)	G	H (Inch)	Weight (lbs)	Code
6	3	I	6.30	1.81	0.63	3.39	2.13	1.65	2.75	M10	5.51	10.80	355127
6	4	I	6.30	1.81	0.63	3.39	2.50	1.65	3.25	M10	5.51	9.92	355128
6	5	I	6.30	1.81	0.63	3.39	3.25	1.65	4.13	M10	5.51	9.92	355129
8	3	I	7.87	1.30	0.67	4.33	2.13	2.02	2.78	M10	6.93	10.36	355130
8	4	I	7.87	1.30	0.67	4.33	2.50	2.17	3.25	M10	6.93	10.36	355131
8	5	I	7.87	1.85	0.67	4.33	3.25	2.17	4.13	M10	6.93	15.87	355132
8	6	I	7.87	2.01	0.67	4.33	4.19	2.17	5.25	M10	6.93	17.64	355133
10	5	I	9.84	1.50	0.75	5.71	3.25	2.99	4.13	M12	8.82	17.64	355134
10	6	I	9.84	2.09	0.75	5.71	4.19	2.99	5.25	M12	8.82	28.44	355135
10	8	I	9.84	2.36	0.75	5.71	5.50	2.99	6.75	M12	8.82	32.41	355136
12	6	I	12.40	1.50	0.75	7.09	4.19	4.06	5.25	M16	11.26	28.44	355137
12	8	I	12.40	2.24	0.75	7.09	5.50	4.06	6.75	M16	11.26	47.84	355138
12	11	I	12.40	2.52	0.75	7.09	7.75	4.06	9.25	M16	11.25	52.91	355139
16	8	II	11.75	1.50	-	8.94	5.50	5.36	6.75	M16	6.75	26.23	355140
16	11	II	11.75	1.89	-	11.69	7.75	5.35	9.25	M16	6.75	38.58	355141
20	8	II	16.02	1.50	-	16.02	5.50	5.35	6.75	M20	9.25	73.85	355142
20	11	II	16.02	1.73	-	16.02	7.75	7.59	9.25	M20	9.25	77.82	355143
20	15	II	16.02	2.05	-	16.02	11.25	7.48	13.00	M20	9.25	83.33	355144
25	8	II	16.02	1.50	-	16.02	5.50	5.35	6.75	M20	13.00	73.85	355145
25	11	II	16.02	1.73	-	16.02	7.75	7.59	9.25	M20	13.00	77.82	355146



Universal Lathe Chucks

Cast Iron – 2-Piece Jaws – 4-Jaw Self-Centering

Plain Back – Series 3605

- Cast iron
- Plain back (Back plates required)
- Ground working surfaces

Standard Accessories:

- 1 set of hard top jaws
- 1 set of hard master jaws
- 1 wrench
- 1 hex key

See 322 for Clamping Ranges

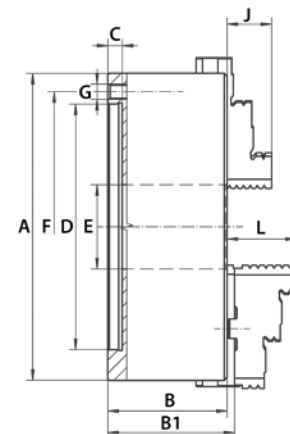

A (Inch)	B (Inch)	B1 (Inch)	C (Inch)	D H7 (Inch)	E (Inch)	F (Inch)	G	J (Inch)	L (Inch)	Weight (lbs)	Code
4.92	2.20	2.39	0.16	3.74	1.26	4.25	3 x M8	0.79	1.57	11.02	355164
6.30	2.54	2.73	0.16	4.92	1.65	5.51	6 x M10	1.26	1.69	22.05	355165
7.87	2.95	3.14	0.16	6.30	2.17	6.93	6 x M10	1.14	1.77	35.58	355166
9.84	3.35	3.50	0.20	7.87	2.99	8.82	6 x M12	1.34	2.09	63.93	355167
12.40	3.70	3.90	0.20	10.24	4.06	11.26	6 x M16	1.69	2.24	110.23	355168
15.75	4.13	4.48	0.20	12.99	5.35	14.25	6 x M16	2.17	2.64	187.39	355169
19.69	4.72	5.15	0.20	16.54	7.48	18.03	6 x M16	2.36	3.11	319.67	355170
24.80	5.31	5.76	0.28	21.46	9.92	23.07	6 x M16	2.76	3.43	551.16	355171

Steel – 2-Piece Jaws – 4-Jaw Self-Centering

Plain Back – Series 3705

- Steel
- Plain back (Back plates required)
- Hardened and ground working surfaces
- Balanced scroll plate

Standard Accessories:

- 1 set of hard top jaws
- 1 set of hard master jaws
- 1 wrench
- 1 hex key

See 322 for Clamping Ranges

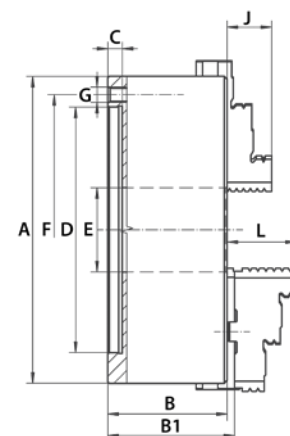

A (Inch)	B (Inch)	B1 (Inch)	C (Inch)	D H7 (Inch)	E (Inch)	F (Inch)	G	J (Inch)	L (Inch)	Weight (lbs)	Code
6.30	2.68	2.87	0.16	4.92	1.65	5.51	6 x M10	1.26	1.69	22.05	355172
7.87	3.07	3.26	0.16	6.30	2.17	6.93	6 x M10	1.14	1.77	38.58	355173
9.84	3.50	3.65	0.20	7.87	2.99	8.82	6 x M12	1.34	2.09	63.93	355174
12.40	3.83	3.99	0.20	10.24	4.06	11.26	6 x M16	1.69	2.24	110.23	355175
15.75	4.29	4.60	0.20	12.99	5.35	14.25	6 x M16	2.17	2.64	187.39	355176
19.69	4.69	5.11	0.20	16.54	7.48	18.03	6 x M16	2.36	3.11	319.67	355177
24.80	5.08	5.52	0.28	21.46	9.92	23.07	6 x M16	2.76	3.43	551.16	355178

Universal Lathe Chucks

Cast Iron – Solid Jaws – 4-Jaw Self-Centering



Plain Back – Series 3604

- Cast iron
- Plain back (Back plates required)
- Ground working surfaces

Standard Accessories:

- 1 set of hard solid ID jaws
- 1 set of hard solid OD jaws
- 1 wrench
- 1 hex key

See 326 for Clamping Ranges

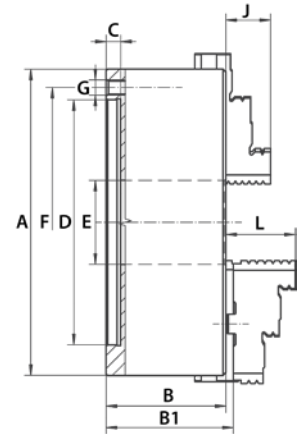

A (Inch)	B (Inch)	B1 (Inch)	C (Inch)	D H7 (Inch)	E (Inch)	F (Inch)	G	J (Inch)	L (Inch)	Weight (lbs)	Code
4.92	2.20	2.39	0.16	3.74	1.26	4.25	3 x M8	0.79	1.57	11.02	355179
6.30	2.54	2.73	0.16	4.92	1.65	5.51	6 x M10	1.26	1.69	22.05	355180
7.87	2.95	3.14	0.16	6.30	2.17	6.93	6 x M10	1.14	1.77	35.58	355181
9.84	3.35	3.50	0.20	7.87	2.99	8.82	6 x M12	1.34	2.09	63.93	355182
12.40	3.70	3.90	0.20	10.24	4.06	11.26	6 x M16	1.69	2.24	110.23	355183
15.75	4.13	4.48	0.20	12.99	5.35	14.25	6 x M16	2.17	2.64	187.39	355184
19.69	4.72	5.15	0.20	16.54	7.48	18.03	6 x M16	2.36	3.11	319.67	355185



Combination Universal/Independent Lathe Chucks

Cast Iron & Steel – Solid Jaws – 4-Jaw Self-Centering (Wescott)

Plain Back – Series 4605 / Front Mount – Series 4805

- Cast iron/Steel
- Plain back (Back plates required) or front mount
- Individually adjustable jaws
- Self-centering jaw clamping

Standard Accessories:

- 1 set of solid reversible jaws
- 1 wrench
- 1 hex key

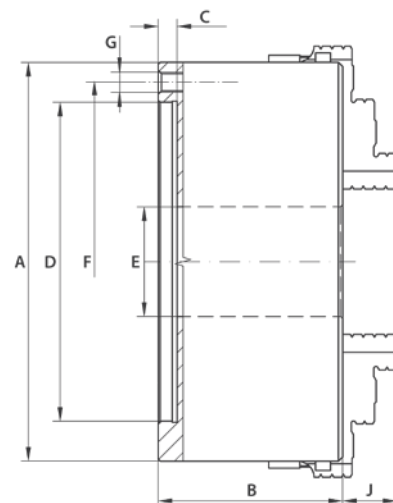

See 333 for Clamping Ranges

A (Inch)	B (Inch)	C (Inch)	D (Inch)	E (Inch)	F (Inch)	G	J (Inch)	Cast Iron Plain Back Series 4605		Steel Front Mount Series 4805	
								Weight (lbs)	Code	Weight (lbs)	Code
7.87	3.78	0.20	6.30	2.17	6.93	6 x M10	1.22	41.4	355190	43	355196
9.84	4.02	0.24	7.87	2.99	8.82	6 x M12	1.30	65	355191	68.3	355197
12.40	4.61	0.24	10.24	4.06	11.26	6 x M16	1.63	120	355192	124	355198
15.75	4.84	0.24	12.99	5.35	14.25	6 x M16	2.32	194	355193	198	355199
19.69	5.71	0.31	16.54	7.48	18.03	6 x M16	2.40	330	355194	342	355200
24.80	6.30	0.39	21.46	9.92	23.07	6 x M16	2.83	551	355195	573	355201

Clamping Ranges for 3-Jaw & 4-Jaw Combination Chucks

- Do not exceed the maximum allowable clamping ranges

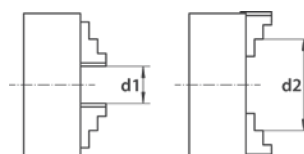

3-Jaw & 4-Jaw Combination Chucks – Solid Reversible Jaws – Series 4505, 4605, 4705, 4805			
Chuck Diameter (Inch)	d1 (Inch)	d2 (Inch)	Maximum Swing Diameter (Inch)
8	0.16	7.87	9.45
10	0.20	9.84	11.80
12	0.39	12.40	14.60
16	0.59	15.70	18.50
20	0.79	19.70	22.60
25	1.18	24.80	28.50

Independent Lathe Chucks

Cast Iron & Steel – Solid Jaws – 4-Jaw Independent



Plain Back – Series 4304

- Cast iron
- Plain back (Back plates required)
- Chucks 10" diameter and larger have additional T-slots

Standard Accessories:

- 1 set of solid reversible jaws
- 1 wrench

See 335 for Clamping Ranges

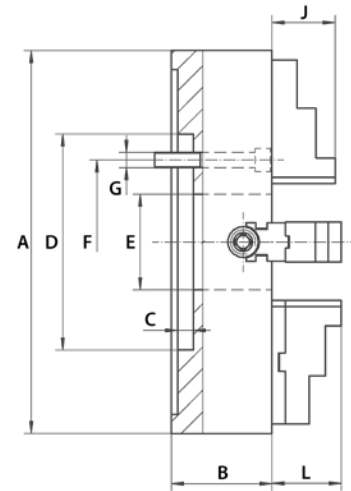

A (Inch)	B (Inch)	C (Inch)	D (Inch)	E (Inch)	F (Inch)	G	J (Inch)	L (Inch)	Weight (lbs)	Code
7.87	3.15	0.20	4.33	1.97	3.24	4 x M10	1.59	1.83	30.86	355209
9.84	3.35	0.28	5.91	2.56	4.13	4 x M12	1.59	2.38	55.12	355210
12.40	3.74	0.28	6.89	3.15	5.25	4 x M16	1.96	2.40	85.98	355211
15.75	4.13	0.39	7.87	3.94	6.75	4 x M16	1.96	2.85	134.48	355212
19.69	4.72	0.47	10.63	4.92	9.25	4 x M20	2.35	3.85	231.49	355213
24.80	5.51	0.47	10.63	6.30	9.25	4 x M20	2.35	3.85	359.35	355214

Plain Back – Series 4306

- Steel
- Plain back (Back plates required)
- Chucks 10" diameter and larger have additional T-slots

Standard Accessories:

- 1 set of solid reversible jaws
- 1 wrench

See 335 for Clamping Ranges

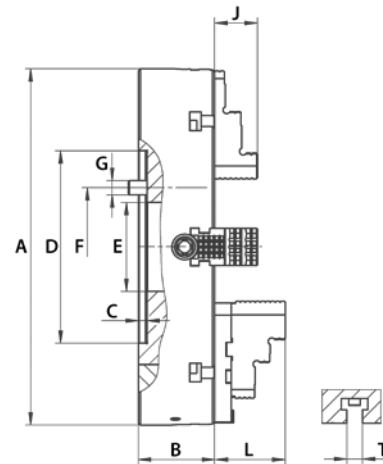

A (Inch)	B (Inch)	C (Inch)	D (Inch)	E (Inch)	F (Inch)	G	J (Inch)	Weight (lbs)	Code
3.39	1.57	0.20	2.44	0.98	2.83	4 x M6	0.67	4.19	355206
5.12	1.69	0.10	2.75	1.02	2.13	4 x M8	0.79	10.58	355207
6.14	1.69	0.10	3.25	1.65	2.75	4 x M10	0.79	14.55	355208



Independent Lathe Chucks

Cast Iron & Steel – Solid Jaws – 4-Jaw Independent (*continued*)

Type D – Series 4344

- Cast iron
- Chucks 10" diameter and larger have additional T-slots

Standard Accessories:

- 1 set of solid reversible jaws
- 1 wrench

See 335 for Clamping Ranges

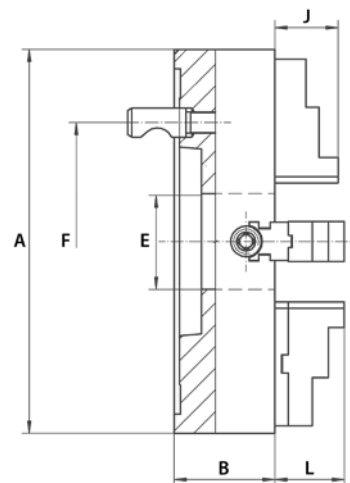

LATHE CHUCKS & ACCESSORIES

A (Inch)	Taper Size	B (Inch)	E (Inch)	F (Inch)	No. of Stud Bolts	J (Inch)	L (Inch)	Weight (lbs)	Code
7.87	3	3.15	1.97	2.78	3	1.59	1.83	36.38	355228
7.87	4	3.15	1.97	3.25	3	1.59	1.83	36.38	355229
7.87	5	3.15	1.97	4.13	6	1.59	1.83	36.38	355230
9.84	4	3.35	2.36	3.25	3	1.59	2.38	60.63	355231
9.84	5	3.35	2.56	4.13	6	1.59	2.38	60.63	355232
9.84	6	3.35	2.56	5.25	6	1.59	2.38	60.63	355233
12.40	6	3.74	3.15	5.25	6	1.96	2.40	87.08	355234
12.40	8	3.74	3.15	6.75	6	1.96	2.40	87.08	355235
15.75	6	4.13	3.94	5.25	6	1.96	2.85	132.28	355236
15.75	8	4.13	3.94	6.75	6	1.96	2.85	132.28	355237
15.75	11	4.13	3.94	9.25	6	1.96	2.85	132.28	355238
19.69	8	4.72	4.92	6.75	6	2.35	3.85	210.54	355239
19.69	11	4.72	4.92	9.25	6	2.35	3.85	210.54	355240
24.80	11	5.51	6.30	9.25	6	2.35	3.85	363.76	355241

Clamping Ranges for 4-jaw Independent Chucks

- Do not exceed the maximum allowable clamping ranges

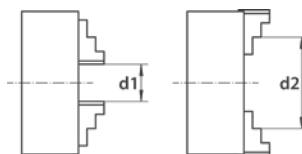

4-Jaw Independent Chucks – Solid Reversible Jaws – Series 43**

Chuck Diameter (Inch)	d1 (Inch)	d2 (Inch)	Maximum Swing Diameter (Inch)
3-1/2	0.12	3.35	3.98
4	0.12	0.39	4.57
5	0.31	4.92	5.91
6	0.31	6.30	7.28
8	0.39	7.87	9.25
10	0.39	9.84	11.60
12	0.59	12.40	14.50
16	0.79	15.70	18.30
20	1.77	19.70	22.40
25	1.97	24.80	28.30

Independent Lathe Chucks

Steel – 2-Piece Jaws – 4-Jaw Independent



Oil Country Chucks – Type A – Series 4317 HD

- Steel
- With large through-hole designed for gripping long and heavy work pieces or pipes during heavy duty (HD) machining
- High gripping force
- High accuracy
- Heavy duty operations
- Chucks can work individually or in pairs, mounted on opposite sides of the lathe spindle

Standard Accessories:

- 1 set of hard top jaws
- 1 set of hard master jaws
- 1 wrench

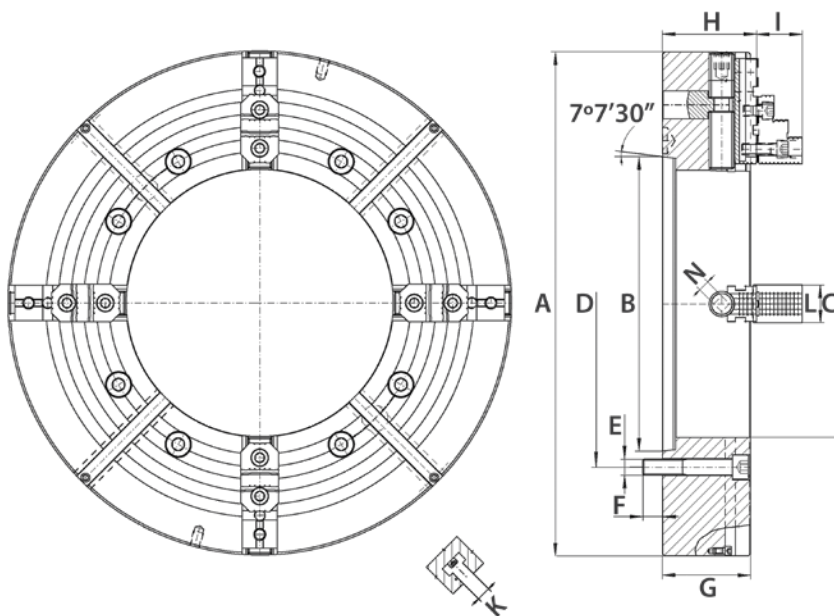

Clamping Ranges

Chuck Diameter (Inch)	Clamping Range (Inch)	Torque on Wrench (lb/ft)	Gripping Force per Jaw (lbf)
19.69	1.77 - 19.69	259	7,190
24.80	1.97 - 24.80	296	8,320
24.80	3.94 - 24.80	296	8,320
27.95	2.95 - 27.95	331	9,217
27.95	3.94 - 27.95	331	9,217
31.50	2.95 - 31.50	331	9,217
31.50	4.53 - 31.50	331	9,217

A (Inch)	Taper Size	B (Inch)	C (Inch)	D (Inch)	E	F (Inch)	G (Inch)	H (Inch)	I (Inch)	K (Inch)	L (Inch)	N (Inch)	Max RPM	Weight (lbs)	Code
19.69	15	11.25	8.07	13.00	8 x M24	1.24	5.71	6.07	2.98	0.87	2.36	0.75	1,000	414	355309
24.80	15	11.25	10.63	13.00	8 x M24	1.34	6.10	6.58	3.57	0.87	2.95	0.87	850	683	355310
24.80	20	16.25	12.60	18.25	8 x M24	1.50	6.10	6.58	3.57	0.87	2.95	0.87	850	661	355311
27.95	15	11.25	10.63	13.00	8 x M24	1.34	6.10	6.58	3.57	0.87	2.95	0.87	750	914	355312
27.95	20	16.25	12.60	18.25	8 x M24	1.50	6.10	6.58	3.57	0.87	2.95	0.87	750	870	355313
31.50	15	11.25	10.63	13.00	8 x M24	1.34	6.50	6.97	3.57	0.87	2.95	0.87	600	1,289	355314
31.50	20	16.25	12.60	18.25	8 x M24	1.50	6.50	6.97	3.57	0.87	2.95	0.87	600	1,245	355315



Independent Lathe Chucks

Steel – 2-Piece Jaws – 4-Jaw Independent (*continued*)

Oil Country Chucks – Type D – Series 4347 HD

- Steel
- With large through-hole designed for gripping long and heavy work pieces or pipes during heavy duty (HD) machining
- High gripping force
- High accuracy
- Heavy duty operations
- Chucks can work individually or in pairs, mounted on opposite sides of the lathe spindle

Standard Accessories:

- 1 set of hard top jaws
- 1 set of hard master jaws
- 1 wrench

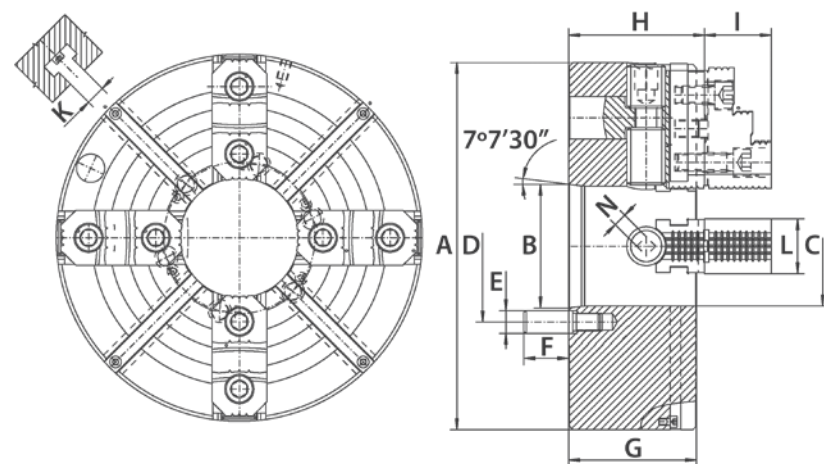

Chuck Diameter (Inch)	Clamping Range (Inch)	Torque on Wrench (lb/ft)	Gripping Force per Jaw (lbf)
16.34	1.77 - 15.75	259	7,190
16.34	1.77 - 15.75	259	7,190
19.69	1.77 - 19.69	259	7,190
19.69	1.77 - 19.69	259	7,190
27.95	2.95 - 27.95	331	9,217

A (Inch)	Taper Size	B (Inch)	C (Inch)	D (Inch)	E (Inch)	F (Inch)	G (Inch)	H (Inch)	I (Inch)	K (Inch)	L (Inch)	N (Inch)	Max RPM	Weight (lbs)	Code
16.34	8	5.50	5.35	6.75	1.00	2.00	5.71	6.07	2.98	0.71	2.36	0.75	1,200	300	355316
16.34	11	7.75	6.61	9.25	1.19	2.39	5.71	6.07	2.98	0.71	2.36	0.75	1,200	282	355317
19.69	8	5.50	5.35	6.75	1.00	2.00	5.71	6.07	2.98	0.87	2.36	0.75	1,000	467	355318
19.69	11	7.75	6.61	9.25	1.19	2.39	5.71	6.07	2.98	0.87	2.36	0.75	1,000	452	355319
27.95	11	7.75	7.56	9.25	1.19	2.39	6.10	6.58	3.57	0.87	2.95	0.87	750	992	355320

LATHE CHUCKS & ACCESSORIES



Independent Lathe Chucks

Oil Country Lathe Chuck Accessories

Hard Top Reversible Jaws – 1 Piece



For Chuck Diameter (Inch)	Code	For Chuck Diameter (Inch)	Code
15-3/4, 20	355922	25, 28, 32	355923

Thrust Bearings – 1 Piece



For Chuck Diameter (Inch)	Code	For Chuck Diameter (Inch)	Code
15-3/4	355927	25, 28	355929
20	355928	32	355930

Keys – 1 Piece



For Chuck Diameter (Inch)	Code	For Chuck Diameter (Inch)	Code
15-3/4, 20	355931	25, 28, 32	355932

Operating Screws – 1 Piece



For Chuck Diameter (Inch)	Hole Diameter (Inch)	Code	For Chuck Diameter (Inch)	Hole Diameter (Inch)	Code	For Chuck Diameter (Inch)	Hole Diameter (Inch)	Code
15-3/4	5.3	355933	20	8.0	355937	28	12.5	355941
15-3/4	6.5	355934	25	10.5	355938	32	10.5	355942
20	5.3	355935	25	12.5	355939	32	12.5	355943
20	6.5	355936	28	10.5	355940			



Universal Lathe Chucks

Cast Iron – 3-Jaw, Solid and 2-Piece Jaws & 4-Jaw, 2-Piece Jaws – Front Mount Self-Centering

LATHE CHUCKS & ACCESSORIES

These 3 and 4-Jaw Universal Scroll Chucks are designed for use with rotary tables and other devices where back mounting chucks cannot be used. They can be mounted directly on 3-slot rotary table or on base plate when rotary table has 4 or 8 T-slots.

3-Jaw – Series 3274 & Series 3275

- Cast iron
- Ground working surfaces
- Flexible mounting system: mounting from the back or front of the chuck by use of an adapter plate

Standard Accessories – Series 3274:

- 1 set of hard solid ID jaws
- 1 set of hard solid OD jaws
- 1 wrench

Standard Accessories – Series 3275:

- 1 set of hard top jaws
- 1 set of hard master jaws
- 1 wrench

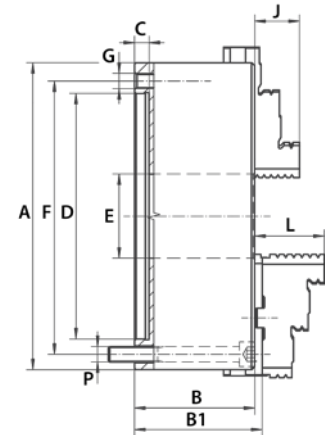

A (Inch)	B (Inch)	B1 (Inch)	C (Inch)	DH7 (Inch)	E (Inch)	F (Inch)	G	J (Inch)	L (Inch)	P	Solid Jaws Series 3274		2-Piece Jaws Series 3275	
											Weight (lbs)	Code	Weight (lbs)	Code
3.94	1.97	-	0.12	2.76	0.79	3.27	3 x M8	0.63	-	3 x 5/16-18	6.17	355275	-	-
4.92	2.20	2.39	0.16	3.74	1.26	4.25	3 x M8	0.79	1.57	3 x 5/16-18	-	-	11.02	355279
6.30	2.54	2.73	0.16	4.92	1.65	5.51	3 x M10	1.26	1.69	3 x 3/8-16	-	-	22.05	355280
7.87	2.95	3.14	0.16	6.30	2.17	6.93	3 x M10	1.14	1.77	3 x 3/8-16	38.58	355276	38.58	355281
9.84	3.35	3.50	0.20	7.87	2.99	8.82	3 x M12	1.34	2.09	3 x 1/2-13	63.93	355277	63.93	355282
12.40	3.70	3.90	0.20	10.24	4.06	11.26	3 x M16	1.69	2.24	3 x 5/8-11	110.23	355278	110.23	355283

4-Jaw – Series 3675

- Cast iron
- Ground working surfaces
- Flexible mounting system: mounting from the back or front of the chuck by use of an adapter plate

Standard Accessories:

- 1 set of hard top jaws
- 1 set of hard master jaws
- 1 wrench

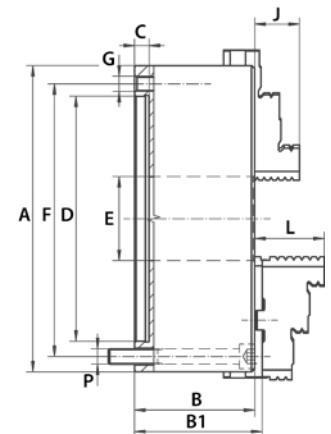

A (Inch)	B (Inch)	B1 (Inch)	C (Inch)	DH7 (Inch)	E (Inch)	F (Inch)	G	J (Inch)	L (Inch)	P	2-Piece Jaws Series 3675	
											Weight (lbs)	Code
4.92	2.20	2.39	0.16	3.74	1.26	4.26	3 x M8	0.79	1.57	3 x 5/16-18	11.02	355284
6.30	2.54	2.73	0.16	4.92	1.65	5.51	3 x M10	1.26	1.69	3 x 3/8-16	22.05	355285
7.87	2.95	3.14	0.16	6.30	2.17	6.93	3 x M10	1.14	1.77	3 x 3/8-16	38.58	355286
9.84	3.35	3.50	0.20	7.87	2.99	8.82	3 x M12	1.34	2.09	3 x 1/2-13	63.93	355287
12.40	3.70	3.90	0.20	10.24	4.06	11.26	3 x M16	1.69	2.24	3 x 5/8-11	110.23	355288

Quick Clamping Lathe Chucks

Cast Iron & Steel – Solid Jaws – 3-Jaw & 6-Jaw

For Drill and End Mill Sharpening



LATHE CHUCKS & ACCESSORIES

- Lever scroll chuck designed for grinding twist drills and other cutting tools
- Fine adjustment in sizes 5" and 6" to the required concentricity by means of 4 radially arranged adjusting screws



3-Jaw – Cast Iron – Series 3266

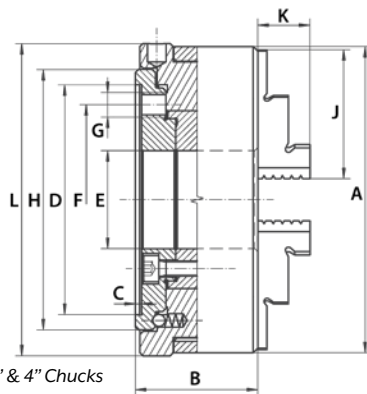

3" & 4" Chucks

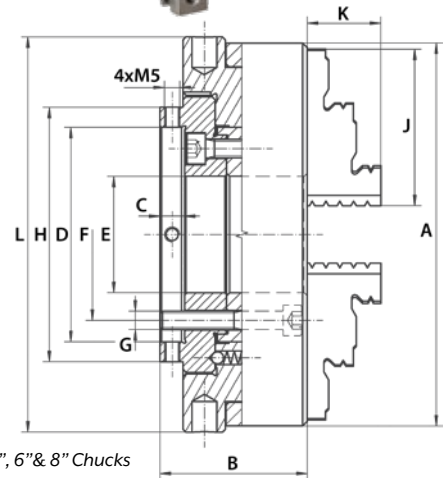

5", 6" & 8" Chucks

Standard Accessories

- 1 set of hard solid ID jaws
- 1 set of hard solid OD jaws
- 1 operating lever

A (Inch)	B (Inch)	C (Inch)	D (Inch)	E (Inch)	F (Inch)	G	H (Inch)	J (Inch)	K (Inch)	L (Inch)	Length of Lever (Inch)	Weight (lbs)	Code
3.15	1.38	0.06	1.89	0.94	1.54	3 x M6	2.05	1.30	0.51	3.23	3.94	2.43	355289
3.94	1.57	0.08	2.95	1.26	1.77	3 x M6	3.35	1.65	0.67	4.02	4.92	7.05	355290
4.92	1.89	0.31	2.76	1.50	2.20	3 x M6	3.27	2.01	0.79	5.08	6.30	8.82	355291
6.30	2.05	0.31	3.09	2.05	2.56	3 x M6	3.78	2.76	1.30	6.46	7.87	16.09	355292

6-Jaw – Steel – Series 3866

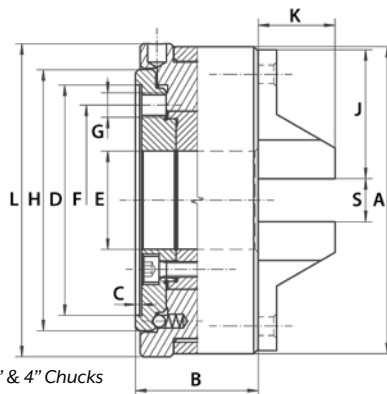

3" & 4" Chucks

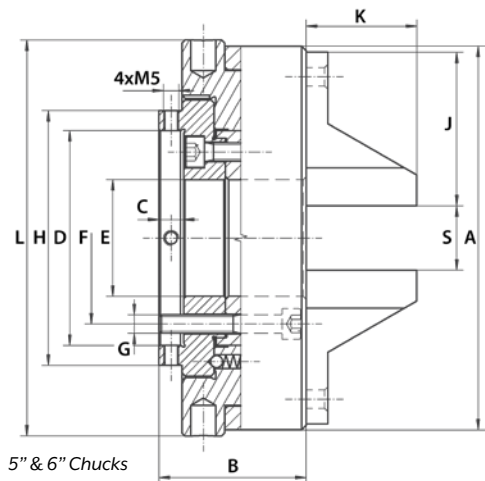

5" & 6" Chucks

Standard Accessories

- 1 set of hard solid jaws
- 1 operating lever

A (Inch)	B (Inch)	C (Inch)	D (Inch)	E (Inch)	F (Inch)	G	H (Inch)	J (Inch)	K (Inch)	L (Inch)	S (Inch)	Length of Lever (Inch)	Weight (lbs)	Code
3.15	1.38	0.06	1.89	0.94	1.54	3 x M6	2.05	1.38	0.87	3.23	0.04 - 0.91	3.94	4.41	355293
3.94	1.57	0.08	2.95	1.26	2.44	3 x M8	3.35	1.65	0.98	4.02	0.06 - 1.22	4.92	6.17	355294
4.92	1.89	0.31	2.76	1.50	2.20	3 x M6	3.27	1.97	1.42	5.08	0.08 - 1.46	6.30	8.82	355295
6.30	2.05	0.31	3.09	2.05	2.56	3 x M6	3.78	2.28	1.42	6.46	0.12 - 2.01	7.87	15.43	355296

Quick Clamping Lathe Chuck Adapters



Morse Taper
Series 8283



- Fully machined

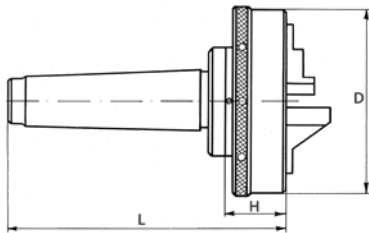

5C
Series 8287

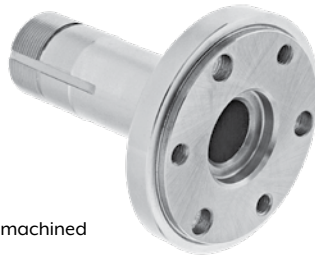

- Fully machined

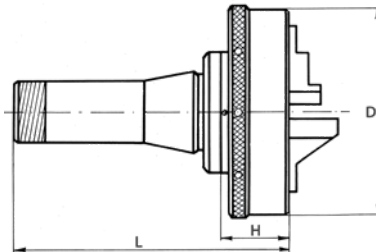

5C Blank
Series 8289



- Semi-finished

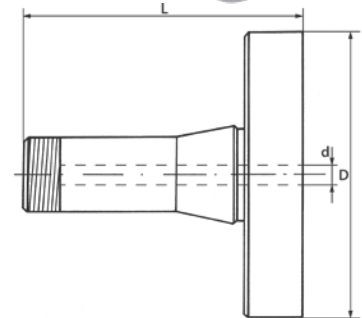

D (Inch)	Morse Taper	L (Inch)	H (Inch)	Code
4	3	5.51	1.57	355554
5	3	5.59	1.89	355556
5	4	6.50	1.89	355557
6	5	7.68	2.05	355558

D (Inch)	L (Inch)	H (Inch)	ØHole (Inch)	Code
5	5.75	1.89	0.87	355560
6	5.83	2.05	0.87	355561

D (Inch)	Shank	ØHole (Inch)	L (Inch)	Thread	Code
3		0.87	4.41	1-1/4-20	355562
4	5C	0.87	4.41	1-1/4-20	355563
5	5C	0.87	4.41	1-1/4-20	355563
6		0.87	4.41	1-1/4-20	355563

Universal Lathe Chucks

Cast Iron – 2-Piece Jaws – 2-Jaw Self-Centering

Plain Back – Series 3105



- Cast iron
- Plain back (Back plates required)
- Hardened and ground working surfaces
- Balanced scroll plate

Standard Accessories:

- 1 set of soft top jaws
- 1 set of hard master jaws
- 1 wrench
- 1 hex key

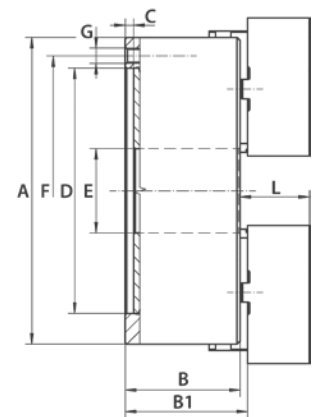

A (Inch)	B (Inch)	B1 (Inch)	C (Inch)	D H7 (Inch)	E (Inch)	F (Inch)	G	L (Inch)	Weight (lbs)	Code
6.30	2.54	2.73	0.16	4.92	1.65	5.51	6 x M10	1.69	22.05	355297
7.87	2.95	3.14	0.16	6.30	2.17	6.93	6 x M10	1.77	38.58	355298
9.84	3.35	3.50	0.20	7.87	2.99	8.82	6 x M12	2.09	63.93	355299
12.40	3.70	3.90	0.20	10.24	4.06	11.26	6 x M16	2.24	110.23	355300
15.75	4.13	4.48	0.20	12.99	5.35	14.25	6 x M16	2.64	187.39	355301

Lathe Chuck Accessories

For Bison Lathe Chucks



Back Plates – Fully Machined

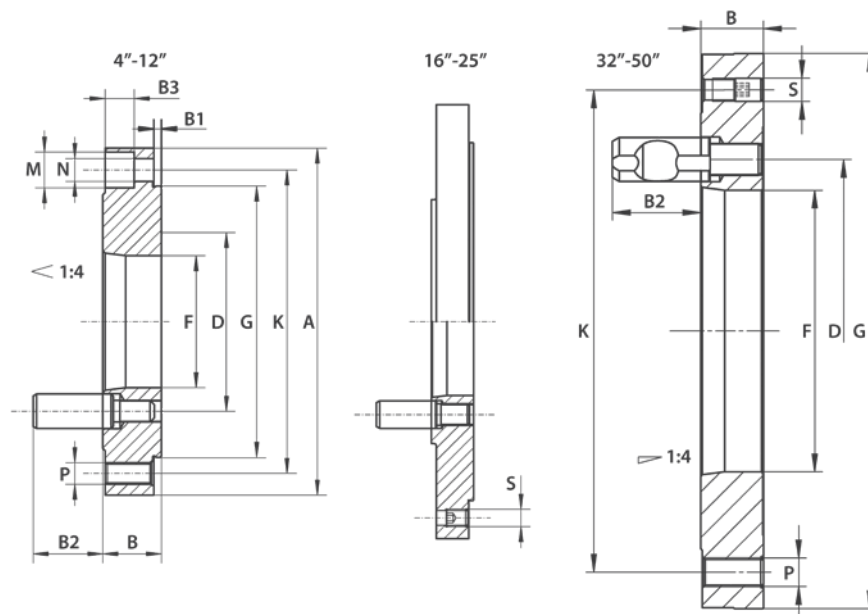

Type D – Series 8240-X

Ø Chuck (Inch)	Taper Size	A (Inch)	B (Inch)	B1 (Inch)	B2 (Inch)	D (Inch)	F (Inch)	G h6 (Inch)	K (Inch)	M (Inch)	N (Inch)	P (Inch)	S (Inch)	Weight (lbs)	Code
5	3	4.92	1.02	0.14	1.21	2.78	2.02	3.74	4.25	3 x 0.53	3 x 0.33	6 x 5/16-18	-	3.53	355565
5	4	4.92	1.02	0.14	1.27	3.25	2.36	3.74	4.25	3 x 0.53	3 x 0.33	6 x 5/16-18	-	3.53	355566
6	4	6.30	1.06	0.14	1.27	3.25	2.36	4.92	5.51	3 x 0.53	3 x 0.33	6 x 3/8-16	-	6.39	355568
6	5	6.30	1.18	0.14	1.50	4.13	3.13	4.92	5.51	3 x 0.53	3 x 0.33	6 x 3/8-16	-	6.61	355569
6	6	6.61	1.43	0.13	-	5.25	4.05	4.92	5.51	3 x M10	6 x 0.413	-	-	4.10	355570
8	3	7.87	1.06	0.14	1.21	2.78	2.02	6.30	6.93	6 x 0.65	6 x 0.41	6 x 3/8-16	-	11.02	355571
8	4	7.87	1.06	0.14	1.29	3.25	2.36	6.30	6.93	6 x 0.65	6 x 0.41	6 x 3/8-16	-	10.80	355572
8	5	7.87	1.18	0.14	1.50	4.13	3.13	6.30	6.93	6 x 0.65	6 x 0.41	6 x 3/8-16	-	10.58	355573
8	6	7.87	1.44	0.14	1.74	5.25	4.06	6.30	6.93	6 x 0.65	6 x 0.41	6 x 3/8-16	-	13.01	355574
10	5	9.84	1.18	0.18	1.50	4.13	3.13	7.87	8.82	6 x 0.75	6 x 0.51	6 x 1/2-13	-	18.96	355575
10	6	9.84	1.44	0.18	1.74	5.25	4.06	7.87	8.82	6 x 0.75	6 x 0.51	6 x 1/2-13	-	19.18	355576
10	8	9.84	1.54	0.18	2.00	6.75	5.36	7.87	8.82	6 x 0.75	6 x 0.51	6 x 1/2-13	-	20.72	355577
12	6	12.40	1.54	0.18	1.74	5.25	4.06	10.24	11.26	6 x 0.98	6 x 0.67	6 x 5/8-11	-	38.36	355578
12	8	12.40	1.54	0.18	2.00	6.75	5.36	10.24	11.26	6 x 0.98	6 x 0.67	6 x 5/8-11	-	35.05	355579
12	11	12.40	1.85	0.18	2.39	9.25	7.59	10.24	11.26	6 x 0.98	6 x 0.67	6 x 5/8-11	-	35.94	355580
16	8	15.74	1.53	0.17	-	5.25	4.05	15.74	14.25	3 x M16	6 x 0.669	-	-	62.10	355581
16	8	15.75	1.54	0.18	2.00	6.75	5.36	12.77	14.25	6 x 0.98	6 x 0.67	6 x 5/8-11	3 x 5/8-16	60.41	355582
16	11	15.75	1.85	0.18	2.39	9.25	7.59	12.77	14.25	6 x 0.98	6 x 0.67	6 x 5/8-11	3 x 5/8-16	60.41	355583
20	8	19.69	1.54	0.18	2.00	6.75	5.36	16.54	18.03	6 x 0.98	6 x 0.67	6 x 5/8-11	3 x 5/8-16	100.09	355584
20	11	19.69	1.85	0.18	2.39	9.25	7.59	16.54	18.03	6 x 0.98	6 x 0.67	6 x 5/8-11	3 x 5/8-16	98.11	355585
25	11	24.80	1.85	0.24	2.39	9.25	7.59	21.46	23.07	6 x 0.98	6 x 0.67	6 x 5/8-11	3 x 5/8-16	164.24	355587



Lathe Chuck Accessories

For Bison Lathe Chucks

Threaded Back Plates – Cast Iron

- Rough finish

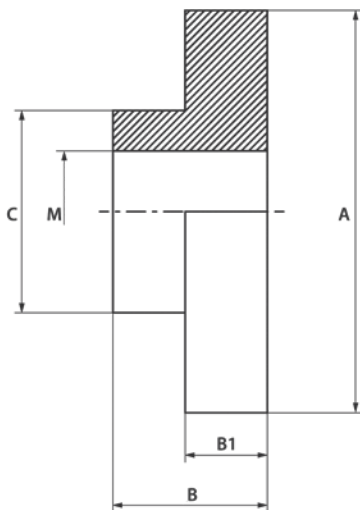
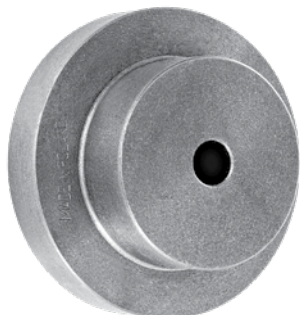

Series 8205

For Chuck Diameter (Inch)	D (Inch)	d (Inch)	D1 (Inch)	K (Inch)	L (Inch)	Weight (lbs)	Code
6-1/4	6.70	0.98	3.46	0.98	2.20	12.0	355664
8	8.30	0.98	4.02	1.18	2.83	22.0	355665
12-1/2	12.30	1.97	6.77	1.26	4.02	66.0	355667
15-3/4	16.34	2.76	9.06	2.17	4.92	154.0	355668
25	25.20	4.72	11.81	3.35	7.09	496.0	355670

For Independent Chucks – Series 8262

For Chuck Diameter (Inch)	D (Inch)	d (Inch)	D1 (Inch)	K (Inch)	L (Inch)	Weight (lbs)	Code
6-1/4	3.94	0.79	2.95	1.18	2.17	8	355671
5	5.12	1.18	3.74	1.38	2.56	11	355672
10	7.09	1.57	4.72	1.97	3.35	25	355673
12-1/2	8.66	2.17	5.51	2.36	3.74	49	355674
15-3/4	10.63	2.95	7.48	2.36	5.51	95	355675
20, 25	11.02	3.54	7.87	2.36	5.51	99	355676

Type A Back Plates – Series 8212

- Semi-machined
- Rough on chuck side
- For plain back self-centering and independent chucks

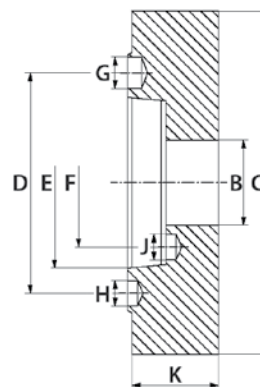

For Chuck Diameter (Inch)	Taper Size	B (Inch)	C (Inch)	D (Inch)	E (Inch)	F (Inch)	G (Inch)	H (Inch)	J (Inch)	K (Inch)	Weight (lbs)	Code
5	6	2.16	5.24	5.25	4.19	3.25	0.77	0.53	0.53	1.30	6.00	355650
6	5	1.50	6.38	4.13	3.25	2.44	0.64	0.47	0.47	1.38	10.52	355652
8	5	1.50	8.39	4.13	3.25	2.44	0.64	0.47	0.47	1.38	20.59	355653
8	6	2.13	8.39	5.25	4.19	3.25	0.77	0.53	0.53	1.52	20.00	355654
10	6	2.13	10.75	5.25	4.19	3.25	0.77	0.53	0.53	1.52	34.87	355655
10	8	3.15	10.75	6.75	5.50	4.37	0.95	0.67	0.67	1.79	38.35	355656
12	6	2.13	12.52	5.25	4.19	3.25	0.77	0.53	0.53	1.52	48.42	355657
12	8	3.15	12.52	6.75	5.50	4.37	0.95	0.67	0.67	1.79	54.43	355658
16	8	3.15	15.94	6.75	5.50	4.37	0.95	0.67	0.67	1.79	92.47	355659
16	11	5.12	15.94	9.25	7.75	6.50	1.16	0.79	0.79	2.09	97.75	355660
25	11	7.59	25.00	9.25	7.75	-	-	-	-	1.77	158.00	355662

Lathe Chuck Accessories

For Bison Self-Centering Lathe Chucks



Hard Solid Outside & Inside Jaws

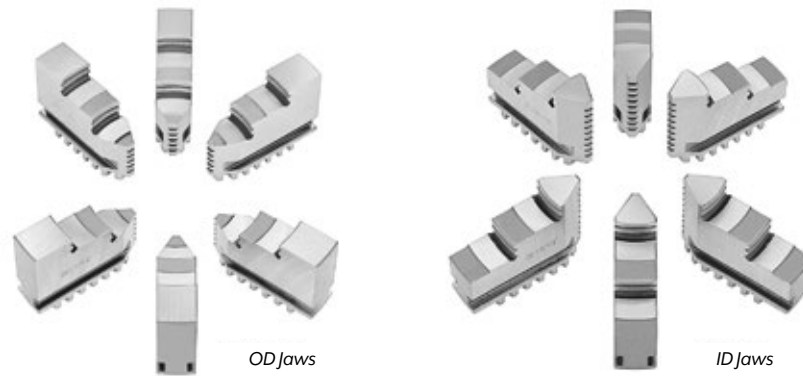

For Chuck Diameter (Inch)	Hard Solid Outside Jaws			Hard Solid Inside Jaws		
	For Series 3200 3-Piece Sets	For Series 3600 4-Piece Sets	For Series 3800 6-Piece Sets	For Series 3200 3-Piece Sets	For Series 3600 4-Piece Sets	For Series 3800 6-Piece Sets
	Code	Code	Code	Code	Code	Code
3	-	-	-	355716	-	-
4	355697	-	-	355717	-	-
5	355698	355704	-	355991	355724	-
6	355989	355705	355712	355992	355725	355732
8	355990	355706	355713	355718	355726	355733
10	355699	355707	355714	355719	355727	-
12	355700	355708	355715	355720	355728	355735
16	355701	-	-	355721	355729	-
20	355702	355710	-	355722	355730	-
25	-	355711	-	-	355731	-

Soft Solid Jaws

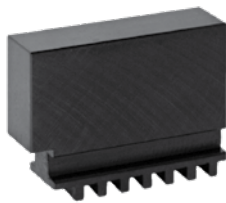

Hard Top Jaws



For Chuck Diameter (Inch)	For Series 3200 & 3500 3-Piece Sets	For Series 3600 4-Piece Sets	For Chuck Diameter (Inch)	For Series 3200 & 3500 3-Piece Sets	For Series 3600 4-Piece Sets	For Series 3800 6-Piece Sets
	Code	Code		Code	Code	Code
3	355736	-	5	355753	355759	-
4	355737	-	6	355754	355760	355767
5	355738	355745	8	355755	355761	355768
6	355993	355746	10	355756	355762	355769
8	355739	-	12	355757	355763	355770
10	355740	355748	16	355303	-	355771
12	355741	355749	20	355304	355765	355772
16	355742	355750	25	355305	355766	355773
20	-	355751				
25	355744	355752				



Lathe Chuck Accessories

For Bison Self-Centering Lathe Chucks

Soft Top Jaws

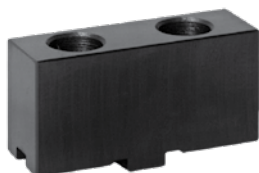

Hard Master Jaws

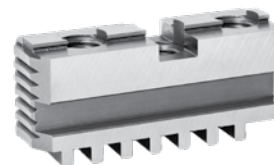

LATHE CHUCKS & ACCESSORIES

For Chuck Diameter (Inch)	For Series 3100 1-Piece	For Series 3200, 3500, 3600 & 3800 1-Piece
	Code	Code
5	-	355779
6	355774	355780
8	355775	355781
10	355776	355782
12	355777	355783
16	355778	355327
20	-	355307
25	-	355308
32	-	355784

For Chuck Diameter (Inch)	For Series 3100 2-Piece Sets	For Series 3200 & 3500 3-Piece Sets	For Series 3600 4-Piece Sets	For Series 3800 6-Piece Sets
	Code	Code	Code	Code
5	-	355790	355798	
6	355785	355791	355799	355806
8	355786	355792	355800	355807
10	355787	355793	355801	355808
12	355788	355794	355802	355809
16	-	355795	355803	355810
20	-	355796	355804	355811
25	-	355797	355805	355812

Pinions



Scroll Plates



For Chuck Diameter (Inch)	For Series 3100, 3200 & 3600 1-Piece	For Series 3500 1-Piece
	Code	Code
3	355813	-
4	355814	-
5	355815	355824
6	355816	355825
8	355817	355826
10	355818	355827
12	355819	355828
16	355820	355829
20	355821	-
25	355822	-
32	355823	-

For Chuck Diameter (Inch)	For Series 3100, 3200 & 3600 1-Piece	For Series 3500 1-Piece
	Code	Code
3	355830	-
4	355831	-
5	355832	355842
6	355833	355843
8	355834	355844
10	355835	355845
12	355836	355846
16	355837	355847
20	355838	-
25	355839	-
32	355840	-

Lathe Chuck Accessories

For Bison Self-Centering & Independent Lathe Chucks

Keys for 3-Jaw & 4-Jaw Chucks & 4-Jaw Independent Chucks



For 3-Jaw & 4-Jaw Chucks – 1 Piece

For 4-Jaw Independent Chucks – 1 Piece

For Chuck Diameter (Inch)	Square (Inch)	Code
3	15/64	355861
4, 5	3/8	355862
10, 12	9/16	355864
16	11/16	355865
20, 25	3/4	355866
32	3/4	355867

For Chuck Diameter (Inch)	Square (Inch)	Code
5, 6	9/32	355868
8, 10	7/16	355869
12, 16	9/16	355870
20, 25	11/16	355871
32	3/4	355872

Hard Top Jaws
1 Piece

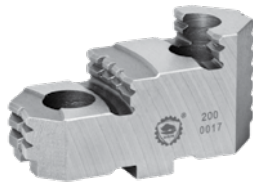

For Chuck Diameter (Inch)	Code
8	355873
10	355874
12	355875
20	355877

Hard Master Jaws
1 Piece

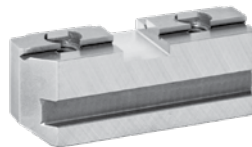

For Chuck Diameter (Inch)	Code
8	355880
10	355881
12	355882
16	355883

Hard Solid Reversible Jaws
1 Piece



For Chuck Diameter (Inch)	Code
8	355898
10	355899
12	355900
25	355903
32	355904

Operating Screws – 1 Piece



For Chuck Diameter (Inch)	Code	For Chuck Diameter (Inch)	Code
3	355887	12	355891
5, 6	355888	16	355892
8	355889	20	355893
10	355890	25	355894
		32	355895

Thrust Bearings – 1 Piece



For Chuck Diameter (Inch)	Code	For Chuck Diameter (Inch)	Code
5, 6	355906	16	355910
8	355907	20	355911
10	355908	25	355912
12	355909	32	355913

Lathe Chuck Accessories

For Bison Lathe Chucks



Studs

Camlock Studs – DIN 55029



Sold individually

Stud & Locknut – DIN 55027



Sold individually

LATHE CHUCKS
& ACCESSORIES

Size (Inch)	Taper Size 1:4	No. of Studs Required	Code
M10 x 0.04 - 1.38	3	3	355678
M10 x 0.04 - 1.46	4	3	355679
M12 x 0.04 - 1.69	5	6	355680
M16 x 0.06 - 1.93	6	6	355681
M20 x 0.06 - 2.19	8	6	355682
M22 x 0.06 - 2.64	11	6	355683

Size (Inch)	Taper Size 1:4	No. of Studs Required	Code
M10 x 1.54	4	3	355691
M10 x 1.69	5	4	355692
M12 x 1.97	6	4	355693
M16 x 2.36	8	4	355694
M20 x 2.95	11	6	355695

Lathe Chuck Accessories

Steel Serrated Soft Jaws – 1.5 x 60° Standard Type | 3-Piece Sets

For Kitagawa Style & Other Power Chucks



* Standard height



Extra height

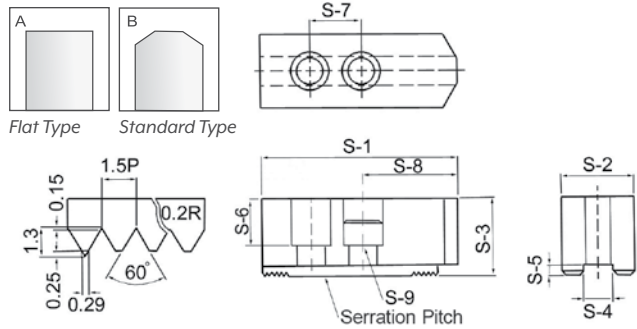

For Chuck Diameter (Inch)	S1 (mm)	S2 (mm)	S3 (mm)	S4 (mm)	S5 (mm)	S6 (mm)	S7 (mm)	S8 (mm)	S9 (mm)	S10 (mm)	S11 (mm)	S12 (mm)	S13 (mm)	S14 Thread	Nose	Code
6	73	31	*31	12	5	15	20	38	17	11	23	-	14	M10	B	302200
6	73	31	50	12	5	15	20	38	17	11	23	-	14	M10	B	302323
6	73	31	80	12	5	15	20	38	17	11	23	-	14	M10	B	302324
8	95	35	*37	14	5	24	25	46	19	13	20	-	16	M12	B	302201
8	95	35	50	14	5	24	25	46	19	13	20	-	16	M12	B	302325
8	95	35	80	14	5	24	25	46	19	13	20	-	16	M12	B	302326
10	110	40	42	16	5	30	30	50	19	13	26	20	18	M12	B	302202
10	110	40	60	16	5	30	30	50	19	13	26	20	18	M12	B	302327
10	110	40	90	16	5	30	30	50	19	13	26	20	18	M12	B	302328
10	110	40	120	16	5	30	30	50	19	13	26	20	18	M12	B	302329
12	129	48	*48	18	6	39	30	60	23	16	30	30	20	M16	B	302203
12	129	48	80	18	6	39	30	60	23	16	30	30	20	M16	B	302331
12	129	48	100	18	6	39	30	60	23	16	30	30	20	M16	B	302333
12	129	48	120	18	6	39	30	60	23	16	30	30	20	M16	B	302335
12	129	48	*48	21	6	39	30	60	23	16	30	30	20	M16	B	302320
12	129	48	80	21	6	39	30	60	23	16	30	30	20	M16	B	302330
12	129	48	100	21	6	39	30	60	23	16	30	30	20	M16	B	302332
12	129	48	120	21	6	39	30	60	23	16	30	30	20	M16	B	302334
15	165	62	*62	22	8	37	43	85	32	21	38	50	-	M20	A	302204
15	165	62	80	22	8	37	43	85	32	21	38	50	-	M20	A	302336
15	165	62	130	22	8	37	43	85	32	21	38	50	-	M20	A	302338
15	165	62	*62	25.5	8	37	43	85	32	21	38	50	-	M20	A	302321
15	165	62	80	25.5	8	37	43	85	32	21	38	50	-	M20	A	302337
15	165	62	130	25.5	8	37	43	85	32	21	38	50	-	M20	A	302339
18	165	62	*62	22	8	37	43	85	32	21	38	50	-	M20	A	302204
18	165	62	150	22	8	37	43	85	32	21	38	50	-	M20	A	302340
18	165	62	*62	25.5	8	37	43	85	32	21	38	50	-	M20	A	302321
18	165	62	150	25.5	8	37	43	85	32	21	38	50	-	M20	A	302322

Steel Serrated Soft Jaws Reference Chart

Major Brand Crossover

For Chuck Diameter (Inch)	KAR Code	Kitigawa	Samchully	Howa	SMW	MMK	Strong
6	302200	BB-06, B-06, B-206, BT-06, BT206	HS-06	HO15M6, HO22M6, HO24M6, HO27M6	170BBM-CC	YA5-6-46	N206
	302323						
	302324						
8	302201	B-08, B208, BB-208, BB208	-	H3KT8, HO15M8, HO7M8	BHM-210, BBM-210, KT8MH	ZA6-9, HA6-8	-
	302325						
	302326						
10	302202	B-10, B-210, BL-210, BLT-210, BB210	HS10, HClO, HCH10, HCH210	H3KT10	ANM250, BHM-250, BBM-250	HA6-10, HA8-10, HA8-11, PC-10-78-A6, PC-10-78-A8	V210, NIT210, NB210, N210
	302327						
	302328						
	302329						
12	302203	B-12, BT-12, HO-12, HOB-12, HOH-12	-	HO12MI2, HO22MI0, HO24MI0, HO27MI0	-	H-12, HA8-12, ZA8-12, ZJA8-12	-
	302331						
	302333						
	302335	B-212, BB-212, BL-212, BLT-212, BL212, BT-212	-	H3KT12	BBM-305, BBM-315, BHM-305, BHM-315	ZA8-12-93B	-
	302320						
	302330						
	302332						
302334							
15	302204	B15, BT-15, B-18, HOH-15K, B-380, B-450, HOB-15, HOB-18, HOH-15, HOH-18, HOH-380	-	-	-	-	-
	302336						
	302338	B-215, NI5, NI8	-	-	-	-	-
	302321						
	302337						
302339							
18	302204	B15, BT-15, B-18, HOH-15K, B-380, B-450, HOB-15, HOB-18, HOH-15, HOH-18, HOH-380	-	-	-	-	-
	302340						
	302321	B-215, NI5, NI8	-	-	-	-	-
	302322						

LATHE CHUCKS & ACCESSORIES

Precision Lathe Chucks & Accessories



PO Series – Forged Steel Body – 3-Jaw Self-Centering Chucks

2 Pc. Hard Reversible Jaws

- Forged steel body, medium duty
- 3 pinion design

Each chuck is provided with:

- 1 set of hard master jaws
- 1 set of hard top reversible jaws
- 1 chuck wrench
- 1 set of mounting bolts
- 2 hex keys
- Eye bolts for chuck sizes larger than 10"

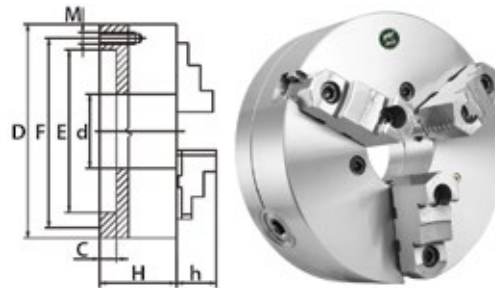

Plain Back Mounting

Chuck Diameter (Inch)	d Hole Diameter (Inch)	RPM Maximum	Model	C (Inch)	E (Inch)	F (Inch)	H (Inch)	h (Inch)	M Thread	Bolt Length (Inch)	No. of Bolts	Code
6	1.65	4500	PO3-6"A	0.16	4.92	5.51	2.76	1.69	M10 x 1.5	0.98	6	410048
8	2.17	4000	PO3-8"A	0.16	6.30	6.93	3.15	1.77	M10 x 1.5	0.98	6	410049
10	2.99	3500	PO3-10"A	0.20	7.87	8.82	3.54	2.09	M12 x 1.75	1.18	6	410050
12	4.06	2800	PO3-12"A	0.20	10.24	11.26	3.94	2.24	M16 x 2	1.18	6	410051
16	5.35	2000	PO3-16"A	0.20	12.99	14.25	4.33	2.69	M16 x 2	1.57	6	410052
20	7.48	1200	PO3-20"A	0.20	16.54	18.03	4.68	3.15	M16 x 2	1.57	6	410053
25	9.92	1000	PO3-25"A	0.28	21.46	23.07	5.08	3.42	M16 x 2	1.57	6	410054

Type A Mounting



Type A1/A2

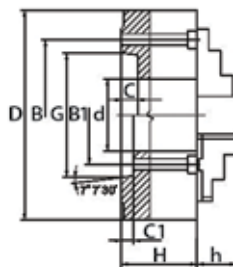

Chuck Diameter (Inch)	d Hole Diameter (Inch)	RPM Maximum	Model	B1 Type A1 (Inch)	B Type A2 (Inch)	* C/C1 (Inch)	G (Inch)	H (Inch)	h (Inch)	M Thread	Bolt Length (Inch)	No. of Bolts	Code
8	2.17	4000	PO3-8"A/A1-6	3.25	-	0.62	4.19	3.07	1.77	1-2/13	2.75	3	410059
10	2.17	3500	PO3-10"A/A1-6	3.25	-	0.62	4.19	3.50	2.09	1-2/13	3.12	6	410060
10	2.99	3500	PO3-10"A/A1-8	4.37	-	0.69	5.50	3.50	2.09	5/8-11	2.75	6	410061
12	4.06	2800	PO3-12"A/A2-6	-	5.25	0.63	4.19	3.79	2.24	1-2/13	4.00	6	410062
12	3.15	2800	PO3-12"A/A1-8	4.37	-	0.69	5.50	3.79	2.24	5/8-11	3.12	6	410063
16	5.12	2000	PO3-16"A/A1-11	6.5	-	0.75	7.75	4.25	2.64	3/4-10	4.50	6	410064
20	7.48	1200	PO3-20"A/A2-11	-	9.25	0.79	7.75	4.68	3.09	3/4-10	4.75	6	410065

* C-C1 = depth of counterbore

Precision Lathe Chucks & Accessories



PO Series – Forged Steel Body – 3-Jaw Self-Centering Chucks

2 Pc. Hard Reversible Jaws (*continued*)

Camlock Mounting

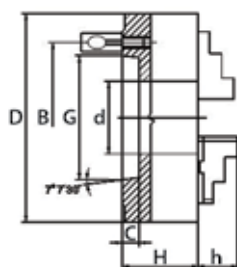

LATHE CHUCKS & ACCESSORIES

Chuck Diameter (Inch)	d Hole Diameter (Inch)	RPM Maximum	Model	B (Inch)	C (Inch)	G (Inch)	H (Inch)	h (Inch)	Camlock Stud Diameter (Inch)	Camlock Stud Thread	No. of Bolts	Code
6	1.65	4500	PO3-6"A/DI-3	2.75	0.51	2.12	2.68	1.69	0.56	M10 x 1.0	3	356361
6	1.65	4500	PO3-6"A/DI-4	3.25	0.51	2.50	2.68	1.69	0.62	M10 x 1.0	3	356362
6	1.65	4500	PO3-6"A/DI-5	4.13	0.56	3.75	2.68	1.69	0.75	M12 x 1.0	6	356363
8	2.17	4000	PO3-8"A/DI-5	4.13	0.56	3.25	3.07	1.77	0.75	M12 x 1.0	6	356364
8	2.17	4000	PO3-8"A/DI-6	5.25	0.63	4.19	3.07	1.77	0.87	M16 x 1.5	6	356365
10	2.99	3500	PO3-10"A/DI-6	5.25	0.63	4.19	3.50	2.09	0.87	M16 x 1.5	6	410055
10	2.99	3500	PO3-10"A/DI-8	6.75	0.71	5.50	3.50	2.09	1.00	M20 x 1.5	6	410056
12	4.06	2800	PO3-12"A/DI-6	5.25	0.63	4.19	3.79	2.24	0.87	M16 x 1.5	6	410057
12	4.06	2800	PO3-12"A/DI-8	6.75	0.71	5.50	3.79	2.24	1.00	M20 x 1.5	6	410058
12	4.06	2800	PO3-12"A/DI-11	9.25	0.79	7.75	4.40	2.24	1.19	M22 x 1.5	6	356366
16	5.35	2000	PO3-16"A/DI-8	6.75	0.71	5.50	4.26	2.64	1.00	M20 x 1.5	6	356367
16	5.35	2000	PO3-16"A/DI-11	9.25	0.79	7.75	4.26	2.64	1.19	M22 x 1.5	6	356368
20	7.60	1200	PO3-20"A/DI-11	9.25	0.79	7.75	4.68	3.15	1.19	M22 x 1.5	6	356369
25	7.48	1000	PO3-25"A/DI-11	9.25	0.79	7.75	5.08	3.42	1.19	M22 x 1.5	6	356370

Spare Jaws for PO Series

Hard jaws, supplied as supplement or as spares, must be ground on the chuck, otherwise centering accuracy does not conform the limits

Hard Top Jaws – 3-Piece Sets

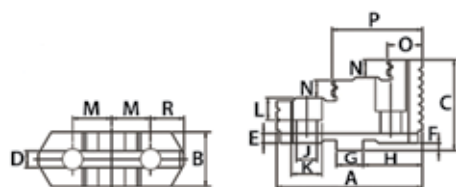

For Chuck Diameter (Inch)	B (Inch)	C (Inch)	D (Inch)	E (Inch)	F (Inch)	G (Inch)	H (Inch)	J (Inch)	K (Inch)	M (Inch)	N (Inch)	A OAL (Inch)	O (Inch)	P (Inch)	Weight (lbs)	Code
6	0.98	1.63	0.31	0.16	0.13	0.50	1.12	0.43	0.71	0.75	0.33	2.64	0.81	1.69	1.20	410140
8	1.18	1.77	0.31	0.16	0.13	0.50	1.37	0.43	0.71	0.87	0.41	3.35	0.98	2.09	2.10	410141
10	1.42	2.09	0.50	0.16	0.13	0.75	1.56	0.55	0.78	1.06	0.53	3.74	1.14	2.52	3.20	410142
12	1.65	2.28	0.50	0.16	0.13	0.75	1.87	0.55	0.78	1.25	0.69	4.25	1.22	3.01	5.10	410143
16	1.77	2.76	0.50	0.16	0.25	0.75	2.25	0.71	1.00	1.50	0.69	5.00	1.85	3.46	7.30	410144
20	1.98	3.42	0.50	0.16	0.25	0.75	2.25	0.87	1.30	1.50	0.79	5.16	2.05	3.23	14.40	410145
25	2.05	3.42	0.50	0.16	0.25	0.75	2.25	0.87	1.30	1.50	0.79	5.16	2.05	3.23	27.10	356302

Precision Lathe Chucks & Accessories



Spare Jaws for PO Series (continued)

Hard jaws, supplied as supplement or as spares, must be ground on the chuck, otherwise centering accuracy does not conform the limits

Hard Master Jaws – 3-Piece Sets

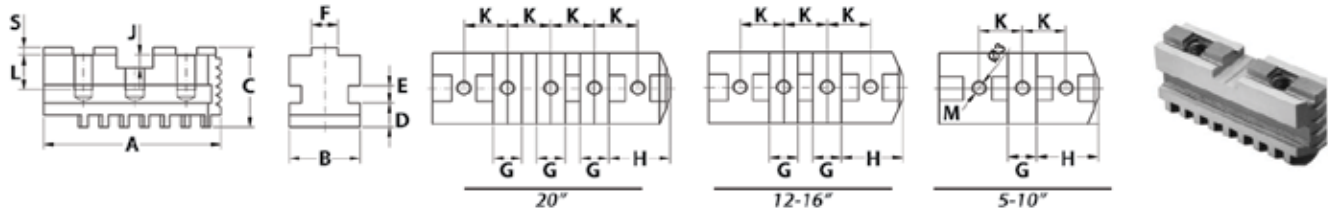

For Chuck Diameter (Inch)	B (Inch)	D (Inch)	E (Inch)	F (Inch)	G (Inch)	H (Inch)	J (Inch)	K (Inch)	L (Inch)	A OAL (Inch)	S (Inch)	M Thread	Weight (lbs)	Code
6	0.79	0.31	0.31	0.31	0.50	1.12	0.16	0.75	0.55	2.56	0.13	3/8-16	1.20	410152
8	0.98	0.35	0.39	0.31	0.50	1.37	0.16	0.87	0.55	3.11	0.13	3/8-16	2.10	410153
10	1.10	0.43	0.47	0.50	0.75	1.56	0.16	1.06	0.63	3.62	0.13	1/2-13	3.20	410154
12	1.26	0.50	0.47	0.50	0.75	1.87	0.16	1.25	0.63	4.33	0.13	1/2-13	5.10	410155
16	1.42	0.59	0.55	0.50	0.75	2.25	0.28	1.50	0.87	5.12	0.25	5/8-11	7.30	410156
20	1.57	0.63	0.55	0.50	0.75	2.25	0.28	1.50	1.26	6.54	0.25	3/4-10	14.40	410157
25	1.97	0.63	0.55	0.50	0.75	2.25	0.28	1.50	1.26	8.27	0.25	3/4-10	27.10	356312

Soft Top Jaws – 1 Piece

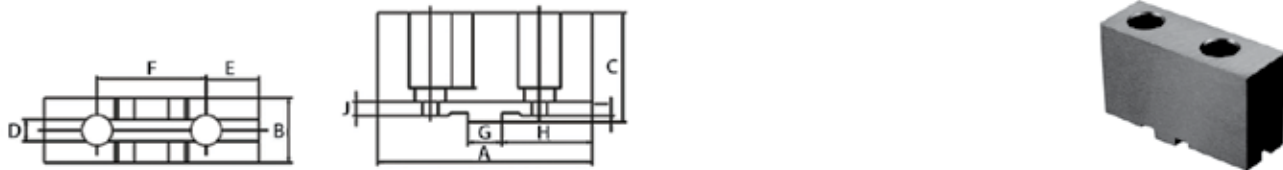

For Chuck Diameter (Inch)	A (Inch)	B (Inch)	C (Inch)	D (Inch)	E (Inch)	F (Inch)	G (Inch)	H (Inch)	I (Inch)	J (Inch)	M Thread	Weight (lbs)	Code
6	3.07	1.00	1.63	0.31	0.84	1.50	0.50	1.34	0.13	0.16	3/8-16	1.01	410146
8	3.54	1.06	1.71	0.31	0.95	1.75	0.50	1.57	0.13	0.16	3/8-16	1.43	410147
10	4.17	1.28	2.03	0.50	1.08	2.12	0.75	1.77	0.13	0.16	1/2-13	2.54	410148
12	4.72	1.57	2.16	0.50	1.21	2.50	0.75	2.09	0.13	0.16	1/2-13	3.53	410149
16	5.51	1.65	2.54	0.50	1.35	3.00	0.75	2.48	0.25	0.16	5/8-11	4.85	410150
20	5.51	1.97	2.93	0.50	1.35	3.00	0.75	2.48	0.25	0.16	3/4-10	5.29	410151
25	6.30	2.05	3.29	0.50	1.35	3.00	0.75	2.48	0.25	0.16	3/4-10	9.26	411044

Precision Lathe Chucks & Accessories



Spare Parts for PO Series

Scroll Plates – 1 Piece



For Chuck Diameter (Inch)	Code
6.25	410116
8.00	410117
10.00	410118
12.50	410119
15.75	410120
20.00	410121

Keys – 1 Piece



For Chuck Diameter (Inch)	Code
6.25	410129
8.00	410129
10.00	410130
12.50	410131
15.75	410132
20.00	410133

Pinions – 1 Piece



For Chuck Diameter (Inch)	Code
6.25	411000
8.00	410104
10.00	410105
12.50	410106
15.75	410107
20.00	411002

Pinion Sleeves – 1 Piece



For Chuck Diameter (Inch)	Code
6.25	411004
8.00	410108
10.00	410109
12.50	410110
15.75	410111
20.00	411006

Half Rings – 1 Piece



For Chuck Diameter (Inch)	Code
6.25	411008
8.00	410112
10.00	410113
12.50	410114
15.75	410115
20.00	411010

LATHE CHUCKS & ACCESSORIES

Universal Lathe Chucks & Accessories



PS Series – Semi-Steel Body – 3-Jaw & 4-Jaw Self-Centering Chucks

2 Pc. Hard Reversible Jaws

- Semi-steel body, medium duty
- 3 pinion design

Each chuck is provided with:

- 1 set of hard master jaws
- 1 set of hard top reversible jaws
- 1 chuck wrench
- 1 set of mounting bolts
- 2 hex keys
- Eye bolts with 10-32" chucks
- Adapters required for plain back mounting

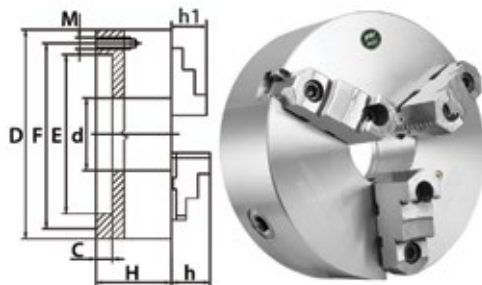

PS Series - Plain Back Mounting Specifications

Chuck Diameter (Inch)	RPM Max	M Thread	L (Inch)	No. of Bolts
5	3200	M8 x 1.25	0.98	3
6	3000	M10 x 1.5	0.98	6
8	2500	M10 x 1.5	0.98	6
10	2000	M12 x 1.75	1.18	6
12	1500	M16 x 2	1.18	6
16	1000	M16 x 2	1.57	6
20	700	M16 x 2	1.57	6
25	500	M16 x 2	1.97	6
32	300	1-8	5.96	6

Plain Back Mounting – 3-Jaw Chucks

Chuck Diameter (Inch)	d Hole (Inch)	Maximum Hole Enlargements (Inch)	Model	C (Inch)	E (Inch)	F (Inch)	H (Inch)	h (Inch)	h1 (Inch)	Code
5	1.26	1.35	PS3-5"A	0.16	3.74	4.25	2.20	1.57	0.79	356373
6	1.65	1.93	PS3-6"A	0.16	4.92	5.51	2.54	1.69	1.26	410009
8	2.17	2.82	PS3-8"A	0.16	6.30	6.93	2.95	1.77	1.14	410010
10	2.99	3.58	PS3-10"A	0.20	7.87	8.82	3.35	2.09	1.34	410003
12	4.06	4.33	PS3-12"A	0.20	10.24	11.26	3.70	2.24	1.69	410007
16	5.35	5.75	PS3-16"A	0.20	12.99	14.25	4.13	2.69	2.16	410008
20	7.48	8.35	PS3-20"A	0.24	16.54	18.03	4.53	3.50	2.20	356374
25	9.92	12.05	PS3-25"A	0.28	21.46	23.07	5.16	3.46	2.76	356375
32	12.60	-	PS3-32"A	0.79	17.72	14.50	6.26	3.46	2.76	356376

Camlock Mounting – 3-Jaw Chucks

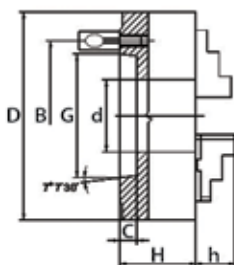

PS Series - Camlock Mounting Specifications

Chuck Diameter (Inch)	RPM Max	Weight (lbs)	Taper Size	Camlock Stud Diameter (Inch)	Camlock Stud Thread	No. of Studs
5	3200	11	DI-4	0.62	M10 x 1.0	3
6	3000	20	DI-3	0.56	M10 x 1.0	3
6	3000	20	DI-4	0.62	M10 x 1.0	3
8	2500	42	DI-3	0.56	M10 x 1.0	3
8	2500	42	DI-4	0.62	M10 x 1.0	3
8	2500	42	DI-5	0.75	M12 x 1.0	6
8	2500	42	DI-6	0.87	M16 x 1.5	6
10	2000	71	DI-5	0.75	M12 x 1.0	6
10	2000	71	DI-6	0.87	M16 x 1.5	6
10	2000	71	DI-8	1.00	M20 x 1.5	6
12	1500	112	DI-6	0.87	M16 x 1.5	6
12	1500	112	DI-8	1.00	M20 x 1.5	6
12	1500	112	DI-11	1.19	M22 x 1.5	6
16	1000	223	DI-6	0.87	M16 x 1.5	6
16	1000	223	DI-8	1.00	M20 x 1.5	6
16	1000	223	DI-11	1.19	M22 x 1.5	6
20	700	331	DI-8	1.00	M20 x 1.5	6
20	700	331	DI-11	1.19	M22 x 1.5	6
25	500	604	DI-11	1.19	M22 x 1.5	6

Universal Lathe Chucks & Accessories



PS Series – Semi-Steel Body – 3-Jaw & 4-Jaw Self-Centering Chucks

2 Pc. Hard Reversible Jaws (*continued*)

Camlock Mounting – 3-Jaw Chucks (*continued*)

LATHE CHUCKS & ACCESSORIES

Chuck Diameter (Inch)	d Hole Diameter (Inch)	Maximum Hole Enlargements (Inch)	Model	B (Inch)	C (Inch)	G (Inch)	H (Inch)	h (Inch)	Code
5	1.26	1.26	PS3-5"A/DI-4	3.25	0.51	2.50	2.76	1.57	356350
6	1.65	1.97	PS3-6"A/DI-3	2.78	0.51	2.12	3.21	1.69	356351
6	1.65	1.97	PS3-6"A/DI-4	3.25	0.51	2.50	3.21	1.69	410011
8	2.03	2.03	PS3-8"A/DI-3	2.78	0.51	2.12	3.58	1.77	356352
8	2.17	2.36	PS3-8"A/DI-4	3.25	0.51	2.50	3.58	1.77	356353
8	2.17	2.64	PS3-8"A/DI-5	4.13	0.56	3.25	3.58	1.77	356354
8	2.17	2.64	PS3-8"A/DI-6	5.25	0.56	4.19	3.58	1.77	410012
10	2.99	2.99	PS3-10"A/DI-5	4.13	0.56	3.25	4.07	2.09	356355
10	2.99	3.74	PS3-10"A/DI-6	5.25	0.63	4.19	4.07	2.09	410013
10	2.99	3.74	PS3-10"A/DI-8	6.75	0.71	5.50	4.07	2.09	410014
12	4.06	4.06	PS3-12"A/DI-6	5.25	0.63	4.19	4.63	2.24	410015
12	4.06	4.53	PS3-12"A/DI-8	6.75	0.71	5.50	4.63	2.24	410006
12	4.06	4.50	PS3-12"A/DI-11	9.25	0.79	7.75	5.51	2.24	410016
16	4.06	4.06	PS3-16"A/DI-6	5.25	0.63	4.19	5.06	2.64	356356
16	5.35	5.35	PS3-16"A/DI-8	6.75	0.71	5.50	5.06	2.64	410017
16	5.35	5.91	PS3-16"A/DI-11	9.25	0.79	7.75	5.06	2.64	410018
20	5.35	5.35	PS3-20"A/DI-8	6.75	0.71	5.50	5.67	3.50	356357
20	7.59	7.60	PS3-20"A/DI-11	9.25	0.79	7.75	5.67	3.50	410019
25	7.59	7.60	PS3-25"A/DI-11	9.25	0.79	7.75	6.50	3.46	356358

Front Mounting – 3-Jaw & 4-Jaw Chucks

- Semi-steel body, medium duty
- 3-jaw chuck has 3 pinion design, 4-jaw chuck has 2 pinion design
- Designed for use on grinders, lathes, rotary tables, indexers and a variety of turning and milling applications where back mounting chucks cannot be used

Each chuck is provided with:

- 1 set of hard master jaws
- 1 set of hard top reversible jaws
- 1 chuck wrench
- 1 set of mounting bolts
- 2 hex keys
- Eye bolts with 10-32" chucks



Chuck Diameter (Inch)	d Hole Diameter (Inch)	C (Inch)	E (H7) (Inch)	F (Inch)	H (Inch)	h (Inch)	h1 (Inch)	G Screw Thread	M Bolt Thread	3-Jaw Chucks		4-Jaw Chucks	
										Model	Code	Model	Code
6	1.65	0.16	4.92	5.51	2.56	1.69	1.26	3/8-16 x 2.76	M10	PS3-6"A(F)	410000	PS4-6"A(F)	410020
8	2.17	0.16	6.30	6.93	2.95	1.77	1.14	3/8-16 x 3.15	M10	PS3-8"A(F)	410001	PS4-8"A(F)	410021
10	2.99	0.20	7.87	8.82	3.35	2.09	1.34	1/2-13 x 3.54	M12	PS3-10"A(F)	410002	PS4-10"A(F)	410022
12	4.06	0.20	10.24	11.26	3.70	2.24	1.69	5/8-11 x 3.94	M16	PS3-12"A(F)	410004	PS4-12"A(F)	410023
16	5.35	0.20	12.99	14.25	4.13	2.64	2.16	5/8-11 x 4.53	M16	PS3-16"A(F)	410005	PS4-16"A(F)	410024

Universal Lathe Chucks & Accessories



Spare Jaws for PS Series Universal

Hard jaws, supplied as supplement or as spares, must be ground on the chuck, otherwise centering accuracy does not conform the limits

Hard Top Jaws – 3-Piece Sets

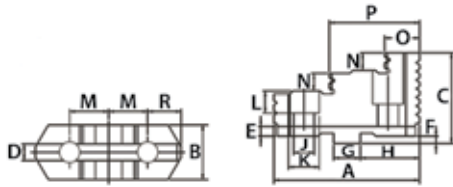

For Chuck Diameter (Inch)	B (Inch)	C (Inch)	D (Inch)	E (Inch)	F (Inch)	G (Inch)	H (Inch)	J (Inch)	K (Inch)	M (Inch)	N (Inch)	A OAL (Inch)	O (Inch)	P (Inch)	Weight (lbs)	Code
5	0.87	1.52	0.31	0.16	0.13	0.50	0.89	0.35	0.55	0.62	0.31	2.20	0.57	1.38	0.93	356300
6	0.98	1.63	0.31	0.16	0.13	0.50	1.12	0.43	0.67	0.75	0.33	2.64	0.81	1.69	1.20	410140
8	1.18	1.77	0.31	0.16	0.13	0.50	1.37	0.43	0.67	0.87	0.41	3.15	0.98	2.09	2.10	410141
10	1.42	2.09	0.50	0.16	0.13	0.75	1.56	0.55	0.79	1.06	0.53	3.74	1.14	2.52	3.20	410142
12	1.65	2.40	0.50	0.16	0.13	0.75	1.87	0.55	0.79	1.25	0.69	4.25	1.22	3.01	5.10	410143
16	1.77	2.76	0.50	0.16	0.25	0.75	2.25	0.71	1.00	1.50	0.69	5.00	1.85	3.46	7.30	410144
20	1.98	3.42	0.50	0.16	0.25	0.75	2.25	0.87	1.30	1.50	0.79	5.16	2.05	3.23	14.40	410145
25 & 32	2.05	3.42	0.50	0.16	0.25	0.75	2.25	0.87	1.30	1.50	0.79	5.16	2.05	3.23	27.10	356301

Hard Top Jaws – 4-Piece Sets

For Chuck Diameter (Inch)	B (Inch)	C (Inch)	D (Inch)	E (Inch)	F (Inch)	G (Inch)	H (Inch)	J (Inch)	K (Inch)	M (Inch)	N (Inch)	A OAL (Inch)	O (Inch)	P (Inch)	Weight (lbs)	Code
5	0.87	1.52	0.31	0.16	0.13	0.50	0.89	0.35	0.55	0.62	0.31	2.20	0.57	1.38	1.25	356303
6	0.98	1.63	0.31	0.16	0.13	0.50	1.12	0.43	0.67	0.75	0.33	2.64	0.81	1.69	1.60	356304
8	1.18	1.77	0.31	0.16	0.13	0.50	1.37	0.43	0.67	0.87	0.41	3.15	0.98	2.09	2.80	356305
10	1.42	2.09	0.50	0.16	0.13	0.75	1.56	0.55	0.79	1.06	0.53	3.74	1.14	2.52	4.27	356306
12	1.65	2.40	0.50	0.16	0.13	0.75	1.87	0.55	0.79	1.25	0.69	4.25	1.22	3.01	6.80	356307
16	1.77	2.76	0.50	0.16	0.25	0.75	2.25	0.71	1.00	1.50	0.69	5.00	1.85	3.46	9.74	356308
20	1.98	3.42	0.50	0.16	0.25	0.75	2.25	0.87	1.30	1.50	0.79	5.16	2.05	3.23	19.20	356309
25	2.05	3.42	0.50	0.16	0.25	0.75	2.25	0.87	1.30	1.50	0.79	5.16	2.05	3.23	36.20	356310

Soft Top Jaws – 1 Piece

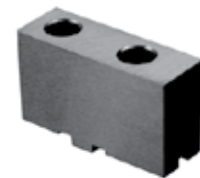
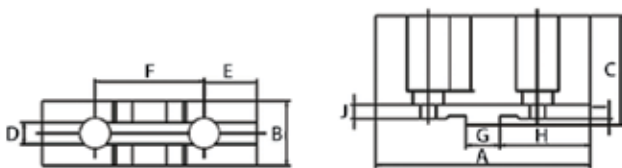

For Chuck Diameter (Inch)	A (Inch)	B (Inch)	C (Inch)	D (Inch)	E (Inch)	F (Inch)	G (Inch)	H (Inch)	I (Inch)	J (Inch)	M Thread	Weight (lbs)	Code
5	2.52	0.87	1.52	0.31	0.59	1.25	0.50	1.00	0.13	0.16	5/16-18	0.66	356314
6	3.07	1.00	1.63	0.31	0.84	1.50	0.50	1.34	0.13	0.16	3/8-16	1.01	410146
8	3.54	1.06	1.71	0.31	0.95	1.75	0.50	1.57	0.13	0.16	3/8-16	1.43	410147
10	4.17	1.28	2.03	0.50	1.08	2.12	0.75	1.77	0.13	0.16	1/2-13	2.54	410148
12	4.72	1.57	2.16	0.50	1.21	2.50	0.75	2.09	0.13	0.16	1/2-13	3.53	410149
16	5.51	1.65	2.54	0.50	1.35	3.00	0.75	2.48	0.25	0.16	5/8-11	4.85	410150
20	5.51	1.97	2.93	0.50	1.35	3.00	0.75	2.48	0.25	0.16	3/4-10	5.29	410151
25 & 32	6.30	2.05	3.29	0.50	1.35	3.00	0.75	2.48	0.25	0.16	3/4-10	9.26	411044

Universal Lathe Chucks & Accessories



Spare Jaws for PS Series Universal (continued)

Hard jaws, supplied as supplement or as spares, must be ground on the chuck, otherwise centering accuracy does not conform the limits

Hard Master Jaws – 3-Piece Sets

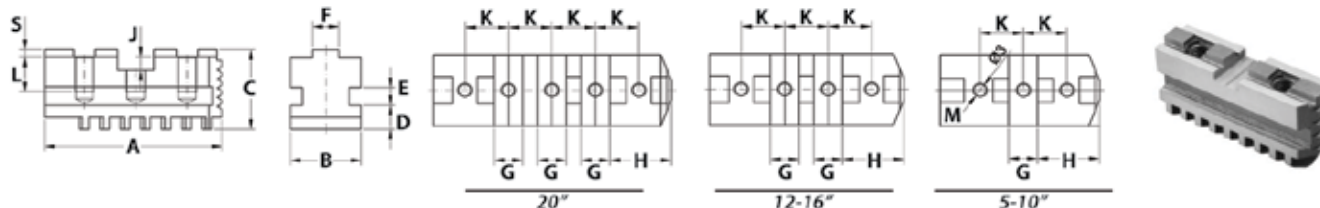

For Chuck Diameter (Inch)	B (Inch)	D (Inch)	E (Inch)	F (Inch)	G (Inch)	H (Inch)	J (Inch)	K (Inch)	L (Inch)	A OAL (Inch)	S (Inch)	M Thread	Weight (lbs)	Code
5	0.79	0.31	0.31	0.31	0.50	0.89	0.16	0.62	0.53	2.13	0.13	5/16-8	0.93	356311
6	0.79	0.31	0.31	0.31	0.50	1.12	0.16	0.75	0.55	2.56	0.13	3/8-16	1.20	410152
8	0.98	0.35	0.39	0.31	0.50	1.37	0.16	0.87	0.55	3.11	0.13	3/8-16	2.10	410153
10	1.10	0.43	0.47	0.50	0.75	1.56	0.16	1.06	0.63	3.62	0.13	1/2-13	3.20	410154
12	1.26	0.50	0.47	0.50	0.75	1.87	0.16	1.25	0.63	4.33	0.13	1/2-13	5.10	410155
16	1.42	0.59	0.55	0.50	0.75	2.25	0.28	1.50	0.87	5.12	0.13	5/8-11	7.30	410156
20	1.57	0.63	0.55	0.50	0.75	2.25	0.28	1.50	1.26	6.54	0.13	3/4-10	14.40	410157
25 & 32	1.97	0.63	0.55	0.50	0.75	2.25	0.28	1.50	1.26	8.27	0.13	3/4-10	27.10	356312

Hard Master Jaws – 4-Piece Sets

For Chuck Diameter (Inch)	B (Inch)	D (Inch)	E (Inch)	F (Inch)	G (Inch)	H (Inch)	J (Inch)	K (Inch)	L (Inch)	A OAL (Inch)	S (Inch)	M Thread	Weight (lbs)	Code
5	0.79	0.31	0.31	0.31	0.50	0.89	0.16	0.62	0.53	2.13	0.13	5/16-8	1.25	356315
6	0.79	0.31	0.31	0.31	0.50	1.12	0.16	0.75	0.55	2.56	0.13	3/8-16	1.60	356316
8	0.98	0.35	0.39	0.31	0.50	1.37	0.16	0.87	0.55	3.11	0.13	3/8-16	2.80	356317
10	1.10	0.43	0.47	0.50	0.75	1.56	0.16	1.06	0.63	3.62	0.13	1/2-13	4.27	356318
12	1.26	0.50	0.47	0.50	0.75	1.87	0.16	1.25	0.63	4.33	0.13	1/2-13	6.80	356319
16	1.42	0.59	0.55	0.50	0.75	2.25	0.28	1.50	0.87	5.12	0.13	5/8-11	9.74	356320
20	1.57	0.63	0.55	0.50	0.75	2.25	0.28	1.50	1.26	6.54	0.13	3/4-10	19.20	356321
25	1.97	0.63	0.55	0.50	0.75	2.25	0.28	1.50	1.26	8.27	0.13	3/4-10	36.20	356322

LATHE CHUCKS & ACCESSORIES

Universal Lathe Chucks & Accessories



Spare Parts for PS Series

Scroll Plates – 1 Piece



For Chuck Diameter (Inch)	Code
6.25	410116
8.00	410117
10.00	410118
12.50	410119
15.75	410120
20.00	410121

Keys – 1 Piece



For Chuck Diameter (Inch)	Code
6.25	410129
8.00	410129
10.00	410130
12.50	410131
15.75	410132
20.00	410133

Pinions – 1 Piece



For Chuck Diameter (Inch)	Code
6.25	410122
8.00	410123
10.00	410124
12.50	410125
15.75	410126
20.00	410127

Pinion Screws – 1 Piece



For Chuck Diameter (Inch)	Code
6.25	410134
8.00	410135
10.00	410136
12.50	410137
15.75	410138
20.00	410139

Precision Lathe Chucks & Accessories



PSL Series – Steel Body – Large Through Hole – 3-Jaw Self-Centering Chucks

2 Pc. Hard Reversible Jaws

- Forged steel body, plain back, medium duty
- 2-piece reversible American Standard tongue and groove jaws
- Designed for pipe machining or pipe welding cut-off operations
- Can be used on grinders, lathes, rotary tables, indexers and welding devices
- Jaws, scroll plate and three pinions are made of fine alloy steel, carefully heat-treated and ground
- Balanced scroll

Each chuck is provide with:

- 1 set of master jaws
- 1 set of hard top jaws
- 1 chuck wrench
- 1 set of mounting screws
- 2 hex keys
- 2 lifting eye bolts

Optional spare parts:

- Soft top jaws

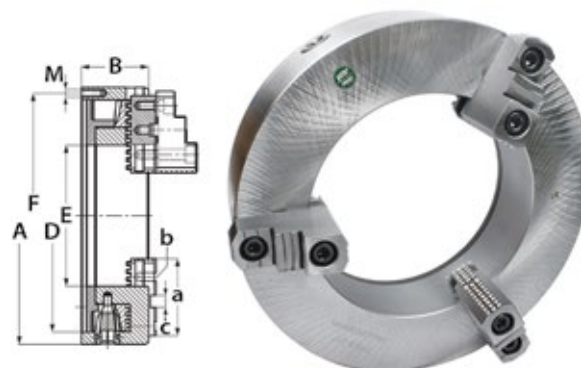

Plain Back Mounting

PSL Series - Plain Back Mounting Specifications

Chuck Diameter (Inch)	RPM Max	Weight (lbs)	d1 Min-Max (Inch)	d2 Min-Max (Inch)	d3 Min-Max (Inch)	M Thread	Jaw Stroke Min-Max (Inch)	Weight of Workpiece without Support (lbs)	Weight of Workpiece with Support (lbs)
16	650	128	5.12 - 10.63	9.06 - 13.78	11.81 - 15.75	M12 x 40	6.61 - 11.34	110	3301
20	460	168	9.84 - 14.96	12.99 - 17.72	15.16 - 19.69	M16 x 40	9.87 - 14.96	177	5512
26	325	258	14.80 - 18.50	17.91 - 22.64	20.28 - 25.00	M16 x 40	14.80 - 19.57	265	7716
32	260	468	10.24 - 22.28	14.17 - 29.53	16.54 - 31.50	M24 x 160	7.40 - 22.28	441	8820

Chuck Diameter (Inch)	Model	a (Inch)	B (Inch)	b (Inch)	c (Inch)	D H7 (Inch)	F (Inch)	E Through Hole (Inch)	Code
16	PSL3-16"	4.72	4.13	5/8-11	0.75	14.25	15.00	8.66	410025
20	PSL3-20"	4.72	4.72	3/4-10	0.75	18.19	18.96	12.60	410026
26	PSL3-26"	5.00	5.32	3/4-10	0.75	22.83	24.41	15.98	356359
32	PSL3-32"	8.86	5.95	3/4-10	0.75	27.95	18.11	16.14	356360

Spare Jaws for PSL Series

Hard jaws, supplied as supplement or as spares, must be ground on the chuck, otherwise centering accuracy does not conform the limits

Hard Master Jaws – 3-Piece Set

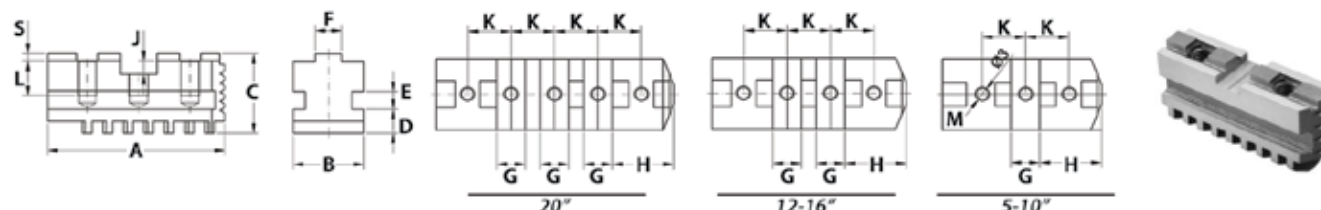

For Chuck Diameter (Inch)	B (Inch)	D (Inch)	E (Inch)	F (Inch)	G (Inch)	H (Inch)	J (Inch)	K (Inch)	L (Inch)	A OAL (Inch)	S (Inch)	Weight (lbs)	M Thread	Code
16	1.42	0.59	0.55	0.50	0.75	2.25	0.28	1.50	0.87	4.72	0.13	9.00	5/8-11	410166
20	1.57	0.63	0.55	0.50	0.75	2.25	0.28	1.50	1.28	4.72	0.13	10.10	3/4-10	410167
26	1.97	0.63	0.55	0.50	0.75	2.25	0.28	1.50	1.28	5.00	0.13	16.00	3/4-10	356371
32	1.97	0.63	0.55	0.50	0.75	2.25	0.28	1.50	1.28	8.86	0.13	28.00	3/4-10	356372

Precision Lathe Chucks & Accessories



Spare Jaws for PSL Series (continued)

Hard jaws, supplied as supplement or as spares, must be ground on the chuck, otherwise centering accuracy does not conform the limits

Hard Top Jaws – 3-Piece Sets

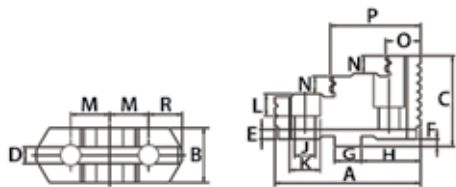

For Chuck Diameter (Inch)	B (Inch)	C (Inch)	D (Inch)	E (Inch)	F (Inch)	G (Inch)	H (Inch)	J (Inch)	K (Inch)	M (Inch)	N (Inch)	A OAL (Inch)	O (Inch)	P (Inch)	Weight (lbs)	Code
16	1.77	2.76	0.50	0.16	0.25	0.75	2.25	0.71	1.00	1.50	0.69	5.00	1.85	3.46	7.30	410144
20	1.98	3.42	0.50	0.16	0.25	0.75	2.25	0.87	1.30	1.50	0.79	5.16	2.05	3.23	14.40	410145
26 & 32	2.05	3.42	0.50	0.16	0.25	0.75	2.25	0.87	1.30	1.50	0.79	5.16	2.05	3.23	27.10	356302

Soft Top Jaws – 1-Piece

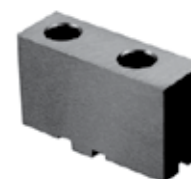
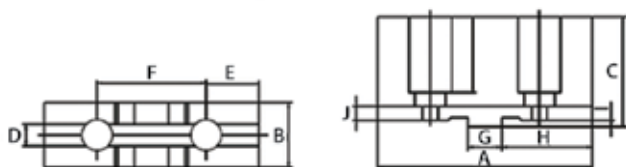

For Chuck Diameter (Inch)	A (Inch)	B (Inch)	C (Inch)	D (Inch)	E (Inch)	F (Inch)	G (Inch)	H (Inch)	I (Inch)	J (Inch)	Weight (lbs)	M Thread	Code
16	5.51	1.65	2.54	0.50	1.35	3.00	0.75	2.48	0.25	0.16	4.85	5/8-11	410150
20	5.51	1.97	2.93	0.50	1.35	3.00	0.75	2.48	0.25	0.16	5.29	3/4-10	410151
26 & 32	6.30	2.05	3.29	0.50	1.35	3.00	0.75	2.48	0.25	0.16	9.26	3/4-10	411044

Spare Parts for PSL Series

Scroll Plates – 1 Piece



For Chuck Diameter (Inch)	Code
15.75	410172
20.00	410173

Keys – 1 Piece



For Chuck Diameter (Inch)	Code
15.75	411012
20.00	411014

Pinions – 1 Piece



For Chuck Diameter (Inch)	Code
15.75	410174
20.00	410175

Pinion Screw – 1 Piece



For Chuck Diameter (Inch)	Code
20.00	411016

Mounting Bolts – 1 Piece



For Chuck Diameter (Inch)	Code
15.75	410179
20.00	410180

Independent Lathe Chucks & Accessories



PI Series – Semi-Steel Body – 4-Jaw Independent Chucks

Solid Reversible Jaws

- Semi-steel body, medium duty
- Designed to grip round or odd shaped workpieces
- Hard solid reversible jaws
- Chucks larger than 10" with T-slots

Each chuck is provided with:

- 1 set of hard solid reversible jaws
- 1 T- wrench
- 2 hex keys
- 1 set of mounting bolts
- 2 eye bolts for chucks larger than 10"

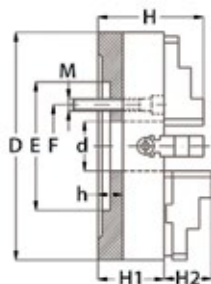

Plain Back Mounting

Chuck Diameter (Inch)	d Hole Diameter (Inch)	RPM Maximum	Model	E (Inch)	F (Inch)	H1 (Inch)	H2 (Inch)	H (Inch)	h	Code
8	2.20	2500	PI4-8"	2.95	3.74	2.95	0.24	4.33	0.24	410027
10	2.56	2000	PI4-10"	5.91	4.13	3.35	0.28	4.70	0.28	410028
12	3.15	1500	PI4-12"	6.89	5.25	3.74	0.28	5.70	0.28	410029
16	3.94	1000	PI4-16"	7.87	6.75	4.13	0.39	6.09	0.39	410031
20	4.92	700	PI4-20"	10.63	9.25	4.72	0.47	7.07	0.47	410032
25	6.30	500	PI4-25"	10.63	9.25	5.51	0.47	7.87	0.47	410033
32	8.27	300	PI4-32"	9.84	11.81	5.71	0.47	8.27	0.47	410034

Camlock Mounting

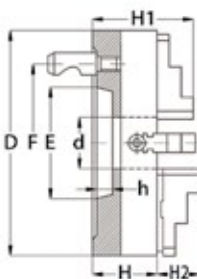

Chuck Diameter (Inch)	d Hole Diameter (Inch)	RPM Maximum	Model	E (Inch)	F (Inch)	H (Inch)	h (Inch)	H1 (Inch)	Taper Size	Code
8	2.20	2500	PI4-8"/D1-4	2.50	3.25	2.95	0.51	4.33	D1-4	410035
8	2.20	2500	PI4-8"/D1-5	3.25	4.13	2.95	0.59	4.33	D1-5	410036
10	2.36	2000	PI4-10"/D1-4	2.50	3.25	3.35	0.51	4.70	D1-4	410037
10	2.56	2000	PI4-10"/D1-5	3.25	4.13	3.35	0.59	4.70	D1-5	410038
10	2.56	2000	PI4-10"/D1-6	4.19	5.25	3.35	0.63	4.70	D1-6	410039
12	3.15	1500	PI4-12"/D1-6	4.19	5.25	3.74	0.63	5.70	D1-6	410040
12	3.15	1500	PI4-12"/D1-8	5.50	6.75	3.74	0.71	5.70	D1-8	410041
16	3.94	1000	PI4-15"/D1-6	4.19	5.25	4.13	0.63	6.09	D1-6	410042
16	3.94	1000	PI4-15"/D1-8	5.50	6.75	4.13	0.71	6.09	D1-8	410043
16	3.94	1000	PI4-15"/D1-11	7.75	9.25	4.13	0.79	6.09	D1-11	410044
20	4.92	700	PI4-20"/D1-8	5.50	6.75	4.72	0.71	7.07	D1-8	410045
20	4.92	700	PI4-20"/D1-11	7.75	9.25	4.72	0.79	7.07	D1-11	410046
25	6.30	500	PI4-25"/D1-11	7.75	9.25	5.51	0.79	7.87	D1-11	410047

LATHE CHUCKS & ACCESSORIES

Independent Lathe Chucks & Accessories



PI Series – Semi-Steel Body – 4-Jaw Independent Chucks (continued)

2 Pc. Hard Reversible Jaws

- Semi-steel body, medium duty
- Designed to grip round or odd shaped workpieces
- 2-piece reversible ANSI tongue and groove jaws
- Chucks larger than 10" with T-slots

Each chuck is provided with:

- 1 set of 2-piece hard reversible jaws
- 1 T-wrench
- 2 hex keys
- 1 set of mounting bolts
- 2 eye bolts for chucks larger than 10"

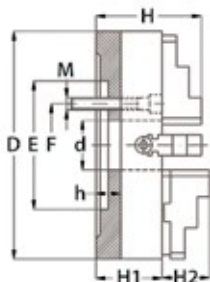

Plain Back Mounting

Chuck Diameter (Inch)	d Hole Diameter (Inch)	RPM Maximum	Model	E (Inch)	F (Inch)	Hole Enlargement (Inch)	H (Inch)	H1 (Inch)	H2 (Inch)	h (Inch)	Code
8	2.20	2500	PI4-8"A	2.95	3.74	2.28	2.95	1.83	1.83	0.24	410214
10	2.56	2000	PI4-10"A	5.91	4.13	2.65	3.35	2.38	2.38	0.28	410215
12	3.15	1500	PI4-12"A	6.89	5.25	3.86	3.74	2.40	2.40	0.28	410216
16	3.94	1000	PI4-16"A	7.87	6.75	4.62	4.13	2.85	2.85	0.39	410217
20	4.92	700	PI4-20"A	10.63	9.25	6.27	4.72	3.56	3.56	0.47	410218
25	6.30	500	PI4-25"A	10.63	9.25	7.09	5.51	3.85	3.85	0.47	410219

Camlock Mounting

Chuck Diameter (Inch)	d Hole Diameter (Inch)	RPM Maximum	Model	E (Inch)	F (Inch)	H2 (Inch)	H (Inch)	H1 (Inch)	h (Inch)	Bolt Thread	L Bolt	Code
8	2.20	1800	PI4-8"A/DI-4	2.50	3.25	1.83	2.95	0.51	0.62	M10 x 1.0	3	410200
8	2.20	1800	PI4-8"A/DI-5	3.25	4.13	1.83	2.95	0.59	0.75	M12 x 1.0	6	410201
10	2.36	1500	PI4-10"A/DI-4	2.50	3.25	2.38	3.35	0.51	0.62	M10 x 1.0	3	410202
10	2.56	1500	PI4-10"A/DI-5	3.25	4.13	2.38	3.35	0.59	0.75	M12 x 1.0	6	410203
10	2.56	1500	PI4-10"A/DI-6	4.19	5.25	2.38	3.35	0.63	0.87	M16 x 1.5	6	410204
12	3.15	1200	PI4-12"A/DI-6	4.19	5.25	2.40	3.74	0.63	0.87	M16 x 1.5	6	410205
12	3.15	1200	PI4-12"A/DI-8	5.50	6.75	2.40	3.74	0.71	1.00	M20 x 1.5	6	410206
16	3.94	800	PI4-15"A/DI-6	4.19	5.25	2.85	4.13	0.63	0.87	M16 x 1.5	6	410207
16	3.94	800	PI4-16"A/DI-8	5.50	6.75	2.85	4.13	0.71	1.00	M20 x 1.5	6	410208
16	3.94	800	PI4-16"A/DI-11	7.75	9.25	2.85	4.13	0.79	1.19	M22 x 1.5	6	410209
20	4.92	500	PI4-20"A/DI-8	5.50	6.75	3.56	4.72	0.71	1.00	M20 x 1.5	6	410210
20	4.92	500	PI4-20"A/DI-11	7.75	9.25	3.56	4.72	0.79	1.19	M22 x 1.5	6	410211
25	6.30	400	PI4-25"A/DI-11	7.75	9.25	3.85	5.51	0.79	1.19	M22 x 1.5	6	410212

Independent Lathe Chucks & Accessories



Spare Jaws for PI Series

Hard jaws, supplied as supplement or as spares, must be ground on the chuck, otherwise centering accuracy does not conform the limits

Hard Solid Reversible Jaws – 4-Piece Sets

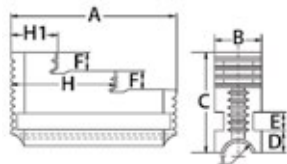

LATHE CHUCKS & ACCESSORIES

For Chuck Diameter (Inch)	A (Inch)	B (Inch)	C (Inch)	D (Inch)	E (Inch)	F (Inch)	H (Inch)	HI (Inch)	Thread	Weight (lbs)	Code
8	3.35	1.06	2.42	0.45	0.39	0.47	2.28	1.20	24 x 4 sq.	1.54	411020
10	3.62	1.06	2.42	0.45	0.39	0.47	2.58	1.20	24 x 4 sq.	1.65	411022
12	4.37	1.57	3.01	0.38	0.47	0.71	2.64	1.06	Tr32 x 6	3.31	411024
16	5.08	1.57	3.01	0.38	0.47	0.71	3.09	1.28	Tr32 x 6	3.97	411026
20	6.00	2.05	3.68	0.46	0.59	0.87	3.66	1.39	Tr36 x 6	7.50	411028
25	6.97	2.05	3.96	0.62	0.71	0.98	4.29	1.77	Tr40 x 6	8.80	411030
32	7.95	2.76	4.51	0.62	0.79	0.98	4.80	1.73	Tr40 x 8	18.00	411032

Hard Top Jaws – 4-Piece Sets

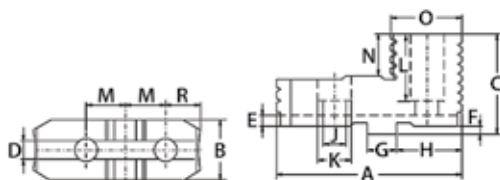

For Chuck Diameter (Inch)	B (Inch)	C (Inch)	D (Inch)	E (Inch)	F (Inch)	G (Inch)	H (Inch)	J (Inch)	K (Inch)	M (Inch)	N (Inch)	A OAL (Inch)	O (Inch)	P (Inch)	Weight (lbs)	Code
8	1.34	1.71	0.31	0.16	0.13	0.50	1.39	0.43	0.71	0.88	0.37	3.23	0.87	2.09	1.65	411048
10	1.34	2.03	0.50	0.16	0.13	0.75	1.57	0.55	0.79	1.03	0.47	3.80	0.98	2.44	2.25	411050
12	1.65	2.17	0.50	0.16	0.13	0.75	1.89	0.55	0.79	1.25	0.51	4.43	1.06	2.78	3.40	411052
16	1.65	2.54	0.50	0.16	0.25	0.75	2.26	0.71	1.02	1.50	0.53	5.08	1.04	3.11	4.50	411054
20	2.13	2.93	0.50	0.16	0.25	0.75	2.28	0.89	1.30	1.50	0.71	5.35	1.48	3.43	7.00	411056
25	2.13	3.23	0.50	0.16	0.25	0.75	2.28	0.89	1.30	1.50	0.83	5.35	1.48	3.43	7.60	411058
32	2.83	3.46	0.50	0.16	0.25	0.75	2.28	0.89	1.30	1.50	0.94	5.35	1.57	3.50	11.00	411060

Soft Top Jaws – 1-Piece

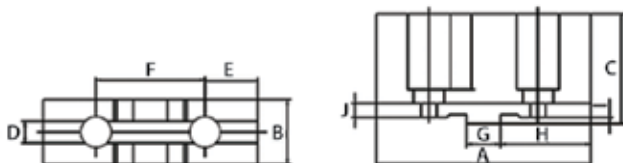

For Chuck Diameter (Inch)	A (Inch)	B (2) (Inch)	C (Inch)	D (Inch)	E (Inch)	F (Inch)	G (Inch)	H (Inch)	I (Inch)	J (Inch)	M Thread	Weight (lbs)	Code
8	3.54	1.06	1.71	0.31	0.95	1.75	0.50	1.57	0.13	0.28	3/8-16	1.43	411034
12	4.72	1.57	2.16	0.50	1.21	2.50	0.75	2.09	0.25	0.28	1/2-13	3.53	411038
25 & 32	6.30	2.05	3.29	0.50	1.35	3.00	0.75	2.48	0.25	0.41	3/4-10	9.26	411044

Independent Lathe Chucks & Accessories



Spare Jaws for PI Series

Hard jaws, supplied as supplement or as spares, must be ground on the chuck, otherwise centering accuracy does not conform the limits

Hard Master Jaws – 4-Piece Sets

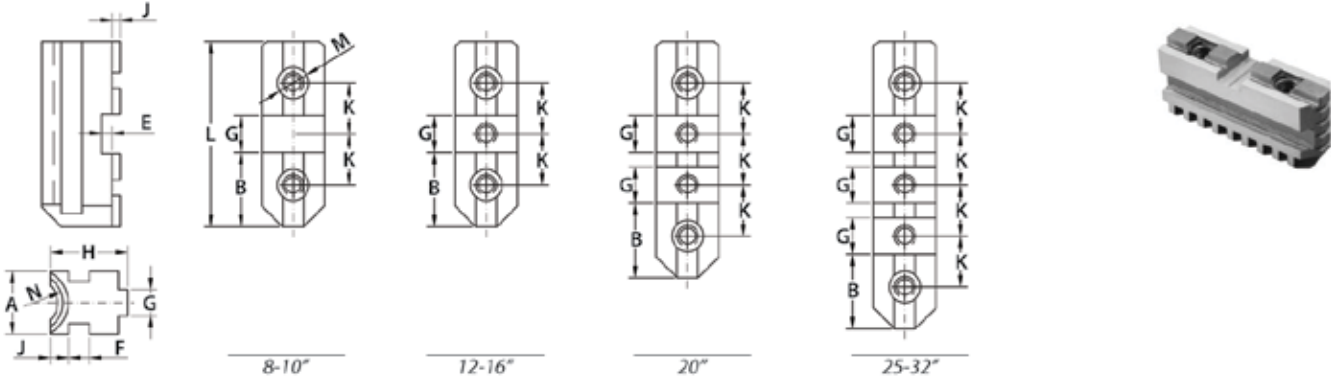

For Chuck Diameter (Inch)	A (Inch)	B (Inch)	C (Inch)	E (Inch)	F (Inch)	G (Inch)	H (Inch)	J (Inch)	K (Inch)	L (Inch)	N Thread	Weight (lbs)	M Thread	Code
8	1.06	1.31	0.50	0.16	0.39	0.31	1.26	0.45	0.88	3.11	24 x 4 sq.	1.00	3/8-16	411062
10	1.06	1.48	0.75	0.16	0.39	0.50	1.50	0.45	1.06	3.70	24 x 4 sq.	1.45	1/2-13	411064
12	1.57	1.79	0.75	0.16	0.47	0.50	1.54	0.38	1.25	4.33	Tr32 x 6	2.45	1/2-13	411066
16	1.57	5.16	0.75	0.28	0.47	0.50	1.73	0.38	1.50	5.08	Tr32 x 6	3.30	5/8-11	411068
20	2.05	2.18	0.75	0.28	0.59	0.50	2.32	0.46	1.50	6.61	Tr36 x 6	7.90	3/4-10	411070
25	2.05	2.18	0.75	0.28	0.71	0.50	2.32	0.62	1.50	8.11	Tr40 x 6	9.50	3/4-10	411072
32	2.76	2.18	0.75	0.28	0.79	0.50	2.32	0.62	1.50	8.11	Tr44 x 8	13.00	3/4-10	411074

Spare Parts for PI Series

Operating Screws – 1 Piece



Keys – 1 Piece



Thrust Bearings – 1 Piece



For Chuck Diameter (Inch)	Code	For Chuck Diameter (Inch)	Code	For Chuck Diameter (Inch)	Code
8.00	411076	8.00	411104	8.00	411090
10.00	411078	10.00	411106	10.00	411092
12.50	411080	12.50	411108	12.50	411094
15.75	411082	15.75	411110	15.75	411096
20.00	411084	20.00	411112	20.00	411098
25.00	411086	25.00	411114	25.00	411100
32.00	411088	32.00	411116	32.00	411102

Oil Country Lathe Chucks & Accessories



PEO Series – Forged Steel Body – Large Through Hole – 3-Jaw Self-Centering Chucks

Heavy Duty Serrated Jaws

- Extra heavy duty
- ANSI standard tongue and groove jaws
- Master and top jaws provided with heavy duty serration for safe and superior gripping power
- Critical chuck surfaces precision ground and heat treated
- A2 mounts supplied
- Extra wide master jaws



Heavy Duty Serrated Jaws

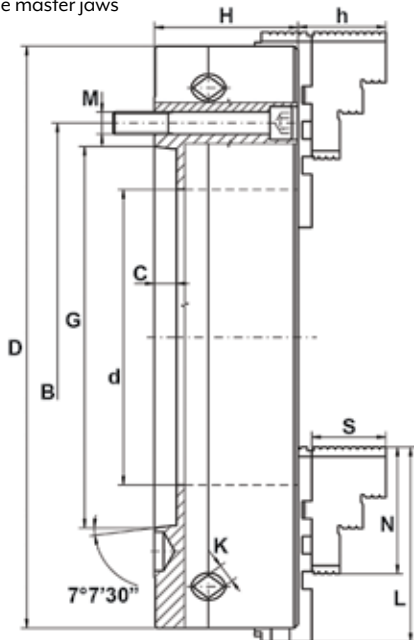

Specifications

Chuck Dia. (Inch)	Spindle Nose	Hard Top Jaw Width (Inch)	Hard Master Jaw Width (Inch)	Spindle Mounting Bolts	Top Jaw Mounting Bolts	* Load Capacity (lbs)	Clamping Capacity Min - Max (Inch)
20	A2-11	2.36	2.36	M20 x 2.5	3/4-10	5200	1.77 - 19.68
20	A2-15	2.36	2.36	M24 x 3.0	3/4-10	5200	1.77 - 19.68
25	A2-15	3.54	3.15	M24 x 3.0	7/8-9	7800	3.15 - 24.80
25	A2-20	3.54	3.15	M24 x 3.0	7/8-9	7800	6.30 - 24.80
32	A2-15	3.54	3.15	M24 x 3.0	7/8-9	10400	5.12 - 31.50
32	A2-20	3.54	3.15	M24 x 3.0	7/8-9	10400	7.09 - 31.50

* For supported workpieces only

Type A2 Mounting

Chuck Diameter (Inch)	d Hole Diameter (Inch)	Spindle Nose Size	B (Inch)	G (Inch)	H (Inch)	h (Inch)	C (Inch)	S (Inch)	N (Inch)	K (Inch)	L (Inch)	RPM Maximum	Weight (lbs)	Code
20	7.48	A2-11	9.25	7.75	4.68	3.42	0.75	2.98	5.31	0.75	6.54	1000	560	410080
20	8.00	A2-15	13.00	11.25	4.68	3.42	0.81	2.98	5.31	0.78	6.54	1000	530	410081
25	10.75	A2-15	13.00	11.25	6.06	3.64	0.81	3.29	5.31	0.87	8.86	850	650	410082
25	12.55	A2-20	18.25	16.25	6.06	3.64	0.87	3.29	5.31	0.87	8.86	850	620	410083
32	10.75	A2-15	13.00	11.25	6.30	3.64	0.81	3.29	5.31	0.87	8.86	600	1200	410084
32	12.55	A2-20	18.25	16.25	6.30	3.64	0.94	3.29	5.31	0.87	8.86	600	1170	410085

LATHE CHUCKS & ACCESSORIES

Oil Country Lathe Chucks & Accessories



Spare Jaws for PEO Series

Hard jaws, supplied as supplement or as spares, must be ground on the chuck, otherwise centering accuracy does not conform the limits

Heavy Duty Serrated Hard Top Jaws – 1-Piece

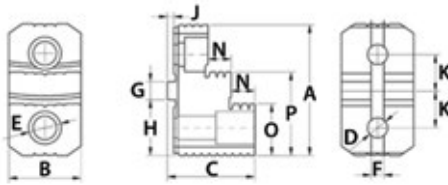

For Chuck Diameter (Inch)	A (Inch)	B (Inch)	C (Inch)	D (Inch)	E (Inch)	F (Inch)	G (Inch)	H (Inch)	J (Inch)	K (Inch)	N (Inch)	O (Inch)	P (Inch)	Code
20	5.34	2.56	3.23	0.87	1.30	0.50	0.75	2.25	0.25	1.50	0.83	2.05	3.37	356325
25 & 32	5.34	2.56	3.82	0.94	1.38	0.50	0.75	2.25	0.25	1.50	1.10	2.05	3.37	356326

Heavy Duty Serrated Hard Master Jaws – 1-Piece

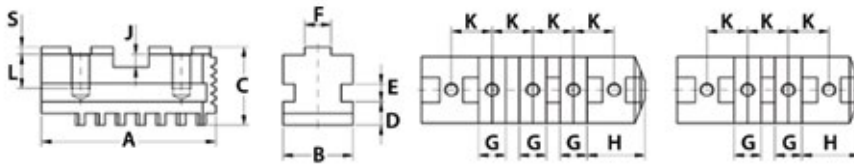

For Chuck Diameter (Inch)	A (Inch)	B (Inch)	C (Inch)	D (Inch)	E (Inch)	F (Inch)	G (Inch)	H (Inch)	J (Inch)	K (Inch)	L (Inch)	S (Inch)	M Thread	Code
20	6.54	2.36	2.56	0.79	0.79	0.49	0.75	2.25	0.28	1.50	1.42	0.13	3/4-10	356327
25 & 32	8.86	3.15	2.56	0.98	0.98	0.49	0.75	2.25	0.28	1.50	1.30	0.13	7/8-9	356328

Oil Country Lathe Chucks & Accessories

PEI Series – Forged Steel Body – Large Through Hole – 4-Jaw Independent Chucks

Heavy Duty Serrated Jaws

- Extra heavy duty
- ANSI standard tongue and groove jaws
- Critical chuck surfaces are precision ground and heat treated
- Extra heavy duty master jaws and top jaws provided with heavy duty serration for safe and superior gripping power
- Extra heavy duty operating screws and thrust bearings
- A2 mounts supplied
- Induction hardened guide ways and through hole
- High accuracy



Heavy Duty Serrated Jaws

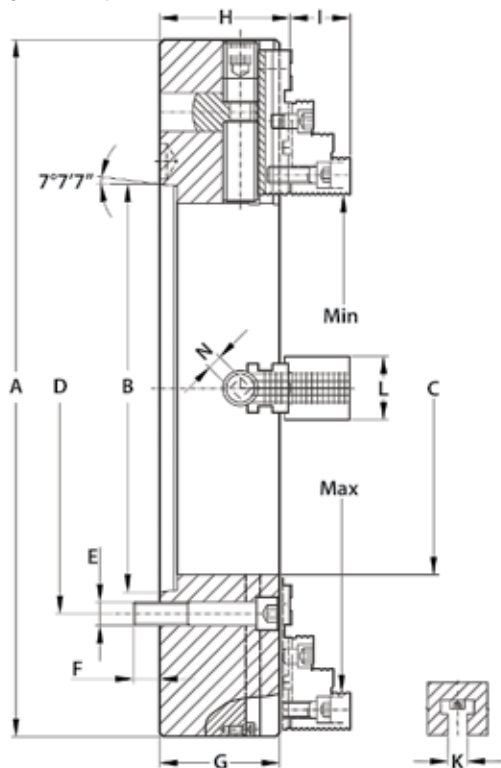

Specifications

Chuck Dia. (Inch)	Spindle Nose	Top Jaw Mounting Bolts	Operating Screw Thread	Clamping Capacity Min-Max
20	A2-11	3/4-10	Tr 44x8 LH	1.77 - 19.68
20	A2-15	3/4-10	Tr 44x8 LH	1.77 - 19.68
25	A2-15	7/8-9	Tr 50x8 LH	1.97 - 24.80
25	A2-20	7/8-9	Tr 50x8 LH	7.09 - 24.80
28	A2-15	7/8-9	Tr 50x8 LH	2.95 - 27.95
28	A2-20	7/8-9	Tr 50x8 LH	7.09 - 24.80
32	A2-15	7/8-9	Tr 50x8 LH	5.12 - 31.50
32	A2-20	7/8-9	Tr 50x8 LH	7.09 - 31.50
40	A2-28	7/8-9	Tr 50x8 LH	13.73 - 39.40

Type A2 Mounting

Chuck Dia. (Inch)	C Through Hole (Inch)	Spindle Nose Size	B (Inch)	D (Inch)	G (Inch)	H (Inch)	I (Inch)	K (Inch)	L (Inch)	N (Inch)	E	F (Inch)	RPM Maximum	Weight (lbs)	Code
20	6.50	A2-11	7.75	9.25	5.71	6.07	2.98	0.87	2.36	0.75	M20 x 2.5	1.12	1000	450	410086
20	8.00	A2-15	11.25	13.00	5.71	6.07	2.98	0.87	2.36	0.75	M24 x 3.0	1.34	1000	414	410087
25	10.50	A2-15	11.25	13.00	6.10	6.07	3.57	0.87	2.96	0.87	M24 x 3.0	1.34	850	682	410088
25	12.55	A2-20	16.25	18.25	6.10	6.58	3.57	0.87	2.95	0.87	M24 x 3.0	1.50	850	649	410089
28	10.50	A2-15	11.25	13.00	6.10	6.58	3.57	0.87	2.95	0.87	M24 x 3.0	1.34	750	913	410090
28	12.55	A2-20	16.25	18.25	6.10	6.58	3.57	0.87	2.95	0.87	M24 x 3.0	1.50	750	869	410091
32	10.50	A2-15	11.25	13.00	6.50	6.97	3.57	0.87	2.95	0.87	M24 x 3.0	1.34	600	1287	410092
32	12.55	A2-20	16.25	18.25	6.50	6.97	3.57	0.87	2.95	0.87	M24 x 3.0	1.50	600	1243	410093
40	20.86	A2-28	23.00	25.50	6.89	7.37	3.57	1.10	2.95	0.87	M30 x 3.5	1.53	430	1683	410094

LATHE CHUCKS & ACCESSORIES

Oil Country Lathe Chucks & Accessories



Spare Jaws for PEI Series

Hard jaws, supplied as supplement or as spares, must be ground on the chuck, otherwise centering accuracy does not conform the limits

Heavy Duty Serrated Hard Top Jaws – 1-Piece

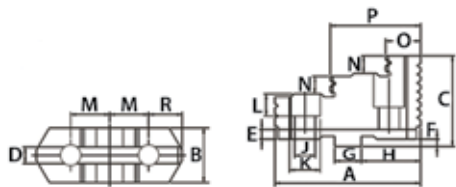

For Chuck Diameter (Inch)	B (Inch)	C (Inch)	D (Inch)	E (Inch)	F (Inch)	G (Inch)	H (Inch)	J (Inch)	K (Inch)	M (Inch)	N (Inch)	A OAL (Inch)	O (Inch)	P (Inch)	Weight (lbs)	Code
*25, 28 & 32	2.95	3.82	0.50	0.16	0.24	0.75	2.25	0.95	1.38	1.50	1.10	5.34	2.05	3.37	12.50	356334
20	2.36	3.23	0.50	0.16	0.24	0.75	2.25	0.87	1.30	1.50	0.83	5.38	2.05	3.37	9.00	356329
40	3.35	4.21	0.50	0.16	0.24	0.75	2.25	0.95	1.38	1.50	1.18	6.30	2.36	3.74	18.50	356330

* Except 25" chuck with A2-15 spindle

Heavy Duty Serrated Hard Master Jaws – 1-Piece

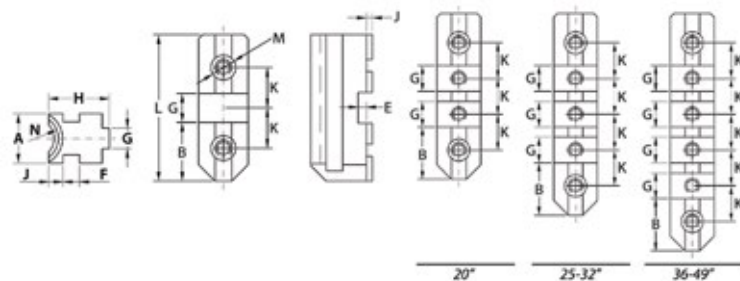

For Chuck Diameter (Inch)	A (Inch)	B (Inch)	C (Inch)	E (Inch)	F (Inch)	G (Inch)	H (Inch)	J (Inch)	K (Inch)	N (Inch)	L OAL (Inch)	M Thread	Weight (lbs)	Code
20	2.05	2.25	0.75	0.28	0.79	0.50	2.32	0.62	1.50	Tr44 x 8	6.69	3/4-10	8.50	356331
25, 28 & 32	2.76	2.25	0.75	0.28	0.79	0.50	2.47	0.62	1.50	Tr50 x 8	8.19	7/8-9	13.50	356332
40	3.15	2.25	0.75	0.28	0.98	0.50	3.04	0.98	1.50	Tr55 x 8	11.81	7/8-9	30.00	356333

Lathe Chuck Accessories

Chuck Mounting Bolts For Hard & Soft Top Jaws

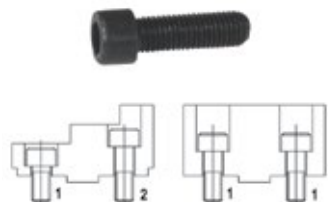

Specifications		
Chuck Diameter	Bolt 1 Short	Bolt 2 Long
200	3/8" – 16 x 30mm	3/8" – 16 x 20mm
250	1/2" – 13 x 40mm	1/2" – 13 x 25mm
315	1/2" – 13 x 40mm	1/2" – 13 x 25mm
400	5/8" – 11 x 45mm	5/8" – 11 x 30mm
500	3/4" – 10 x 55mm	3/4" – 10 x 40mm
630	3/4" – 10 x 60mm	3/4" – 10 x 40mm
800	3/4" – 10 x 65mm	3/4" – 10 x 40mm

For Chuck Diameter (mm)	Thread	Bolt 1 Short – 1-Piece		Bolt 2 Long – 1-Piece	
		Length (mm)	Code	Length (mm)	Code
125	M8	20	41118	25	41120
160	M10	20	410158	30	410162
200	M10	20	410158	30	410162
250	M12	25	410159	40	410163
315	M12	25	410159	40	410163
400	M16	30	410160	45	410164
500	M20	40	410161	75	410165
630	M20	40	410161	80	410165



5C Collet Chucks

For Mounting with Back Plate

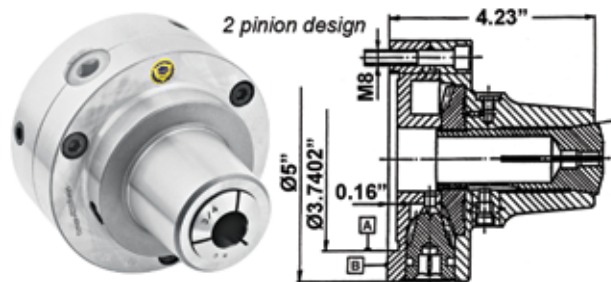

Plain Back

Chuck Size	5C Collet Holding (Inch)	Weight (lbs)	Code
5	1/16 - 1/8	13.0	358031

Direct Mount

Chuck Size	Mount	Weight (lbs)	Code
5	DI-4	15	358033
5	DI-5	15	358034

Machined Back Plates

Taper Size	Code
DI-3	355565
DI-4	355566
DI-6	358038
L00	358039

Other back plates available

Face Plate Jaws

For Radial T-Slot Tables

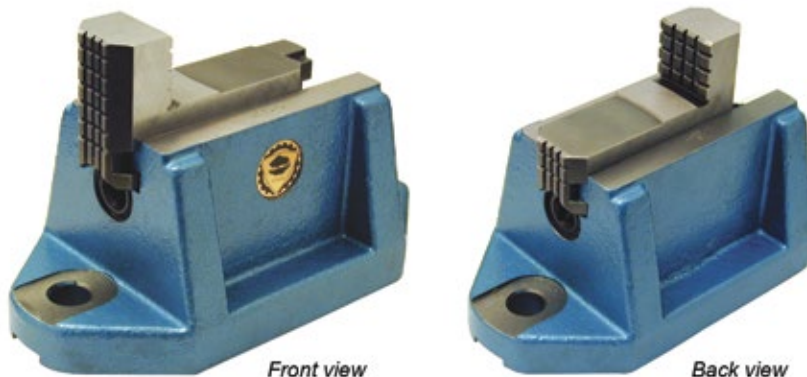

- Heavy semi-steel body
- Hard solid reversible jaws
- Each set of jaws furnished with mounting bolts (M18) and wrench
- Sold in 4-piece sets

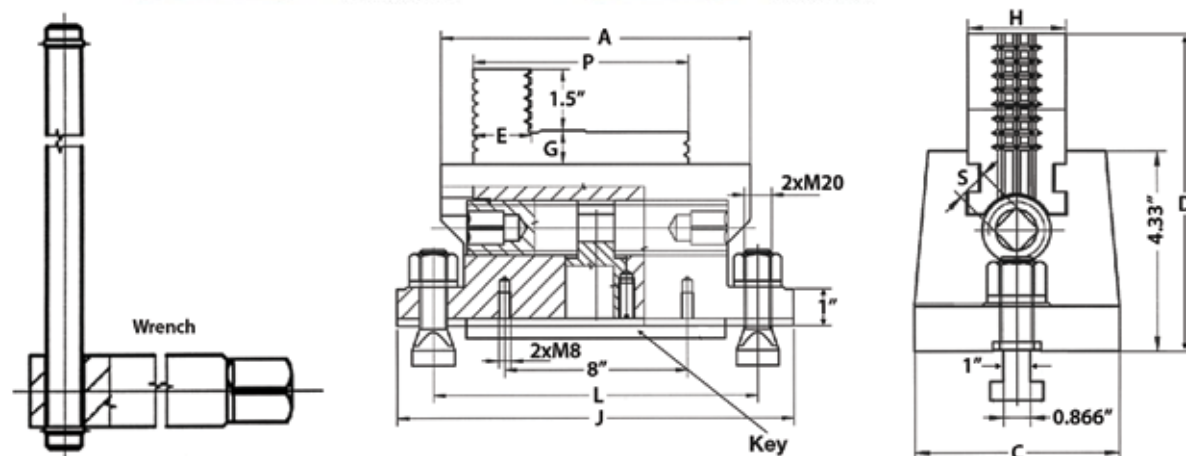

Jaw Size (Inch)	A (Inch)	C (Inch)	D (Inch)	E (Inch)	G (Inch)	H (Inch)	J (Inch)	L (Inch)	P (Inch)	S (Inch)	Weight (lbs)	Code
6	6	5.12	6.5	1.34	0.5	1.575	10.25	8	5	0.5551	149	355983
8	8	5.5	7	1.5	0.85	2.047	12.2	10	6	0.669	205	355984

Chuck Stop Sets

Standard & Deluxe



- The Royal Chuck Stop provides a simple, consistent method for locating short parts in a 3-jaw lathe chuck
- Captive, web-shaped design eliminates the danger of using spacers or parallels that could come loose and be thrown from a spinning chuck
- Three strong magnets further secure the stop to the chuck face
- Stop allows short parts to project past the chuck jaws, providing clearance for facing operations
- Setup time is greatly reduced - no need to bore soft jaws
- Very accurate - front and back locating surfaces are parallel within $\pm 0.0004"$
- Slot width can be easily enlarged to accommodate wider chuck jaws
- Anodized finish provides good wear-resistance

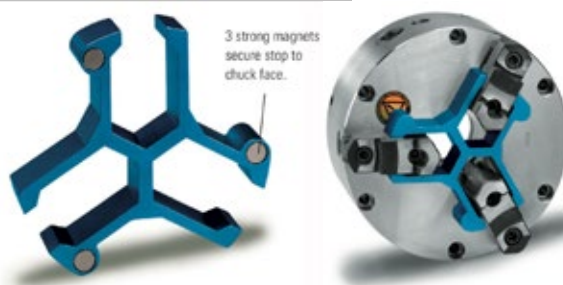

Description	Code
3-Piece Standard Set - 15, 20 and 25mm stops	355985
5-Piece Deluxe Set - 15, 20, 25, 30 and 35mm stops	355986

Tool Posts, Turrets, Holders & Bushings

40-Position Tool Posts

REPEATABILITY: Guaranteed repeatability of index accuracy is 0.01mm and remains unchanged even after innumerable tool changes

TECHNICAL DATA: When determining the size, the following is important:

1. Driving motor power
2. Center height from carriage "X"
3. Length of tool holder "lg" should possibly correspond to width "z" of top slide
4. Height of tool "D", which together with height "y" and the space that remains underneath makes up the necessary size "X" (See table)

Example for choice of size: Driving power of machine – 6 KW. Width of carriage "Z", 145 mm, then use tool holder turret "B" and tool holders BD 25120. BD 25140, BD 32140 with BH 32130 and BJ 40120

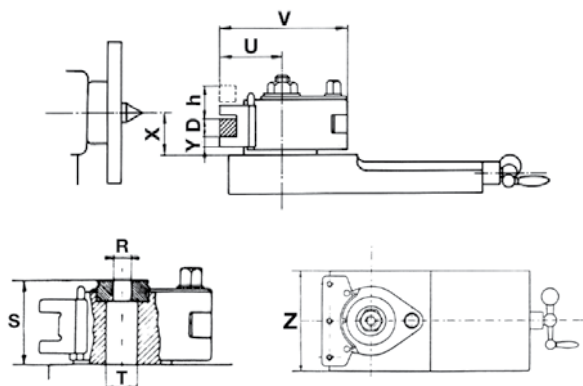

Minimum dimension "X" required for height of tool "D"

Type GS-	Aa	A		E			B		C		D1		D2				
Toolholder D	12	16	20	16	20	25	25	32	32	40	45	40	50	63	50	65	
Tool Height D	X Minimum																
6	12																
8	14	17															
10	16	19	19	19	19	22											
12	18	21	21	21	21	24	25	26									
14		23	23	23	23	26	27	28	29								
16		25	25	25	25	28	29	30	31	31							
20						29	32	33	34	35	35	38					
25							37	38	39	40	40	43	45				
30									44	45	45	48	50	51	52	50	55
32										47	47	50	52	53	54	52	57
40											55	58	60	61	62	60	65
50														71	72	70	75
63																85	88

Hole "R" in the centring disc must be enlarged up to the size of the clamping screw

Original Wechselfix		Aa	A		E			B		C		D1		D2			
Driving Power	KW	1	2	2	4.5	4.5	4.5	7	7	13	13	20	20	28	28		
Change Toolholder Size	D	12	16	20	16	20	25	25	32	32	40	45	40	50	63	50	65
Width of Carriage Max.	Z mm	80	100	100	120	120	120	150	150	180	180	200	200	200	250	250	
Center Height from Carriage Max.	X mm	Y+D	Y+D	Y+D	Y+D	Y+D	Y+D	Y+D	Y+D	Y+D	Y+D	Y+D	Y+D	Y+D	Y+D	Y+D	
Center Height from Carriage Max.	X mm	X+h	X+h	X+h	X+h	X+h	X+h	X+h	X+h	X+h	X+h	X+h	X+h	X+h	X+h	X+h	
Change Toolholder Size	h mm	8	11	11	16	11	6	20	11	40	35	30	30	20	20	30	
Tool Repose	Y mm	6	8.5	8.5	8.5	8.5	12	12	13.5	15	15	18	20	20	20	25	
Maximum Height of Tool	D mm	12	16	20	16	20	25	25	32	32	40	45	40	50	63	50	65
Total Width	V mm	70	100	100	125	125	125	150	150	200	200	200	230	234	242	275	282
Total Height	S mm	37	56	56	68	68	68	79	79	110	110	110	122	122	122	135	135
Maximum Throat	U mm	30	48	48	60	60	60	71	71	190	190	190	112	116	124	140	147
Boring Diameter	T mm	13	19.5	19.5	19.5	19.5	19.5	31.5	31.5	39.5	39.5	39.5	40	40	40	79	79

Tool Posts, Turrets, Holders & Bushings

40-Position Tool Posts (continued)

Turrets, Holders & Bushings

Turret		Tool Holder D				Round Bar Holder H				Bush Holder J				Part-Off Tool Holder A		Morse Taper Bushing L					
Type GS	Code	Type	D (mm)	Ig (mm)	Code	Type	H (mm)	Ig (mm)	Code	Type	J (mm)	Ig (mm)	Code	Type	Code	Type	MT	Ig (mm)	Code		
0-Aa	137001	AaD	12	50	137011	AaH	12	50	137101	Aaj	15	50	137201	AaT	137301	-	-	-	-	-	
1-A	137002	-	-	-	-	AH	20	85	137102	Aj	30	80	137202	AT	137302	AL	1	30	137902	-	
		AD	16	90	137022	-	-	-	-	-	-	-	-	-	-	AL	2	40	137912	-	
		AD	20	75	137032	-	-	-	-	-	-	-	-	-	-	-	-	-	-	-	-
		AD	20	90	137042	-	-	-	-	-	-	-	-	-	-	-	-	-	-	-	-
1-E	137003	-	-	-	-	EH	16	100	137103	Ej	30	100	137203	ET	137303	AL	2	30	137913	-	
		ED	20	100	137023	EH	25	100	137113	Ej	40	100	137213	-	-	BL	3	40	137924	-	
		ED	25	100	137033	-	-	-	-	-	-	-	-	-	-	-	-	-	-	-	-
2-B	137004	BD	25	120	137014	BH	32	130	137104	Bj	40	120	137204	BT	137304	BL	1	40	137904	-	
		BD	25	140	137024	-	-	-	-	-	-	-	-	-	-	BL	2	40	137914	-	
		BD	32	120	137034	-	-	-	-	-	-	-	-	-	-	BL	3	40	137924	-	
		BD	32	140	137044	-	-	-	-	-	-	-	-	-	-	BL	4	40	137934	-	
3-C	137005	CD	32	150	137015	CH	40	160	137105	Cj	40	160	137205	CT	137305	-	-	-	-	-	
		CD	32	170	137025	CH	50	160	137115	Cj	50	160	137215	-	-	-	-	-	-	-	
		CD	40	150	137035	-	-	-	-	-	-	-	-	-	-	-	-	-	-	-	-
		CD	40	170	137045	-	-	-	-	-	-	-	-	-	-	-	CL	3	50	137925	-
		CD	45	170	137055	-	-	-	-	-	-	-	-	-	-	-	CL	4	50	137933	-
4-D1	137006	DID	40	180	137016	DIH	63	180	137106	Dij	63	180	137206	-	-	-	-	-	-	-	
		DID	50	180	137026	-	-	-	-	-	-	-	-	-	-	-	DL1	5	63	137906	-
		DID	63	180	137036	-	-	-	-	-	-	-	-	-	-	-	-	-	-	-	
5-D2	137007	D2D	50	220	137017	D2H	70	220	137107	D2j	63	220	137207	-	-	-	-	-	-	-	
		D2D	65	220	137027	-	-	-	-	-	-	-	-	-	-	-	DL2	5	63	137907	-

* Blades not included with Part-Off Tool Holder A

Quick Change 40-Position Tool Posts



- Adjust tool to 40 different positions indicated by a marked position dial (index every 9°)
- Fully interchangeable with other brands of 40-position quick change tool posts and holders
- Heat-treated and precision-ground for very accurate repeatability
- Change tools in seconds
- Allows adjustment of height of cutting edge easily and accurately

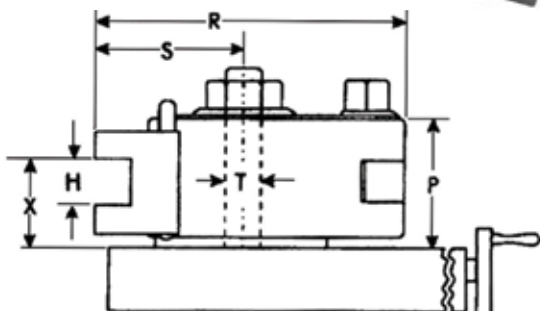

Tool Post Size	A	E	B	C	D
Lathe Swing	6 - 13	10 - 18	13 - 20	18 - 30	25 - 36
Max. Driving Power (hp)	3	6	9	18	30
R Max.	4.13	5.14	6.00	7.90	9.52
S Max.	2.07	2.57	2.95	3.62	4.88
P	1.83	2.30	2.68	3.90	4.80
T	0.79	0.79	1.26	1.57	1.57
H	0.83	0.75	1.00	1.25	1.50
X Minimum	1.18	1.37	1.46	1.86	2.36
X Maximum	1.61	2.04	2.25	3.43	3.74

Tool Posts, Turrets, Holders & Bushings

Quick Change 40-Position Tool Posts (continued)

Turrets, Holders & Bushings

Turret		Turn & Face Holder D			Boring Bar Holder B			Bushing Holder S			Morse Taper Bushing L		
Type	Code	D (mm)	lg (mm)	Code	H Max (mm)	lg	Code	J Bore (mm)	lg	Code	Outside Diameter (mm)	Inside Diameter MT	Code
A	*302900	20	90	*302901	20	90	*302902	30	80	302904	30	1	302905
E	*302910	20	100	302914	30	100	*302912	30	100	302915	30	2	302917
		25	100	*302911	-	-	-	40	100	302916	40	3	302918
B	*302920	25	120	*302921	32	130	*302922	40	120	302925	40	3	302926
		32	120	302924	-	-	-	-	-	-	40	4	302927
C	*302930	32	150	*302931	32	160	*302932	40	150	302937	40	3	302939
		40	150	302934	40	160	302936	50	150	302938	40	4	302898
D	*302890	40	170	302935	-	-	-	-	-	-	50	4	302899
		40	180	*302891	50	180	*302894	-	-	-	-	-	-
		50	180	302892	63	180	302895	63	180	302896	63	5	302897
		63	180	302893	-	-	-	-	-	-	-	-	-

* Items included in sets below

Quick Change 40-Position Tool Post Sets

Sets Include: 1 turret, 3 turn and face holders, 1 boring bar holder, 1 'T' wrench and 1 lock wrench

Type	Description	Weight (kg)	Code
A	Turret – 302900, Turn and Face Holder – 302901, Boring Bar Holder – 302902	4	302903
E	Turret – 302910, Turn and Face Holder – 302911, Boring Bar Holder – 302912	10	302913
B	Turret – 302920, Turn and Face Holder – 302921, Boring Bar Holder – 302922	13	302923
C	Turret – 302930, Turn and Face Holder – 302931, Boring Bar Holder – 302932	25	302933

Quick Change Tool Post Sets

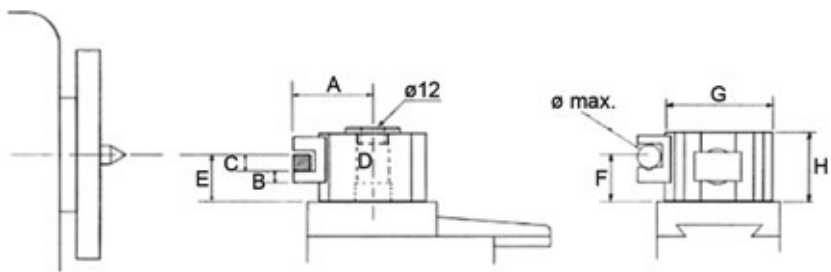



















Sets include: 1 turret, 4 flat section tool holders, 1 V-slotted tool holder, 1 elbow wrench, 1 cross-pin spanner

Model	Swing of Lathe (Inch)	A (Inch)	B (Inch)	C (Inch)	D (Inch)	E Min-Max (Inch)	F Min-Max (Inch)	Bar Maximum Diameter (Inch)	Morse Taper	H (Inch)	I (Inch)	A Cut-Off Blade Min-Max (Inch)	B Cut-Off Blade Min-Max (Inch)	Code
M-O	10	4.40	0.31	0.63	0.551	0.95-1.30	0.79-1.18	0.59	1	1.77	2.75	0.08-0.16	0.39-0.59	145001
A-O	14	6.00	0.47	0.83	0.787	1.26-1.65	1.00-1.38	0.75	2	2.36	4.00	0.08-0.20	0.47-0.79	145003
B-O	18	8.00	0.59	1.30	0.984	1.89-2.60	1.50-2.20	1.00	3	3.35	5.00	0.08-0.20	0.59-1.00	145005
C-O	24	8.50	0.71	1.42	1.259	2.20-3.07	1.57-2.44	1.00	4	3.75	5.75	0.12-0.25	0.70-1.18	145006
D-O	Over 24	11.00	0.83	1.65	1.654	2.50-3.66	1.77-2.95	1.34	5	4.72	7.00	0.15-0.31	0.70-1.38	145007
E-O	Over 24	12.25	0.87	2.00	1.654	3.00-4.12	2.28-3.54	1.34	5	5.12	8.00	0.19-0.39	1.00-1.50	145008

Tool Posts, Turrets, Holders & Bushings

Quick Change Tool Posts (continued)

Accessories

<p>QUICK CHANGE TOOL HOLDER ACCESSORIES</p> <p><i>For Models M-O, A-O, B-O, C-O, D-O, E-O</i></p>	 <p>201 Tool Holders</p>	 <p>202 V-Slot Tool Holders</p>	 <p>203 Morse Cone Tool Holders</p>
 <p>217 Part-Off Holders</p>	 <p>204 Eccentric Pins</p>	 <p>205 Tenons</p>	 <p>206 Height Adjustment Reels</p>
 <p>207 Extractors</p>	 <p>208 Long Screws</p>	 <p>209 Short Screws</p>	 <p>210 Set Screws</p>
 <p>211 Extractor Screws</p>	 <p>212 Springs</p>	 <p>213 Pins</p>	 <p>214 Elbow Wrenches</p>
 <p>215 Cross-Pin Spanners</p>	 <p>218 Screws</p>	 <p>219 Clamps for Part-Off Blades</p>	 <p>220 Clamp Screws</p>

TURNING TOOLS

Model	For Model	Code	Model	For Model	Code	Model	For Model	Code	Model	For Model	Code	Model	For Model	Code
Turret	M-O	145100	203	D-O	145703	206	B-O	145506	210	C-O	145610	214	C-O	145614
Turret	A-O	145300	203	E-O	145803	206	C-O	145606	210	D-O	145710	214	D-O	145714
Turret	B-O	145500	217	M-O	145117	206	D-O	145706	210	E-O	145810	214	E-O	145814
Turret	C-O	145600	217	A-O	145317	206	E-O	145806	211	M-O	145111	215	M-O	145115
Turret	D-O	145700	217	B-O	145517	207	M-O	145107	211	A-O	145311	215	A-O	145315
Turret	E-O	145800	217	C-O	145617	207	A-O	145307	211	B-O	145511	215	B-O	145515
201	M-O	145101	217	D-O	145717	207	B-O	145507	211	C-O	145611	215	C-O	145615
201	A-O	145301	217	E-O	145817	207	C-O	145607	212	M-O	145112	215	D-O	145715
201	B-O	145501	204	M-O	145104	208	M-O	145108	212	A-O	145312	215	E-O	145815
201	C-O	145601	204	A-O	145304	208	A-O	145308	212	B-O	145512	218	D-O	145718
201	D-O	145701	204	B-O	145504	208	B-O	145508	212	C-O	145612	219	M-O	145119
201	E-O	145801	204	C-O	145604	208	C-O	145608	212	D-O	145712	219	A-O	145319
202	M-O	145102	204	D-O	145704	208	D-O	145708	212	E-O	145812	219	B-O	145519
202	A-O	145302	204	E-O	145804	208	E-O	145808	213	M-O	145113	219	C-O	145619
202	B-O	145502	205	M-O	145105	209	M-O	145109	213	A-O	145313	219	D-O	145719
202	C-O	145602	205	A-O	145305	209	A-O	145309	213	B-O	145513	219	E-O	145819
202	D-O	145702	205	B-O	145505	209	B-O	145509	213	C-O	145613	220	M-O	145120
202	E-O	145802	205	C-O	145605	209	C-O	145609	213	D-O	145713	220	A-O	145320
203	M-O	145103	205	D-O	145705	209	D-O	145709	213	E-O	145813	220	B-O	145520
203	A-O	145303	205	E-O	145805	210	M-O	145110	214	M-O	145114	220	C-O	145620
203	B-O	145503	206	M-O	145106	210	A-O	145310	214	A-O	145314	220	D-O	145720
203	C-O	145603	206	A-O	145306	210	B-O	145510	214	B-O	145514	220	E-O	145820

Tool Posts & Holders

Piston Type

Turrets



- All working parts hardened and ground
- Maximum rigidity for chatter-free performance
- No time wasted with shims - A knurled nut on each tool holder provides for exact height adjustment, entirely eliminating the use of shims
- Speed up your lathe operations by 90%
- Completely sealed for maintenance-free operation
- Cuts set-up time - Instant changing from one operation to another. You simply flip the handle and slide out the tool holder, then slide in the next holder with the locked-in tool bit in the exact pre-set position, ready to run. Set-ups can be made on a bench or surface plate, avoiding costly down-time
- Fits Aloris and Yuasa

Turning: The unequalled rigidity of this tool post and tool holders ensures smoother turning without chatter or vibration

Drilling: Enables you to drill by power feed with your carriage instead of hand operation of tail stock and easily centered

Turning & Facing Holder

No. 1 – Turning



Takes various sizes of bits. Turning and facing tools can be locked in together. Saves time and labor when changing operations.

Boring, Turning & Facing Holder

No. 2 – with V-Groove



“V” groove holds round shank boring bars and tools as well as square tool bits

Heavy Duty Boring Bar Holders

No. 4 & 41 (Larger Capacity)



For smaller diameter boring bars. Equipped with a split bushing to accommodate a boring bar of small diameter. It grips the bar with extreme rigidity, cuts smoothly without chatter.

Morse Taper Tool Holders

MT No. 2, 3, 4 & 5



Drills with carriage by using power feed, instead of tail stock. Easily centered. For No. 2, 3 and 4 Morse Taper Drills.

Universal Parting Blade Holders

No. 7



For bevel as well as T-cut blades. Enables you to cut-off close to chuck. Reduces vibration and prevents breaking blades.

Knurling, Facing & Turning Holders

No. 10



For turning and facing as well as knurling. Supplied with a set of high speed precision ground and tapped medium diamond knurls. Easily replaceable.

Description	12" Swing		10"-15" Swing		13"-18" Swing		14"-20" Swing	
	Tool Capacity	Code	Tool Capacity	Code	Tool Capacity	Code	Tool Capacity	Code
Turret	–	303100	–	303200	–	303300	–	303400
No. 1 Turning	1/2" square	303101	5/8" square	303201	3/4" square	303301	1" square	303401
No. 2 Boring "V"	7/16" diameter	303102	5/8" diameter	303202	3/4" diameter	303302	1" diameter	303402
No. 4 Boring (Bush)	5/8" diameter	303104	3/4" diameter	303204	3/4" diameter	303304	1" diameter	303404
No. 41 Boring (Bush)	3/4" diameter	303141	1" diameter	303241	1" diameter	303341	1-1/4" diameter	303441
MT 2 & 3 Morse Taper	MT2	303105	MT2	303205	MT3	303305	MT3	303405
MT 4 & 5 Morse Taper	MT3	303153	MT3	303253	MT4	303353	MT4	303453
No. 7 Part-Off	1/2"	303107	11/16"	303207	3/4"	303307	7/8"	303407
No. 10 Knurl	–	303110	–	303210	–	303310	–	303410



CNC Bar Pullers

Compact CNC Bar Pullers

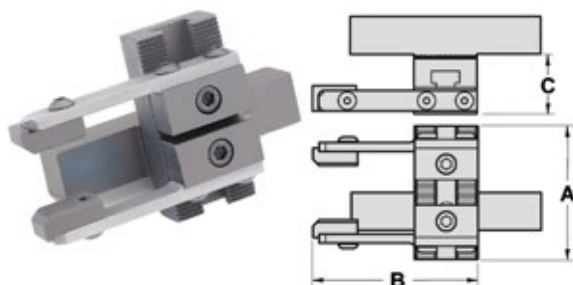

- Great for use with small CNC lathes - compact design minimizes tool interference
- Very easy to setup and use
- Unit can pull round, square, and hex stock
- Flexible heat-treated steel fingers provide strong gripping force
- Each compact bar puller includes one set of serrated jaws and one blank spindle bushing

Order insert holder and insert separately. Additional sizes and shank styles are available. Please contact your KAR distributor for information.

Shank Size (Inch)	Gripping Range (Inch)	A (Inch)	B (Inch)	C (Inch)	Code
1/2 sq.	1/8 – 1-5/8	2-1/8	3-1/4	1-3/16	217050
3/4 sq.	1/8 – 2-1/4	2-5/8	3-1/4	1-3/16	217051
1 sq.	1/8 – 2-1/4	2-5/8	3-1/4	1-3/16	217052
1 sq.	1/8 – 3	3-5/8	3-1/4	1-3/16	217053

Heavy Duty CNC Bar Pullers

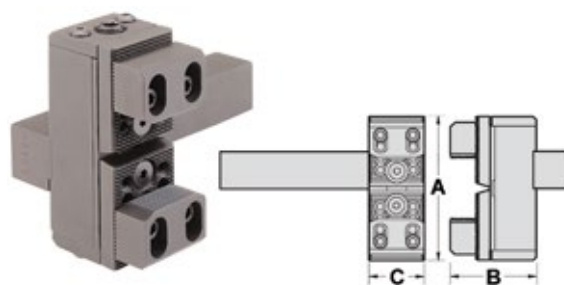

- Gripping range from 1/8" to 6-1/2" (extra capacity jaws sold separately)
- Gripping force is easily adjusted by altering spring pressure
- Jaws have two gripping surfaces: one side is serrated for increased gripping power, the other side is smooth to help prevent marking
- Smooth side is also used when pulling small diameter stock
- Very easy to set up and use
- Each unit comes with one set of standard jaws and one blank spindle bushing

Shank Size (Inch)	Gripping Range		A (Inch)	B (Inch)	C (Inch)	Code
	Standard Jaws (Inch)	Extra Capacity Jaws (Inch)				
3/4 sq.	1/8 – 2-1/4	1-7/8 – 3-3/4	3-7/8	2-9/16	1-1/2	217058
1 sq.	1/8 – 2-1/4	1-7/8 – 3-3/4	3-7/8	2-9/16	1-1/2	217059
1 sq.	1/8 – 3-1/2	1-7/8 – 5-3/8	4-3/4	2-9/16	1-1/2	217060
1 sq.	1/8 – 3-5/8	1-7/8 – 5-1/2	5	2-3/4	1-3/4	217061
1 sq.	1/8 – 4-7/8	1-7/8 – 6-1/2	6-3/4	2-3/4	1-3/4	217062

Combination CNC Cut-Off/Bar Pullers

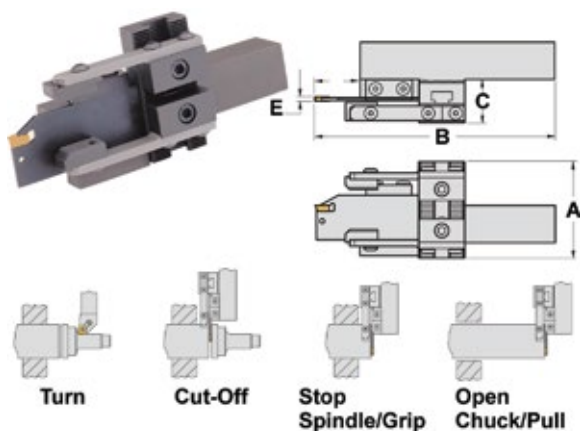

- Combination bar puller/cut-off tool saves a turret station by combining two tools into one
- Benefits include reduced indexing, reduced set-up time, and reduced cycle time
- Compact design - good for all CNC machines where tool interference is a problem
- Gripping range from 1/8" to 2-1/4"
- Flexible heat-treated steel fingers provide strong gripping force
- Unit easily handles round, square, and hex stock
- Very easy to set up and use
- Includes bar puller, one set of standard jaws and one blank spindle bushing

Order holder and insert separately

Shank Size (Inch)	Gripping Range (Inch)	A (Inch)	B (Inch)	C (Inch)	D (Inch)	E (Inch)	Code
3/4 sq.	1/8 – 2-1/4	2-5/8	4-3/4	1-3/16	7/8	0.125	217054
1 sq.	1/8 – 2-1/4	2-5/8	6-3/8	1-3/16	1-1/4	0.125	217055

Part-Off Blade & Insert



Bar puller accepts many popular brands of holders – must be slightly modified

Bar Puller Shank Size (Inch)	Code
1/2 or 3/4	217056
1	217057

Expanding Mandrels

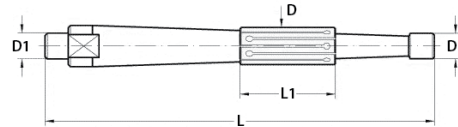

Model	D Range Inch (mm)	L Length Inch (mm)	D1 Diameter Inch (mm)	L1 Sleeve Length Inch (mm)	Complete	Sleeve Only
					Code	Code
LM-1	0.51-0.75 (13-19)	6.5 (165)	0.43 (11)	1.57 (40)	165101	165201
LM-2	0.75-1.00 (19-25)	7.7 (196)	0.50 (13)	2.36 (60)	165102	165202
LM-3	1.00-1.30 (25-33)	10.0 (257)	0.67 (17)	3.54 (90)	165103	165203
LM-4	1.30-1.66 (33-42)	11.7 (297)	0.91 (23)	4.72 (120)	165104	165204
LM-5	1.66-2.05 (42-52)	13.3 (338)	1.18 (30)	5.12 (130)	165105	165205
LM-6	2.05-2.56 (52-65)	15.4 (392)	1.50 (38)	5.90 (150)	165106	165206
LM-7	2.56-3.07 (65-78)	15.4 (392)	1.50 (38)	5.90 (150)	165107	165207
LM-8	3.07-3.55 (78-90)	15.4 (392)	1.50 (38)	5.90 (150)	165108	165208
Model		Set Range (Inch)			Code	
SET: LM-16		0.51 to 2.56 (Model LM-1 to LM-6)			165116	

Revolving Tail Stock Turrets



- Compact, accurate and well-made, these revolving tailstock turrets convert your engine or bench lathe into a screw machine
- Available in two sizes, have six holes each for holding six tools
- Trigger type handle is conveniently located which enables instant changing from one tool to another
- Supplied with Morse taper shank as indicated below

Turret Diameter (Inch)	Hole Size (Inch)	Morse Taper	Weight (lbs)	Code
2-1/2	5/8	2	4	303500
5	1	3	12	303501
5	1	4	12	303502
5	1	1" SS	12	303503

Tool Holder Bushings

CNC Bushings – Black Oxide Finish – Types C, CV, B, DD, J & Z

- For use on all NC and CNC turning machines to adapt a wide variety of boring bars, drills, reamers and other round shank type tools
- Heat treated and precision ground

Type C

- C bushings have long slots for clamping directly on the tool for positive alignment of the cutting edge of the tool

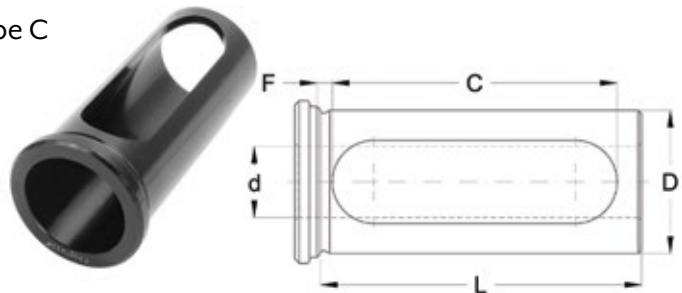

D Outside Diameter (Inch)	d Inside Diameter (Inch)	L Length Under Head (Inch)	C Slot Length (Inch)	F (Inch)	Code	D Outside Diameter (Inch)	d Inside Diameter (Inch)	L Length Under Head (Inch)	C Slot Length (Inch)	F (Inch)	Code	
3/4	3/8	2	1-1/2	0.1693	310732	1	3/4	2-3/4	2-3/8	0.1319	310540	
3/4	1/2	2	1-1/2	0.1693	310733	4 Piece Set – 3/8" to 3/4"					300851	
2 Piece Set – 3/8" to 1/2"						300850	1-1/4	3/8	3-1/4	2-3/4	0.1496	310544
1	3/8	2-3/4	2-3/8	0.1319	310534	1-1/4	1/2	3-1/4	2-3/4	0.1496	310545	
1	1/2	2-3/4	2-3/8	0.1319	310536	1-1/4	5/8	3-1/4	2-3/4	0.1496	310547	
1	5/8	2-3/4	2-3/8	0.1319	310538	1-1/4	3/4	3-1/4	2-3/4	0.1496	310549	

Tool Holder Bushings

CNC Bushings – Black Oxide Finish – Types C, CV, B, DD, J & Z (continued)

Type C (continued)

D Outside Diameter (Inch)	d Inside Diameter (Inch)	L Length Under Head (Inch)	C Slot Length (Inch)	F (Inch)	Code	D Outside Diameter (Inch)	d Inside Diameter (Inch)	L Length Under Head (Inch)	C Slot Length (Inch)	F (Inch)	Code
1-1/4	7/8	3-1/4	2-3/4	0.1496	310734	2	1/2	4	3-5/8	0.1319	310595
1-1/4	1	3-1/4	2-3/4	0.1496	310553	2	5/8	4	3-5/8	0.1319	310596
6 Piece Set – 3/8" to 1"					300852	2	3/4	4	3-5/8	0.1319	310597
1-1/2	3/8	3-3/8	3	0.1260	310735	2	7/8	4	3-5/8	0.1319	310738
1-1/2	1/2	3-3/8	3	0.1260	310559	2	1	4	3-5/8	0.1319	310599
1-1/2	5/8	3-3/8	3	0.1260	310561	2	1-1/4	4	3-5/8	0.1319	310601
1-1/2	3/4	3-3/8	3	0.1260	310563	2	1-1/2	4	3-5/8	0.1319	310603
1-1/2	7/8	3-3/8	3	0.1260	310736	2	1-3/4	4	3-5/8	0.1319	310605
1-1/2	1	3-3/8	3	0.1260	310567	8 Piece Set – 1/2" to 1-3/4"					300855
1-1/2	1-1/4	3-3/8	3	0.1260	310571	2-1/2	1/2	4-1/2	4-1/8	0.1457	310739
7 Piece Set – 3/8" to 1-1/4"					300853	2-1/2	5/8	4-1/2	4-1/8	0.1457	310740
1-3/4	1/2	3-1/2	3-1/8	0.1260	310575	2-1/2	3/4	4-1/2	4-1/8	0.1457	310741
1-3/4	5/8	3-1/2	3-1/8	0.1260	310577	2-1/2	7/8	4-1/2	4-1/8	0.1457	310742
1-3/4	3/4	3-1/2	3-1/8	0.1260	310579	2-1/2	1	4-1/2	4-1/8	0.1457	310743
1-3/4	7/8	3-1/2	3-1/8	0.1260	310737	2-1/2	1-1/4	4-1/2	4-1/8	0.1457	310744
1-3/4	1	3-1/2	3-1/8	0.1260	310583	2-1/2	1-1/2	4-1/2	4-1/8	0.1457	310745
1-3/4	1-1/4	3-1/2	3-1/8	0.1260	310587	2-1/2	1-3/4	4-1/2	4-1/8	0.1457	310746
1-3/4	1-1/2	3-1/2	3-1/8	0.1260	310591	2-1/2	2	4-1/2	4-1/8	0.1457	310747
7 Piece Set – 1/2" to 1-1/2"					300854	2-1/2	2-1/4	4-1/2	4-1/8	0.1457	310748
10 Piece Set – 1/2" to 2-1/4"										300856	

TURNING TOOLS

Type CV

- CV bushings have long slots for clamping directly on the tool for positive alignment of the cutting edge of the tool

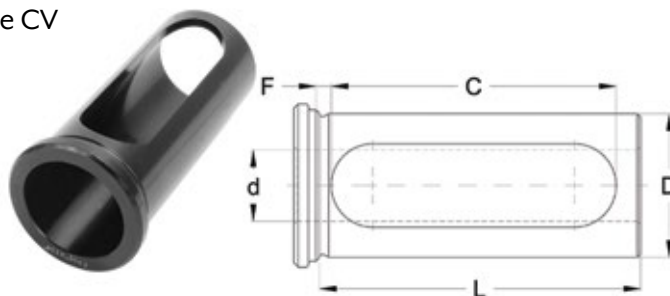

D Outside Diameter (Inch)	d Inside Diameter (Inch)	L Length Under Head Inch (mm)	C Slot Length Inch (mm)	F (Inch)	Code	D Outside Diameter (Inch)	d Inside Diameter (Inch)	L Length Under Head Inch (mm)	C Slot Length Inch (mm)	F (Inch)	Code
1-1/4	1/4	2.36 (60)	1.97 (50)	0.1535	310749	7 Piece Set – 1/4" to 1"					300857
1-1/4	3/8	2.36 (60)	1.97 (50)	0.1535	310750	1-1/2	1/4	2.76 (70)	2.36 (60)	0.1575	310756
1-1/4	1/2	2.36 (60)	1.97 (50)	0.1535	310751	1-1/2	3/8	2.76 (70)	2.36 (60)	0.1575	310757
1-1/4	5/8	2.36 (60)	1.97 (50)	0.1535	310752	1-1/2	1/2	2.76 (70)	2.36 (60)	0.1575	310758
1-1/4	3/4	2.36 (60)	1.97 (50)	0.1535	310753	1-1/2	5/8	2.76 (70)	2.36 (60)	0.1575	310759
1-1/4	7/8	2.36 (60)	1.97 (50)	0.1535	310754	1-1/2	3/4	2.76 (70)	2.36 (60)	0.1575	310760
1-1/4	1	2.36 (60)	1.97 (50)	0.1535	310755	1-1/2	7/8	2.76 (70)	2.36 (60)	0.1575	310761
8 Piece Set – 1/4" to 1-1/4"										300858	
8 Piece Set – 1/4" to 1-1/4"										300858	

Tool Holder Bushings

CNC Bushings – Black Oxide Finish – Types C, CV, B, DD, J & Z (continued)

Type B

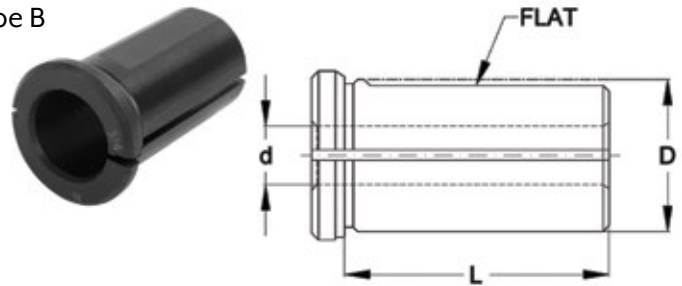

- B bushings have splits and flats providing strong gripping of the tool shanks

D Outside Diameter (Inch)	d Inside Diameter (Inch)	L Length Under Head (Inch)	Code	D Outside Diameter (Inch)	d Inside Diameter (Inch)	L Length Under Head (Inch)	Code
1	1/2	1-3/4	310832	1-3/4	1-1/4	3	310712
1	5/8	1-3/4	310833	1-3/4	1-1/2	3	310713
1	3/4	1-3/4	310834	7 Piece Set – 1/2" to 1-1/2"			300847
3 Piece Set – 1/2" to 3/4"				2	1/2	3-1/2	310714
1-1/4	3/8	2-1/8	310700	2	5/8	3-1/2	310715
1-1/4	1/2	2-1/8	310835	2	3/4	3-1/2	310716
1-1/4	5/8	2-1/8	310701	2	7/8	3-1/2	310717
1-1/4	3/4	2-1/8	310836	2	1	3-1/2	310718
1-1/4	7/8	2-1/8	310702	2	1-1/4	3-1/2	310719
1-1/4	1	2-1/8	310837	2	1-1/2	3-1/2	310720
6 Piece Set – 3/8" to 1"				2	1-3/4	3-1/2	310721
1-1/2	3/8	2-1/2	310703	8 Piece Set – 1/2" to 1-3/4"			300848
1-1/2	1/2	2-1/2	310838	2-1/2	1/2	4	310722
1-1/2	5/8	2-1/2	310704	2-1/2	5/8	4	310723
1-1/2	3/4	2-1/2	310839	2-1/2	3/4	4	310724
1-1/2	7/8	2-1/2	310705	2-1/2	7/8	4	310725
1-1/2	1	2-1/2	310840	2-1/2	1	4	310726
1-1/2	1-1/4	2-1/2	310706	2-1/2	1-1/4	4	310727
7 Piece Set – 3/8" to 1-1/4"				2-1/2	1-1/2	4	310728
1-3/4	1/2	3	310707	2-1/2	1-3/4	4	310729
1-3/4	5/8	3	310708	2-1/2	2	4	310730
1-3/4	3/4	3	310709	2-1/2	2-1/4	4	310731
1-3/4	7/8	3	310710	10 Piece Set – 1/2" to 2-1/4"			300849
1-3/4	1	3	310711				

Type DD

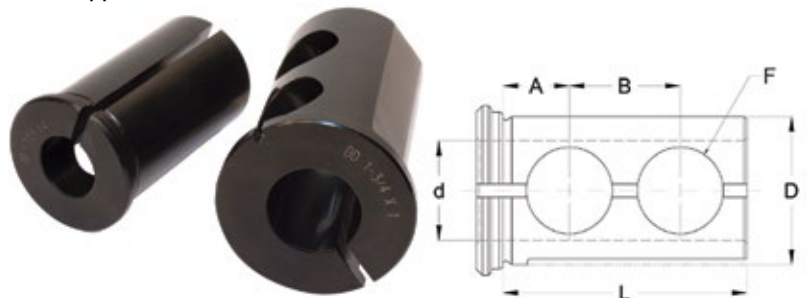

- DD bushings combine Type B split bushings and Type J with the set screw holes allowing this bushing to be used as either Type B or Type J
- Each bushing has a split, two or four holes and a flat

D Outside Diameter (Inch)	d Inside Diameter (Inch)	L Length Under Head (Inch)	A (Inch)	B (Inch)	F (Inch)	Code	D Outside Diameter (Inch)	d Inside Diameter (Inch)	L Length Under Head (Inch)	A (Inch)	B (Inch)	F (Inch)	Code
1-1/2	3/8	2-1/2	11/16	1-1/8	7/8	310779	1-1/2	5/8	2-1/2	11/16	1-1/8	7/8	310781
1-1/2	1/2	2-1/2	11/16	1-1/8	7/8	310780	1-1/2	3/4	2-1/2	11/16	1-1/8	7/8	310782

Tool Holder Bushings

CNC Bushings – Black Oxide Finish – Types C, CV, B, DD, J & Z (continued)

Type DD (continued)

D Outside Diameter (Inch)	d Inside Diameter (Inch)	L Length Under Head (Inch)	A (Inch)	B (Inch)	F (Inch)	Code	D Outside Diameter (Inch)	d Inside Diameter (Inch)	L Length Under Head (Inch)	A (Inch)	B (Inch)	F (Inch)	Code
1-1/2	7/8	2-1/2	11/16	1-1/8	7/8	310783	2-1/2	1-1/4	4	7/8	1-3/4	1-1/4	310804
1-1/2	1	2-1/2	11/16	1-1/8	7/8	310784	2-1/2	1-1/2	4	7/8	1-3/4	1-1/4	310805
1-1/2	1-1/4	2-1/2	11/16	1-1/8	7/8	310785	2-1/2	1-3/4	4	7/8	1-3/4	1-1/4	310806
7 Piece Set – 3/8" to 1-1/4"						300859	2-1/2	2	4	7/8	1-3/4	1-1/4	310807
1-3/4	1/2	3	3/4	1-1/4	7/8	310786	2-1/2	2-1/4	4	7/8	1-3/4	1-1/4	300862
1-3/4	5/8	3	3/4	1-1/4	7/8	310787	8 Piece Set – 3/4" to 2-1/4"						300863
1-3/4	3/4	3	3/4	1-1/4	7/8	310788	3	1	4-1/2	1	2	1-1/4	300864
1-3/4	7/8	3	3/4	1-1/4	7/8	310789	3	1-1/4	4-1/2	1	2	1-1/4	300865
1-3/4	1	3	3/4	1-1/4	7/8	310790	3	1-1/2	4-1/2	1	2	1-1/4	300866
1-3/4	1-1/4	3	3/4	1-1/4	7/8	310791	3	1-3/4	4-1/2	1	2	1-1/4	300867
1-3/4	1-1/2	3	3/4	1-1/4	7/8	310792	3	2	4-1/2	1	2	1-1/4	300868
7 Piece Set – 1/2" to 1-1/2"						300860	3	2-1/4	4-1/2	1	2	1-1/4	300869
2	1/2	3-1/2	3/4	1-1/2	1	310793	6 Piece Set – 1" to 2-1/4"						300870
2	5/8	3-1/2	3/4	1-1/2	1	310794	3-1/2	1-1/2	5-1/4	1-1/4	2-1/2	1-1/4	300871
2	3/4	3-1/2	3/4	1-1/2	1	310795	3-1/2	1-3/4	5-1/4	1-1/4	2-1/2	1-1/4	300872
2	7/8	3-1/2	3/4	1-1/2	1	310796	3-1/2	2	5-1/4	1-1/4	2-1/2	1-1/4	300873
2	1	3-1/2	3/4	1-1/2	1	310797	3-1/2	2-1/4	5-1/4	1-1/4	2-1/2	1-1/4	300874
2	1-1/4	3-1/2	3/4	1-1/2	1	310798	3-1/2	2-1/2	5-1/4	1-1/4	2-1/2	1-1/4	300875
2	1-1/2	3-1/2	3/4	1-1/2	1	310799	3-1/2	3	5-1/4	1-1/4	2-1/2	1-1/4	300876
2	1-3/4	3-1/2	3/4	1-1/2	1	310800	6 Piece Set – 1-1/2" to 3"						300877
8 Piece Set – 1/2" to 1-3/4"						300861							
2-1/2	3/4	4	7/8	1-3/4	1-1/4	310801							
2-1/2	7/8	4	7/8	1-3/4	1-1/4	310802							
2-1/2	1	4	7/8	1-3/4	1-1/4	310803							

Type J

- J bushings have a long solid body with two holes for clamping directly on the tool with set screws for positive alignment of the cutting edge of the tool

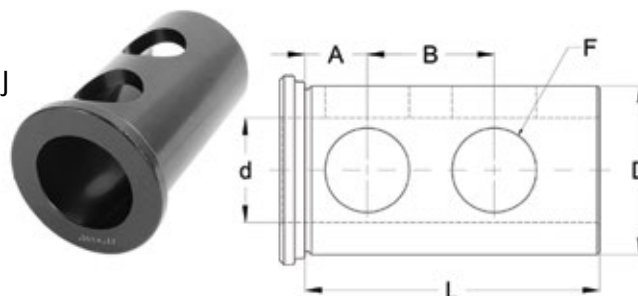

D Outside Diameter (Inch)	d Inside Diameter (Inch)	L Length Under Head (Inch)	A (Inch)	B (Inch)	F Hole Diameter (Inch)	Code	D Outside Diameter (Inch)	d Inside Diameter (Inch)	L Length Under Head (Inch)	A (Inch)	B (Inch)	F Hole Diameter (Inch)	Code
1	1/2	1-3/4	7/16	7/8	5/8	310418	1-1/2	3/4	2-1/2	11/16	1-1/8	7/8	310455
1	5/8	1-3/4	7/16	7/8	5/8	310420	1-1/2	7/8	2-1/2	11/16	1-1/8	7/8	310766
1	3/4	1-3/4	7/16	7/8	5/8	310422	1-1/2	1	2-1/2	11/16	1-1/8	7/8	310459
3 Piece Set – 1/2" to 3/4"						300878	1-1/2	1-1/4	2-1/2	11/16	1-1/8	7/8	310463
1-1/4	3/8	2-1/8	5/8	1	3/4	310436	7 Piece Set – 3/8" to 1-1/4"						300880
1-1/4	1/2	2-1/8	5/8	1	3/4	310437	1-3/4	1/2	3	3/4	1-1/4	7/8	310470
1-1/4	5/8	2-1/8	5/8	1	3/4	310440	1-3/4	5/8	3	3/4	1-1/4	7/8	310472
1-1/4	3/4	2-1/8	5/8	1	3/4	310441	1-3/4	3/4	3	3/4	1-1/4	7/8	310474
1-1/4	7/8	2-1/8	5/8	1	3/4	310764	1-3/4	7/8	3	3/4	1-1/4	7/8	310767
1-1/4	1	2-1/8	5/8	1	3/4	310445	1-3/4	1	3	3/4	1-1/4	7/8	310478
6 Piece Set – 3/8" to 1"						300879	1-3/4	1-1/4	3	3/4	1-1/4	7/8	310482
1-1/2	3/8	2-1/2	11/16	1-1/8	7/8	310765	1-3/4	1-1/2	3	3/4	1-1/4	7/8	310486
1-1/2	1/2	2-1/2	11/16	1-1/8	7/8	310451	7 Piece Set – 1/2" to 1-1/2"						300881
1-1/2	5/8	2-1/2	11/16	1-1/8	7/8	310453	2	1/2	3-1/2	3/4	1-1/2	1	310490

Tool Holder Bushings

CNC Bushings – Black Oxide Finish – Types C, CV, B, DD, J & Z (continued)

Type J (continued)

D Outside Diameter (Inch)	d Inside Diameter (Inch)	L Length Under Head (Inch)	A (Inch)	B (Inch)	F Hole Diameter (Inch)	Code	D Outside Diameter (Inch)	d Inside Diameter (Inch)	L Length Under Head (Inch)	A (Inch)	B (Inch)	F Hole Diameter (Inch)	Code
2	5/8	3-1/2	3/4	1-1/2	1	310491	2-1/2	1/2	4	7/8	1-3/4	1-1/4	310769
2	3/4	3-1/2	3/4	1-1/2	1	310492	2-1/2	5/8	4	7/8	1-3/4	1-1/4	310770
2	7/8	3-1/2	3/4	1-1/2	1	310768	2-1/2	3/4	4	7/8	1-3/4	1-1/4	310771
2	1	3-1/2	3/4	1-1/2	1	310494	2-1/2	7/8	4	7/8	1-3/4	1-1/4	310772
2	1-1/4	3-1/2	3/4	1-1/2	1	310496	2-1/2	1	4	7/8	1-3/4	1-1/4	310773
2	1-1/2	3-1/2	3/4	1-1/2	1	310498	2-1/2	1-1/4	4	7/8	1-3/4	1-1/4	310774
2	1-3/4	3-1/2	3/4	1-1/2	1	310500	2-1/2	1-1/2	4	7/8	1-3/4	1-1/4	310775
8 Piece Set – 1/2" to 1-3/4"						300882	2-1/2	1-3/4	4	7/8	1-3/4	1-1/4	310776
							2-1/2	2	4	7/8	1-3/4	1-1/4	310777
							2-1/2	2-1/4	4	7/8	1-3/4	1-1/4	310778
							10 Piece Set – 1/2" to 2-1/4"						300883

Type Z

- Z bushings have a long slot and two set screws in the bushing head
- Provides improved rigidity and reduced chatter

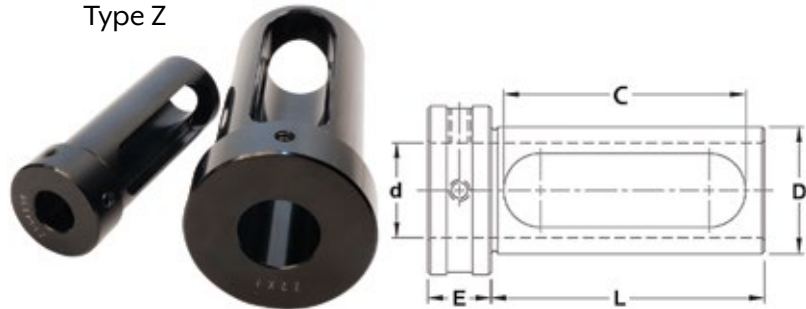

D Outside Diameter (Inch)	d Inside Diameter (Inch)	L Length Under Head (Inch)	C Slot Length (Inch)	E (Inch)	Code	D Outside Diameter (Inch)	d Inside Diameter (Inch)	L Length Under Head (Inch)	C Slot Length (Inch)	E (Inch)	Code
1-1/4	3/8	3	2-5/8	5/8	310808	7 Piece Set – 3/8" to 1-1/4"					300888
1-1/4	1/2	3	2-5/8	5/8	310809	1-3/4	1/2	3-1/4	3-1/8	3/4	310821
1-1/4	5/8	3	2-5/8	5/8	310810	1-3/4	5/8	3-1/4	3-1/8	3/4	310822
1-1/4	3/4	3	2-5/8	5/8	310811	1-3/4	3/4	3-1/4	3-1/8	3/4	310823
1-1/4	7/8	3	2-5/8	5/8	310812	1-3/4	1	3-1/4	3-1/8	3/4	310824
1-1/4	1	3	2-5/8	5/8	310813	1-3/4	1-1/4	3-1/4	3-1/8	3/4	310825
6 Piece Set – 3/8" to 1"					300887	5 Piece Set – 1/2" to 1-1/4"					300889
1-1/2	3/8	3-1/4	2-7/8	3/4	310814	2	1/2	3-3/4	3-1/2	3/4	310826
1-1/2	1/2	3-1/4	2-7/8	3/4	310815	2	3/4	3-3/4	3-1/2	3/4	310827
1-1/2	5/8	3-1/4	2-7/8	3/4	310816	2	7/8	3-3/4	3-1/2	3/4	310828
1-1/2	3/4	3-1/4	2-7/8	3/4	310817	2	1	3-3/4	3-1/2	3/4	310829
1-1/2	7/8	3-1/4	2-7/8	3/4	310818	2	1-1/4	3-3/4	3-1/2	3/4	310830
1-1/2	1	3-1/4	2-7/8	3/4	310819	2	1-1/2	3-3/4	3-1/2	3/4	310831
1-1/2	1-1/4	3-1/4	2-7/8	3/4	310820	6 Piece Set – 1/2" to 1-1/2"					300890

TG Collet Chucks

ISA

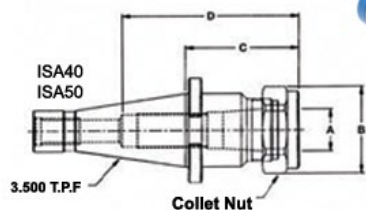

Taper	Collet	A Range (Inch)	B (Inch)	C (Inch)	D (Inch)	Code
ISA40	100	3/32 - 1	2.44	3.00	3.68	827322
ISA50	100	3/32 - 1	2.44	3.00	3.68	827323

Spare Parts

Wrenches

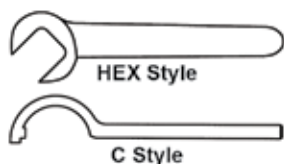

Collet	Style	Code
TG100	Hex	200619
TG150	C	201770



Collet	Code
TG100	827317
TG150	827318

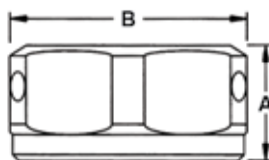

Collet Nuts

Collet	Style	A (Inch)	B (Inch)	Code
TG100	Hex	1.10	2.44	827333
TG150	C	1.25	3.25	827334



Collet	Thread	Code
TG150	ACME 2-5/8-12	827321

TG Rigid Tapping Collets

TG100 with Square Drive



- Manufactured to ANSI tap standards
- For synchronous tapping operations using any TG collet chuck
- Collet bore is exact tool diameter with square drive for accuracy and rigidity

ANSI Tap Size	Shank Diameter (Inch)	Drive Square (Inch)	Code	ANSI Tap Size	Shank Diameter (Inch)	Drive Square (Inch)	Code	ANSI Tap Size	Shank Diameter (Inch)	Drive Square (Inch)	Code
0-6	0.141	0.110	826500	3/8"	0.381	0.286	826506	3/4"	0.590	0.442	826512
#8	0.168	0.131	826501	7/16"	0.323	0.242	826507	7/8"	0.697	0.523	826513
#10	0.194	0.152	826502	1/2"	0.367	0.275	826508	1"	0.800	0.600	826514
#12	0.220	0.165	826503	9/16"	0.429	0.322	826509	1/8" PS	0.312	0.234	826515
1/4"	0.255	0.191	826504	5/8"	0.480	0.360	826510	1/8" PL	0.437	0.328	826516
5/16"	0.318	0.238	826505	11/16"	0.542	0.406	826511	1/4" P	0.562	0.421	826517
								3/8" P	0.700	0.531	826518
								1/2" P	0.687	0.515	826519

TG Collets

TG100 & TG150 Series – Inch

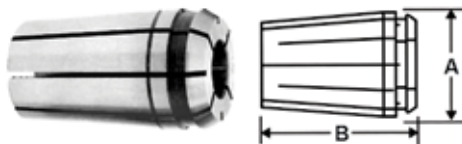

Collet	A (Inch)	B (Inch)
TG100	1.379	2.375
TG150	2.000	3.000

Size (Inch)	TG100 Code	TG150 Code	Size (Inch)	TG100 Code	TG150 Code	Size (Inch)	TG100 Code	TG150 Code	Size (Inch)	TG100 Code	TG150 Code
3/32	218201	-	7/16	218223	-	25/32	218245	218319	1-1/8	-	218341
7/64	218202	-	29/64	218224	-	51/64	218246	218320	1-9/64	-	218342
1/8	218203	-	15/32	218225	-	13/16	218247	218321	1-5/32	-	218343
9/64	218204	-	31/64	218226	-	53/64	218248	218322	1-11/64	-	218344
5/32	218205	-	1/2	218227	218301	27/32	218249	218323	1-3/16	-	218345
11/64	218206	-	33/64	218228	218302	55/64	218250	218324	1-13/64	-	218346
3/16	218207	-	17/32	218229	218303	7/8	218251	218325	1-7/32	-	218347
13/64	218208	-	35/64	218230	218304	57/64	218252	218326	1-15/64	-	218348
7/32	218209	-	9/16	218231	218305	29/32	218253	218327	1-1/4	-	218349
15/64	218210	-	37/64	218232	218306	59/64	218254	218328	1-17/64	-	218350
1/4	218211	-	19/32	218233	218307	15/16	218255	218329	1-9/32	-	218351
17/64	218212	-	39/64	218234	218308	61/64	218256	218330	1-19/64	-	218352
9/32	218213	-	5/8	218235	218309	31/32	218257	218331	1-5/16	-	218353
19/64	218214	-	41/64	218236	218310	63/64	218258	218332	1-21/64	-	218354
5/16	218215	-	21/32	218237	218311	1	-	218333	1-11/32	-	218355
21/64	218216	-	43/64	218238	218312	1-1/64	-	218334	1-23/64	-	218356
11/32	218217	-	11/16	218239	218313	1-1/32	-	218335	1-3/8	-	218357
23/64	218218	-	45/64	218240	218314	1-3/64	-	218336	1-25/64	-	218358
3/8	218219	-	23/32	218241	218315	1-1/16	-	218337	1-13/32	-	218359
25/64	218220	-	47/64	218242	218316	1-5/64	-	218338	1-27/64	-	218360
13/32	218221	-	3/4	218243	218317	1-3/32	-	218339	1-7/16	-	218361
27/64	218222	-	49/64	218244	218318	1-7/64	-	218340	1-29/64	-	218362
									1-15/32	-	218363
									1-31/64	-	218364
									1-1/2	-	218365

TG Collets

TG100 Series – Metric

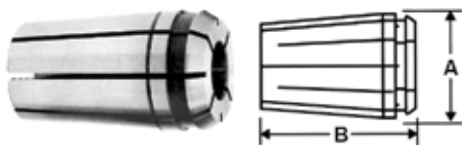

Collet	A (Inch/mm)	B (Inch/mm)
TG100	1.379/35	2.375/60

Size (mm)	TG100 Code	Size (mm)	TG100 Code	Size (mm)	TG100 Code	Size (mm)	TG100 Code	Size (mm)	TG100 Code	Size (mm)	TG100 Code
3	218103	7	218107	11	218111	15	218115	19	218119	23	218123
4	218104	8	218108	12	218112	16	218116	20	218120	24	218124
5	218105	9	218109	13	218113	17	218117	21	218121	25	218125
6	218106	10	218110	14	218114	18	218118	22	218122		

ER Collet Chucks

Straight Shank

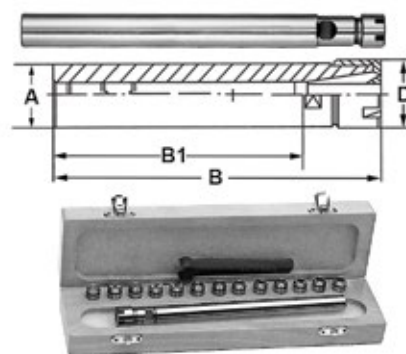
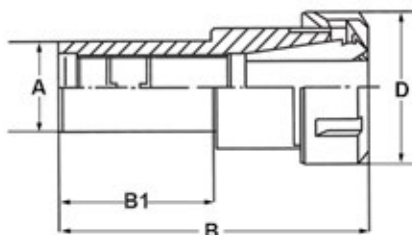

Sets include: wrench, chuck and collets (inch) and supplied in a fitted storage case

A (Inch)	B (Inch)	B1 (Inch)	D Diameter (Inch)	Nut Style	ER16		ER20	ER25	ER32		ER40
					Chuck Only	Set	Chuck Only	Chuck Only	Chuck Only	Set	Chuck Only
					Code	Code	Code	Code	Code	Code	Code
3/8	2-3/4	1-3/4	0.87	Mini	356900	-	-	-	-	-	-
1/2	6-1/2	6	0.87	Mini	356901	-	-	-	-	-	-
5/8	4	3	1.10	Hex	356902	-	-	-	-	-	-
3/4	3	2	1.10	Hex	356904	-	-	-	-	-	-
3/4	5	4	1.10	Hex	356905	-	-	-	-	-	-
1-1/4	3-1/4	2-1/4	1.10	Hex	356908	356945	-	-	-	-	-
5/8	6-1/4	5-1/2	1.10	Hex	356903	-	-	-	-	-	-
3/4	6-1/2	5-1/4	0.87	Mini	356906	-	-	-	-	-	-
1	6-1/4	5-1/2	1.10	Hex	356907	-	-	-	-	-	-
5/8	5-1/2	4	1.10	Mini	-	-	356925	-	-	-	-
3/4	5-1/2	4	1.10	Mini	-	-	356934	-	-	-	-
1	6-1/4	5-1/4	1.10	Mini	-	-	356926	-	-	-	-
5/8	3-1/4	2	1.65	E25	-	-	-	356935	-	-	-
3/4	5-1/4	2	1.65	E25	-	-	-	356936	-	-	-
1	5-1/4	4	1.38	Mini	-	-	-	356937	-	-	-
1	5-1/4	4	1.65	E25	-	-	-	356941	-	-	-
1	3-3/4	2	1.97	E32	-	-	-	-	356917	356919	-
1-1/4	4-1/4	2-1/4	1.97	E32	-	-	-	-	356918	-	-
1	3-3/4	2	2.48	E40	-	-	-	-	-	-	356922
1-1/4	4-1/4	2-1/4	2.48	E40	-	-	-	-	-	-	356923

Collet Storage Boxes

ER16		ER20		ER25		ER32		ER40	
Collet Capacity	Code	Collet Capacity	Code	Collet Capacity	Code	Collet Capacity	Code	Collet Capacity	Code
10	356929	12	356930	15	356933	18	356931	23	356932

ER Collets

Inch & Metric

- Precision collets
- Collet accuracy: 0.0003" to 0.0004" T.I.R.
- Wide clamping ranges: 0.02" to 0.039" collapsibility
- Made of high quality spring steel

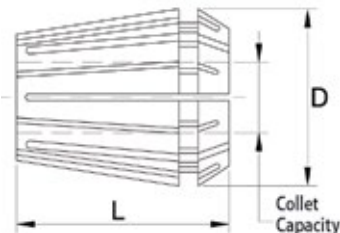

Collet Dimensions

Style	D (Inch)	L (Inch)
ER11	0.453	0.709
ER16	0.669	1.062
ER20	0.826	1.220
ER25	1.024	1.378
ER32	1.299	1.574
ER40	1.614	1.811

Inch

Nominal Diameter (Inch)	ER11	ER16	ER20	ER25	ER32	ER40
	Code	Code	Code	Code	Code	Code
1/32	-	826520	-	-	-	-
1/16	300641	826521	826532	826547	-	-
3/32	300642	826522	826533	826548	826566	-
1/8	300643	826523	826534	826549	826567	826588
5/32	300644	826524	826535	826550	826568	826589
3/16	300645	826525	826536	826551	826569	826590
7/32	300646	826526	826537	826552	826570	826591
1/4	300647	826527	826538	826553	826571	826592
9/32	-	826528	826539	826554	826572	826593
5/16	-	826529	826540	826555	826573	826594
11/32	-	826530	826541	826556	826574	826595
3/8	-	826531	826542	826557	826575	826596
13/32	-	300649	826543	826558	826576	826597
7/16	-	302697	826544	826559	826577	826598
15/32	-	-	826545	826560	826578	826599
1/2	-	302690	826546	826561	826579	826600
17/32	-	-	-	826562	826580	826601
9/16	-	-	-	826563	826581	826602
19/32	-	-	-	826564	826582	826603
5/8	-	-	302691	826565	826583	826604
21/32	-	-	-	-	826584	826605
11/16	-	-	-	-	826585	826606
23/32	-	-	-	-	826586	826607
3/4	-	-	-	302692	826587	826608
25/32	-	-	-	-	-	826609
13/16	-	-	-	-	-	826610
27/32	-	-	-	-	-	826611
7/8	-	-	-	-	302693	826612
29/32	-	-	-	-	-	826613
15/16	-	-	-	-	-	826614
31/32	-	-	-	-	-	826615
1	-	-	-	-	302694	826616
1-1/8	-	-	-	-	-	302695
1-1/4	-	-	-	-	-	302696

Metric – Collapsible 1 mm

Decimal Range (mm)	Size (mm)	ER16	ER20	ER25	ER32	ER40
		Code	Code	Code	Code	Code
0.04 – 0.08	1 – 2	-	-	302081	-	-
0.08 – 0.12	2 – 3	302001	302011	302082	302031	-

ER Collets

Inch & Metric

Metric – Collapsible 1 mm (continued)

Decimal Range (mm)	Size (mm)	ER16	ER20	ER25	ER32	ER40
		Code	Code	Code	Code	Code
0.12 – 0.16	3 – 4	302002	302012	302083	302032	302052
0.16 – 0.20	4 – 5	302003	302013	302084	302033	302053
0.20 – 0.24	5 – 6	302008	302014	302085	302034	302054
0.24 – 0.28	6 – 7	302004	302015	302086	302035	302055
0.28 – 0.32	7 – 8	302005	302016	302087	302036	302056
0.32 – 0.35	8 – 9	302006	302017	302088	302037	302057
0.35 – 0.39	9 – 10	302007	302018	302089	302038	302058
0.39 – 0.43	10 – 11	–	302019	302090	302039	302059
0.43 – 0.47	11 – 12	–	302020	302091	302040	302060
0.47 – 0.51	12 – 13	–	302021	302092	302041	302061
0.51 – 0.55	13 – 14	–	–	302093	302042	302062
0.55 – 0.59	14 – 15	–	–	302094	302043	302063
0.59 – 0.63	15 – 16	–	–	302095	302044	302064
0.63 – 0.67	16 – 17	–	–	–	302045	302065
0.67 – 0.71	17 – 18	–	–	–	302046	302066
0.71 – 0.75	18 – 19	–	–	–	302047	302067
0.75 – 0.79	19 – 20	–	–	–	302048	302068
0.79 – 0.83	20 – 21	–	–	–	–	302069
0.83 – 0.87	21 – 22	–	–	–	–	302070
0.87 – 0.91	22 – 23	–	–	–	–	302071
0.91 – 0.95	23 – 24	–	–	–	–	302072
0.95 – 0.98	24 – 25	–	–	–	–	302073
0.98 – 1.02	25 – 26	–	–	–	–	302074

ER Rigid Tapping Collets

With Square Drive



- For taps with ANSI shanks
- For synchronous tapping operations using any ER collet chuck
- Collet bore is exact tool diameter, with square drive, for accuracy and rigidity

Tap Size	Tap Shank Diameter (Inch)	Tap Shank Square (Inch)	ER16	ER20	ER25	ER32	ER40
			Code	Code	Code	Code	Code
0 – 6"	0.141	0.110	356200	356210	356220	356240	356270
#8	0.168	0.131	356201	356211	356221	356241	356271
#10	0.194	0.152	356202	356212	356222	356242	356272
#12	0.220	0.165	356203	356213	356223	356243	356273
1/4"	0.255	0.191	356204	356214	356224	356244	356274
5/16"	0.318	0.238	356205	356215	356225	356245	356275
3/8"	0.381	0.286	–	356216	356226	356246	356276
7/16"	0.323	0.242	–	356217	356227	356247	356277
1/2"	0.367	0.275	–	356218	356228	356248	356278
9/16"	0.429	0.322	–	–	356229	356249	356279
5/8"	0.480	0.360	–	–	356230	356250	356280
3/4"	0.590	0.442	–	–	–	356251	356281
7/8"	0.697	0.523	–	–	–	–	356282
1"	0.800	0.600	–	–	–	–	356283
1/8" Pipe SS	0.312	0.234	–	–	356231	356261	356291
1/8" Pipe LS	0.438	0.328	–	–	356232	356262	356292
1/4" Pipe	0.562	0.421	–	–	–	356263	356293
3/8" Pipe	0.700	0.531	–	–	–	–	356294
1/2" Pipe	0.687	0.515	–	–	–	–	356295

ER Collets – Steel Sealed

Inch & Metric



- Collet accuracy: 0.0003" to 0.0004" T.I.R. (0.008 mm to 0.010 mm)
- For optimal collet performance use tools with shank diameter equal to the collet nominal size
- Coolant allowable pressure: 1,500 PSI
- Made from high quality spring steel

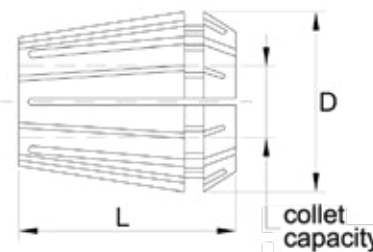

Inch

Nominal Diameter (Inch)	ER16 D = 0.669"/L = 1.083"	ER20 D = 0.827"/L = 1.240"	ER25 D = 1.024"/L = 1.339"	ER32 D = 1.299"/L = 1.575"	ER40 D = 1.614"/L = 1.811"
	Code	Code	Code	Code	Code
1/8	312211	312236	-	-	-
3/16	312213	312237	-	-	-
1/4	312215	312239	312263	312294	-
5/16	312217	312241	312265	312296	-
3/8	312219	312243	312267	312298	312339
7/16	-	312245	312269	312300	312341
1/2	-	312247	312271	312302	312343
9/16	-	-	312273	312304	312345
5/8	-	-	312275	312306	312347
11/16	-	-	-	312308	312349
3/4	-	-	-	312310	312351
13/16	-	-	-	312312	312353
7/8	-	-	-	-	312355
15/16	-	-	-	-	312357
1	-	-	-	-	312359

Metric

Nominal Diameter (mm)	ER16 D = 17mm/L = 27.5mm	ER20 D = 21mm/L = 31.5mm	ER25 D = 26mm/L = 34mm	ER32 D = 33mm/L = 40mm	ER40 D = 41mm/L = 46mm
	Code	Code	Code	Code	Code
3.0	312221	-	-	-	-
4.0	312222	-	-	-	-
5.0	312224	-	-	-	-
6.0	312226	312251	312279	312316	312362
7.0	312228	312252	312280	312317	312363
8.0	312230	312253	312281	312318	312364
9.0	312232	312254	312282	312319	312365
10.0	312234	312255	312283	312320	312366
11.0	-	312256	312284	312321	312367
12.0	-	312257	312285	312322	312368
13.0	-	312258	312286	312323	312369
14.0	-	-	312287	312324	312370
15.0	-	-	312288	312325	312371
16.0	-	-	312289	312326	312372
17.0	-	-	-	312327	312373
18.0	-	-	-	312328	312374
19.0	-	-	-	312329	312375
20.0	-	-	-	312330	312376
21.0	-	-	-	-	312377
22.0	-	-	-	-	312378
23.0	-	-	-	-	312379
24.0	-	-	-	-	312380
25.0	-	-	-	-	312381
26.0	-	-	-	-	312382

ER Collets – Steel Sealed

Inch & Metric

Sets – Inch & Metric

Collet	Inch		Metric	
	Nominal Diameter Range (Inch)	Code	Diameter Range (mm)	Code
ER16	–	–	3.0 – 10.0 (8-pc)	312206
ER20	1/8 – 1/2 by 16ths (7-pc)	312201	3.0 – 13.0 (11-pc)	312207
ER25	1/8 – 5/8 by 16ths (9-pc)	312202	3.0 – 16.0 (14-pc)	312208
ER32	1/8 – 13/16 by 16ths (12-pc)	312203	3.0 – 20.0 (18-pc)	312209
ER40	1/8 – 1 by 16ths (15-pc)	312205	3.0 – 26.0 (23-pc)	312210

Collet Storage Tray

Allows you to build and store your own collet set



Collets not included

ER16		ER20		ER25		ER32		ER40	
Collet Capacity	Code	Collet Capacity	Code	Collet Capacity	Code	Collet Capacity	Code	Collet Capacity	Code
10	302009	12	302022	15	302097	18	302049	24	302075

ER Collet Sets

Inch & Metric

- Accuracy: 0.00039"



ER20 Inch Collet Set shown

Inch Sets

Size	No. of Collets	Code
ER16	7	826617
ER20	10	826618
ER25	12	826619
ER32	11	826620
ER40	15	826621

Metric Sets

Size	No. of Collets	Code
ER16	8	302685
ER20	10	302686
ER25	15	302689
ER32	18	302687
ER40	23	302688

ER Collet Chucks, Sets & Accessories

ER Chucks – R8, ISA & Morse Taper Shanks



R8



ISA



MT



Sets include: Shank, collets, wrench, supplied in storage case

Shank	Collet Style	Collet Range (Inch)	Collet Chuck Only		Collet Chuck Sets	
			Collet Range (mm)	Code	Quantity per Set	Code
R8	ER32	0.08-0.79	2-20	302600	18	302610
ISA40	ER32	0.08-0.79	2-20	302601	18	302611
MT3	ER32	0.08-0.79	2-20	302605	-	-
MT4	ER32	0.08-0.79	2-20	302606	-	-
R8	ER40	0.12-1	3-25	302604	15	302614
ISA40	ER40	0.12-1	3-25	302602	15	302612
ISA50	ER40	0.12-1	3-25	302603	15	302613
MT3	ER40	0.12-1	3-25	302607	-	-
MT4	ER40	0.12-1	3-25	302608	-	-

ER Collet Chucks, Sets & Accessories

ER Clamping Nuts

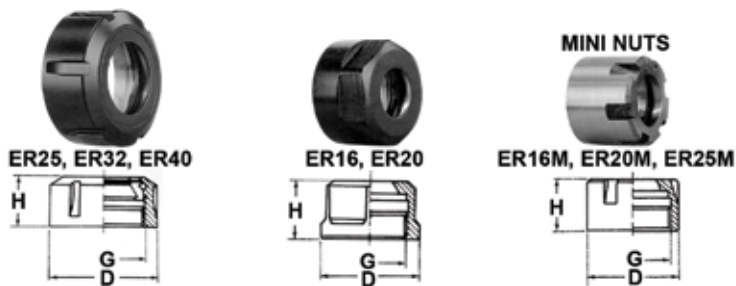

Type	D (mm)	H (mm)	G	Code	Type	D (mm)	H (mm)	G	Code
ER16M	22	22	M19 x 1.0	827000	ER25M	35	20	M30 x 1.0	827004
ER16	28	17	M22 x 1.5	827001	ER25	42	20	M32 x 1.5	827005
ER20M	28	19	M24 x 1.0	827002	ER32	50	22	M40 x 1.5	827006
ER20	34	19	M25 x 1.5	827003	ER40	63	25	M50 x 1.5	827007

ER Collet Wrenches

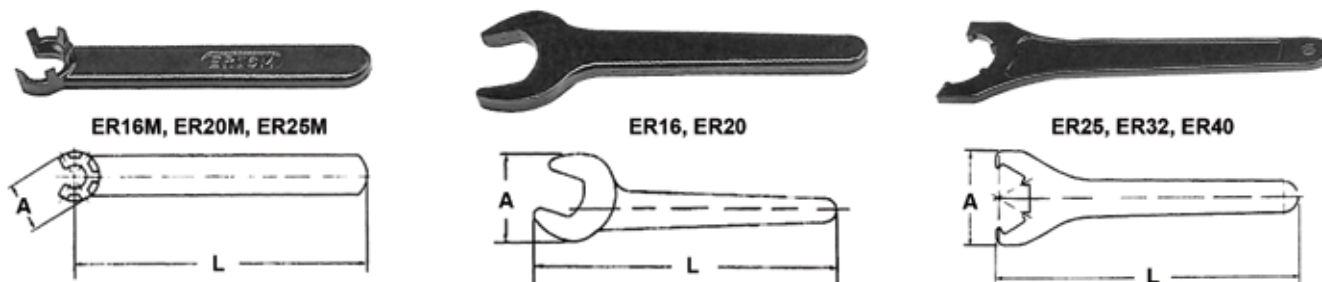

Type	A (mm)	L (mm)	Code	Type	A (mm)	L (mm)	Code	Type	A (mm)	L (mm)	Code
ER16M	22.5	110	827008	ER20	60.0	135	827011	ER32	75.0	250	827014
ER16	42.0	140	827009	ER25M	36.0	150	827012	ER40	90.0	290	827015
ER20M	29.0	120	827010	ER25	75.0	250	827013				

ER Collet Chucks & Accessories



ER Collet Chucks – CAT40 & CAT50



- Constructed of high quality alloy steel - SAE8620/20MnCR5
- Taper to taper runout: <0.0002"
- Coolant through spindle
- CAT40 balanced G2.5@20,000 RPM
- CAT50 balanced G6.3@15,000 RPM
- Balanced tools supplied with QA certificates
- Supplied with depth set screws
- Supplied with high torque hard coat power nuts
- Taper shank ground to AT3 accuracy or better
- DIN AD+B flange coolant

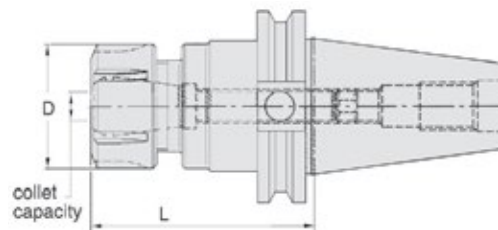

NOTE: Collet wrench sold separately

Collet Series	Collet Cap Min-Max (Inch)	Nut	D (Inch)	L (Inch)	Locknut Reference	Wrench Reference	CAT40		CAT50	
							Weight (lbs)	Code	Weight (lbs)	Code
ER11	0.02-0.28	Hex	0.79	2.50	301731	301790	2.0	300681	-	-
ER11	0.02-0.28	Hex	0.79	4.00	301731	301790	2.2	300682	-	-
ER11	0.02-0.28	Hex	0.79	6.00	301731	301790	2.4	300683	-	-
ER16	0.02-0.41	Hex	1.10	2.50	312182	312174	2.4	310965	-	-
ER16	0.02-0.41	Hex	1.10	4.00	312182	312174	3.2	310966	7.3	312054
ER16	0.02-0.41	Hex	1.10	5.00	312182	312174	3.2	310967	-	-
ER16	0.02-0.41	Hex	1.10	6.00	312182	312174	-	-	7.9	312055
ER20	0.02-0.50	Hex	1.34	2.50	312183	312175	2.4	310968	-	-
ER20	0.02-0.50	Hex	1.34	4.00	312183	312175	3.5	310969	7.4	312056
ER20	0.02-0.50	Hex	1.34	6.00	312183	312175	3.7	310970	8.1	312057
ER25	0.04-0.63	Round	1.65	2.50	312179	312171	2.6	310971	-	-
ER25	0.04-0.63	Round	1.65	4.00	312179	312171	4.5	310972	7.8	312058
ER25	0.04-0.63	Round	1.65	6.00	312179	312171	4.4	310973	8.8	312059
ER32	0.04-0.81	Round	1.97	2.75	312180	312172	2.6	310974	-	-
ER32	0.04-0.81	Round	1.97	4.00	312180	312172	6.8	310975	8.1	312060
ER32	0.04-0.81	Round	1.97	6.00	312180	312172	4.4	310976	9.5	312061
ER40	0.12-1.00	Round	2.48	3.00	312181	312173	3.0	310977	-	-
ER40	0.12-1.00	Round	2.48	4.00	312181	312173	-	-	8.9	312062
ER40	0.12-1.00	Round	2.48	6.00	312181	312173	3.0	310978	11.8	312063

Spare Wrenches & Nuts for ER Collet Chucks



Nut Size	Hex		Round		
	Hex Nut	Wrench (Style 1)	Round Nut	Wrench Hook Style (Style 2)	Wrench U-Style (Style 3)
	Code	Code	Code	Code	Code
ER11	301731	301790	-	-	-
ER16	312182	312174	301725	-	301705
ER20	312183	312175	301726	-	301706
ER25	-	-	301727	301707	312171
ER32	301732	312176	301728	301708	312172
ER40	-	-	301729	301709	312173

ER Collet Chucks & Accessories

ER Stub Collet Chucks – CAT40 & CAT50



- Taper to taper runout: <0.0002"
- Coolant through spindle
- Balanced G6.3@15,000 RPM
- Balanced tools supplied with QA certificates
- Supplied with depth set screws
- Supplied with high torque hard coat power nuts
- Taper shank ground to AT3 accuracy or better
- DIN AD+B flange coolant

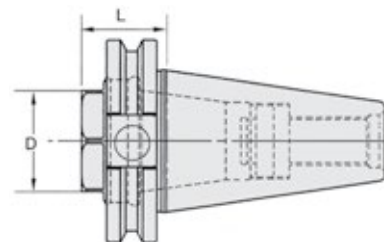

NOTE: Collet wrench sold separately

Collet Series	Collet Cap Min-Max (Inch)	Nut	D (Inch)	L (Inch)	Locknut Reference	Wrench Reference	Stop Screw Reference	CAT40		CAT50	
								Weight (lbs)	Code	Weight (lbs)	Code
ER32	0.08-0.81	Hex	1.41	1.69	312177	312176	312187	1.7	310988	6.3	312073



ER Straight Shank Collet Chucks

- Shank to taper runout: 0.0002"
- Coolant stop screw included

NOTE: Collet wrench sold separately

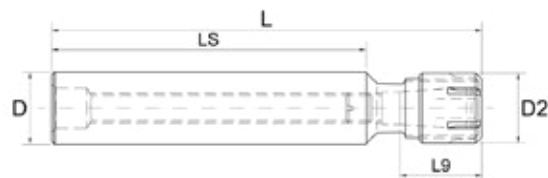

Collet Series	Collet Cap Min-Max (Inch)	D (Inch)	D2 (Inch)	L (Inch)	LS (Inch)	L9 (Inch)	Weight (lbs)	Locknut Type	Code
ER11	0.020-0.276	1/2	0.63	7.00	5.51	1.27	0.40	*Round Slim	312128
ER16	0.020-0.406	3/4	0.87	7.00	5.51	1.24	0.90	*Round Slim	312130
ER20	0.020-0.512	1	1.38	7.00	5.51	1.42	1.60	Hex	312133
ER25	0.040-0.630	1	1.65	7.50	5.69	1.57	1.70	Round	312134
ER32	0.040-0.810	3/4	1.97	6.00	4.65	1.34	1.10	Round	312131
ER32	0.040-0.810	1	1.97	7.50	5.69	1.93	1.83	Round	312135
ER32	0.040-0.810	1-1/4	1.97	4.50	2.75	1.72	1.60	Round	312139
ER32	0.040-0.810	1-1/4	1.97	6.00	3.10	1.72	2.10	Round	312140
ER40	0.120-1.000	1	2.47	4.50	2.38	2.17	2.30	Round	312136
ER40	0.120-1.000	1	2.47	7.00	4.87	1.77	2.70	Round	312137
ER40	0.120-1.000	1-1/4	2.47	4.50	2.38	2.17	1.90	Round	312141
ER40	0.120-1.000	1-1/4	2.47	6.50	4.87	2.17	3.10	Round	312142

* Round slim nut for close center work

Full Grip Collet Chucks

OZ25 & OZ32



Sets include: chuck, wrench, collets (10 with OZ25, 15 with OZ32) and supplied in storage case

Chuck Size	Capacity	Taper Shanks	Collets for Cylindrical Shanks		Collets for Threaded End Mills
			Inch	Metric (mm)	
OZ25	1/8 - 1	ISA 30, 40, 50 MT 3, 4, R8	1/8, 3/16, 1/4, 5/16 3/8, 1/2, 5/8, 3/4, 7/8, 1	2-25 x 1	1/4, 3/8, 1/2, 5/8, 3/4
OZ32	1/4 - 1-1/4	ISA 40, 50	1/4, 5/16, 3/8, 7/16 1/2, 9/16, 5/8, 11/16 3/4, 13/16, 7/8, 15/16 1, 1-1/8, 1-1/4	6-32 x 1	1/4, 3/8, 1/2, 5/8, 3/4, 1

Shank	OZ25		OZ32	
	Chuck Only	Sets	Chuck Only	Sets
	Code	Code	Code	Code
ISA30	215010	215110	-	-
ISA40	215011	215111	215411	215421
ISA50	215012	215112	215412	215422
MT3	215013	215113	-	-
MT4	215014	215114	-	-
R8	215019	215119	-	-
Wrench	215320	-	-	-

Full Grip Collets

For Cylindrical Shanks – DIN 6388 – OZ25 & OZ32 – Inch & Metric



Inch

Diameter (Inch)	OZ25	OZ32
	Code	Code
1/8	215201	-
3/16	215202	-
1/4	215203	215503
5/16	215204	215504
3/8	215205	215505
7/16	215206	215506
1/2	215207	215507
9/16	215208	215508
5/8	215209	215509
11/16	215210	215510
3/4	215211	215511
13/16	215212	215512
7/8	215213	215513
15/16	215214	215514
1	215215	215515
1-1/8	-	215516
1-1/4	-	215517

Metric

Diameter (mm)	OZ25	OZ32	Diameter (mm)	OZ25	OZ32
	Code	Code		Code	Code
3	215243	-	18	215258	215558
4	215244	215544	19	215259	215559
5	215245	215545	20	215260	215560
6	215246	215546	21	215261	215561
7	215247	215547	22	215262	215562
8	215248	215548	23	215263	215563
9	215249	215549	24	215264	215564
10	215250	215550	25	215265	215565
11	215251	215551	26	-	215566
12	215252	215552	27	-	215567
13	215253	215553	28	-	215568
14	215254	215554	29	-	215569
15	215255	215555	30	-	215570
16	215256	215556	31	-	215571
17	215257	215557	32	-	215572

Double Angle Collet Extensions

Collets & Nuts

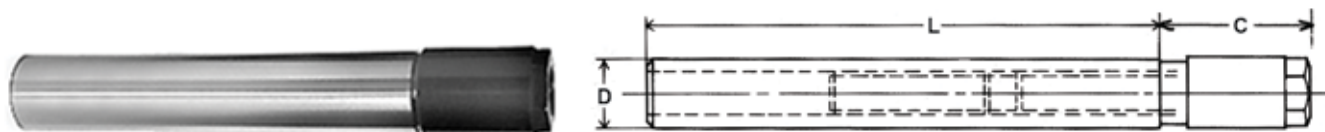

Collet Style	Range (Inch)	D (Inch)	L (Inch)	C (Inch)	Extension	Nut
					Code	Code
300 DA	0.031 – 0.250	1/2	5-1/2	1-5/16	304001	304011
200 DA	0.047 – 0.375	3/4	5-1/2	1-5/8	304002	304012
100 DA	0.047 – 0.562	1	5-1/2	1-13/16	304003	304013
180 DA	0.047 – 0.750	1-1/4	5-1/2	1-13/16	304004	304014

Double Angle Collets

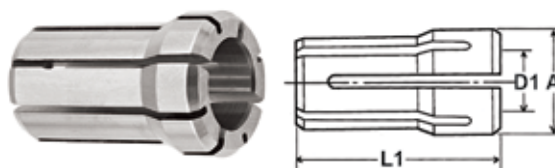

D1 (Inch)	300DA	200DA	100DA	180DA
	L1 = 1.000" A Max. Diameter = 0.375"	L1 = 1.188" A Max. Diameter = 0.531"	L1 = 1.438" A Max. Diameter = 0.769"	L1 = 1.625" A Max. Diameter = 1.035"
	Code	Code	Code	Code
1/32	826622	-	-	-
3/64	826623	826637	826659	826693
1/16	826624	826638	826660	826694
5/64	826625	826639	826661	826695
3/32	826626	826640	826662	826696
7/64	826627	826641	826663	826697
1/8	826628	826642	826664	826698
9/64	826629	826643	826665	826699
5/32	826630	826644	826666	826700
11/64	826631	826645	826667	826701
3/16	826632	826646	826668	826702
13/64	826633	826647	826669	826703
7/32	826634	826648	826670	826704
15/64	826635	826649	826671	826705
1/4	826636	826650	826672	826706
17/64	-	826651	826673	826707
9/32	-	826652	826674	826708
19/64	-	826653	826675	826709
5/16	-	826654	826676	826710
21/64	-	826655	826677	826711
11/32	-	826656	826678	826712
23/64	-	826657	826679	826713
3/8	-	826658	826680	826714

D1 (Inch)	300DA	200DA	100DA	180DA
	L1 = 1.000" A Max. Diameter = 0.375"	L1 = 1.188" A Max. Diameter = 0.531"	L1 = 1.438" A Max. Diameter = 0.769"	L1 = 1.625" A Max. Diameter = 1.035"
	Code	Code	Code	Code
25/64	-	-	826681	826715
13/32	-	-	826682	826716
27/64	-	-	826683	826717
7/16	-	-	826684	826718
29/64	-	-	826685	826719
15/32	-	-	826686	826720
31/64	-	-	826687	826721
1/2	-	-	826688	826722
33/64	-	-	826689	826723
17/32	-	-	826690	826724
35/64	-	-	826691	826725
9/16	-	-	826692	826726
37/64	-	-	-	826727
19/32	-	-	-	826728
39/64	-	-	-	826729
5/8	-	-	-	826730
41/64	-	-	-	826731
21/32	-	-	-	826732
43/64	-	-	-	826733
11/16	-	-	-	826734
45/64	-	-	-	826735
23/32	-	-	-	826736
47/64	-	-	-	826737
3/4	-	-	-	826738

End Mill Holders

CAT40 & CAT50



- Taper to bore runout: <0.0002"
- H5 bore tolerance
- Coolant through spindle
- CAT40 balanced G2.5@20,000 RPM
- CAT50 balanced G6.3@15,000 RPM
- Balanced tools supplied with QA certificates
- Taper shank ground to AT3 accuracy or better
- DIN AD+B flange coolant

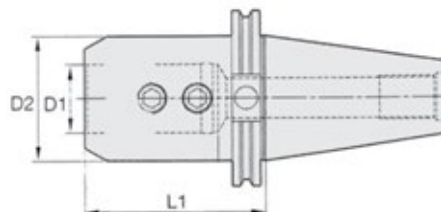

D1 (Inch)	D2 (Inch)	L1 Gage Length (Inch)	Clamping Screw Reference	No. of Clamp Screws	Wrench Size (Allen Key)	CAT40		CAT50	
						Weight (lbs)	Code	Weight (lbs)	Code
1/8	0.69	1.38	3I2143	1	3/32	1.79	3I2010	-	-
1/8	0.69	4.50	3I2143	1	3/32	2.41	3I0940	-	-
3/16	0.69	1.38	3I2143	1	3/32	1.79	3I2011	-	-
3/16	0.69	2.50	3I2143	1	3/32	2.22	3I0941	6.55	3I2029
3/16	0.69	4.50	3I2143	1	3/32	2.41	3I0942	6.84	3I2030
1/4	0.78	1.38	3I2144	1	1/8	1.82	3I2012	-	-
1/4	0.78	2.50	3I2144	1	1/8	-	-	6.55	3I2031
1/4	1.00	2.50	3I2144	1	1/8	2.35	3I0943	-	-
1/4	0.78	4.50	3I2144	1	1/8	2.51	3I0944	7.17	3I2032
1/4	0.78	8.00	3I2144	1	1/8	3.80	3I0769	-	-
5/16	1.00	1.38	3I2145	1	5/32	1.85	3I2013	-	-
5/16	1.00	4.50	3I2145	1	5/32	2.76	3I0945	7.15	3I2033
3/8	1.00	1.38	3I2146	1	3/8	1.85	3I2014	-	-
3/8	1.00	2.50	3I2146	1	3/16	2.32	3I0946	6.63	3I2034
3/8	1.00	4.50	3I2146	1	3/16	2.69	3I0947	7.07	3I2035
3/8	1.00	6.50	3I2146	1	3/16	3.17	3I0948	7.45	3I2036
7/16	1.25	1.75	3I2147	1	7/32	2.00	3I2015	-	-
7/16	1.25	4.50	3I2147	1	7/32	3.04	3I0949	6.78	3I2037
1/2	1.75	1.75	3I2147	1	7/32	2.27	3I2016	-	-
1/2	1.38	2.62	3I2147	1	7/32	2.52	3I0950	6.82	3I2038
1/2	1.38	4.62	3I2147	1	7/32	-	-	7.52	3I2039
1/2	1.38	6.62	3I2147	1	7/32	-	-	8.21	3I2040
1/2	1.25	4.62	3I2147	1	7/32	3.05	3I0951	-	-
1/2	1.25	6.62	3I2147	1	7/32	3.83	3I0952	-	-
5/8	1.75	1.75	3I2149	1	1/4	2.19	3I2017	-	-
5/8	1.50	3.75	3I2149	1	1/4	2.96	3I0953	-	-
5/8	1.63	3.75	3I2149	1	1/4	-	-	7.53	3I2041
5/8	1.63	5.75	3I2149	1	1/4	4.21	3I0954	8.63	3I2042
3/4	1.75	1.75	3I2150	1	5/16	2.09	3I2018	-	-
3/4	1.75	3.75	3I2150	1	5/16	3.21	3I0955	7.65	3I2043
3/4	1.75	5.75	3I2150	1	5/16	4.44	3I0956	8.67	3I2044
7/8	1.88	1.75	3I2150	1	5/16	2.31	3I2019	-	-
7/8	2.00	4.00	3I2150	1	5/16	3.65	3I0957	8.00	3I2045
7/8	1.88	6.00	3I2150	1	5/16	4.86	3I0958	-	-
7/8	2.00	6.00	3I2150	1	5/16	-	-	9.44	3I2046
1	1.75	1.75	3I2151	2	3/8	1.78	3I2020	-	-
1	2.00	4.00	3I2153	2	3/8	3.39	3I0959	7.95	3I2047
1	2.00	6.00	3I2153	2	3/8	5.04	3I0960	9.39	3I2048
1-1/4	2.25	2.00	3I2152	2	3/8	2.25	3I2021	-	-
1-1/4	2.50	4.25	3I2154	2	3/8	4.96	3I0961	8.98	3I2049
1-1/4	2.50	6.25	3I2154	2	3/8	7.47	3I0962	11.42	3I2050



End Mill Holders

CAT40 & CAT50 (continued)

D1 (Inch)	D2 (Inch)	L1 Gage Length (Inch)	Clamping Screw Reference	No. of Clamp Screws	Wrench Size (Allen Key)	CAT40		CAT50	
						Weight (lbs)	Code	Weight (lbs)	Code
1-1/2	2.75	4.62	312155	2	3/8	5.80	310963	9.19	312051
1-1/2	2.75	6.62	312155	2	3/8	8.76	310964	12.21	312052
2	3.94	5.62	312155	2	1/2	-	-	17.70	312053

End Mill Holders

- Produced according to AT3 specifications and made of alloy forged steel for long, durable service life
- Hardened to 56-60 HRC and ground to ensure maximum accuracy
- End mill socket total indicator runout <0.0004"

R8, ISA (NMTB) 30, 40, 50 Shanks



R8

Draw Bar Threads

- ISA30 1/2"-13 UNC
- ISA40 5/8"-11 UNC
- ISA50 1"-8 UNC

R8 DRAW BAR THREAD

- 7/16"-20 UNF



ISA

Hole Diameter (Inch)	Set Screw Thread Reference	Set Screw Code Reference	ISA30	ISA40	ISA50	R8
			Code	Code	Code	Code
3/16	1/4-28 x 5/16	827105	827016	827024	827034	827044
1/4	1/4-28 x 1/4	827106	827017	827025	-	-
3/8	3/8-24 x 25/64	827107	827018	827026	827035	827045
1/2	7/16-20 x 15/32	827108	827019	827027	827036	827046
5/8	9/16-18 x 15/32	827109	827020	827028	827037	827047
3/4	5/8-18 x 33/64	827110	827021	827029	827038	827048
7/8	5/8-18 x 33/64	827110	827022	827030	827039	827049
1	3/4-16 x 19/32	827112	-	827031	827040	827050
1-1/4	3/4-16 x 5/8	827113	-	827032	827041	827051
1-1/2	3/4-16 x 45/64	827114	-	827033	827042	827052
2	1-14 x 15/16	827118	-	-	827043	-

Morse Taper Shanks – Style A Tanged & Style B Threaded



Style A - Tanged

Draw Bar Threads

- MT2 3/8" – 16 UNC
- MT3 1/2" – 13 UNC
- MT4 5/8" – 11 UNC
- MT5 1" – 8 UNC



Style B - Threaded

NOTE: 5/8" holders with MT2 shank are for single end mills only

Shank	Hole Diameter (Inch)	Set Screw Thread Reference	Set Screw Code Reference	Style A Tanged	Style B Threaded	Shank	Hole Diameter (Inch)	Set Screw Thread Reference	Set Screw Code Reference	Style A Tanged	Style B Threaded
				Code	Code					Code	Code
MT2	3/16	1/4-28 x 5/16	827105	827053	827079	MT4	3/4	5/8-18 x 33/64	827110	827067	827093
MT2	1/4	1/4-28 x 1/4	827106	-	827080	MT4	7/8	5/8-18 x 33/64	827110	827068	827094
MT2	3/8	3/8-24 x 25/64	827107	827055	827081	MT4	1	3/4-16 x 19/32	827112	827069	-
MT2	1/2	7/16-20 x 15/32	827108	827056	827082	MT5	3/8	3/8-24 x 25/64	827105	827070	827096
MT2	5/8	9/16-18 x 15/32	827109	827057	827083	MT5	1/2	7/16-20 x 15/32	827107	827071	-
MT3	3/16	1/4-28 x 5/16	827105	827058	827084	MT5	5/8	9/16-18 x 15/32	827108	827072	827098
MT3	1/4	1/4-28 x 1/4	827106	-	827085	MT5	3/4	5/8-18 x 33/64	827110	827073	-
MT3	3/8	3/8-24 x 25/64	827107	827060	827086	MT5	7/8	5/8-18 x 33/64	827110	827074	827100
MT3	1/2	7/16-20 x 15/32	827108	827061	827087	MT5	1	3/4-16 x 19/32	827112	827075	827101
MT3	5/8	9/16-18 x 15/32	827109	827062	827088	MT5	1-1/4	3/4-16 x 5/8	827113	827076	827102
MT3	3/4	5/8-18 x 33/64	827110	827063	827089	MT5	1-1/2	3/4-16 x 45/64	827114	827077	827103
MT4	3/8	3/8-24 x 25/64	827105	827064	827090	MT5	2	1-14 x 15/16	827118	827078	827104
MT4	1/2	7/16-20 x 15/32	827107	827065	827091						
MT4	5/8	9/16-18 x 15/32	827108	827066	827092						

Set Screws

NOTE: Holders 7/8" diameter and above furnished with 2 set screws



Thread	Code	Thread	Code	Thread	Code	Thread	Code	Thread	Code
1/4-28 x 5/16	827105	3/8-24 x 25/64	827107	9/16-18 x 15/32	827109	3/4-16 x 19/32	827112	3/4-16 x 45/64	827114
1/4-28 x 1/4	827106	7/16-20 x 15/32	827108	5/8-18 x 33/64	827110	3/4-16 x 5/8	827113	3/4-16 x 1-13/32	827117
								1-14 x 15/16	827118

Shell Mill Adapters

- Taper to pilot runout: <0.0002"
- Taper shank ground to AT3 accuracy or better
- H6 pilot tolerance
- AD+B coolant through spindle and flange
- Balanced by design
- Provided with a non-coolant arbor screw (coolant arbor screws sold separately)

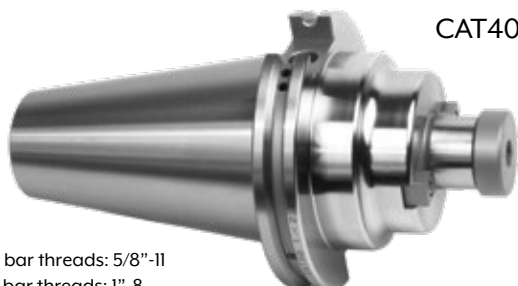

CAT40 & CAT50

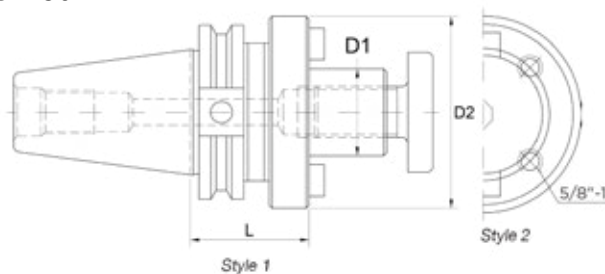

- CAT40 draw bar threads: 5/8"-11
- CAT50 draw bar threads: 1"-8

D1 (Inch)	D2 (Inch)	L (Inch)	Clamp Screw Reference	Wrench Size (Allen Key)	Drive Key Size (Inch)	CAT40		CAT50	
						Weight (lbs)	Code	Weight (lbs)	Code
1/2	1.75	1.38	301761	3/16	1/4	2.27	310989	-	-
1/2	2.75	1.38	301761	3/16	1/4	-	-	6.82	312074
1/2	1.44	3.50	301761	3/16	1/4	-	-	7.54	312075
3/4	2.75	1.38	301741	1/4	5/16	-	-	6.88	312076
3/4	1.75	1.38	301741	1/4	5/16	2.21	310990	-	-
3/4	1.75	3.50	301741	1/4	5/16	3.80	310991	8.34	312077
3/4	1.75	6.00	301741	1/4	5/16	-	-	9.70	312078
1	2.19	2.06	301742	5/16	3/8	3.10	310992	7.37	312079
1	2.19	4.00	301742	5/16	3/8	4.30	310993	-	-
1	2.40	4.00	301742	5/16	3/8	-	-	9.97	312080
1	2.40	6.00	301742	5/16	3/8	-	-	12.46	312081
1-1/4	2.75	2.12	301743	5/16	1/2	4.00	310994	7.18	312082
1-1/4	2.75	4.00	301743	5/16	1/2	5.00	310995	10.31	312083
1-1/4	2.75	6.00	301743	5/16	1/2	-	-	11.35	312084
1-1/2	3.38	2.41	301762	3/8	5/8	5.01	310996	9.71	312085
1-1/2	3.38	4.00	301762	3/8	5/8	5.01	310997	12.27	312086
1-1/2	3.38	6.00	301762	3/8	5/8	-	-	13.40	312087
2	4.37	2.40	301763	3/8	3/4	-	-	12.50	* 301770
2-1/2	4.88	2.40	-	-	1	-	-	19.00	301771

* Non-coolant through

MILLING TOOLS

Boring Bar Blanks

CAT V-Flange Shanks

- Constructed of high quality alloy steel - SAE8620/20MnCR5
- 58+/-2 HRC shank
- 20-30 HRC blank part
- Taper shank ground to AT3 accuracy or better

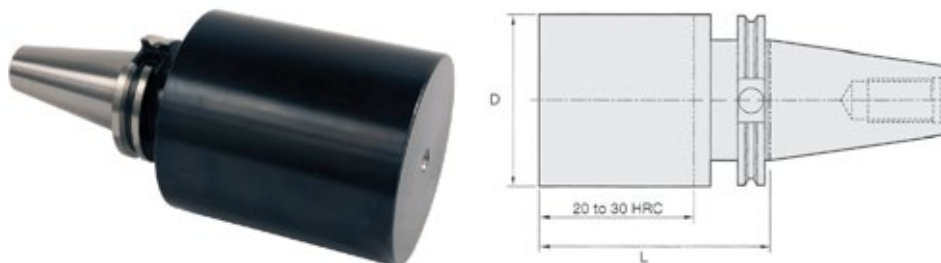

CAT40				CAT50			
D (Inch)	L (Inch)	Weight (lbs)	Code	D (Inch)	L (Inch)	Weight (lbs)	Code
4.00	12.00	39.89	310933	4.00	12.00	44.56	312023
4.00	6.00	18.55	310934	4.00	6.00	23.23	312024
-	-	-	-	6.00	6.00	43.50	312025

Morse Taper Adapters



- Coolant through spindle
- Taper shank ground to AT3 accuracy or better

CAT40 & CAT50

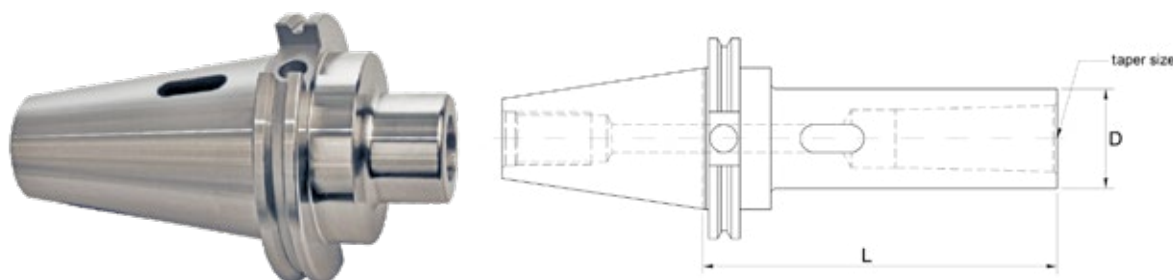

- MT - CAT Form A
- CAT40 draw bar threads: 5/8"-11
- CAT50 draw bar threads: 1"-8

Taper Size	CAT40				CAT50			
	D (Inch)	L (Inch)	Weight (lbs)	Code	D (Inch)	L (Inch)	Weight (lbs)	Code
MT1	0.98	1.75	2.21	310984	2.75	1.75	6.90	312068
MT2	1.26	2.44	2.30	310985	2.75	2.00	7.43	312069
MT3	1.57	3.00	2.49	310986	1.57	2.50	6.73	312070
MT4	1.89	3.88	2.86	310987	1.89	3.38	6.90	312071
MT5	-	-	-	-	2.75	3.75	7.55	312072

Jacobs Taper Adapters



- Designed to use with keyless Jacobs chucks
- Non-coolant through
- Taper shank ground to AT3 accuracy or better

CAT40 & CAT50

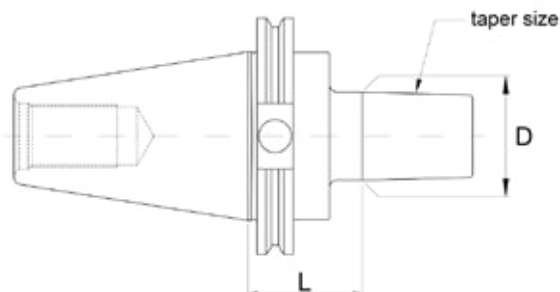

- CAT40 draw bar threads: 5/8"-11
- CAT50 draw bar threads: 1"-8

Taper Size	D (Inch)	L (Inch)	CAT40		CAT50	
			Weight (lbs)	Code	Weight (lbs)	Code
JT2	0.560	1.57	2.10	300719	2.65	300724
JT2	0.560	2.44	2.33	310979	2.93	312064
JT3	0.812	1.57	2.30	300720	2.90	300725
JT3	0.812	2.78	2.45	310980	3.06	312065
JT33	0.625	1.57	2.20	300721	2.81	300726
JT33	0.625	2.56	2.32	310981	2.96	312066
JT4	1.124	1.57	2.18	300722	6.45	300727
JT4	1.124	2.44	2.45	310982	-	-
JT4	1.124	3.25	-	-	6.97	312067
JT5	1.413	1.57	-	-	6.92	300728
JT5	1.413	3.25	-	-	7.25	300729
JT6	0.676	1.57	2.50	300723	6.95	300730
JT6	0.676	2.44	2.78	310983	-	-

Tightening Fixtures

Universal H/V CNC Tool Tightening Fixtures



Mount in vertical and horizontal positions

- Multiple usage on tool holder shank CAT, BT, NMTB and ISO
- Enables strong gripping power of tool holder
- Access both ends of tool holders simultaneously
- Provides maximum protection of tool holder
- Tools may be mounted in vertical and horizontal positions
- High quality compact and rigid design for mounting on work table or tool cart
- Body is constructed of strong, high quality aluminum alloy

Taper Size	Overall Height (Inch)	Overall Length (Inch)	Width (Inch)	Weight (lbs)	Code
30	4.84	7.09	3.23	3.8	310841
40	5.12	7.09	3.23	4.2	310842
50	7.24	9.84	4.72	8.4	310843

Shell Mill Arbors

ISA (NMTB) Shanks



- Made of alloy forged steel for long, durable service life
- Hardened to 56-60 HRC and ground to ensure maximum accuracy
- Shell end mill pilot total indicator runout <0.0004"

Draw Bar Threads:

- ISA30 1/2"-13 UNC
- ISA40 5/8"-11 UNC
- ISA50 1"-8 UNC

Shank	Arbor Diameter (Inch)	For Shell End Mills (Inch)	Weight (lbs)	Code	Shank	Arbor Diameter (Inch)	For Shell End Mills (Inch)	Weight (lbs)	Code
ISA30	1/2	1-1/4 - 1-1/2	0.82	827119	ISA40	1-1/2	4 - 5	2.76	827127
ISA30	3/4	1-3/4 - 2	0.95	827120	ISA40	2	5-1/2 - 6	3.44	827128
ISA30	1	2-1/4 - 2-3/4	1.26	827121	ISA50	1/2	1-1/4 - 1-1/2	6.00	827129
ISA30	1-1/4	3 - 3-1/2	1.32	827122	ISA50	3/4	1-3/4 - 2	6.10	827130
ISA40	1/2	1-1/4 - 1-1/2	1.85	827123	ISA50	1	2-1/4 - 2-3/4	6.40	827131
ISA40	3/4	1-3/4 - 2	1.96	827124	ISA50	1-1/4	3 - 3-1/2	6.50	827132
ISA40	1	2-1/4 - 2-3/4	2.25	827125	ISA50	1-1/2	4 - 5	6.90	827133
ISA40	1-1/4	3 - 3-1/2	2.45	827126	ISA50	2	5-1/2 - 6	7.40	827134

ISA (NMTB) Shanks - 4" Extension Type



Draw Bar Threads:

- ISA40 5/8"-11 UNC
- ISA50 1"-8 UNC

Shank	Arbor Diameter (Inch)	For Shell End Mills (Inch)	Weight (lbs)	Code
ISA40	3/4	1-3/4 - 2	3.50	827135
ISA40	1	2-1/2 - 2-3/4	3.90	827136
ISA50	1	2-1/4 - 2-3/4	8.60	827137
ISA50	1-1/4	3 - 3-1/2	10.6	827138

R8 Shanks



- Made of alloy forged steel for long, durable service life
- Hardened to 56-60 HRC and ground to ensure maximum accuracy
- Shell end mill pilot total indicator runout <0.0004"

Shank	Arbor Diameter (Inch)	For Shell End Mills (Inch)	Code
R8	1/2	1-1/4 - 1-1/2	827140
R8	3/4	1-3/4 - 2	827141
R8	1	2-1/4 - 2-3/4	827142
R8	1-1/4	3 - 3-1/2	827143
R8	1-1/2	4 - 5	827144

Shell Mill Arbors

Straight Shanks

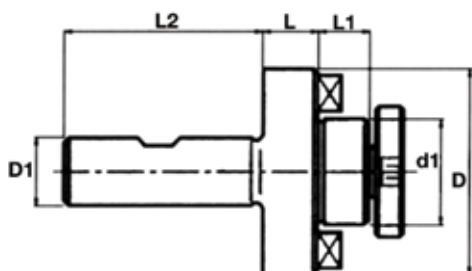

Shank Diameter (Inch)	d1 (Inch)	D (Inch)	L (Inch)	L1 (Inch)	L2 (Inch)	Code
3/4	0.75	1.75	0.703	0.67	1.75	827145
1	1.00	2.12	0.714	0.67	2.25	827146
1	1.25	2.50	0.845	0.67	2.25	827147

Morse Taper Shanks – Tanged



- Made of alloy forged steel for long, durable service life
- Hardened to 56-60 HRC and ground to ensure maximum accuracy
- Shell end mill pilot total indicator runout <0.0004"

Shank	Arbor Diameter (Inch)	For Shell End Mills (Inch)	Code	Shank	Arbor Diameter (Inch)	For Shell End Mills (Inch)	Code
MT4	3/4	1-3/4 – 2	827149	MT5	1	2-1/4 – 2-3/4	827153
MT4	1	2-1/4 – 2-3/4	827150	MT5	1-1/4	3 – 3-1/2	827154
MT4	1-1/4	3 – 3-1/2	827151	MT5	1-1/2	4 – 5	827155
MT4	1-1/2	4 – 5	827152				

Screws

For Shell Mill Arbors

- Socket head arbor screws are designed for all shell end mill arbors
- Made of alloy forged steel for long, durable service life



Thread	Arbor Diameter (Inch)	Code
1/4-28	1/2	827156
3/8-24	3/4	827157
5/8-18	1-1/4	827159

Face Mill Holders



- Holders have four mounting holes with 5/8-11 thread on a 4" bolt circle to hold 8" or larger face milling cutters
- Holders have 1" drive keys

Taper	Arbor Diameter (Inch)	Arbor Length (Inch)	Weight (lbs)	Code
ISA40	2	6.20	7.5	827162
ISA40	2-1/2	6.20	8.0	827163
ISA50	2	7.56	11.5	827164
ISA50	2-1/2	7.56	11.8	827165

Boring Head Adapters

For Boring Heads with Threaded Bores – CAT V-Flange Shanks

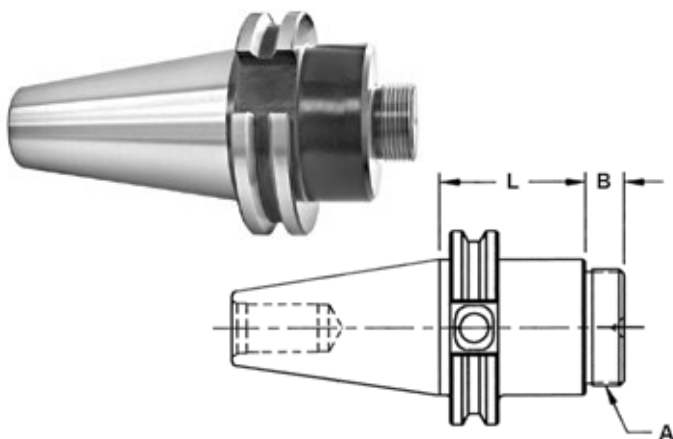

Taper	A Thread	B (Inch)	L (Inch)	Code
CAT40	7/8-20	0.44	1.50	827170
CAT50	1-1/2-18	0.44	1.75	302432

Centering Plug Arbors

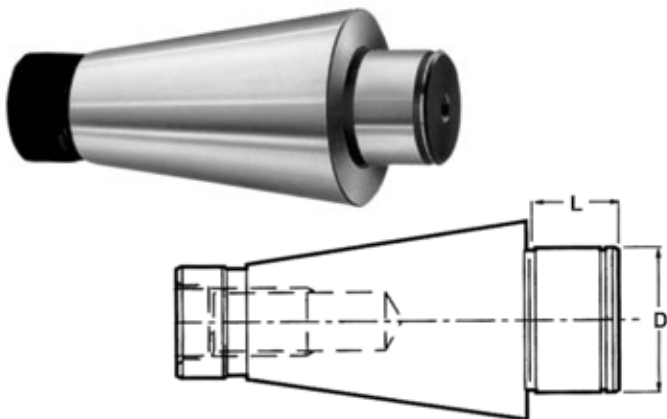

Taper	D (Inch)	L (Inch)	Code
ISA50	2	1-1/4	213530
ISA50	2-1/2	1-1/4	213532

Milling Machine Adapters

- Shanks are produced according to AT3 specifications
- Made of alloy forged steel for long, durable service life
- Hardened to 56-60 HRC and ground to ensure maximum accuracy
- Taper seat T.I.R. <0.0004"

For Changing from ISA (NMTB) Shank to a Smaller ISA (NMTB)



Shank	ISA Hole	Weight (lbs)	Code
ISA50	ISA30	4.52	827172
ISA50	ISA40	3.86	827173

For Changing from ISA (NMTB) Shank to MT Socket



Shank	Morse Taper Hole	Weight (lbs)	Draw Bar Thread	Code
ISA40	MT2	1.98	5/8-11	827176
ISA40	MT3	2.20	5/8-11	827177
ISA40	MT4	3.09	5/8-11	827178
ISA40	MT5	7.06	5/8-11	827179
ISA50	MT2	9.26	1-8	827180
ISA50	MT3	9.26	1-8	827181
ISA50	MT4	8.16	1-8	827182
ISA50	MT5	6.61	1-8	827183

For Changing from ISA (NMTB) Shank to MT Socket



- Open end type for threaded shank tools

Shank	Morse Taper Hole	Weight (lbs)	Code
ISA40	MT2	1.30	827186
ISA40	MT3	1.15	827187
ISA40	MT4	1.26	827188
ISA50	MT3	5.29	827189
ISA50	MT4	4.74	827190
ISA50	MT5	5.84	827191

For Changing from ISA (NMTB) Shank to R8 Socket

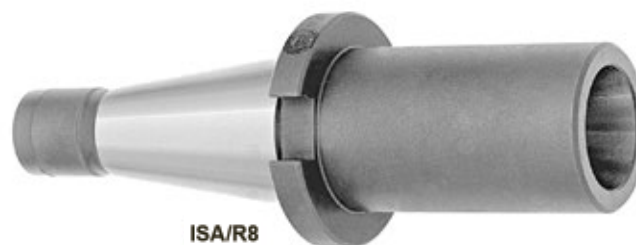

- Adapters are provided with the screw (Inside) to hold tools with 7/16-20 R8 shank
- To hold adapter in the spindle use draw bar with standard thread

Shank	Hole	Weight (lbs)	Draw Bar Thread	Code
ISA40	R8	3.26	5/8-11	827184

For Changing from R8 Shank to MT Socket



Shank	Morse Taper Hole	Weight (lbs)	Draw Bar Thread	Code
R8	MT2	0.71	7/16-20	827174
R8	MT3	0.86	7/16-20	827175

Quick Change Tooling Systems

Collet Chuck Quick Change Adapters
No. 30 & 40 Tapers



Capacity (Inch)	No. 30 Taper	No. 40 Taper
	Code	Code
1/8 - 1	302195	302196

End Mill Quick Change Adapters
No. 30 & 40 Tapers



Bore Diameter (Inch)	No. 30 Taper	No. 40 Taper
	Code	Code
3/8	302110	302120
1/2	302111	302121
5/8	302112	302122
3/4	302113	302123
7/8	302114	302124
1	302115	302125
1-1/4	302116	302126

NOTE: ISA30 ad ISA40 Quick-Change Adapters can be used on regular machine spindles. Standard ISA30 and ISA40 adapters cannot be used on these master shanks

Morse Taper Quick Change Adapters
No. 30 & 40 Tapers



Morse Taper	No. 30 Taper	No. 40 Taper
	Code	Code
MT1	302136	-
MT2	302137	302147
MT3	302138	302148
MT4	302139	302149

NOTE: ISA30 ad ISA40 Quick-Change Adapters can be used on regular machine spindles. Standard ISA30 and ISA40 adapters cannot be used on these master shanks

Jacobs Taper Quick Change Adapters
No. 30 & 40 Tapers



Jacobs Taper	No. 30 Taper	No. 40 Taper
	Code	Code
J2	302161	302171
J3	302162	302172
J33	302163	302173
J4	302164	302174
J6	302165	302175

Shell Mill Quick Change Adapters
No. 30 & 40 Tapers



Spigot Diameter (Inch)	No. 30 Taper	No. 40 Taper
	Code	Code
1/2	302180	302190
3/4	302181	302191
1	302182	302192
1-1/4	302183	302193
1-1/2	302184	302194

Quick Change Adapter Set
21 Pieces



- Set includes:**
- Master holder
 - Collet holder
 - 1" Shell
 - J6 Jacobs
 - MT3 Morse
 - 15 Collets 1/8-1"
 - Wrench

Master Shank	Code
40/40	302106

Stub Arbor Adapters

For Side Milling Cutters

Nut Type

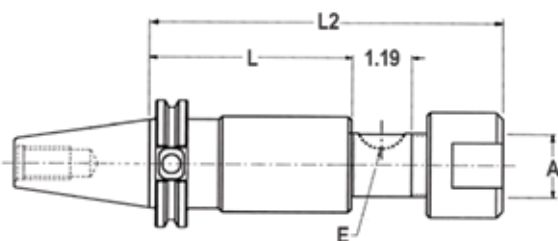

Screw Type

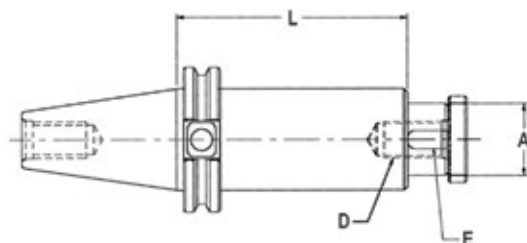

Taper	A Diameter (Inch)	L (Inch)	L2 (Inch)	E Key (Inch)	Code
CAT40	1.00	4.00	6.19	0.250	827685
CAT40	1.25	4.00	6.44	0.312	827686
CAT50	1.25	4.00	6.44	0.312	827688
CAT50	1.50	4.00	6.69	0.375	827689

Includes three spacers (1/8, 3/8, 3/4), key and nut.
Additional spacers available.

Taper	A Diameter (Inch)	L (Inch)	D Thread	E Key (Inch)	Code
CAT40	1.00	4.00	1/2-20	0.250	827690
CAT40	1.25	4.00	5/8-18	0.312	827691
CAT40	1.50	4.00	3/4-16	0.375	827692
CAT50	1.25	4.00	5/8-18	0.312	827693
CAT50	1.50	4.00	3/4-16	0.375	827694

Includes two spacers (1/4, 1/2), key and standard shell screw.

Weldon Shank

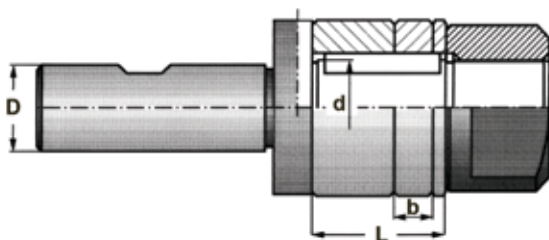

- Made of alloy forged steel for long, durable service life
- Hardened to 56-60 HRC and ground to ensure maximum accuracy
- Face is held perpendicular to center line within 0.0004"
- Pilot diameter is sized for precision fit with cutter and is keyed for positive drive
- Heavy duty locking LH nut and three arbor spacers are included

D Shank Diameter (Inch)	d Arbor Diameter (Inch)	L (Inch)	Code
3/4	3/4	1	827192
3/4	7/8	1	827193
3/4	1	1	827194
3/4	1-1/4	1	827195

Milling Machine Arbors

R8, ISA (NMTB) Styles A & B

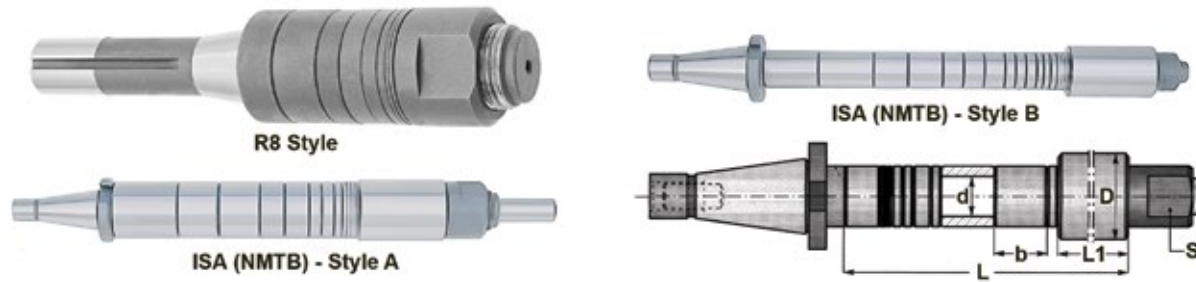

Complete with assorted spacers and running bushings as indicated

R8 Style

Taper	Diameter of Arbor (Inch)	Style	L Length (Inch)	D x L1 Running Bushings (Inch)	Running Bushing Quantity	Code
R8	1	B	2	-	-	203101
R8	1-1/4	B	2	-	-	203103

ISA (NMTB) - Style A (End Pilot 23/32" Dia. x 1-3/4" Long)

Taper	Diameter of Arbor (Inch)	Style	L Length (Inch)	D x L1 Running Bushings (Inch)	Running Bushing Quantity	Code
ISA30	7/8	A	10	1-5/8 x 2-5/8	1	203105
ISA30	1	A	10	1-5/8 x 2-5/8	1	203107
ISA40	7/8	A	10	-	-	203109
ISA40	7/8	A	16	1-7/8 x 3-1/8	1	203111
ISA40	1	A	12	-	-	203113
ISA40	1	A	16	1-7/8 x 3-1/8	1	203115
ISA40	1-1/4	A	12	-	-	203117
ISA40	1-1/4	A	16	1-7/8 x 3-1/8	1	203119
ISA50	1	A	12	-	-	203121
ISA50	1	A	18	2-1/8 x 3-3/4	1	203123
ISA50	1-1/4	A	12	-	-	203125
ISA50	1-1/4	A	18	2-1/8 x 3-3/4	1	203127

Milling Machine Arbors

R8, ISA (NMTB) Styles A & B (continued)

ISA (NMTB) - Style B

Taper	Diameter of Arbor (Inch)	Style	L Length (Inch)	D x L1 Running Bushings (Inch)	Running Bushing Quantity	Code
ISA40	1	B	3	-	-	203129
ISA40	1	B	14	1-7/8 x 3-1/8	1	203131
ISA40	1	B	20	1-7/8 x 3-1/8	1	203133
ISA40	1-1/4	B	3	-	-	203135
ISA40	1-1/4	B	14	1-7/8 x 3-1/8	1	203137
ISA40	1-1/4	B	20	1-7/8 x 3-1/8	1	203141
ISA40	1-1/2	B	20	2-1/8 x 3-3/4	1	203145
ISA50	1	B	3-1/2	-	-	203147
ISA50	1	B	15	2-1/8 x 3-3/4	1	203149
ISA50	1	B	18	2-1/8 x 3-3/4	2	203151
ISA50	1	B	24	2-1/8 x 3-3/4	2	203153
ISA50	1-1/4	B	3-1/2	-	-	203155
ISA50	1-1/4	B	15	2-1/8 x 3-3/4	1	203157
ISA50	1-1/4	B	18	2-1/8 x 3-3/4	2	203159
ISA50	1-1/4	B	24	2-1/8 x 3-3/4	2	203161
ISA50	1-1/4	B	30	2-1/8 x 3-3/4	2	203163
ISA50	1-1/2	B	3-1/2	-	-	203165
ISA50	1-1/2	B	18	2-1/8 x 3-3/4	2	203167
ISA50	1-1/2	B	24	2-3/4 x 4-1/4	2	203169
ISA50	1-1/2	B	30	2-3/4 x 4-1/4	2	203171
ISA50	1-1/2	B	36	2-3/4 x 4-1/4	2	203173
ISA50	2	B	24	-	-	203175
ISA50	2	B	30	2-3/4 x 4-1/4	2	203177
ISA50	2	B	36	-	-	203179
ISA50	2-1/2	B	36	3-3/8 x 4-1/2	2	203181

Nuts

- Hardened
- Ground left-hand thread and shoulder



For Arbor Diameter (Inch)	Thread Size	Code
7/8	7/8 - 14RH	203211
1	1 - 14RH	203213
1-1/4	1-1/4 - 12RH	203215
1-1/2	1-1/2 - 12RH	203217
2	2 - 12RH	203219
2-1/2	2-1/2 - 12RH	203220

Arbor Spacers

With Keyway



0.001" to 0.125" Thickness – 10 Piece Sets

Thickness (Inch)	Inside Diameter 7/8"	Inside Diameter 1"	Inside Diameter 1-1/4"	Inside Diameter 1-1/2"	Inside Diameter 2"
	Code	Code	Code	Code	Code
0.001	206400	206420	206440	206460	206480
0.0015	206401	206421	206441	206461	206481
0.002	206402	206422	206442	206462	206482
0.003	206403	206423	206443	206463	206483
0.004	206404	206424	206444	206464	206484
0.005	206405	206425	206445	206465	206485
0.006	206406	206426	206446	206466	206486
0.007	206407	206427	206447	206467	206487
0.008	206408	206428	206448	206468	206488
0.010	206409	206429	206449	206469	206489
0.012	206410	206430	206450	206470	206490
0.015	206411	206431	206451	206471	206491
0.020	206412	206432	206452	206472	206492
0.025	206413	206433	206453	206473	206493
0.031	206414	206434	206454	206474	206494
0.047	206415	206435	206455	206475	206495
0.062	206416	206436	206456	206476	206496
0.093	206417	206437	206457	206477	206497
0.125	206418	206438	206458	206478	206498
Assorted 19 pcs.	206419	206439	206459	206479	206499

MILLING
TOOLS

Tool Clamping Fixtures

Multiple Use for Tool Shank ISO – DIN 69871 – CAT & BT-MAS

- Easy access for combined assembly of cutting tool and pull stud
- Head fixture can be set in five positions: vertical, horizontal and 45° (left and right)
- Efficiently designed for maximum protection of tool holder
- Enables strong gripping power of cutting tools
- Compact design - can be mounted on work table or tool cart



Taper	Code
Tool clamp #40 rotary	827695
Tool clamp #50 rotary	827696
Tool clamp #40 fixed	827697
Tool clamp #50 fixed	827698

Tool Trolleys & Accessories

Heavy Duty

Tool Trolley



Tray with #40 Inserts



Code
214200

Individual Inserts



Description	Code
With #40 inserts (28 pcs.)	214140
With #50 inserts (20 pcs.)	214150

Insert	Code
#40	214240
#50	214250
HSK50	214260
HSK63	214261

Universal Machining Chucks

4-Jaw – Vertical

- Parts are gripped firmly by the formed jaws, ensuring high precision (deviation within 0.03mm)
- Large workpieces can be held tight with the low profile vise body
- Handle is set on the face and does not interfere with the table. A number of chucks can be used together
- Soft jaws available

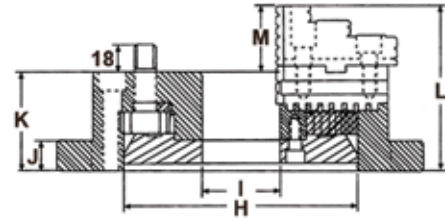
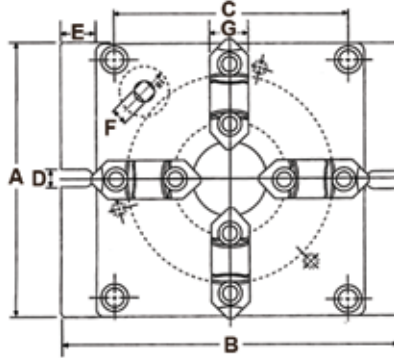
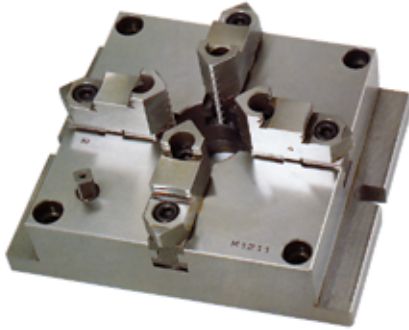

A (mm)	B (mm)	C (mm)	D (mm)	E (mm)	F (mm)	G (mm)	H (mm)	I (mm)	J (mm)	K (mm)	L (mm)	M (mm)	Code
165	215	143	13	25	12	26	130	40	18	57	97	40	302706
250	310	218	18	60	-	32	200	70	-	-	-	-	302710

Universal Tilting Rotary Table

- Accurate and solidly designed table for use on milling, boring and other machine tools
- Allows indexing, facing and other work to be carried out rapidly with extreme precision
- Tilting range 90° from horizontal to vertical position, one rotation of handle equals 3°, five minutes tilting reading
- 10 second Vernier scale
- Table dial one minute graduations
- Fast indexing: location pin in 24 holes (15° ensures accurate spacing)
- Minimum set-up time
- Rugged construction

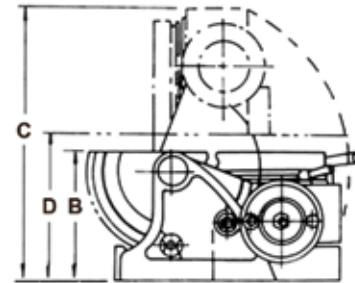
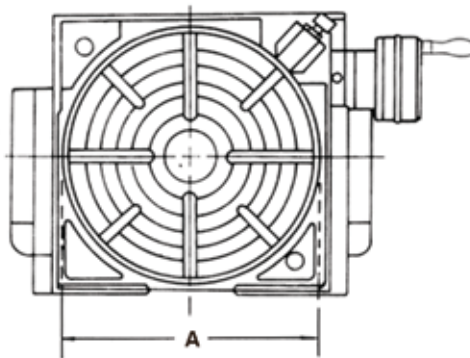
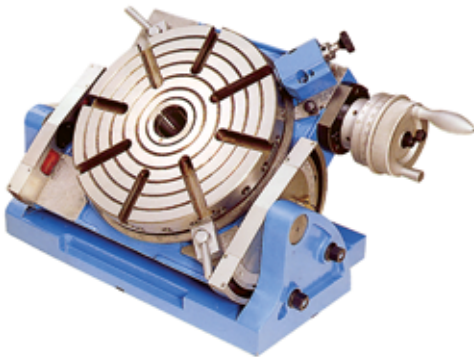

A Table Diameter (mm)	B Table Height (Horizontal) (mm)	C Overall Table Height (Vertical) (mm)	Center Hole	D Center Height (Vertical) (mm)	Direct Indexing	Gear Ratio	Approximate Weight (kg)	Code
300	185	370	MT3	208	24-div.	90:1	102	242130

Accessories sold separately

Tail Stock

Code
242127

Dividing Plates

Code
242132

5C Fixtures & Indexes

5C Collet Index – Horizontal/Vertical



- Index plate has screws in all 24 index holes for easy masking of holes not needed for a specific job
- Ratchet device on front of spindle permits fast rotation of spindle nose
- Collet closer lever has a leverage ratio of 100 to 1
- Hardened and ground index plate is designed for long life and extreme accuracy
- Index pin has a spring for quick positive location in index plate holes
- Spindle has taper seat in body frame

Base Dimensions (Inch)	Height (Inch)	Code
4 x 5	7	251215

5C Angle Collet Fixture



- All moving parts hardened, ground and honed
- Cam lever opens and closes collets
- Collets can be changed easily and quickly
- For drilling, milling, grinding, tapping assembly, etc.
- Can be mounted and used horizontally and vertically
- Collet retains positive relation to base - can be adjusted without disturbing set-up
- Does not move up or down

Base Dimensions (Inch)	Height (Inch)	Code
5 x 3-5/8	3-3/4	245203

5C Spin Index



- Single indexing from 0° to 360° by increments of ten degrees using the indexing plate only
- Indexing from 0° to 360° by increments of one degree using the indexing plate in conjunction with the vernier holes
- Dividing into 2, 3, 4, 6, 9, 12, 18 and 36 parts using the indexing plate only
- Used for grinding flutes on cutting tools
- If disengaged the spindle rotates freely and it has a linear travel up to 2-1/16"

Code
245205

Expanding Arbor Set

8-Piece Set – Straight Shank



Diameter (Inch)	Length (Inch)	Expansion (Inch)	Code
1-1/4	4	0.005	302460
1	4	0.005	
7/8	4	0.005	
3/4	4	0.005	
5/8	3	0.005	
1/2	3	0.005	
3/8	3	0.005	
1/4	3	0.005	

5C Expanding Collets



- Body is precision ground and hardened
- Soft head can be machined to accommodate work piece

Machining Range (Inch)	Code
0.250 – 0.468	302455
0.437 – 0.800	302456
0.570 – 1.437	302457
0.750 – 1.937	302458
0.250 – 1.937 (Set of 4)	302459



5C Collet Blocks

Description	Outside Dimensions (Inch)	Code
Square Block	1-3/4 x 1-3/4 x 2-3/4	302481
Hexagonal Block	1-3/4 HEX x 2-3/4	302482
Quick-Action Lever	-	302483
Complete Set	-	302484

Morse Taper Collets

Morse Taper Outside – Fractional Inside



Draw Bar Threads
• 3/8" – 16

Size (Inch)	MT2	MT3
	Code	Code
1/8	221300	221307
3/16	221301	221308
1/4	221302	221309
5/16	221303	221310
3/8	221304	221311
7/16	221305	221312

Size (Inch)	MT2	MT3
	Code	Code
1/2	221306	221313
9/16	-	221314
5/8	-	221315
11/16	-	221316
3/4	-	221317

Round Collets

5C, R8, Brown & Sharp 21 – Inch & Metric



Inch

Diameter (Inch)	5C	R8	B&S 21	Diameter (Inch)	5C	R8	B&S 21
	Code	Code	Code		Code	Code	Code
1/32	221101	221201	170311	9/16	221118	221218	170345
1/16	221102	221202	170313	19/32	221119	221219	170347
3/32	221103	221203	170315	5/8	221120	221220	170349
1/8	221104	221204	170317	21/32	221121	221221	170351
5/32	221105	221205	170319	11/16	221122	221222	170353
3/16	221106	221206	170321	23/32	221123	221223	170355
7/32	221107	221207	170323	3/4	221124	221224	170357
1/4	221108	221208	170325	25/32	221125	221225	170359
9/32	221109	221209	170327	13/16	221126	221226	170361
5/16	221110	221210	170329	27/32	221127	221227	170363
11/32	221111	221211	170331	7/8	221128	221228	170365
3/8	221112	221212	170333	29/32	221129	-	170367
13/32	221113	221213	170335	15/16	221130	-	170369
7/16	221114	221214	170337	31/32	221131	-	170371
15/32	221115	221215	170339	1	221132	-	170373
1/2	221116	221216	170341	1-1/16	221133	-	170375
17/32	221117	221217	170343	1-1/32	221134	-	-

Metric

Diameter (mm)	5C	R8	Diameter (mm)	5C	R8	Diameter (mm)	5C	R8
	Code	Code		Code	Code		Code	Code
1	-	221251	9	221279	221259	17	221287	221267
2	-	221252	10	221280	221260	18	221288	221268
3	221273	221253	11	221281	221261	19	221289	221269
4	221274	221254	12	221282	221262	20	221290	221270
5	221275	221255	13	221283	221263	21	221291	221271
6	221276	221256	14	221284	221264	22	221292	221272
7	221277	221257	15	221285	221265	23	221293	-
8	221278	221258	16	221286	221266	24	221294	-
						25	221295	-

Square & Hexagonal Collets

5C – Inch



Diameter (Inch)	5C Square Code	5C Hexagonal Code	Diameter (Inch)	5C Square Code	5C Hexagonal Code	Diameter (Inch)	5C Square Code	5C Hexagonal Code
3/32	221401	221431	11/32	221409	221439	19/32	221417	221447
1/8	221402	221432	3/8	221410	221440	5/8	221418	221448
5/32	221403	221433	13/32	221411	221441	21/32	221419	221449
3/16	221404	221434	7/16	221412	221442	11/16	221420	221450
7/32	221405	221435	15/32	221413	221443	23/32	221421	221451
1/4	221406	221436	1/2	221414	221444	3/4	221422	221452
9/32	221407	221437	17/32	221415	221445	25/32	–	221453
5/16	221408	221438	9/16	221416	221446	13/16	–	221454
						27/32	–	221455
						7/8	–	221456

Floating Holders



- Used to compensate for misalignment between tool and work piece, both being held rigidly in machinery operations
- Recommended for both reaming and tapping

TYPE 081 with a parallel float of 0.014" to 0.016" and with an angular float
 TYPE 082 where due to the vulcanized rubber joint, an angular flexibility is achieved

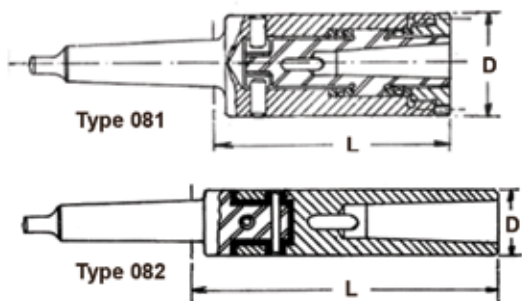

Morse Taper Shank	Morse Taper Bore	D (Inch)	L (Inch)	Type 081	Type 082
				Code	Code
1	1	1.603	3.18	185111	185211
1	2	1.730	4.72	185112	–
2	1	1.570	4.10	185121	185221
2	2	1.730	4.72	185122	185222
2	3	2.000	5.43	185123	185223
3	2	1.730	4.72	185132	185232
3	3	2.000	5.43	185133	185233
3	4	1.730	6.46	185134	185234
4	3	2.000	5.43	185143	185243
4	4	2.250	6.46	185144	185244
4	5	2.720	8.00	185145	–
5	4	2.250	6.46	185154	–
5	5	2.720	8.00	185155	–

Emergency Collets



- Emergency collets are soft to accommodate boring of special diameters within the collet range

Style	Code
5C	221140
R8	221240

5C Step Collets



- 5C step collets are soft to accommodate boring of special diameters above the collet range

Diameter (Inch)	Code
2	221142
3	221143
4	221144
5	221145

5C Adjustable Collet Stop



Code
826739

Horizontal Milling Attachments

R8 & ISA40

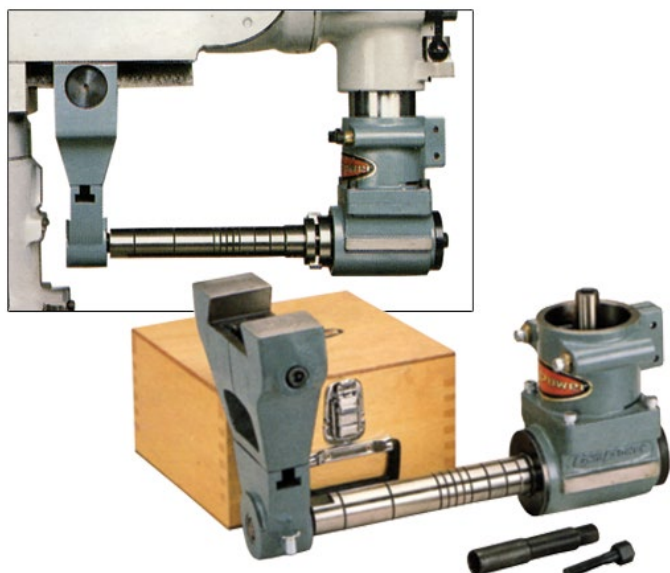

Available only as a set

Spindle	Code
R8	264101
*ISA40	264103

*Please specify quill diameter and dovetail width

Right Angle Head

Taper	Suitable Milling Head Quill Diameter
R8	85.725 mm – 86 mm = 3.38"
NT40	85.725 mm – 115 mm = 3.38" – 4.53"

Horizontal Milling Arbor Support

Taper	Suitable Milling Head Quill Diameter
R8	85.725 mm – 86 mm = 3.38"
NT40	85.725 mm – 115 mm = 3.38" – 4.53"

Right Angle Heads

R8 & ISA40

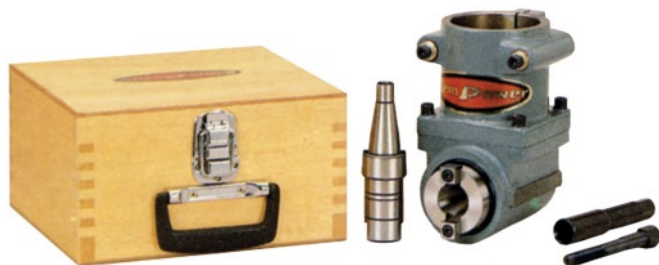

- For horizontal cutting on vertical machines
- Rigid construction

Spindle Taper	Tool Taper	Quill Diameter (Inch)	Code
R8	R8	3.375/3.385	264105
*ISA40	R8	*3.375/4.520	264107

*Please specify quill diameter and dovetail width

Tail Stock

Rigid & Precision Designed



Set includes:

- Precision dead center with 0.0002" T.I.R.
- 2 locating keys
- 2 mounting bolts with T-nuts

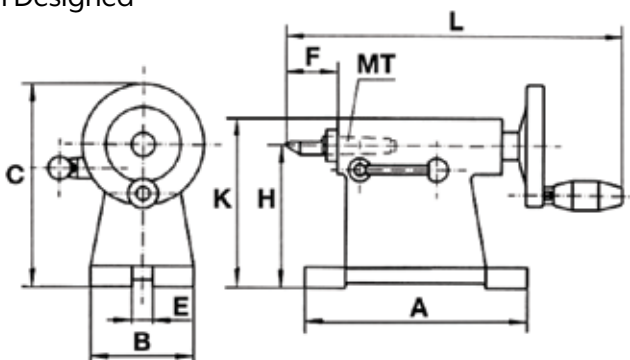

H + 0002" (Inch)	K (Inch)	B (Inch)	A (Inch)	F Minimum (Inch)	F Maximum (Inch)	E Key Size (Inch)	Morse Taper	Weight (lbs)	Code
3.937	5.51	3.15	7.68	1.30	2.48	0.55	MT2	14	277111
4.921	7.01	3.54	7.68	1.54	2.72	0.55	MT2	16	277112
6.299	8.39	4.53	9.84	1.89	3.35	0.71	MT3	28	277113
9.843	11.93	5.91	11.02	2.34	3.92	0.71	MT4	51	277114

Arbor Presses

Standard & Economy

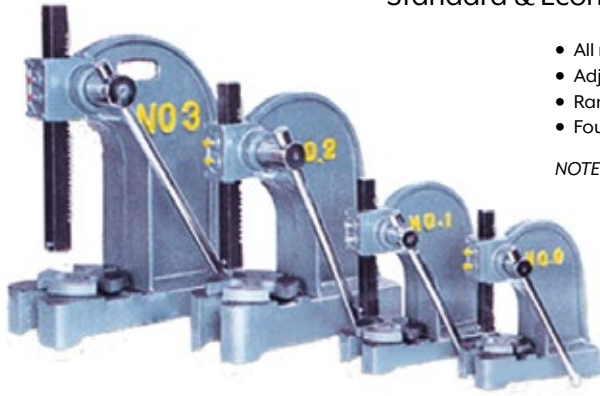

- All main parts made of ductile cast iron
- Adjustable handle for convenient positioning
- Ram finite control with smooth gears
- Four 90 degree equally divided slotted round table

NOTE: Not recommended for broaching

Standard

Base Dimensions (Inch)	Press Height (Inch)	Press Tons	Maximum Work Height (Inch)	Swing (Inch)	Table Diameter (Inch)	Ram Dimensions (Inch)	Code
9.25 x 4.02	10	0.5	4.5	3.3	3.5	0.75 x 0.75	680105
10.63 x 5	12.6	1	5.5	4.1	4.3	1 x 1	680110
15.75 x 6.69	17.5	2	8.5	5.3	6.7	1.25 x 1.25	680115
18.5 x 7.87	22.4	3	12.5	5.3	6.7	1.5 x 1.5	680120
26.77 x 9.84	31.5	5	18.5	9.6	9.8	2 x 2	680130

Economy

Base Dimensions (Inch)	Press Height (Inch)	Press Tons	Maximum Work Height (Inch)	Largest Arbor (Inch)	Table Diameter (Inch)	Ram Dimensions (Inch)	Ram Length (Inch)	Press Distance Ram/Column (Inch)	Code
4 x 9.5	10	0.5	4.5	1.12	3.35	0.75 x 0.75	7.5	3.37	218002
5 x 11	12	1	5.25	1.37	3.54	1 x 1	9.5	4.25	218003
6.75 x 17	17	2	8.5	1.75	6.5	1.25 x 1.25	14	6	218004
8 x 8	21.5	3	12.62	2.5	7.48	1.5 x 1.5	18	6	218005

Power Table Feed



- Smooth running with high torque maximum of 650 in/lb
- New and stronger design assures long trouble-free life
- Electrical and mechanical parts are designed for easy maintenance

Specifications:

Voltage: 110V, 50/60Hz
 Speed Range: 4-160 RPM
 Rapid Speed: 200 RPM
 Max. Torque: 650 lbs/in
 Dimensions: 290 x 200 x 320mm
 Weight: 6.3kg

Code

302235

Replacement Circuit Board

Code

302236

LED Machine Lamps

Coolant Proof – IP20 | JHL-35R Series

- 3W LED lamp (3 x 1W LEDs)
- Coolant proof – IP20
- Various lighting angles: 30°, 45°, 60°
- Impact resistant clear lens
- Supplied with 1.8 meter power connection cord
- Engineered double plastic shade design allows fast heat dissipation

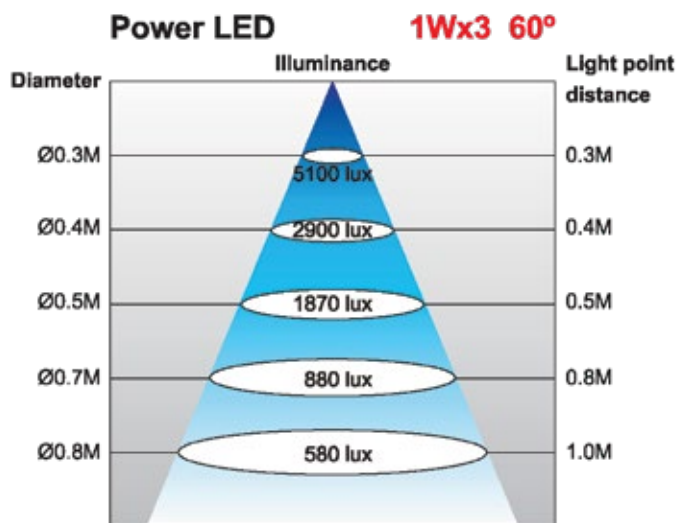
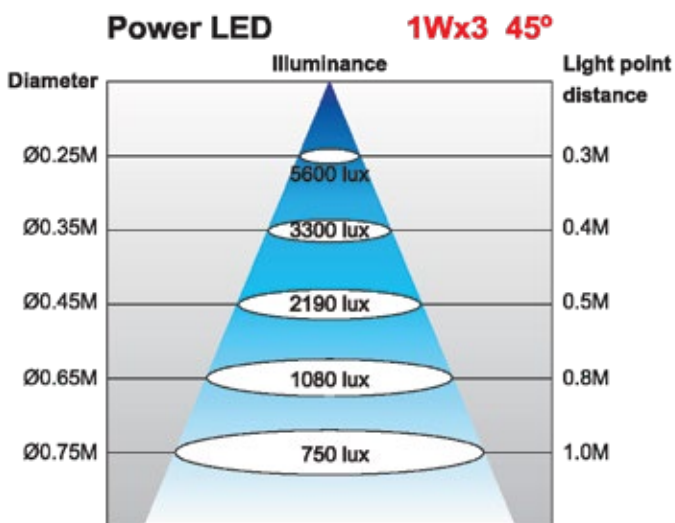
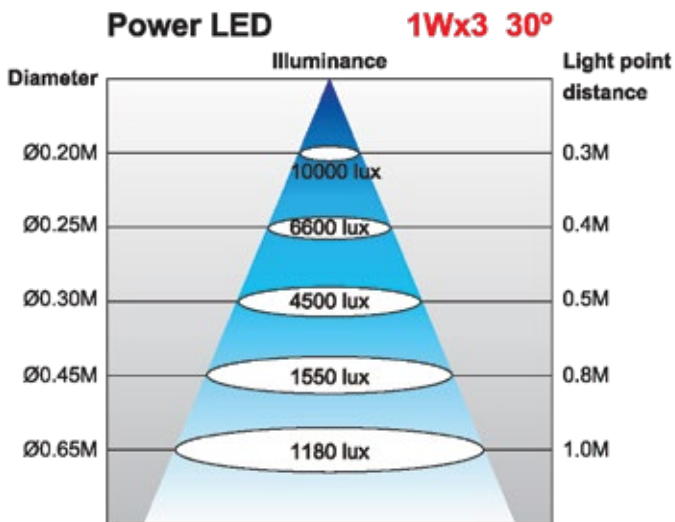

Built in LED Driver with Coil Transformer

- Low voltage power AC24V or DC24V

- High voltage power 100V-260V with plug

Model	Reach (Inch)	Code
JHL-35RS	Short	302304
JHL-35RM	18 (9+9)	302305
JHL-35RL	32 (16+16)	302306

Model	Reach (Inch)	Code
JHL-35RTS	Short	302307
JHL-35RTM	18 (9+9)	302308
JHL-35RTL	32 (16+16)	302309

LED Machine Lamps

Coolant Proof – IP65 | JWL-55 Series

- 12W LED lamp (6 x 2W LEDs)
- Coolant proof – IP65
- Standard light beam angle: 60°
- Impact resistant clear lens
- Supplied with 1.8 meter power connection cord
- Expected lamp life of 40,000 hours
- Handle on head allows easy positioning
- Working temperature range: -30°C to +60°C

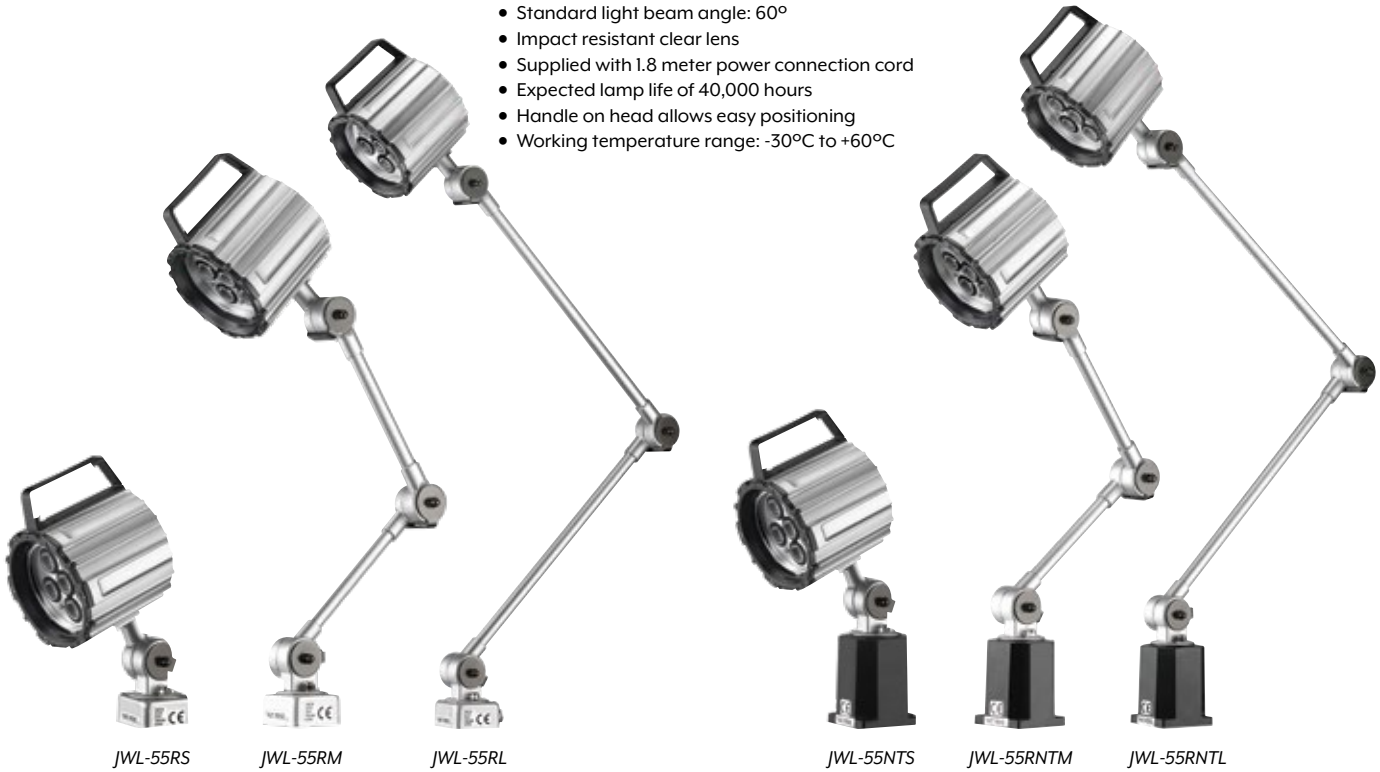

JWL-55RS

JWL-55RM

JWL-55RL

JWL-55NTS

JWL-55RNTM

JWL-55RNTL

MACHINE ACCESSORIES

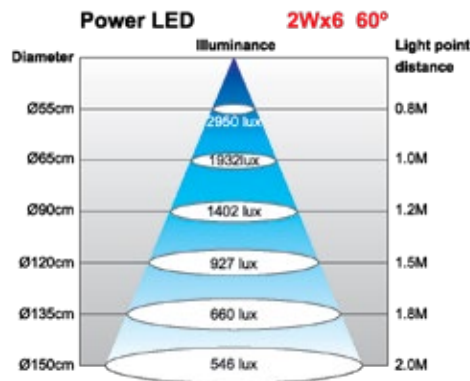
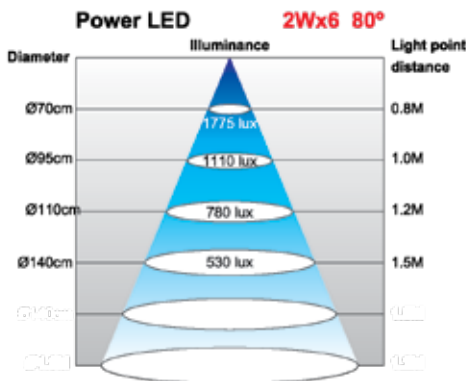

LED Driver in Lamp Head

- Low voltage power AC24V or DC24V

Model	Reach (Inch)	Code
JWL-55RS	Short	302995
JWL-55RM	18 (9+9)	302996
JWL-55RL	32 (16+16)	302997

LED Driver in Base

- High voltage power 100V-260V with plug

Model	Reach (Inch)	Code
JWL-55NTS	Short	302992
JWL-55RNTM	18 (9+9)	302993
JWL-55RNTL	32 (16+16)	302994

LED Replacement Assembly

Description	Code
6 LEDs with reflector in one unit	302998



Quill Stop

For Bridgeport Type Mills

- Quick action clip
- Clips on quill easily for rapid depth setting
- Top or bottom positioning
- 0.020" fine adjustment
- Easily removable when not being used

Code
302233

Cross-Slide Tables

Inch – Double Axis – Fixed Base

- General tolerance $\pm 0.03"$

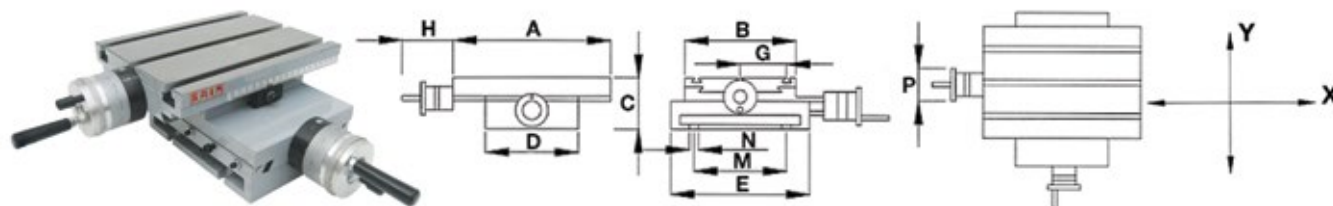

Model	A (mm)	B (mm)	C (mm)	D (mm)	E (mm)	M (mm)	N (mm)	G (mm)	F (mm)	H (mm)	P (mm)	No. of Slots	Stroke X Axis (mm)	Stroke Y Axis (mm)	Weight (lbs)	Code
340 XY	340	190	108	155	195	100	9	72	12	127	62	3	100 + 100	70 + 70	60	266524
430 XY	430	240	120	190	260	140	11	72	12	127	70	3	140 + 140	90 + 90	100	266526
600 XY	600	240	120	190	260	140	11	72	12	127	70	3	200 + 200	90 + 90	132	266528
800 XY	800	280	144	240	290	184	14	72	12	127	80	3	250 + 250	125 + 125	200	266530

Dead Blow Hammers

Steel – Polyurethane Coated Thermoplastic Rubber



- One piece steel construction with steel shot
- Polyurethane coated thermoplastic rubber – no exposed metal on head or handle
- Textured non-slip handle with flanged end for a comfortable and safe grip
- Hammer hardness: 90A-95A

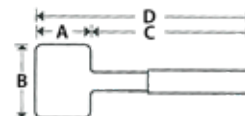

Model	A (mm)	B (mm)	C (mm)	D (mm)	Weight (g)	Weight (oz)	Code
VHM-38	38	100	249	287	490	18	284560
VHM-46	46	100	260	306	690	24	284561
VHM-50	50	110	290	340	930	33	284562
VHM-56	56	120	297	353	1,160	41	284563
VHM-60	60	130	308	368	1,370	49	284564

Precision Milling Machine Vises



FCD-60 Ductile Iron

6" x 7.5" Opening



6" x 8.9" Opening



8" x 10" Opening



Dimensions (Inch)			
A	17.01	17.20	21.85
B	9.25	8.74	11.61
C	5.94	5.94	8.11
D	18.74	18.94	24.21
E	4.37	4.37	5.28
F	1.73	1.73	2.36
G	4.25	3.56	4.95
H	2.88	2.88	3.31
I	2.05	2.05	2.28
J	0.71	0.71	0.95
K	0.69	0.69	0.81
L	4.84	4.84	6.18
M	1.75	1.75	2.20
N	0.75	0.75	0.75
O	7.56	8.90	10.43
T	0.94	0.94	1.26
U	3.87	3.87	4.72
Weight (lbs)	79.37	80.03	150.36
Code	277064	277065	277066

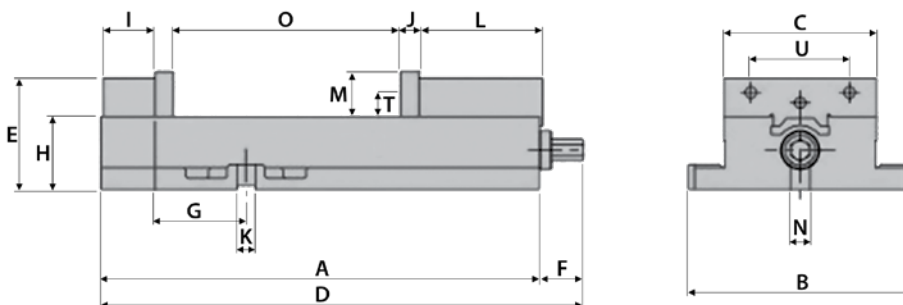

Bed Height from Machine Table	Parallelism of Vise Base to Vise Bed	Vertical of Fixed Jaw to Vise Bed	Clamping Force (lbs)	Code
2.875" ±0.001"			6,700	277064
2.875" ±0.001"	0.0006"	0.0005"	7,900	277065
3.260" ±0.001"			11,600	277066

Toolmaker's Vises



321482 and 321483



321486



- Squareness and parallelism guaranteed within 0.0002" on sides and bottom
- Made of hardened steel and precision ground
- Horizontal and vertical v-grooves in movable jaw
- The "no rise" jaw construction exerts continual downward pressure on the jaw, preventing the jaw from rising which is a common problem on most vises

Jaw Width (Inch)	Jaw Opening (Inch)	Jaw Depth (Inch)	Overall Length (Inch)	Overall Height (Inch)	Code
2	3-1/8	1	5-1/2	2	321482
3	3-3/4	1-3/8	7	2-1/2	321483
3	4	1-3/8	7-1/4	2-1/2	321486

Jaw Width (Inch)	Jaw Opening (Inch)	Jaw Depth (Inch)	Vise Length (Inch)	Code
2	2-1/2	1	6	321488
2-1/2	3-1/2	1-1/4	7-1/2	321489
3	3-1/2	1-1/4	8-1/2	321490

Double CNC Precision Vises

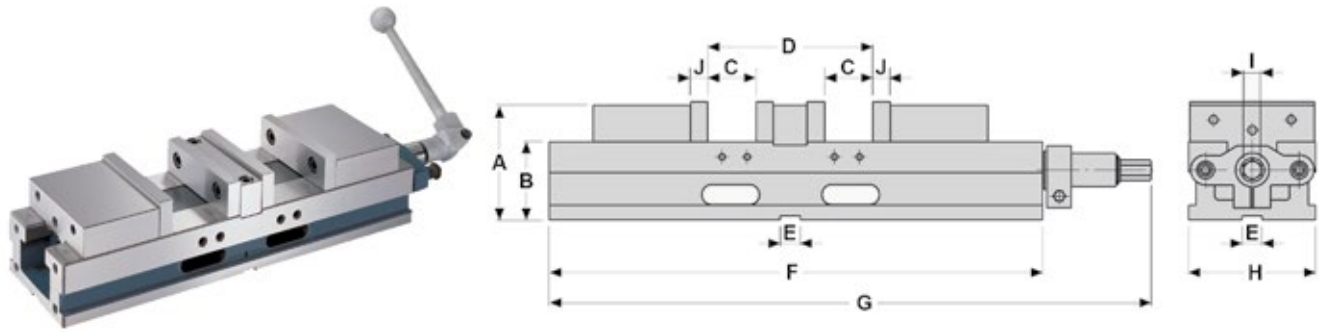

- Material: FCD 55 ductile iron; Hardness: 50 HRC
- Increases the workholding capacity of CNC machining centers by holding two pieces of different sizes (max. opening difference 70mm)
- Compact design allows several vises to be fitted to the machine table
- Center jaw may be removed to hold larger workpieces
- When center jaw is removed the vise is self-centering
- Special spring device allows an extra range of up to 5mm in workpiece size, enabling quick positioning and clamping

STANDARD ACCESSORIES: 2 alignment wedges, 4 clamps

Model	A (mm)	B (mm)	C (mm)	D (mm)	E (mm)	F (mm)	G (mm)	H (mm)	I (mm)	J (mm)	Weight (kg)	Code
HDL-4	92	63 ±0.01	74	200	18	395	480	104	14	14	20	277008
HDL-6	118	80 ±0.01	100	270	18	517	615	154	19	18	46	277010

Super Open Quick Action Vise

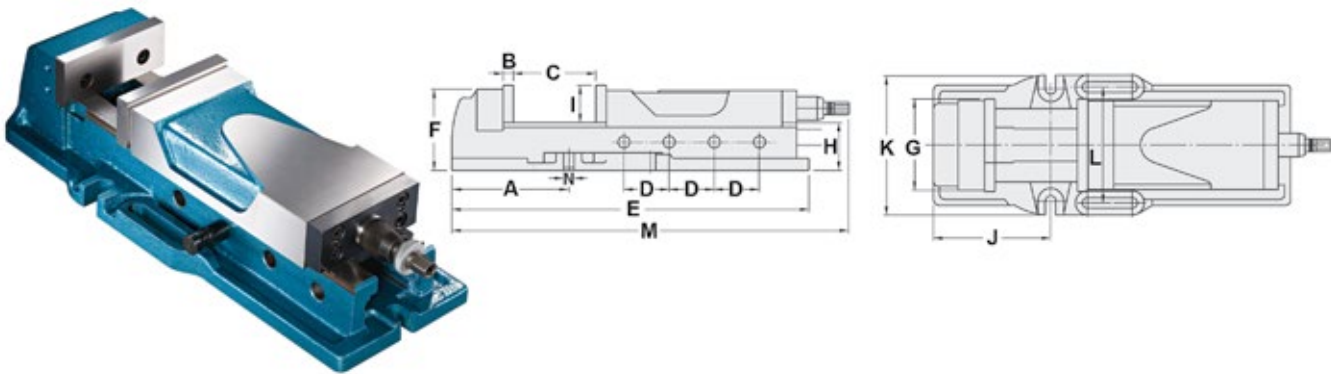

- Material: FCD 60 ductile iron; Hardness: 50 HRC
- Patented Multi-Power System provides extremely high clamping force of 0-4500 kg
- Consistent clamping pressure
- Eliminates all leakage and maintenance problems associated with hydraulic vises
- More compact than hydraulic vises
- Body has one-piece construction for high rigidity and precision
- Angle lock mechanism provides downward pressure on jaw to ensure parallel clamping force
- Both surfaces of slideways are heat treated for durability
- Large opening capacity up to 300mm

Model	A (mm)	B (mm)	C (mm)	D (mm)	E (mm)	F (mm)	G (mm)	H (mm)	I (mm)	J (mm)	K (mm)	L (mm)	M (mm)	N (mm)	Weight (kg)	Code
HSAC-160	200	15	300	77	610	139	158	82	63	200	240	190	915	18	58	277011



Modular System Vises

Standard Series

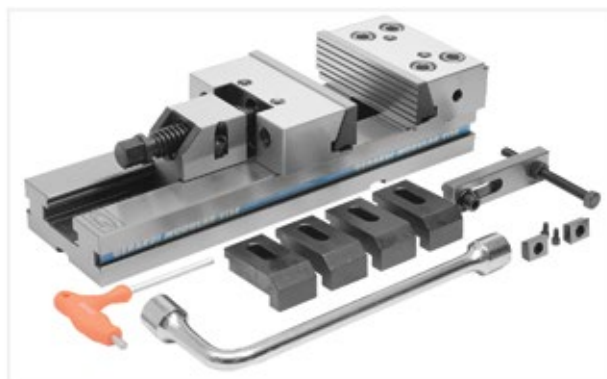
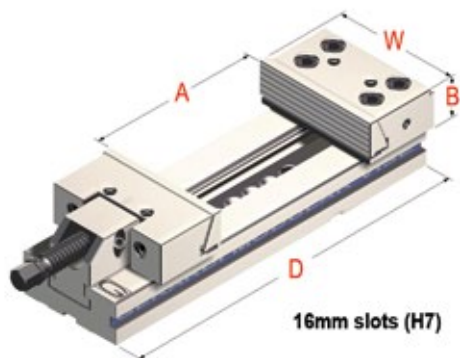

- Modular design for easy interchangeability
- Hardened and ground steel
- Manufactured under rigid quality control
- Fixed vise with guided movable jaw
- High alloyed quality resistance steel, case hardened (HRC 60 ±2)
- Unlimited clamping range
- Supplied with one workstop, one pair of positioning key nuts, two pair of clamps, one box wrench and one "T" wrench

Type	W Jaw Width (Inch)	A Jaw Opening (Inch)	B Jaw Height (Inch)	D Base Length (Inch)	Approximate Weight (kg/lbs)	Code
2	5	5.9	1.5	13.5	13/28	278002
3	6	7.8	1.9	16.5	26/56	278004
3	6	11.1	1.9	20.7	29/64	278006

Drill Press Vises

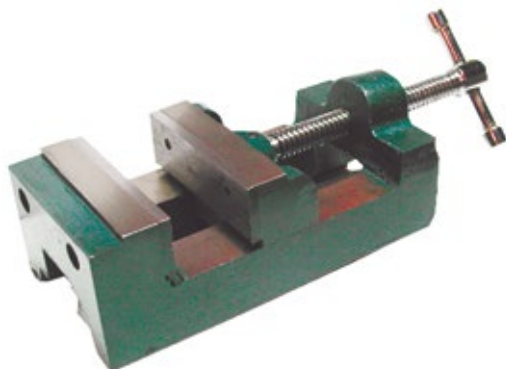

Jaw Width (Inch)	Jaw Opening (Inch)	Jaw Depth (Inch)	Weight (lbs)	Code
2-1/2	2-1/4	1-1/4	12	302276
3-1/2	3	1-5/16	18	302277

Jaw Width (Inch)	Jaw Opening (Inch)	Jaw Depth (Inch)	Weight (kg/lbs)	Code
3-1/8	2-3/4	1-1/16	3/6.61	327490
4-1/8	3-3/4	1-3/16	4/8.82	327491
5	4-5/8	1-3/8	6/13.23	327492
6	5-5/8	1-3/8	8/17.64	327493

Precision Drill Press Vises

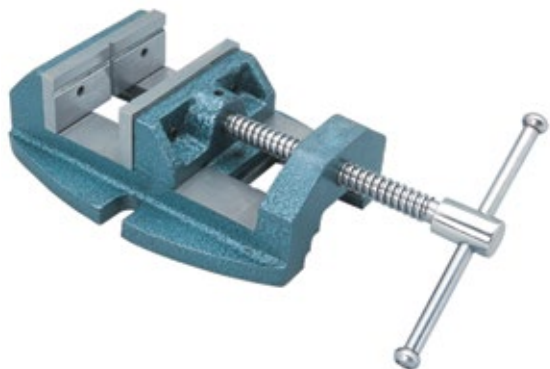

- Close grained cast iron construction
- Ground vise bed
- Hardened v-grooved tool steel jaws
- Knurled nut type grip makes it convenient to close and open the vise on the drill table

Jaw Width (Inch)	Jaw Opening (Inch)	Weight (lbs)	Code
3	3	6	416263
4	4	12	416264
5	5	23	416265

KR Precision Vise

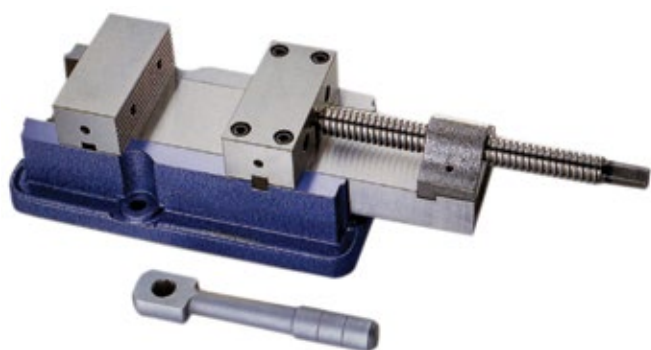

- Stationary front jaw
- Back jaw moves along with the slide reducing the tendency of deflection and prevents the work piece from lifting
- Cast body, steel jaws
- Hardened throughout and ground on all sliding and contacting surfaces
- Ideal for CNC applications

Vise

Jaw Width (Inch)	Jaw Opening (Inch)	Jaw Depth (Inch)	Code
6	8	1-7/8	301436

Swivel Base Only

Code
301437

Fixed Base Bench Vises



- Graded cast iron body
- Hardened and ground alloy steel jaws
- Perfectly aligned vise for smooth functioning

Jaw Width (Inch)	Jaw Opening (Inch)	Weight (lbs)	Code
3	3-3/8	11	416250
4	4	19	416251
5	5	28	416252
6	6	43	416253

Angle Vise



- Ideal for drilling, tapping or reaming applications
- 3 inch vise securely mounted on an angle base permitting quick 0-90° vertical angle adjustments
- Graduated settings for easy vertical angle readings
- Movable jaw plate is smooth, stationary jaw plate is grooved with a cross - patterned 90° V

Jaw Width (Inch)	Code
3	302275

U-Type Angle Vises



Jaw Width (Inch)	Code
3	318481
4	318482

Quick Action Vises

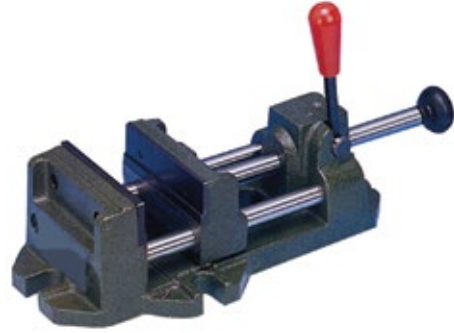

Jaw Width (Inch)	Jaw Opening (Inch)	Weight (lbs)	Code
3	2-3/4	10	312436
4	4-1/4	18	312437
6	6	29	312438
8	8	44	312439

Universal Dividing Head

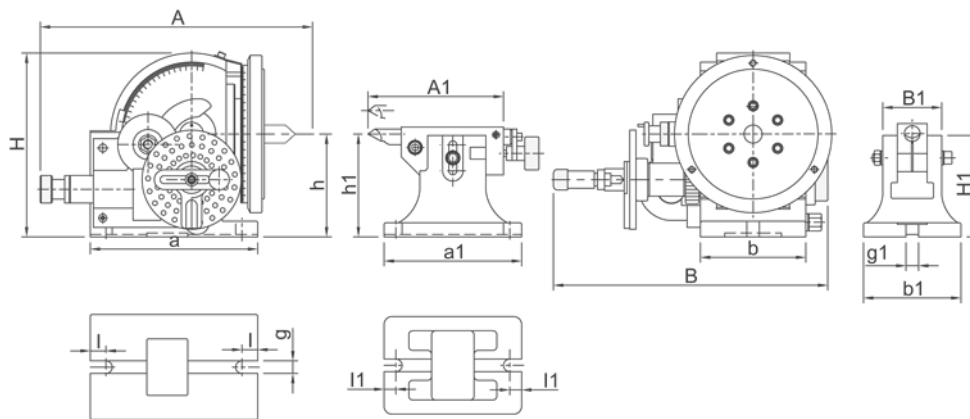
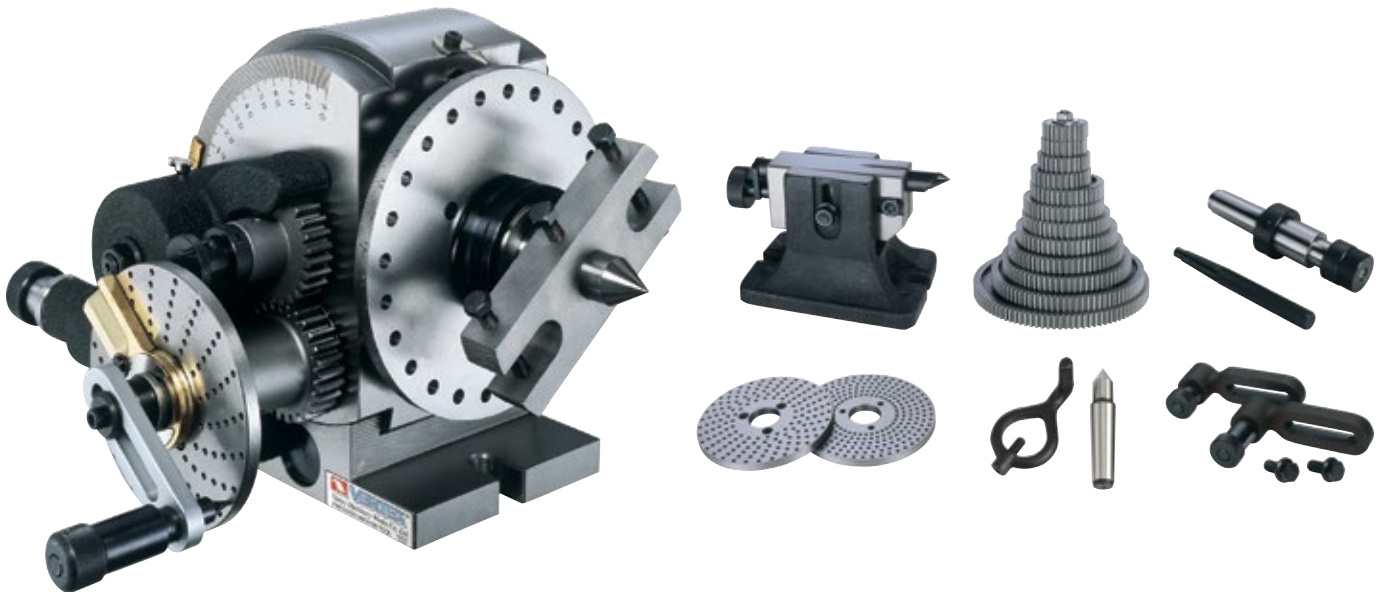

Tail Stock

Model	A1 (mm)	B1 (mm)	H1 (mm)	l1 (mm)	a1 (mm)	b1 (mm)	h1 (mm)	g1	Weight (kg)
BS-2	135-175	75	130	15	175	125	120-145	16	10

Standard Accessories: Dividing Plate A, B, C. Number of Holes of Dividing Plate (Worm Gear Reduction Ratio 40:1)

Number of Holes	Plate A	15	16	17	18	19	20
	Plate B	21	23	27	29	31	33
	Plate C	37	39	41	43	47	49

- Can be used for either direct or indirect dividing
- Three additional indexing plates included to provide the ability of indirect dividing of all divisions from 2 to 50 and also most common divisions up to 380
- Hardened and ground spindle is rigidly held in a taper roller bearing
- Hardened and ground worm
- Swivel head can be locked on any angle from 10° below horizontal to 90° vertical - precision fitting to base allows smooth rotation
- Threaded spindle nose and 24 hole dividing plate with easy conversion to fast direct indexing on numbers 2, 3, 4, 6, 8, 12 and 24

A (mm)	B (mm)	H (mm)	l (mm)	a (mm)	b (mm)	g (mm)	h (mm)	Center Taper (mm)	Spindle Through Hole (mm)	Code
359	340	235	20	212	135	16	134	MT4	25	277075

Semi-Universal Dividing Heads

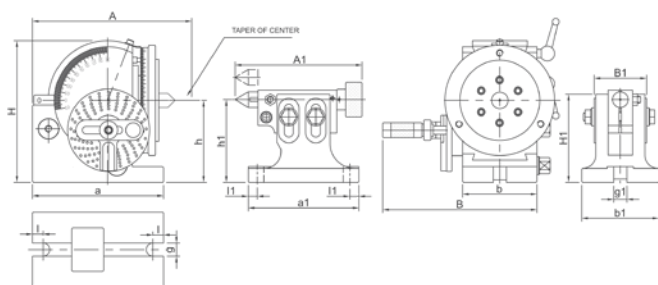
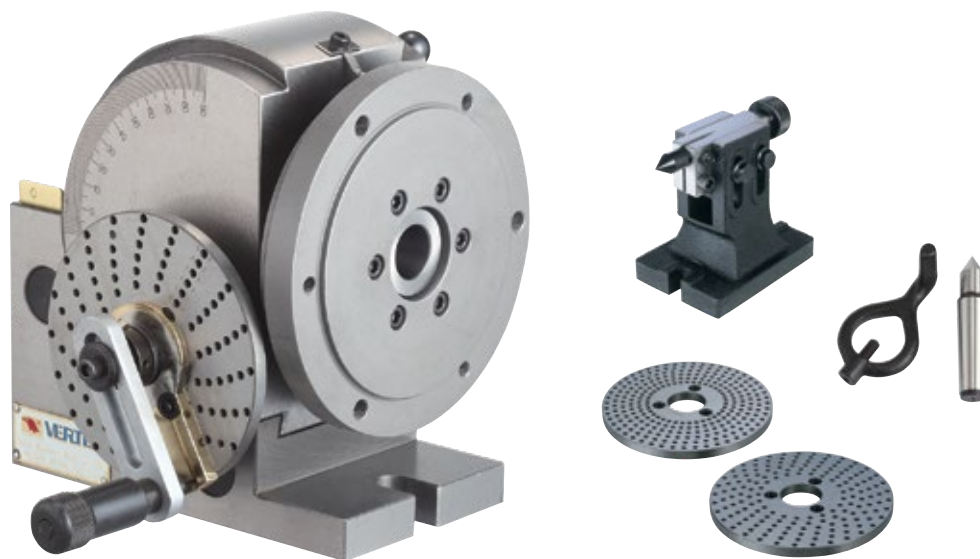

BS-0

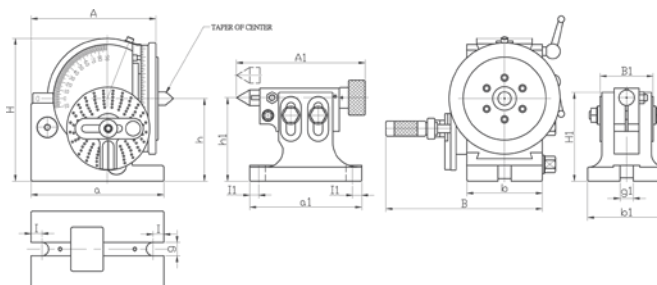

BS-1

Tail Stock

Model	A1 (mm)	B1 (mm)	H1 (mm)	l1 (mm)	a1 (mm)	b1 (mm)	h1 (mm)	g1	Weight (kg)
BS-0	155-180	64	107	11	134	94	80-108	16	4
BS-1	170-195	64	150	11	155	110	150-115	16	5.3

Standard Accessories: Dividing Plate A, B, C. Number of Holes of Dividing Plate (Worm Gear Reduction Ratio 40:1)

Number of Holes	Plate A	15	16	17	18	19	20
	Plate B	21	23	27	29	31	33
	Plate C	37	39	41	43	47	49

- A simplified type of universal index center
- Can be used for either direct or indirect dividing
- Three additional indexing plates included to provide the ability of indirect dividing of all divisions from 2 to 50 and also most common divisions up to 380
- Hardened and ground spindle is rigidly held in a taper roller bearing
- Hardened and ground worm
- Swivel head can be locked on any angle from 10° below horizontal to 90° vertical - precision fitting to base allows smooth rotation
- Threaded spindle nose and 24 hole dividing plate with easy conversion to fast direct indexing on numbers 2, 3, 4, 6, 8, 12 and 24

A (mm)	B (mm)	H (mm)	l (mm)	a (mm)	b (mm)	g (mm)	h (mm)	Center Taper (mm)	Spindle Through Hole (mm)	Code
177	188	173	13	160	91	16	100	MT2	18	277070
245	230	220	19	205	114	16	128	MT3	20	277072

DIVIDING HEADS & INDEXING SPACERS

Simple Indexing Spacer

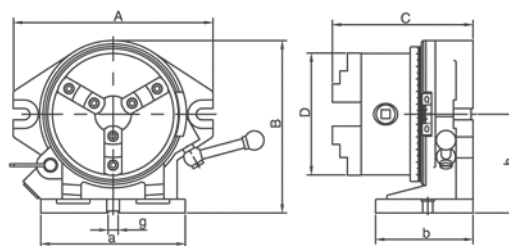

CC-6

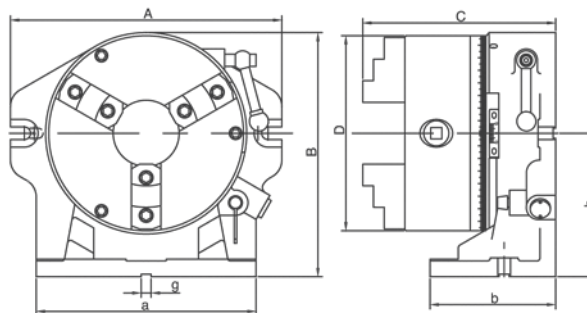

CC-8

- Mount on milling machines, drilling machines and other machine tools where an indexing facility is required
- Designed for use in horizontal or vertical positions
- Large center through hole suitable for large and long workpieces
- May be used with 3-jaw chuck
- Rapid indexing and easy operation, sharp for mass production
- Simple index includes 3-jaw chuck, masking plates 2, 3, 4, 6, 8 and 12
- Using the key guide block the center can be corrected quickly and accurately

Model	Dividable Number	A (mm)	B (mm)	C (mm)	D (mm)	a (mm)	b (mm)	h (mm)	Ø Inner Jaw (mm)	g Guide Block (mm)	Ø Outer Jaw (mm)	Ø Turret Hole (mm)	Ø Chuck Hole (mm)	Weight (kg)	Code
CC-6	2, 3, 4, 6, 8, 12, 24	253	225	179	160	187	115	130	55-145	16	3-160	44	44	29.5	277080
CC-8	2, 3, 4, 6, 8, 12, 24	318	274	209	200	230	155	157	65-200	16	4-200	63	58	51.5	277082

Tail Stock for Indexing Spacers

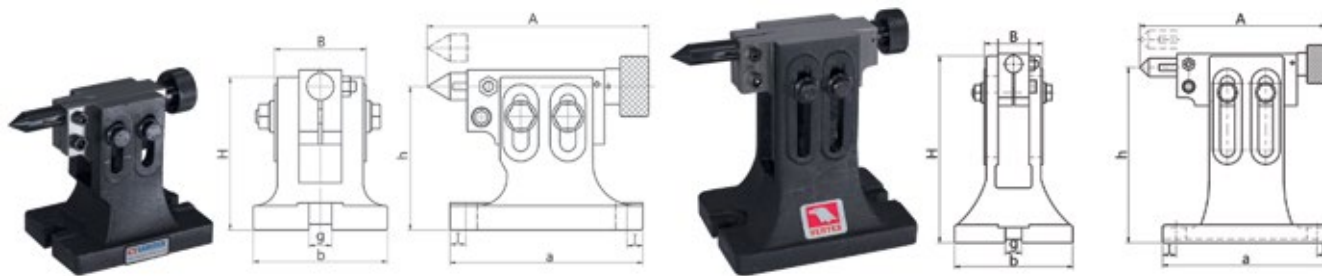

TS-1

TS-2, TS-3, TS-4

Model	Suitable for.....	Adjustable High-Low	A (mm)	B (mm)	H (mm)	I (mm)	a (mm)	b (mm)	g (mm)	Weight (kg)	Code
TS-1	HV-4, HV-6, VSI-4, VSI-5, BS-0, VUT-6, VU-100, VU-150	108-80	155-180	64	107	11	134	94	16	3.9	277092
TS-2	BS-1, CC-6, CS-6, HV-8	150-115	170-195	64	150	11	155	110	16	5.5	277094
TS-3	CS-8, HV-10, HV-12, CC-8, VUT-10, VUT-12, VU-200	205-130	210-235	64	205	13	185	138	16	8.1	277096
TS-4	HV-14, CC-12, HV-16	260-182	210-235	75	260	17	205	144	16	11.9	277084

Super Indexing Spacers

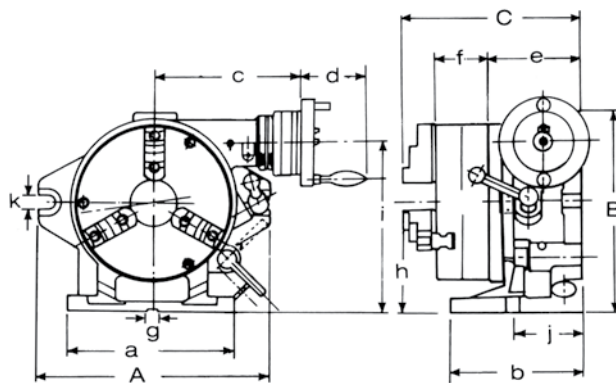

Masking Plates

Model	Chuck				Face Plate	
	Outer Diameter (mm)	Inner Jaw (mm)	Outer Jaw (mm)	Inner Diameter (mm)	Outer Diameter (mm)	Thickness (mm)
CS-6	160	4-42	10-156	44	203	50
CS-8	210	4-62	10-180	63	254	58

- 3-jaw chuck mounted
- In addition to all of the features of the simple indexing spacer, the super indexing spacer incorporates a worm gear and is supplied with a face plate. With the further addition of the optional dividing plate set, it can also be used as a dividing head.
- The worm gear is hardened and precision ground to minimize wear

Dividable Number	A (mm)	B (mm)	C (mm)	a (mm)	b (mm)	c (mm)	d (mm)	e (mm)	f (mm)	g (mm)	h (mm)	i (mm)	j (mm)	k (mm)	Weight (kg)	Code
2, 3, 4, 6, 8, 12, 24	250	235	221	220	150	184	82	112	66	16	123	186	80	18	43.6	277088
2, 3, 4, 6, 8, 12, 24	310	285	243	225	160	201	82	125	75	16	155	232	90	18	78.3	277090

Dividing Plate Sets

- Set includes: indexing plate, crank handle, screws (3), sector and a “U” washer



DP-1

DP-2, DP-3, DP-4, DP-5

Model	Number of Holes	
	Holes	
DP-1	A Plate: 15, 16, 17, 18, 19, 20 B Plate: 21, 23, 27, 29, 31, 33 C Plate: 37, 39, 41, 43, 47, 49	
DP-2, DP-3, DP-4, DP-5	A Plate: 26, 28, 30, 32, 34, 37, 38, 39, 41, 43, 44, 46, 47, 49, 51, 53, 57, 59 B Plate: 61, 63, 67, 69, 71, 73, 77, 79, 81, 83, 87, 89, 91, 93, 97, 99	

Model	Suitable for.....	Weight (kg)	Code
DP-1	HV-4, HV-6, VUT-6, VU-100, VU-150	1.4	277100
DP-2	HV-8, VU-200	4.5	277102
DP-3	HV-10, HV-12, HV-14, HV-16, VUT-10, VUT-12	4.6	277104
DP-4	CS-6, CS-8	4.6	277101
DP-5	VU-300	4.6	277103

DIVIDING HEADS & INDEXING SPACERS

Horizontal/Vertical Rotary Table

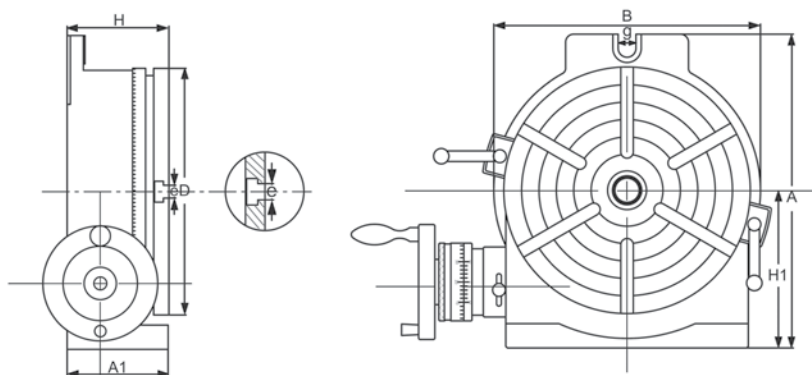

The work table is graduated 360 degrees around its circumference and is driven by a precision worm and gear providing a 90:1 reduction ratio. One turn of the handle moves the table through four degrees. The dial is graduated in divisions of 1 minute and the vernier scale allows readings down to 10 seconds.

- The worm is hardened and precision ground to minimize wear of the worm gear
- Both the upper and lower surface of the rotary plates are precision ground
- Operation and service manual included

OPTIONAL ACCESSORIES:

- Tail Stock
- Dividing Plate Set
- 3-Jaw Chuck

Model	Table			Base Dimensions			Width of T-Slot	Bolt Slots	Load Capacity of Table (kg)		Center Taper	Weight (kg)		Code
	Outer Diameter		Height						Horizontal	Vertical		Net	Gross	
	A1 (mm)	D (mm)	H (mm)	H1 (mm)	A (mm)	B (mm)	e (mm)	g						
HV-6	78	150	80	102	205	163	11	17	40	20	MT2	12.1	12.7	277106
HV-8	100	205	102	135	265	219	14	17	80	40	MT3	24.7	26.2	277107
HV-10	106	254	109	163	321	276	14	17	90	50	MT3	35.5	37.3	277108
HV-12	123	305	125	194	388	330	16	18	120	60	MT4	58.7	69.8	277109
HV-16	128	406	130	258	503	435	16	18	140	70	MT4	106.4	123.1	277110

Standard Toe Clamps

Low & High Grip Steel Toes

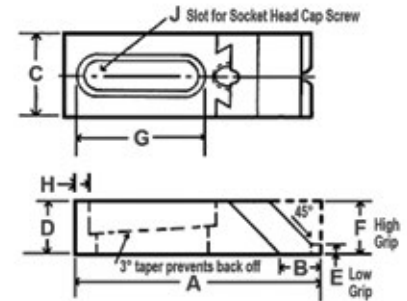
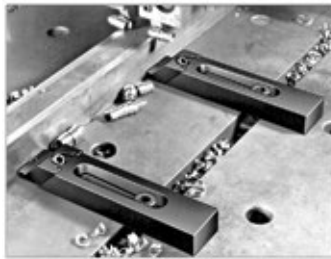

- Powerful clamps that grip on the side of the work leaving the top surface open
- Hardened for maximum wear
- Black oxide finish
- Each clamp is supplied with a protective washer
- Conforms to TCMAI standards

NOTE:

- Clamps slotted for 1/2" SHCS will accept M12 SHCS
- Clamps slotted for 5/8" SHCS will accept M16 SHCS
- Small toe clamps can be anchored with 5/16" or M8 SHCS

Low Grip Steel Toes

A (Inch)	B (Inch)	C (Inch)	D (Inch)	E (Inch)	G (Inch)	H (Inch)	J (Inch)	Slotted for 1/2" SHCS	Slotted for 5/8" SHCS
								Code	Code
4-1/16	13/16	1-1/2	7/8	1/4	2	1/8	1/2 or 5/8	217250	217253
5-1/2	13/16	1-1/2	7/8	1/4	2-3/4	1/2	1/2 or 5/8	217251	217254
7-7/16	13/16	1-1/2	7/8	1/4	3-3/4	1	1/2 or 5/8	217252	217255

High Grip Steel Toes

A (Inch)	B (Inch)	C (Inch)	D (Inch)	E (Inch)	G (Inch)	H (Inch)	J (Inch)	Slotted for 1/2" SHCS	Slotted for 5/8" SHCS
								Code	Code
4-1/16	13/16	1-1/2	7/8	1/4	2	1/8	1/2 or 5/8	217262	217265
5-1/2	13/16	1-1/2	7/8	1/4	2-3/4	1/2	1/2 or 5/8	217263	217266
7-7/16	13/16	1-1/2	7/8	1/4	3-3/4	1	1/2 or 5/8	217264	217267

Machinist's Clamp Sets



Inch & Metric

Inch Set

Set includes:

- 4 coupling nuts
- 4 flanged nuts
- 6 T-slot nuts
- 1 T-slot cleaner
- 24 studs with flats – 4 each of 3", 4", 5", 6", 7" and 8" long
- 6 stepped blocks
- 6 serrated end clamps

Packed in carton - metal storage container not included

Table Slot (Inch)	Stud Size	Weight (lbs)	Code
7/16	3/8 - 16	19	217330
1/2	3/8 - 16	19	217331
9/16	3/8 - 16	19	217332
9/16	1/2 - 13	24	217333
11/16	1/2 - 13	24	217334
5/8	1/2 - 13	24	217335
11/16	5/8 - 11	29	217336
3/4	5/8 - 11	29	217337
13/16	5/8 - 11	29	217338

Metric Set

- Standard 1" wide blocks

Table Slot (mm)	Stud Size	Net Weight (lbs)	Code
12	M10	19	217569
14	M12	24	217570

Table Slot (mm)	Stud Size	Net Weight (lbs)	Code
16	M12	24	217571
18	M16	31	217572
20	M16	31	217573

Clamping Sets

Wall Mount

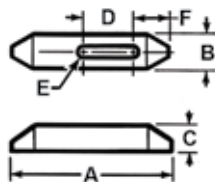

Table Slot (Inch)	Stud Size	Block Width (Inch)	Model	Code
1/2	3/8-16	1	500CKM	400010
5/8	1/2-13	1	625CKM	400020
3/4	5/8-11	1	750CKM	400030

Plain Clamps



- Black oxide finish
- Case hardened



A (Inch)	B (Inch)	C (Inch)	D (Inch)	E Stud Size (Inch)	F (Inch)	Code
2-1/2	1	1/2	13/16	5/16 or 3/8	27/32	217358
4	1	5/8	1-7/16	5/16 or 3/8	1-1/32	217359
6	1-1/8	3/4	2-3/16	5/16 or 3/8	1-5/32	217360
2-1/2	1-1/8	1/2	11/16	1/2	29/32	217361
4	1-1/4	3/4	1-5/16	1/2	1-5/32	217362
6	1-1/4	7/8	2-1/16	1/2	1-9/32	217363
2-1/2	1-1/4	5/8	9/16	5/8	31-32	217364
4	1-1/2	3/4	1-3/16	5/8	1-9/32	217365
6	1-1/2	7/8	1-15/16	5/8	1-13/32	217366
4	1-1/2	3/4	1-1/16	3/4	1-11/32	217367
6	1-1/2	1	1-15/16	3/4	1-15/32	217368
8	1-3/4	1-1/8	2-3/16	3/4	1-29/32	217369
6	2	1-1/4	1-11/16	7/8 or 1	1-27/32	217370
8	2	1-3/8	1-15/16	7/8 or 1	2-1/32	217371
10	2	1-1/2	2-15/16	7/8 or 1	2-1/32	217372

Plain Clamps



Bolt Size (Inch)	Length (Inch)	Width (Inch)	Thickness (Inch)	Code	Bolt Size (Inch)	Length (Inch)	Width (Inch)	Thickness (Inch)	Code
3/8	2-1/2	1	1/2	400302	5/8	6	1-1/2	7/8	400326
3/8	4	1	5/8	400304	3/4	4	1-1/2	3/4	400334
3/8	6	1-1/8	3/4	400306	3/4	6	1-1/2	1	400336
1/2	2-1/2	1-1/8	1/2	400312	3/4	8	1-3/4	1-1/8	400338
1/2	4	1-1/4	3/4	400314	1	6	2	1-1/4	400346
1/2	6	1-1/4	7/8	400316	1	8	2	1-3/8	400348
5/8	2-1/2	1-1/4	5/8	400322	1	10	2	1-1/2	400350
5/8	4	1-1/2	3/4	400324					

Flanged Nuts



Inch & Metric

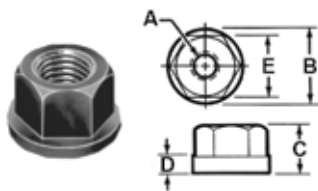

- UNC
- Heat treated steel with black oxide finish for long life under repeated usage
- Flange provides large bearing surface and reduces chance of possible damage to part being clamped

Inch

A Thread Size	B (Inch)	C (Inch)	D (Inch)	E (Inch)	Code
1/4-20	5/8	5/16	3/32	1/2	217339
5/16-18	3/4	3/8	1/8	9/16	217340
3/8-16	7/8	1/2	1/8	11/16	217341
7/16-14	1	9/16	5/32	3/4	217342
1/2-13	1-1/8	11/16	3/16	7/8	217343
5/8-11	1-3/8	13/16	3/16	1-1/16	217344
3/4-10	1-5/8	1	1/4	1-1/4	217345
7/8-9	1-3/4	1-1/8	1/4	1-7/16	217346
1-8	2	1-1/4	1/4	1-5/8	217347
1-1/4-7	2-1/2	1-1/4	1/4	1-13/16	217348

Metric

A Thread Size	B (mm)	C (mm)	D (mm)	E (mm)	Code
M8 x 1.25	19.0	9.5	2.4	14.3	217607
M10 x 1.50	22.2	12.7	3.2	17.4	217608
M12 x 1.75	28.5	17.4	4.0	22.2	217609
M16 x 2.00	35.0	20.6	4.7	27.0	217610

Flanged Nuts

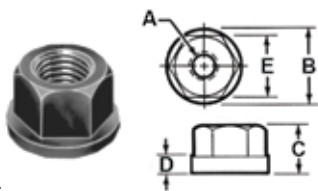

- UNC
- Heat treated steel with black oxide finish for long life under repeated usage

A Thread Size	B (Inch)	C (Inch)	D (Inch)	E (Inch)	Code
5/16-18	3/4	3/8	3/32	9/16	400800
3/8-16	7/8	1/2	1/8	11/16	400802
1/2-13	1-5/16	11/16	1/8	13/16	400804
5/8-11	1-3/8	13/16	3/16	1-1/16	400806
3/4-10	1-1/2	1	1/4	1-1/4	400808
7/8-9	1-3/4	1-1/8	1/4	1-7/16	400810
1-8	2	1-1/4	1/4	1-5/8	400812

Coupling Nuts

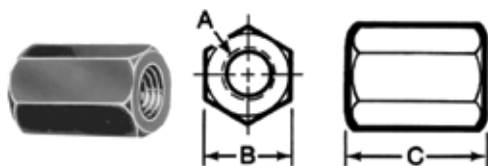

- Heat treated steel with black oxide finish

A Thread Size	B Hex Size (Inch)	C Length (Inch)	Code
5/16-18	9/16	7/8	400601
3/8-16	11/16	1	400602
1/2-13	7/8	1-1/4	400604
5/8-11	1-1/16	1-5/8	400606
3/4-10	1-1/4	1-7/8	400608
7/8-9	1-7/16	2-1/4	400610
1-8	1-5/8	2-1/2	400612

CLAMPING COMPONENTS

Coupling Nuts

Inch & Metric

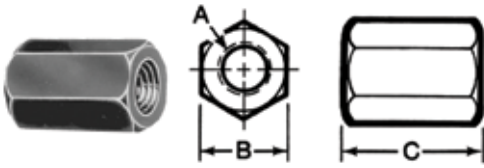

- Heat treated steel with black oxide finish for long life under repeated usage
- Coupling nut allows studs to be joined together to create desired length

Inch

A Thread Size	B (Inch)	C (Inch)	Code
1/4 - 20	1/2	5/8	217349
5/16 - 18	9/16	7/8	217350
3/8 - 16	11/16	1	217351
7/16 - 14	3/4	1-1/4	217352
1/2 - 13	7/8	1-1/4	217353
5/8 - 11	1-1/16	1-5/8	217354
3/4 - 10	1-1/4	1-7/8	217355
7/8 - 9	1-7/16	2-1/4	217356
1 - 8	1-5/8	2-1/2	217357

Metric

A Thread Size	B (mm)	C (Inch)	Code
M8 x 1.25	14.3	22	217611
M10 x 1.50	17.4	25	217612
M12 x 1.75	22.2	32	217613
M16 x 2.00	27.0	41	217614

T-Slot Nuts

Inch & Metric

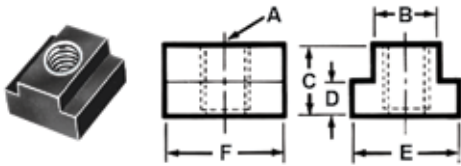

- Black oxide finish
- Case hardened
- Many sizes conform to TCMA standards
- The last thread is incomplete on T-Slot nuts to prevent the stud from turning through bottom of nut into machine table

To keep from damaging the T-Nut, the mating thread must be threaded as far as possible into the T-Nut. Standard T-Slot Nuts have an incomplete thread in the base to eliminate any danger of screwing the stud through the nut and damaging the machine table.

Inch

B Table Slot (Inch)	A Thread Size	E (Inch)	D (Inch)	C (Inch)	F Length (Inch)	Code
3/8	5/16 - 18	5/8	3/16	1/2	7/8	217373
7/16	3/8 - 16	11/16	7/32	1/2	7/8	217374
1/2	3/8 - 16	7/8	9/32	1/2	7/8	217375
9/16	3/8 - 16	7/8	11/32	5/8	1-1/8	217376
9/16	1/2 - 13	7/8	11/32	5/8	1-1/8	217377
5/8	1/2 - 13	1	11/32	5/8	1-1/8	217378
11/16	1/2 - 13	1-1/8	7/16	3/4	1-1/4	217379
11/16	5/8 - 11	1-1/8	7/16	3/4	1-1/4	217380
3/4	5/8 - 11	1-1/4	15/32	3/4	1-1/4	217381
13/16	5/8 - 11	1-1/4	9/16	1	1-1/2	217382
13/16	3/4 - 10	1-1/4	9/16	1	1-1/2	217383
7/8	3/4 - 10	1-1/2	9/16	1	1-1/2	217384
1	3/4 - 10	1-5/8	5/8	1	1-3/4	217385
1	7/8 - 9	1-5/8	5/8	1	1-3/4	217387
1-1/16	3/4 - 10	1-5/8	11/16	1-1/8	2	217386
1-1/16	1 - 8	1-5/8	11/16	1-1/8	2	217388

Metric

B Table Slot (mm)	A Thread Size	E (mm)	D (mm)	C (mm)	F Length (mm)	Code
10	M8 x 1.25	16.0	6	12.7	22	217601
12	M10 x 1.50	22.0	7	12.7	22	217602
14	M12 x 1.75	22.0	8	16.0	29	217603
16	M12 x 1.75	25.4	9	16.0	29	217604
18	M16 x 2.00	31.7	11	19.0	32	217605
20	M16 x 2.00	31.7	12	25.4	38	217606

T-Slot Nuts

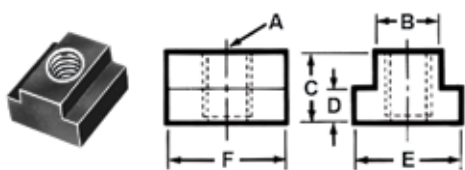

- Black oxide finish
- Case hardened
- Many sizes conform to TCMA standards
- The last thread is incomplete on T-Slot nuts to prevent the stud from turning through bottom of nut into machine table

B Table Slot (Inch)	A Thread Size	E (Inch)	D (Inch)	C (Inch)	F Length (Inch)	Code
3/8	5/16-18	5/8	3/16	1/2	7/8	400701
7/16	3/8-16	11/16	7/32	1/2	7/8	400702
1/2	3/8-16	7/8	9/32	1/2	7/8	400704
9/16	3/8-16	7/8	11/32	5/8	1-1/8	400706
9/16	1/2-13	7/8	11/32	5/8	1-1/8	400708
5/8	1/2-13	1	11/32	5/8	1-1/8	400710
11/16	1/2-13	1-1/8	7/16	3/4	1-1/4	400712
11/16	5/8-11	1-1/8	7/16	3/4	1-1/4	400714
3/4	5/8-11	1-1/4	15/32	3/4	1-1/4	400716
13/16	5/8-11	1-1/4	9/16	1	1-1/2	400718
13/16	3/4-10	1-1/4	9/16	1	1-1/2	400720
7/8	3/4-10	1-1/2	9/16	1	1-1/2	400722
1	3/4-10	1-5/8	5/8	1	1-3/4	400724
1-1/16	3/4-10	1-5/8	11/16	1-1/8	2	400726
1	7/8-9	1-5/8	5/8	1	1-3/4	400728
1-1/16	1-8	1-5/8	11/16	1-1/8	2	400730



T-Slot Cleaner

- Heat treated steel
- Black oxide finish
- Eliminates the danger of removing chips with air
- Saves time



Length (Inch)	Code
6	217389

T-Slot Bolts

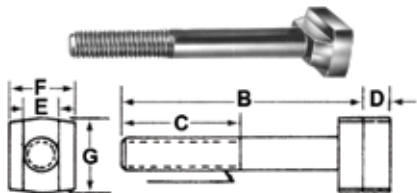

- Black oxide finish
- Medium carbon steel
- Diameters offered include 3/8", 1/2", 5/8", 3/4", 7/8" and 1"
- T-Slot bolt head thickness "D" is undersized to fit machine table slot
- Thread class 2A UNC
- Sizes functionally interchange with forged T-Slot bolts



3/8-16

B Length (Inch)	C (Inch)	D (Inch)	E (Inch)	F (Inch)	G (Inch)	Code	B Length (Inch)	C (Inch)	D (Inch)	E (Inch)	F (Inch)	G (Inch)	Code
1-1/2	1	13/64	3/8	5/8	3/4	217390	3	1-1/2	13/64	3/8	5/8	3/4	217393
2	1-1/4	13/64	3/8	5/8	3/4	217391	3-1/2	1-1/2	13/64	3/8	5/8	3/4	217394
2-1/2	1-1/2	13/64	3/8	5/8	3/4	217392	4	1-1/2	13/64	3/8	5/8	3/4	217395

5/8-11

B Length (Inch)	C (Inch)	D (Inch)	E (Inch)	F (Inch)	G (Inch)	Code	B Length (Inch)	C (Inch)	D (Inch)	E (Inch)	F (Inch)	G (Inch)	Code
1-1/2	1	5/16	5/8	1-1/64	1-1/8	217404	3-1/2	1-1/2	5/16	5/8	1-1/64	1-1/8	217408
2	1-1/4	5/16	5/8	1-1/64	1-1/8	217405	4	1-1/2	5/16	5/8	1-1/64	1-1/8	217409
2-1/2	1-1/2	5/16	5/8	1-1/64	1-1/8	217406	5	1-1/2	5/16	5/8	1-1/64	1-1/8	217410
3	1-1/2	5/16	5/8	1-1/64	1-1/8	217407	6	2	5/16	5/8	1-1/64	1-1/8	217411
							8	3	5/16	5/8	1-1/64	1-1/8	217412

CLAMPING COMPONENTS

T-Slot Bolts

(continued)

3/4-10

B Length (Inch)	C (Inch)	D (Inch)	E (Inch)	F (Inch)	G (Inch)	Code	B Length (Inch)	C (Inch)	D (Inch)	E (Inch)	F (Inch)	G (Inch)	Code
3	1-1/2	3/8	3/4	1-1/4	1-3/8	217413	5	1-1/2	3/8	3/4	1-1/4	1-3/8	217416
3-1/2	1-1/2	3/8	3/4	1-1/4	1-3/8	217414	6	2	3/8	3/4	1-1/4	1-3/8	217417
4	1-1/2	3/8	3/4	1-1/4	1-3/8	217415	8	3	3/8	3/4	1-1/4	1-3/8	217418

1-8

B Length (Inch)	C (Inch)	D (Inch)	E (Inch)	F (Inch)	G (Inch)	Code	B Length (Inch)	C (Inch)	D (Inch)	E (Inch)	F (Inch)	G (Inch)	Code
4	2	1/2	1	1-21/32	1-7/8	217419	6	2	1/2	1	1-21/32	1-7/8	217421
5	2	1/2	1	1-21/32	1-7/8	217420	8	3	1/2	1	1-21/32	1-7/8	217422
							10	3	1/2	1	1-21/32	1-7/8	217423

1/2-13

B Length (Inch)	C (Inch)	D (Inch)	E (Inch)	F (Inch)	G (Inch)	Code	B Length (Inch)	C (Inch)	D (Inch)	E (Inch)	F (Inch)	G (Inch)	Code
1-1/2	1	1/4	1/2	13/16	1	217396	3-1/2	1-1/2	1/4	1/2	13/16	1	217400
2	1-1/4	1/4	1/2	13/16	1	217397	4	1-1/2	1/4	1/2	13/16	1	217401
2-1/2	1-1/2	1/4	1/2	13/16	1	217398	5	1-1/2	1/4	1/2	13/16	1	217402
3	1-1/2	1/4	1/2	13/16	1	217399	6	2	1/4	1/2	13/16	1	217403

Serrated Step Clamps

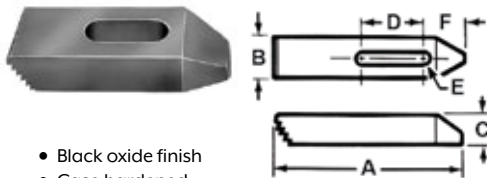

- Black oxide finish
- Case hardened
- Teeth match all step blocks

A (Inch)	B (Inch)	C (Inch)	D (Inch)	E Stud Size (Inch)	F (Inch)	Code
2-1/2	1	1/2	13/16	5/16 or 3/8	27/32	217424
4	1	5/8	1-7/16	5/16 or 3/8	1-1/32	217425
6	1-1/8	3/4	2-3/16	5/16 or 3/8	1-5/32	217426
2-1/2	1-1/8	1/2	11/16	1/2	29/32	217427
4	1-1/4	3/4	1-5/16	1/2	1-5/32	217428
6	1-1/4	7/8	2-1/16	1/2	1-9/32	217429
2-1/2	1-1/4	5/8	9/16	5/8	31/32	217430
4	1-1/2	3/4	1-3/16	5/8	1-9/32	217431
6	1-1/2	7/8	1-15/16	5/8	1-13/32	217432
4	1-1/2	3/4	1-1/16	3/4	1-11/32	217433
6	1-1/2	1	1-15/16	3/4	1-15/32	217434
8	1-3/4	1-1/8	2-3/16	3/4	1-29/32	217435
6	2	1-1/4	1-11/16	7/8 or 1	1-27/32	217436
8	2	1-3/8	1-15/16	7/8 or 1	2-1/32	217437
10	2	1-1/2	2-15/16	7/8 or 1	2-1/32	217438

Serrated Step Clamps



Thickness (Inch)	Length (Inch)	Width (Inch)	Bolt Size (Inch)	Code
1/2	2-1/2	1	3/8	400202
5/8	4	1	3/8	400204
3/4	6	1-1/8	3/8	400206
1/2	2-1/2	1-1/8	1/2	400212
3/4	4	1-1/4	1/2	400214
7/8	6	1-1/4	1/2	400216
5/8	2-1/2	1-1/4	5/8	400222
3/4	4	1-1/2	5/8	400224
7/8	6	1-1/2	5/8	400226
3/4	4	1-1/2	3/4	400234
1	6	1-1/2	3/4	400236
1-1/8	8	1-3/4	3/4	400238
1-1/4	6	2	1	400246
1-3/8	8	2	1	400248
1-1/2	10	2	1	400250

Step Blocks

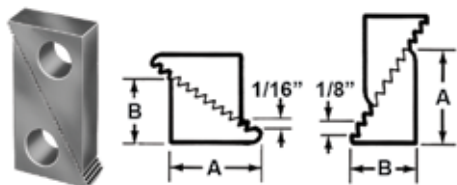

- Chamfered holes in larger sizes for ease of use
- Steel stepped blocks have black oxide finish
- Two halves = one block – order by block
- Teeth match serrated stepped clamps

Width (Inch)	Height Adjustment Range (Inch)	A (Inch)	B (Inch)	Code
1	3/4 – 1-5/8	1-1/16	11/16	217439
1	1-1/8 – 2-1/2	1-39/64	1-1/16	217440
1	2-1/2 – 6	3-3/4	2-15/32	217441
1-1/2	1-3/4 – 4	2-17/32	1-43/64	217442
1-1/2	2-1/2 – 6	3-3/4	2-15/32	217443
1-1/2	3-1/2 – 9	5-21/64	3-7/16	217444
2	1-3/4 – 4	2-17/32	1-43/64	217445
2	2-1/2 – 6	3-3/4	2-15/32	217446
2	3-1/2 – 9	5-21/64	3-7/16	217447

T-Nut & Stud Sets



Table Slot (Inch)	Stud Size	Code
5/8	1/2 - 13	400055
3/4	5/8 - 11	400060
7/8	3/4 - 10	400065

Step Block & Clamp Sets



Block Width (Inch)	Stud Size (Inch)	Code
1	3/8	400075
1	1/2	400080

Clamping Studs

Inch & Metric – Material TO ASTM A 311 Class B

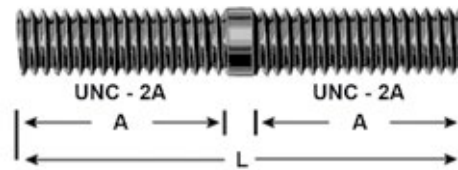

Inch

L Length (Inch)	1/4-20		5/16-18		3/8-16		1/2-13		5/8-11		3/4-10		7/8-9		1-8	
	A (Inch)	Code	A (Inch)	Code	A (Inch)	Code	A (Inch)	Code	A (Inch)	Code	A (Inch)	Code	A (Inch)	Code	A (Inch)	Code
1-1/2	1	217448	1-1/8	217454	1-1/4	217465	1-1/2	217479	1-3/4	217497	-	-	-	-	-	-
2	1	217449	1-1/8	217455	1-1/4	217466	1-1/2	217480	1-3/4	217498	-	-	-	-	-	-
2-1/2	1	217450	1-1/8	217456	1-1/4	217467	1-1/2	217481	1-3/4	217499	-	-	-	-	-	-
3	1	217451	1-1/8	217457	1-1/4	217468	1-1/2	217482	1-3/4	217500	2	217515	2-1/4	217533	2-1/2	217546
3-1/2	1	217452	1-1/8	217458	1-1/4	217469	1-1/2	217483	1-3/4	217501	2	217516	-	-	-	-
4	1	217453	1-1/8	217459	1-1/4	217470	1-1/2	217484	1-3/4	217502	2	217517	2-1/4	217534	2-1/2	217547
4-1/2	-	-	1-1/8	217460	1-1/4	217471	1-1/2	217485	1-3/4	217503	2	217518	-	-	-	-
5	-	-	1-1/8	217461	1-1/4	217472	1-1/2	217486	1-3/4	217504	2	217519	2-1/4	217535	2-1/2	217548
5-1/2	-	-	-	-	1-1/4	217473	1-1/2	217487	1-3/4	217505	2	217520	-	-	-	-
6	-	-	1-1/8	217462	1-1/4	217474	1-1/2	217488	1-3/4	217506	2	217521	2-1/4	217536	2-1/2	217549
6-1/2	-	-	-	-	1-1/4	217475	1-1/2	217489	1-3/4	217507	2	217522	-	-	-	-
7	-	-	1-1/8	217463	1-1/4	217476	1-1/2	217490	1-3/4	217508	2	217523	2-1/4	217537	2-1/2	217550
7-1/2	-	-	-	-	1-1/4	217477	1-1/2	217491	1-3/4	217509	2	217524	-	-	-	-
8	-	-	1-1/8	217464	1-1/4	217478	1-1/2	217492	1-3/4	217510	2	217525	2-1/4	217538	2-1/2	217551
9	-	-	-	-	-	-	2	217493	2	217511	2	217526	2-1/4	217539	2-1/2	217552
10	-	-	-	-	-	-	2	217494	2	217512	2	217527	2-1/4	217540	2-1/2	217553
12	-	-	-	-	-	-	2	217495	2	217513	2	217528	2-1/4	217541	2-1/2	217554
14	-	-	-	-	-	-	2	217496	2	217514	2	217529	2-1/4	217542	2-1/2	217555
16	-	-	-	-	-	-	-	-	-	-	2	217530	2-1/4	217543	2-1/2	217556
18	-	-	-	-	-	-	-	-	-	-	2	217531	2-1/4	217544	2-1/2	217557
20	-	-	-	-	-	-	-	-	-	-	2	217532	2-1/4	217545	2-1/2	217558

Metric

L Length (mm)	M8 x 1.25		M10 x 1.5		M12 x 1.75		M16 x 2.0	
	A (mm)	Code	A (mm)	Code	A (mm)	Code	A (mm)	Code
50	33	217577	-	-	-	-	-	-
65	33	217578	35	217583	-	-	-	-
80	33	217579	35	217584	39	217589	47	217595
95	33	217580	35	217585	39	217590	-	-
110	33	217581	35	217586	39	217591	47	217596
125	33	217582	35	217587	39	217592	47	217597
150	-	-	35	217588	39	217593	47	217598
175	-	-	-	-	39	217594	47	217599
200	-	-	-	-	-	-	47	217600

Clamping Studs

Inch



L Length (Inch)	5/16-18		3/8-16		1/2-13		5/8-11		3/4-10		7/8-9		1-8	
	A (Inch)	Code	A (Inch)	Code	A (Inch)	Code	A (Inch)	Code	A (Inch)	Code	A (Inch)	Code	A (Inch)	Code
3	3/4	400393	1-1/4	400403	1-1/2	400423	1-3/4	400443	2	400463	2-1/4	400482	2-1/2	400501
4	3/4	400394	1-1/4	400405	1-1/2	400425	1-3/4	400445	2	400465	2-1/4	400484	2-1/2	400503
5	3/4	400395	1-1/4	400407	1-1/2	400427	1-3/4	400447	2	400467	2-1/4	400486	2-1/2	400505
6	3/4	400396	1-1/4	400409	1-1/2	400429	1-3/4	400449	2	400469	2-1/4	400488	2-1/2	400507
7	3/4	400397	1-1/4	400411	1-1/2	400431	1-3/4	400451	2	400471	2-1/4	400490	2-1/2	400509
8	3/4	400398	1-1/4	400413	1-1/2	400433	1-3/4	400453	2	400473	2-1/4	400492	2-1/2	400511
10	-	-	-	-	-	-	1-3/4	400455	2	400475	2-1/4	400494	2-1/2	400513
12	-	-	-	-	-	-	1-3/4	400457	2	400476	2-1/4	400495	2-1/2	400514
14	-	-	-	-	-	-	-	-	2	400477	2-1/4	400496	2-1/2	400515
16	-	-	-	-	-	-	-	-	2	400478	2-1/4	400497	2-1/2	400516
18	-	-	-	-	-	-	-	-	2	400479	2-1/4	400498	2-1/2	400517
20	-	-	-	-	-	-	-	-	2	400480	2-1/4	400499	2-1/2	400518

Screw Jacks & Pads



No. 6400 – Screw Jacks with Flat Support

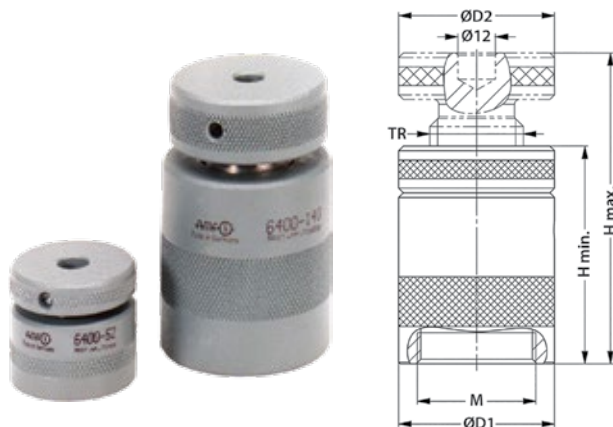

- For clamping and setting
- Screw jack flat top with center hole 12mm diameter
- Trapezoidal thread, self-locking spindle with end stops
- Tempered carbon steel

Note:

- Size 50 without centering hole Ø12mm
- Sizes 52-100mm suitable for clamps with slot width of approximately 14-22mm
- Sizes 140-300 suitable for clamps with slot width of approximately 20-40mm
- Sizes 200-280 are intended for supporting large work pieces
- Suitable pads for screw jack sizes 52-280 are nos. 6440, 6441, 6442, and 6443 (on next page)
- Suitable pad for sizes 52-100 is no. 6442 (on next page)
- DO NOT ADJUST SCREW JACK UNDER LOAD

Size (mm)	H min. (mm)	H max. (mm)	TR	ØD1 (mm)	ØD2 (mm)	M	F max. (kN)	Weight (g)	Code
50	38	50	20 x 4	31	31	-	25	190	405902
52	42	52	30 x 4	50	50	M38 x 2	100	550	405904
70	50	70	30 x 4	50	50	M38 x 2	100	620	405906
100	70	100	30 x 4	50	50	M38 x 2	100	900	405908
140	100	140	40 x 7	68	68	-	120	2760	405910
210	140	210	50 x 8	80	70	-	170	4600	405912
200	140	200	65 x 10	100	80	-	350	6900	405914
300	190	300	65 x 10	100	80	-	350	9000	405916
280	190	280	80 x 10	140	110	-	600	19000	405918

CLAMPING COMPONENTS

Screw Jacks & Pads (continued)



No. 6401 – Aluminum Screw Jacks

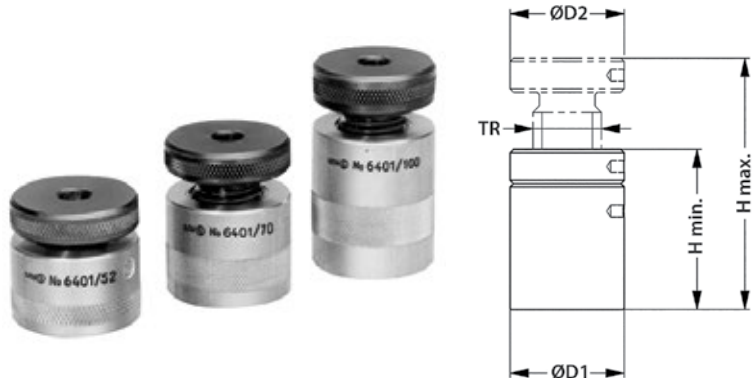

- For clamping and setting
- Screw jack aluminum base with center hole 12mm diameter
- Trapezoidal thread, self-locking spindle with end stop
- Tempered carbon steel with aluminum base 400N/mm² tensile strength

Note:

- Safeguards machine tables against damage (swarf does not penetrate table - enters aluminum base)
- Useful for all machine tool tables, surface plates and plane tables with precision faces
- Suitable pads are nos. 6440, 6441, and 6442 (below)
- DO NOT ADJUST SCREW JACK UNDER LOAD

Size (mm)	H min. (mm)	H max. (mm)	TR	ØD1 (mm)	ØD2 (mm)	F max. (kN)	Weight (g)	Code
52	42	52	30 x 4	50	50	30	370	405920
70	50	70	30 x 4	50	50	30	430	405922
100	70	100	30 x 4	50	50	30	600	405924

No. 6430 – Atlas Screw Jack with Counter Nut



- For clamping and setting
- Atlas screw jack with center hole 12mm diameter
- Trapezoidal threaded spindle
- Cast iron body, tempered steel spindle

Note:

- Suitable pads are nos. 6440, 6441, 6442, and 6443 (below)
- DO NOT ADJUST SCREW JACK UNDER LOAD

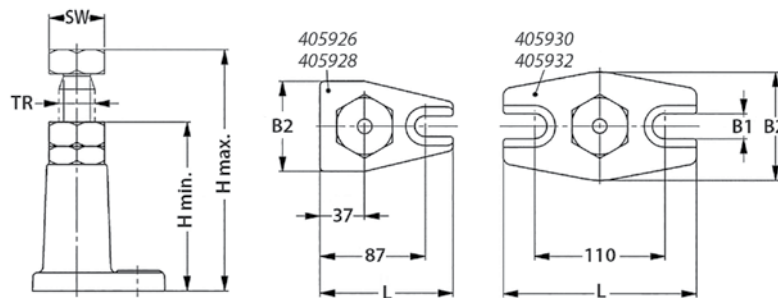

Size (mm)	H min. (mm)	H max. (mm)	TR	B1 (mm)	B2 (mm)	L (mm)	SW (mm)	F max. (kN)	Weight (kg)	Code
140	100	140	30 x 6	18	75	110	46	60	1.8	405926
200	140	200	30 x 6	18	75	110	46	60	2.2	405928
320	200	320	30 x 6	22	90	160	46	40	3.8	406930
550	320	550	30 x 6	22	90	160	46	25	4.9	405932

Screw Jack Pads



Pad No.	For Screw Jack Model No. ...			Code
	6400	6401	6430	
6440 Ball Pad	•	•	•	405940
6441 V-Pad	•	•	•	405942
6442 Centering Pad	•	•	•	405944
6443 Locating Pad	•	—	•	405948

Hi-Rise Clamps & Accessories

Standard Hi-Rise Clamps – 34-Piece Sets



- A 1/4 turn of the clamp disengages the tangs from the slots in the rack allowing the clamp to move up and down
- Adding extensions to the rack gives an unlimited clamping range
- Racks and clamps are hardened to provide better wear resistance

Sets include:

- 2 Studs of each length: 3", 4", 5", 6", 7" and 8"
- 2 T-Slot Nuts to fit your machine
- 2 Toggle Flanged Nuts
- 4 Coupling Nuts
- 2 Standard length Hi-Rise Clamps
- 2 Slotted Racks 6" long
- 2 Extensions, 4" long
- 2 Extensions, 6-1/2" long
- 2 Aluminum Bases
- 2 Clamp Supports
- 1 "T" Slot Cleaner
- 1 Handy Holder

Stud Size	Table Slot (Inch)	Net Weight per Set (lbs)	Code
3/8 - 16	7/16	16	217615
3/8 - 16	1/2	16	217616
3/8 - 16	9/16	16	217617
1/2 - 13	9/16	18	217618
1/2 - 13	5/8	18	217619
1/2 - 13	11/16	18	217620
5/8 - 11	11/16	20	217621

Stud Size	Table Slot (Inch)	Net Weight per Set (lbs)	Code
5/8 - 11	3/4	20	217622
5/8 - 11	13/16	21	217623
3/4 - 10	13/16	24	217624
3/4 - 10	7/8	24	217625
3/4 - 10	1	24	217626
3/4 - 10	1-1/16	25	217627

Hi-Rise Clamps

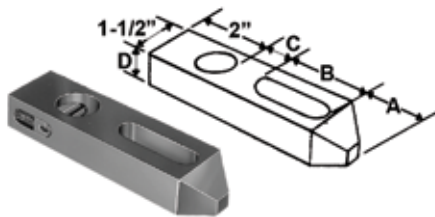

- Heat treated alloy steel
- Black oxide finish
- Clamp slides up or down the slotted rack for fast height adjustment

Style	Stud Size (Inch)	A (Inch)	B (Inch)	C (Inch)	D (Inch)	Code
Standard	3/8	3/4	2	3/4	7/8	217641
Long Reach	3/8	1-1/8	3	1-3/8	7/8	217642
Standard	1/2	3/4	2	3/4	7/8	217643
Long Reach	1/2	1-1/8	3	1-3/8	7/8	217644
Standard	5/8	3/4	2	3/4	7/8	217645
Long Reach	5/8	1-1/8	3-1/2	1-7/8	1-1/8	217646
Standard	3/4	3/4	2	3/4	7/8	217647
Long Reach	3/4	1-1/8	3-1/2	1-7/8	1-1/8	217648

Solid Extensions



- Extends the slotted rack for larger height requirements
- Black oxide finish

Length (Inch)	Diameter (Inch)	Code
4	1	217649
6-1/2	1	217650

Aluminum Base



- Provides solid support
- Protects tables

Height (Inch)	Diameter (Inch)	Code
5/8	2-1/2	217651

Slotted Rack



- Slots let clamps adjust within 1/16" of work height
- Heat treated alloy steel
- Black oxide finish

Length (Inch)	Diameter (Inch)	Code
6	1	217652

Toggle Clamps & Accessories

Vertical Handle Toggle Clamp

- Miniature size
- Holding capacity: 50 kg (100 lbs) maximum
- Weight: 60 g (2 oz)
- Handle moves 56°, bar 100°
- Neoprene tipped
- Vinyl hand grip

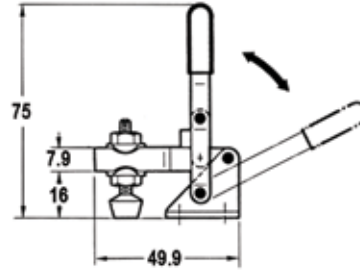
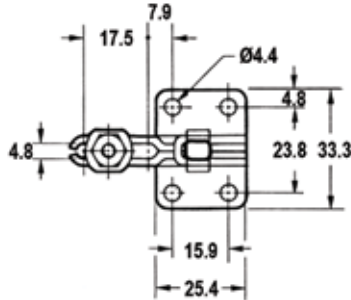

Model	Description	Code
SH-101-A	U-bar, flanged base, straight handle	412101

Vertical Handle Toggle Clamps

- Holding capacity: 91 kg (200 lbs) maximum
- Weight: 170 g (6 oz)
- Handle moves 60°, bar 100°
- Neoprene tipped
- Solid bar
- Vinyl hand grip

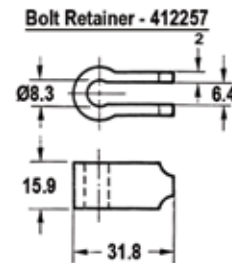
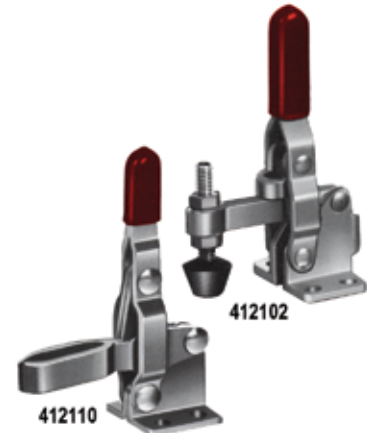
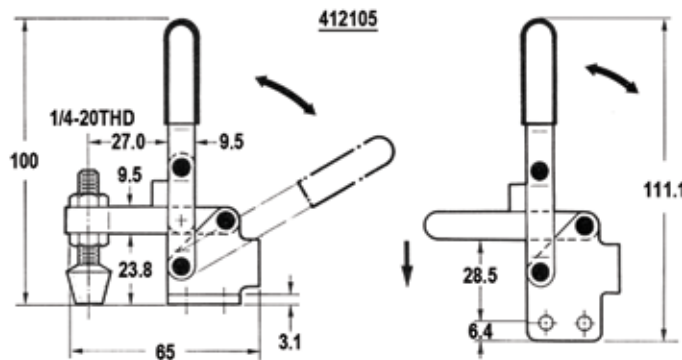
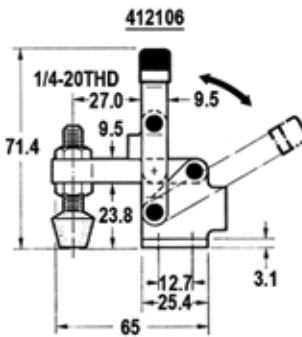
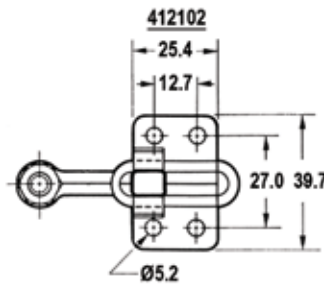

Model	Description	Code
SH-12050	Fixed spindle, flanged base, straight handle	412102
SH-12055	Fixed spindle, straight base, straight handle	412103
SH-12060	Solid bar, flanged base, straight handle	412104
SH-12065	Solid bar, straight base, straight handle	412105
SH-12070	Fixed spindle, flanged base, T-handle	412106
SH-12075	Fixed spindle, straight base, T-handle	412107
SH-12080	Solid bar, flanged base, T-handle	412108
SH-12050-U	U-bar, flanged base, straight handle	412110

Toggle Clamps & Accessories

(continued)

Vertical Handle Toggle Clamps

- Holding capacity: 340 kg (750 lbs) maximum
- Weight: 624 g (1 lb, 6 oz)
- Handle moves 58°, bar 105°
- Accepts all 3/8-16 diameter spindles
- U-Bar supplied with two flanged washers
- Solid bar supplied (spindle not included)
- Vinyl hand grip

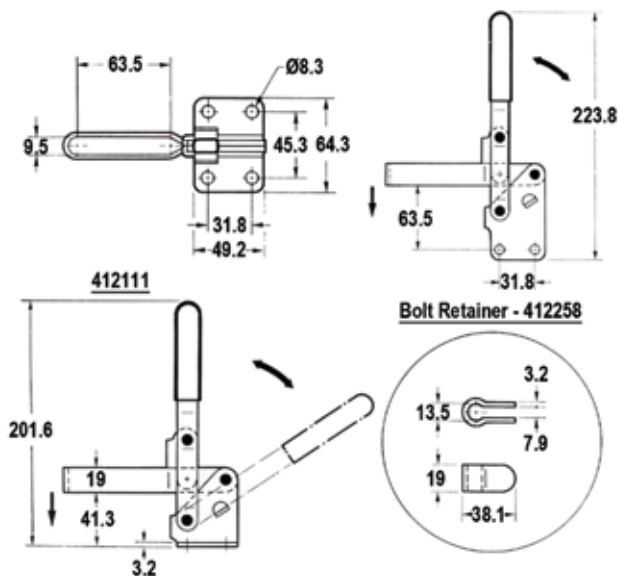

Model	Description	Code
12265	U-bar, flanged base, straight handle	412111
12275	Solid bar, flanged base, straight handle	412113
12280	Solid bar, straight base, straight handle	412114

Vertical Handle Toggle Clamps

- Heavy duty
- Compact size
- Two stops provide user with a choice of handle and bar movement
- Holding capacity: 450 kg (1000 lbs) maximum
- Weight: 1250 g (44 oz)
- Handle moves 58°, bar 100° (with roll pin)
- Handle moves 70°, bar 135° (without roll pin)
- Accepts all 1/2 - 13 diameter spindles
- U-Bar supplied with two flanged washers
- Solid bar (spindle not included)
- Vinyl hand grip
- Hardened bushings
- Removable ground pins

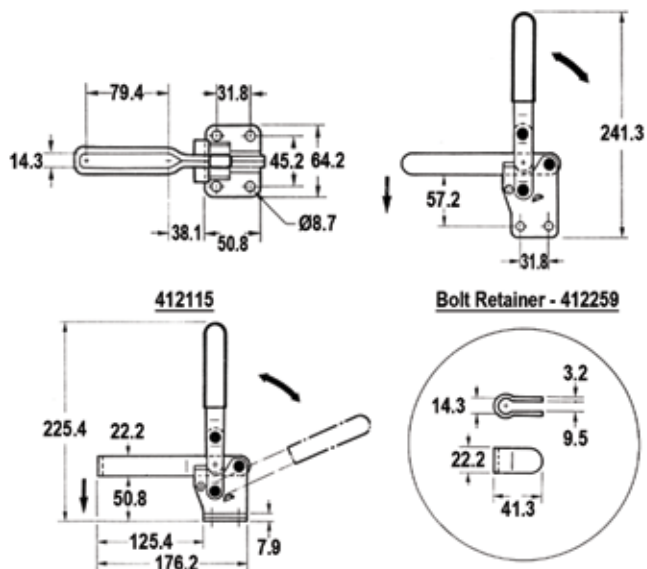

Model	Description	Code
10247	U-bar, flanged base, straight handle	412115
10249	Solid bar, flanged base, straight handle	412117
10250	Solid bar, straight base, straight handle	412118

Toggle Clamps & Accessories

(continued)

Vertical Handle Toggle Clamps

- Holding capacity: 227 kg (500 lbs) maximum
- Handle moves 60°, bar 100°
- Accepts all 5/16-18 diameter spindles
- U-Bar supplied with two flanged washers
- Vinyl hand grip

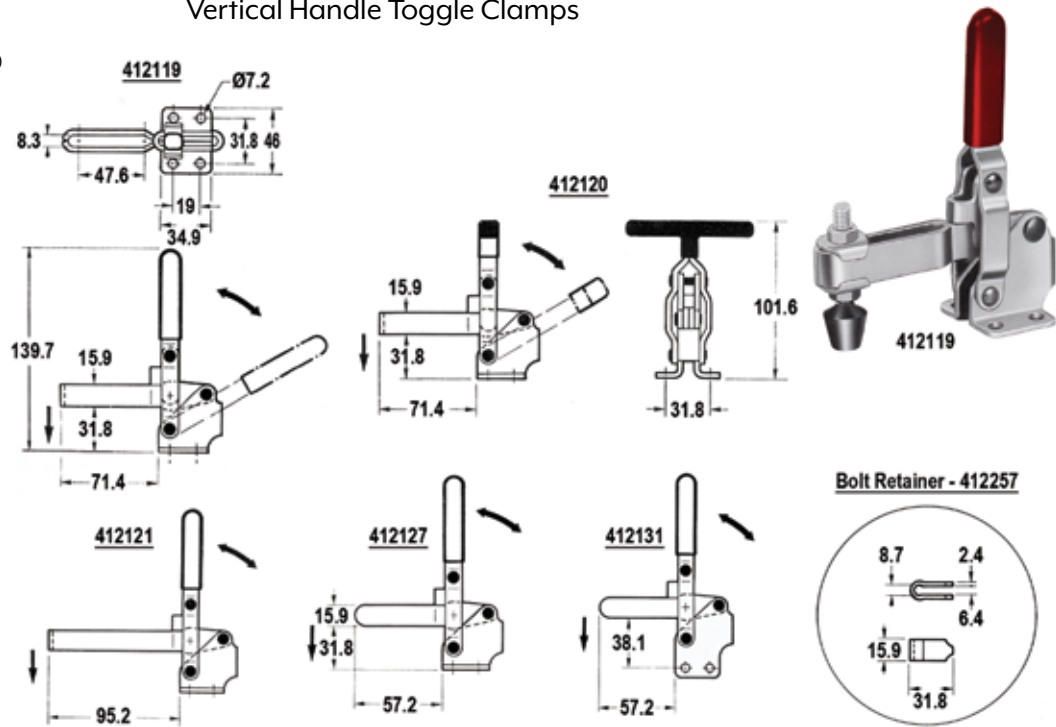

Model	Description	Weight g (oz)	Code
12130	Short U-bar, flanged base, straight handle	355 (12.5)	412119
12131	Short U-bar, flanged base, T-handle	370 (13)	412120
12132	Long U-bar, flanged base, straight handle	370 (13)	412121
12137	Long U-bar, straight base, straight handle	370 (13)	412125
12138	Long U-bar, straight base, T-handle	400 (12.5)	412126
12140	Short solid bar, flanged base, straight handle	340 (12)	412127
12143	Long solid bar, flanged base, T-handle	375 (13)	412130
12145	Short solid bar, straight base, straight handle	340 (12)	412131

Vertical Handle Toggle Clamp with Vertical Mount

- Holding capacity: 90 kg (200 lbs)
- Weight: 115 g (4 oz)
- U-bar
- Vertical mounting straight base
- Vertical handle
- Neoprene tipped
- Vinyl hand grip

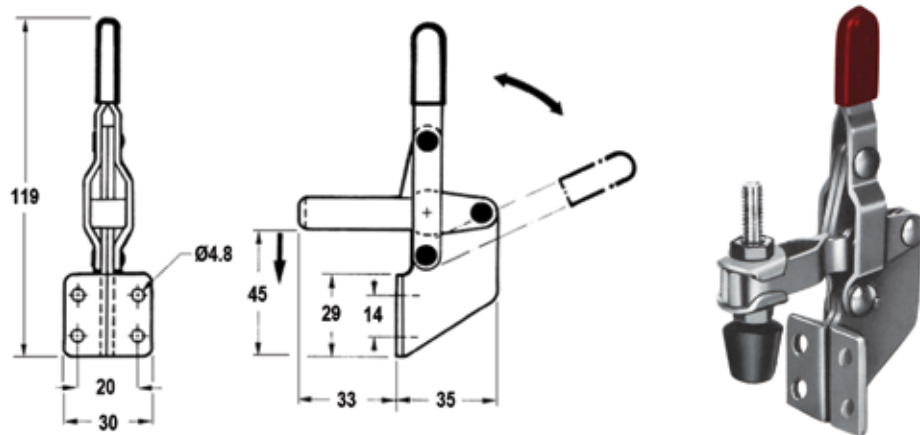

Model	Description	Code
101B	U-bar, vertical mount, straight handle	412175

Toggle Clamps & Accessories

(continued)

Horizontal Handle Toggle Clamps with Vertical Mount

- Holding capacity: 217 kg (480 lbs)
- Weight: 315 g (11 oz)
- U-bar
- Straight base, vertical mounting
- Horizontal handle
- Neoprene tipped
- Vinyl hand grip

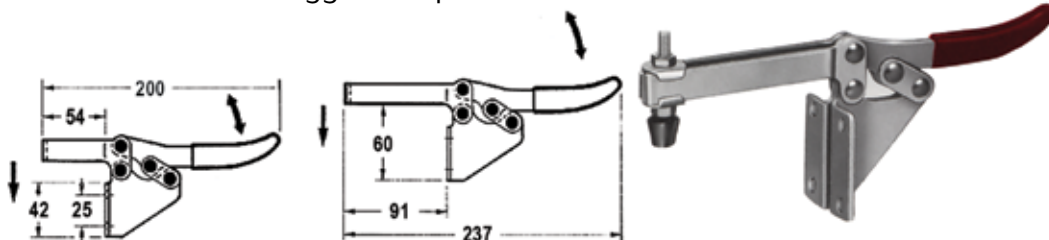

Model	Description	Code
202F	U-bar, vertical mount, straight handle	412180
202FL	Long U-bar, vertical mount, straight handle	412181

Horizontal Handle Toggle Clamps

- Low Profile
- Holding capacity: 90 kg (200 lbs) maximum
- Weight: 130 g (4.6 oz.)
- Handle moves 60°, bar 85°
- Neoprene tipped
- Solid bar
- Vinyl hand grip

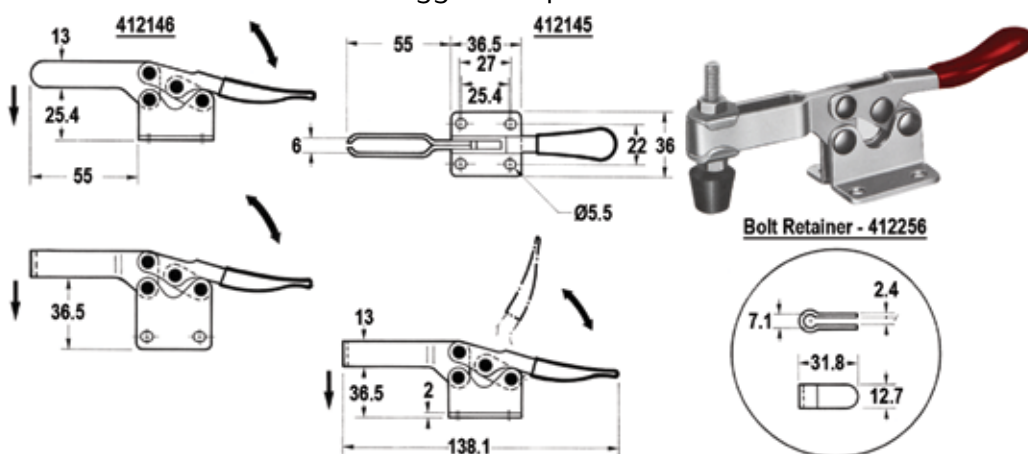

Model	Description	Code
201B	U-bar, flanged base	412145
201BI	U-bar, straight base	412146
201BS	Solid bar, flanged base	412147

Horizontal Handle Toggle Clamps

- Low Profile
- Holding capacity: 340 kg (750 lbs) maximum
- Weight: 640 g (22.6 oz)
- Handle moves 50°, bar 85°
- Neoprene tipped
- Vinyl hand grip

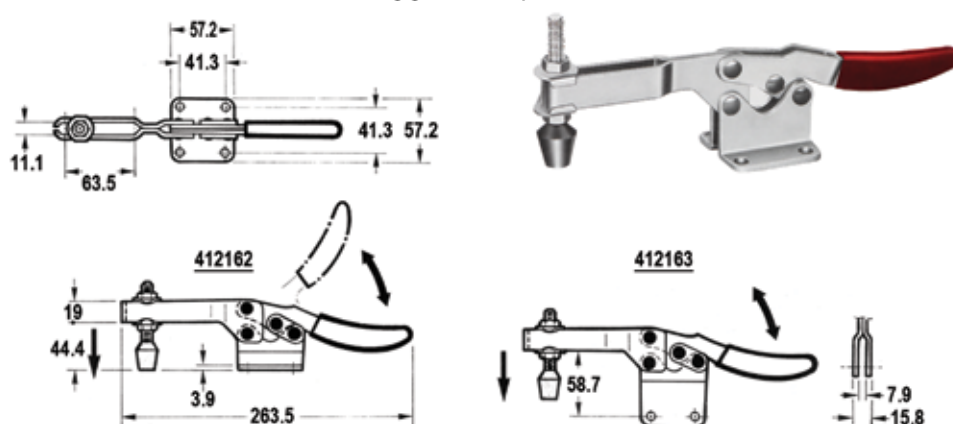

Model	Description	Code
20235	U-bar, flanged base	412162
20236	U-bar, straight base	412163

Toggle Clamps & Accessories

(continued)

Horizontal Handle Toggle Clamps

- Compact size
- Low profile
- Holding capacity: 227 kg (500 lbs) maximum
- Weight: 265 g (9.4 oz)
- Handle moves 65°, bar 90°
- Neoprene tipped
- Vinyl hand grip

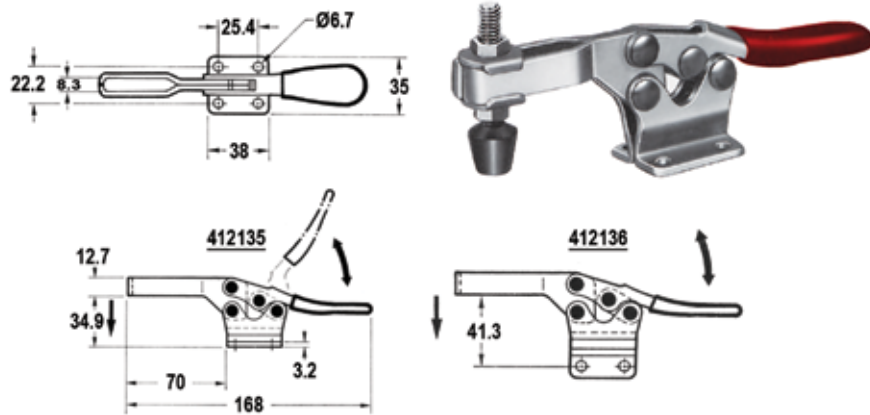

Model	Description	Code
225D	U-bar, flanged base	412135
225DI	U-bar, straight base	412136

Horizontal Handle Toggle Clamps

- Miniature size
- Low profile
- Holding capacity: 27 kg (60 lbs) maximum
- Weight: 43 g (1-1/2 oz)
- Handle moves 80°, bar 90°
- Nylon spindle
- Vinyl hand grip

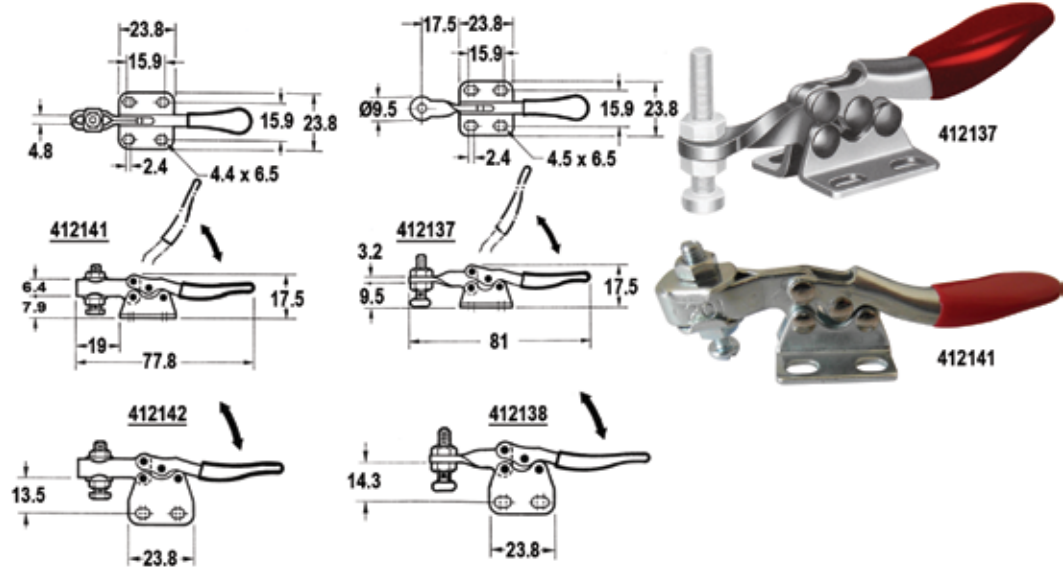

Model	Description	Code
201A	Solid bar, flanged base	412137
201A-1	Solid bar, straight base	412138
201AL	Solid bar, left hand flanged base	412139
201AR	Solid bar, right hand flanged base	412140
201	U-bar, flanged base	412141
201-1	U-bar, straight base	412142

Toggle Clamps & Accessories

(continued)

Horizontal Handle Toggle Clamps – Latch Style

- Holding capacity: Model 40323 – 163.6 kg (360 lbs) maximum; Model 431 – 318 kg (700 lbs) maximum; Model 40341 – 900 kg (2000 lbs) maximum
- Weight: Model 40323 – 70.9 g (2.5 oz); Model 431 – 225 g (8 oz); Model 40341 – 680 g (1 lb, 8 oz)
- Latch plate
- Vinyl hand grip

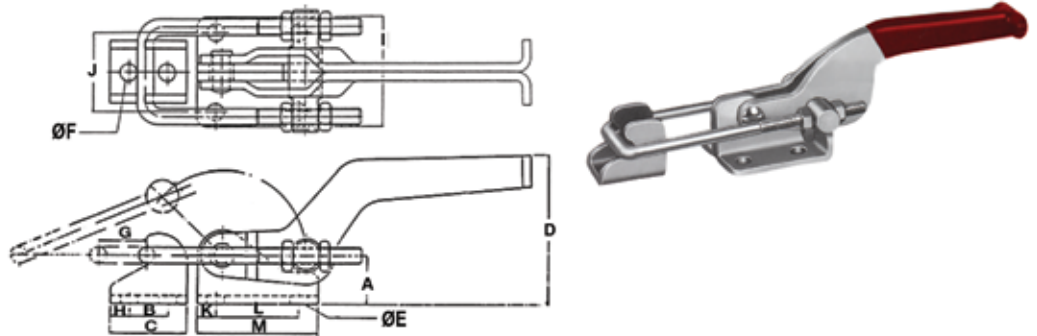

Model	A Inch (mm)	B Inch (mm)	C Inch (mm)	D Inch (mm)	E Inch (mm)	F Inch (mm)	G Inch (mm)	H Inch (mm)	I Inch (mm)	J Inch (mm)	K Inch (mm)	L Inch (mm)	M Inch (mm)	Code
40323	15/32 (12)	25/64 (9.9)	25/32 (19.8)	1-5/32 (29.3)	11/64 (4.4)	11/64 (4.4)	25/64 (9.9)	15/64 (6)	1-7/64 (28.2)	3/4 (19)	13/64 (5.2)	5/8 (15.9)	1-1/32 (26.2)	412157
431	21/32 (16.7)	29/64 (11.5)	1 (25.4)	1-5/8 (41.3)	17/64 (6.7)	1/4 (6.3)	3/8 (9.6)	17/64 (6.8)	1-3/4 (44.5)	1-1/4 (31.8)	1/4 (6.4)	3/4 (19)	1-9/16 (39.7)	412158
40341	59/64 (23.4)	3/4 (19.1)	1-1/2 (38.1)	2-29/32 (74)	11/32 (8.6)	21/64 (8.5)	15/16 (23.8)	3/8 (9.5)	2-1/8 (54)	1-1/2 (38.1)	3/8 (9.5)	1-5/8 (41.3)	2-3/8 (60.3)	412159

Vertical Handle Toggle Clamps – Latch Style

- Holding capacity: Model 40334 – 205 kg (450 lbs) maximum; Model 40344 – 409 kg (900 lbs) maximum
- Weight: Model 40334 – 250 g (9 oz); Model 40344 – 900 g (2 lbs)
- Latch plate
- Vinyl hand grip

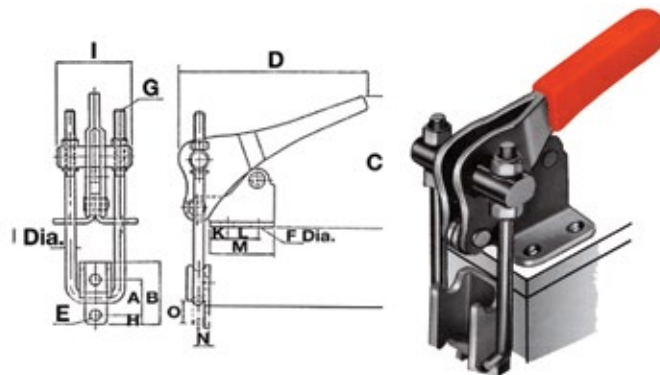

Model	A (mm)	B (mm)	C (mm)	D (mm)	E (mm)	F (mm)	G (mm)	H (mm)	I (mm)	J (mm)	K (mm)	L (mm)	M (mm)	N (mm)	O (mm)	P (mm)	Code
40334	20.6	38.1	61.9	120	5.6	7.1	M6 x 1	7.1	41.3	6.35	7.1	19.1	33.3	8.7	17.5	102	412186
40344	27	54	84.1	130.2	8.7	8.7	M8 x 1.25	9.5	60.3	7.9	7.9	31.8	47.6	12.7	28.6	150	412187

Toggle Clamps & Accessories

(continued)

Latch Toggle Clamps – Hook Style

- Holding capacity: Model 451 – 170 kg (374 lbs) maximum; Model 40371 – 340 kg (750 lbs) maximum
- Weight: Model 451 – 270 g (10 oz); Model 40371 – 624 g (1 lb, 6 oz)
- Vinyl hand grip

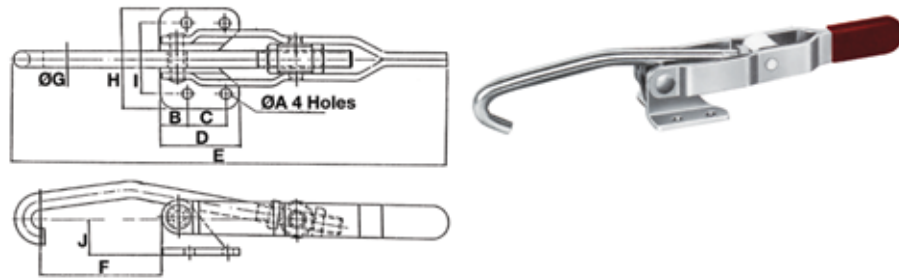

Model	A Inch (mm)	B Inch (mm)	C Inch (mm)	D Inch (mm)	E Inch (mm)	F Inch (mm)	G Inch (mm)	H Inch (mm)	I Inch (mm)	J Inch (mm)	Code
451	7/32 (5.6)	1/2 (12.7)	3/4 (19)	1-1/2 (38.1)	8-5/16 (211.1)	2-5/16 (58.7)	5/16 (8)	1-15/16 (49.2)	1-3/8 (34.9)	3/4 (19)	412160
40371	11/32 (8.7)	5/16 (7.9)	1-1/4 (31.8)	1-7/8 (47.6)	11-1/4 (285.8)	3-1/8 (79.4)	3/8 (9.5)	2-19/32 (65.7)	1-15/16 (49.2)	1-25/64 (35.32)	412161

Push/Pull Toggle Clamps

- Holding capacity: Model 36202 – 91 kg; Model 36204 – 136 kg; Model 36206 – 318 kg
- Weight: Model 36202 – 113 g; Model 36204 – 270 g; Model 36206 – 690 g
- Plunger clamp with threaded collar for mounting through panels or plates
- Plunger locks in extended or retracted position
- Vinyl hand grip and jam nut

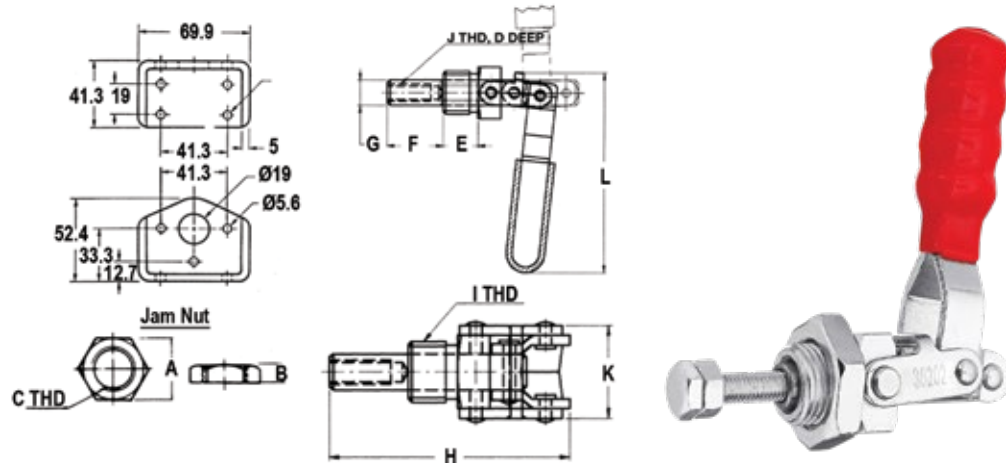

Model	Plunger Travel (mm)	A (mm)	B (mm)	C Thread	D (mm)	E (mm)	F (mm)	ØG (mm)	H (mm)	I Thread	J Thread	K (mm)	L (mm)	Code
36202	19.0	23	6.4	5/8-18	15.80	12.7	20.6	9.4	63	5/8-18	1/4-20	26	76	412167
36204	38.0	30	6.4	3/4-16	25.40	15.9	39.7	11.0	1.5	3/4-16	5/16-18	30	99	412168
36206	66.8	41	6.4	1-14	31.75	22.0	69.0	15.8	169.5	1-14	3/8-16	37	127	412169

Toggle Clamps & Accessories

(continued)

Push/Pull Toggle Clamps

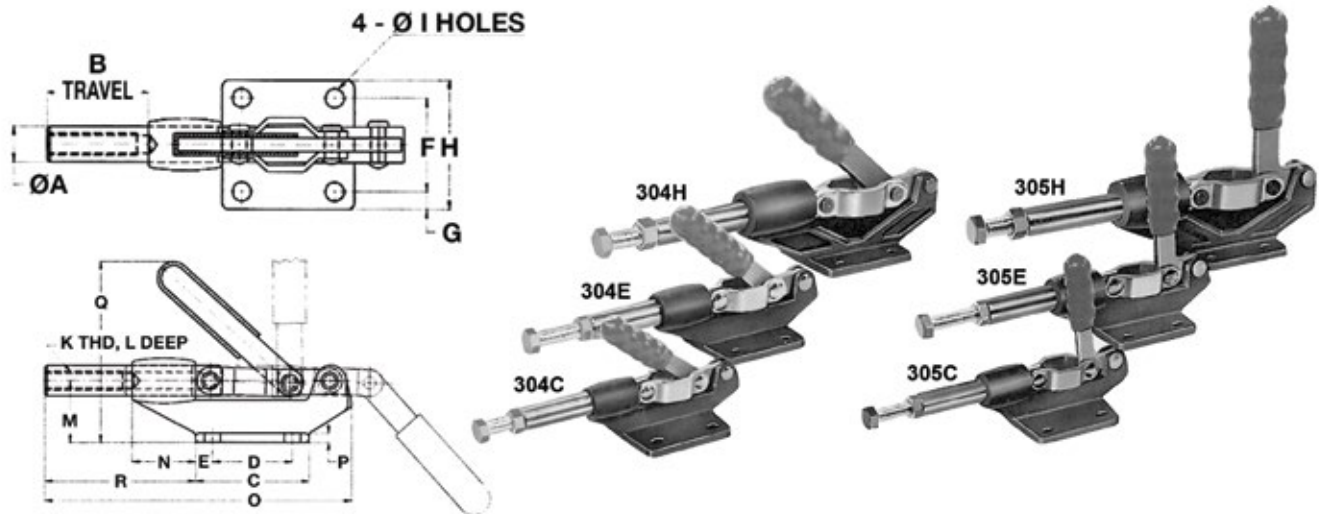

- Available for light, medium, or heavy duty operations
- Supplied with a ductile iron base which is precision machined for flatness
- Close tolerances between the base and plunger allow clamps to be used for pin location gages as well as clamping devices
- Plunger locks in extended or retracted position
- Light and medium duty clamps are supplied with heavy duty rivets
- Heavy duty clamps are supplied with bushings and removable hardened ground pins
- Vinyl hand grip (spindles not included)

Model	A mm Inch	B mm Inch	C mm Inch	D mm Inch	E mm Inch	F mm Inch	G mm Inch	H mm Inch	I mm Inch	J mm Inch	K Thread	L mm Inch	M mm Inch	N mm Inch	O mm Inch	P mm Inch	Q mm Inch	R mm Inch
304C	12.7 1/2	30.2 1-3/16	52.4 2-1/16	35 1-3/8	8.7 11/32	41.4 1-5/8	8 5/16	57.2 2-1/4	6.7 17/64	6.4 1/4	5/16 - 18	30.2 1-3/16	25.4 1	20.6 13/16	125.4 4-15/16	4.8 3/16	74.6 2-15/16	52.4 2-1/16
305C	12.7 1/2	30.2 1-3/16	52.4 2-1/16	35 1-3/8	8.7 11/32	41.4 1-5/8	8 5/16	57.2 2-1/4	6.7 17/64	6.4 1/4	5/16 - 18	30.2 1-3/16	25.4 1	20.6 13/16	125.4 4-15/16	4.8 3/16	90.5 3-9/16	52.4 2-1/16
304E	16 5/8	41.4 1-5/8	58.8 2-5/16	41.4 1-5/8	8.7 11/32	41.4 1-5/8	8 5/16	57.2 2-1/4	8.3 21/64	8 5/16	3/8 - 16	39.7 1-9/16	31.8 1-1/4	31.8 1-1/4	158.8 6-1/4	4.8 3/16	98.4 3-7/8	81 3-3/16
305E	16 5/8	41.4 1-5/8	58.8 2-5/16	41.4 1-5/8	8.7 11/32	41.4 1-5/8	8 5/16	57.2 2-1/4	8.3 21/64	8 5/16	3/8 - 16	39.7 1-9/16	31.8 1-1/4	31.8 1-1/4	158.8 6-1/4	4.8 3/16	122.2 4-13/16	81 3-3/16
304H	19 3/4	60.4 2-3/8	73.2 2-7/8	50.8 2	11.1 7/16	50.8 2	10.3 13/32	71.4 2-11/16	8.3 21/64	8 5/16	1/2 - 13	49.2 1-15/16	50.8 2	50.8 2	238.2 9-3/8	6.4 1/4	133.4 5-1/4	120.8 4-3/4
305H	19 3/4	60.4 2-3/8	73.2 2-7/8	50.8 2	11.1 7/16	50.8 2	10.3 13/32	71.4 2-11/16	8.3 21/64	8 5/16	1/2 - 13	49.2 1-15/16	50.8 2	50.8 2	238.2 9-3/8	6.4 1/4	171.6 6-3/4	120.5 4-3/4

Model	Holding Capacity kg (lbs)	Weight g (oz)	Handle Angle	Code
304C	227 (500)	340 (12)	45°	412151
305C	227 (500)	340 (12)	90°	412152
304E	386 (850)	580 (20.5)	45°	412153
305E	386 (850)	580 (20.5)	90°	412154
304H	680 (1500)	1480 (52.2)	45°	412155
305H	680 (1500)	1480 (52.2)	90°	412156

CLAMPING
COMPONENTS

Toggle Clamps & Accessories

(continued)

Push/Pull Toggle Clamp – Flanged

- Heavy duty
- Plunger locks in extended or retracted position
- Accepts 1/2" - 13 spindles (spindle not included)
- Vinyl hand grip

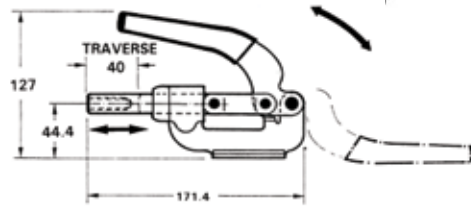
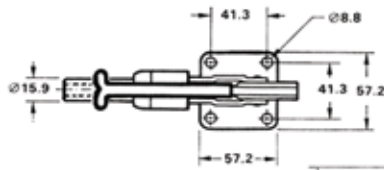

Holding Capacity Maximum kgs (lbs)	Weight g (oz)	Plunger Travel mm (Inch)	Code
364 (800)	800 (28.2)	41.4 (1-5/8)	412150

Toggle Pliers

- Improved handle design for operator comfort
- Hex head spindle assembly

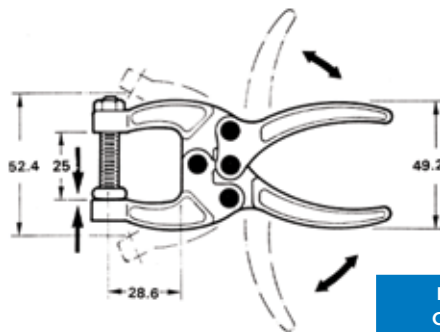
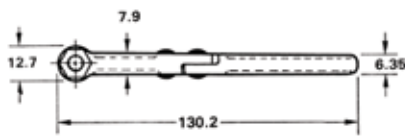

Holding Capacity Maximum kgs (lbs)	Weight g (oz)	Code
90 (200)	185 (6.5)	412165

Toggle Pliers

- Improved handle design for operator comfort
- Hex head spindle assembly

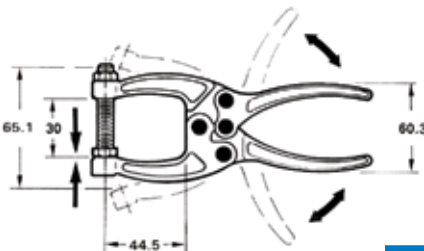

Holding Capacity Maximum kgs (lbs)	Weight g (oz)	Code
159 (350)	290 (10.2)	412166

Toggle Clamps & Accessories

(continued)

Adjustable Spindle Assembly
Flat Cushion Top Bonded Neoprene Cap



Model	Description	Code
FC-10138	10-24 x 1-3/8	412200
FC-14134	1/4-20 x 1-3/4	412201
FC-14218	1/4-20 x 2-1/8	412202
FC-56212	5/16-18 x 2-1/2	412203
FC-56300	5/16-18 x 3	412204
FC-38312	3/8-16 x 3-1/2	412205
FC-38412	3/8-16 x 4-1/2	412206

Adjustable Spindle Assembly
Standard Adjustable



Model	Description	Code
SA-08034	8-32 x 3/4 (Nylon)	412210
SA-10118	10-24 x 1-1/8	412211
SA-14112	1/4-20 x 1-1/2	412212
SA-14134	1/4-20 x 1-3/4	412213
SA-56200	5/16-18 x 2	412214
SA-56212	5/16-18 x 2-1/2	412215
SA-38300	3/8-16 x 3	412216
SA-38400	3/8-16 x 4	412217
SA-12300	1/2-13 x 3	412218
SA-12412	1/2-13 x 4-1/2	412219
SA-58500	5/8-11 x 5	412220

Adjustable Spindle Assembly
Pointed Tip Bonded Neoprene Cap



Model	Description	Code
CC-10138	10-24 x 1-3/8	412221
CC-14134	1/4-20 x 1-3/4	412222
CC-14218	1/4-20 x 2-1/8	412223
CC-56212	5/16-18 x 2-1/2	412224
CC-38312	3/8-16 x 3-1/2	412225

Adjustable Spindle Assembly
Model SF



Model	Description	Code
SF-14214	1/4-20 x 2-1/4	412230
SF-56234	5/16-18 x 2-3/4	412231
SF-38300	3/8-16 x 3	412232

Toggle Clamp Reference Chart

Major Brand Crossover

Description	KAR Code	Kakuta	Destaco	Carr Lane	Jergens
101A Toggle Clamp	412101	HV150	201-U	CL-150-VTC	70310
12050 Toggle Clamp	412102	HV250	202	CL-250-VTC	70330
12055 Toggle Clamp	412103	HV251-B	202-B	CL-251-VTC	70335
12060 Toggle Clamp	412104	-	-	-	-
12065 Toggle Clamp	412105	-	-	-	-
12070 Toggle Clamp	412106	HV252-T	202-T	CL-252-VTC	70340
12075 Toggle Clamp	412107	HV251-BT	202-TB	-	71016
12080 Toggle Clamp	412108	-	-	-	-
SH-12050-U Toggle Clamp	412110	HV250-U	202-U	-	70342
SH-12265 Toggle Clamp	412111	HV650	210-U	CL-650-VTC	70440
12270 Toggle Clamp	412112	HV651-B	210-UB	CL-651-VTC	70445
12275 Toggle Clamp	412113	HV550	210-S	CL-550-VTC	70420
12280 Toggle Clamp	412114	HV551-B	210-SB	CL-551-VTC	70425
10247 Toggle Clamp	412115	HV850	247-U	CL-850-VTC	70470
10249 Toggle Clamp	412117	HV750	247-S	CL-750-VTC	70460
10250 Toggle Clamp	412118	HV751-B	247-SB	CL-751-VTC	71030
12130 Toggle Clamp	412119	HV450	207-U	CL-450-VTC	70380
12131 Toggle Clamp	412120	HV452-T	207-TU	CL-452-VTC	70390
12132 Toggle Clamp	412121	HV453-L	207-UL	CL-453-VTC	70395
12137 Toggle Clamp	412125	HV451-BL	207-ULB	-	71025
12138 Toggle Clamp	412126	HV451-BTL	207-TULB	-	71026
12140 Toggle Clamp	412127	HV350	207-S	CL-350-VTC	70350
12142 Toggle Clamp	412129	HV353-L	207-L	CL-353-VTC	70365
12143 Toggle Clamp	412130	HV352-TL	207-TL	-	71023
12145 Toggle Clamp	412131	HV351-B	207-SB	CL-351-VTC	70355
225D Toggle Clamp	412135	HH450	225-U	CL-450-HTC	70250
GH-225-DI Toggle Clamp	412136	HH451-B	225-UB	CL-451-HTC	70255
GH201-A Toggle Clamp	412137	HH150	205-S	CL-150-HTC	70210
201AI Toggle Clamp	412138	HH151-B	205-SB	CL-151-HTC	70215
201AL Toggle Clamp	412139	HH154-LE	205-SL	CL-153-HTC	70211
201AR Toggle Clamp	412140	HH155-R	205-SR	CL-152-HTC	71001
201 Toggle Clamp	412141	HH250	205-U	CL-250-HTC	70230
201-I Toggle Clamp	412142	HH250-B	205-UB	CL-251-HTC	70235
201-R Toggle Clamp	412144	HH255-R	205-UR	CL-252-HTC	71003
GH-201 B Toggle Clamp	412145	HH350	215-U	CL-350-HTC	70240
201BI Toggle Clamp	412146	HH351-B	215-UB	CL-351-HTC	70245
GH-201-BS Toggle Clamp	412147	HH350-S	215-S	CL-300-HTC	71008
201-BSI Toggle Clamp	412148	HH351-SB	215-SB	-	71009
36010 Push/Pull Clamp	412150	SL250	610	CL-250-SPC	70840
304C Push/Pull Clamp	412151	SL100	603	CP-100-PC	70810
305C Push/Pull Clamp	412152	-	-	-	-
304E Push/Pull Clamp	412153	SL200	608	CL-200-PC	70830
305E Push/Pull Clamp	412154	-	-	-	-
304H Push/Pull Clamp	412155	SL300	-	CL-300-PC	70850
305H Push/Pull Clamp	412156	-	-	-	-
GH-40323 Latch Clamp	412157	FA100	323	CL-100-PA	70558
GH-431 Latch Clamp	412158	FA200	331	CL-200-PA	70560
GH-40341 Latch Clamp	412159	FA300	341	CL-300-PA	70562
451 Latch Clamp	412160	PA250	351	CL-250-PA	70570
GH-40371 Latch Clamp	412161	PA270	371	-	-
GH-20235 U-Bar Flanged Base	412162	HH550	235-U	CL-550-HTC	-
20236 Toggle Clamp	412163	HH551-BN	235-UB	-	-
50350 Toggle Clamp	412165	SA150	424	CL-50-PL	70710
50360 Toggle Clamp	412166	SA250	441	CL-150-PL	70720

Toggle Clamp Reference Chart

Major Brand Crossover (continued)

Description	KAR Code	Kakuta	Destaco	Carr Lane	Jergens
36202 Toggle Clamp	412167	FM50	602	CL-150-TPC	70118
36204 Toggle Clamp	412168	FM150	604	CL-250-TPC	70120
36206 Toggle Clamp	412169	FM250	624	CL-350-TPC	70140
101B Toggle Clamp	412175	-	-	-	-
202F Toggle Clamp	412180	-	-	-	-
202FL Toggle Clamp	412181	-	-	-	-
40334 Toggle Clamp	412186	FA230	334	CL-210-PA	71042
40344 Toggle Clamp	412187	FA330	344	CL-310-PA	70565

F-Clamps

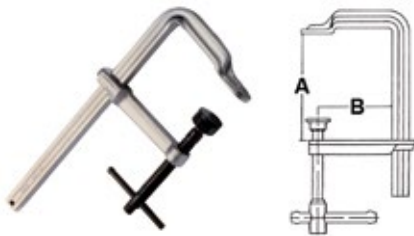

- Material: ANSI 1045 medium carbon steel, chrome plated
- Hardness: HRC 36±2
- T-handle
- P-type pad

Medium Duty 2400

A Span (Inch)	B Span (Inch)	Rail Thickness (Inch)	Weight (lbs)	Code
10	4.75	1.06 x 0.51	4.6	412330
12	4.75	1.06 x 0.51	4.9	412331
16	4.75	1.06 x 0.51	5.4	412332
20	4.75	1.06 x 0.51	6.0	412333
24	4.75	1.06 x 0.51	6.1	412334

Heavy Duty 4600

A Span (Inch)	B Span (Inch)	Rail Thickness (Inch)	Weight (lbs)	Code
12	5.50	1.18 x 0.59	6.7	412340
16	4.75	1.18 x 0.59	7.1	412341
20	5.50	1.18 x 0.59	8.1	412342
24	4.75	1.18 x 0.59	9.1	412343

Extra Heavy Duty

A Span (Inch)	B Span (Inch)	Rail Thickness (Inch)	Weight (lbs)	Code
12	7.00	1.57 x 0.79	12	412350

Clamping Pads

Three types of replacement clamping pads:

- P: For general purpose
- R: For cold work purpose
- V: For clamping round pipes or round bars

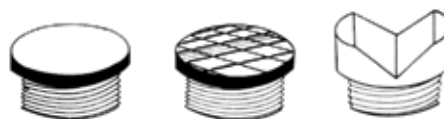

Type	Medium Duty	Heavy Duty
	Code	Code
P	412360	412364
R	412361	412365
V	412362	412366

C-Clamps

Standard & Heavy Duty



- Steel forged



- Steel forged
- Heat-treated

Capacity (Inch)	Throat Depth (Inch)	Minimum Proof Test (lbs)	Weight (lbs)	Standard Duty	Heavy Duty
				Code	Code
0-1	0.945	2860	0.5	416161	-
0-2	1.220	4400	0.9	416162	416172
0-3	1.575	6160	1.8	416163	416173
0-4	2.008	6600	2.8	416164	416174
0-5	2.441	7260	4.2	416165	-
0-6	2.756	7920	7.1	416166	416176
0-8	3.701	13200	10.0	416167	416177
0-10	4.724	15400	13.8	416168	416178
0-12	4.921	17600	20.7	416169	416179

Industrial Drill Chucks & Key

For Stationary & Portable Drilling Machines



- Specifically designed for stationary drilling, turning, milling and wood working machines
- The one-piece gear ring and sleeve eliminate the possibility of tooth breakage
- The jaws, gear ring and body are all totally hardened to avoid wear and lengthen the life of the drill chuck
- Fits tools of up to 19mm (3/4") in diameter
- Machine fitting via DIN238 of JACOBS tapers
- Wide range of accessories

Model	Capacity (mm)	Capacity (Inch)	Mount	Diameter (mm)	Length Closed (mm)	Length Open (mm)	Weight (g)	Code
CY-04 J0	0.8-4	1/64-5/32	J-0	22	29	36	100	827812
CY-04 R-5/16	0.8-4	1/32-5/32	5/16" x 24	22	38	44	130	827826
CY-06 R-3/8	0.8-6.5	1/32-1/4	3/8" x 24	32	42	52	220	827821
CY-06 R-3/8 SP *	0.8-6.5	1/32-1/4	3/8" x 24	37	51	63	340	827827
CY-10 J-1	1-10	1/32-3/8	J-1	37	51	60	310	827815
CY-10 J-2	1-10	1/32-3/8	J-2	37	51	60	300	827816
CY-10 R-3/8	1-10	1/32-3/8	3/8" x 24	37	51	60	300	827829
CY-10 R-3/8 SP *	1-10	1/32-3/8	3/8" x 24	43	53	68	420	827828
CY-10 R-1/2	1-10	1/32-3/8	1/2" x 20	37	51	60	300	827822
CY-10 R-1/2 SP *	1-10	1/32-3/8	1/2" x 20	43	53	68	420	827831
CY-13 J-6	1-13	1/32-1/2	J-6	46	62	77	480	827806
CY-13 J-33	1-13	1/32-1/2	J-33	46	62	77	480	827817
CY-13 J-33 KD (1)	1-13	1/32-1/2	33JT	46	71	86	500	827819
CY-13 R-3/8	1-13	1/32-1/2	3/8" x 24	46	62	77	500	827833
CY-13 R-1/2	1-13	1/32-1/2	1/2" x 20	46	62	77	480	827832
CY-13 R-5/8	1-13	1/32-1/2	5/8" x 16	46	62	77	490	827834
CYX-13 J-2 *	1-13	1/32-1/2	J-2	53	69	89	760	827805
CYX-13 J-33 *	1-13	1/32-1/2	J-33	53	69	89	750	827807
CYX-13 J-33C (3)	1-13	1/32-1/2	33JT	53	86	106	820	827808
CY-16 J-6	1-16	1/32-5/8	J-6	57	77	95	970	348120
CY-16 J-33	1-16	1/32-5/8	J-33	57	77	95	980	348126
CY-16 J-3	1-16	1/32-5/8	J-3	57	77	95	940	348118
CY-16 J-3 KD (1)	1-16	1/32-5/8	3JT	57	85	102	980	827803
CY-16 J-3 PD (2)	1-16	1/32-5/8	3JT	57	85	102	980	827804
CY-16 R-1/2	1-16	1/32-5/8	1/2" x 20	57	77	95	990	827823
CY-16 R-5/8	1-16	1/32-5/8	5/8" x 16	57	77	95	1,000	827820
CY-19 J-3	3-19	13/64-3/4	J-3	65	85	110	1,440	827809
CY-19 J-3 KD (1)	3-19	13/64-3/4	3JT	65	89	116	1,400	827810
CY-19 J-3 PD (2)	3-19	13/64-3/4	3JT	65	89	116	1,360	827811
CY-19 J-4	3-19	13/64-3/4	J-4	68	97	120	1,500	348132

* Extra heavy duty model

- (1) Equipped with positive drive slot
- (2) Equipped with pin type positive drive
- (3) Equipped with locking collar

Ball-Bearing Drill Chucks & Key

For Production Drilling Equipment



- Drill chuck with key for industrial applications that require the toughest machining conditions
- Equipped with ball bearings to reduce friction in the tightening mechanism and provide a better grip on the drill shaft
- All the pieces are hardened and ground
- The one-piece gear ring and sleeve eliminate the possibility of tooth breakage
- Fits tools up to 25mm (1")
- Machine fitting via JACOBS taper

Model	Capacity (mm)	Capacity (Inch)	Mount	Diameter (mm)	Length Closed (mm)	Length Open (mm)	Weight (g)	Code
CBB-13 J3	1-13	1/32-1/2	J-3	62	75	94	1,115	348144
CBB-16 J3	1-16	1/32-5/8	J-3	67	81	102	1,470	348145
CBB-19 J4	1-19	1/32-3/4	J-4	75	99	125	2,145	348146
CBB-25 J5	5-25	13/64-1	J-5	93	112	147	3,645	348147

Chuck Keys

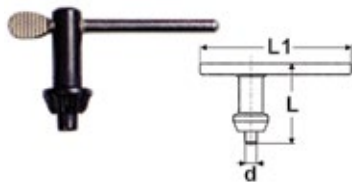

Key	Jacobs Key Reference	d (mm)	L (mm)	L1 (mm)	Code
S8	K30	6.00	41	80	348148
S9	K32	6.35	45	83	348149
S10	K3	8.00	48	100	348150
S13	K4	9.50	70	110	348208

Chuck Keys



Model	Code	Model	Code
K0	350K0	K4	350K4
K1	350K1	K5	350K5
K2	350K2	K7	350K7
K3	350K3	K30	350K30
		K32	350K32

Keyless Drill Chucks



Classic



- Keyless operation
- Self-tightening design
- Balanced

Capacity (Inch)	Capacity (mm)	Mount	Maximum RPM	Weight (lbs)	Code
0 - 1/16	0 - 1.5	J0	50000	0.1	827901
0 - 1/8	0 - 3	J0	35000	0.2	827902
0 - 1/8	0 - 3	J1	35000	0.2	827903
0 - 1/4	0 - 6.5	J1	20000	0.7	827904
0 - 3/8	0 - 10	J33	12000	1.4	827905
0 - 3/8	0 - 10	J2	12000	1.4	827906
1/32 - 1/2	1 - 13	J33	7000	2.1	827907
1/32 - 1/2	1 - 13	J2	7000	2.1	827908
1/32 - 1/2	1 - 13	J6	7000	2.1	827909
1/8 - 5/8	3 - 16	J6	4000	2.8	827910

Keyless Drill Chucks



For Portable Drilling Machines



- Ideal for portable electric or battery operated drilling machines
- Does not require a chuck key for tightening or loosening, enabling production increase
- Ergonomic design, using materials which eliminate the possibility of oxidation
- Fits any type of drill, via UNF thread, male and female
- Wide range of accessories

Model	Capacity (mm)	Capacity (Inch)	Mount	Diameter (mm)	Length Closed (mm)	Length Open (mm)	Weight (g)	Code
CPL-10 R-3/8	1-10	1/32-3/8	3/8" x 24 UNF	41	57	65	180	348134

Threaded Mount for Portable Drilling Machines & Taper Mount for Stationary Machines



- Standard screw thread mount for portable drilling machines
- Standard tapered mount for stationary drilling machines
- Self-tightening mechanism automatically increases the clamping forces in proportion to the increase in torque during the drilling operation. This prevents tool slippage in clockwise rotation.
- Tool capacity of up to 3/4" in diameter

Threaded Mount

Model	Capacity (Inch)	Mount	Diameter (Inch)	Length Closed (Inch)	Length Open (Inch)	Code
L40165B	1/32 - 3/8	3/8 - 24	1.457	2.835	3.071	348209
L40166B	1/32 - 3/8	1/2 - 20	1.457	2.835	3.071	348210
L40171B	1/16 - 1/2	3/8 - 24	1.575	2.992	3.268	348211

Taper Mount

Model	Capacity (Inch)	Jacobs Mount	Diameter (Inch)	Length Closed (Inch)	Length Open (Inch)	Code
L40159B	1/64 - 1/4	JT1	1.339	2.480	2.756	348213
L40163B	1/32 - 5/16	JT1	1.457	2.835	3.071	348214
L40164B	1/32 - 5/16	JT2	1.457	2.835	3.071	348215
L40167B	1/32 - 3/8	JT2	1.575	3.110	3.386	348216
L40221B	1/32 - 3/8	JT33	1.575	3.110	3.386	348217
L40168B	1/32 - 1/2	JT2	1.850	3.661	4.055	348218
L40169B	1/32 - 1/2	JT33	1.850	3.661	4.055	348219
L40170B	1/32 - 1/2	JT6	1.850	3.661	4.055	348220
L40173B	1/8 - 5/8	JT33	2.047	3.740	4.134	348221
L40174B	1/8 - 5/8	JT6	2.047	3.740	4.134	348222
L40177B	3/16 - 3/4	JT3	2.520	4.764	5.157	348223

Keyless Drill Chucks with Locking Mechanism

LLAMBRICH

Plastic Body & Carbide Jaw Inserts



- With a locking mechanism, no key is required for closing or opening, for hammer drilling and also screwdriver operations
- Carbide jaw inserts (for 13mm capacity) reduce bit slippage and enhance wear resistance
- Ergonomic design, using materials that eliminate the possibility of rust
- With through hole for clockwise and counter-clockwise rotation
- Supplied with screw M5 (R-3/8") or M6 (R-1/2") to fix chuck to drilling machine
- Fits any type of drill (up to 1000W) via UNF thread, male and female
- Wide range of accessories

Model	Capacity (mm)	Capacity (Inch)	Mount	Diameter (mm)	Length Closed (mm)	Length Open (mm)	Weight (g)	Code
CPX-13 R-3/8	2-13	1/16-1/2	3/8" x 24 UNF	42	65	75	280	348138

Precision Keyless Drill Chucks



Capacity (Inch)	Mount	Code
0 - 1/4	J1	354100
0 - 1/4	3/8-24	354102
0 - 3/8	J2	354106
0 - 3/8	3/8-24	354108
1/32 - 1/2	J6	354112
1/32 - 1/2	J33	354114
1/32 - 1/2	1/2-20	354116
1/8 - 5/8	J6	354120
1/8 - 5/8	5/8-16	354122

Super Precision Keyless Drill Chucks

LLAMBRICH



- Maximum total integrated run-out of 0.04mm
- Self-tightening feature automatically increases gripping force in proportion to increased torque to prevent tool shank slippage (for right-hand rotation applications only)
- Permits use on high accuracy drill presses, jig borers, milling machines and production drilling equipment
- All components exposed to wear are completely hardened to maintain accuracy and extend chuck life
- Also available with through hole for EDM machines upon request

Model	Capacity (mm)	Capacity (Inch)	Mount	Diameter (mm)	Length Closed (mm)	Length Open (mm)	Weight (g)	Code
SP-1.5 J-0	0.2-1.5	0.0008-1/16	J-0	19.4	35	37.3	80	827841
SP-03 J-0	0.3-3	1/64-1/8	J-0	24.5	44	47.5	200	827842
SP-03 J-1	0.3-3	1/64-1/8	J-1	24.5	44	47.5	200	827843
SP-06 J-1	0.3-6.5	1/64-1/4	J-1	33	62	70	360	351099
SP-08 J-1	0.3-8	1/64-5/16	J-1	38	67	74	460	351100
SP-08 J-25	0.3-8	1/64-5/16	J-25	38	67	74	460	351102
SP-10 J-2	0.5-10	1/32-3/8	J-2	43	81	89	720	351104
SP-10 J-33	0.5-10	1/32-3/8	J-33	43	81	89	720	351106
SP-13 J-2	1-13	1/32-1/2	J-2	49	91	103	1,000	351108
SP-13 J-33	1-13	1/32-1/2	J-33	49	91	103	1,000	351110
SP-13 J-6	1-13	1/32-1/2	J-6	49	91	103	1,000	351112
SP-16 J-6	3-16	1/8-5/8	J-6	55	95	107	1,320	351114

Keyless Drill Chucks with Integral Shanks

Classic-Plus



- Integral shank design is more compact than a combined drill chuck and arbor, resulting in greater accuracy, greater rigidity and a larger work envelope
- Integral shank eliminates the possibility of a chuck slipping on its arbor
- Keyless operation
- Self-tightening
- Balanced

Model	Capacity (mm)	Capacity (Inch)	Mount	Diameter (Inch)	Length Closed (Inch)	Length Open (Inch)	Weight (lbs)	Code
CPI30-2MT	1 - 13	1/32 - 1/2	MT2	2	3-3/8	3-7/8	2.3	827911
CPI30-3MT	1 - 13	1/32 - 1/2	MT3	2	3-3/8	3-7/8	2.6	827912
CPI30-4MT	1 - 13	1/32 - 1/2	MT4	2	3-7/16	3-15/16	3.3	827913
CPI30-R8	1 - 13	1/32 - 1/2	R8	2	3-5/16	3-13/16	2.6	827914
CPI30-5/8	1 - 13	1/32 - 1/2	5/8" SS	2	3-1/8	3-5/8	2.2	827915
CPI60-2MT	3 - 16	1/8 - 5/8	MT2	2-1/4	3-1/2	4-1/16	2.9	827916
CPI60-3MT	3 - 16	1/8 - 5/8	MT3	2-1/4	3-1/2	4-1/16	3.3	827917
CPI60-4MT	3 - 16	1/8 - 5/8	MT4	2-1/4	3-9/16	4-1/16	4.0	827918
CPI60-R8	3 - 16	1/8 - 5/8	R8	2-1/4	3-7/16	3-15/16	4.2	827919

Integral Shank Drill Chucks

- Rigid heavy duty design
- High accuracy and high RPM
- Wide gripping capacity
- Self tightening keyless operations
- Provided with wrenches
- Non-coolant through
- Taper shank ground to AT3 accuracy or better

CAT40 & CAT50



- CAT40 draw bar threads: 5/8"-11
- CAT50 draw bar threads: 1"-8
- Max. T.I.R. 0.0004"

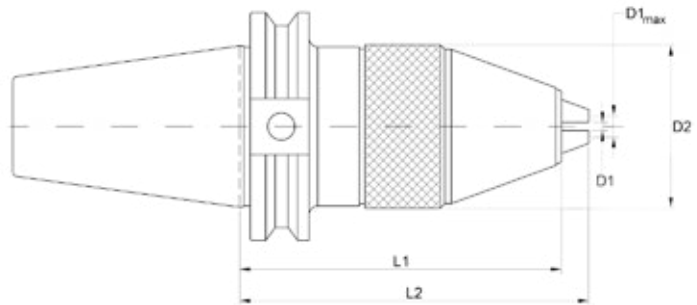

Chuck Size (Inch)	D1 Min-Max (Inch)	L1 (Inch)	L2 (Inch)	Wrench Reference	CAT40			CAT50		
					D2 (Inch)	Weight (lbs)	Code	D2 (Inch)	Weight (lbs)	Code
1/2	0.039-0.512	4.04	4.50	312189	1.89	3.84	310939	1.98	7.85	312028

Micro-Sensitive Drill Feed Adapter

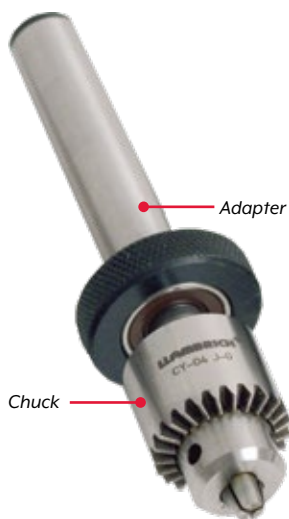

- Micro-sensitive drill adapter only - chuck and drill sold separately
- 3/4" travel
- Simple to use:
 - Grasp free-turning knurled ring and feed with gentle finger pressure
 - Spring-loaded - when ring is released, chuck retracts automatically
- Sensitive drill feeds makes drilling of small holes easy by giving you fingertip feed control independent of coarser quill feed
- Makes drilling of small holes easy by giving you fingertip feed control
- Eliminates the need for special machines to drill small holes
- Reduces breakage and deflection of small drills

Shank Diameter (Inch)	Jacobs Taper	Code
1/2	JT0	820383

Micro Drill Chuck & Key

- Very accurate and sensitive for precise drilling
- To be used in mills, lathes, drill presses, jig bore and Swiss machines
- Eliminates the need of secondary operations to drill small holes
- Spindle speeds up to 50,000 RPM
- Feed with gentle finger pressure
- Free turning knurled ring with spring return upon release
- 3/4" total travel
- Standard 1/2" diameter straight shank or MT1 to go directly into the spindle of the machine

Model	Capacity (Inch)	Jacobs Mount	Diameter (Inch)	Length Closed (Inch)	Length Open (Inch)	Code
L40I29B	1/64 - 5/32	JT0	0.866	1.102	1.378	827812

Drill Chuck Arbors

Hardened & Ground



Shank	Jacobs Taper	Code	Shank	Jacobs Taper	Code	Shank	Jacobs Taper	Code	Shank	Jacobs Taper	Code
MT1	J0	357200	ISA30	J2	363302	MT4	J4	357234	MT4	J6	357236
MT2	J0	357210	ISA40	J2	363312	MT5	J4	360244	MT5	J6	360246
1/2"	J0	360250	ISA50	J2	363322	1/2"	J4	360254	1/2"	J6	360256
R8	J0	363330	R8	J2	363332	5/8"	J4	360264	5/8"	J6	360266
MT1	J1	357201	MT1	J3	357203	3/4"	J4	360274	3/4"	J6	360276
MT2	J1	357211	MT2	J3	357213	1"	J4	360284	1"	J6	360286
MT3	J1	357221	MT3	J3	357223	ISA30	J4	363304	ISA30	J6	363306
1/2"	J1	360251	MT4	J3	357233	ISA40	J4	363314	ISA40	J6	363316
5/8"	J1	360261	MT5	J3	360243	ISA50	J4	363324	ISA50	J6	363326
ISA30	J1	363301	1/2"	J3	360253	R8	J4	363334	R8	J6	363336
R8	J1	363331	5/8"	J3	360263	MT1	J5	357205	MT1	J33	357207
MT1	J2	357202	3/4"	J3	360273	MT2	J5	357215	MT2	J33	357217
MT2	J2	357212	1"	J3	360283	MT3	J5	357225	MT3	J33	357227
MT3	J2	357222	ISA30	J3	363303	MT4	J5	357235	MT4	J33	357237
MT4	J2	357232	ISA40	J3	363313	MT5	J5	360245	1/2"	J33	360257
MT5	J2	360242	ISA50	J3	363323	ISA50	J5	363325	5/8"	J33	360267
1/2"	J2	360252	R8	J3	363333	R8	J5	363335	3/4"	J33	360277
5/8"	J2	360262	MT1	J4	357204	MT1	J6	357206	1"	J33	360287
3/4"	J2	360272	MT2	J4	357214	MT2	J6	357216	ISA30	J33	363307
1"	J2	360282	MT3	J4	357224	MT3	J6	357226	ISA40	J33	363317
									ISA50	J33	363327
									R8	J33	363337

Fitted Sockets

- Hardened and ground



Size	Description	Overall Length (Inch)	Code
1 - 2	1 bore, 2 shank	6-3/16	125212
1 - 3	1 bore, 3 shank	8-15/16	125213
1 - 4	1 bore, 4 shank	7-15/18	125214
1 - 5	1 bore, 5 shank	9-3/16	125215
2 - 1	2 bore, 1 shank	6-3/8	125221
2 - 2	2 bore, 2 shank	6-13/16	125222
2 - 3	2 bore, 3 shank	7-9/16	125223
2 - 4	2 bore, 4 shank	8-9/16	125224
2 - 5	2 bore, 5 shank	9-13/16	125225
3 - 1	3 bore, 1 shank	7-1/8	125231
3 - 2	3 bore, 2 shank	7-3/4	125232
3 - 3	3 bore, 3 shank	8-1/2	125233
3 - 4	3 bore, 4 shank	9-1/2	125234
3 - 5	3 bore, 5 shank	10-3/4	125235
4 - 2	4 bore, 2 shank	8-5/8	125242
4 - 3	4 bore, 3 shank	9-7/16	125243
4 - 4	4 bore, 4 shank	10-7/16	125244
4 - 5	4 bore, 5 shank	11-11/16	125245
4 - 6	4 bore, 6 shank	14-7/16	125246
5 - 3	5 bore, 3 shank	11	125253
5 - 4	5 bore, 4 shank	11-13/16	125254
5 - 5	5 bore, 5 shank	13-1/16	125255
5 - 6	5 bore, 6 shank	16	125256
6 - 5	6 bore, 5 shank	15-3/4	125265

Sleeves

- Hardened and ground



Size	Description	Code
1 - 2	1 bore & outside fitting 2 socket	125412
1 - 3	1 bore & outside fitting 3 socket	125413
1 - 4	1 bore & outside fitting 4 socket	125414
1 - 5	1 bore & outside fitting 5 socket	125415
2 - 3	2 bore & outside fitting 3 socket	125423
2 - 4	2 bore & outside fitting 4 socket	125424
2 - 5	2 bore & outside fitting 5 socket	125425
3 - 4	3 bore & outside fitting 4 socket	125434
3 - 5	3 bore & outside fitting 5 socket	125435
4 - 5	4 bore & outside fitting 5 socket	125445
4 - 6	4 bore & outside fitting 6 socket	125446
5 - 6	5 bore & outside fitting 6 socket	125456

Machine Sockets



Size	Morse Taper Bore	Overall Dimensions (Inch)	Overall Length (Inch)	Code
A	MT1	1	3-1/2	125501
B	MT1	1-1/4	3-1/2	125502
C	MT1	1-1/2	3-1/2	125503
D	MT2	1	4	125504
E	MT2	1-1/4	4	125505
F	MT2	1-1/2	4	125506
G	MT2	1-3/4	4	125507
H	MT2	2	4	125508
J	MT3	1-1/4	4-3/4	125509
K	MT3	1-1/2	4-3/4	125510
L	MT3	1-3/4	4-3/4	125511
M	MT3	2	4-3/4	125512
N	MT4	1-1/2	6	125513
P	MT4	1-3/4	6	125514
Q	MT4	2	6	125515
R	MT5	2-1/4	7-3/8	125516
S	MT5	2-1/2	7-3/8	125517

Automatic Drill Drifts



Description	Code
Suitable for MT shanks 1-3	375502
Suitable for MT shanks 4-6	375503

Drill Drifts



Size	Description	Code
1	Fitting 1 or 2 sockets and sleeves	130101
3	Fitting 3 sockets and sleeves	130103
4	Fitting 4 sockets and sleeves	130104
5	Fitting 5 and 6 sockets and sleeves	130105



Quick Change Tooling

For Morse Taper Spindles

- For use on radial drills, boring mills, or any machine with Morse taper spindles
- Interchangeable with Jahrl

Holders – 006 02 01

- Max rotation speed 2000 RPM
- Max concentricity achieved by taper coupling
- 10 mm clearance between workpiece and tool is sufficient
- Rotation in either direction
- Equally effective in vertical or horizontal position

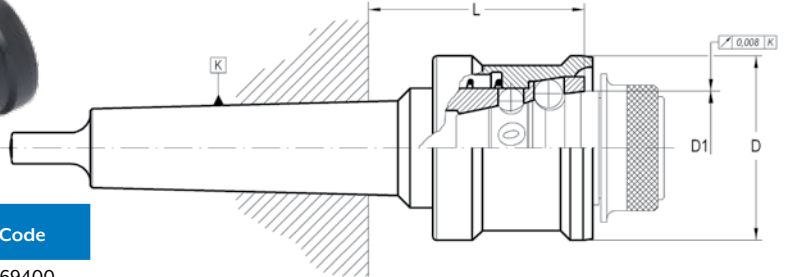

K	D1 (mm)	L (mm)	D (mm)	Code
M3	40	77	63	369400
M4	40	78	63	369401
M4	51.5	95	83	369402
M5	68.7	116	100	369403

Morse Taper Adapters – 006 99 01

- For tanged Morse taper tools - DIN 228-B

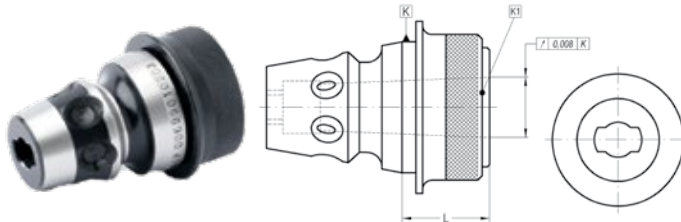

K (mm)	K1 (mm)	L (mm)	Code
40	M1	25	369411
40	M2	29	369412
40	M3	44	369413
51.5	M1	34	369421
51.5	M2	34	369422
51.5	M3	34	369423
51.5	M4	55	369424
68.7	M1	34	369431
68.7	M2	34	369432
68.7	M3	34	369433
68.7	M4	43	369434
68.7	M5	70	369435

Morse Taper Tapping Adapters – 006 99 05

- For tanged Morse taper tools - DIN 228-B

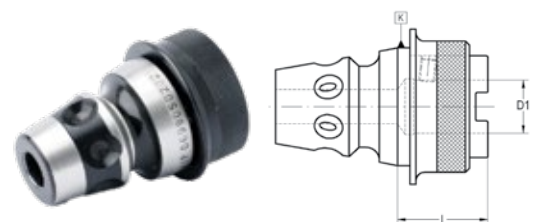

K (mm)	Capacity	D1 (mm)	L (mm)	Code
40	M3-M12 (M16)	19	29	369450
51.5	M3-M12 (M16)	19	41	369451
51.5	M8-M20 (M30)	31	41	369452
68.7	M8-M20 (M30)	31	41	369453
68.7	M14-M33 (M48)	48	54	369454

Tapping Adapters – 006 99 19 52

- Double axial compensation

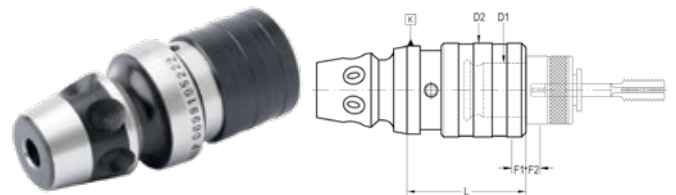

K (mm)	Capacity	D1 (mm)	L (mm)	D2 (mm)	F1 (mm)	F2 (mm)	Code
40	M3-M12 (M16)	19	45	36	7.5	7.5	369460
40	M8-M20 (M30)	31	69	53	12.5	12.5	369461
51.5	M3-M12 (M16)	19	46	36	7.5	7.5	369462
51.5	M8-M20 (M30)	31	69	53	12.5	12.5	369463
68.7	M8-M20 (M30)	31	69	53	12.5	12.5	369464
68.7	M14-M33 (M48)	48	110	78	20	20	369465

60° Centering Point Adapters – 006 99 03

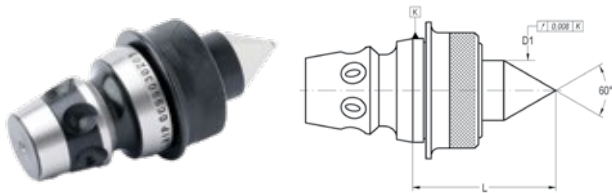

K (mm)	D1 (mm)	L (mm)	Code
40	26	61	369417
51.5	26	66	369427
68.7	26	66	369437

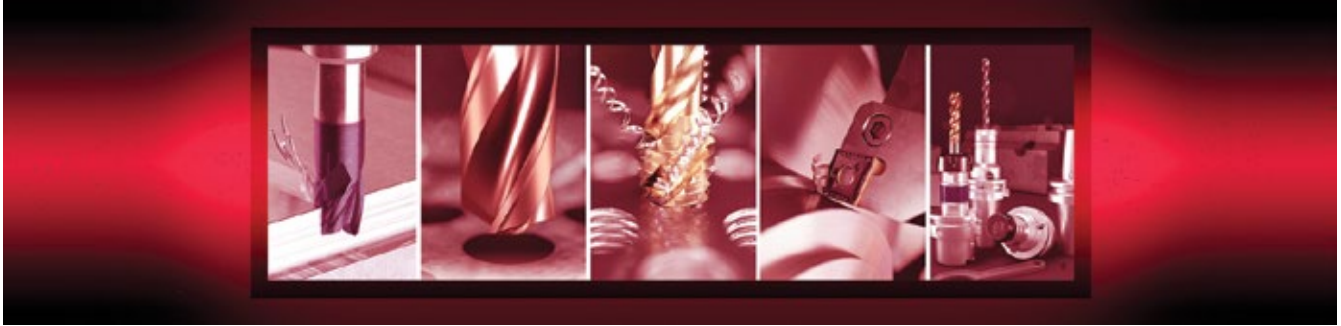

YG-1: BEST VALUE IN THE WORLD OF CUTTING TOOLS

Product Categories include:

Milling

Holemaking

Threading

Tooling Systems

Indexable Inserts

Tapping Heads

Self Reversing



- Radial floating, self-centering to compensate for hole center misalignment
- Unique double spring mechanism produces automatic feed and cushions the drive. There are two springs for reverse operation. Each set gives you added smoothness for ultra accurate tapping
- Pre-set torque control (reduces tap breakage)

Jacobs Taper	Tap Capacity	D Diameter (Inch)	D1 Diameter (Inch)	L (Inch)	L1 (Inch)	Code
J6	0 - 1/4 M2-M7	2.25	0.90	5.00	3.72	242140
J6	#10 - 1/2 M5-M12	3.50	1.10	6.65	4.80	242141
*M20	3/8 - 3/4 M8-M20	3.58	1.58	8.03	5.80	242142

*M20 is metric taper

Shanks

Shanks for 242142 M20 metric taper

Type	Code
MT3	242143
MT4	242144
R8	242145



Rubber-Flex Collets

For Holder	Tap Capacity	Code
242140	#0-#10	242146
242140	#10-1/4	242147
242141	#4-1/4	242148
242141	1/4-1/2	242149
242142	3/8-5/8	242163
242142	9/16-3/4	242164

Modular Tap Holders

Straight Shank

- Available in rigid or tension-compression styles
- Ideally suited to lathes and turning centers

Rigid Tap Holders



Type	d (Inch)	D (Inch)	Capacity (Inch)	L (Inch)	L1 (Inch)	Code
MRT#1 - 3/4	0.75	1.42	0 - 9/16	3.15	1.57	356720
MRT#1 - 1	1.00	1.42	0 - 9/16	3.58	2.01	356722
MRT#2 - 1	1.00	2.05	5/16 - 7/8	4.17	2.01	356723
MRT#3 - 1-1/2	1.50	3.07	13/16 - 1-3/8	6.25	3.00	356724

Modular Tap Holders

Straight Shank (continued)

Tension/Compression Tap Holders



Type	d (Inch)	D (Inch)	Capacity (Inch)	L (Inch)	L1 (Inch)	T Compensation (Inch)	C Compensation (Inch)	Code
MTC#1 - 3/4	0.75	1.42	0 - 9/16	3.15	1.57	0.30	0.30	356730
MTC#1 - 1	1.00	1.42	0 - 9/16	3.58	2.01	0.30	0.30	356732
MTC#2 - 1	1.00	2.16	5/16 - 7/8	4.49	2.01	0.49	0.49	356733
MTC#3 - 1-1/2	1.50	3.07	13/16 - 1-3/8	6.50	3.00	0.79	0.79	356734

Floating Holder Shanks

- Allows tapping using ERI6 collet systems



Shank Diameter (Inch)	B (Inch)	B1 (Inch)	D (Inch)	Tap Range	Wrench Reference	Code
3/4	5.31	2.36	1.10	#0-1/2	827009	242072
3/4	3.94	2.56	0.86	#0-1/2	827008	242074

BF Adapter

For ERI6 Collet



- Quick-change adapters are interchangeable with Bilz and other popular tapping systems
- Collets hold ANSI and metric sizes
- May be used for tapping and drilling

Collet Size	Tap Range	Bilz Style	B (Inch)	L (Inch)	D (Inch)	Code
ERI6	#0-1/2 M3-M12	#1	0.75	0.98	1.10	356890

Quick Change Tap Holders

Using BILZ Style Tap Holders

Tension/Compression Tap Holders

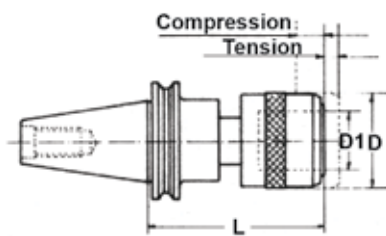

CATERPILLER V-FLANGE

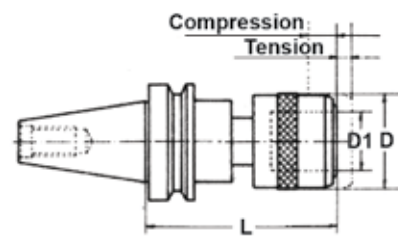

BT FLANGE

Taper	L (Inch)	D (Inch)	Tap Range	DI (Inch)	Tension (Inch)	Compression (Inch)	Approximate Weight (lbs)	Code
CAT40	3	1.18	0-9/16 hand 1/8 pipe	0.748	13/64	9/32	5	356040
CAT40	3-3/4	1.89	5/16-7/8 hand 1/4-3/8-1/2 pipe	1.220	5/16	19/32	9	356041
CAT50	4	1.18	0-9/16 hand 1/8 pipe	0.748	13/64	9/32	6	356049
CAT50	4	1.89	5/16-7/8 hand 1/4-3/8-1/2 pipe	1.220	5/16	19/32	10	356050
BT40	3	1.18	0-9/16 hand 1/8 pipe	0.748	13/64	9/32	5	356140
BT40	3-3/4	1.89	5/16-7/8 hand 1/4-3/8-1/2 pipe	1.220	5/16	19/32	9	356141
BT50	4	1.18	0-9/16 hand 1/8 pipe	0.748	13/64	9/32	6	356149

Rigid/Synchronized Tap Holders

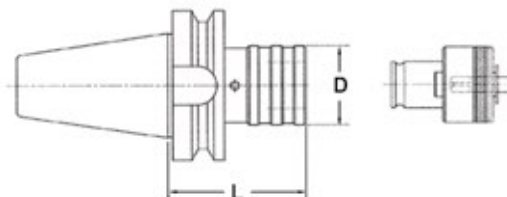

This unit does not have Tension/Compression

Taper	Chuck Size	Tap Range	D (Inch)	L (Inch)	Code
CAT40	1	0 - 9/16; 1/8P	1-1/2	3	242150
CAT40	2	5/16 - 7/8; 1/4P, 3/8P, 1/2P	2	3-3/4	242151
CAT40	3	13/16 - 1-3/8	2	5-3/4	242152
CAT50	1	0 - 9/16; 1/8P	1-1/2	3	242153
CAT50	2	5/16 - 7/8; 1/4P, 3/8P, 1/2P	2	3-3/4	242154
CAT50	3	13/16 - 1-3/8	2	5-3/4	242155
BT40	1	0 - 9/16; 1/8P	1-1/2	3	242156
BT40	2	5/16 - 7/8; 1/4P, 3/8P, 1/2P	2	3-3/4	242158
BT50	1	0 - 9/16; 1/8P	1-1/2	3	242160
BT50	2	5/16 - 7/8; 1/4P, 3/8P, 1/2P	2	3-3/4	242161

Quick Change Tap Adapters

Morse Taper Shank – Tension/Compression

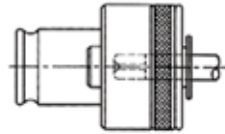
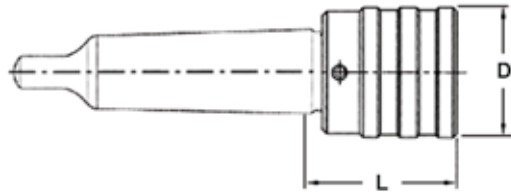

- For use on drills, lathes, etc.
- Takes Bilz style adapters #1, #2, and #3

Shank Size	Adapter	D (Inch)	L (Inch)	Code	Shank Size	Adapter	D (Inch)	L (Inch)	Code
MT2	CWE 1	1.42	1.85	242200	MT3	CWE 2	2.08	2.83	242205
MT3	CWE 1	1.42	1.85	242201	MT4	CWE 2	2.08	2.83	242206

BILZ Style Tap Adapters

Positive Drive & Torque Control Tap Adapters – Inch & Metric



Model	A	B
CWE 1	1.18	0.75
CWE 2	1.89	1.22
CWE 3	2.75	1.89

Standard Positive Drive (PD) – Inch

Hand Tap Size	Tap Shank Diameter (Inch)	Model CWE 1		Model CWE 2		Model CWE 3	
		Depth Tap Enters	Code	Depth Tap Enters	Code	Depth Tap Enters	Code
0-6	0.141	0.85	356500	0.85	356540	-	-
#8	0.168	0.92	356502	0.92	356542	-	-
#10	0.194	0.92	356504	0.92	356544	-	-
#12	0.220	0.95	356506	0.95	356546	-	-
1/4"	0.255	0.95	356508	0.95	356548	-	-
5/16"	0.318	0.98	356510	1.49	356550	-	-
3/8"	0.381	1.05	356512	1.56	356552	-	-
7/16"	0.323	1.08	356514	1.59	356554	-	-
1/2"	0.367	1.11	356516	1.62	356556	-	-
9/16"	0.429	1.17	356518	1.68	356558	-	-
5/8"	0.480	-	-	1.74	356560	-	-
11/16"	0.542	-	-	1.81	356562	-	-
3/4"	0.590	-	-	1.87	356564	-	-
13/16"	0.652	-	-	1.87	356566	2.42	356580
7/8"	0.697	-	-	1.93	356568	2.48	356582
15/16"	0.760	-	-	-	-	2.48	356584
1"	0.800	-	-	-	-	2.54	356586
1-1/8"	0.896	-	-	-	-	2.61	356588
1-1/4"	1.021	-	-	-	-	2.73	356590
1-3/8"	1.108	-	-	-	-	2.79	356592

Pipe – Positive Drive (PD) – Inch

Pipe Tap Size	Tap Shank Diameter (Inch)	Model CWE 1		Model CWE 2		Model CWE 3	
		Depth Tap Enters	Code	Depth Tap Enters	Code	Depth Tap Enters	Code
1/8 SS	0.313	1.05	356520	-	-	-	-
1/8 LS	0.437	1.05	356522	-	-	-	-
1/4	0.562	-	-	1.18	356570	-	-
3/8	0.700	-	-	1.24	356572	-	-
1/2	0.687	-	-	1.37	356574	-	-
3/4	0.906	-	-	-	-	1.55	356596
1	1.125	-	-	-	-	1.68	356598

BILZ Style Tap Adapters

Positive Drive & Torque Control Tap Adapters – Inch & Metric (*continued*)

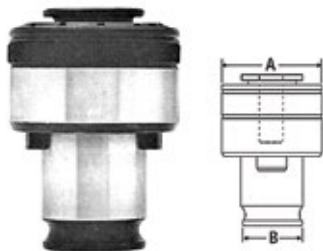

Model	A	B
CWES 1	1.26	0.75
CWES 2	1.97	1.22

Torque Control (TC) – Inch

Hand Tap Size	Tap Shank Diameter (Inch)	Model CWES 1	Model CWES 2
		Code	Code
0-6	0.141	356800	–
#8	0.168	356802	–
#10	0.194	356804	–
#12	0.220	356806	–
1/4"	0.255	356808	356849
5/16"	0.318	356810	356850
3/8"	0.381	356812	356852
7/16"	0.323	356814	356854
1/2"	0.367	356816	356856
9/16"	0.429	356818	356858
5/8"	0.480	–	356860
11/16"	0.542	–	356862
3/4"	0.590	–	356864
13/16"	0.652	–	356866
7/8"	0.697	–	356868

Torque Control (TC) – Metric (ISO)

Hand Tap Size	Tap Shank Diameter (mm)	Model CWES 1	Model CWES 2
		Code	Code
M6	6.3	356825	356875
M8	8.0	356828	356878
M10	10.0	356830	356880
M12	9.0	356832	356882

Pipe – Torque Control (TC) – Inch

Pipe Tap Size	Tap Shank Diameter (Inch)	Model CWES 1	Model CWES 2
		Code	Code
1/8 SS	0.313	356820	–
1/8 LS	0.437	356822	–
1/4	0.562	–	356870
3/8	0.700	–	356872
1/2	0.687	–	356874

Boring Heads & Detachable Shanks



- Round style – double bar
- Detachable shank
- Delivers the optimum in precision performance
- Rugged construction and maximum bearing-surface between the sliding gib and the body
- Superior rigidity for chatter-free boring and precise hole-size accuracy
- Bar holder moves freely and smoothly and when locked in place holds firmly against the body
- Micrometer leadscrew provides 0.001" direct-reading accuracy and adjusts easily and quickly to accommodate size change or tool wear

Boring Heads

Model	Actual Size	Overall Length (Inch)	Hole Size (Inch)	Offset (Inch)	Thread Back	Code
DBL-202	2 Rd.	2-5/16	1/2	1/2	1-1/2 - 18	254140
DBL-203	3 Rd.	3-1/4	3/4	3/4	1-1/2 - 18	254142
DBL-204	4 Rd.	3-3/4	1	1	1-1/2 - 18	254144

Detachable Shanks

Shank Size (Inch)	Code	Shank Size (Inch)	Code	Shank Size (Inch)	Code	Shank Size (Inch)	Code
3/4	254146	MT3	254152	ISA40	254158	CAT40	302431
1	254148	R8	254154	ISA50	254159	CAT50	302432
MT2	254150	ISA30	254156				



Boring Head Sets

Set includes:

- Wrenches
- Variety of boring bars
- Supplied in fitted case

Model	Shank	Capacity (Inch)	Bore Size (Inch)	Code
BHC2	3/4 SS	0 - 4	1/2	302425
BHC3	R8	0 - 6	3/4	302430

Boring Heads

Integral Shanks

- Boring capacity 4" diameter
- 3/4" travel (1-1/2" on diameter)

Shank	Boring Bar Diameter (Inch)	Dial Reading (Inch)	Body Diameter (Inch)	Body Length (Inch)	Code
R8	1/2	0.001	2-1/2	3-7/16	311576
3/4	1/2	0.001	2-1/2	3-7/16	311577



R8 Shank

3/4" Straight Shank

Universal Boring & Facing Head



Supplied in fitted storage case

Code
302300

Specifications:

Operating accuracy.....	±0.0002"
Boring & Facing range.....	0 - 9"
Maximum adjustability of slide.....	1.375"
Maximum diameter of slide.....	2.750"
Various automatic slide-feeds per revolution.....	
.....	0.0016"
.....	0.0032"
.....	0.0048"
One graduation of fine adjustment on diameter.....	0.0005"
One revolution of fine adjustment.....	0.016"
Quick return per revolution.....	0.030"
Diameter of tool holes in slide.....	5/8"
Height of head without shank.....	3.125"
Width of head.....	2.875"
Weight of head without shank.....	4 lbs

Standard equipment supplied with the master head (in fitted case):

Boring bars.....	3/8 (2)
Boring bars.....	5/8 (2)
Extension holder.....	5/8 - 3-7/8
Set reinforcing rings.....	5/8
Carbide round toolbits.....	5/8 (4)
Reducing sleeve.....	5/8 - 3/8

Shanks for Universal Boring & Facing Head

(Sold separately)



Shank	Code
MT3	302312
MT4	302313
ISA30	302314
ISA40	302315
R8	302317
Straight 1"	302318

Oil Cans

- Compact and robust
- Metal body
- Brass pump
- Supplied with rigid and flex spouts

Pump Style



Capacity	Code
300 ml	416300
500 ml	416301
700 ml	416302

Piston Style



Capacity	Code
125 ml	416315

Replacement Spouts



Type	Length (Inch)	Code
Rigid	7	416305
Flexible	8	416306

Grease Guns

Heavy Duty



- Robust construction
- Develops up to 10,000 PSI
- Short stroke feature pumps grease with limited action
- Complete with bulk loader and air bleeder fittings
- Versatile loading: cartridge or bulk
- Comfortable non-slip grip

Capacity	Code
500 g	416320

Push Type



- Pump action grease gun for use with soft medium grease
- Complete with nipple connector
- Develops up to 3000 PSI

Capacity	Code
125 mg	416325
200 mg	416326

Snap Coolant Systems



FLUID ACCESSORIES

Description	Image	1/4" System		1/2" System	
		Includes	Code	Includes	Code
Complete Hose Assembly		Hose assembly (approx. 13") 1/16", 1/8", 1/4" nozzles and 1/8", 1/4" connectors	217700	Hose assembly (approx. 13") 1/4" 3/8", 1/2" nozzles and 3/8", 1/2" NPT connectors	217701
Hose Assemblies		Body hose segment: 12"	217702	Body hose segment: 12"	217705
		Body hose segment: 25' bulk	217703	Body hose segment: 25' bulk	217706
		Body hose segment: 50' bulk	217704	-	-
		-	-	1/2" to 1/4" I.D. hose reducer (2)	217707
Male Hose to Male Pipe Thread Connectors		Male Hose to NPT: 1/8" NPT (4)	217708	Male Hose to NPT: 3/8" NPT (4)	217710
		Male Hose to NPT: 1/4" NPT (4)	217709	Male Hose to NPT: 1/2" NPT (4)	217711
Female Hose to Male Pipe Thread Connectors		Female Hose to NPT: 1/8" NPT (2)	217712	Female Hose to NPT: 3/8" NPT (4)	217714
		Female Hose to NPT: 1/4" NPT (2)	217713	Female Hose to NPT: 1/2" NPT (4)	217715
Male Hose to Female Pipe Thread Connectors		Male Hose to F/NPT: 1/8" NPT (4)	217716	Male Hose to F/NPT: 1/2" NPT (4)	217719
		Male Hose to F/NPT: 1/4" NPT (4)	217717	-	-
SAE Flare Nut Adapters		SAE Flare Nut: 3/8" SAE flare (4)	217721	SAE Flare Nut: 3/8" SAE flare (4)	217722
Nozzles (Light Gray)		Nozzle assortment: 1/16", 1/8", 1/4" round, 1" flare (1 ea.)	217723	Nozzle assortment: 1/4", 3/8" 1/2" round, 2" flare (1 ea.)	217727
		Round: 1/16" (4)	217724	Round: 1/4" (4)	217728
		Round: 1/8" (4)	217725	Round: 3/8" (4)	217729
		Round: 1/4" (4)	217726	Round: 1/2" (4)	217730
		Flare: 3/4" (2)	217731	Flare: 2" (2)	217733
		Flare: 1" (2)	217732	-	-
Male Hose to NPT Y		1/8" NPT (2)	217734	3/4" NPT (2)	217738
		1/4" NPT (2)	217735	1/2" NPT (2)	217739
		3/8" NPT reducer Y (2)	217736	-	-
		1/2" NPT reducer Y (2)	217737	-	-
Hose to Hose Y's (Dark Gray)		Hose to Hose Y: 1/4" (2)	217740	-	-
Hose to Hose RDCR Y's (Dark Gray)		-	-	Hose to Hose RDCR Y: 1/2" (2)	217741
		-	-	Hose Reducers (2)	217742
Hose to Hose (Female) Double Socket		1/4" Double Socket (2)	217744	1/2" Double Socket (2)	217745
Close Nipple		1/4" NPT Close Nipple (4)	-	1/2" NPT Close Nipple (4)	217748
		3/8" NPT Close Nipple (4)	-	-	-

Snap Coolant Systems (continued)



Description		1/4" System		1/2" System	
		Includes	Code	Includes	Code
Plugs		3/8" NPT (4)	217749	1/2" NPT (4)	217750
Ball Valves		1/4" NPT (1)	217751	1/2" NPT (1)	217752
Universal Assembly Pliers		For 1/4" I.D. hose systems	217756	For 1/2" I.D. hose systems	217757

Lamp Assembly with Magnetic Base



Description	Code
115V work light pac	217758
Dual voltage (12/115V), high intensity universal halogen light pac	217761

Adjustable Arm



Description	Code
Approximate length - 12", 1/2" adjustable, black, plastic clip, magnetic base	217763

Snap Coolant Systems



With Magnetic Base

- Efficient flow control to deliver air/liquid coolant where it is required
- Control valve allows convenient adjustment of air/coolant near work
- Barbed connection easily adapts to regulated shop air or machine coolant pump
- Magnetic base (38 lbs pull) holds unit firmly in position
- Made from high quality non-corrosive materials
- Flexible hose can be easily directed and stays in position

Single



Description	Code
Single 9" length of 1/4" I.D. hose and 1/8" I.D. nozzle	217766

Double



Description	Code
Two 9" lengths of 1/4" I.D. hose and 1/8" I.D. nozzle	217767

Misting System



- Reliable mist flow with precision control
- Get the right mist mixture with separate air and fluid controls
- Fully assembled, ready to use
- Special tank not required
- Magnetic base can be easily repositioned
- Made from high quality non-corrosive material

Description	Code
Set includes: 1/4" NPT ball valve, 1/4" NPT quick disconnect, 1/4" regulator, aspirator, pressure gage, foot strainer, 3/8" O.D. tubing, magnetic base, 12" hose assembly with 1/8" nozzle	217768



Universal Manifold Set

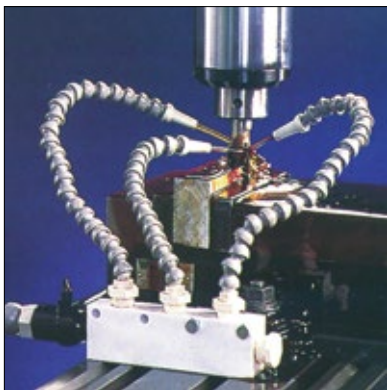

Set includes:

- Manifold block
- Mounting bracket
- 1/2" female x 1/2" NPT male connector
- 1/2" NPT ball valve
- 1/2" NPT close nipples (2)
- 1/2" NPT plug
- 3/8" NPT tee (3)
- 3/8" NPT close nipples (3)
- 1/4"-20 hex head screws (2)
- 1/4"-20 hex head nuts (2)
- 3/8" NPT plug
- 3/8" NPT x 1/4" NPT reducer bushings (6)

NOTE: Hose and nozzles sold separately

Code
217769

FLUID ACCESSORIES

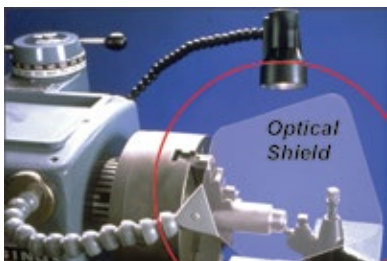













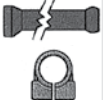























Optical Shields



Size (Inch)	Code
6 x 6	217770
9 x 9	217771
12 x 12	217772

Coolant Hose Segments & Fittings











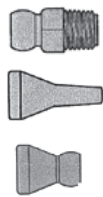









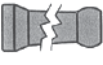











1/4" System – Interchangeable with Loc-Line

Style	Description	Style	Description	Style	Description
A	 <ul style="list-style-type: none"> • 1/4" hose kit • 13" length with fittings • 2 x 6" segments • 1/16", 1/8", 1/4" nozzles • 1/4" and 1/8" male NPT connectors 	O	 <ul style="list-style-type: none"> • 1/16" 90° nozzles (pkg. of 4) 	Z	 <ul style="list-style-type: none"> • 1/4" elbow fittings (pkg. of 2)
B	 <ul style="list-style-type: none"> • 1/4" extended element kit with element clamps, including 4 elements and 4 element clamps 	P	 <ul style="list-style-type: none"> • 1/8" 90° nozzles (pkg. of 4) 	AA	 <ul style="list-style-type: none"> • 1/4" T fitting (pkg. of 2)
C	 <ul style="list-style-type: none"> • 1/4" segment pack (2 x 6" pcs.) 	Q	 <ul style="list-style-type: none"> • 1/4" 90° nozzles (pkg. of 4) 	BB	 <ul style="list-style-type: none"> • 1/4" side flow nozzles (pkg. of 4)
D	 <ul style="list-style-type: none"> • 1/4" x 50 ft. coil 	R	 <ul style="list-style-type: none"> • 1/4" 90° spray bar nozzles (pkg. of 2) 	CC	 <ul style="list-style-type: none"> • 1/4" end caps (pkg. of 4)
E	 <ul style="list-style-type: none"> • 1/4" circle flow nozzle kit, assembled with 15 side flow nozzles 1/4" and 1 end cap 1/4" 	S	 <ul style="list-style-type: none"> • 1" flare nozzles (pkg. of 2) 	DD	 <ul style="list-style-type: none"> • 1/4" NPT male hose nipple valves (pkg. of 2)
F	 <ul style="list-style-type: none"> • 1/4" extended elements (pkg. of 4) 	T	 <ul style="list-style-type: none"> • 1/8" NPT connectors (pkg. of 4) 	EE	 <ul style="list-style-type: none"> • 1/4" connection valves (pkg. of 2)
G	 <ul style="list-style-type: none"> • 1/4" element clamps (pkg. of 4) 	U	 <ul style="list-style-type: none"> • 1/4" NPT connectors (pkg. of 4) 	FF	 <ul style="list-style-type: none"> • 1/4" male NPT valves (pkg. of 2)
H	 <ul style="list-style-type: none"> • 1/4" 90° nozzle kit • 1 each: 1/16", 1/8", 1/4", and spray bar nozzles 	V	 <ul style="list-style-type: none"> • 1/4" fitting (pkg. of 2) 	GG	 <ul style="list-style-type: none"> • 1/4" female NPT valves (pkg. of 2)
I	 <ul style="list-style-type: none"> • 1/16" round nozzles (pkg. of 4) 	W	 <ul style="list-style-type: none"> • 1/4" double sockets (pkg. of 4) 	HH	 <ul style="list-style-type: none"> • 1/4" connection check valves (pkg. of 2)
J	 <ul style="list-style-type: none"> • 1/16" round nozzles (pkg. of 50) 	X	 <ul style="list-style-type: none"> • 1/4" double sockets (pkg. of 20) 	II	 <ul style="list-style-type: none"> • Modular manifold system 1/4" • 1/4" elbow fitting (1 pc.) • 1/4" manifold bracket (1 pc.) • 1/4" T fittings (3 pcs.) • 1/4" mounting screw (3 pcs.)
K	 <ul style="list-style-type: none"> • 1/8" round nozzles (pkg. of 4) 	Y	 <ul style="list-style-type: none"> • 1/4" socket to 1/8" NPT (pkg. of 4) 	JJ	 <ul style="list-style-type: none"> • 1/4" main flow control manifold system (1 pc.) • 1/4" connection valves (5 pcs.)
L	 <ul style="list-style-type: none"> • 1/8" round nozzles (pkg. of 50) 			KK	 <ul style="list-style-type: none"> • 1/4" manifold brackets (pkg. of 2)
M	 <ul style="list-style-type: none"> • 1/4" round nozzles (pkg. of 4) 				
N	 <ul style="list-style-type: none"> • 1/4" round nozzles (pkg. of 50) 				

Style	Code	Style	Code	Style	Code	Style	Code
A	217773	K	217783	T	217792	CC	217801
B	217774	L	217784	U	217793	DD	217802
C	217775	M	217785	V	217794	EE	217803
D	217776	N	217786	W	217795	FF	217804
E	217777	O	217787	X	217796	GG	217805
F	217778	P	217788	Y	217797	HH	217806
G	217779	Q	217789	Z	217798	II	217807
H	217780	R	217790	AA	217799	JJ	217808
I	217781	S	217791	BB	217800	KK	217809
J	217782					Assembly Pliers	217850

Coolant Hose Segments & Fittings

1/2" System – Interchangeable with Loc-Line

Style	Description	Style	Description
A	 <ul style="list-style-type: none"> • 1/2" Hose Kit • 13" length with fittings: - 2 x 6" segments - 1/4", 3/8", 1/2" nozzles - 3/8" and 1/2" male NPT connectors 	N	 <ul style="list-style-type: none"> • 1/2" to 1/4" Reducers (pkg. of 2)
B	 <ul style="list-style-type: none"> • 1/2" Extended Element Kit with Element Clamps • Includes 4 of each: - 1/2" extended elements - 1/2" element clamps 	O	 <ul style="list-style-type: none"> • 1/2" to 1/4" Y Reducers (pkg. of 20)
C	 <ul style="list-style-type: none"> • Segment pack (2 x 6" pcs.) 	P	 <ul style="list-style-type: none"> • 1/2" Y Fittings (pkg. of 2)
D	 <ul style="list-style-type: none"> • 1/2" x 50 ft. coil 	Q	 <ul style="list-style-type: none"> • 1/2" Y Fittings (pkg. of 20)
E	 <ul style="list-style-type: none"> • 1/2" Circle Flow Nozzle Kit • Assembled with 15 side flow nozzles 1/2" and one end cap 1/2" 	R	 <ul style="list-style-type: none"> • 1/2" to 1/4" Adapters (pkg. of 2)
F	 <ul style="list-style-type: none"> • 1/2" Extended Elements (pkg. of 4) 	S	 <ul style="list-style-type: none"> • 1/2" T Fittings (pkg. of 2)
G	 <ul style="list-style-type: none"> • 1/4" Round Nozzles (pkg. of 4) 	T	 <ul style="list-style-type: none"> • 1/2" Side Flow Nozzles (pkg. of 4)
H	 <ul style="list-style-type: none"> • 3/8" Round Nozzles (pkg. of 4) 	U	 <ul style="list-style-type: none"> • 1/2" Side Flow Nozzles (pkg. of 20)
I	 <ul style="list-style-type: none"> • 1/2" Round Nozzles (pkg. of 4) 	V	 <ul style="list-style-type: none"> • 1/2" End Caps (pkg. of 4)
J	 <ul style="list-style-type: none"> • 1-1/4" Flare Nozzles (pkg. of 2) 	W	 <ul style="list-style-type: none"> • 1/2" End Caps (pkg. of 20)
K	 <ul style="list-style-type: none"> • 3/8" NPT Connectors (pkg. of 4) 	X	 <ul style="list-style-type: none"> • 1/2" Connection Valves (pkg. of 2)
L	 <ul style="list-style-type: none"> • 1/2" NPT Connectors (pkg. of 4) 	Y	 <ul style="list-style-type: none"> • 1/2" Connection Valves (pkg. of 10)
M	 <ul style="list-style-type: none"> • 1/2" Elbow Fittings (pkg. of 2) 	Z	 <ul style="list-style-type: none"> • 1/2" Female NPT Valves (pkg. of 2)
		AA	 <ul style="list-style-type: none"> • 1/2" Female NPT Valves (pkg. of 10)
		BB	 <ul style="list-style-type: none"> • 1/2" Male NPT Valves (pkg. of 2)
		CC	 <ul style="list-style-type: none"> • 1/2" Male NPT Valves (pkg. of 10)
		DD	 <ul style="list-style-type: none"> • Modular Manifold System 1/2" includes: - 1/2" elbow fitting (1 pc.) - 1/2" manifold bracket (1 pc.) - 1/2" T fittings (3 pcs.) - 1/2" mounting screws (3 pcs.)
		EE	 <ul style="list-style-type: none"> • Main Flow Control Manifold System 1/2" includes: - modular manifold 1/2" - 5 connection valves 1/2"
		FF	 <ul style="list-style-type: none"> • 1/2" Manifold Brackets (pkg. of 2)

Style	Code	Style	Code	Style	Code	Style	Code
A	217810	I	217818	Q	217826	Y	217834
B	217811	J	217819	R	217827	Z	217835
C	217812	K	217820	S	217828	AA	217836
D	217813	L	217821	T	217829	BB	217837
E	217814	M	217822	U	217830	CC	217838
F	217815	N	217823	V	217831	DD	217839
G	217816	O	217824	W	217832	EE	217840
H	217817	P	217825	X	217833	FF	217841

Assembly Pliers

Pneuvac Pump

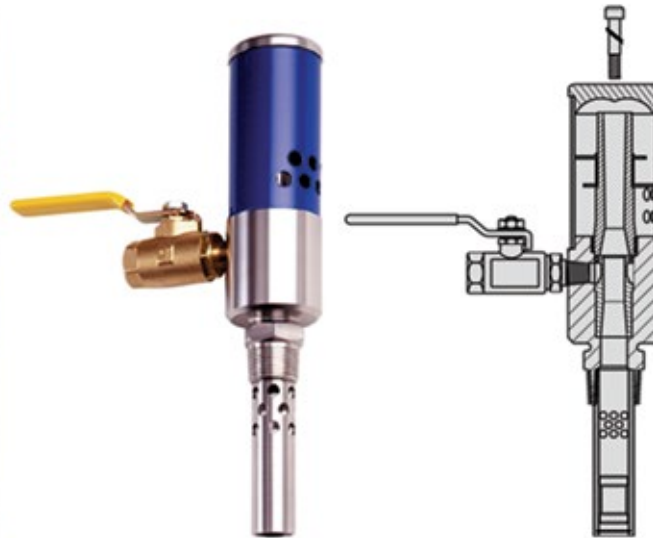

The Royal PneuVac pump is a simple, low-cost device that generates a strong vacuum when compressed air flows through its internal venturi.

All you have to do to operate the unit is:

- Connect the pump and hose to a standard 55-gallon steel drum
- Hook up a compressed air supply to the pump
- Drop the free end of hose into the coolant
- Open the air valve
- Coolant and sludge is drawn through the hose and deposited into the drum – quick, clean, and hassle-free

Removing old, rancid coolant from machine tool coolant sumps has always been a dirty, time-consuming job – but now it doesn't have to be. The Royal PneuVac Pump allows you to clean your sumps quickly, safely, and easily!

PneuVac Pump Sets

Set includes:

- 1/4" ball valve
- Automatic shut-off valve
- 10 ft. of smooth-bore hose
- Quick-disconnect drum fittings
- 18" aluminum wand

CAUTION:

1. Do not use the PneuVac pump with flammable or volatile liquids such as gasoline, alcohol, kerosene, aviation fuel, mineral spirits or any similar liquid with a low flash point
2. Do not modify this product to pressurize drum to pump liquids out. Pressurizing drum could cause an explosion that may result in serious injuries.



Description	Code
Stainless Steel	217843
Aluminum	217844

Wrenches

476



Refractometers

478

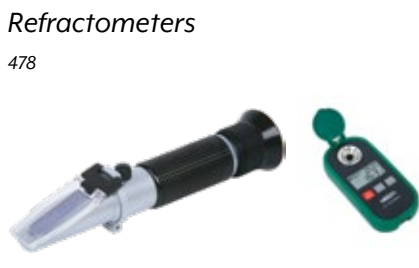

Marking Equipment & Supplies

479



Air Tapping

480



Punch Formers, Punches & Scribes

481-487



Inside/Outside Calipers & Dividers

488

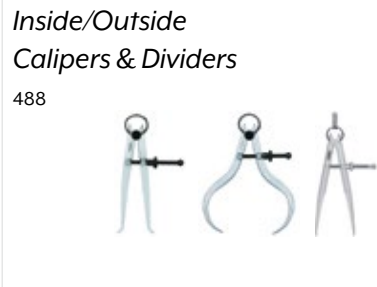

TORX® Wrenches



Small Grip TORX® Wrenches

- Chrome vanadium, hardened and steel-gray
- Handle is cadmium-free impact resistant plastic

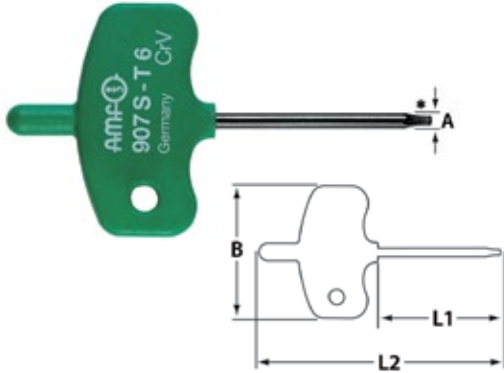

Size	A (mm)	L1 (mm)	L2 (mm)	B (mm)	Weight (g)	Code
T6	1.70	35	70	38	14	718405
T10	2.74	40	75	38	15	718406

Ergonomic Grip TORX® Wrenches

- Chrome vanadium, hardened and chrome-plated with black tip
- Handle is cadmium-free impact resistant plastic

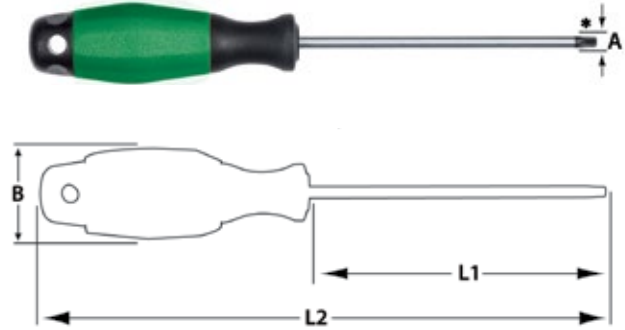

Size	A (mm)	L1 (mm)	L2 (mm)	B (mm)	Weight (g)	Code
T9	2.50	60	140	18	37	718407
T15	3.27	80	170	21	41	576532
T20	3.86	100	190	24	56	718401

T-Grip TORX® Wrenches

- Chrome vanadium, hardened and chrome-plated with black tip
- Handle is cadmium-free impact resistant plastic

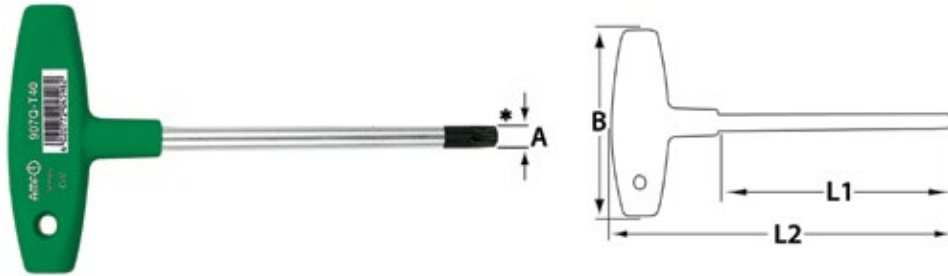

Size	A (mm)	L1 (mm)	L2 (mm)	B (mm)	Weight (g)	Code
T9	2.50	100	125	80	35	718408
T10	2.74	100	125	80	35	718409
T15	3.27	100	125	80	36	302319
T27	4.99	100	131	100	70	718411

Size	A (mm)	L1 (mm)	L2 (mm)	B (mm)	Weight (g)	Code
T30	5.52	100	131	100	75	718412
T40	6.65	100	131	100	80	718413
T50	8.83	150	188	120	160	718414

TORX® Screwdrivers



Size	Drill Range		Torque (lbs)	Code
	Inch	Metric		
T7	3/8 - 1/2	9.5 - 11	5.5	549505
T8	33/64 - 11/16	13 - 17.5	11	549500
T9	45/64 - 15/16	18 - 24	20	549501
T15	31/32 - 1-3/8	24 - 35	45	549502
T20	1-13/32 - 2-9/16	36 - 65	90	549503
T25	2-1/2 - 4-1/2	64 - 114	155	549504

Torque Wrenches



- DIN ISO 6789, ASME B107.300-2010 standards
- All metal construction
- Clockwise operation only

Range (clockwise)	40-200lb.in	50-250lb.in	20-100lb.ft	30-150lb.ft	50-250lb.ft	100-600lb.ft
Accuracy	±6% (<89lb.in) ±4% (≥89lb.in)	±6% (<89lb.in) ±4% (≥89lb.in)	±4%	±4%	±4%	±4%
Graduation	1lb.in	1lb.in	0.5lb.ft	0.5lb.ft	1lb.ft	2.5lb.ft
Square driver	1/4"	3/8"	3/8"	1/2"	1/2"	3/4"
Length	11.02"	12.4"	16.73"	19.88"	20.67"	41.54"
Weight	1.5 lbs	1.8 lbs	2.29 lbs	2.56 lbs	2.87 lbs	13.01 lbs
INSIZE No.	IST-10WM200	IST-10WM250	IST-10WMI00	IST-10WMI50	IST-10WM250A	IST-10WM600
Code	877238	877239	877236	877237	877240	877241

Electronic Torque Testers



INCLUDES ONE OF EACH: Torque tester, Transducer with 40" cable, AC/DC adapter, Adapter

- With external sensor, to test torque wrenches, torque screwdrivers and other torque tools
- Clockwise and counter-clockwise operation
- Peak, track and first peak working modes
- Unit: N.m, in.lb, ft.lb, kg.cm
- Low and high limits with judgement
- Target torque value can be set, with audible and visible alarm:
 - Green LED light on and buzzer sounds when the value is 80%-100% of target torque
 - Both green and red LED light on and buzzer sounds when the target torque value is reached
- Auto power off
- Not recommended for electric wrenches, impact wrenches or pneumatic wrenches

Range	4.42-44.24in.lb 0.369-3.687ft.lb	44.2-442.4in.lb 3.69-36.87ft.lb	195-1946in.lb 16.2-162.2ft.lb	487-4867in.lb 40.6-405.6ft.lb	– 162-1622ft.lb
Accuracy	±1% (clockwise and counter-clockwise)				
Resolution	0.01in.lb 0.001ft.lb	0.1in.lb 0.01ft.lb	1in.lb 0.1ft.lb	1in.lb 0.1ft.lb	– 1ft.lb
Square socket	1/4"	3/8"	1/2"	3/4"	1"
Power supply	DC				
Adapter	No	3/8" to 1/4"	1/2" to 3/8" 3/8" to 1/4"	3/4" to 1/2" 1/2" to 3/8"	1" to 3/4" 3/4" to 1/2"
Transducer dimension	2.36" x 2.36" x 1.85"	3.5" x 3.5" x 2.56"	4.29" x 4.29" x 2.87"	5.51" x 5.51" x 3.82"	6.3 x 6.3 x 4.57
Weight	1.54 lbs	2.43 lbs	3.09 lbs	6.17 lbs	10.36 lbs
INSIZE No.	IST-TTS	IST-TT50	IST-TT220	IST-TT550	IST-TT2200
Code	877256	877257	877254	877258	877255



Portable Refractometer

- Quickly measure the concentration of coolant
- Refer to the refraction factor of coolant, for example: the refraction factor of grinding emulsion is 2.1, the reading value is 6%, so the actual concentration is $(2.1 \times 6\%) = 12.6\%$
- Suitable for water based coolant



Measuring range	0-32%
Graduation	0.2%
Dimensions	1.06" x 1.57" x 6.3"
Weight	0.39 lbs
INSIZE No.	ISQ-RM30
Code	219182



Electronic Refractometer

- Quickly measure the concentration of coolant
- Two measurement modes: single measurement and automatic average multiple measurement
- Two units: brix and refractive index
- Refer to the refraction factor of coolant, for example: the refraction factor of grinding emulsion is 2.1, the reading value is 6%, so the actual concentration is $(2.1 \times 6\%) = 12.6\%$
- Automatic power off



Measuring range	0-50% (1.333-1.42RI)
Accuracy	$\pm 0.2\%$ ($\pm 0.0003RI$)
Resolution	0.1% (0.0001RI)
Power supply	1 x AAA battery
Dimension	4.76" x 2.28" x 0.98"
Weight	0.21lbs
INSIZE No.	ISQ-DRM31
Code	877433

Layout Fluids



DYKEM is one of the world's best known and most trusted line of metal marking fluids. DYKEM has expanded its technology to offer a complete line of metal marking products, many of which have been formulated for a wide range of marking devices for virtually any application.

- Provides a thin translucent blue film without cracking or chipping
- Prevents glare with a uniform, deep colour
- Dries in two to four minutes
- Lets you scribe sharp, clear precise lines
- Reduces eyestrain
- Toluene free

Colour	Description	Code
Steel Blue	12 oz. aerosol	219026
Steel Blue	8 oz. bottle	219034

Remover & Thinner



- Thoroughly cleans and prepares metal surfaces
- Removes dirt, grease and oil from metals, most plastics and glass
- Does not contain 1,1,1-trichloroethane
- Ideal for surface preparation as well as removing layout fluids and staining colours
- May also be used to dilute staining colours



Description	Code
12 oz. aerosol	219073
1 gallon	219075

High Spot Marking



For identifying high spots on bearings and gear surfaces

Description	Code
Prussian Blue 0.75 oz. tube	219071

Marking Pens



DYKEM has expanded its line of marking pens to offer a complete range of sizes and types to accommodate virtually any marking application. All Dykem pens are designed with a patented valve-action feature. Even when the cap is left off for a period of time, the tip can be recharged simply by pressing it against a surface, allowing the ink to flow from the reservoir.

Colour	Description	Code
Black	General Purpose (12 cc)	219077
White	General Purpose (12 cc)	219078
Yellow	General Purpose (12 cc)	219079
Red	General Purpose (12 cc)	219080
Blue	General Purpose (12 cc)	219081
Orange	General Purpose (12 cc)	219082
Green	General Purpose (12 cc)	219083
Black	Ball Point Tex-Pens (26.8 cc)	219091
White	Ball Point Tex-Pens (26.8 cc)	219092
Red	Ball Point Tex-Pens (26.8 cc)	219094
Blue	Ball Point Tex-Pens (26.8 cc)	219095
Orange	Ball Point Tex-Pens (26.8 cc)	219096
Green	Ball Point Tex-Pens (26.8 cc)	219097

Tint Etching Marker



Creates black colour etchings on the surface of various types of metals such as stainless, iron, copper, brass alloys, etc., and does not fade away. This special fiber pen never drips and easily draws letters, figures and markings.

- The work surface remains even and the metal is not harmed by deep grooves or scratches
- The depth of the etching is approximately 20 microns
- Completely remove all grease and film from metal surface before use
- After marking you should prevent rust by protecting the surface with a proper rust inhibitor
- Marking can be polished (erased) with fine sandpaper
- You should avoid skin contact with the marking liquid. As a precaution, wash skin with soap and water at once contact has been made

Code
820382

Pneumatic Tapping Machines & Attachments



All Tapping Units Include:

- Pneumatic tapping spindle
- Stretch arm
- Slanted arm (302799 and 302801 only)
- Table mounting column
- Air unit
- 6 safety clutch tapping adapters

Model	Tap Capacity (Inch)	Speed (RPM)	Work Range Rmax./Rmin. (Inch)	Approximate Weight (lbs)	Code
AS-12/II	0-1/2	400	55.12/7.87	46.30	302799
AT-12/I	0-1/2	400	62.99/19.69	44.09	302800
AT-20/II	0-3/4	150/400	74.8/7.87	83.78	302801



Universal Tapping Attachments



Range	For Use on Tapping Unit	Approx. Weight (lbs)	Code
90°	302799, 302800	4.41	302803
90°	302801	4.41	302804

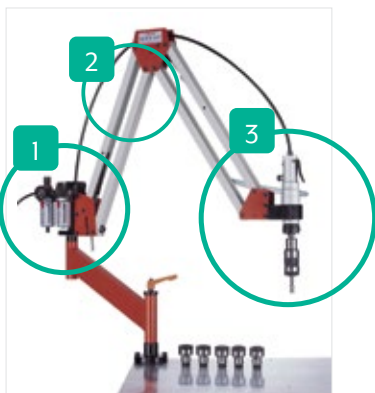

Replacement Parts

#	Description	For Model AS-12/II (302799)	For Model AT-12/I (302800)	For Model AT-20/II (302801)
1	Air Filter	302805	302805	302805
2	Tapping Arm	302878 (36")	302879 (57")	302880 (57")
3	Spindle	302875 302876 (HD)	302875 302876 (HD)	302877

Centerless Punch Grinders

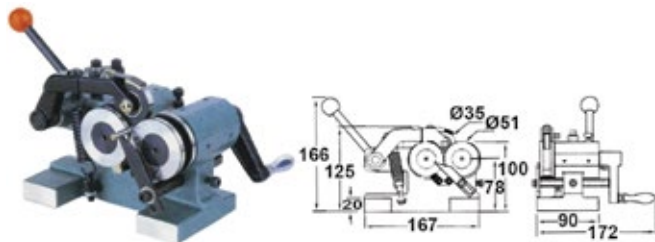

- High accuracy
- Centerless - no alignment necessary
- Rollers accept 0.06" – 1" diameters

Model	Weight	Code
PGA	5.5 kg	302470

Motorized

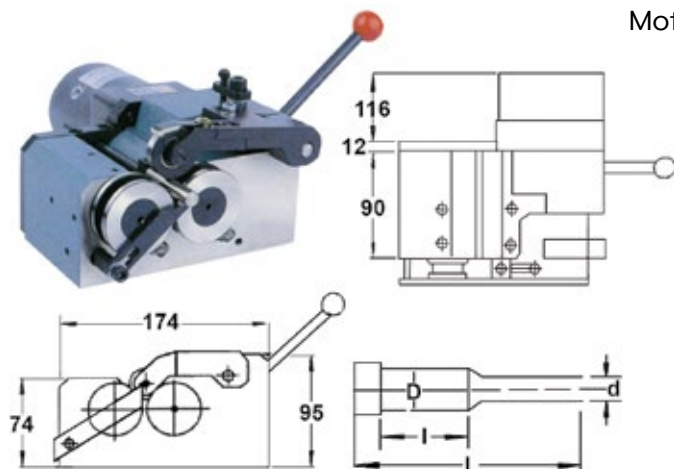

- Motor 110V, 25 watts
- Roller speed: 130 RPM
- D: 1.5-25mm
- d: 0.5-25mm
- L: maximum 120mm
- l: minimum 22mm

Model	Weight	Code
PGAM	11.5 kg	302471

Punch Formers

Tangential Style

Double Offset

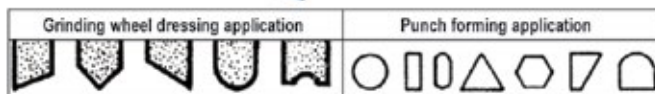

- Maximum diameter of workpiece: 32mm (1-1/4")
- V-Block: 30mm (1-3/16")
- Tangential travel: 20mm (25/32") either side of center
- V-Block adjusting system: rack and pinion
- Center height at 80mm (or 3-1/2")
- Indexing div: 24 (every 15°) ±10 seconds
- Angle setting: by sine system - gage blocks
- Roundness: 0.002mm (0.0001")
- Parallelism: within 0.005mm/50mm (0.0002 in 2")
- Squareness: within 0.005mm/50mm (0.0002 in 2")
- Construction: hardened tool steel throughout for long and accurate life
- Weight: 10 kgs (22 lbs.)

Code
875440

Single Offset

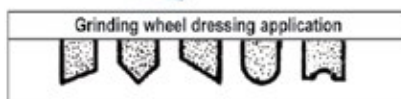

- Concentricity: within 0.003mm (0.0001")
- 24 index divisions (increments DF15°) within ±10 seconds
- Capacity: 32mm (1-1/4"), 90° V-blocks
- 30mm (1-1/8") through center hole
- Squareness and parallelism to within ±0.003 mm (±0.0001")
- Weight: 7.7 kg (17 lbs)

Code
865415

High Precision Punch Formers

Tangential Style – 1-1/4" Capacity

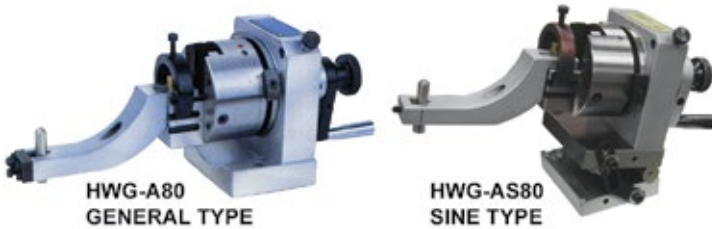

- Maximum diameter of workpiece: 1-1/4"
- Indexing ± 10 seconds: 24 (15°)
- Parallelism: 0.0001"
- Squareness: 0.0001"

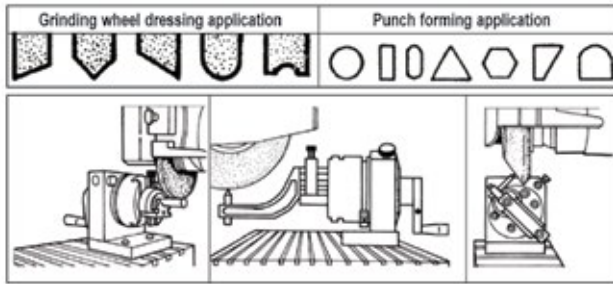

Model	Type	Center Height	Weight (lbs)	Code
HWG-A80	General	3.15	18	875510
HWG-AS80	Sine	4.49	25	875511

ER Collet Style Punch Formers

ER32 – 1/8" to 3/4" Capacity



- Indexing ± 10 seconds: 24 (15°)
- Through hole: 3/4"
- Parallelism: 0.0001"
- Squareness: 0.0001"

NOTE: Collets not included

Diameter Range (Inch)	Center Height (Inch)	Weight (lbs)	Code
0.04 - 0.78	3.15	15	875520
0.04 - 0.78	4.49	21	875521

Chuck Style Punch Formers

2" Capacity

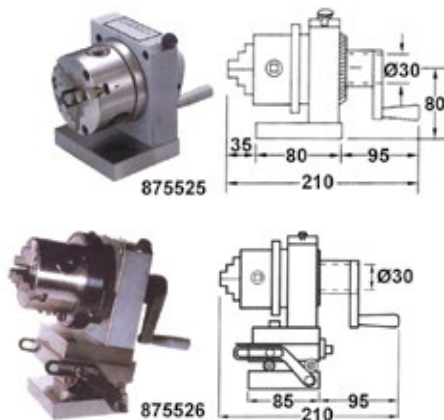

- Maximum diameter of workpiece: 2"
- Indexing ± 10 seconds: 24 (15°)
- Through hole: 3/4"
- Parallelism: 0.0001"
- Squareness: 0.0001"

Center Height (Inch)	Weight (lbs)	Code
3.15	18	875525
4.49	25	875526

Drive Pin Punches



- Made from tool steel
- Uniformly heat treated
- Knurled body for easy gripping
- Ground point

Set of 4 consists of:
 1/8", 5/32", 3/16" and 1/4"
 Other sets include all sizes in series

Size (Inch)	4" Long	6" Long	8" Long
	Code	Code	Code
1/16	460001	460011	-
3/32	460002	460012	-
1/8	460003	460013	-
5/32	460004	460014	-
3/16	460005	460015	460025
7/32	460006	460016	-
1/4	460007	460017	460027
5/16	460008	460018	460028
3/8	-	-	460029
Sets	460010 (4)	460020 (8)	460030 (5)

Center Punch Set

5-Pieces



- Tool steel with black oxide finish, hardened and tempered on both ends
- Knurled finger grip
- Supplied in storage case

Sizes Included (Inch)	INSIZE No.	Code
5 Pieces - 1/16" Diameter - 4" Length Point Sizes (Ø): 1/8, 3/6, 1/4, 5/16, and 3/8	7251	283977

Center Punches



- Center punches are made of hardened and tempered tool steel
- Round shank, knurled grip

Size (Inch)	Body Diameter (Inch)	Length (Inch)	Code
1/16	1/4	3	460031
5/64	5/16	4	460032
3/32	5/16	4	460033
9/64	3/8	4	460034
5/32	7/16	4	460035
Set (5)	-	-	460040

PUNCH FORMERS,
PUNCHES & SCRIBERS

Automatic Center Punches

Light Duty



- Pressure can be varied from 5 lbs. to approximately 30 lbs. simply by rotating knurled head
- Used for marking light dotting to heavy punching

Heavy Duty



- Fully automatic single hand operation
- Adjustable from very light to extra heavy markings
- Used for marking, punching, staking and riveting
- Replaceable point is made from hardened alloy steel
- Individually packed in vinyl pouch

Length (Inch)	Code
5	460051

Length (Inch)	Diameter (Inch)	Code
5-1/2	5/8	460050

Center Punch Sets



- Eight pieces per set
- 4" length
- Well proportioned for comfort
- Hardened and tempered
- Knurled finger grip for ease of use

Sizes Included Inch (mm)	Code
1/16 (1.5), 5/64 (2), 3/32 (2.5), 1/8 (3), 9/64 (3.5), 5/32 (4), 3/16 (5), and 7/32 (5.5)	460042

Surface Scriber Blocks



- Hardened steel base is ground and polished
- V-groove in base for cylindrical work
- Fine adjustment of spindle to any angle above or below base

Base (Inch)	Rod Length (Inch)	Code
2-3/16 x 1-5/8 x 3/4	7	460081
3-1/8 x 2-1/2 x 1	12	460082

Pocket Scriber



- Hardened steel point is reversible for protection when not in use
- Overall length: 89mm – 3-1/2"

Code
460070

Telescoping Magnetic Pick-Up and Flashlight



- Flashlight range: 118"
- For illumination and pick up metal parts in hidden areas
- Head can bend
- Telescoping handle, made of stainless steel
- Magnetic head and end
- With four LR44 batteries
- Battery life: 8h

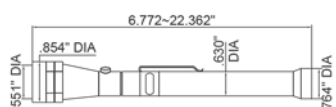

Magnetic Force of End (lbf)	Magnetic Force of Head (lbf)	Length (Inch)	INSIZE No.	Code
8	4.6	6.772-22.362	7163-1	877410

Flexible Pick-Up and Flashlight

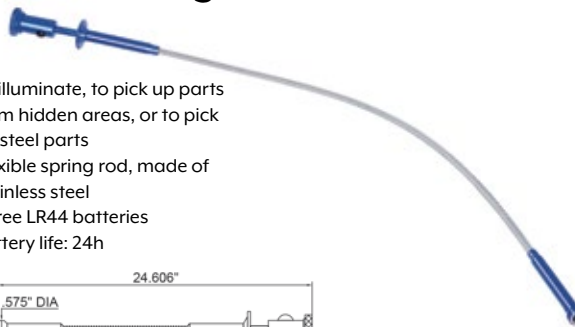

- To illuminate, to pick up parts from hidden areas, or to pick up steel parts
- Flexible spring rod, made of stainless steel
- Three LR44 batteries
- Battery life: 24h

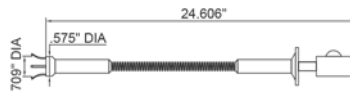

Magnetic Force (lbf)	Flashlight range (Inch)	INSIZE No.	Code
1.98	40	7164-1	877411

Surface Scriber Block

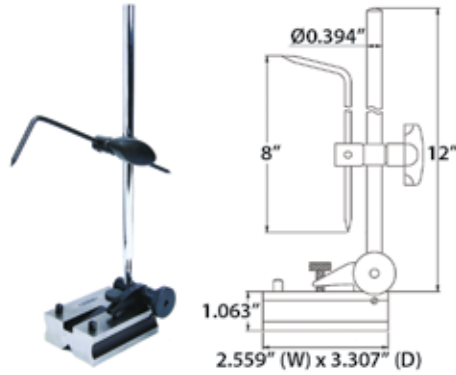

- Grooved bottom for cylinder
- Two pins to be set against the edge of the surface plate

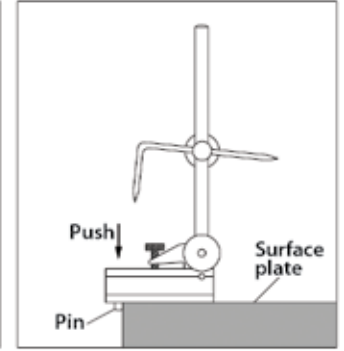
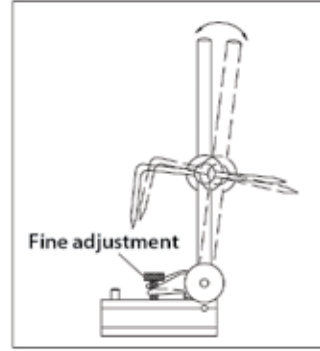

Base (Inch)	INSIZE No.	Code
1.063 x 2.559 x 3.307	6990-300A	283971

Telescoping Magnetic Pick-Up



- Pick up metal parts from hidden areas
- Rotation of the magnetic head: 360°
- Length of handle is adjustable
- Handle made of brass and chrome plated



Magnetic Tip (Inch)	Magnetic Force	Length (Inch)	INSIZE No.	Code
Ø.236	0.99lbf	7.008-22.913	7161-1	877206

Machinist's Scribes



Tip Style	Code
4-1/2	460061
7-1/2	460062
7-1/2	460063
7-1/2	460064
7	460065
4	460066
6-3/4	460067
10	460068

Machinist's Tool Set



Description	Individual	3-Piece Set
	Code	Code
Scriber	455501	
Center punch	455502	455505
Magnetic pick-up	455503	

PUNCH FORMERS,
PUNCHES & SCRIBERS

Transfer Punch Sets



- Overall length: 4-7/8"
- Inch sizes: 3/32" to 1/2" (plus 17/32") and 1/2" to 1" by 64ths
- Letter sizes: A to Z
- Wire Gage sizes: 1 to 60
- Metric sizes: 1mm to 13mm by 0.5mm
- All sets in metal indexed storage case

Individual punches also available

Description	Code
28 punches - 3/32" to 1/2" by 64ths, plus 17/32"	415090
26 punches - Letter Sizes A-Z	415093
60 punches - Wire Gage Sizes 1-60	415096
33 punches - 1/2" to 1" by 64ths	415099
25 punches - 1mm to 13mm by 0.5mm	415100

Universal Transfer Punches & Aligners

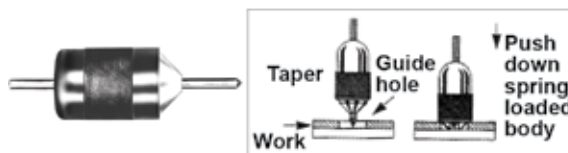

- Precision ground and spring loaded
- All parts made from steel and hardened
- Replaces different size transfer punches
- Centers top of 1/4" to 3/4" holes
- Perfect hole center alignment assured

Description	Weight (lbs)	Code
3/16" diameter, 3-1/8" long for 1/4" - 3/4" hole	0.26	604130
3/16" diameter, 4-1/8" long for 1/4" - 1-1/16" hole	0.46	604131

Steel Stamps

Letters & Numbers



Size (Inch)	Letter Stamps				Number Stamps			
	Straight Stamps		Reverse Stamps		Straight Stamps		Reverse Stamps	
	Stamp	Code	Stamp	Code	Stamp	Code	Stamp	Code
1/16	LP/1-16	416101	LP/R 1-16	416111	NP/1-16	416121	NP/R 1-16	416131
3/32	LP/3-32	416102	LP/R 3-32	416112	NP/3-32	416122	NP/R 3-32	416132
1/8	LP/1-8	416103	LP/R 1-8	416113	NP/1-8	416123	NP/R 1-8	416133
5/32	LP/5-32	416104	LP/R 5-32	416114	NP/5-32	416124	NP/R 5-32	416134
3/16	LP/3-16	416105	LP/R 3-16	416115	NP/3-16	416125	NP/R 3-16	416135
1/4	LP/1-4	416106	LP/R 1-4	416116	NP/1-4	416126	NP/R 1-4	416136

Machinist's Jack



- For use on drill presses, shapers, milling machines, planers, or any place where leveling is necessary
- Has a lifting capacity of approximately 1000 lbs
- Base is made of a heavy casting with adjustable steel screw and tilting swivel head, with lock nut for permanent positioning
- 3" high when closed and 4" high when fully extended

Code
416160

Punch & Die Set



- Cuts rubber, plastic, brass or steel up to 0.025" thick
- Clear plexiglas top lets you see where you are punching for greater accuracy
- Heat treated tool steel base
- Compact in size: 3-9/16" x 3-1/16"
- Weighs 2 lbs., 4 oz.

Sizes Included (Inch)	Code
1/8", 3/16", 1/4", 5/16", 3/8", 7/16", 1/2", 5/8", and 3/4"	455500

Pin Hand Chucks



Length (Inch)	Capacity (Inch)	Code
3	0 - 0.040	460181
3-1/2	0.030 - 0.062	460182
3-3/4	0.050 - 0.125	460183
4-1/8	0.115 - 0.187	460184
SET: 4 Pieces: 0 - 0.187" capacity		460185

Double End Pin Chuck



- Each end with a double end collet which can be reversed to desired size
- Nickel plated body made of tube to permit use of long wire or rods

Length (Inch)	Capacity (Inch)	Code
2-1/2	0 - 3/32	460186

Master Pin Chuck



- Hand drill and pin vise with swivel head
- With two double end collets
- Capacity: 0 to 0.125"

Code
460187

Spring Dividers



Carbon Steel with Hardened Points

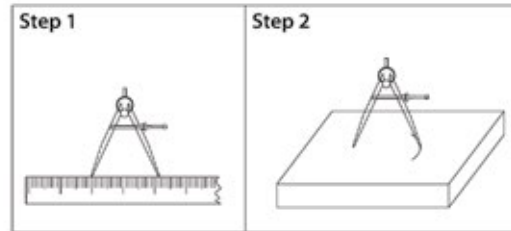
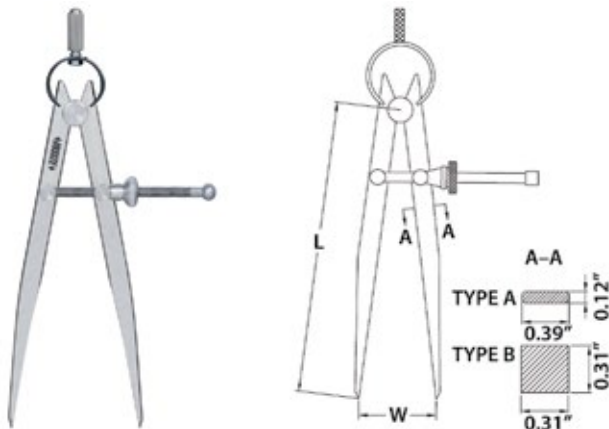

L Size (Inch)	W Range (Inch)	INSIZE No.	Code
6	0-5.91	7260-150	283897
8	0-8.27	7260-200	816417
10	0-10.24	7260-250	816418
12	0-12.60	7260-300	816419

Dividers



Carbon Steel with Hardened Points

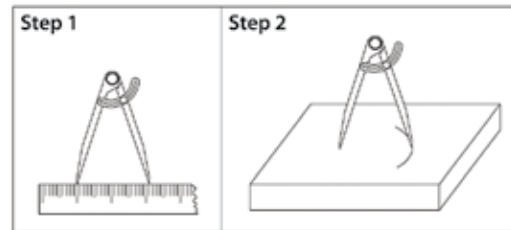
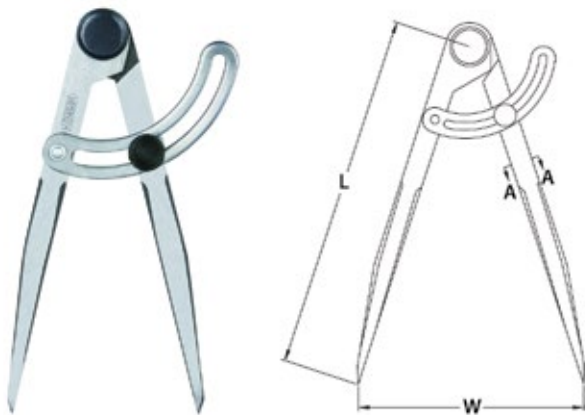

L Size (Inch)	W Range (Inch)	a (Inch)	INSIZE No.	Code
6	0-5.51	0.33	7247-150	283917
8	0-7.48	0.39	7247-200	283919
12	0-11.42	0.47	7247-300	283921

INSIDE/OUTSIDE CALIPERS & DIVIDERS

Inside Spring Caliper

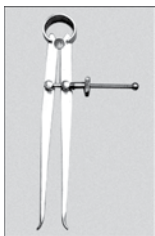

Size (Inch)	Code
3	810163
4	810164
6	810166
8	810168
10	810170
12	810172

Outside Spring Caliper



Size (Inch)	Code
3	810173
4	810174
6	810176
8	810178
10	810180
12	810182

Spring Divider

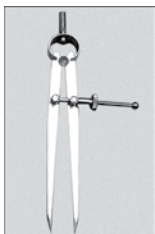

Size (Inch)	Code
3	810183
4	810184
6	810186
8	810188
10	810190
12	810192

Jenny Hermaphrodite Divider



Size (Inch)	Code
6	810194

Calipers

490-514



Micrometers

515-535



Indicators & Depth Gages

536-558



Magnetic Stands

562-566



Height Gages

567-568



Bore Gages

570-572



Thickness Gages

573-574



Gage Blocks

575-576



Levels & Protractors, Rules, Straight Edges & Squares

577-587



Gages

588-607



Edge & Center Finders, Zero Setting

608-609



Surface Roughness

610-612



Measuring Tool Sets

613-615



Hardness Testers

616-618



Microscopes

619-620



Surface Plates

621



Loupes & Magnifiers

622-626



Scales

627-628



Electronic Calipers

Standard Model

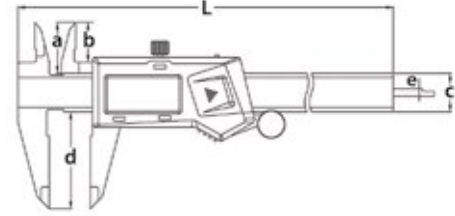

- Resolution: 0.0005"/0.01mm
- Buttons: on/off, zero, inch/mm
- Auto power off, move the digital unit to turn on power
- Battery CR2032
- Data output
- Stainless steel construction
- Supplied in fitted storage case

OPTIONAL ACCESSORY: SPC cable

Range (Inch/mm)	Accuracy (Inch)	L (Inch)	a (Inch)	b (Inch)	c (Inch)	d (Inch)	e (Inch)	INSIZE No.	Code
0-6/0-150	±0.0010	9.291	0.827	0.630	0.630	1.575	0.146	1108-150	817000
0-8/0-200	±0.0015	11.260	0.945	0.748	0.630	1.969	0.146	1108-200	817001
0-12/0-300	±0.0015	15.748	0.984	0.807	0.630	2.362	0.146	1108-300	817002

Electronic Caliper

Heavy Duty – 12 Inch/0-300mm

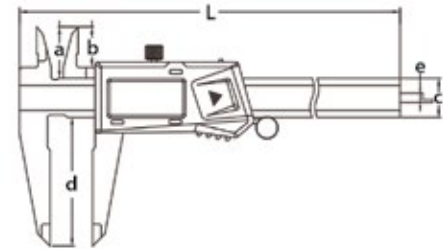

- Resolution: 0.0005"/0.01mm
- Buttons: on/off, zero, inch/mm
- Auto power off
- Battery CR2032
- Data output
- Stainless steel
- Supplied in fitted storage case

OPTIONAL ACCESSORY: SPC cable

Range (Inch/mm)	Accuracy (Inch)	L (Inch)	a (Inch)	b (Inch)	c (Inch)	d (Inch)	e (Inch)	INSIZE No.	Code
0-12/0-300	±0.0015	16.024	1.063	0.827	0.787	2.520	0.185	1196-300	877124

Electronic Calipers

Fractional Reading

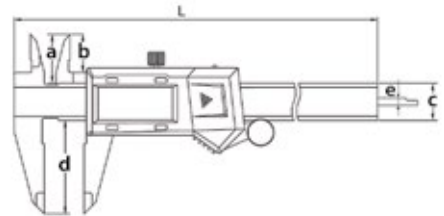

- Resolution: 0.0005", 1/128" (fractional), 0.01mm
- Buttons: zero, unit (mm/inch/fraction), ABS (absolute and incremental measurement), on/off
- Auto power off
- Battery CR2032
- Stainless steel construction
- Supplied in fitted storage case

Range (Inch/mm)	Accuracy (Inch)	L (Inch)	a (Inch)	b (Inch)	c (Inch)	d (Inch)	e (Inch)	INSIZE No.	Code
0-6/0-150	±0.0015	9.213	0.787	0.591	0.630	1.575	0.146	1102-150	280003
0-8/0-200	±0.0015	11.260	0.945	0.748	0.630	1.969	0.146	1102-200	280004
0-12/0-300	±0.0015	15.354	1.024	0.846	0.630	2.362	0.146	1102-300	280005

Electronic Calipers

Coolant Proof

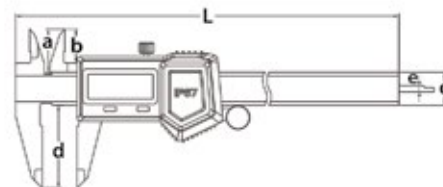

- Resolution: 0.0005"/0.01mm
- Coolant proof, IP67 Ingress protection level
- Button functions: zero, on/off, inch/mm, ABS/REL, hold
- Battery CR2032
- Stainless steel
- Supplied in fitted storage case

Range (Inch/mm)	Accuracy (Inch)	L (Inch)	a (Inch)	b (Inch)	c (Inch)	d (Inch)	e (Inch)	INSIZE No.	Code
0-6/0-150	±0.0015	9.291	0.827	0.630	0.630	1.575	0.146	1118-150B	816018
0-8/0-200	±0.0015	11.260	0.945	0.748	0.630	1.969	0.146	1118-200B	280014
0-12/0-300	±0.0015	15.748	0.984	0.807	0.669	2.362	0.146	1118-300B	280015

Electronic Calipers

Zinc Alloy Casing

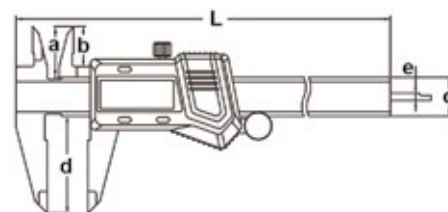

- Resolution: 0.0005"/0.01mm
- Zinc alloy casing
- Buttons: zero, on/off, inch/mm
- Auto power off, move the digital unit to turn on power
- Battery CR2032
- Stainless steel
- Supplied in fitted storage case

Range (Inch/mm)	Accuracy (Inch)	L (Inch)	a (Inch)	b (Inch)	c (Inch)	d (Inch)	e (Inch)	INSIZE No.	Code
0-6/0-150	±0.0015	9.291	0.827	0.630	0.630	1.575	0.146	1114-150A	816012
0-8/0-200	±0.0015	11.260	0.945	0.748	0.630	1.969	0.146	1114-200A	816014
0-12/0-300	±0.0015	15.748	0.984	0.807	0.669	2.362	0.146	1114-300A	816016

Electronic Caliper

Round Depth Bar

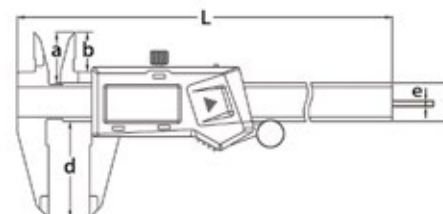

- Resolution: 0.0005"/0.01mm
- Buttons: on/off, zero, inch/mm
- Auto power off
- Battery CR2032
- Data output
- Stainless steel
- Supplied in fitted storage case

OPTIONAL ACCESSORY: SPC cable

Range (Inch/mm)	Accuracy (Inch)	L (Inch)	a (Inch)	b (Inch)	c (Inch)	d (Inch)	Øe (Inch)	INSIZE No.	Code
0-6/0-150	±0.0015	9.291	0.827	0.630	0.630	1.575	0.063	1119-150	877109

Electronic Caliper

Plastic

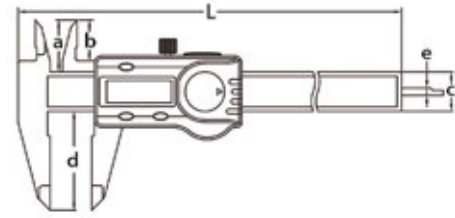

- Hard plastic – non-magnetic, non-conductive
- Resolution: 0.0005"/0.01mm
- Buttons: zero, on/off, inch/mm
- Auto power off
- Battery CR2032
- Supplied in fitted storage case

Range (Inch/mm)	Accuracy (Inch)	L (Inch)	a (Inch)	b (Inch)	c (Inch)	d (Inch)	e (Inch)	INSIZE No.	Code
0-6/0-150	±0.004	9.252	0.768	0.591	0.630	1.575	0.146	1139-150	280024

Electronic Calipers

Carbide Tipped Jaws

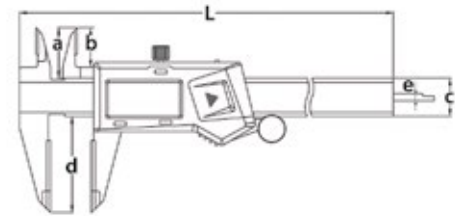

- Resolution: 0.0005"/0.01mm
- Wear resistant carbide tipped jaws for inside and outside measurements
- Buttons: zero, on/off, inch/mm
- Auto power off
- Battery CR2032
- Stainless steel
- Data output
- Supplied in fitted storage case

OPTIONAL ACCESSORY: SPC cable

Range (Inch/mm)	Accuracy (Inch)	L (Inch)	a (Inch)	b (Inch)	c (Inch)	d (Inch)	e (Inch)	INSIZE No.	Code
0-6/0-150	±0.0015	9.291	0.827	0.630	0.630	1.575	0.146	1110-150A	280021
0-8/0-200	±0.0015	11.260	0.945	0.748	0.630	1.969	0.146	1110-200A	280022
0-12/0-300	±0.0015	15.748	0.984	0.807	0.630	2.362	0.146	1110-300A	280023

Digimatic Calipers

ABSOLUTE Encode Technology



- Resolution: 0.0005"/0.01mm
- Inch/metric
- Coolant proof, IP67 Ingress protection level
- Absolute function
- Automatic on/off
- Dust and chip proof
- Data output

Range (Inch/mm)	Accuracy (Inch)	SPC	Code
0-6/0-150	±0.001	Without SPC	500-752-20

Electronic Calipers

Absolute

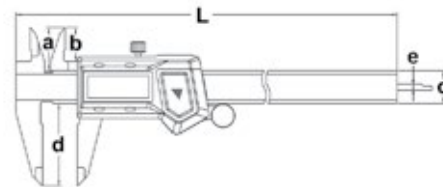

- Absolute system
- Resolution: 0.0005"/0.01mm
- Buttons: Inch/mm, ABS/REL, on/off, origin set
- Battery CR2032
- Auto power off, move unit to turn power on
- Data output
- Stainless steel
- Supplied in fitted storage case

OPTIONAL ACCESSORY: SPC cable

Range (Inch/mm)	Accuracy (Inch)	L (Inch)	a (Inch)	b (Inch)	c (Inch)	d (Inch)	e (Inch)	INSIZE No.	Code
0-6/0-150	±0.0008	9.213	0.787	0.591	0.630	1.575	0.146	1103-150	285127
0-8/0-200	±0.0008	11.260	0.945	0.748	0.630	1.969	0.146	1103-200	285128
0-12/0-300	±0.0012	15.354	1.024	0.845	0.630	2.362	0.146	1103-300	285129

Electronic Calipers

Miniature

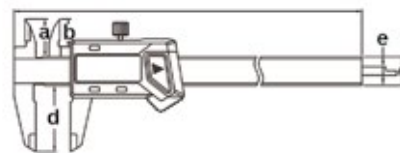

- Resolution: 0.0005"/0.01mm
- Buttons: zero, on/off, inch/mm
- Auto power off
- Battery LR44
- Stainless steel
- Supplied in fitted storage case

Range (Inch/mm)	Accuracy (Inch)	L (Inch)	a (Inch)	b (Inch)	c (Inch)	d (Inch)	e (Inch)	INSIZE No.	Code
0-3/0-75	±0.0010	5.669	0.669	0.492	0.512	1.181	0.146	1111-75A	280019
0-4/0-100	±0.0010	6.693	0.669	0.492	0.512	1.181	0.146	1111-100A	280020

Electronic Calipers

Left Hand

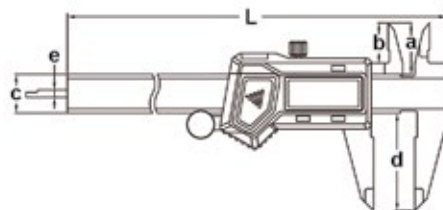

- Designed for left-handed users
- Resolution: 0.0005"/0.01mm
- Buttons: on/off, zero, inch/mm
- Battery CR2032
- Auto power off, move unit to turn power on
- Data output
- Stainless steel
- Supplied in fitted storage case

OPTIONAL ACCESSORY: SPC cable

Range (Inch/mm)	Accuracy (Inch)	L (Inch)	a (Inch)	b (Inch)	c (Inch)	d (Inch)	e (Inch)	INSIZE No.	Code
0-6/0-150	±0.0015	9.291	0.827	0.630	0.630	1.575	0.146	1130-150	816615
0-8/0-200	±0.0015	11.260	0.945	0.748	0.630	1.969	0.146	1130-200	816616
0-12/0-300	±0.0015	15.748	0.984	0.807	0.630	2.362	0.146	1130-300	816617

Electronic Caliper

12 Inch/300mm

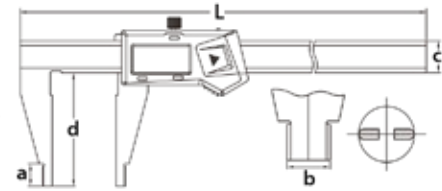

- Resolution: 0.0005"/0.01mm
- Buttons: on/off, zero, inch/mm
- Battery CR2032
- Auto power off, move unit to turn power on
- Data output
- Stainless steel
- Supplied in fitted storage case

OPTIONAL ACCESSORY: SPC cable

Range (Inch/mm)	Accuracy (Inch)	L (Inch)	a (Inch)	b (Inch)	c (Inch)	d (Inch)	INSIZE No.	Code
0-12/0-300	±0.0015	16.535	0.427	0.500	0.669	2.953	1522-127	816686

Electronic Caliper

12 Inch/300mm

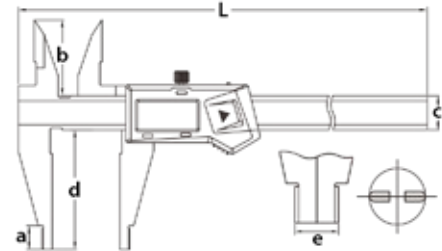

- Resolution: 0.0005"/0.01mm
- Buttons: on/off, zero, inch/mm
- Battery CR2032
- Auto power off, move unit to turn power on
- Data output
- Stainless steel
- Supplied in fitted storage case

OPTIONAL ACCESSORY: SPC cable

Range (Inch/mm)	Accuracy (Inch)	L (Inch)	a (Inch)	b (Inch)	c (Inch)	d (Inch)	e (Inch)	INSIZE No.	Code
0-12/0-300	±0.0015	16.535	0.427	1.102	0.669	2.953	0.500	1523-127	816687

Electronic Calipers

Long Range – 24 to 80 Inch/600 to 2000mm

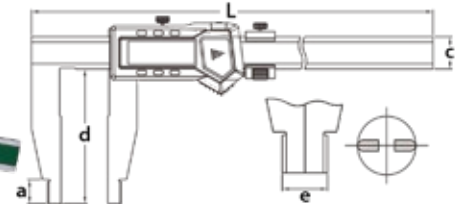

- Resolution: 0.0005"/0.01mm
- Button function: on/off, zero, inch/mm, ABS, data preset
- Battery CR2032
- Stainless steel
- Data output
- Supplied in fitted storage case

OPTIONAL ACCESSORY: SPC cable

Range (Inch/mm)	Accuracy (Inch)	L (Inch)	a (Inch)	c (Inch)	d (Inch)	e (Inch)	INSIZE No.	Code
0-24/0-600	±0.0020	30.315	0.709	0.945	3.937	0.800	1131-24	876221
0-40/0-1000	±0.0030	48.031	0.945	1.220	5.906	0.800	1131-40	876222
0-60/0-1500	±0.0045	70.079	0.945	1.654	5.906	0.800	1131-60	816618
0-80/0-2000	±0.0055	90.157	0.945	1.654	5.906	0.800	1131-80	280063

Electronic Caliper

Long Range – 40 Inch/1000mm



OPTIONAL ACCESSORY: SPC cable

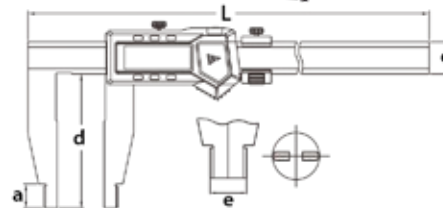

- Resolution: 0.0005"/0.01mm
- Button function: on/off, zero, inch/mm, ABS, data preset
- Battery CR2032
- Stainless steel
- Data output
- Supplied in fitted storage case

Range (Inch/mm)	Accuracy (Inch)	L (Inch)	a (Inch)	c (Inch)	d (Inch)	e (Inch)	INSIZE No.	Code
0-40/0-1000	±0.0030	48.031	0.945	1.220	5.906	0.787	1106-1102	280051

Electronic Calipers

Long Range – 24 & 40 Inch/600 & 1000mm

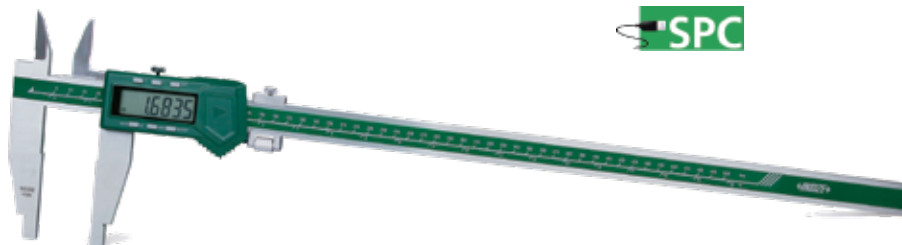

OPTIONAL ACCESSORY: SPC cable

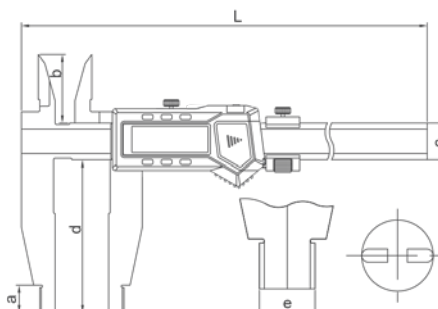

- Resolution: 0.0005"/0.01mm
- Button function: on/off, zero, inch/mm, ABS, data preset
- Battery CR2032
- Stainless steel
- Data output
- Supplied in fitted storage case

Range (Inch/mm)	Accuracy (Inch)	L (Inch)	a (Inch)	b (Inch)	c (Inch)	d (Inch)	e (Inch)	INSIZE No.	Code
0-24/0-600	±0.0020	30.315	0.709	1.772	0.945	3.937	0.800	1133-24	285061
0-40/0-1000	±0.0030	48.031	0.945	2.362	1.220	5.906	0.800	1133-40	285062

Electronic Calipers



OPTIONAL ACCESSORY: SPC cable

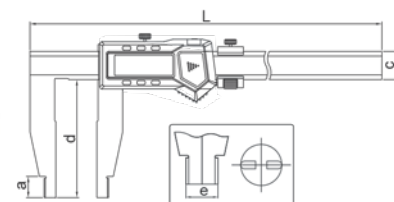

- Resolution: 0.01mm/0.0005"
- Button function: on/off, zero, mm/inch, ABS, data preset
- Battery CR2032
- Stainless steel
- Supplied in fitted storage case

Range (Inch/mm)	Accuracy (mm)	L (mm)	a (mm)	c (mm)	d (mm)	e (mm)	INSIZE No.	Code
0-12/0-300	±0.05	420	18	24	100	20	1106-301	280031
0-12/0-300	±0.05	420	18	24	150	20	1106-302	280032
0-24/0-600	±0.05	770	18	24	100	20	1106-601	280042
0-24/0-600	±0.06	770	24	31	200	20	1106-603	280044

Long Range Electronic Caliper

20 & 40 Inch/500 & 1000mm

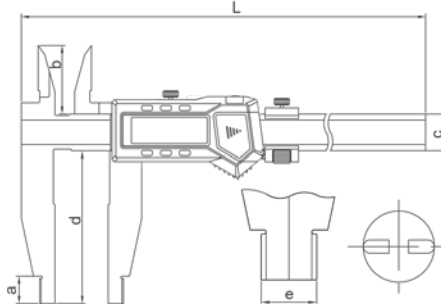
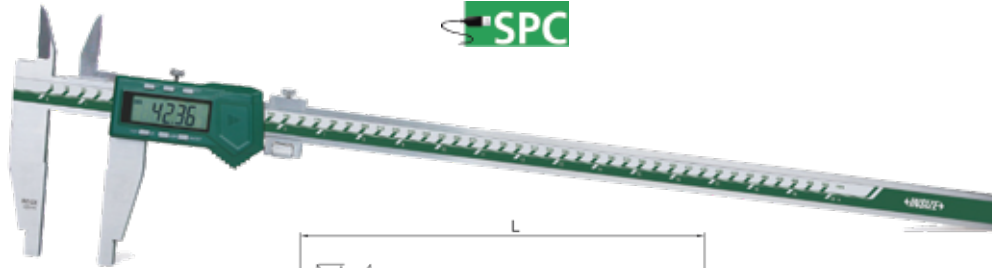

- Resolution: 0.01mm/0.0005"
- Button function: on/off, zero, mm/inch, ABS, data preset
- Battery CR2032
- Data output
- Stainless steel
- Supplied in fitted storage case

OPTIONAL ACCESSORY: SPC cable

Range (mm/Inch)	Accuracy (mm)	L (mm)	a (mm)	b (mm)	c (mm)	d (mm)	e (mm)	INSIZE No.	Code
0-300/0-12	±0.05	420	18	45	24	100	20	1136-301	280112
0-500/0-20	±0.05	675	18	45	24	100	20	1136-501	280117
0-1000/0-40	±0.08	1220	24	60	31	150	20	1136-1002	816022

Sizes available up to 2000mm/80"

Electronic Gear Tooth Calipers

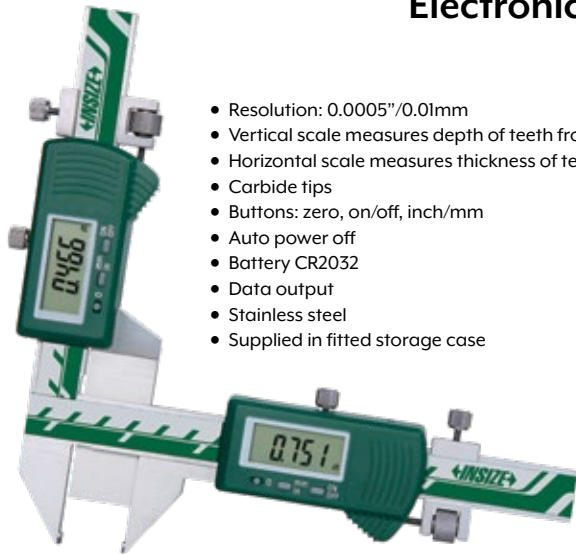

- Resolution: 0.0005"/0.01mm
- Vertical scale measures depth of teeth from the top to the pitch line
- Horizontal scale measures thickness of teeth in the pitch line
- Carbide tips
- Buttons: zero, on/off, inch/mm
- Auto power off
- Battery CR2032
- Data output
- Stainless steel
- Supplied in fitted storage case

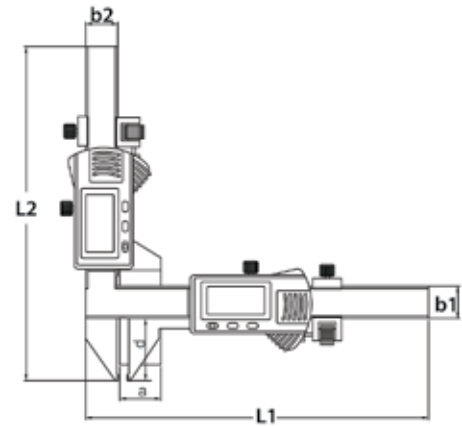
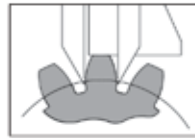

Range	Accuracy (Inch)	L1 (Inch)	L2 (Inch)	a (Inch)	b1 (Inch)	b2 (Inch)	d (Inch)	INSIZE No.	Code
PI-P24	±0.0015	6.693	6.516	0.827	0.630	0.630	1.201	1181-M25A	280658
PI/2-P5	±0.0015	8.661	7.480	1.988	0.630	0.630	2.165	1181-M50A	280659

Universal Caliper



- Resolution: 0.01mm/0.0005"
- Buttons: on/off, set, inch/mm, ABS, preset (+, -)
- Battery CR2032
- Data output
- Stainless steel
- Includes: Half disk points, spherical points, measuring jaws, depth stop
- Supplied in fitted storage case

Range (mm/Inch)	Accuracy (Inch)	L (Inch)	INSIZE No.	Code
0-600/0-24	±0.002	30.6	1125-600	877100

Electronic Inside Groove Caliper

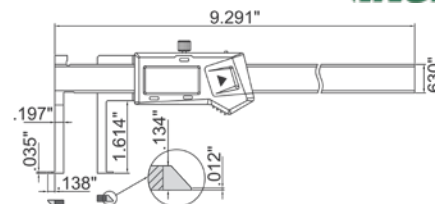
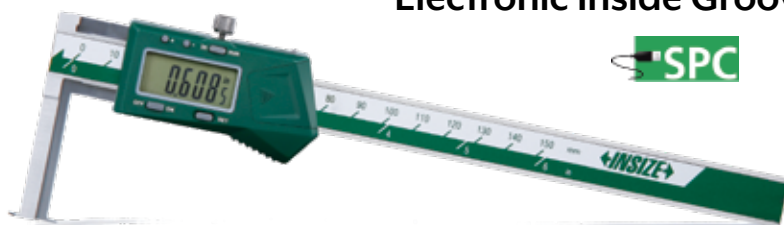

- Measures groove diameter inside small bores
- Resolution: 0.0005"/0.01mm
- Buttons: on/off, set, inch/mm, preset (+, -)
- Auto power off - move unit to turn on
- Battery CR2032
- Data output
- Stainless steel
- Supplied in fitted storage case

Range (mm/Inch)	Accuracy (Inch)	INSIZE No.	Code
11-150/0.43-6	±0.0015	1520-150	877105

Electronic Outside Groove Caliper

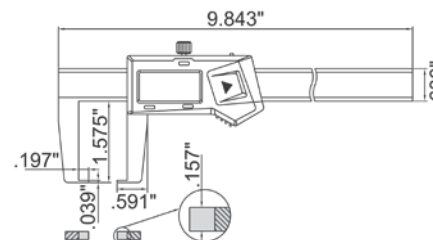

- Measures grooves and recesses
- Resolution: 0.0005"/0.01mm
- Buttons: on/off, zero, inch/mm
- Auto power off - move unit to turn on
- Battery CR2032
- Data output
- Stainless steel
- Supplied in fitted storage case

Range (mm/Inch)	Accuracy (Inch)	INSIZE No.	Code
0-150/0-6	±0.0015	1187-150A	280505

Electronic Outside Point Caliper

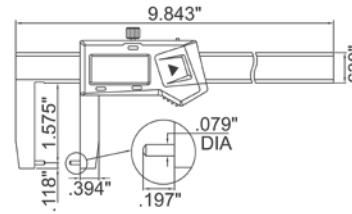

- Measures wall thickness inside bores and recesses
- Resolution: 0.0005"/0.01mm
- Buttons: on/off, zero, inch/mm
- Auto power off - move unit to turn on
- Battery CR2032
- Data output
- Stainless steel
- Supplied in fitted storage case

Range (mm/Inch)	Accuracy (Inch)	INSIZE No.	Code
0-150/0-6	±0.0015	1185-150A	280514

Electronic Blade Caliper

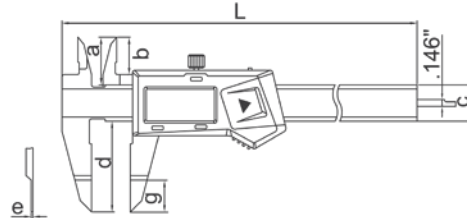
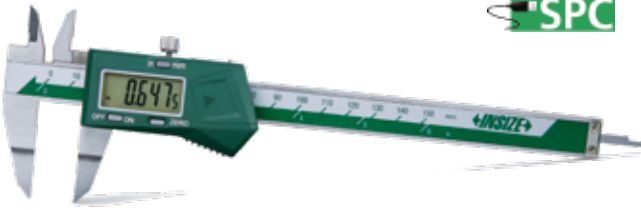

- Blade jaws fit into small grooves
- Resolution: 0.0005"/0.01mm
- Buttons: on/off, zero, inch/mm
- Auto power off - move unit to turn on
- Battery CR2032
- Data output
- Stainless steel
- Supplied in fitted storage case

Range (mm/Inch)	Accuracy (Inch)	L (Inch)	a (Inch)	b (Inch)	c (Inch)	d (Inch)	e (Inch)	g (Inch)	INSIZE No.	Code
0-150/0-6	±0.0015	9.291	0.827	0.63	0.63	1.575	0.3	0.669	1188-150A	280580

Electronic Small Point Caliper

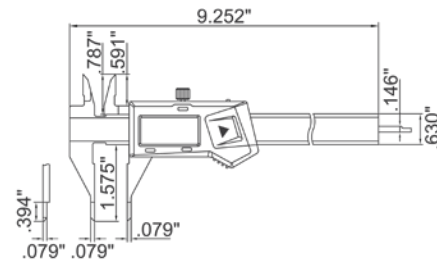

- Small pointed jaws fit into small grooves and recesses
- Resolution: 0.0005"/0.01mm
- Buttons: on/off, zero, inch/mm
- Auto power off - move unit to turn on
- Battery CR2032
- Data output
- Stainless steel
- Supplied in fitted storage case

Range (mm/Inch)	Accuracy (Inch)	INSIZE No.	Code
0-150/0-6	±0.0015	1169-150	877119

Electronic Inside Knife-Edge Caliper

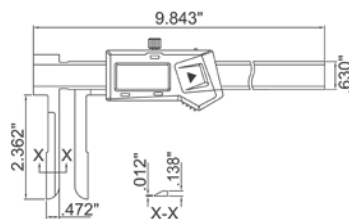
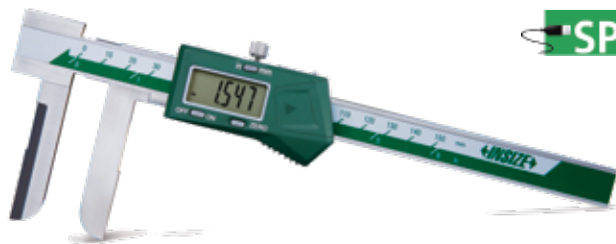

- Measures diameter of deep step holes
- Resolution: 0.0005"/0.01mm
- Buttons: on/off, zero, inch/mm
- Auto power off - move unit to turn on
- Battery CR2032
- Data output
- Stainless steel
- Supplied in fitted storage case

Range (mm/Inch)	Accuracy (Inch)	INSIZE No.	Code
15-150/0.6-6	±0.002	1123-150A	280589

Electronic Offset Caliper

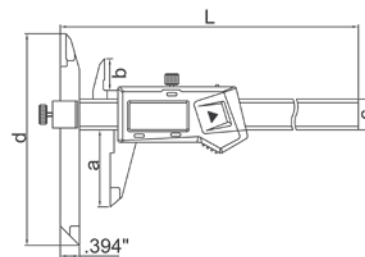
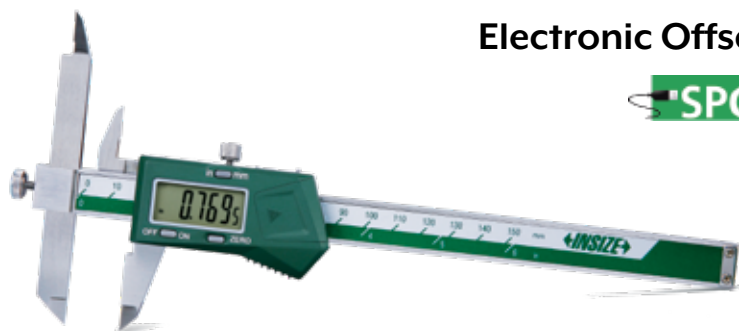

- Left jaw slides up and down to facilitate measurement of stepped sections
- Resolution: 0.0005"/0.01mm
- Buttons: on/off, zero, inch/mm
- Auto power off - move unit to turn on
- Battery CR2032
- Data output
- Stainless steel
- Supplied in fitted storage case

Range (mm/Inch)	Accuracy (Inch)	L (Inch)	a (Inch)	b (Inch)	c (Inch)	d (Inch)	INSIZE No.	Code
0-150/0-6	±0.0015	9.409	1.575	0.65	0.669	4.331	1186-150A	280625

Electronic Tube Thickness Caliper

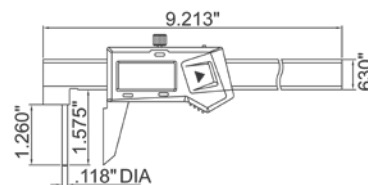

- Measures wall thickness of tubes
- Resolution: 0.0005"/0.01mm
- Buttons: on/off, zero, inch/mm
- Auto power off - move unit to turn on
- Battery CR2032
- Data output
- Stainless steel
- Supplied in fitted storage case

Range (mm/Inch)	Accuracy (Inch)	INSIZE No.	Code
0-150/0-6	±0.002	1161-150A	280502

Electronic RTJ Ring Groove Caliper



- Measures ring grooves of flange
- Resolution: 0.0005"/0.01mm
- Buttons: on/off, set, zero, inch/mm, data preset
- Auto power off - move unit to turn on
- Battery CR2032
- Data output
- Stainless steel
- Supplied in fitted storage case

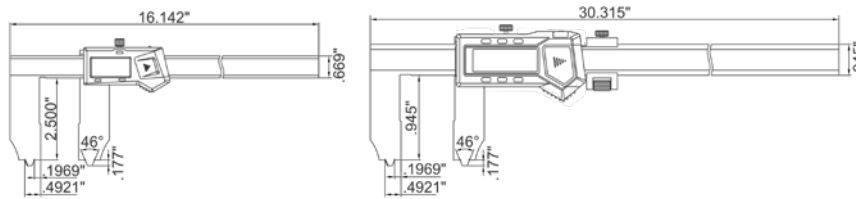

Range inside diameter of RTJ ring groove (Inch/mm)	Range outside diameter of RTJ ring groove (Inch/mm)	Accuracy (Inch)	Angle of RTJ ring groove	INSIZE No.	Code
0.4-12/10-300	1-12/25-300	±0.0025	23°	1179-300	877121
0.4-24/10-600	1-24/25-600	±0.003	23°	1179-600	877122

Electronic Caliper with Large Measuring Face

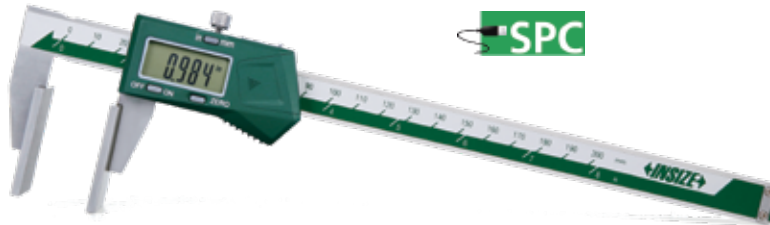

- Measures diameters of wire ropes and thickness of soft materials like rubber, sponge, etc.
- Resolution: 0.0005"/0.01mm
- Buttons: on/off, zero, inch/mm
- Auto power off - move unit to turn on
- Battery CR2032
- Data output
- Stainless steel
- Supplied in fitted storage case

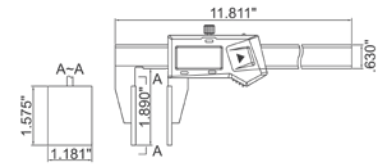

Range (mm/Inch)	Accuracy (Inch)	INSIZE No.	Code
0-200/0-8	±0.003	1172-200	877104

Electronic Hook Caliper



- Measure width and distance of grooves inside bores
- Resolution: 0.01mm/0.0005"
- Buttons: on/off, zero, mm/inch
- Automatic power off, move the digital unit to turn on power
- Battery CR2032
- Data output
- Stainless steel
- Supplied in fitted storage case



Range (mm/Inch)	Accuracy (mm)	INSIZE No.	Code
4-300/0.16-12	±0.04	1122-300	280645

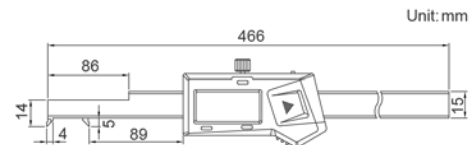

Electronic Disk Brake and Pad Caliper

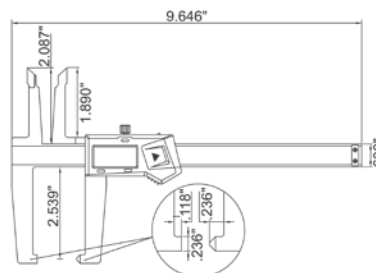
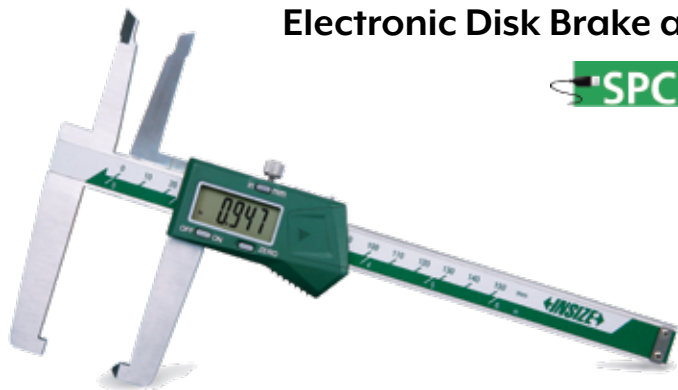

- Measures thickness of disk brakes and pad wear
- Resolution: 0.0005"/0.01mm
- Buttons: on/off, zero, inch/mm
- Auto power off - move unit to turn on
- Battery CR2032
- Data output
- Stainless steel
- Supplied in fitted storage case

Range (mm/Inch)	Accuracy (Inch)	INSIZE No.	Code
0-150/0-6	±0.003	1167-150A	877118

Electronic Depth Caliper



With Mounting Holes for Extension Base

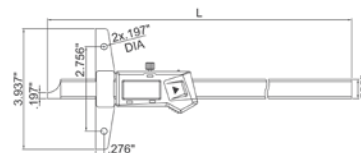

- Resolution: 0.0005"/0.01mm
- Buttons: on/off, zero, inch/mm
- Auto power off - move unit to turn on
- Battery CR2032
- Data output
- Stainless steel
- Supplied in fitted storage case

Range (mm/Inch)	Accuracy (Inch)	L (Inch)	INSIZE No.	Code
0-150/0-6	±0.0015	9.331	1147-150	285130
0-200/0-8	±0.0015	11.299	1147-200	285131
0-300/0-12	±0.0015	15.866	1147-300	285132

Extension Base



- Supplied with two screws
- Stainless steel
- Suitable for depth calipers series 1147 and 1148

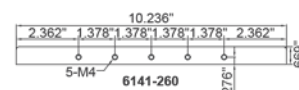
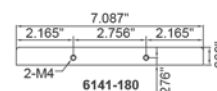

L (Inch)	INSIZE No.	Code
7.087	6141-180	280750
10.236	6141-260	280751
12.598	6141-320	280752

Electronic Depth Caliper with Round Depth Bar



- Resolution: 0.0005"/0.01mm
- Supplied with three interchangeable points - flat, spherical, disk
- With mounting holes for extension base
- Buttons: on/off, set, inch/mm, preset (+, -)
- Auto power off - move unit to turn on
- Battery CR2032
- Data output
- Stainless steel
- Supplied in fitted storage case

Range (mm/Inch)	Accuracy	L	d	INSIZE No.	Code
0-100/0-4	±0.02mm	200mm	85mm	1148-100E	877278
0-200/0-8	±0.0015"	11.811"	3.976"	1148-200E	877103

*When disk points are used range is reduced by 0.394"

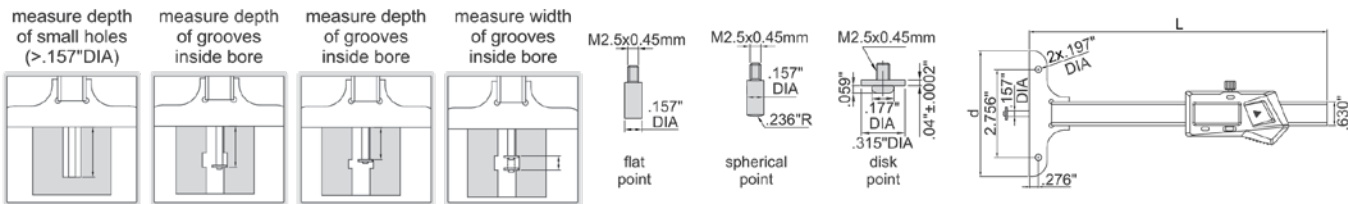

Electronic Point Depth Caliper



- Resolution: 0.0005"/0.01mm
- Buttons: on/off, zero, inch/mm
- Auto power off - move unit to turn on
- Battery CR2032
- Data output
- Stainless steel
- Supplied in fitted storage case

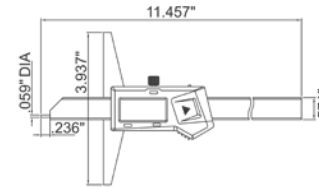
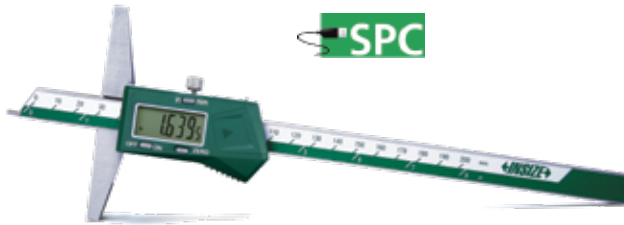

Range (mm/Inch)	Accuracy (Inch)	INSIZE No.	Code
0-200/0-8	±0.0015	1143-200A	877004

Accessory Set for Electronic Calipers



- Suitable for 0-6"/0-150mm and 0-8"/0-200mm electronic calipers (thickness of lower jaws ≤ 0.146")

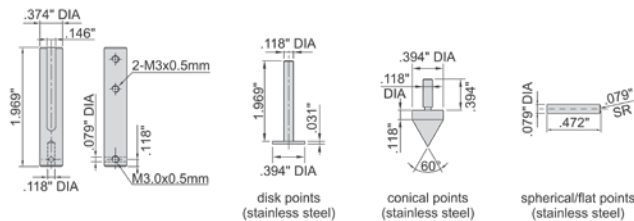

INSIZE No.	Code
6144	877188

Wireless Electronic Caliper



- Built-in wireless data transmission module, Zigbee signal Transmission distance is 10 meter (under the condition of no obstruction and no electromagnetic interference)
- Resolution: 0.01mm/0.0005"
- Buttons: on/off, zero, mm/inch, data transmission
- Automatic power off, move the digital unit to turn on power
- Battery CR2032
- Stainless steel
- Supplied in fitted storage case

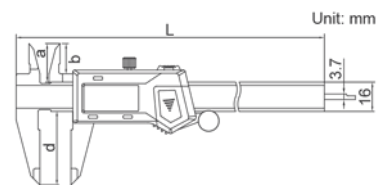

Range (Inch/mm)	Accuracy (mm)	L (mm)	a (mm)	b (mm)	d (mm)	INSIZE No.	Code
0-6/0-150	±0.03	236				1113-150	877275

Electronic Disk Brake Caliper



- Measure thickness of disk brakes
- Resolution: 0.01mm/0.0005"
- Buttons: on/off, zero, mm/inch
- Automatic power off, move the digital unit to turn on power
- Battery CR2032
- Stainless steel
- Supplied in fitted storage case

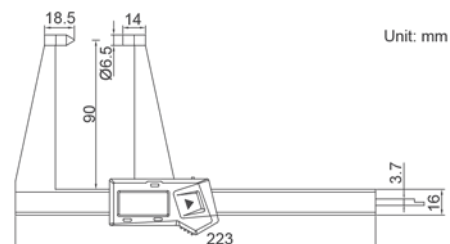

Range (mm/Inch)	Accuracy (mm)	INSIZE No.	Code
0-125/0-5	±0.05	1162-125A	284529

Electronic Point Caliper



- Pointed jaws fit into small grooves and recesses
- Resolution .0005"/0.01mm
- Buttons: on/off, zero, inch/mm
- Automatic power off, move the digital unit to turn on power
- Battery CR2032
- Data output
- Stainless steel
- Supplied in fitted storage case

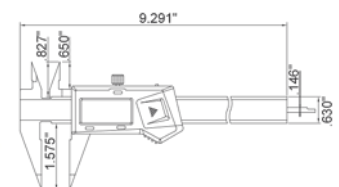

Range (mm/Inch)	Accuracy (Inch)	INSIZE No.	Code
0-150/0-6	±0.0015	1183-150A	280569

Electronic Caliper

Interchangeable Points



Short spherical/flat points

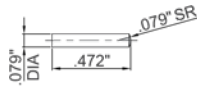

Long spherical/flat points

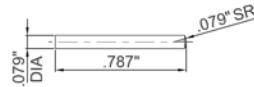

Short spherical blade points

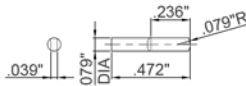

Long spherical blade points

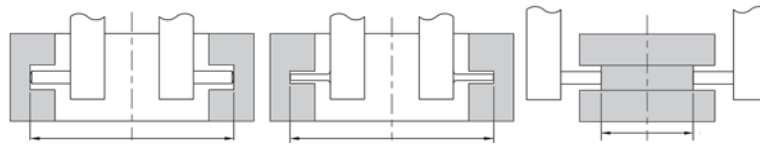
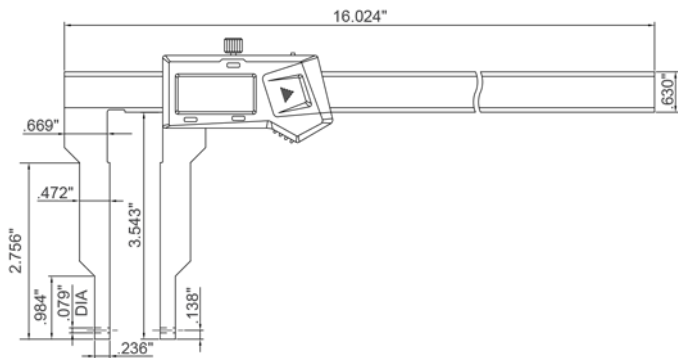
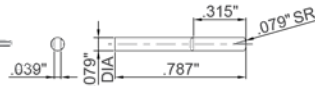

Spherical points for groove (inside hole) measurement

Spherical blade points for narrow groove (inside hole) measurement

Flat points for external groove measurement

- Supplied with 4 pairs of points and a zero setting block for external measurement
- Resolution: 0.0005"/0.01mm
- Buttons: on/off, set, inch/mm, preset (+, -)
- Auto power off, move unit to turn on
- Battery CR2032
- Stainless steel
- Data output
- Supplied in fitted storage case

OPTIONAL ACCESSORIES: SPC cable, Points, and Depth Stops

Points	Range (Inch/mm)	Accuracy (Inch)	Application	INSIZE No.	Code
Short spherical/flat	1-12.7/24-324 (Internal) 0-11.3/0-288 (External)	±0.0015	Spherical points for grooves inside small holes, flat points for external grooves	1124-300A	816619
Long spherical/flat	1.5-13.3/40-340 (Internal) 0-10.7/0-272 (External)	±0.0015	Spherical points for grooves inside large holes, flat points for external grooves		
Short spherical/blade	1-12.7/24-324 (Internal) 0-11.3/0-288 (External)	±0.0015	For narrow grooves inside small holes		
Long spherical/blade	1.5-13.3/40-340 (Internal) 0-10.7/0-272 (External)	±0.0015	For narrow grooves inside large holes		

Electronic Caliper

Interchangeable Points

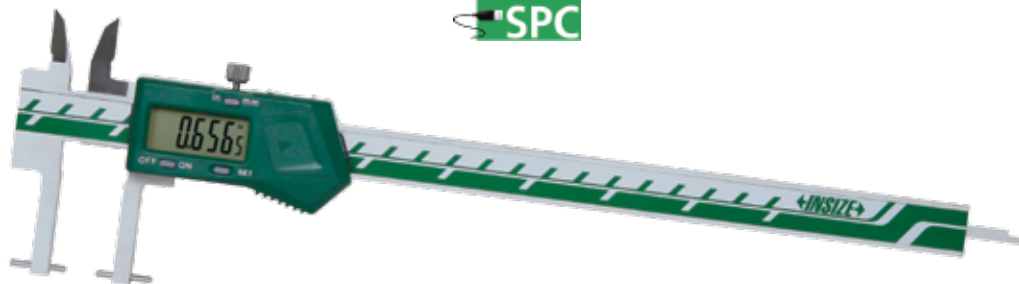

Short spherical points



Long spherical/flat points

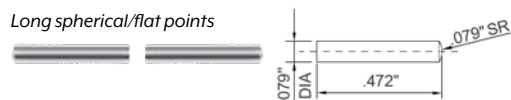

Spherical blade points

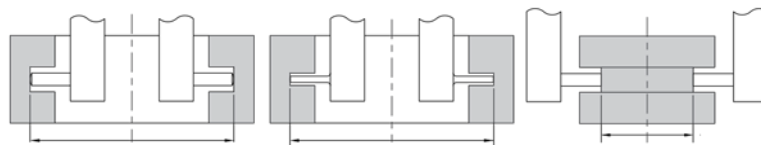
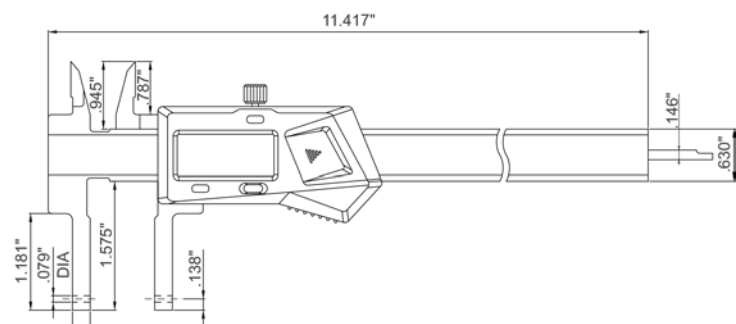
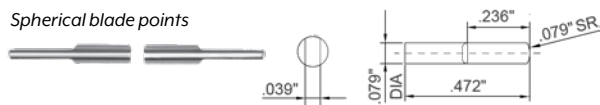

Spherical points for groove (inside hole) measurement

Spherical blade points for narrow groove (inside hole) measurement

Flat points for external groove measurement

- Supplied with 3 pairs of points and a zero setting block for external measurement
- Resolution: 0.0005"/0.01mm
- Buttons: on/off, set, inch/mm, preset (+, -)
- Auto power off, move unit to turn on
- Battery CR2032
- Stainless steel
- Data output
- Supplied in fitted storage case

OPTIONAL ACCESSORIES: SPC cable, Point Sleeve, and Depth Stop

Points	Range (Inch/mm)	Accuracy (Inch)	Application	INSIZE No.	Code
Short spherical	0.5-8.5/12-212 (Internal)	±0.0015	Spherical points for grooves inside small holes		
Long spherical/flat	1-8.8/24-224 (Internal) 0-7.5/0-187 (External)	±0.0015	Spherical points for grooves inside holes, flat points for external grooves	1526-200	816620
Spherical blade	1-8.8/24-224 (Internal) 0-7.5/0-187 (External)	±0.0015	For narrow grooves inside holes		

Depth Stops for Calipers



- Supplied in pairs
- Suitable for INSIZE caliper series no.: 1124, 1526, 1520, 1176, 1178, 1120, 1121, 1187, and 1185
- Stainless steel

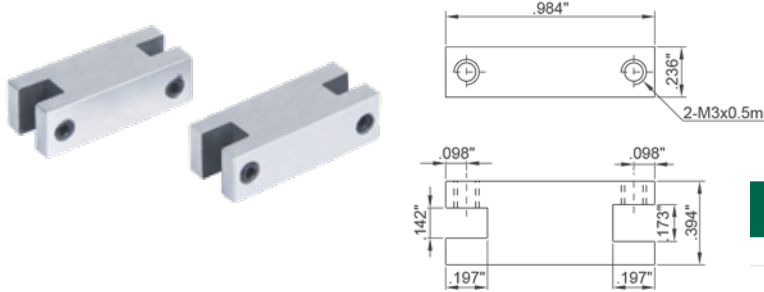

INSIZE No.	Code
6143	816408

Point Sleeves

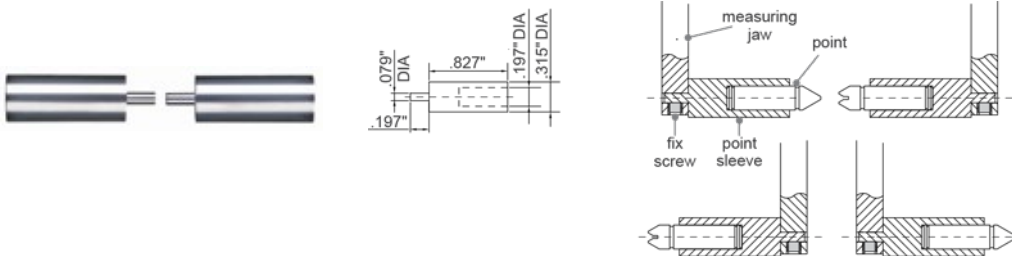

INSIZE No.	Code
1526-T101	816621

Screw Thread Points



- Point sleeves required

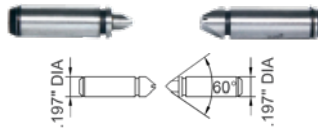

External Thread – 60° Thread Angle

Pitch (TPI/mm)	INSIZE No.	Code
64-48/0.4-0.5	7381-T11	281671
44-28/0.6-0.9	7381-T12	281672
24-14/1-1.75	7381-T13	281673
13-9/2-3	7381-T14	281674
8-5/3.5-5	7381-T15	281675
4.5-3.5/5.5-7	7381-T16	281676
SET - 6 Pair (above)	7381-TS	281670

Electronic Inside Groove Caliper



- IP67 Coolant proof
- Measures groove diameter inside bores
- Resolution: 0.0005"/0.01mm
- Buttons: on/off, zero, inch/mm, ABS/REL, hold
- Battery CR2032
- Stainless steel
- Supplied in fitted storage case

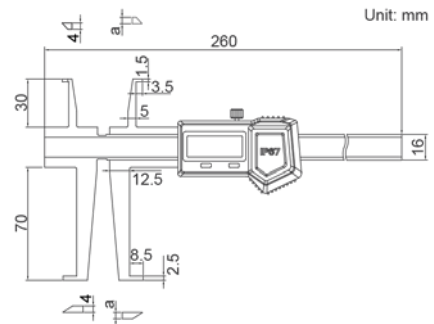

Range of Upper Jaw (Inch/mm)	Range of Lower Jaw (Inch/mm)	Accuracy (mm)	a (mm)	INSIZE No.	Code
0.35-6/9-150	0.7-6/17-150	±0.04	4	1176-150P	877280

Electronic Inside Groove Caliper

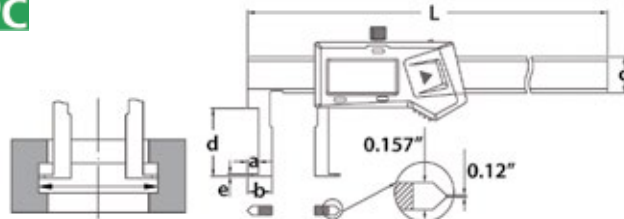

- Measures groove diameter
- Resolution: 0.0005"/0.01mm
- Buttons: on/off, set, inch/mm, preset (+,-)
- Auto power off - move unit to turn on
- Battery CR2032
- Data output
- Stainless steel
- Supplied in fitted storage case

OPTIONAL ACCESSORY: SPC cable, Depth stops

Range (Inch/mm)	Accuracy	L	a	b	c	d	e	INSIZE No.	Code
1-6/25.4-150	±0.0015"	9.843"	0.197"	0.5"	0.63"	1.181"	0.039"	1120-150AE	280523
0.98-8/25-200	±0.04mm	310mm	5mm	12.5mm	16mm	40mm	1mm	1120-200A	280525
1.18-12/30-300	±0.05mm	410mm	5mm	15mm	16mm	50mm	1.5mm	1120-300A	280527

Sizes available up to 12"/300mm

Electronic Inside Groove Caliper

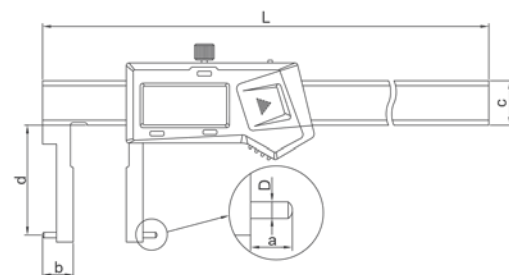

- Measures groove diameter
- Resolution: 0.0005"/0.01mm
- Pin dimensions: 0.079" diameter x 0.197" deep
- Buttons: on/off, set, inch/mm, preset (+,-)
- Auto power off - move unit to turn on
- Battery CR2032
- Data output
- Stainless steel
- Supplied in fitted storage case

OPTIONAL ACCESSORY: SPC cable, Depth stops

Range (Inch/mm)	Accuracy	L	a	b	c	d	D	INSIZE No.	Code
0.9-6/24-150	±0.0015"	9.843"	0.197"	0.4724"	0.63"	1.181"	0.079"	1121-150A	280541
0.98-8/25-200	±0.04mm	310mm	5mm	12.5mm	16mm	37mm	2mm	1121-200A	280544
1.97-12/50-300	±0.07mm	410mm	8mm	25mm	16mm	77mm	3mm	1121-300IA	280548

Electronic Inside Groove Caliper

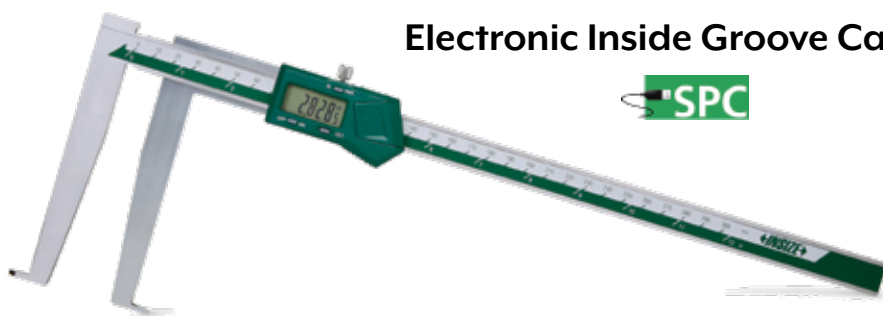

- Measures diameter of grooves inside bores
- Resolution: 0.0005"/0.01mm
- Buttons: on/off, set, inch/mm, preset (+,-)
- Auto power off - move unit to turn on
- Battery CR2032
- Data output
- Stainless steel
- Supplied in fitted storage case

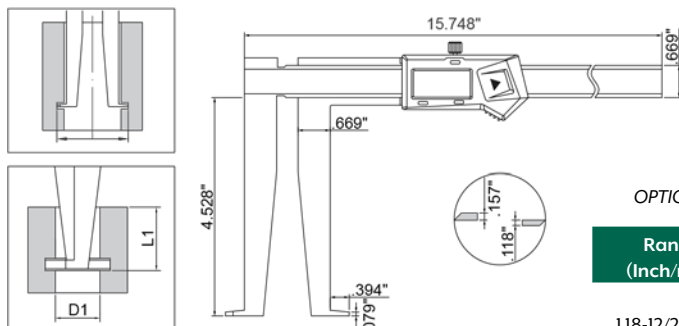

OPTIONAL ACCESSORY: SPC cable, Depth stops

Range (Inch/mm)	Accuracy (Inch)	ØD1 (Inch)	L1 (Inch)	INSIZE No.	Code
1.18-12/25-300	±0.0020	0.984	<1.969	1178-300	816633
		1.024	<2.362		
		1.063-12	<4.331		

Electronic Inside Groove Caliper

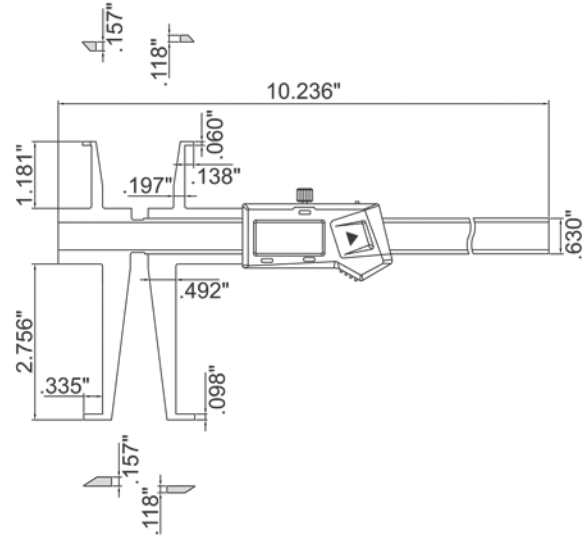
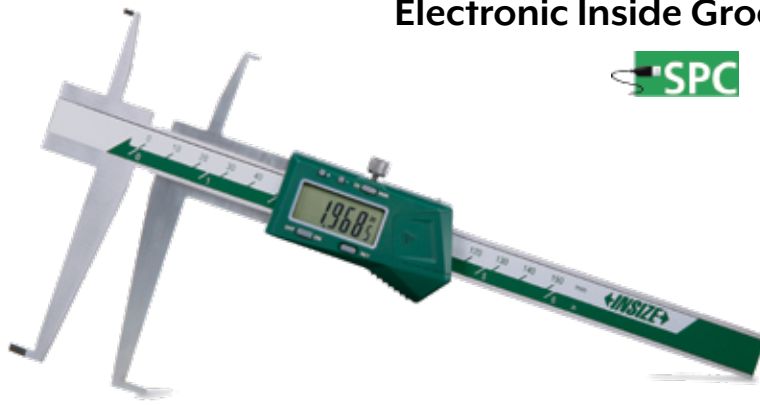

- Measures groove diameter inside bores
- Resolution: 0.0005"/0.01mm
- Buttons: on/off, set, inch/mm, preset (+,-)
- Auto power off - move unit to turn on
- Battery CR2032
- Data output
- Stainless steel
- Supplied in fitted storage case

Range of Upper Jaw (Inch/mm)	Range of Lower Jaw (Inch/mm)	Accuracy	INSIZE No.	Code
0.35-6/9-150	0.59-6/15-150	±0.0015"	1176-150	817005
0.35-8/9-200	0.70-8/17-200	±0.05mm	1176-200	877281

Wireless data transfer

Range of Upper Jaw (Inch/mm)	Range of Lower Jaw (Inch/mm)	Accuracy	INSIZE No.	Code
0.35-8/9-200	0.70-8/17-200	±0.05mm	1176-200WL	877282

Electronic Calipers



With Ceramic Tipped Jaws



- Ceramic tipped jaws for outside measurement, extremely wear-resistant, non-magnetic and non electric conductive
- Resolution: 0.01mm/0.0005"
- Buttons: on/off, zero, mm/inch
- Automatic power off, move the digital unit to turn on power
- Battery CR2032
- Meet DIN862
- Data output
- Stainless steel
- Supplied in fitted storage case

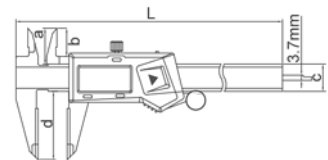

Range (Inch/mm)	Accuracy (mm)	L (mm)	a (mm)	b (mm)	c (mm)	d (mm)	INSIZE No.	Code
0-6/0-150	±0.03	235	21	16.5	16	40	1193-150	877284
0-8/0-200	±0.03	287	24	20	16	50	1193-200	877285
0-12/0-300	±0.03	390	26	21.5	16	60	1193-300	877286

Electronic Wall Thickness Caliper



- Measure wall thickness of helmets, domes and curved pots
- Resolution .0005"/0.01mm
- Buttons: on/off, zero, inch/mm, ABS, data preset
- Automatic power off, move the digital unit to turn on power
- Battery CR2032
- Data output
- Stainless steel
- Supplied in fitted storage case

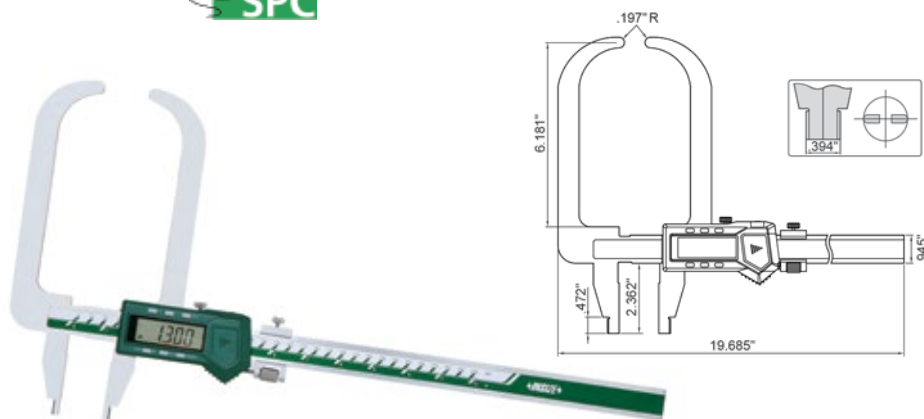

Range (Inch/mm)	Accuracy (Inch)	INSIZE No.	Code
0-12/0-300	±0.002	1536-300	877287

Electronic Depth Calipers

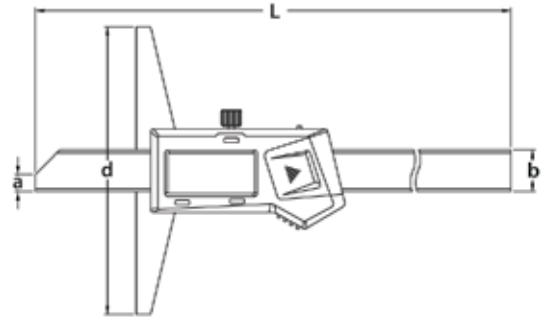

- Resolution: 0.0005"/0.01mm
- Buttons: on/off, zero, inch/mm
- Auto power off
- Battery CR2032
- Data output
- Stainless steel construction
- Supplied in fitted storage case

OPTIONAL ACCESSORY: SPC cable

Range (Inch/mm)	Accuracy (Inch)	L (Inch)	a (Inch)	b (Inch)	d (Inch)	INSIZE No.	Code
0-6/0-150	±0.0015	9.055	0.236	0.571	3.937	1141-150A	816040
0-8/0-200	±0.0015	11.024	0.236	0.571	3.937	1141-200A	816042
0-12/0-300	±0.0015	14.961	0.236	0.571	5.906	1141-300A	816044
0-20/0-500	±0.0020	23.031	0.276	0.591	5.906	1141-500A	280676

Electronic Depth Calipers

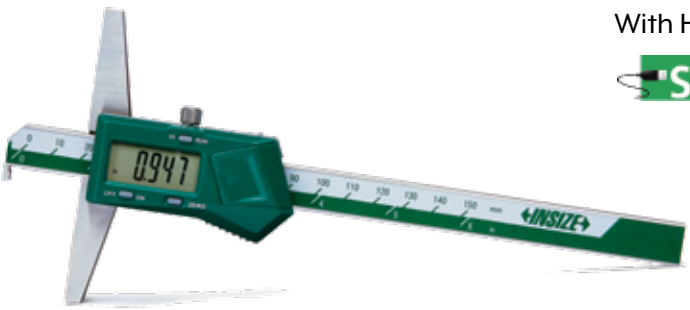

With Hook

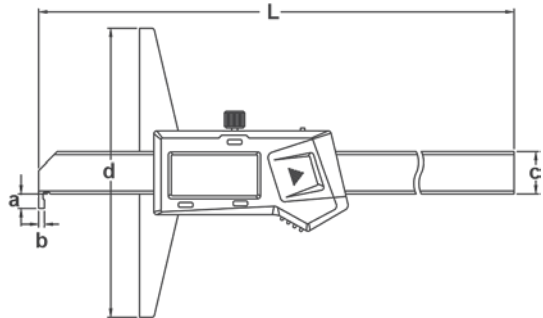

- Resolution: 0.0005"/0.01mm
- Buttons: on/off, zero, inch/mm
- Auto power off - move unit to turn on
- Battery CR2032
- Data output
- Stainless steel construction
- Supplied in fitted storage case

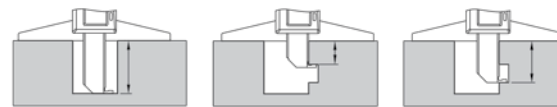

OPTIONAL ACCESSORY: SPC cable

Range (Inch/mm)	Accuracy (Inch)	L Length (Inch)	a (Inch)	b (Inch)	c (Inch)	d (Inch)	INSIZE No.	Code
0-6/0-150	±0.0015	9.055	0.197	0.0787	0.571	3.937	1142-150A	280677
0-8/0-200	±0.0015	11.024	0.197	0.0787	0.571	3.937	1142-200A	280678
0-12/0-300	±0.0015	14.961	0.197	0.0787	0.571	5.906	1142-300A	280679

Electronic Depth Calipers

With Two Hooks

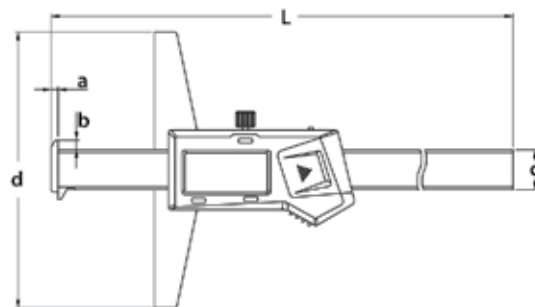
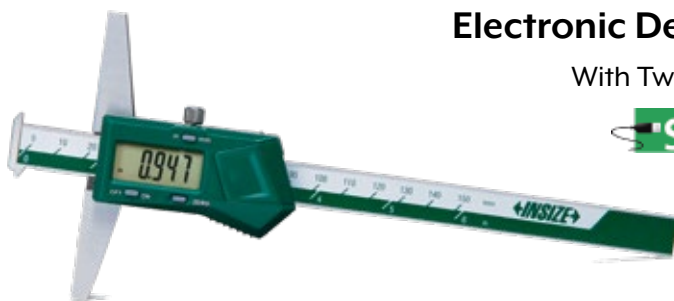

OPTIONAL ACCESSORY: SPC cable

- Resolution: 0.0005"/0.01mm
- Buttons: on/off, zero, inch/mm
- Auto power off - move unit to turn on
- Battery CR2032
- Data output
- Stainless steel
- Supplied in fitted storage case

Range (Inch/mm)	Accuracy (Inch)	L Length (Inch)	d (Inch)	INSIZE No.	Code
0-6/0-150	±0.0015	9.173	3.937	1144-150A	280681
0-8/0-200	±0.0015	11.142	3.937	1144-200A	280682
0-12/0-300	±0.0015	15.079	5.906	1144-300A	280683

Vernier Calipers

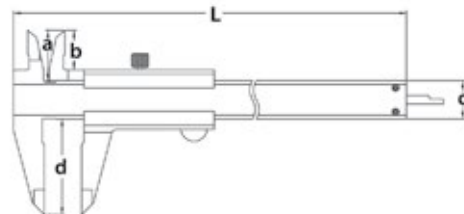

- Stainless steel with satin chrome plated reading surface
- Supplied in fitted storage case

Graduations: 0.001"/0.02mm – Accuracy: ±0.0012"

Range (Inch/mm)	L (Inch)	a (Inch)	b (Inch)	c (Inch)	d (Inch)	INSIZE No.	Code
0-6/0-150	9.252	0.807	0.610	0.630	1.575	1205-1502E	876750
0-8/0-200	11.417	0.925	0.748	0.669	1.969	1205-2002E	876225
0-12/0-300	16.299	1.083	0.866	0.787	2.520	1205-3002E	876232

Graduations: 0.05mm/1/128" – Accuracy: ±0.05mm

Range (mm/Inch)	L (mm)	a (mm)	b (mm)	c (mm)	d (mm)	INSIZE No.	Code
0-150/0-6	235	20.5	15.5	16	40	1205-150S	876224

Vernier Caliper

With Thumb Clamp

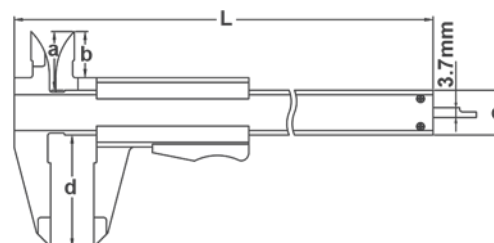

- Meets DIN862 standards
- With thumb clamp
- Stainless steel with satin chrome plated reading surface
- Supplied in fitted storage case

Graduations: 0.05mm/1/128" – Accuracy: ±0.05mm

Range (mm/Inch)	L (mm)	a (mm)	b (mm)	c (mm)	d (mm)	INSIZE No.	Code
0-150/0-6	230	20.5	16.5	16	40	1223-150	280184

Vernier Calipers



- Meets DIN862 standards
- Stainless steel with satin chrome plated reading surface
- Supplied in fitted storage case



Graduations: 0.05mm/1/128" – Accuracy: ±0.05mm

Range (mm/Inch)	L (mm)	a (mm)	b (mm)	c (mm)	d (mm)	INSIZE No.	Code
0-300/0-12	414	27.5	22	20	64	1205-300S	876226

Graduations: 0.02mm/0.001" – Accuracy: ±0.03mm

Range (mm/Inch)	L (mm)	a (mm)	b (mm)	c (mm)	d (mm)	INSIZE No.	Code
0-150/0-6	235	20.5	15.5	16	40	1205-1502S	876230
0-200/0-8	290	23.5	19	17	50	1205-2002S	876231

Vernier Caliper

With Fine Adjustment



- Meets DIN862 standards
- Stainless steel with satin chrome plated reading surface
- Supplied in fitted storage case



Graduations: 0.02mm/0.001" – Accuracy: ±0.03mm

Range (mm/Inch)	L (mm)	a (mm)	b (mm)	c (mm)	d (mm)	INSIZE No.	Code
0-130/0-5	230	20.5	16.5	16	40	1233-130	280209

Scribing Caliper



- Made of stainless steel
- Satin chrome plated reading surface
- Carbide scriber tip



Graduations: 0.1mm, 1/128" – Accuracy: ±0.1mm

Range (mm/Inch)	INSIZE No.	Code
0-200/0-8	7202-200A	283948

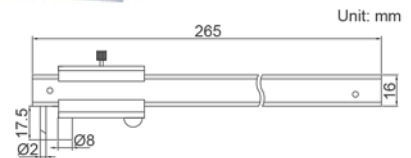

Vernier Calipers

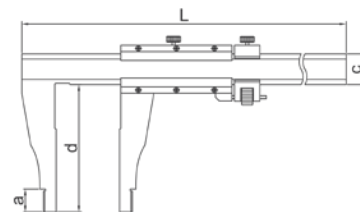

- With fine adjustment
- Graduation on scale: inch on bottom, metric on top
- Stainless steel
- Supplied in fitted storage case

Range (mm/Inch)	Graduation (mm/Inch)	Accuracy (Inch)	L (Inch)	a (Inch)	c (Inch)	d (Inch)	e (Inch)	INSIZE No.	Code
0-600/0-24	0.02/0.001	±0.002	30.315	0.709	0.945	3.937	0.8	1211-24	280408
0-1000/0-40	0.02/0.001	±0.0031	47.874	0.945	1.26	5.512	0.8	1211-40	280409

Dial Calipers



Shockproof

- Shockproof dial indicator
- With thumb roller
- Stainless steel
- Supplied in fitted storage case

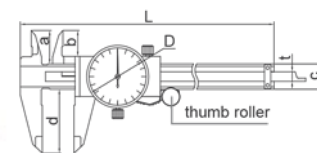

Range (mm)	Accuracy (mm)	L (mm)	a (mm)	b (mm)	c (mm)	d (mm)	ØD (mm)	t (mm)	INSIZE No.	Code
0-150	±0.03	235	21	16.5	16	40	39	6.5	1312-150A	280459
0-300	±0.03	410	28	22	20	62	44.5	7.5	1312-300A	280461

Depth Base Attachment for Calipers



- To increase the stability of depth measurement
- Suitable for digital calipers and dial calipers
- Made of stainless steel



877375



877376

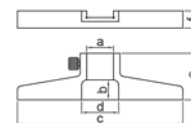

a (Inch)	b (Inch)	c (Inch)	d (Inch)	e (Inch)	f (Inch)	Type	Application	INSIZE No.	Code
0.787	0.591	4.921	0.866	1.339	0.354	narrow base (f=0.354")	For calipers with beam width (w) 0.787"	6140-300A	877376
0.63	0.492	2.953	0.965	1.181	0.433	wide base (f=0.433"), high stability	For calipers with beam width (w) 0.63"	6140-16B	877375

Dial Calipers

Inch & Metric

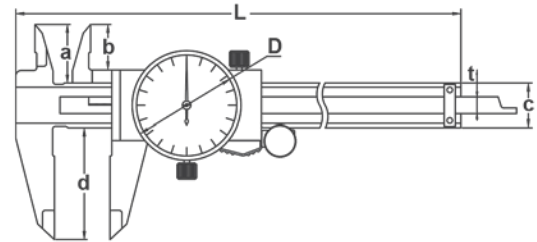
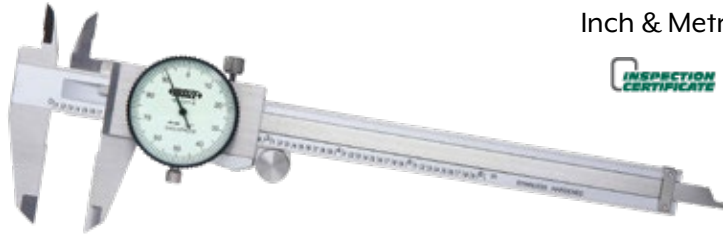

- Graduations: Inch 0.001", Metric 0.01mm
- One revolution equals: Inch 0.1", Metric 1mm
- Shock proof dial indicator
- Supplied in fitted storage case

Inch

Range (Inch)	Accuracy (Inch)	L (Inch)	a (Inch)	b (Inch)	c (Inch)	d (Inch)	ØD (Inch)	t (Inch)	INSIZE No.	Code
0-4	±0.0012	6.496	0.709	0.472	0.512	1.181	1.260	0.228	1311-4	280462
0-6	±0.0015	9.252	0.827	0.650	0.630	1.575	1.535	0.256	1311-6	816028
0-8	±0.0020	11.339	0.945	0.748	0.630	1.890	1.535	0.256	1311-8	816030
0-12	±0.0020	16.142	1.102	0.866	0.787	2.441	1.752	0.295	1311-12	816032

Metric

Range (mm)	Accuracy (mm)	L (mm)	a (mm)	b (mm)	c (mm)	d (mm)	ØD (mm)	t (mm)	INSIZE No.	Code
0-150	±0.03	235	21	16.5	16	40	39.0	6.5	1311-150A	816034
0-200	±0.03	288	24	19.0	16	48	39.0	6.5	1311-200A	816036
0-300	±0.03	410	28	22.0	20	62	44.5	7.5	1311-300A	816038

Depth Base Attachment for Calipers



- Increases stability when measuring depths with a caliper
- Suitable for 0-6" and 0-8" Vernier calipers, electronic calipers and dial calipers with a beam width of (w) 0.63"
- Stainless steel

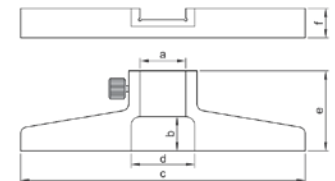
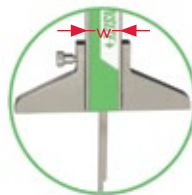

a (Inch)	b (Inch)	c (Inch)	d (Inch)	e (Inch)	f (Inch)	INSIZE No.	Code
0.650	0.354	2.953	0.709	1.181	0.236	6140	816046
0.787	0.591	4.921	1.102	1.378	0.512	6140-300B	877377

Caliper Accessory Set



Caliper not included

- Set includes jaws, wrench and the following points: small cylindrical, large cylindrical, spherical, and pointed
- Components are hardened, ground and lapped
- Fits many brands
- For sizes 4", 6", and 8" calipers
- Used to measure slots, grooves, webs, shoulders, etc.

Code

805785

Electronic Outside Micrometers



Coolant Proof

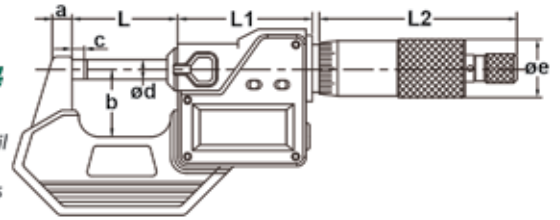

OPTIONAL ACCESSORY: SPC cable

- Resolution: 0.00005"/0.001mm [exceptions: 280848 (3101-275E) and 280849 (3101-300E) - resolution 0.0001"/0.001mm]
- Coolant/dust proof, IP65 Ingress protection level
- Button function: on/off, set, inch/mm, ABS/INC
- Data output
- Auto power off
- Battery LR44
- Ratchet stop
- Carbide tips
- Supplied with spherical anvil
- Setting standards are included (exception: micrometers 0-1"/0-25mm)
- Supplied in fitted storage case

Friction Thimble

Range (Inch/mm)	Accuracy (Inch)	L (Inch)	a (Inch)	b (Inch)	c (Inch)	INSIZE No.	Code
0-1/0-25	±0.0001	1.358	0.236	0.984	0.118	*3101-25FE	877302

Range (Inch/mm)	Accuracy (Inch)	L (Inch)	L1 (Inch)	L2 (Inch)	a (Inch)	b (Inch)	c (Inch)	Ød (Inch)	Øe (Inch)	INSIZE No.	Code
0-1/0-25	±0.00010	1.280	1.752	2.520	0.236	0.945	0.118	0.256	0.709	*3101-25E	280838
1-2/25-50	±0.00010	2.264	1.752	2.520	0.315	1.260	0.118	0.256	0.709	*3101-50E	280839
2-3/50-75	±0.00015	3.248	1.752	2.520	0.315	1.752	0.118	0.256	0.709	*3101-75E	280840
3-4/75-100	±0.00015	4.232	1.752	2.520	0.315	2.244	0.118	0.256	0.709	*3101-100E	280841
4-5/100-125	±0.00015	5.236	1.752	2.520	0.394	2.756	0.118	0.256	0.709	3101-125E	280842
5-6/125-150	±0.00015	6.240	1.752	2.520	0.394	3.228	0.118	0.256	0.709	3101-150E	280843
6-7/150-175	±0.00015	7.244	1.752	2.520	0.472	3.720	0.217	0.256	0.709	3101-175E	280829
7-8/175-200	±0.00015	8.248	1.752	2.520	0.472	4.213	0.217	0.256	0.709	3101-200E	280830
8-9/200-225	±0.00020	9.291	1.752	2.520	0.906	5.098	0.217	0.256	0.709	3101-225E	280846
9-10/225-250	±0.00015	10.217	1.752	2.520	0.764	5.610	0.217	0.256	0.709	3101-250E	280847
10-11/250-275	±0.00020	11.220	1.752	2.520	0.764	6.102	0.217	0.256	0.709	3101-275E	280848
11-12/275-300	±0.00020	12.224	1.752	2.520	0.764	6.594	0.217	0.256	0.709	3101-300E	280849
0-3/0-75		SET: Included: 3101-25E, 3101-50E, 3101-75E								3101-33E	877303
0-4/0-100		SET: Included: 3101-25E, 3101-50E, 3101-75E, 3101-100E								3101-44E	285125
0-6/0-150		SET Included: 3101-25E, 3101-50E, 3101-75E, 3101-100E, 3101-125E, 3101-150E								3101-66E	285126

Electronic Outside Micrometers



Coolant Proof

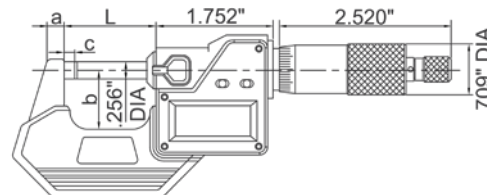

- Resolution: 0.00005"/0.001mm
- Coolant/dust proof, IP65 Ingress protection level
- Button function: on/off, set, inch/mm, ABS/INC
- No data output
- Auto power off
- Battery LR44
- Carbide measuring faces
- Friction thimble
- Supplied with spherical anvil
- Setting standards are included (exception: micrometers 0-1"/0-25mm)
- Supplied in fitted storage case

Range (Inch/mm)	Accuracy (Inch)	L (Inch)	a (Inch)	b (Inch)	c (Inch)	INSIZE No.	Code
0-1/0-25	±0.00010	1.358	0.236	0.984	0.118	3108-1	280868
1-2/25-50	±0.00010	2.343	0.315	1.260	0.118	3108-2	280869

Digimatic Micrometer



Coolant Proof IP65



- Resolution: 0.00005"/0.001mm
- Accuracy: ± 0.00005 "
- Coolant proof, IP65 Ingress protection level
- Faster measurement with 2mm per revolution instead of the standard 0.5mm
- A patented ratchet thimble mechanism helps ensure repeatability
- A function lock helps prevent error
- Certificate of inspection provided
- Supplied in fitted storage case

Range (Inch)	Code
0-1	293-180

Electronic Outside Micrometers

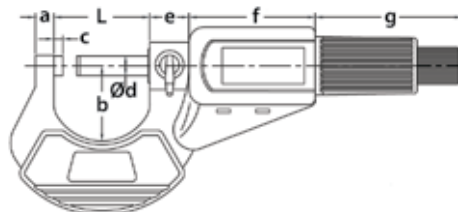

- Resolution: 0.00005"/0.001mm
- Button functions: on/off, set, inch/mm, ABS/INC
- Auto power off
- Battery LR44
- Carbide tips
- Friction thimble
- Spherical anvil included allows tube thickness measurements
- Micrometers over 0-1"/0-25mm are supplied with a setting standard
- Supplied in fitted storage case

Range (Inch/mm)	Accuracy (Inch)	L (Inch)	a (Inch)	b (Inch)	c (Inch)	Ød (Inch)	e (Inch)	f (Inch)	g (Inch)	INSIZE No.	Code
0-1/0-25	± 0.00010	1.260	0.236	1.083	0.118	0.256	0.551	1.811	1.890	3109-25E	816500
1-2/25-50	± 0.00015	2.244	0.315	1.457	0.118	0.256	0.551	1.811	1.890	3109-50E	816502
2-3/50-75	± 0.00015	3.228	0.315	1.969	0.118	0.256	0.551	1.811	1.890	3109-75E	816504
3-4/75-100	± 0.00015	4.213	0.394	2.402	0.118	0.256	0.551	1.811	1.890	3109-100E	816506

Outside Micrometers



With Counter

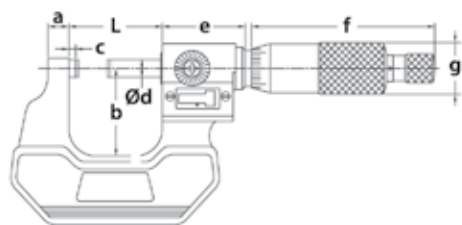

- Counter resolution: 0.001"
- Thimble graduation: 0.0001"
- Ratchet stop and carbide tips
- Micrometers over 1"/25mm are supplied with a setting standard
- Supplied in fitted storage case

Range (Inch)	Accuracy (Inch)	L (Inch)	a (Inch)	b (Inch)	c (Inch)	Ød (Inch)	e (Inch)	f (Inch)	Øg (Inch)	INSIZE No.	Code
0-1	± 0.00015	1.260	0.236	1.024	0.138	0.256	1.181	2.598	0.709	3400-1	280933
1-2	± 0.00015	2.244	0.315	1.260	0.138	0.256	1.181	2.598	0.709	3400-2	280934
2-3	± 0.00020	3.228	0.315	1.752	0.138	0.256	1.181	2.598	0.709	3400-3	280935
3-4	± 0.00020	4.213	0.315	2.244	0.138	0.256	1.181	2.598	0.709	3400-4	280936

Outside Micrometers

For Left or Right Hand



Front



Back

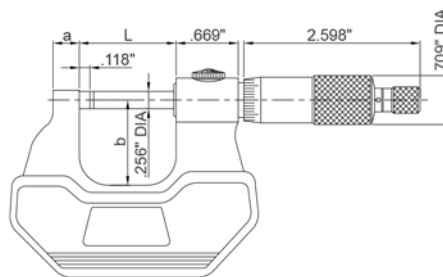

- Graduation: 0.001"
- Graduations on both sides
- Carbide tips
- Ratchet stop
- Micrometers over 1" are supplied with a setting standard
- Supplied in fitted storage case

Range (Inch)	Accuracy (Inch)	L (Inch)	a (Inch)	b (Inch)	INSIZE No.	Code
0-1	±0.00015	1.260	0.236	0.945	3236-1B	816636
1-2	±0.00015	2.244	0.315	1.260	3236-2B	816637

Outside Micrometers

Inch & Metric



816566

816564

* INSPECTION CERTIFICATE

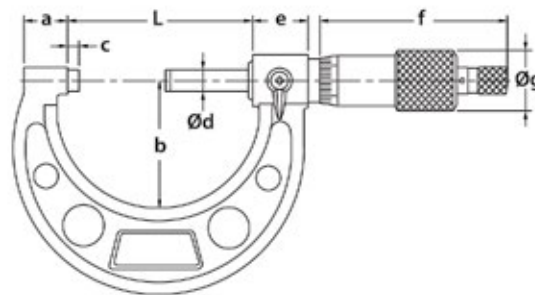

- Graduation: Inch 0.0001"; Metric 0.01mm
- Ratchet stop
- Carbide tips
- Micrometers over 1"/25mm are supplied with a setting standard
- Supplied in fitted storage case

Inch

Range (Inch)	Accuracy (Inch)	L (Inch)	a (Inch)	b (Inch)	c (Inch)	Ød (Inch)	e (Inch)	f (Inch)	Øg (Inch)	INSIZE No.	Code
0-1	±0.00015	1.260	0.354	1.102	0.118	0.256	0.669	2.598	0.709	*3203-1A	816564
1-2	±0.00015	2.244	0.551	1.496	0.118	0.256	0.669	2.598	0.709	*3203-2A	816566
2-3	±0.00020	3.228	0.591	1.929	0.118	0.256	0.669	2.598	0.709	*3203-3A	816568
3-4	±0.00020	4.213	0.591	2.362	0.118	0.256	0.669	2.598	0.709	*3203-4A	816570
4-5	±0.00025	5.236	0.650	2.874	0.118	0.256	0.669	2.598	0.709	*3203-5A	816572
5-6	±0.00025	6.220	0.650	3.346	0.118	0.256	0.669	2.598	0.709	*3203-6A	816574
6-7	±0.00030	7.205	0.764	4.094	0.118	0.256	0.669	2.598	0.709	3203-7A	816576
7-8	±0.00030	8.228	0.764	4.606	0.118	0.256	0.669	2.598	0.709	3203-8A	816578
8-9	±0.00030	9.213	0.764	5.118	0.118	0.256	0.669	2.598	0.709	3203-9A	816580
9-10	±0.00030	10.236	0.764	5.591	0.118	0.256	0.669	2.598	0.709	3203-10A	816582
10-11	±0.00035	11.220	0.764	6.102	0.118	0.256	0.669	2.598	0.709	3203-11A	816584
11-12	±0.00035	12.205	0.764	6.614	0.118	0.256	0.669	2.598	0.709	3203-12A	816586

Friction Thimble

Range (Inch)	Accuracy (Inch)	L (Inch)	a (Inch)	b (Inch)	INSIZE No.	Code
0-1	±0.0001	1.26	0.354	1.102	*3203-1FA	816565
1-2	±0.0001	2.244	0.551	1.496	*3203-2FA	877304
2-3	±0.0001	2.244	0.591	1.929	*3203-3FA	877305

Outside Micrometers

Inch & Metric (continued)



Metric

Range (mm)	Accuracy (μm)	L (mm)	a (mm)	b (mm)	c (Inch)	Ød (Inch)	e (Inch)	f (Inch)	Øg (Inch)	INSIZE No.	Code
0-25	2	32	9	28	0.118	0.256	0.669	2.598	0.709	*3203-25A	816530
25-50	2	57	14	38	0.118	0.256	0.669	2.598	0.709	*3203-50A	816532
50-75	2	82	15	49	0.118	0.256	0.669	2.598	0.709	*3203-75A	816534
75-100	3	107	15	60	0.118	0.256	0.669	2.598	0.709	*3203-100A	816536
100-125	3	133	16.5	73	0.118	0.256	0.669	2.598	0.709	3203-125A	816538
125-150	3	158	16.5	85	0.118	0.256	0.669	2.598	0.709	3203-150A	816540
150-175	4	183	19.4	104	0.118	0.256	0.669	2.598	0.709	3203-175A	816542
175-200	4	209	19.4	117	0.118	0.256	0.669	2.598	0.709	3203-200A	816544
200-225	4	234	19.4	130	0.118	0.256	0.669	2.598	0.709	3203-225A	816546
225-250	5	260	19.4	142	0.118	0.256	0.669	2.598	0.709	3203-250A	816548
250-275	5	285	19.4	155	0.118	0.256	0.669	2.598	0.709	3203-275A	816550
275-300	5	310	19.4	168	0.118	0.256	0.669	2.598	0.709	3203-300A	816552

* NIST Certification

MICROMETERS

Outside Micrometers

Inch & Metric – Sets



0-12" Set



0-4" Set

Range	Micrometers Included	Case	INSIZE No.	Code
0-3" (3 pcs)	816564, 816566, 816568	Plastic	*3203-33A	816588
0-4" (4 pcs)	816564, 816566, 816568, 816570	Plastic	*3203-44A	816590
0-6" (6 pcs)	816564, 816566, 816568, 816570, 816572, 816574	Plastic	*3203-66A	816592
6-12" (6 pcs)	816576, 816578, 816580, 816582, 816584, 816586	Aluminum	3203-126A	816594
0-12" (12 pcs)	816564, 816566, 816568, 816570, 816572, 816574, 816576, 816578, 816580, 816582, 816584, 816586	Aluminum	3203-1212A	816596
0-75 mm (3 pcs)	816530, 816532, 816534	Plastic	*3203-753A	816554
0-100 mm (4 pcs)	816530, 816532, 816534, 816536	Plastic	*3203-1004A	816556
0-150 mm (6 pcs)	816530, 816532, 816534, 816536, 816538, 816540	Plastic	3203-1506A	816558
150-300 mm (6 pcs)	816542, 816544, 816546, 816548, 816550, 816552	Aluminum	3203-3006A	816560
0-300 mm (12 pcs)	816530, 816532, 816534, 816536, 816538, 816540, 816542, 816544, 816546, 816548, 816550, 816552	Aluminum	3203-3012A	816562

Setting Standards



Length (Inch)	Accuracy (Inch)	Diameter (Inch)	INSIZE No.	Code
1	±0.00006	0.276	6311-1	282508
2	±0.00008	0.276	6311-2	282509
3	±0.0001	0.276	6311-3	282510
4	±0.00012	0.315	6311-4	282511
5	±0.00014	0.315	6311-5	282512
6	±0.00016	0.315	6311-6	282513
7	±0.00018	0.315	6311-7	282514
8	±0.00020"	0.315	6311-8	282515
9	±0.00022	0.315	6311-9	282516
10	±0.00024	0.315	6311-10	282517

Outside Micrometers

With Interchangeable Anvils

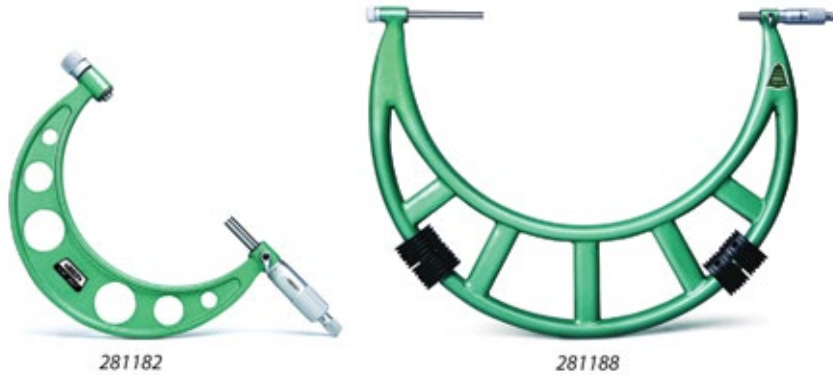

- Graduations: 0.0001" (up to 12"), 0.001" (over 12")
- Micrometers up to 12" have cast frame, over 12" have pipe frame
- Ratchet stop
- Carbide tips
- Supplied with setting standards
- Supplied in fitted storage case

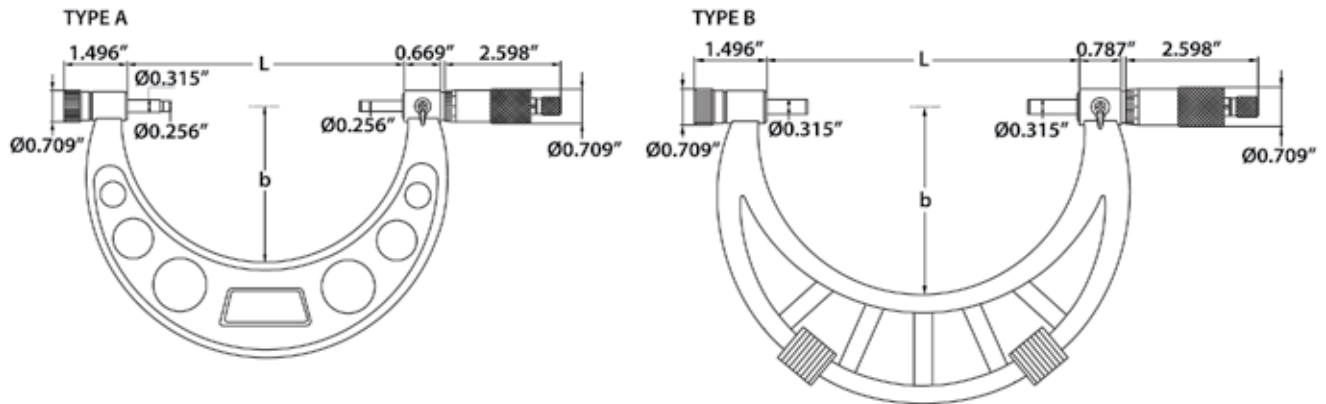

Range (Inch)	Type	Accuracy (Inch)	L (Inch)	b (Inch)	Setting Standards Included (Inch)	INSIZE No.	Code
0-2	A	±0.00015	2.283	1.378	1	3206-2	281180
0-4	A	±0.00020	4.252	2.244	1, 2, 3	3206-4	281181
0-6	A	±0.00025	6.220	3.228	1, 2, 3, 4, 5	3206-6	281182
4-8	A	±0.00030	8.189	4.488	4, 5, 6, 7	3206-8	281185
6-12	A	±0.00035	12.126	6.496	6, 7, 8, 9, 10, 11	3206-12	281186
8-12	A	±0.00035	12.126	6.496	8, 9, 10, 11	3206-12I	281187
12-16	B	±0.00045	16.102	8.819	13, 15	3206-16	281188
16-20	B	±0.00050	20.039	10.827	17, 19	3206-20	281189
20-24	B	±0.00055	23.976	12.638	21, 23	3206-24	281190
24-28	B	±0.00065	27.913	14.606	25, 27	3206-28	281191
28-32	B	±0.00070	31.850	16.772	29, 31	3206-32	281192
32-36	B	±0.00080	35.787	18.740	33, 35	3206-36	281193
36-40	B	±0.00085	39.724	22.677	37, 39	3206-40	281194

Outside Micrometer Set



Range (Inch)	Graduation (Inch)	Included in Set	Code
0-3	0.0001	0-1", 1-2", 2-3"	103-922

Spherical Anvil Tube Micrometers

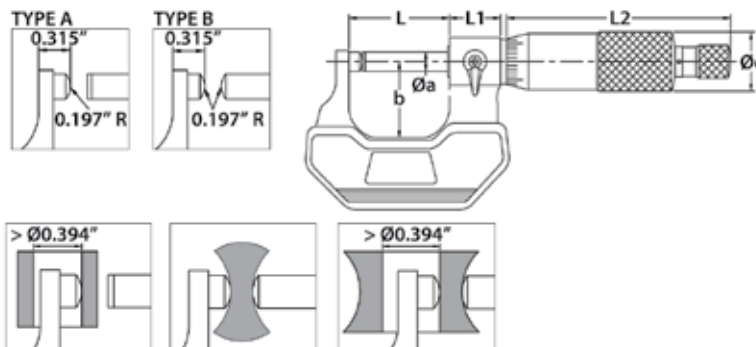

- For measuring wall thickness of tubes
- Graduation: 0.0001"
- Ratchet stop
- Carbide tips
- Micrometers over 1" are supplied with a setting standard
- Supplied in fitted storage case

Range (Inch)	Type	Accuracy (Inch)	L (Inch)	L1 (Inch)	L2 (Inch)	Øa (Inch)	b (Inch)	Øc (Inch)	INSIZE No.	Code
0-1	A	0.00015	1.260	0.669	2.598	0.256	0.945	0.709	3260-1	281457
0-1	B	0.00015	1.260	0.669	2.598	0.256	0.945	0.709	3260-1S	281461
1-2	A	0.00015	2.244	0.669	2.598	0.256	1.260	0.709	3260-2	281458
1-2	B	0.00015	2.244	0.669	2.598	0.256	1.260	0.709	3260-2S	281462
2-3	A	0.00020	3.228	0.669	2.598	0.256	1.752	0.709	3260-3	281459

Blade Micrometers

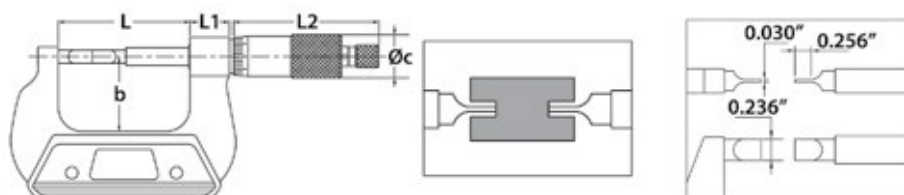

- Measures the groove diameters of shafts and keyways
- Graduation: 0.0001"
- Non-rotating spindle
- Ratchet stop
- Micrometers over 1" are supplied with a setting standard
- Supplied in fitted storage case

Range (Inch)	Accuracy (Inch)	L (Inch)	L1 (Inch)	L2 (Inch)	b (Inch)	Øc (Inch)	INSIZE No.	Code
0-1	±0.00015	2.244	0.669	2.598	1.260	0.709	3232-1	281320
1-2	±0.00015	3.228	0.669	2.598	1.752	0.709	3232-2	281321
2-3	±0.00020	4.213	0.669	2.598	2.244	0.709	3232-3	281322
3-4	±0.00020	5.220	0.669	2.598	2.736	0.709	3232-4	281323
4-5	±0.00025	6.220	0.669	2.598	3.228	0.709	3232-5	281324
5-6	±0.00025	7.220	0.669	2.598	3.720	0.709	3232-6	281325
6-7	±0.00030	8.220	0.669	2.598	4.213	0.709	3232-7	281326

Cylindrical Anvil Tube Micrometers



- Measure wall thickness of tubes
- Graduation 0.0001"
- Ratchet stop
- Carbide spindle tip

Range (Inch)	Accuracy (Inch)	L (Inch)	b (Inch)	INSIZE No.	Code
0-1	0.00025	1.417	0.984	3261-1	281480
0-1	0.00025	1.417	0.984	3261-1C	281483

Electronic Blade Micrometers

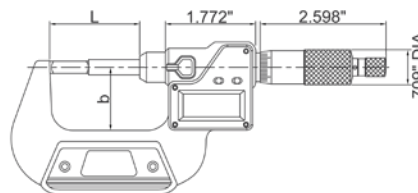

MICROMETERS

- Measures the groove diameters of shafts and keyways
- Resolution: 0.00005"/0.001mm
- Button function: on/off, set, inch/mm, ABS/INC
- Data output
- Battery LR44
- Auto power off
- Non-rotating spindle
- Ratchet stop
- Supplied in fitted storage case

Range (Inch/mm)	Accuracy (Inch)	L (Inch)	b (Inch)	INSIZE No.	Code
1-2/25-50	±0.00015	2.244	1.260	3532-25E	281327
1-2/25-50	±0.00015	3.228	1.752	3532-50E	281328
2-3/50-75	±0.00020	4.213	2.244	3532-75E	281329
3-4/75-100	±0.00020	5.220	2.736	3532-100E	281330
0-1/0-25	±0.00015	2.244	1.260	3532-25BE	877317

Point Micrometers



- Measures the web thickness of drills, small grooves and keyways
- Graduation: 0.0001"
- Ratchet stop
- Carbide tips
- Supplied in fitted storage case

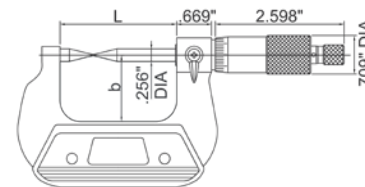

Range (Inch)	Accuracy (Inch)	L (Inch)	b (Inch)	INSIZE No.	Code
0-1	±0.00015	2.244	1.260	3230-1	281345
1-2	±0.00015	3.228	1.752	3230-2	281346
3-4	±0.00020	5.220	2.736	3230-4	281348
0-1	±0.00015	2.244	1.260	3230-1B	877306

Crimp Height Micrometers

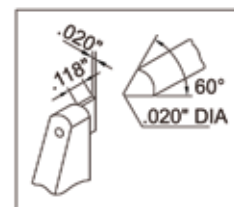
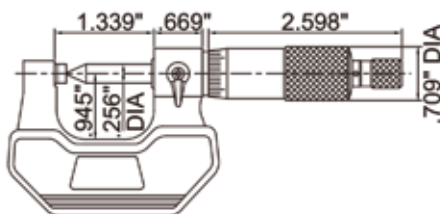

- Measures the height of crimp contact
- Graduation: 0.0001"
- Ratchet stop
- Supplied in fitted storage case

Range (Inch)	Accuracy (Inch)	INSIZE No.	Code
0-1	±0.00015	3266-1B	281395

Electronic Blade Micrometers

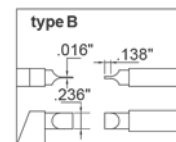
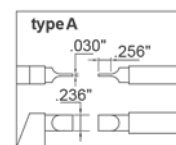
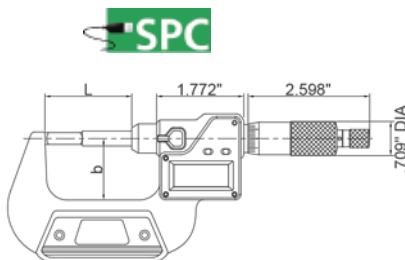

- Measures the groove diameters of shafts and keyways
- Resolution: 0.00005"/0.001mm
- Button function: on/off, set, inch/mm, data transmit
- Data output
- Battery LR44
- Auto power off
- Non-rotating spindle
- Ratchet stop
- Supplied with setting standards (except 0-1"/0-25mm)
- Supplied in fitted storage case

Range (mm/Inch)	Type	Accuracy	L (mm)	b (mm)	INSIZE No.	Code
0-25/0-1	A	±4μm	57	32	3532-25A	289015
25-50/1-2	A	±4μm	82	44.5	3532-50A	877318
50-75/2-3	A	±5μm	107	57	3532-75A	289017
75-100/3-4	A	±5μm	132.6	69.5	3532-100A	877311
100-125/4-5	A	±6μm	158	82	3532-125A	877312
125-150/5-6	A	±6μm	183.4	94.5	3532-150A	877313
150-175/6-7	A	±7μm	208.8	107	3532-175A	877314
0-25/0-1	B	±4μm	57	32	3532-25BA	877316
150-175/6-7	B	±7μm	208.8	107	3532-175BA	877315

Electronic Screw Thread Micrometers

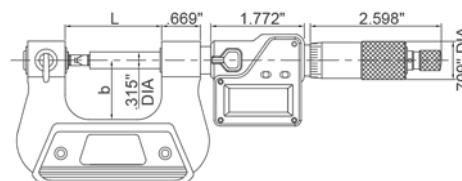

- Measure pitch diameter of screw threads
- Resolution 0.00005"/0.001mm
- Button function: on/off, set, inch/mm, ABS/INC
- Data output
- LR44 battery, automatic power off
- Non-rotating spindle
- Ratchet stop
- Supplied with 60° setting standards
- Measuring tips not included

Range (Inch/mm)	L (mm)	b (mm)	INSIZE No.	Code
1-2/25-50	2.638	1.496	3581-50E	877320

Electronic Outside Micrometers



Coolant Proof

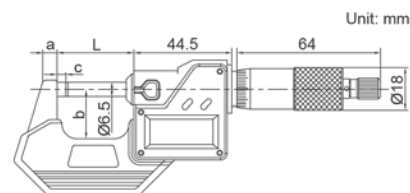

MICROMETERS

- IP65 dust/waterproof
- Button function: on/off, set, mm/inch, data transmit
- Automatic power off
- Carbide measuring faces
- Supplied with spherical anvil
- Setting standards are included (except 0-25mm/0-1")
- Supplied in fitted storage case

Ratchet Stop

Range (mm/Inch)	Resolution	Accuracy	L (mm)	a (mm)	b (mm)	c (mm)	INSIZE No.	Code
0-25/0-1	0.001mm/0.00005"	±2µm	34.5	6	25	3	3101-25A	280823
25-50/1-2	0.001mm/0.00005"	±2µm	59.5	8	32	3	3101-50A	280824
200-225/8-9	0.001mm/0.00005"	±4µm	236	23	129.5	5.5	3101-225A	280831

Friction Thimble

Range (mm/Inch)	Resolution	Accuracy	L (mm)	a (mm)	b (mm)	c (mm)	INSIZE No.	Code
0-25/0-1	0.001mm/0.00005"	±2µm	34.5	6	25	3	3101-25FA	877301

Electronic Outside Micrometers



Basic Type

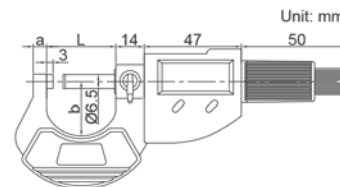

- Resolution 0.001mm/0.00005"
- Button function: on/off, set, mm/inch, ABS/INC
- No data output
- Automatic power off
- Carbide measuring faces
- Friction thimble
- Supplied with spherical anvil
- Setting standards are included (except 0-25mm/0-1")

Range (mm/Inch)	Accuracy	L (mm)	a (mm)	b (mm)	INSIZE No.	Code
0-25/0-1	±2µm	32	6	27.5	3109-25A	289005
25-50/1-2	±2µm	57	8	37	3109-50A	289008

Screw Thread Micrometers

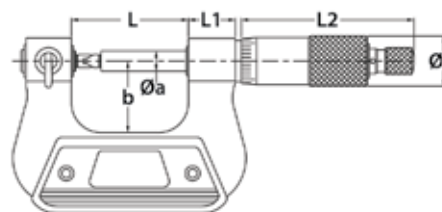
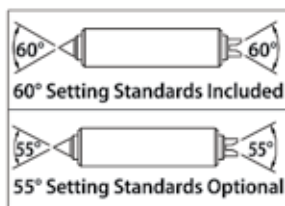

OPTIONAL ACCESSORY: 55° Setting standards

- Measures pitch diameter of screw threads
- Graduation: 0.001"
- Non-rotating spindle
- Ratchet stop
- Micrometers over 1" supplied with 60° setting standards (55° setting standards sold separately)
- Supplied in fitted storage case

Accuracy of Micrometers with Tips

Pitch (TPI)	Range					
	0-1" (Inch)	1-2" (Inch)	2-3" (Inch)	3-4" (Inch)	4-5" (Inch)	5-8" (Inch)
64-48	±0.00040	-	-	-	-	-
44-32	±0.00040	±0.00050	-	-	-	-
28-20	±0.00045	±0.00060	±0.00065	±0.00065	-	-
19-13	±0.00055	±0.00065	±0.00075	±0.00075	±0.00080	±0.00090
12-7	±0.00065	±0.00075	±0.00085	±0.00085	±0.00090	±0.00100
6-3.5	-	±0.00085	±0.00090	±0.00090	±0.00100	±0.00110

Range (Inch)	L (Inch)	L1 (Inch)	L2 (Inch)	Øa (Inch)	b (Inch)	Øc (Inch)	INSIZE No.	Code
0-1	1.654	0.669	2.598	0.315	1.024	0.709	3281-1	281696
1-2	2.638	0.669	2.598	0.315	1.496	0.709	3281-2	281697
2-3	3.622	0.669	2.598	0.315	1.969	0.709	3281-3	281698
3-4	4.630	0.669	2.598	0.315	2.441	0.709	3281-4	281699
4-5	5.630	0.669	2.598	0.315	2.756	0.709	3281-5	281700
5-6	6.622	0.669	2.598	0.315	3.228	0.709	3281-6	281701
6-7	7.559	0.669	2.598	0.315	3.720	0.709	3281-7	281702
7-8	8.543	0.669	2.598	0.315	4.213	0.709	3281-8	281703

Screw Thread Micrometer Measuring Tips



Metric & Unified Screw for 60° Threads, Whitworth Thread 55° Thread Angle

- Supplied in pairs
- Suitable for INSIZE micrometers - series 3281 and 3581

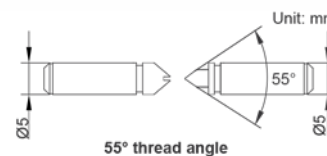
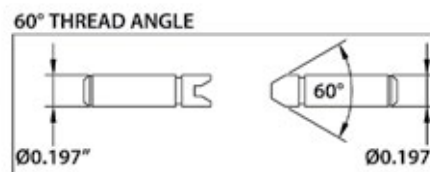

Pitch (TPI/mm)	INSIZE No.	Code
64-48/0.4-0.5	7381-T11	281671
44-28/0.6-0.9	7381-T12	281672
24-14/1-1.75	7381-T13	281673
13-9/2-3	7381-T14	281674
8-5/3.5-5	7381-T15	281675
4.5-3.5/5.5-7	7381-T16	281676
6-Pair Set includes above	7381-TS	281670

More on page 488

Whitworth thread (55° thread angle)

Pitch (TPI)	INSIZE No.	Code
10-Pair Set includes: 60-48, 48-40, 40-32, 32-24, 24-18, 18-14, 14-10, 10-7, 7-4.5, 4.5-3.5	7381-T2S	281677

Electronic Screw Thread Micrometers

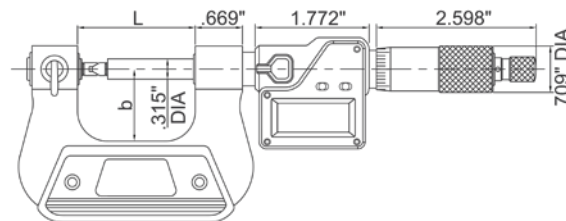

MICROMETERS

- Measures pitch diameter of screw threads
- Resolution: 0.00005"/0.001mm
- Button function: on/off, set, inch/mm, ABS/INC
- Data output
- Battery LR44
- Auto power off
- Non-rotating spindle
- Ratchet stop
- Supplied with 60° setting standards
- Supplied in fitted storage case

Range (Inch/mm)	L (Inch)	b (Inch)	INSIZE No.	Code
0-1/0-25mm	1.654	1.024	3581.25E	877166

Accuracy of micrometers with tips

Pitch	Range 0-1"
64-48TPI	±0.0004"
44-32TPI	±0.0004"
28-20TPI	±0.00045"
18-13TPI	±0.00055"
12-7TPI	±0.00065"
6-3.5TPI	-

Deep Throat (Sheet Metal) Micrometers



- Deep frame suitable for deep throat, paper and plastic
- Graduation: 0.0001"
- Ratchet stop
- Supplied in fitted storage case

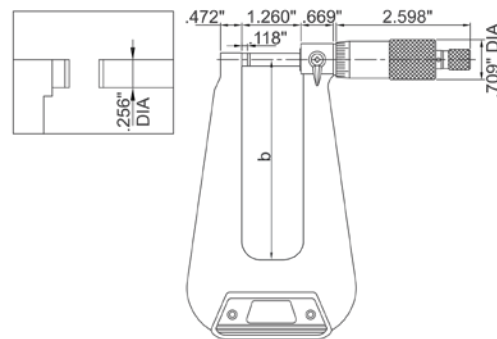

Range (Inch)	Accuracy (Inch)	b (Inch)	INSIZE No.	Code
0-1	±0.0003	6.102	3239-13	281235
0-1	±0.0004	12.205	3239-14F	281251

Micrometer Head



- Meets DIN863-2 standards
- Graduation: 0.01mm
- Ratchet stop



Range (mm)	Stem	Spindle Tip	Accuracy	INSIZE No.	Code
0-25	Plain	Flat (Carbide)	3µm	6381-25W	282605

Non-Rotating Spindle Universal Micrometers



MICROMETERS

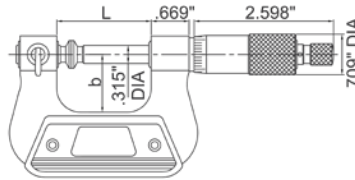

Anvil/spindle tip (included)

Flat	.256\"/>
Spherical	$\frac{S}{R}$.256\"/>
Spline	.079\"/>
Disk	.472\"/>
Blade	.028\"/>
Knife-edge	.014\"/>
Point	.012\"/>

- Graduation: 0.0001"
- Non-rotating spindle
- Ratchet stop
- Supplied with 7 pair of anvil/spindle tips
- Supplied in fitted storage case

Range (Inch)	Accuracy (Inch)	L (Inch)	b (Inch)	INSIZE No.	Code
0-1	±0.00015	1.654	1.024	3280-1	281607

Inside Micrometers

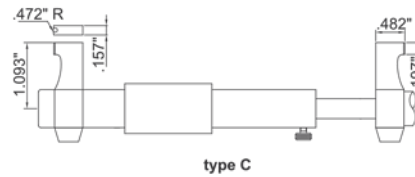
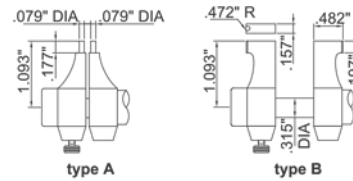
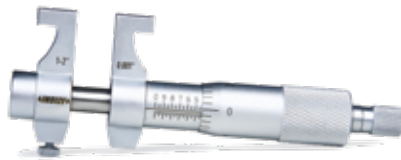

- Graduation: 0.001"
- Ratchet stop
- Carbide measuring faces
- Supplied in fitted storage case

Range (Inch)	Type	Setting Ring (Inch)	Accuracy (Inch)	INSIZE No.	Code
0.2-1.2	A	∅ 0.2 included	±0.0003	3220-1	281962
1-2	B	∅ 1 included	±0.00035	3220-2	281963
2-3	B	∅ 2 optional	±0.00035	3220-3	281964
3-4	C	∅ 3 optional	±0.0004	3220-4	281965

Electronic Inside Micrometers

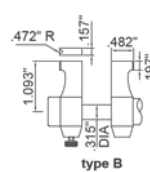
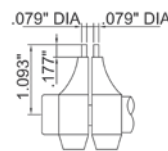

- Resolution: 0.00005"/0.001mm
- Button function: on/off, set, inch/mm, ABS/INC
- Data output
- Battery LR44
- Auto power off
- Ratchet stop
- Carbide measuring faces
- 0.2" diameter setting ring included
- Supplied in fitted storage case

Range (Inch/mm)	Type	Accuracy (Inch)	INSIZE No.	Code
0.2-1.2/5-30	A	±0.0002	3520-30E	281970
1-2/25-50	B	±0.00025	3520-50E	877308

Three Point Internal Micrometers



MICROMETERS

- 0.275-0.5" graduation: 0.0001"
- 0.5-12" graduation: 0.0002"
- Ratchet stop
- Supplied with setting ring (4-6" optional) and extension rod
- Supplied in fitted storage case

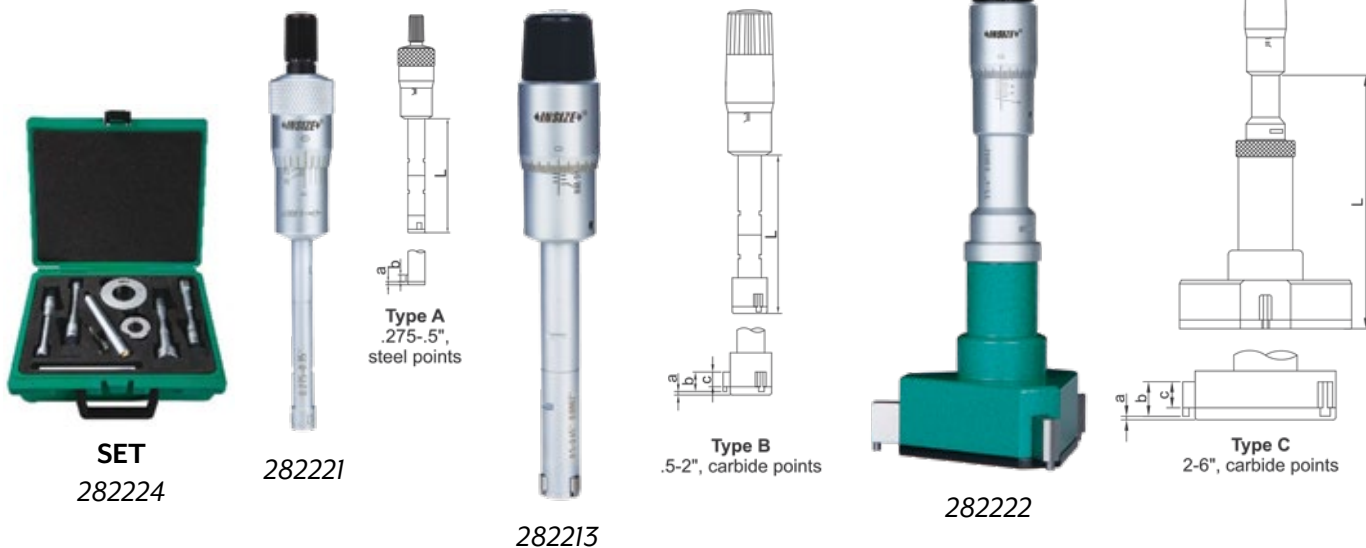

Range (Inch)	Accuracy (Inch)	Type	Ø Setting Ring (Inch)	Extension Rod (Inch)	L (Inch)	a (Inch)	b (Inch)	c (Inch)	INSIZE No.	Code
0.275-0.35	0.00015	A	0.275	4	2.146	0.059	0.098	–	3227-E035	282196
0.35-0.425	0.00015	A	0.35	4	2.146	0.059	0.098	–	3227-E0425	877165
0.425-0.5	0.00015	A	0.5	4	2.146	0.059	0.098	–	3227-E05	282198
0.5-0.65	0.00015	B	0.65	6	3.150	0.02	0.236	0.177	3227-E065	282213
0.65-0.8	0.00015	B	0.65	6	3.150	0.02	0.236	0.177	3227-E08	282214
0.8-1	0.00015	B	1	6	3.543	0.02	0.315	0.236	3227-E1	282215
1-1.2	0.00015	B	1	6	3.543	0.02	0.315	0.236	3227-E112	282216
1.2-1.6	0.00015	B	1.6	6	3.819	0.02	0.551	0.472	3227-E16	282217
1.6-2	0.0002	B	1.6	6	3.819	0.02	0.551	0.472	3227-E2	282218
2-2.5	0.0002	C	2.5	6	4.488	0.02	0.689	0.571	3227-E25	282219
2.5-3	0.0002	C	2.5	6	4.488	0.02	0.689	0.571	3227-E3	282220
3-3.5	0.0002	C	3.5	6	4.488	0.02	0.689	0.571	3227-E35	282221
3.5-4	0.0002	C	3.5	6	4.488	0.02	0.689	0.571	3227-E4	282222
4-5	0.00025	D	optional	6	5.512	0.035	1.142	0.984	3227-E5	282260
5-6	0.00025	D	optional	6	5.512	0.035	1.142	0.984	3227-E6	282261

Supplied with a Manufacturer Inspection Certificate

Sets

Range (Inch)	Micrometers Included (Inch/mm Range)	Ø Setting Ring (Inch)	Extension Rod (Inch)	INSIZE No.	Code
0.275-0.5	0.275-0.35, 0.35-0.425, 0.425-0.5	0.275, 0.35, 0.5	4	3227-E053	282199
0.5-0.8	0.5-0.65, 0.65-0.8	0.65	6	3227-E082	282223
0.8-2	0.8-1, 1-1.2, 1.2-1.6, 1.6-2	1, 1.6	6	3227-E24	282224
2-4	2-2.5, 2.5-3, 3-3.5, 3.5-4	2.5, 3.5	6	3227-E44	282225

Supplied with a Manufacturer Inspection Certificate

Electronic Three Point Internal Micrometers



Coolant Proof

- Resolution: 0.00005"/0.001mm
- Coolant/dust proof, IP54 Ingress protection level
- Buttons: on/off, set, inch/mm, ABS/INC
- Data output
- Battery LR44
- Auto power off
- Ratchet stop
- Supplied with setting rings and extension rods
- Supplied in fitted storage case



OPTIONAL ACCESSORIES:
SPC cable, Setting ring, Micrometer stand, clamp



282305

Type A
Steel Points

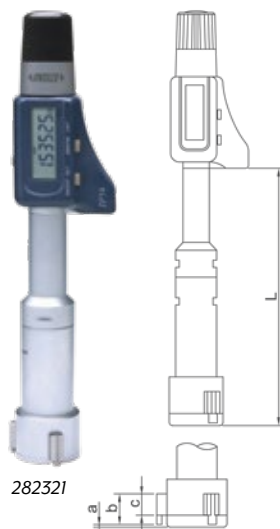

282321

Type B
Carbide Points



282367

Type C
Carbide Points

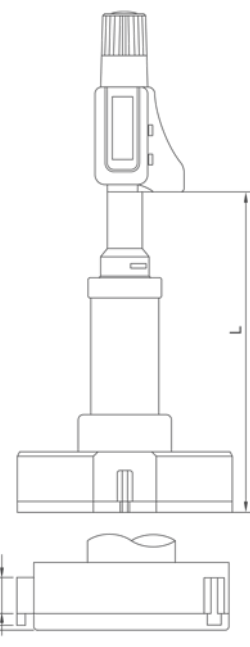

Set
282331

Individual

Range (Inch/mm)	Accuracy (Inch)	Type	Ø Setting Ring (Inch)	Extension Rod (Inch)	L (Inch)	a (Inch)	b (Inch)	c (Inch)	INSIZE No.	Code
0.35-0.425/9-11	0.00015	A	0.35	4	2.18	0.059	0.098	-	3127-E0425	816638
0.425-0.5/11-13	0.00015	A	0.50	4	2.18	0.059	0.098	-	3127-E05	282305
0.5-0.65/13-17	0.00015	B	0.65	6	3.20	0.020	0.236	0.177	3127-E065	282317
0.65-0.8/17-20	0.00015	B	0.65	6	3.20	0.020	0.236	0.177	3127-E08	282318
0.8-1/20-25	0.00015	B	1.00	6	3.60	0.020	0.315	0.236	3127-E1	282319
1-1.2/25-30	0.00015	B	1.00	6	3.60	0.020	0.315	0.236	3127-E112	282320
1.2-1.6/30-40	0.00015	B	1.60	6	3.88	0.020	0.551	0.472	3127-E16	282321
1.6-2/40-51	0.00020	B	1.60	6	3.88	0.020	0.551	0.472	3127-E2	282322
2-2.5/51-63	0.00020	C	2.50	6	4.56	0.020	0.689	0.571	3127-E25	282323
2.5-3/63-76	0.00020	C	2.50	6	4.56	0.020	0.689	0.571	3127-E3	282324
3-3.5/76-89	0.00020	C	3.50	6	4.56	0.020	0.689	0.571	3127-E35	282325
3.5-4/89-101	0.00020	C	3.50	6	4.56	0.020	0.689	0.571	3127-E4	282326
4-5/101-127	0.00025	C	-	6	6.00	0.035	1.142	0.984	3127-E5	282367
5-6/127-152	0.00025	C	-	6	6.00	0.035	1.142	0.984	3127-E6	282368

Supplied with a Manufacturer Inspection Certificate

Sets

Range (Inch/mm)	Micrometers Included (Inch/mm Range)	Ø Setting Ring (Inch)	Extension Rod (Inch)	INSIZE No.	Code
0.275-0.5/7-13	0.275-0.35/7-9, 0.35-0.425/9-11, 0.425-0.5/11-13	0.275, 0.35, 0.5	4	3127-E053	282306
0.5-0.8/13-20	0.5-0.65/13-17, 0.65-0.8/17-20	0.65	6	3127-E082	282330
0.8-2/20-51	0.8-1/20-25, 1-1.2/25-30, 1.2-1.6/30-40, 1.6-2/40-51	1, 1.6	6	3127-E24	282331
2-4/51-101	2-2.5/51-63, 2.5-3/63.76, 3-3.5/76-89, 3.5-4/89-101	2.5, 3.5	6	3127-E44	282332

Supplied with a Manufacturer Inspection Certificate

Electronic Three Point Internal Micrometers

Wide Range – Coolant Proof

- Resolution: 0.00005"/0.001mm
- Coolant/dust proof, IP54 Ingress protection level
- Buttons: on/off, set, inch/mm, ABS/INC
- Data output
- Battery LR44
- Auto power off
- Carbide measuring tips
- Ratchet stop
- Supplied with setting rings (except 816644) and extension rods
- Supplied in fitted storage case



OPTIONAL ACCESSORY: SPC cable

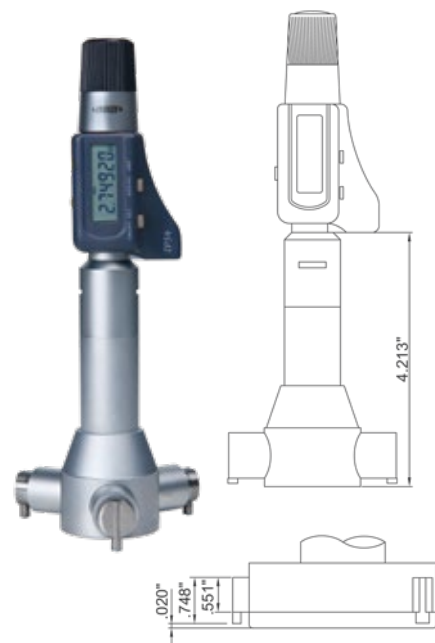

MICROMETERS

Range (Inch/mm)	Accuracy (Inch)	Ø Setting Ring (Inch)	Extension Rod (Inch)	INSIZE No.	Code
2-2.8/51-71	0.00020	2	6	3128-28	816640
2.8-4/71-101	0.00020	2.8	6	3128-4	816641
4-6/101-152	0.00025	4	6	3128-6	816642
6-10/152-254	0.00035	6	6	3128-10	816643
8-12/203-305	0.00035	-	6	3128-12	816644

Supplied with a Manufacturer Inspection Certificate

Internal Micrometers



- Graduation: 0.001"
- Micrometer head travel: 0.5"
- Supplied with a setting block standard
- Carbide tips
- Supplied in fitted storage case

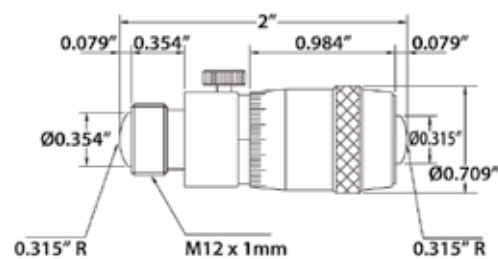

Range (Inch)	Accuracy (Inch)	Extension Rods (Inch)	INSIZE No.	Code
2-6	[0.00005 (3+n+L/2)] n=Number of Rods L=Max. Measuring Length (Inch)	0.5, 1, 2	3222-6	281999
2-12		0.5, 1, 2 (2pcs), 4	3222-12	282000
2-20		0.5, 1, 2 (2pcs), 4, 8	3222-20	282001
2-24		0.5, 1, 2, 4, 6, 8	3222-24	282007
2-40		0.5, 1, 2 (2pcs), 4, 8 (2pcs), 12	3222-40	282002
2-60		0.5, 1, 2 (2pcs), 4, 8 (3pcs), 12 (2pcs)	3222-60	282003



- Graduation: 0.001"
- Supplied in fitted storage case

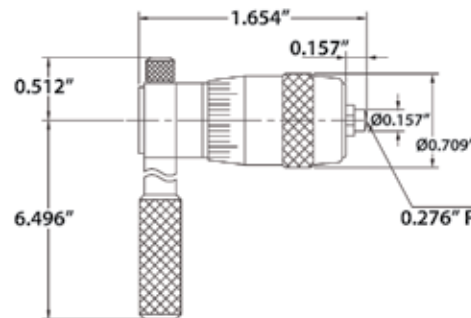

Range (Inch)	Accuracy (Inch)	Micrometer Head Travel (Inch)	No. of Extension Rods	INSIZE No.	Code
2-8	[0.0003+0.00005 (L/2)] L=Max. Measuring Length (Inch)	0.5	6	3221-8	282039
2-12		0.5	10	3221-12	282040
8-20		1	3	3221-20	282042
8-40		1	8	3221-40	282043

Caliper Type Micrometer



- Graduation .001"
- Non-rotating spindle Ratchet stop
- Carbide measuring faces
- Supplied in fitted storage case

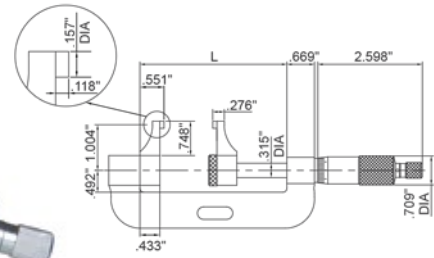

Range (Inch)	Accuracy (Inch)	L (Inch)	INSIZE No.	Code
0-1	0.0004	2.205	3238-1	281595

Disk Micrometer



- Measure root tangent length of gear
- Ratchet stop
- Supplied with setting standards

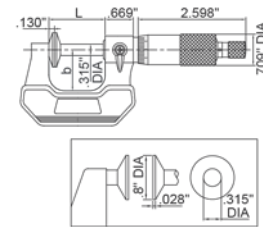

Range (Inch)	Graduation (Inch)	Accuracy (Inch)	Parallelism (Inch)	L (Inch)	b (Inch)	INSIZE No.	Code
0-1	0.0001	0.00015	0.0002	1.339	0.945	3282-1	281575

Groove Micrometer



- Measure width of grooves inside bores
- Non-rotating spindle
- Two graduations for inside and outside measurement

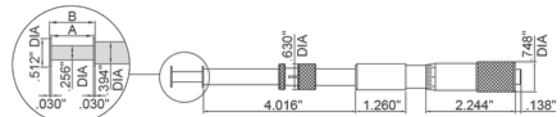

Range (outside A) (Inch)	Range (inside B) (Inch)	Graduation (Inch)	Accuracy (Inch)	INSIZE No.	Code
0-1	0.06-1.05	0.001	0.0004	3287-1	281908
1-2	1.05-2.05	0.001	0.0004	3287-2	281909

Hub Micrometer



- Measure hub thickness and shoulder inside a bore
- Graduation 0.0001"
- Ratchet stop
- Carbide measuring faces
- Supplied with setting standards (except 0-1")



Range (Inch)	Accuracy (Inch)	h1 (Inch)	h2 (Inch)	H (Inch)	INSIZE No.	Code
0-1	0.00015	0.236	0.354	0.736	3292-1	281796
1-2	0.00015	0.256	0.433	0.835	3292-2	281797

MICROMETERS

Can Seam Micrometer



- Measure the width, height and depth of can seams
- Graduation 0.001"

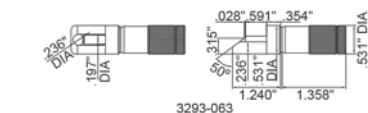
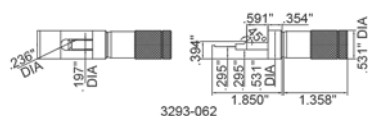
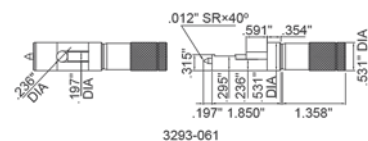

Range (Inch)	Accuracy (Inch)	INSIZE No.	Code
0-0.5	0.00015	3293-061	281825
0-0.5	0.00015	3293-062	281826
0-0.5	0.00015	3293-063	281827

Indicating Micrometer



- Micrometer head graduation 0.0001"
- Micrometer head accuracy 0.00015"
- Dial indicator: range ± 0.0015 ", graduation .00005", accuracy 0.00005"
- Carbide measuring faces
- Supplied with setting standards (except 0-1")

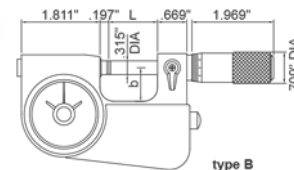
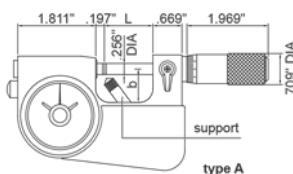

Micrometer Head Range (Inch)	Type	L (Inch)	b (Inch)	INSIZE No.	Code
0-1	A	1.122	0.748	3332-1	281845
0-1	B	1.122	0.748	3332-1B	281849

Electronic Outside Micrometer



With Interchangeable Anvils

- Resolution 0.001mm/0.0001" (resolution of 3506-100A and 3506-150A is 0.001mm/0.00005")
- IP65 dust/waterproof
- Button function: on/off, set, mm/inch, data transmit
- Data output
- Automatic power off
- Ratchet stop
- Carbide measuring faces
- Supplied with setting standards

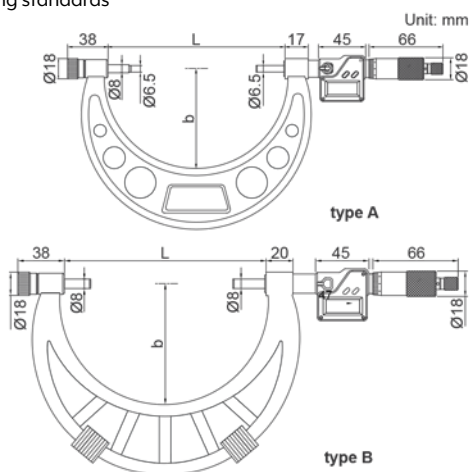

281197



281203

Range (mm/Inch)	Type	Accuracy	L (mm)	b (mm)	Setting Standard	INSIZE No.	Code
0-100/0-4	A	±5µm	105	57	25, 50, 75	3506-150A	281197
150-300/6-12	A	±8µm	305	165	150, 175, 200, 225, 250, 275	3506-300A	281201
300-400/12-16	B	±9µm	405	224	325, 375	3506-400A	281203

Electronic Point Micrometer



- Measure the web thickness of drills, small grooves and keyways
- Resolution .00005"/0.001mm IP65 dust/waterproof
- Button function: on/off, set,
- inch/mm, ABS/INC
- Data output
- Automatic power off
- Ratchet stop, carbide tips

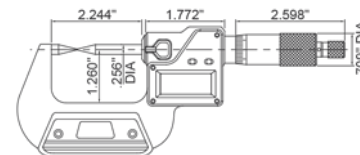

Range (Inch/mm)	Accuracy	INSIZE No.	Code
0-1/0-25	±0.00015	3530-25A	281349
0-1/0-25	±0.00015	3530-25E	877310
0-1/0-25	±0.00015	3530-25BE	877309

Electronic Spherical Anvil Tube Micrometer



- Measure wall thickness of tubes
- Resolution .00005"/0.001mm
- IP65 dust/waterproof
- Button function: on/off, set, inch/mm, ABS/INC
- Data output
- Automatic power off
- Ratchet stop
- Carbide measuring faces

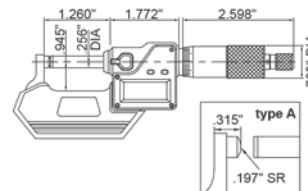

Range (Inch/mm)	Accuracy	INSIZE No.	Code
0-1/0-25	±.00015	3560-25E	877319

Electronic Micrometer Head



- Resolution 0.001mm/0.00005"
- IP65 dust/waterproof
- Button function: on/off, set, mm/inch, data transmit
- Data output, automatic power off
- Ratchet stop

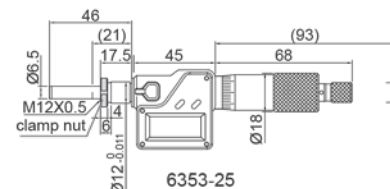

Range (Inch/mm)	Stem	Spindle Tip	Accuracy	INSIZE No.	Code
0-1/0-25	With clamp nut	Flat (Carbide)	±2µm	6353-25	282585

Setting Rings



- Class X of ASME B89.1.6
- For zero setting of inside micrometers, three points internal micrometers and bore gages
- The size marked on the setting ring is checked at the direction of the marking line
- Deviation is the difference between the ordered size and the size marked on the setting ring when supplied
- For example, the ordered size is .2", the size marked on the setting ring when supplied may be 0.20008"
- Supplied with manufacturer inspection certificate



Diameter (Inch)	INSIZE No.	Code
1/4	6313-1H4	889412
1/2	6313-1H2	282487
3/4	6313-3H4	877395
0.24	6313-0D24	877385
0.65	6313-0D65	877386
0.7	6313-0D7	877387
0.8	6313-0D8	877388
1.0	6313-1	282486
1.2	6313-1D2	877389

Diameter (Inch)	INSIZE No.	Code
1.4	6313-1D4	877390
1.6	6313-1D6	877391
1.8	6313-1D8	877392
2.0	6313-2	282489
2.5	6313-2D5	877393
3.0	6313-3	282492
3.5	6313-3D5	877394
4.0	6313-4	282494
5.0	6313-5	889417

Inside Micrometer



- Micrometer travel: 0.5"
- 5 rods
- Wide range I.D. measurements with interchangeable rods
- Each interchangeable rod is marked with its measuring range
- Sizes of interchangeable rods can be adjusted with spacing collars

Range (Inch)	Graduation (Inch)	Code
2-12	0.001	141-233

Micrometer Stand

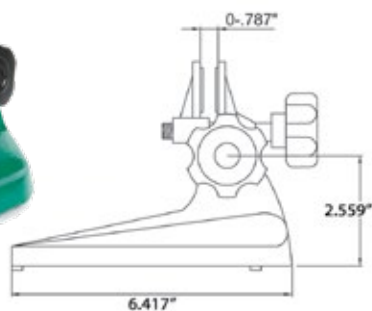

- For micrometers up to 4"

Description	INSIZE No.	Code
Cast stand with 2 separate locking handles	6301	282456

Electronic Depth Micrometer

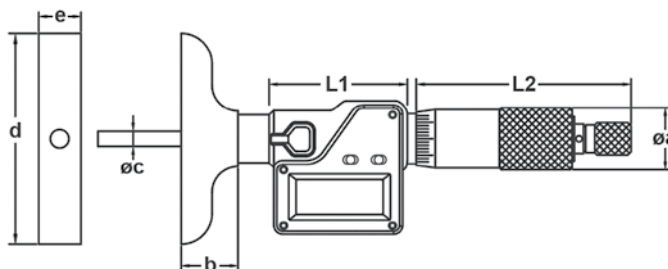

- Resolution: 0.0005"/0.01mm
- Micrometer head accuracy: ± 0.00012 "
- Rod accuracy: $\pm [0.001 + 0.0005 (L/3)]$ (L = measuring range in inch)
- Button function: on/off, set, inch/mm, ABS/INC
- IP65 Ingress protection level (dust/coolant proof)
- Automatic power off
- Battery LR44
- Auto power off
- Data output
- Rods with flat end
- Ratchet stop
- Supplied in fitted storage case

OPTIONAL ACCESSORY: SPC cable

Range (Inch/mm)	L1 (Inch)	L2 (Inch)	Øa (Inch)	b (Inch)	Øc (Inch)	d (Inch)	e (Inch)	No. of Rods	INSIZE No.	Code
0-2/0-50	1.772	2.598	0.709	0.669	0.177	3.996	0.669	2	3540-50E	281943
0-6/0-150	1.772	2.598	0.709	0.669	0.177	3.996	0.669	6	3540-150E	281945
0-12/0-300	1.772	2.598	0.709	0.669	0.177	3.996	0.669	12	3540-300E	281947

Depth Micrometers

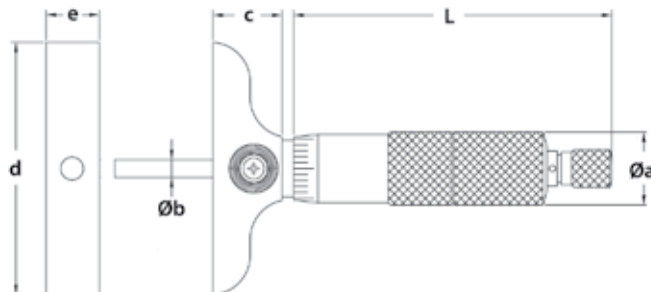

MICROMETERS

- Graduation: 0.001"
- Micrometer head accuracy: ±0.00012"
- Rod accuracy: ±[0.001 + 0.0005(L/3)] (L = measuring range in inch)
- Rods with flat ends
- Ratchet stop
- Supplied in fitted storage case

Range (Inch)	L (Inch)	Øa (Inch)	Øb (Inch)	c (Inch)	d (Inch)	e (Inch)	No. of Rods	INSIZE No.	Code
0-1	3.228	0.709	0.177	0.669	2.480	0.669	1	3241-B1	281927
0-4	3.228	0.709	0.177	0.669	2.480	0.669	4	3241-B4	281929
0-1	3.228	0.709	0.177	0.669	3.996	0.669	1	3241-1	281921
0-2	3.228	0.709	0.177	0.669	3.996	0.669	2	3241-2	281922
0-3	3.228	0.709	0.177	0.669	3.996	0.669	3	3241-3	877307
0-4	3.228	0.709	0.177	0.669	3.996	0.669	4	3241-4	281923
0-6	3.228	0.709	0.177	0.669	3.996	0.669	6	3241-6	281924
0-12	3.228	0.709	0.177	0.669	3.996	0.669	12	3241-12	281926

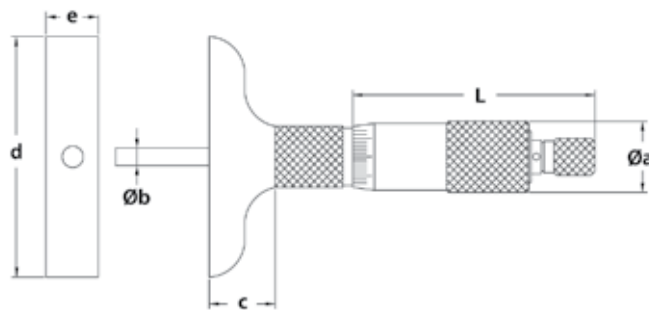

- Graduation: 0.001"
- Micrometer head accuracy: ±0.00012"
- Rod accuracy: ±[0.001 + 0.0005(L/3)] (L = measuring range in inch)
- Rods with flat end
- Ratchet stop
- Supplied in fitted storage case

Range (Inch)	L (Inch)	Øa (Inch)	Øb (Inch)	c (Inch)	d (Inch)	e (Inch)	INSIZE No.	Code
0-6	2.598	0.709	0.177	0.669	3.996	0.669	3240-6	281939

Micrometer Head



- Graduation: 0.001"
- Flat carbide tip
- Ratchet stop

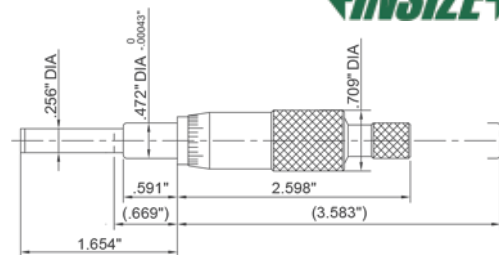

Range (Inch)	Accuracy (Inch)	INSIZE No.	Code
0-1	0.00015	6381-1W	816688

Electronic Indicators

Precision



- Meets ASME B89.1.10M-2001 standards
- Accuracy: $\pm 0.0015''$
- Hysteresis: 0.0005"
- 320 degree rotating display – digital/analog
- Stem diameter: 3/8"
- Button function: tolerance GO and NOGO display, data preset, measuring direction change, max/min/TIR measurement, inch/metric conversion, absolute/incremental measurement
- Keeps preset data and tolerance data in memory after restart
- Battery CR2032 – auto power off
- Data output
- Lug back
- Contact point thread #4-48UNF
- Supplied in fitted storage case

OPTIONAL ACCESSORIES:

- SPC cable
- Contact points
- Flat back



285053



876700



285051

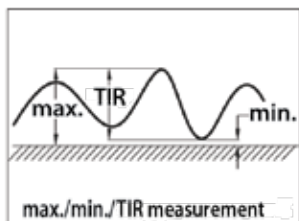
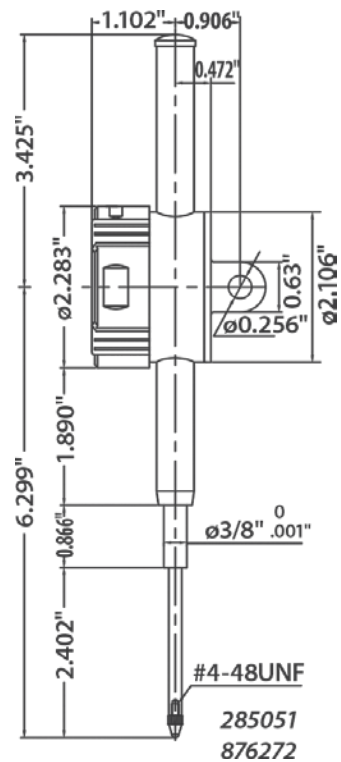
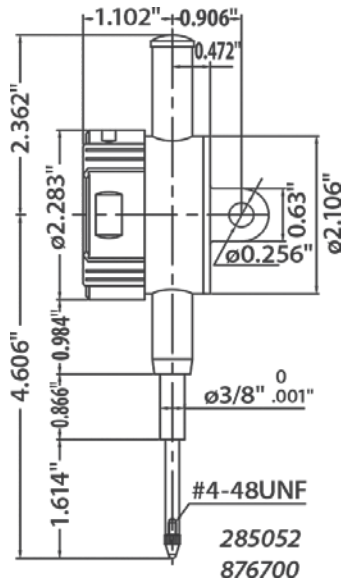
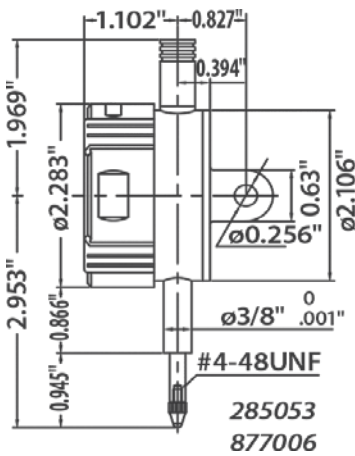

Resolution: 0.00005"/0.001mm

Range (Inch/mm)	INSIZE No.	Code
0.5/12.7	2103-10E	285053
1/25.4	2103-25E	285052
2/50.8	2103-50E	285051

Resolution: 0.0005"/0.01mm

Range (Inch/mm)	INSIZE No.	Code
0.5/12.7	2104-10E	877006
1/25.4	2104-25E	876700
2/50.8	2104-50E	876272

Electronic Indicators



Standard



- Meets ASME B89.1.10M-2001 standards
- Accuracy: $\pm 0.0015''$
- Hysteresis: 0.0005"
- Button function: on/off, inch/mm, zero
- Auto power off
- Battery CR2032
- Data output
- Lug back
- Contact point thread #4-48UNF
- Supplied in fitted storage case

OPTIONAL ACCESSORIES:

- SPC cable
- Contact points
- Flat back



877010

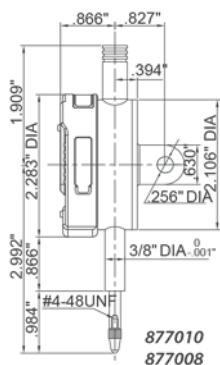

877010
877008



816392

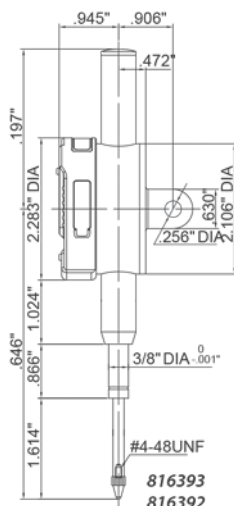

816393
816392



816394

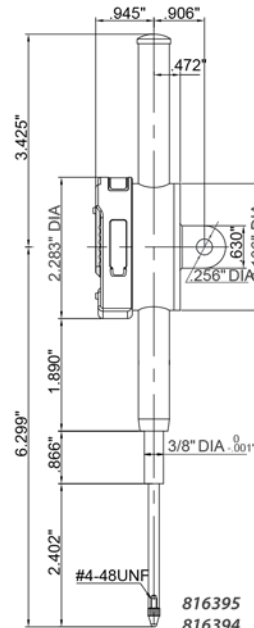

816395
816394

Resolution: 0.00005"/0.001mm

Range (Inch/mm)	INSIZE No.	Code
0.5/12.7	2112-10IE	877008
1/25.4	2112-25IE	816392
2/50.8	2112-50IE	816394

Resolution: 0.0005"/0.01mm

Range (Inch/mm)	INSIZE No.	Code
0.5/12.7	2112-10E	877010
1/25.4	2112-25E	816393
2/50.8	2112-50E	816395

INDICATORS

Electronic Indicators



Compact



- Meets ASME B89.1.10M-2001 standards
- Button function:
 - inch/mm: .. short press for inch/metric conversion
 - long press to change measuring direction
 - ABS: short press for absolute/incremental measurement
 - long press to preset data
 - O/ON:..... short press to turn on when power is off
 - long press to turn off
- Keep preset data in memory after restart
- Battery CR1632 – auto power off
- Data output
- Flat back
- Contact point thread #4-48UNF
- Supplied in fitted storage case

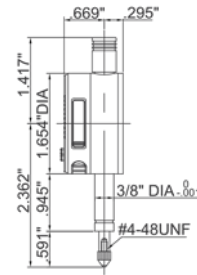

Range (Inch/mm)	Accuracy (Inch)	Resolution (Inch/mm)	Hysteresis (Inch)	INSIZE No.	Code
0.2/5	±0.0015	0.0005/0.01	0.0005	2114-5FE	877131
0.2/5	±0.00015	0.00005/0.001	0.00005	2114-5IFE	877130

Dial Indicators



Compact

- Meets ASME B89.1.10M-2001 standards
- Lug back
- Supplied with limit pointers and bezel clamp
- Supplied in fitted storage case

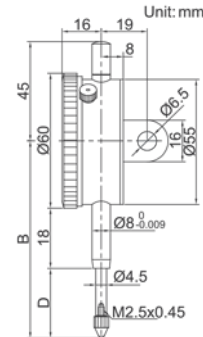

Range (Inch)	Accuracy (Inch)		Graduation	Range/rev.	Dial Reading	INSIZE No.	Code
	First 2.5 rev.	Overall					
0.1	-	±0.001	0.001	0.1	0-100	2304-01	282699
0.2	-	±0.001	0.001	0.1	0-100	2304-02	282700
0.25	±0.001	±0.001	0.001	0.1	0-100	2304-025	282701
0.1	-	±0.0005	0.0005	0.05	0-50	2304-015	282702
0.2	±0.0005	±0.0015	0.0005	0.05	0-50	2304-0205	282703
0.25	±0.0005	±0.0015	0.0005	0.05	0-50	2304-0255	282704

Flat back

Range (Inch)	Accuracy (Inch)		Graduation	Range/rev.	Dial Reading	INSIZE No.	Code
	First 2.5 rev.	Overall					
0.2	-	±0.001	0.001	0.1	0-100	2304-02F	877298

Electronic Indicators



Flat Back



- Meets ASME B89.1.10M-2001 standards
- Reading in digital and analog
- Display can be rotated by 320°
- Button function: tolerance Go and No-Go display, data preset, measuring direction change, max./min./TIR measurement, inch/metric conversion, absolute/incremental measurement
- Keep preset data and tolerance data in memory after restart
- Battery CR2032
- Automatic power off (time is adjustable)
- Data output
- Supplied in fitted storage case

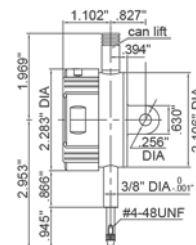

Range (Inch/mm)	Accuracy (Inch)	Hysteresis (Inch)	Max. measuring force (lbf)	INSIZE No.	Code
0.5/12.7	±0.00015	0.00005	0.337	2103-10FE	877288

Large Stroke Electronic Indicator



Lug Back



- Button function: on/off, zero, inch/mm, data preset, tolerance, change measuring direction, max./min./TIR measurement, absolute/incremental measurement
- Keep preset data and tolerance data in memory after restart
- Battery CR2032
- Automatic power off
- Data output
- With lug back
- Supplied in fitted storage case

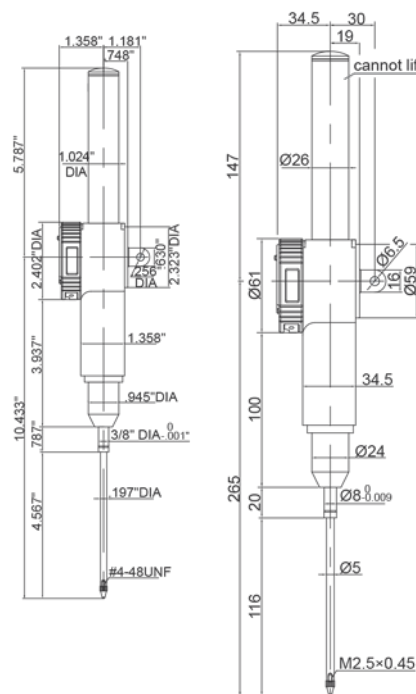

Range	Accuracy	Resolution	Hysteresis	INSIZE No.	Code
4"/100mm	±0.0015"	0.0005"/0.01mm	0.0005"	2117-100E	877292
4"/100mm	30µm	-	10µm	2117-100	877291

INDICATORS

Dial Indicators



Inch

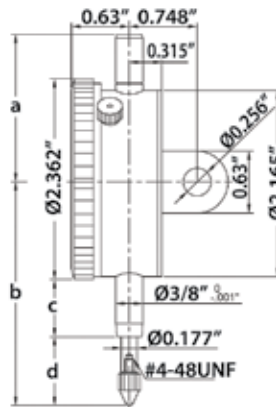

- Meets ASME B89.110M-2001 standards
- Lug back
- Bezel locking clamp and limit pointers
- Contact point thread: #4-48UNF
- Supplied in fitted storage case

Specifications				
Range (Inch)	a (Inch)	b (Inch)	c (Inch)	d (Inch)
0.25	1.811	2.953	0.787	0.984
0.5	1.811	2.953	0.787	0.984
1	1.811	3.346	0.787	1.375
2	4.370	5.472	1.969	2.323

OPTIONAL ACCESSORIES: Contact points, Flat back

Range (Inch)	Graduation (Inch)	First 2.5 Rev Accuracy (Inch)	Overall Accuracy (Inch)	Range per Rev (Inch)	Dial Reading	INSIZE No.	Code
0.25	0.001	±0.001	±0.001	0.1	0-100	2307-025	282705
0.5	0.001	±0.001	±0.002	0.1	0-100	2307-05	816156
1	0.001	±0.001	±0.002	0.1	0-100	2307-1	816158
2	0.001	±0.001	±0.004	0.1	0-100	2307-2	816160
0.25	0.0005	±0.0005	±0.0015	0.05	0-50	2307-0255	282707
0.5	0.0005	±0.0005	±0.0015	0.05	0-50	2307-055	282708
1	0.0005	±0.0005	±0.0020	0.05	0-50	2307-105	282709
2	0.0005	±0.0005	±0.0020	0.05	0-50	2307-205	282710

Dial Indicator

- Lug back



Range (Inch)	Graduation (Inch)	Bezel Diameter (Inch)	Reading	Code
0-1	0.001	2-3/16	0-100-0	841021

Large Face Dial Indicators



- Meets ASME B89.110M-2001 standards
- Lug back
- Bezel locking clamp and limit pointers
- Contact point thread: #4-48UNF
- Supplied in fitted storage case

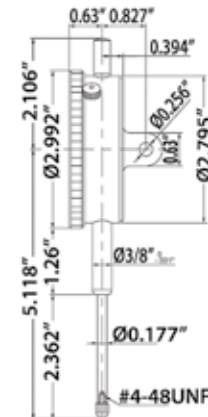

OPTIONAL ACCESSORIES: Contact points

Range (Inch)	Graduation (Inch)	First 2.5 Rev Accuracy (Inch)	Overall Accuracy (Inch)	Range per Rev (Inch)	Dial Reading	INSIZE No.	Code
1.5	0.001	±0.001	±0.004	0.1	0-100	*2312-15	282711
2	0.001	±0.001	±0.004	0.1	0-100	2312-2	282712

Precision Dial Indicator



- Meets ASME B89.1.10M-2001 standards
- Shock proof
- Jeweled bearing
- Lug back
- Bezel locking clamp and limit pointers
- Contact point thread #4-48UNF
- Supplied in fitted storage case

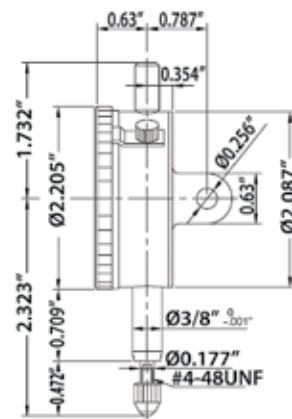

OPTIONAL ACCESSORIES: Contact points, Flat back

Range (Inch)	Graduation (Inch)	First 2.5 Rev Accuracy (Inch)	Overall Accuracy (Inch)	Range per Rev (Inch)	Dial Reading	INSIZE No.	Code
0.05	0.0001	±0.0001	±0.0003	0.01	0-100	2315-05	282719

INDICATORS

Back Plunger Dial Indicator



- Supplied with handle, 3 contact points and limit pointers
- Contact point thread #4-48UNF
- Supplied in fitted storage case

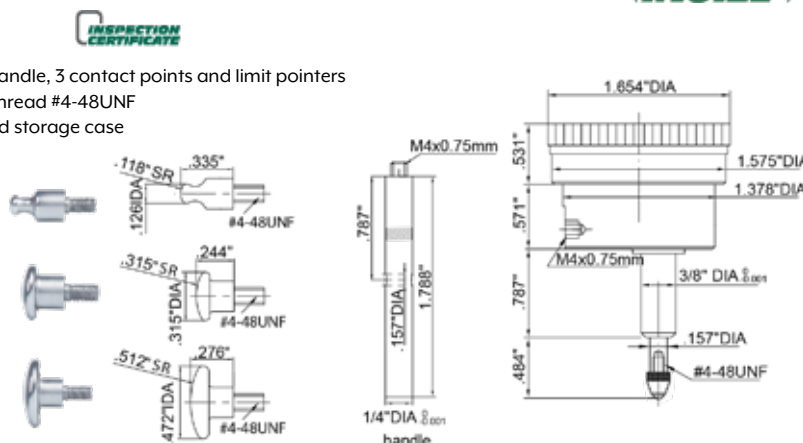

OPTIONAL ACCESSORIES: Contact points

Range (Inch)	Graduation (Inch)	Accuracy (Inch)	Hysteresis (Inch)	Range per Rev (Inch)	Dial Reading	INSIZE No.	Code
0.2	0.001	±0.001	±0.00033	0.1	0-100	2320-02	816371

Long Stroke Dial Indicators



- Lug back on 282665, flat back on 282664
- Hysteresis: 0.007mm
- Bezel locking clamp and limit pointers
- Contact point thread: M2.5 x 0.45
- Supplied in fitted storage case

Metric

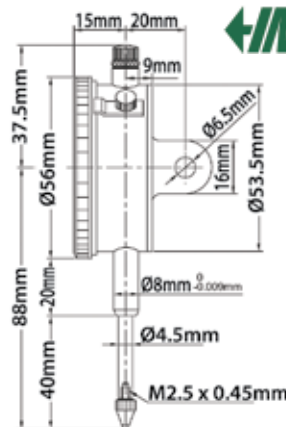

OPTIONAL ACCESSORIES: Contact points, Flat back or Lug back

Range (mm)	Graduation (mm)	Accuracy (mm)	Range per Rev (mm)	Dial Reading	Back Style	INSIZE No.	Code
30	0.01	0.035	1	0-100	Lug back	2310-30A	282665
30	0.01	0.035	1	0-100	Flat back	2310-30FA	282664

Dial Indicator

Metric



- Lug back
- Hysteresis: 0.02mm
- Bezel locking clamp and limit pointers
- Contact point thread: M2.5 x 0.45
- Supplied in fitted storage case

OPTIONAL ACCESSORIES: Contact points, Flat back

Range (mm)	Graduation (mm)	Accuracy (mm)	Range per Rev (mm)	Dial Reading	INSIZE No.	Code
25	0.1	0.06	10	0-10	2318-25	816164



Long Stroke Dial Indicators



- Graduation: 0.001"
- Lug back
- Bezel locking clamp and limit pointers
- Contact point thread: #4-48UNF
- Supplied in fitted storage case

OPTIONAL ACCESSORIES: Contact points, Flat back

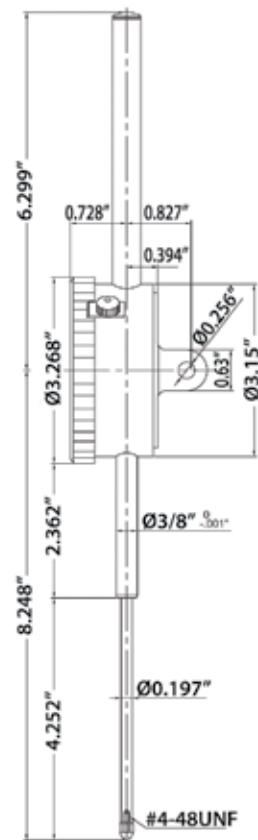
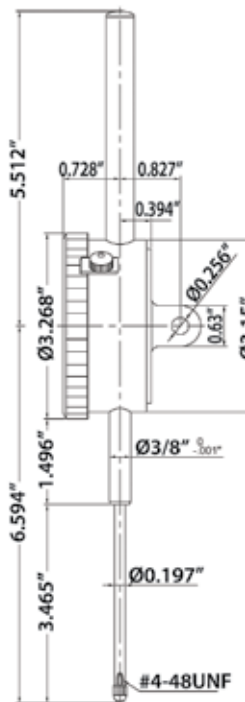
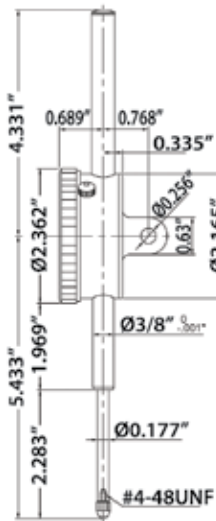

Range (Inch)	First 2.5 Rev Accuracy (Inch)	Overall Accuracy (Inch)	Range per Rev (Inch)	Dial Reading	INSIZE No.	Code
2	±0.001	±0.004	0.1	0-100	*2326-2	282715
3	±0.001	±0.005	0.1	0-100	2326-3	282717
4	±0.001	±0.005	0.1	0-100	2326-4	282718

NOTE: 282717 and 282718 can only be used vertically

Indicator Points



Ball Point Steel & Carbide

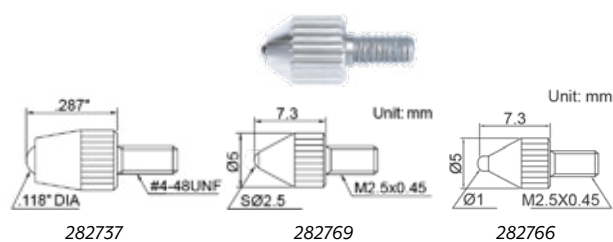

INSIZE No.	Code
6282-0102	282737
6282-0304	282769
6282-0301 (Steel)	282766

Roller Points Steel

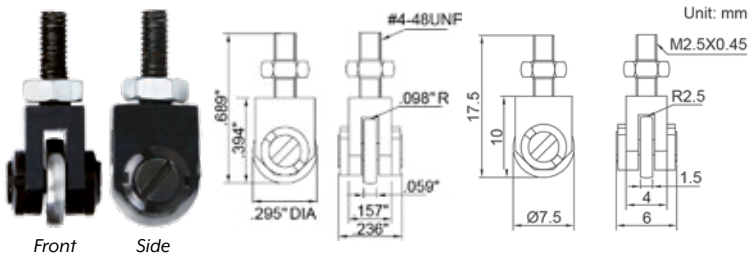

INSIZE No.	Code
6282-1902	282827
6282-1901	282826

Spherical Points Steel

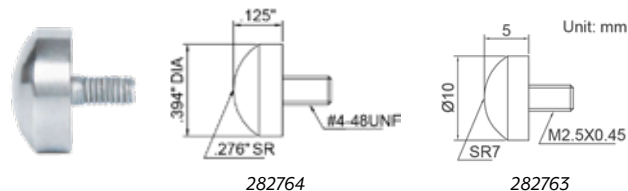

INSIZE No.	Code
6282-0402	282764
6282-0401	282763

Shell Points Steel



Length	INSIZE No.	Code
0.156"	6282-0201	282753
5mm	6282-0202	282754
15mm	6282-0205	282757

Flat Points Steel

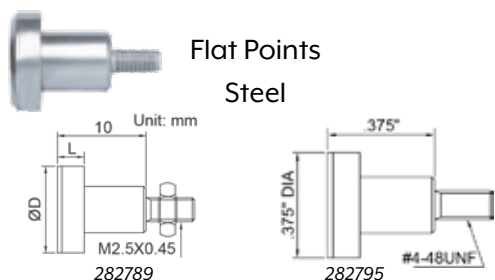

INSIZE No.	Code
6282-1201	282789
6282-1207	282795

Conical Points Steel

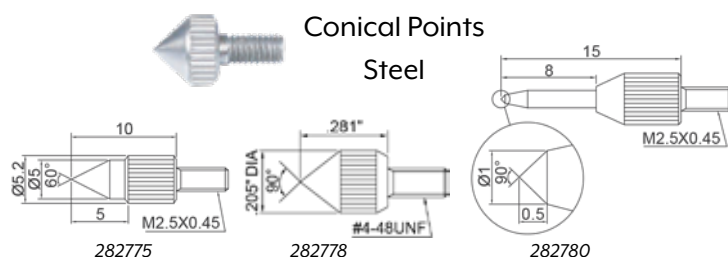

INSIZE No.	Code
6282-0601	282775
6282-0702	282778
6282-0901	282780

Needle Points Steel & Carbide

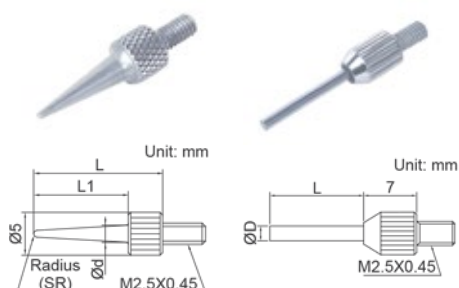

INSIZE No.	Code
6282-1602 (Steel)	282782
6282-1708 (Carbide)	282835

INDICATORS



Bison is a global leader in production of professional tooling for machining.
KAR stocks a range of sizes of lathe chucks from 5" to 20".
Bison is empowered by precision and supplied by KAR.



Product Categories include:
Lathe Chucks
Milling Fixtures
Live and Solid Centers
Spare parts and accessories

SEE TURNING, MILLING & WORK HOLDING

Indicator Point Set

Steel

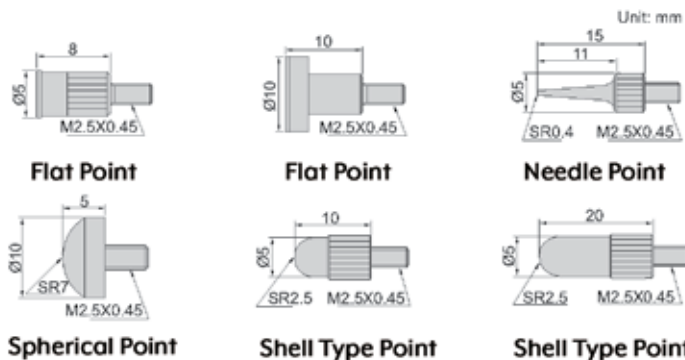

Unit: mm

INSIZE No.	Code
6282-S6	282848

INDICATORS

Clamps for Dial Test Indicators



ØD (mm)	INSIZE No.	Code
4	6298-1	877384
8	6298-2	289027

Dial Indicator

Basic Type | Flat Back



- Meets DIN878 standards
- Jeweled bearing
- Supplied with limit pointers and bezel clamp
- Packed in carton box

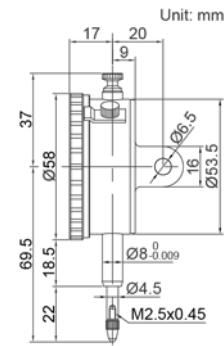

Range (mm)	Graduation (mm)	Accuracy	Hysteresis	Range per Rev (mm)	Dial Reading	INSIZE No.	Code
10	0.01	17µm	3µm	1	0-100	2301-10F	877295

Long Stroke Dial Indicator

Basic Type



- Supplied with limit pointers and bezel clamp
- Packed in carton box

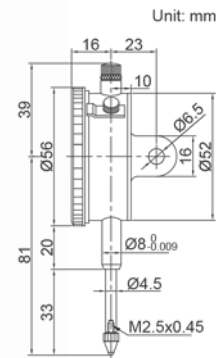

Range (mm)	Graduation (mm)	Accuracy	Hysteresis	Range per Rev (mm)	Dial Reading	Back	INSIZE No.	Code
25	0.01	35µm	7µm	1	0-100	Flat Back	2302-25F	877297
25	0.01	35µm	7µm	1	0-100	Lug Back with spare Flat Back	2302-25	877296

Reverse Reading Dial Indicator



- Meet ASME B89.1.10M-2001
- With lug back (2307-IR) and flat back (2307-IRF)
- Supplied with limit pointers and bezel clamp

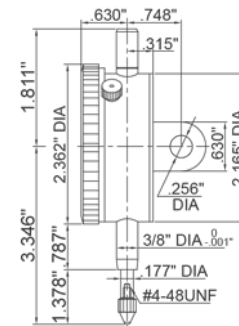

Range (Inch)	Graduation (Inch)	First 2.5 Rev Accuracy (Inch)	Overall Accuracy (Inch)	Range per Rev (Inch)	Dial Reading	INSIZE No.	Code
1	0.001	±0.001	±0.002	0.1	100-0	2307-IR	877299
1	0.001	±0.001	±0.002	0.1	100-0	2307-IRF	877300

Indicator Extension Rods



Steel

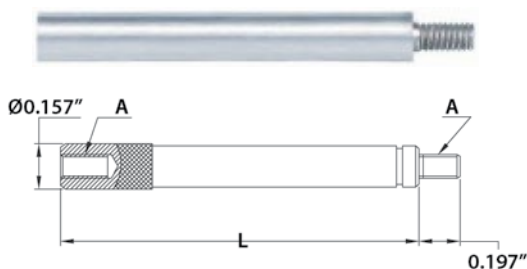

L (Inch)	A Thread	INSIZE No.	Code
1	#4-48UNF	6282-2018	282823
2	#4-48UNF	6282-2019	282824
4	#4-48UNF	6282-2020	282825

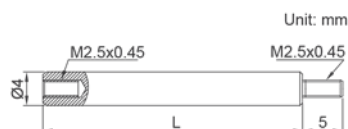

L (mm)	INSIZE No.	Code
10	6282-2001	282806
15	6282-2002	282807
20	6282-2003	282808
25	6282-2004	282809
40	6282-2007	282812
50	6282-2009	282814
70	6282-2013	282818
100	6282-2017	282822

Styli for Dial Test Indicators

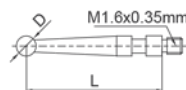

For Dial Test Indicator	Material of Contact Point	L (mm)	D (mm)	INSIZE No.	Code
2380-08	Steel	13.5	SØ1	6284-1	282869
2398-08	Carbide	13.5	SØ2	6284-3	282871
2381-08					
2399-08					
2380-02	Carbide	12.5	SØ2	6284-22	282870
2381-02					
2381-021					

Electronic Indicator

Standard Type | Flat Back



- Button function: on/off, inch/mm, zero, data preset, change measuring direction, absolute/incremental measurement
- Switchable high/low frequency measurement mode, high frequency mode is suitable for high speed moving of spindle and has large power consumption, low power consumption in low frequency mode
- Keep preset data in memory after restart
- CR2032 battery, automatic power off (time is adjustable)
- Data output

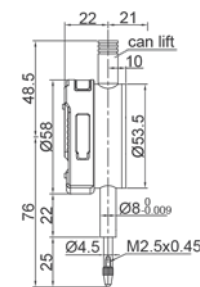

Range (mm/Inch)	Resolution (mm/Inch)	Accuracy	Hysteresis	Max. measuring force	INSIZE No.	Code
12.7/0.5	0.001/0.00005	5µm	2µm	1.5N	2112-101F	877289
12.7/0.5	0.01/0.0005	20µm	10µm	1.5N	2112-10F	877290

Indicator Flat Backs

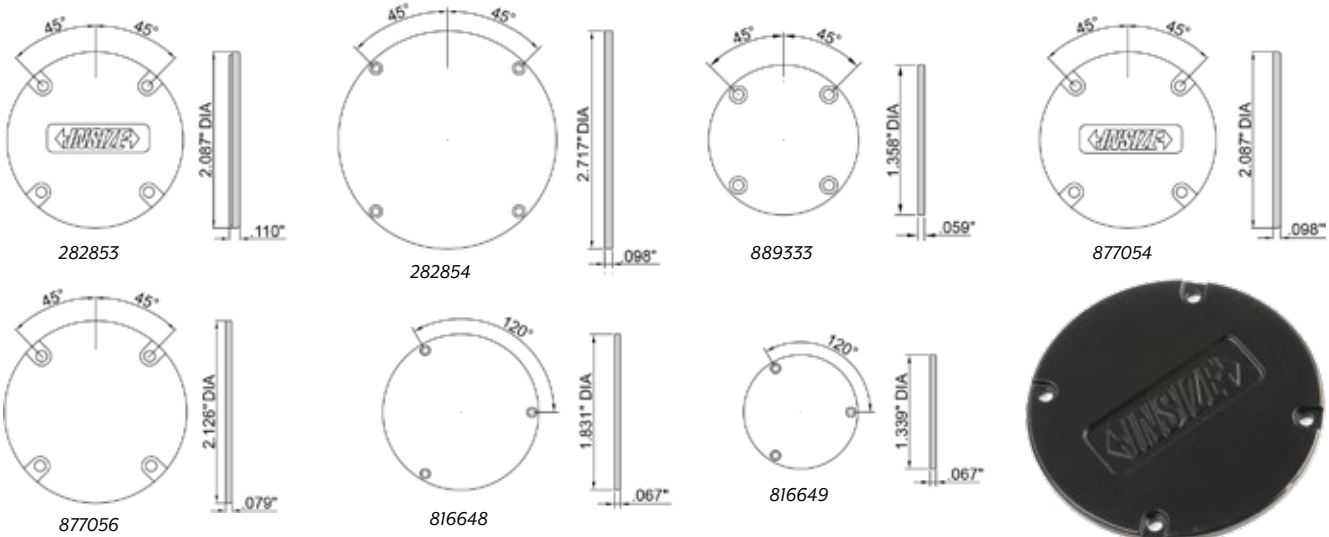

282853



816649

For use with Electronic/Dial Indicators	INSIZE No.	Code
INSIZE series 2311	7330-F1	282852
INSIZE series 2324 and series 2315	7330-F2	282853
INSIZE No. 2326-3 and 2326-4	7330-F3	282854
INSIZE series 2304	7330-F4	889333
INSIZE series 2103, 2104, 2109, 2112, 2113, 2115, 2117 and 2118	7330-F5	877054
INSIZE series 2307 and No. 2326-2	7330-F6	877056
INSIZE series 2837	7330-F7	816648
INSIZE series 2832	7330-F8	816649

Indicator Lug Backs

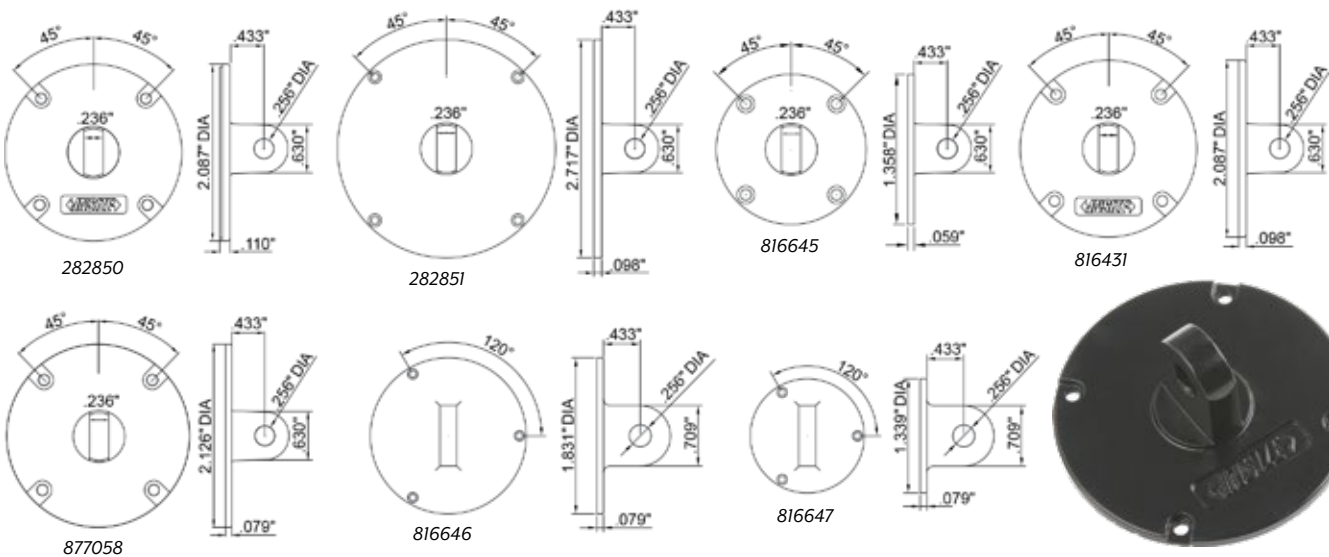

282850



816647

For use with Electronic/Dial Indicators	INSIZE No.	Code
INSIZE series 2324 and series 2315	7330-L2	282850
INSIZE No. 2326-3 and No. 2326-4	7330-L3	282851
INSIZE series 2304	7330-L4	816645
INSIZE series 2103, 2104, 2109, 2112, 2113, 2115, 2117 and 2118	7330-L5	816431
INSIZE series 2307 and No. 2326-2	7330-L6	877058
INSIZE series 2837	7330-L7	816646
INSIZE series 2832	7330-L8	816647

Indicator Magnetic Backs



For use with Electronic/ Dial Indicators	Ø D	INSIZE No.	Code
INSIZE series 2103 INSIZE series 2104 INSIZE series 2109 INSIZE series 2112 INSIZE series 2113 INSIZE series 2115 INSIZE series 2117 INSIZE series 2118	2.028	7331-M1	877211
INSIZE series 2307	2.126	7331-M2	877212

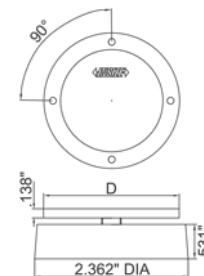

Dial Test Indicators



- Meets DIN2270 standards
- Jeweled bearing
- Carbide contact point
- Two measuring directions
- Anti magnetic body
- Supplied with two clamps: diameter Ø4mm and Ø8mm

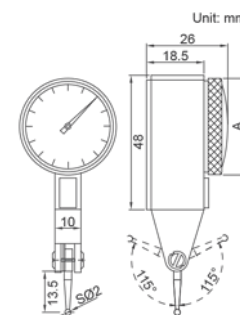

Range (mm)	Graduation (mm)	Accuracy	Hysteresis	Dial Reading	ØA (mm)	L (mm)	INSIZE No.	Code
0.8	0.01	13µm	3µm	0-40-0	30	13.5	2380-08	816168

Granite Dial Indicator Stands

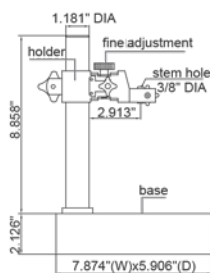

- Vertical travel of holder: 5.906"
- Fine adjustment range .079"
- Supplied with dust cover

Applicable Holding Stem	Base	INSIZE No.	Code
Ø3/8"	Flatness 98µin	6866-150E	877397

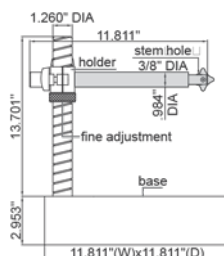

- Vertical travel of holder: 9.843"
- Fine adjustment range: entire stroke
- Supplied with dust cover

Applicable Holding Stem	Base	INSIZE No.	Code
Ø3/8"	Flatness 110µin	6867-250E	877398

Indicator Point Set



Inch

- A 22-piece assortment which includes all popular indicator contact points
- Standard 4-48 thread
- Supplied in plastic case

Code

805784

Indicator Holder

Zero Set

- The Zero Set fits all dovetail equipped indicators and is used for checking set-ups
- Checks the alignment of the centers of round materials in relation to the cutting head
- Significantly speeds the set-up operation
- Equipped with a spindle post with 1/4", 3/8", and 1/2" diameters and has an effective measuring range of 3/8" to 9"



Code

425498

Universal Indicator Holder

Indicol Type

- Ideal for Bridgeports
- 1-7/8" spindle diameter
- 12" reach



Code

302269

Indicator Holder

Zero Set Universal

- A unique attachment for our standard Zero Set indicator accessory
- Allows the placement of any test indicator with dovetails in a multitude of positions
- Angles up to 90° either side
- Bends both forward and backward
- Allows for an infinite range of measurements over an extensive area
- Attaches in seconds to 425498 Zero Set



NOTE: UNIVERSAL UNIT CIRCLED

Code

425497

Half Round Indicator Holder

- Two-point adjustment
- 1/4" shank
- For dovetail and 5/32" stem indicators



Code

302268

Universal Indicator Holder

- Allows user expanded ability to hold dovetail test indicators at infinitely variable angles and positions
- Brass lock gib does not scar dovetail



Code

840620

Dovetail Clamp

- Fits all indicators and clamps all standard dovetails
- Clamps all diameters from 1/8" to 1/4"



Code

840622

Granite Dial Comparator Stand

- Microscrew fingertip control
- Black granite surface plate, 2" thick
- 0.00005" granite flatness
- Full 6" square
- 10" overall height
- Weight: 14lbs/6kg
- Accepts all AGD indicators



Indicator not included

Code

840349

Magnetic Indicator Holder

- A universal magnetic base that will save time and improve accuracy
- Strong magnet with 45 lbs. of holding power
- Zinc diecast housing
- 5 different locations for mounting accessories:
 - 3 positions 1/4-20 for lug mounts
 - 1 tapped hole 10-32
 - 1 reamed hole 3/8"
- Size: 4-1/2" x 1 x 1-1/4"



Code

425560



Dial Test Indicator

Back Plunger Type

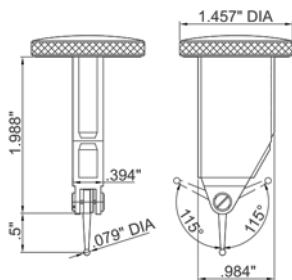

- Jeweled bearing
- Carbide contact point
- Two measuring directions
- Anti magnetic body
- Supplied with two clamps: 5/32" diameter and 3/8" diameter

Range (Inch)	Graduation (Inch)	Accuracy (Inch)	Dial Reading	INSIZE No.	Code
0.03	0.0005	±0.0005	0-15-0	2398-03	877156

INDICATORS

Dial Test Indicator

Tilted Face Type

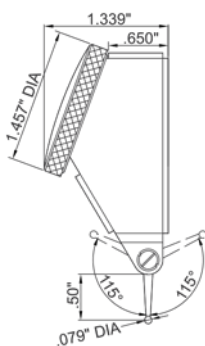

- Jeweled bearing
- Carbide contact point
- Two measuring directions
- Anti magnetic body
- Supplied with two clamps: 5/32" diameter and 3/8" diameter

Range (Inch)	Graduation (Inch)	Accuracy (Inch)	Dial Reading	INSIZE No.	Code
0.03	0.0005	±0.0005	0-15-0	2399-03	877157

Dial Test Indicator

Large Range Back Plunger Type

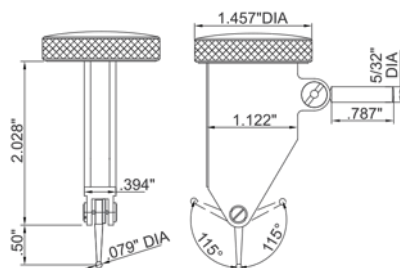

- Jeweled bearing
- Carbide contact point
- Two measuring directions
- Anti magnetic body
- Supplied with two clamps: 5/32" diameter and 3/8" diameter

Range (Inch)	Graduation (Inch)	Accuracy (Inch)	Dial Reading	INSIZE No.	Code
0.06	0.0005	±0.0008	0-15-0	2480-06	877158

Dial Test Indicators



282858



Supplied with two clamps

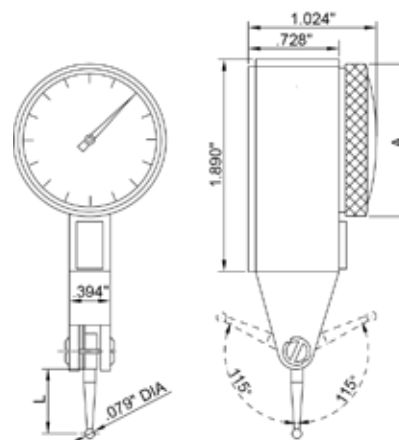

- Jeweled bearing
- Carbide contact point
- Two measuring directions
- Anti-magnetic body
- Supplied with two clamps: 5/32" and 3/8" diameters
- Supplied in fitted storage case

OPTIONAL ACCESSORY: Contact point (stylus) - series 6284

Range (Inch)	Graduation (Inch)	Accuracy (Inch)	Dial Reading	ØA (Inch)	L (Inch)	INSIZE No.	Code
0.03	0.001	±0.001	0-15-0	1.181	0.500	2380-31	282858
0.03	0.0005	±0.0005	0-15-0	1.181	0.500	2380-35	816170
0.008	0.0001	±0.0001	0-40-0	1.181	0.563	2380-301	816172
0.03	0.001	±0.001	0-15-0	1.457	0.500	2381-31	282859
0.03	0.0005	±0.0005	0-15-0	1.457	0.500	2381-35	282860
0.008	0.0001	±0.0001	0-40-0	1.457	0.563	2381-301	282861

Dial Test Indicator



With Long Stylus



Supplied with two clamps

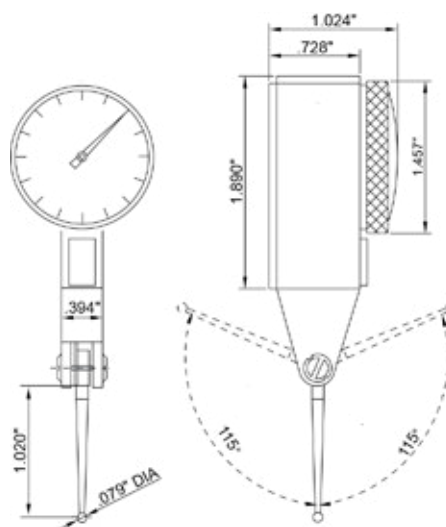

- Jeweled bearing
- Carbide contact point
- Two measuring directions
- Anti-magnetic body
- Supplied with two clamps: 5/32" and 3/8" diameters
- Supplied in fitted storage case

OPTIONAL ACCESSORY: Contact point (stylus) - series 6284

Range (Inch)	Graduation (Inch)	Accuracy (Inch)	Dial Reading	INSIZE No.	Code
0.03	0.0005	±0.0005	0-15-0	2383-35A	816372

Long Range Dial Test Indicator



INSIZE
INSPECTION
CERTIFICATE



Supplied with two clamps

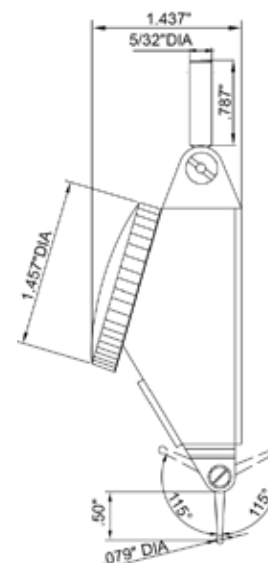

- Jeweled bearing
- Carbide contact point
- Two measuring directions
- Anti-magnetic body
- Supplied with two clamps: 5/32" and 3/8" diameters
- Supplied in fitted storage case

OPTIONAL ACCESSORY: Contact point (stylus) - series 6284

Range (Inch)	Graduation (Inch)	Accuracy (Inch)	Dial Reading	INSIZE No.	Code
0.06	0.0005	±0.0008	0-15-0	2386-006A	816174

Styli for Dial Test Indicators



For use with Dial Test Indicators	Contact Point Material	L (Inch)	ØD (Inch)	INSIZE No.	Code
INSIZE No. 2380-31, 2380-35, 2381-31, 2381-35, 2398-03, 2399-03	Steel	0.500	0.039	6284-9	876268
	Carbide	0.500	0.079	6284-10	285265
	Ruby	0.500	0.079	6284-11	816409
	Carbide	0.500	0.118	6284-12	816410
INSIZE No. 2380-301, 2381-301	Steel	0.563	0.039	6284-13	816411
	Carbide	0.563	0.079	6284-14	816412
	Ruby	0.563	0.079	6284-15	816413
	Carbide	0.563	0.118	6284-16	816414
INSIZE No. 2383-35A	Steel	1.020	0.039	6284-17	816373
	Carbide	1.020	0.079	6284-18	816374
	Ruby	1.020	0.079	6284-19	816375
	Carbide	1.020	0.118	6284-20	816376
INSIZE No. 2386-006A, 2480-06	Steel	0.500	0.039	6284-65	816377
	Carbide	0.500	0.079	6284-66	816378
	Ruby	0.500	0.079	6284-67	816379
	Carbide	0.500	0.118	6284-68	816380
INSIZE No. 2380-02 and 2381-02	Carbide	12.5 mm	2 mm	6284-22	282870

INDICATORS

Dial Test Indicator Holders



- Supplied with hex key

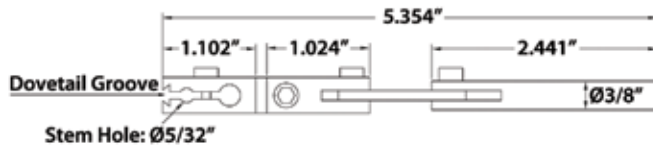

INSIZE No.	Code
6296-2	877030

Universal



- Set the indicator at a desired position

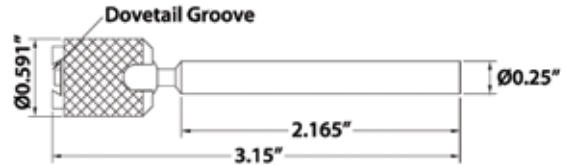

INSIZE No.	Code
6293-5	282880

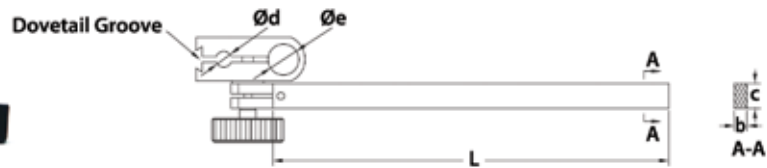

L Stem Length (Inch)	b (Inch)	c (Inch)	Ød Stem Hole (Inch)	Øe Stem Hole (Inch)	INSIZE No.	Code
2	0.354	0.354	5/32	3/8	6293-7	816416
4	0.25	0.5	5/32	3/8	6293-3	282878

Dial Test Indicator Centering Holders



- Center cylinders or holes on machine tools

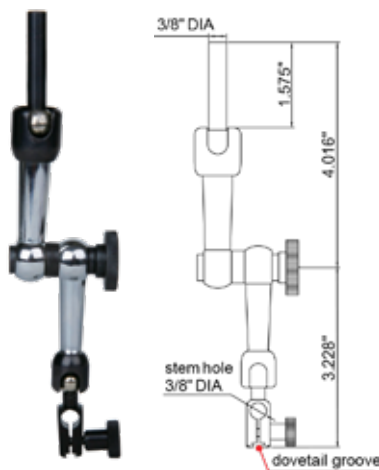

INSIZE No.	Code
6295-IAE	284452



INSIZE No.	Code
6291-2	282875



Indicator Centering Holders

- Center cylinders or holes on machine tools
- For use with dial test indicators or dial indicators

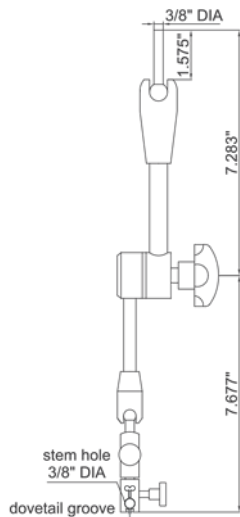

INSIZE No.	Code
6294-1AE	284453

INDICATORS

Dial Test Indicator Holders

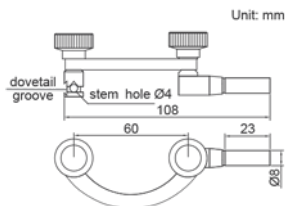

INSIZE No.	Code
6291-1	282874

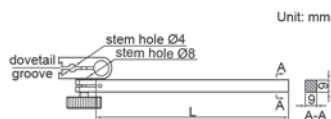

INSIZE No.	Code
6293-1	282876

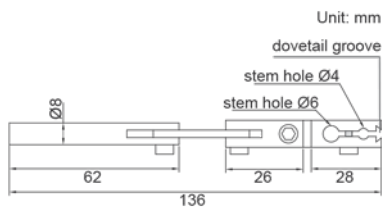

INSIZE No.	Code
6296-1	877383

- Supplied with hex key



INSIZE No.	Code
6297-1	816523



Electronic Depth Gage

With Extension Rods

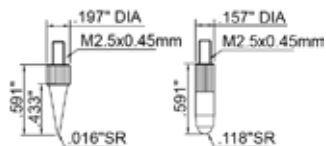
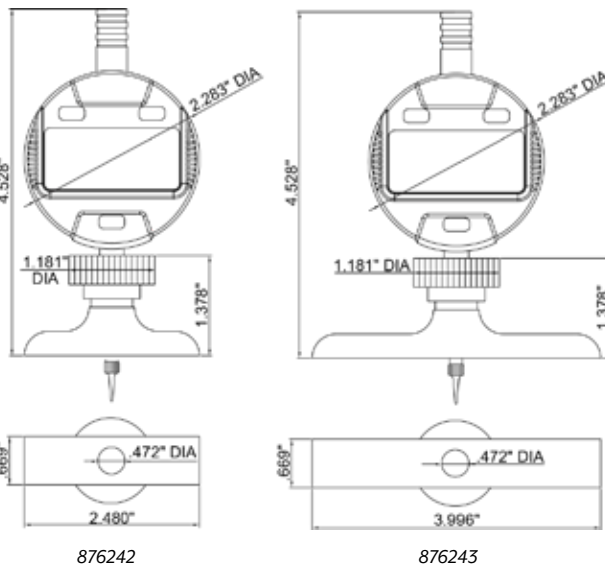

- Indicator resolution: 0.0005"/0.01mm
- Indicator stroke: 0.5"/12.7mm
- Button function: on/off, zero, inch/mm, ABS, data preset, change measuring direction
- Auto power off
- Battery CR2032
- Data output
- Stainless steel base
- Supplied with pointed tip and ball tip
- Supplied in fitted storage case

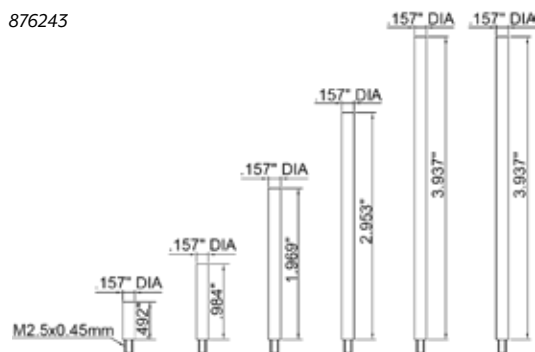

Range (Inch/mm)	Accuracy (Inch)	L (Inch)	a (Inch)	Ob (Inch)	c (Inch)	d (Inch)	Øe (Inch)	INSIZE No.	Code
0-12/0-300	±0.0008	4.528	1.378	1.181	2.480	0.669	0.472	2141-201A	876242
0-12/0-300	±0.0008	4.528	1.378	1.181	3.996	0.669	0.472	2141-202A	876243

Electronic Depth Gage

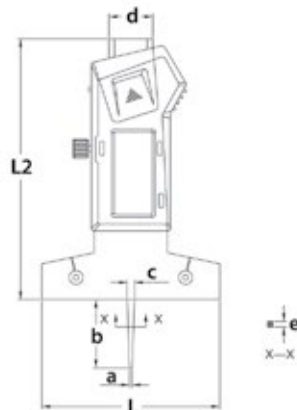

- Measures depth of small grooves, holes, and tire treads
- Resolution: 0.0005"/0.01mm
- Buttons: on/off, zero, inch/mm
- Supplied with zero set surface
- Auto power off, move unit to turn on
- Battery CR2032
- Data output
- Stainless steel
- Supplied in fitted storage case

OPTIONAL ACCESSORY: SPC cable

Range (Inch/mm)	Accuracy (Inch)	L (Inch)	L2 (Inch)	a (Inch)	b (Inch)	c (Inch)	d (Inch)	e (Inch)	INSIZE No.	Code
0-1/0-25	±0.0012	2.559	3.543	0.039	0.984	0.118	0.630	0.079	1145-25A	284550

Electronic Depth Gage



With Round Bar

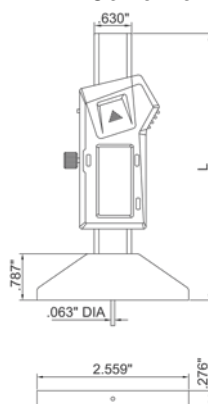

- Measures depth of small grooves and holes
- Resolution: 0.0005"/0.01mm
- Buttons: on/off, set, inch/mm, preset (+, -)
- Auto power off, move unit to turn on
- Battery CR2032
- Data output
- Stainless steel
- Supplied in fitted storage case

OPTIONAL ACCESSORY: SPC cable

Range (Inch/mm)	Accuracy (Inch)	L (Inch)	INSIZE No.	Code
0-1/0-25	±0.0008	4.488	1140-25	877114
0-2/0-50	±0.0008	5.512	1140-50	877115

INDICATOR DEPTH GAGES

Dial Depth Gage

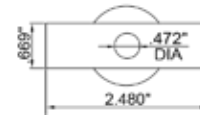
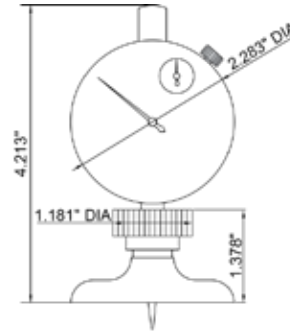

- Indicator graduation: 0.001"
- Indicator stroke: 0.5"
- Stainless steel base
- Supplied with pointed tip and ball tip
- Supplied in fitted storage case

Range (Inch)	Accuracy (Inch)	Base (Inch)	INSIZE No.	Code
0-1.2	±0.0012	2.480 x 0.669	2341-E1	283207

INDICATOR DEPTH GAGES

Dial Depth Gage



With Extension Rods

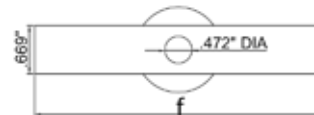
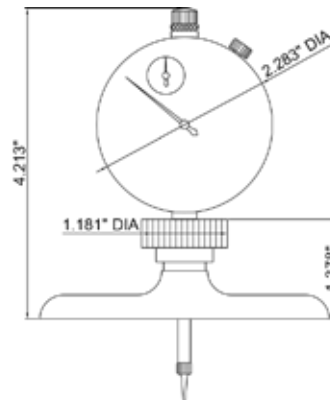
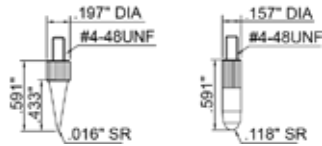
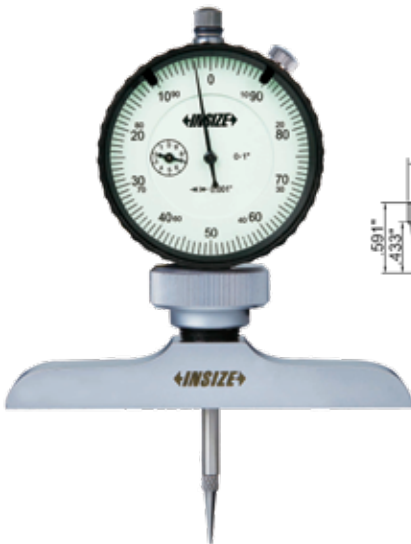

- Indicator graduation: 0.001"
- Indicator stroke: 1"
- Stainless steel base
- Extension rods: 1" (1pc.), 2" (1pc.) 3" (1pc.), 4" (2pcs.)
- Supplied with pointed tip and ball tip
- Supplied in fitted storage case

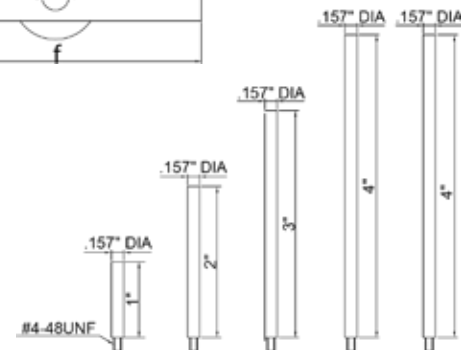

Range (Inch)	Accuracy (Inch)	L (Inch)	a (Inch)	Øb (Inch)	Øc (Inch)	d (Inch)	Øe (Inch)	f (Inch)	INSIZE No.	Code
0-1.2	±0.002	4.213	1.378	1.181	2.283	0.669	0.472	2.480	2341-2E1	876240
0-1.2	±0.002	4.213	1.378	1.181	2.283	0.669	0.472	3.996	2341-2E2	876241



SPC Keyboard Data Output Cables

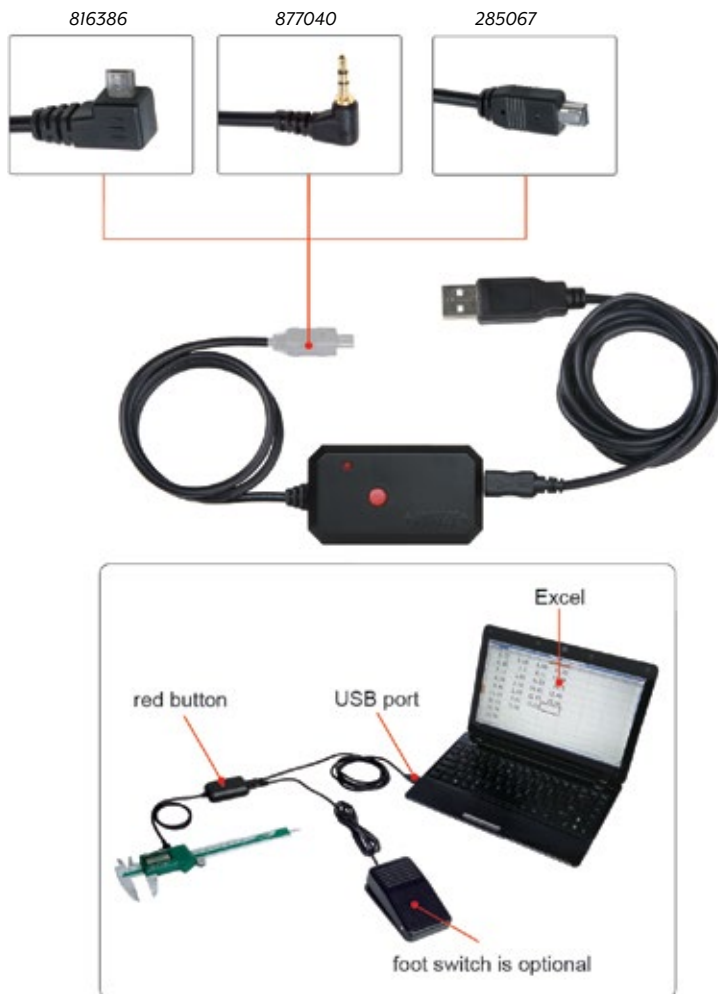

- Without special software, data may be exported to Microsoft Excel, Microsoft Word, CAD, Skype, etc.
- Press red button or the foot switch (optional) to input data

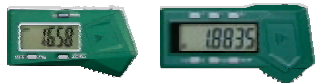

DATA OUTPUT

For use with...	Description	INSIZE No.	Code
 <p>For electronic callipers, electronic depth gages (except 1103 series), and electronic height gages</p>	Cable 100" length	7302-SPC5B	816386
 <p>For electronic micrometers (except for 3631, 3632, 3109, and 3109 series)</p>	Cable 100" length	7302-SPC2A	877040
 <p>For electronic calipers 1103 series only</p>	Cable 100" length	7302-SPC4	285067
For Electronic Calipers	Cable 120" length	7302-21	877412
For large Electronic Calipers (range ≤ 40") and electronic height gages	Cable 100" length	7302-22	877413

Wireless Data Transmission System



- Through wireless transmission, the measurement data can be transmitted to computers or mobile phones
- For windows and android systems
- Wireless zigbee protocol, conforming to IEEE802, 2.4GHz band Transmission distance is 49ft (Under the condition of no obstruction and no electromagnetic interference. The transmission distance of built-in wireless measuring tools can be found in their respective introduction.)

Transmitter

- Connecting to digital measuring tools such as calipers, micrometers and indicators
- Press the transmit button to send data
- CR2032 battery



For use with...	Description	INSIZE No.	Code
Electronic Calipers and Electronic Depth Gages	Transmitter	7315-21	877414
For Electronic Micrometers	Transmitter	7315-30	877269
For Electronic Indicators	Transmitter	7315-50M	877271

Receiver (Keyboard signal)

- For computers and mobile phones with windows and android systems
- Recognized as HID keyboard device, press transmit button of transmitter, which is recognized by computers or mobile phones as keyboard input data and press enter, such as 1.34K.
- No need to install drivers and software
- Data can be transmitted to excel, word, txt etc.
- Suitable for any software which can receive keyboard signal

Description	INSIZE No.	Code
Single channel receiver	7315-3	877267
Multichannel receiver	7315-7	877415



Receiver (text format, virtual com port)

- Suitable for computers with windows system
- Text format virtual com port, converted to keyboard format with supplied software
- Supplied with EXCEL directional input software (please refer to the next page for details)
- Measurement data can be transmitted to excel, word, txt etc. and any software which receives keyboard signal

Description	INSIZE No.	Code
Multichannel receiver	7315-2	877266



4-Channel Hub



Description	INSIZE No.	Code
4-channel hub Length 0.2m USB computer plug	7324-HUB4	877416

Magnetic Stands

With Dual Stems

- For electronic/dial indicators and dial test indicators



816250



816252



282886



816254

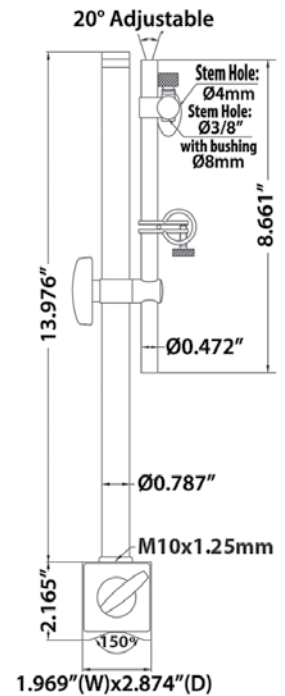
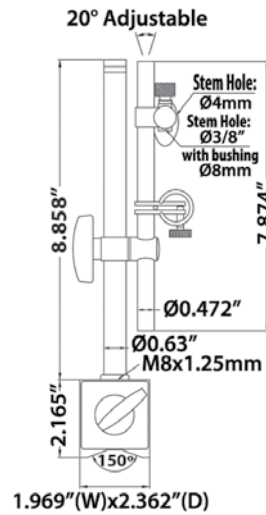
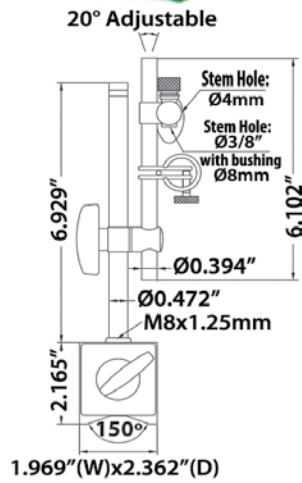
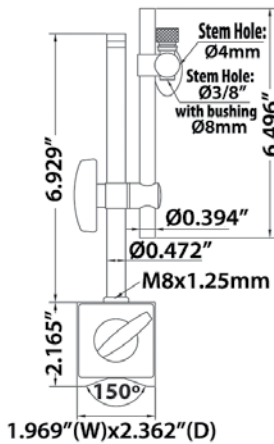

MAGNETIC STANDS

Magnetic Force (lbf/kgf)	Applicable Holding Stem Diameters	Fine Adjustment	INSIZE No.	Code
132/60	3/8", 8mm, 4mm	No	6200-60	816250
132/60	3/8", 8mm, 4mm	Yes	6201-60	816252
176/80	3/8", 8mm, 4mm	Yes	6202-80	282886
220/100	3/8", 8mm, 4mm	Yes	6202-100	816254

Magnetic Base

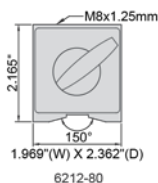

Magnetic Force (lbf/kgf)	INSIZE No.	Code
176/80	6212-80	877380

Universal Magnetic Stands



- For electronic/dial indicators and dial test indicators
- With fine adjustment and dovetail groove

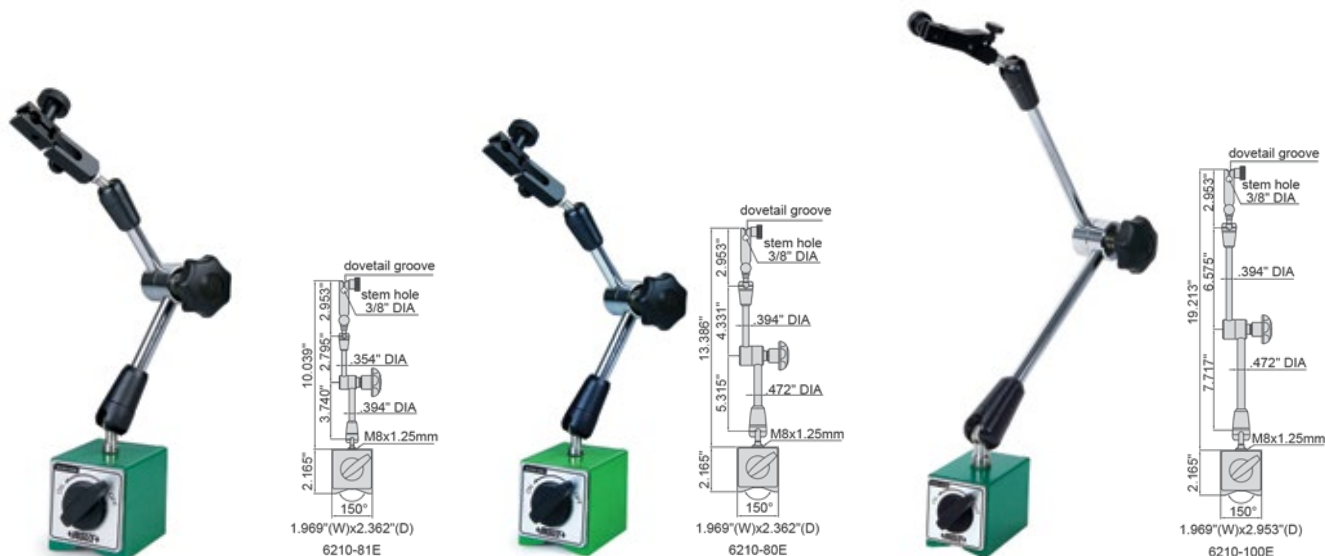

Magnetic Force (lbf/kgf)	Applicable Holding Stem Diameter	Fine Adjustment	INSIZE No.	Code
176/80	3/8"	Yes	6210-81E	877379
176/80	3/8"	Yes	6210-80E	877028
220/100	3/8"	Yes	6210-100E	877378

Light Duty

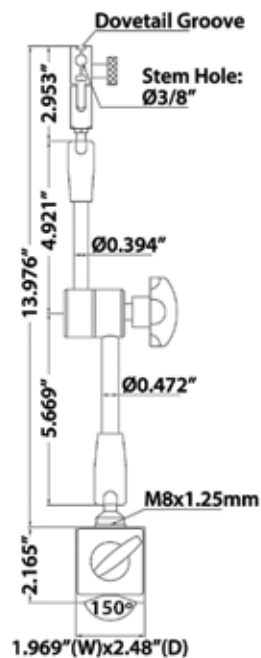

Magnetic Force (lbf/kgf)	Applicable Holding Stem Diameter	Fine Adjustment	INSIZE No.	Code
176/80	3/8"	Yes	6208-80E	816256



Magnetic Stands

For Uneven Surface



- For electronic/dial indicators and dial test indicators
- With fine adjustment

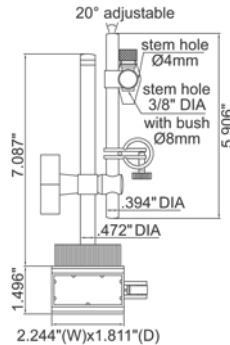

Magnetic Force (lbf)	Applicable Holding Stem Diameter	Fine Adjustment	INSIZE No.	Code
132	Ø3/8", Ø8mm, Ø4mm	Yes	6215-60	282893

Vacuum Stands



- Suitable for granite surface plates or cast iron surface plates
- For electronic/dial indicators and dial test indicators
- With fine adjustment and dovetail groove

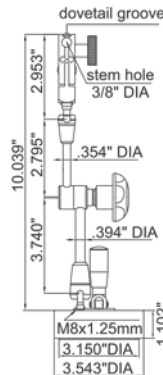

Diameter of vacuum disc (Inch)	Vacuum force (lbf)	Applicable holding stem diameter (Inch)	INSIZE No.	Code
3.15	176	3/8	6217-BE	877190

Miniature Magnetic Stands



- For dial test indicators
- With dovetail groove

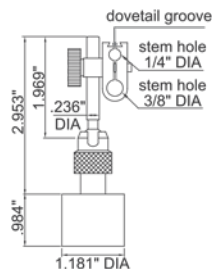

Magnetic force (lbf)	Applicable holding stem diameter (Inch)	INSIZE No.	Code
22	1/4, 3/8	6211-10E	877189

MAGNETIC STANDS

Universal Stands



- For electronic/dial indicators and dial test indicators
- With fine adjustment

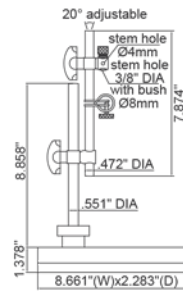

Applicable Holding Stem Diameter	INSIZE No.	Code
Ø3/8", Ø8mm, Ø4mm	6214-A	877381

Magnetic Stands



With Double Fine Adjustments

- For electronic/dial indicators and dial test indicators
- Applicable holding stem: 3/8" DIA
- With two fine adjustments and dovetail groove
- With two fine adjustments on the head and on the base

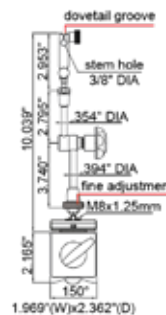

Magnetic force (lbf)	INSIZE No.	Code
176	6272-80E	877382



Magnetic Stand

With Flex Arm

- For dial test indicators

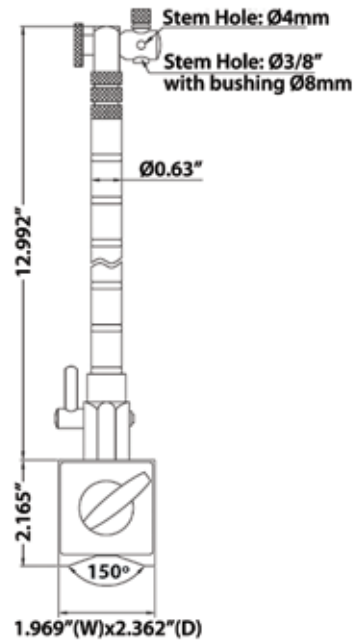

Magnetic Force (lbf/kgf)	Applicable Holding Stem Diameter	INSIZE No.	Code
176/80	3/8", 8mm, 4mm	6207-80A	282892

Miniature Magnetic Stand

- For dial test indicators
- With fine adjustment and dovetail groove

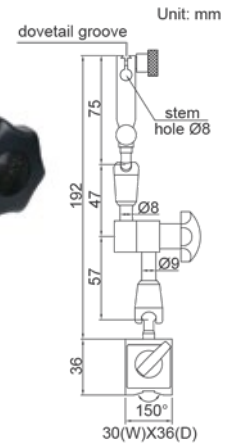
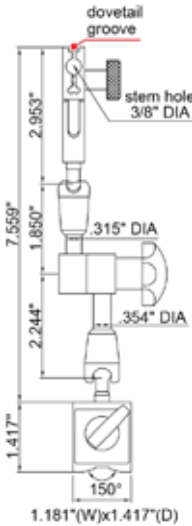

Magnetic Force (lbf/kgf)	Applicable Holding Stem Diameter	Fine Adjustment	INSIZE No.	Code
88/40	3/8"	Yes	6224-40E	816650
88/40	8mm	Yes	6224-40	889325

Electronic Height Gages

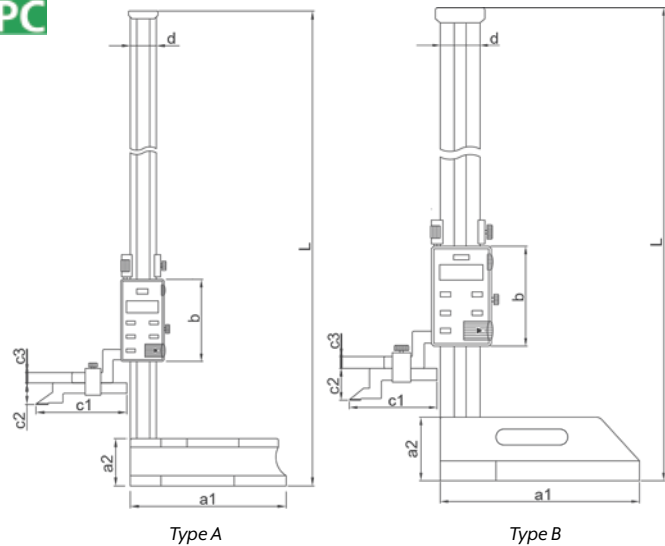

- Resolution: 0.0005"/0.01mm
- Buttons: on/off, zero, inch/mm, ABS/INC (absolute and incremental measurements), data hold, TOL (tolerance measurement), set
- Carbide-tipped scriber, stainless steel beam
- Battery LR44
- Data output
- Supplied with dial test indicator holder
- Supplied with vinyl dust cover

OPTIONAL ACCESSORY: SPC cable 7301-SPC5 (Code 280795)

Range (Inch/mm)	Type	Accuracy (Inch)	L (Inch)	a1 (Inch)	a2 (Inch)	b (Inch)	c1 (Inch)	c2 (Inch)	c3 (Inch)	d (Inch)	e (Inch)	f (Inch)	INSIZE No.	Code
0-12/0-300	A	±0.0020	18.504	5.315	1.772	3.150	2.992	0.984	0.394	0.906	0.236	0.315	1150-300E	280756
0-20/0-500	A	±0.0025	28.346	7.087	2.165	3.740	4.055	0.984	0.472	1.181	0.394	0.472	1150-500E	280757
0-24/0-600	B	±0.0025	32.283	7.087	2.165	3.740	4.055	0.984	0.472	1.181	0.394	0.472	1150-600E	280758
0-40/0-1000	B	±0.0030	50.197	9.843	3.150	4.921	4.331	1.535	0.591	1.969	0.394	0.591	1150-1000E	280759

Sizes available up to 80"

Electronic Height Gages

With Drive Wheel



- Resolution: 0.0005"/0.01mm
- Buttons: on/off, zero, inch/mm, preset +, preset -, hold
- Auto power off - move unit to turn power on
- Carbide-tipped scriber, stainless steel beam
- Battery CR2032
- Data output
- Supplied with vinyl dust cover

OPTIONAL ACCESSORIES: SPC cable, Dial Test Indicator Holder, Clamp

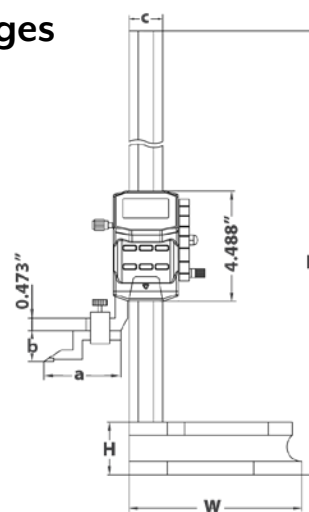

Range (Inch/mm)	Accuracy (Inch)	L (Inch)	W (Inch)	H (Inch)	a (Inch)	b (Inch)	c (Inch)	h (Inch)	INSIZE No.	Code
0-12/0-300	±0.0015	20.276	7.087	2.165	3.150	1.181	1.378	0.354	1156-300	816634
0-24/0-600	±0.0020	32.087	7.087	2.165	3.150	1.181	1.378	0.354	1156-600	816635



Electronic Height Gages

Light Duty

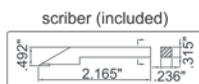
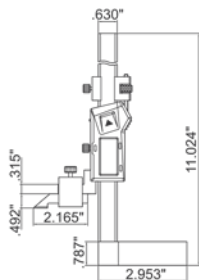

- Resolution: 0.0005"/0.01mm
- Buttons: on/off, zero, inch/mm
- Auto power off - move unit to turn on
- Carbide tipped scriber
- With fine adjustment
- Battery CR2032
- Data output
- Stainless steel
- Supplied in fitted storage case

Range (Inch/mm)	Accuracy (Inch)	INSIZE No.	Code
0-6/0-150	±0.0015	1154-150	877102

Vernier Height Gages

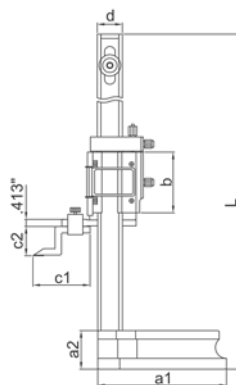
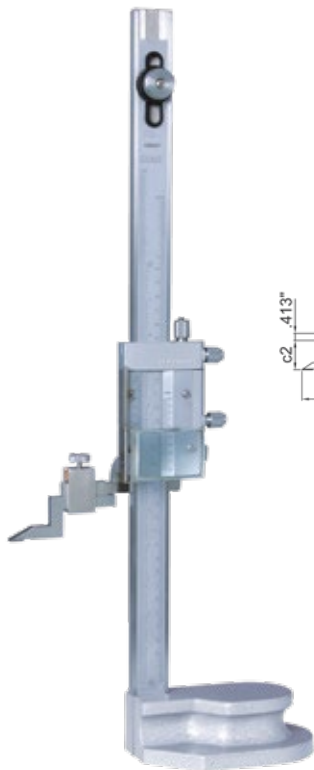

- Graduation: 0.001"/0.02mm
- Adjustable main scale to set zero
- Carbide tipped scriber
- Stainless steel (except base)
- Satin chrome plated scale
- Supplied with magnifier
- With fine adjustment
- Supplied with dust cover

Range (Inch/mm)	Accuracy (Inch)	L (Inch)	a1 (Inch)	a2 (Inch)	b (Inch)	c1 (Inch)	c2 (Inch)	d (Inch)	INSIZE No.	Code
0-12/0-300	±0.0016	21.457	5.315	1.693	2.953	3.150	1.181	1.102	1250-300	280780
0-24/0-600	±0.002	34.252	7.087	2.126	3.346	3.150	1.614	1.378	1250-600	280783

HEIGHT GAGES

Vernier Height Gage



Light Duty

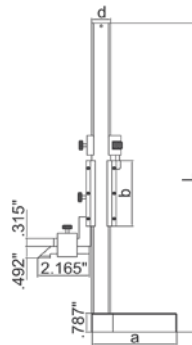

- Graduation: 0.001"/0.02mm
- Carbide tipped scriber
- Stainless steel (except base)
- Satin chrome plated scale
- Supplied in fitted storage case

Range (Inch/mm)	Accuracy (Inch)	L (Inch)	a (Inch)	b (Inch)	d (Inch)	INSIZE No.	Code
0-8/0-200	±0.0012	12.795	3.543	2.756	0.787	1253-200	877126

Digimatic Height Gages



Standard Type

- Resolution: 0.0005"/0.01mm (0.0002"/0.005mm switchable)
- Easy-to-use standard type
- Carbide-tipped scriber is provided
- Double-column structure ensures high measuring accuracy
- Coarse/fine feed switching
- Switchable resolution
- Two preset reference heights

Multi-Function Type with SPC Data Output

- Resolution: 0.0005"/0.01mm (0.0002"/0.005mm switchable)
- Highly versatile multi-function type
- Carbide-tipped long scriber is provided
- Rigid construction ensures repeatable measurement
- Switchable resolution
- Coarse/fine feed switching
- SPC data output
- Two preset reference heights

Bi-directional touch-signal probe is an optional accessory. It can quickly and accurately measure steps, and inside and outside widths.



Standard

Range (Inch/mm)	Accuracy (Inch)	Weight (kg)	Code
0-12/0-300	±001	4.7	192-630-10
0-18/0-450	±002	7.5	192-631-10

Multi-Function

Range (Inch/mm)	Accuracy (Inch)	Weight (kg)	Code
0-12/0-300	±001	5.7	192-670-10
0-18/0-450	±0015	7.5	192-671-10
0-24/0-600	±0015	8.3	192-672-10

Electronic Height Gages



- Resolution: 0.01mm/0.0005"
- Buttons: on/off, zero, mm/inch, data hold, ABS/INC, preset
ABS/INC is for absolute and incremental measurement
- Automatic power off, move the digital unit to turn on power
- Carbide tipped scriber
- Stainless steel
- Battery CR2032, data output
- With driving wheel
- With dial test indicator holder
- Supplied with dust cover

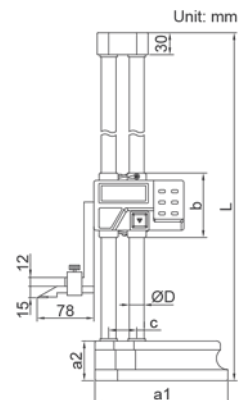

Range (mm/Inch)	Accuracy (mm)	L (mm)	a1 (mm)	a2 (mm)	b (mm)	c (mm)	ØD (Inch)	INSIZE No.	Code
0-300/0-12	±0.04	475	135	43	84	33	15	1151-300	816100
0-600/0-24	±0.05	810	180	54	88	38	20	1151-600	816104

Scribers for Height Gages



- Carbide tipped

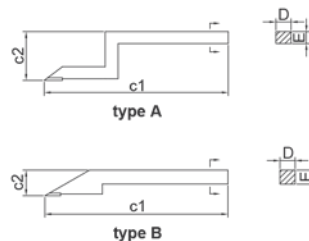

For height gages...	Type	c1 (mm)	c2 (mm)	D (mm)	E (mm)	INSIZE No.	Code
1150-300	A	76	25	6	8	7150-SC1	280786
1150-500, 1150-600	A	103	25	10	12	7150-SC2	280787
1150-1000, 1150-1500, 1150-2000	A	110	39	10	15	7150-SC3	280788
1351-300, 1351-450, 1351-600	B	78	15	9	9	7150-SC4	280789
1250-300, 1156-300, 1156-600	A	80	30	9	9	7150-SC6	280791
1250-450, 1250-600	A	80	41	9	9	7150-SC7	280792
1253-150, 1253-200, 1154-150	B	55	12.5	6	8	7150-SC9	877408

HEIGHT GAGES



816192

- Indicator graduation: 0.0005"
- Indicator range: 0.25"
- Supplied in fitted storage case

OPTIONAL ACCESSORIES:

Setting ring
Long handle

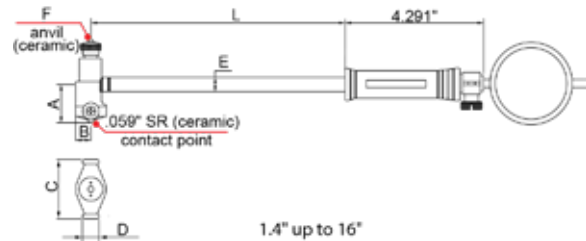
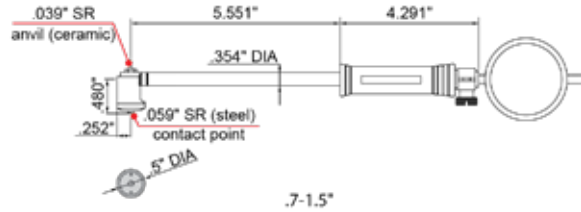
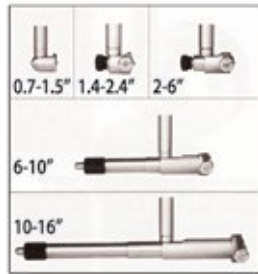

Range (Inch)	Accuracy (Inch)	Repeatability (Inch)	L (Inch)	A (Inch)	B (Inch)	C (Inch)	ØD (Inch)	E (Inch)	F (Inch)	INSIZE No.	Code
0.7-1.5	±0.00075	0.00015	5.551	0.480	0.252	0.480	0.252	0.354	0.039	2323-15	282930
1.4-2.4	±0.00090	0.00015	5.551	0.866	0.354	1.063	0.512	0.504	0.079	2323-24	816188
2-6	±0.00090	0.00015	5.551	1.024	0.354	1.378	0.512	0.504	0.079	2323-6	816192
6-10	±0.00090	0.00015	9.488	2.224	0.512	2.933	0.591	0.571	0.079	2323-10	816184
10-16	±0.00090	0.00015	9.488	3.406	0.591	3.996	0.591	0.571	0.098	2323-16	816186



282928

- Indicator graduation: 0.0005"
- Indicator range: 0.25"
- Supplied in fitted storage case

OPTIONAL ACCESSORY: Setting ring



For Small Holes

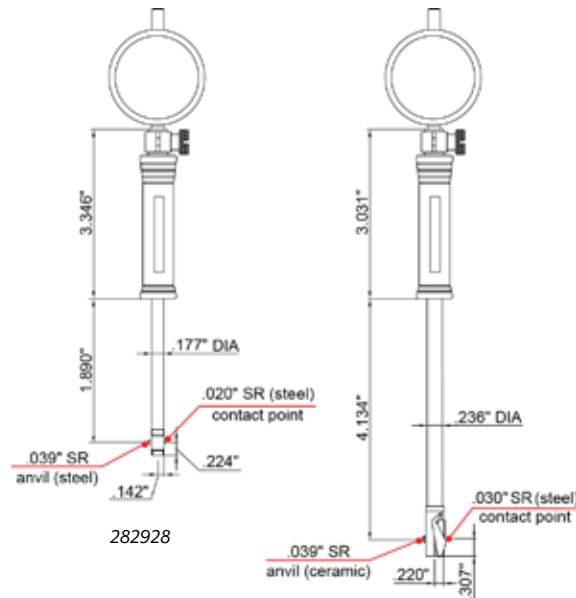

Range (Inch)	Accuracy (Inch)	Repeatability (Inch)	INSIZE No.	Code
0.24-0.4	±0.00075	0.00015	2323-04	282928
0.4-0.7	±0.00075	0.00015	2323-07	282929

Bore Gage Sets



- Supplied in fitted storage case



877159

877160

Range (Inch)	Accuracy (Inch)	Repeatability (Inch)	Indicator	Bore Gages Included	INSIZE No.	Code
1.4-6	1.4-2 ±0.0009 2-6 ±0.0009	0.00015	Dial Indicator range 0.25" Graduation 0.0005"	1.4-2" (indicator and handle not included) 2-6"	2824-S2E	877159
0.7-6	0.7-1.5 ±0.00075 1.4-2.4 ±0.0009 2-6 ±0.0009	0.00015	Dial Indicator range 0.25" Graduation 0.0005"	0.7-1.5 1.4-2.4 (Indicator not included) 2-6 (Indicator not included)	2824-S3E	877160

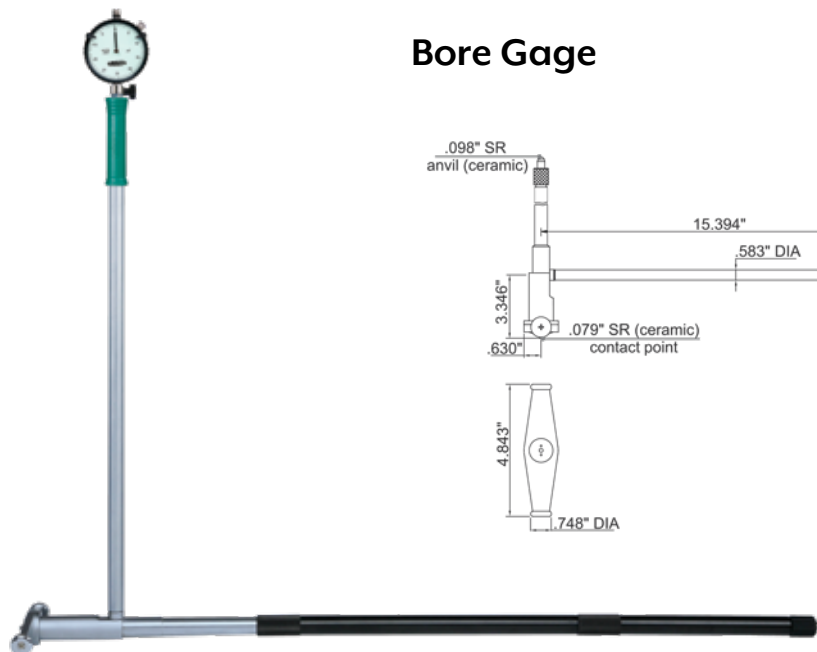

Bore Gage



BORE GAGES

Range (Inch)	Accuracy (Inch)	Repeatability (Inch)	Indicator	INSIZE No.	Code
16-32	±0.001	0.00015	Dial Indicator, range 0.25", graduation 0.0005"	2828-32	877161

Bore Gage Setter

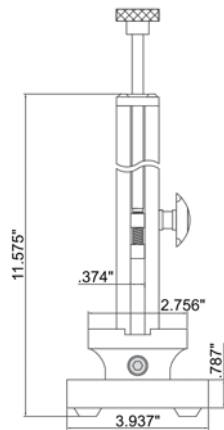

- Vertical and horizontal use
- To be used with gage blocks

Range (Inch)	Repeatability (Inch)	Gage Block Set	INSIZE No.	Code
0-6	0.00005	With	7353-6	877262
0-6	0.00005	Without	7353-160W	877213

Blocks per Set	Size (Inch)	Step (Inch)	Quantity (pcs)	Remark
36	0.05		1	
	0.1001-0.1009		9	
	0.101-0.109	0.0001	9	
	0.11-0.19	0.001	9	Grade AS-2 (ASME B89.1.9)
	0.1-0.5	0.01	5	
	1	0.1	1	
	2		1	
	4		1	

Long Handle



- To assist deep hole measurement



Applicable bore gages	A (mm)	ØD (mm)	INSIZE No.	Code
35-60mm				
50-100mm	475	13	7351-EX11	877423
50-160mm				
100-160mm				

Electronic Thickness Gage

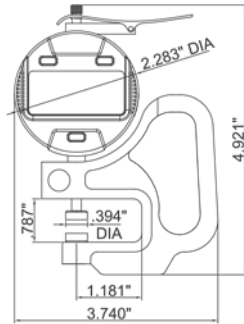

- Ceramix spindle tip and anvil
- Buttons: on/off, zero, inch/mm
- Battery CR2032
- Auto power off
- Data output

Range (Inch/mm)	Resolution (Inch/mm)	Accuracy (Inch)	INSIZE No.	Code
0-0.4/0-10	0.0005/0.01	±0.0008	2871-10	877162
0-0.4/0-10	0.00005/0.001	±0.0002	2871-101	877163

Thickness Gage

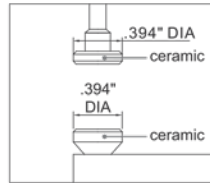
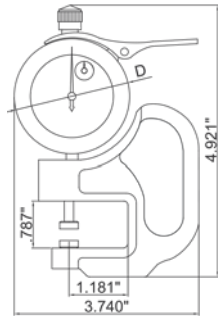

Range (Inch)	Graduation (Inch)	Accuracy (Inch)	INSIZE No.	Code
0-0.5	0.0005	±0.0008	2364-055	876312

Electronic Thickness Gage



- Ceramix spindle tip and anvil
- Buttons: on/off, zero, inch/mm
- Battery CR2032
- Auto power off
- Data output

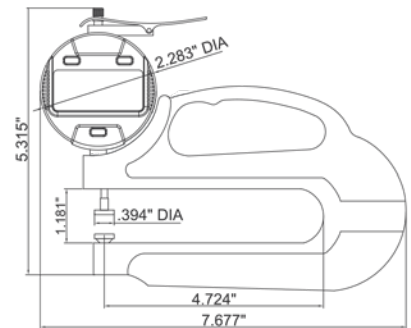

Range (Inch/mm)	Resolution (Inch/mm)	Accuracy (Inch)	INSIZE No.	Code
0-0.4/0-10	0.0005/0.01	±0.0008	2872-10	877164

THICKNESS GAGES

Ultrasonic Thickness Gage



- Measures the thickness from one side of object
- Suitable for pipes, tanks, etc.
- Supplied with transducer, bottle of couplant and 2 x AAA batteries
- Supplied with manufacturer inspection certificate
- Supplied in fitted storage case



Measuring Range (Inch)		0.03 - 11.81	
Resolution (Inch)		0.001 (range <10") 0.01 (range ≥10")	
Accuracy (Inch)		±0.002 (range <0.4") ±(0.002+H/1000) (range 0.4-4") ±H/333 (range ≥4") H is the thickness to be measured in inch	
Transducer	Frequency	5MHz	
	Diameter	0.43"	
Minimum size of pipe for measurement (Inch)		0.79 x 0.05 (diameter x wall thickness)	
Applicable Temperature		<140°F	
Velocity		0.039-0.394"/μs	
Power Supply		2 x AAA batteries (included)	
Dimensions (Inch)		4.49 x 2.52 x 1.1	
Weight (lbs)		49	
INSIZE No.		ISU-100D	
Code		816694	

Coating Thickness Gage



- Magnetic induction probe (Fe) is to measure the thickness of non-magnetic coating on magnetic substrate
Substrate: iron, steel, magnetic stainless steel (does not include non-magnetic stainless steel)
Coating: zinc, copper, chrome, tin, plastic, powder, paint (nickel is not included)
- Eddy current probe (NFe) is to measure the thickness of non-conductive coating on non-magnetic substrate
Substrate: copper, aluminum, zinc, non-magnetic stainless steel
Coating: plastic, powder, paint, anodizing
- Low and high limits with judgement
- Auto power off
- For magnetic and non-magnetic substrates
- Data output

INCLUDES ONE OF EACH: Coating thickness gage, Magnetic induction probe (Fe), Zero calibration block for Fe probe, Calibration foils (50μm/2mils, 100μm/4mils, 250μm/10mils, 500μm/20mils, 1000μ/40mils), 1.5V AA battery, USB cable and software

Probe type	Fe (included) Magnetic induction probe	NFe (optional) Eddy current probe	Fe90 (optional) Magnetic induction probe for bores and grooves	Fe10 (optional) Magnetic induction probe with big range
Measuring range	0-50mils	0-50mils	0-50mils	20-400mils
Accuracy	±(3%L+0.04)mils ±(3%L+0.4)mils	(range≤50mils) (range≤50mils)	L is measuring thickness in mils	
Resolution	0.01mils			0.1mils
Measuring mode	Continuous and single			
Minimum substrate thickness	0.02"	0.012"	0.02"	0.08"
Minimum measuring area	Ø0.28"	Ø0.2"	Ø0.28"	Ø1.57"
Minimum curvature radius of convex workpiece	0.06"	0.12"	-	0.4"
Memory	500			
Power supply	2 x 1.5V AA batteries			
Dimension	5.04" x 2.68" x 1.26"			
Weight	0.75lbs			
INSIZE No.	9501-1200			
Code	877217			



Gage Block Set

Steel



- Alloy steel
- Meets ASME B89.1.9 standards
- Supplied with inspection certificate
- Supplied in fitted storage case

No. of Blocks	Blocks Included...			Grade 0		Grade AS-2	
	Size (Inch)	Step (Inch)	Quantity	INSIZE No.	Code	INSIZE No.	Code
36	0.05		1	4102-36	283257	4102-236	283259
	0.1001-0.1009	0.0001	9				
	0.101-0.109	0.001	9				
	0.11-0.19	0.01	9				
	0.1-0.5	0.1	5				
	1		1				
81	2		1	4102-81	283260	4102-281	283262
	4		1				
	0.1001-0.1009	0.0001	9				
	0.101-0.149	0.001	49				
	0.05-0.95	0.05	19				
	1-4	1	4				

Gage Block Sets

Inch & Metric – Steel & Carbide



- Grade 2 (A+) and Grade 3 (A and B) accuracy meets or exceeds federal specifications GGG-G-15C
- Grade B shop accuracy approximately ± 0.00005 "
- CARBIDE SET: Tungsten carbide blocks in all sizes through 1" for superior wear life
- Standard steel blocks in 2", 3" and 4"

Inch

No. of Blocks per Set	Block Combination	Material	Grade	Code
81	9 blocks - 0.1001-0.1009 (0.0001 step); 49 blocks - 0.101-0.159 (0.001 step); 19 blocks 0.050-0.950 (0.050 step); 4 blocks 1.000-4.000 (1.000 step)	Steel	2	845112
81	9 blocks - 0.1001-0.1009 (0.0001 step); 49 blocks - 0.101-0.159 (0.001 step); 19 blocks 0.050-0.950 (0.050 step); 4 blocks 1.000-4.000 (1.000 step)	Steel	3	845113
81	9 blocks - 0.1001-0.1009 (0.0001 step); 49 blocks - 0.101-0.159 (0.001 step); 19 blocks 0.050-0.950 (0.050 step); 4 blocks 1.000-4.000 (1.000 step)	Steel	B	845115
81	9 blocks - 0.1001-0.1009 (0.0001 step); 49 blocks - 0.101-0.159 (0.001 step); 19 blocks 0.050-0.950 (0.050 step); 4 blocks 1.000-4.000 (1.000 step)	Carbide	B	845121
36	9 blocks - 0.1001-0.1009 (0.0001 step); 9 blocks - 0.101-0.109 (0.001 step); 9 blocks - 0.110-0.190 (0.010 step); 4 blocks - 0.200, 0.300, 0.400, 0.500; 3 blocks - 1.000, 2.000, 4.000; 2 blocks - 0.50, 0.100	Steel	2	845122
36	9 blocks - 0.1001-0.1009 (0.0001 step); 9 blocks - 0.101-0.109 (0.001 step); 9 blocks - 0.110-0.190 (0.010 step); 4 blocks - 0.200, 0.300, 0.400, 0.500; 3 blocks - 1.000, 2.000, 4.000; 2 blocks - 0.50, 0.100	Steel	3	845123
36	9 blocks - 0.1001-0.1009 (0.0001 step); 9 blocks - 0.101-0.109 (0.001 step); 9 blocks - 0.110-0.190 (0.010 step); 4 blocks - 0.200, 0.300, 0.400, 0.500; 3 blocks - 1.000, 2.000, 4.000; 2 blocks - 0.50, 0.100	Steel	B	845125

Metric

No. of Blocks per Set	Block Combination	Grade	Code
87	9 blocks - 1.001-1.009 (0.001 step); 49 blocks - 1.01-1.49 (0.01 step); 19 blocks 0.5-9.5 (0.5 step); 10 blocks - 10-100 (10.0 step)	1	845131
47	1 block - 1.005; 9 blocks 1.01-1.09 (0.01 step); 9 blocks - 1.5-1.9 (0.1 step); 24 blocks 1-24 (1.0 step); 4 blocks - 25-100 (25.0 step)	2	845139

Gage Block Set

Steel



- Alloy steel
- Meets ASME B89.1.9 standards
- Supplied with inspection certificate
- Supplied in fitted storage case



No. of Blocks	Blocks Included...			Grade AS-1	
	Size (Inch)	Step (Inch)	Quantity	INSIZE No.	Code
36	0.05		1	4102-136	283258
	0.1001-0.1009	0.0001	9		
	0.101-0.109	0.001	9		
	0.11-0.19	0.01	9		
	0.1-0.5	0.1	5		
	1		1		
81	2		1	4102-181	283261
	4		1		
	0.1001-0.1009	0.0001	9		
	0.101-0.149	0.001	49		
	0.05-0.95	0.05	19		
	1-4	1	4		

Gage Block Holders

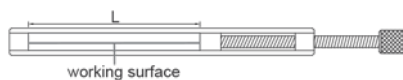

L Clamping Range (mm)	INSIZE No.	Code
0-25	6881-A1	877399
25-50	6881-A2	877400
50-100	6881-A3	877401
100-200	6881-A4	877402
200-300	6881-A5	877403
300-500	6881-A6	877404



Applicable gage block size (mm)	INSIZE No.	Code
1.5-5	6883-1	877405
5-10	6883-2	877406

Block Levels



- V-groove on bottom for shafts (shaft diameter 0.63 to 2.76")
- With transverse vial
- Supplied with adjusting wrench

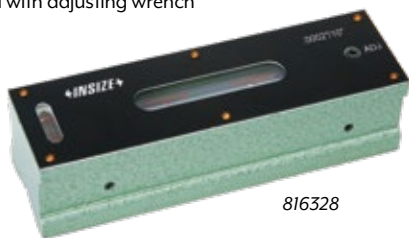

816328

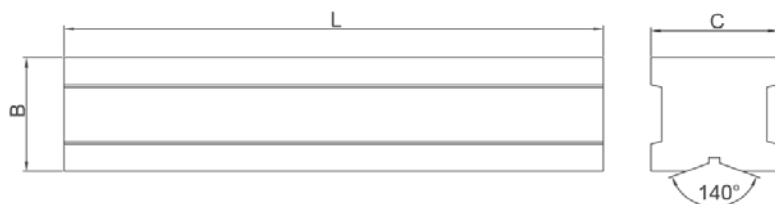

L (Inch)	Sensitivity (Inch/ft)	INSIZE No.	Code
6	0.00024 (=0.001°)	4901-6	816326
8	0.00024 (=0.001°)	4901-8	816328
12	0.00024 (=0.001°)	4901-12	816330

Cast Aluminum Level



- 10 inch with magnetic base
- ±0.006"/ft accuracy
- Shockproof horizontal and vertical vials
- Working temperature: 5°F-131°F
- Cast aluminum body
- Vials made in Israel – Lifetime warranty

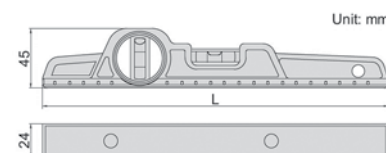

Length (Inch/mm)	INSIZE No.	Code
10/250	4913-250	877182

Portable Level

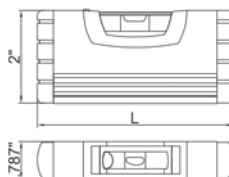

- Shockproof vials
- Magnetic base
- Shock absorbing rubber end caps
- Working temperature: 5°F-131°F
- Vials made in Israel – Lifetime warranty

L Length (Inch)	Accuracy	INSIZE No.	Code
4	0.006in/ft	4912-100	877180

Aluminum Levels



- Shockproof horizontal and vertical vials
- Magnetic base
- Shock absorbing rubber end caps
- Working temperature: 5°F-131°F
- Vials made in Israel – Lifetime warranty



L Length (Inch)	Accuracy	INSIZE No.	Code
12	0.006in/ft	4914-300	877369
24	0.006in/ft	4914-600	877185
32	0.006in/ft	4914-800	877186
40	0.006in/ft	4914-1000	877183
48	0.006in/ft	4914-1200	877184
80	0.006in/ft	4914-2000	877368

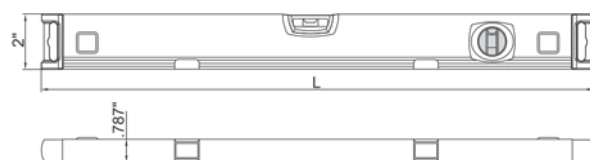

Electronic Level & Protractor

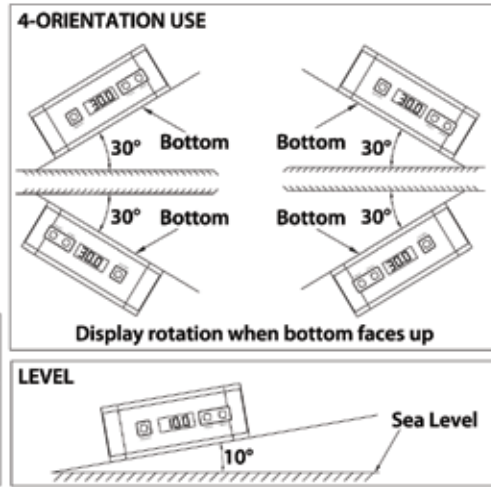
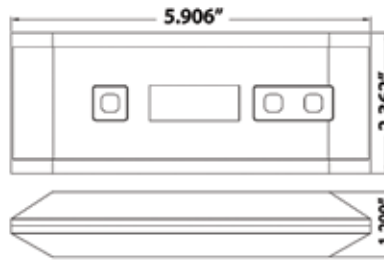

- Resolution: 0.1° (=0.021 in/ft)
- Accuracy: At 0° and 90°: ±0.1°; others: ±0.2°
- Used as level and protractor
- Aluminum frame
- Magnetic bottom with v-groove for shafts
- Zero setting may be used at any angle on plain surfaces
- Buttons: on/off, zero, hold
- Display rotates when gage is upside down
- Battery CR2032
- Auto power off
- Supplied in leather pouch

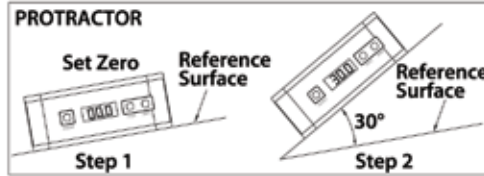

Range	INSIZE No.	Code
0-360° (4 x 90°)	2173-360	816340

Electronic Level & Protractor



- IP54 dust/coolant proof
- Aluminum frame
- Magnetic bottom with V-groove for shafts
- Sea level is permanently set inside the chip, zero setting is not needed when batteries are replaced
- Buttons: ON/OFF, absolute and incremental measurement, keep the reading, buzzer alarm (at 0° and 90°), unit (in/ft, %, mm/m), backlight
- Two AAA batteries
- Auto power off
- Absolute level

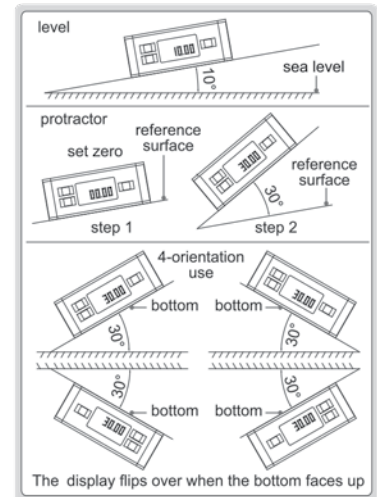
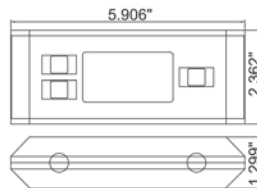

Range	Resolution	Accuracy	INSIZE No.	Code
0-360° (90° x 4)	0.05°/0.125in/ft	at 0° and 90°: ±0.1°; others: ±0.2°	2179-360	877108

Electronic Level & Protractor

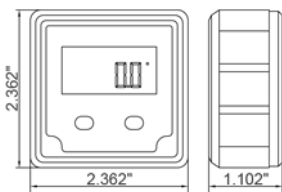

- Resolution: 0.1° (=0.021 in/ft)
- Accuracy: At 0° and 90°: ±0.1°; others: ±0.2°
- Used as level and protractor
- Aluminum frame
- Magnetic bottom
- Display rotates when gage is upside down
- Backlight on automatically when in use - auto off 15 minutes after use
- Sea level is permanently set inside the chip - zero setting not required when battery is replaced
- Buttons: on/off, zero, absolute and incremental measurement
- Battery: 1 x AAA
- Auto power off
- Absolute level

Range	INSIZE No.	Code
4 x 90°	2170-1	816396

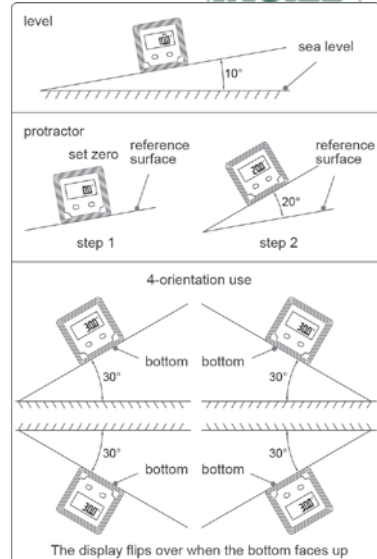

Electronic Protractor

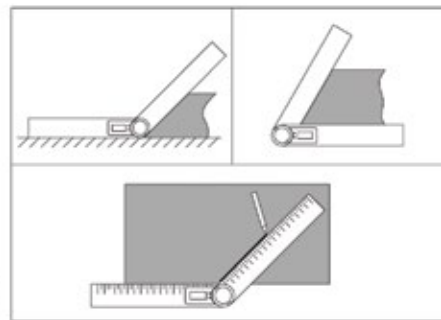
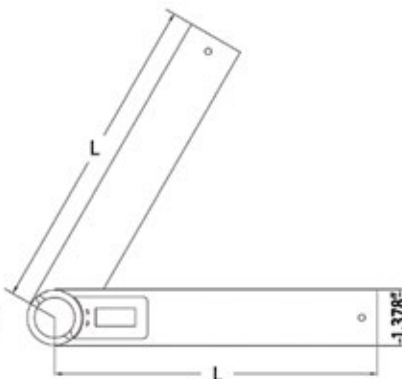
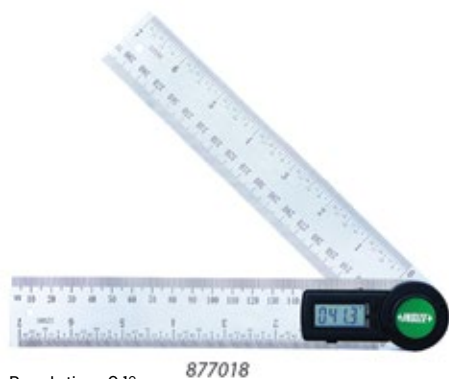

- Resolution: 0.1°
- Accuracy: ±0.3°
- Buttons: on/off, zero
- With locking screw
- Graduation of blade: 1/32" and 1mm
- Stainless steel
- Battery CR2032
- Auto power off

L (Inch)	Range	INSIZE No.	Code
8	0-360°	2176-200	877018
12	0-360°	2176-300	877107

Electronic Protractor



- Display in degrees and degrees/minutes/seconds
- Resolution: 10"/0.005"
- Accuracy: ±5'
- Buttons: SET - preset the reading, change measuring direction; MODE - choose 0-90°, 0-180°, or 0-360° display; ZERO/ON/OFF - zero and power on/off
- Stainless steel
- Battery CR2032
- Data output
- Auto power off
- Two blades: 6" and 12"
- Supplied with square to set 90°
- Supplied in storage case

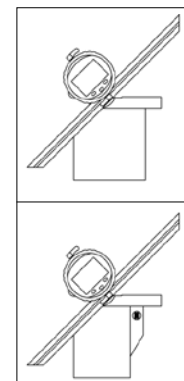
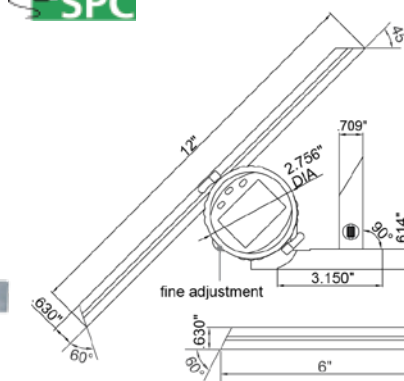
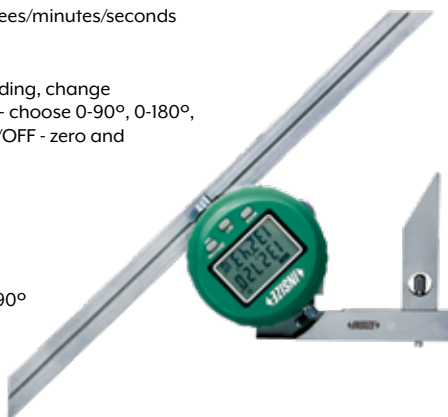

OPTIONAL ACCESSORIES:
SPC cable, Clamp 284912 (2372-CLAMP) for Height Gages – INSIZE series 1156, 1250 and 1351

Range	INSIZE No.	Code
0-360°	2172-360A	283343

Protractor



- Graduations: 1°
- Accuracy: ±0.5°
- Stainless steel with satin chrome plated scale
- With locking screw
- Supplied in storage case

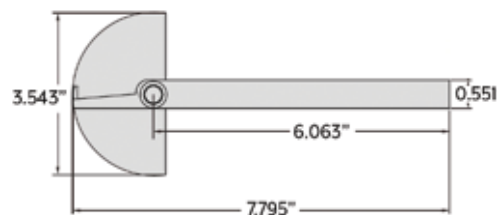

Range	INSIZE No.	Code
0-180°	4780-85A	283328

Protractor



- Graduations: 1°
- Accuracy: ±0.3°
- Stainless steel with satin chrome plated scale
- With locking screw
- Supplied in storage case

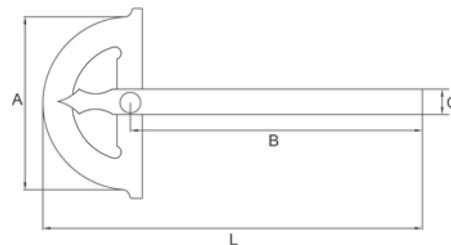

Range	L (Inch)	A (Inch)	B (Inch)	C (Inch)	INSIZE No.	Code
0-180°	8.661	4.7	5.9	0.551	4799-1120	283330

Universal Protractor



- Graduation: 5'
- Accuracy: ±5'
- Parallax-free reading
- Two blades: 6" and 12"
- Stainless steel
- Supplied in fitted storage case

OPTIONAL ACCESSORY:
Clamp 284912 (2372-CLAMP)
for Height Gages – INSIZE series
1156, 1250 and 1351

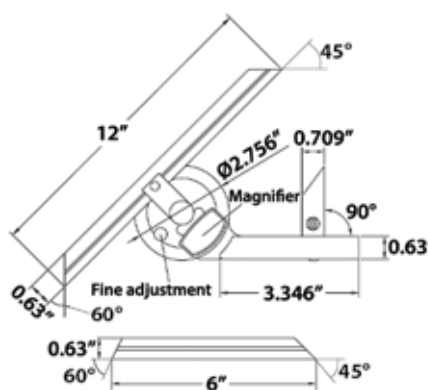

Clamp for Height Gages
sold separately

Protractor

Clamp for Height Gage

Range	INSIZE No.	Code	INSIZE No.	Code
0-360°	2372-360	283341	2372-CLAMP	284912

Dial Protractor



- Graduation: 5'
- Accuracy: ±5'
- Two blades: 6" and 12"
- Stainless steel
- Supplied in fitted storage case

OPTIONAL ACCESSORY:
Clamp 284912 (2372-CLAMP)
for Height Gages – INSIZE series
1156, 1250 and 1351

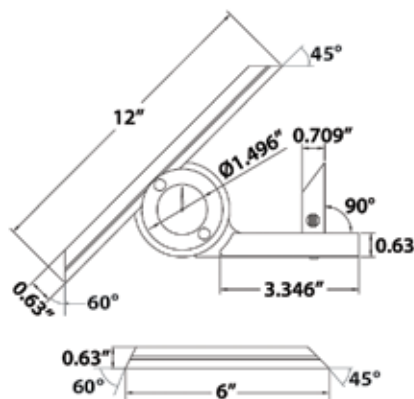

Clamp for Height Gages
sold separately

Protractor

Clamp for Height Gage

Range	INSIZE No.	Code	INSIZE No.	Code
0-360°	2373-360	283342	2372-CLAMP	284912

Electronic Protractor

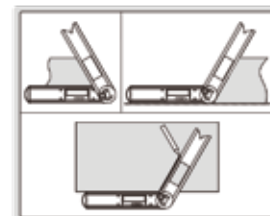
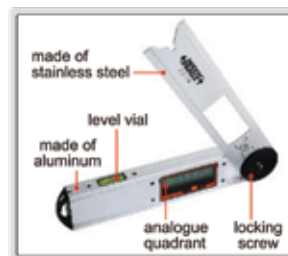
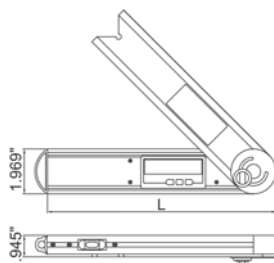

- Buttons: on/off, hold (keep the reading), zero, ABS (absolute and incremental measurement)
- Fix the locking screw for 4 positions for different measuring ranges: 0°-225°, -225°-0°, -45°-180°, -180°-45°
- Remove the locking screw for 360° range
- With level vial
- Battery CR2032
- Auto power off

Range	Size (L) (Inch)	Resolution	Accuracy	INSIZE No.	Code
0-360°	10	0.05°	±0.15°	2171-250	877106

Electronic Protractor



Coolant Proof (Heavy Duty)



IP54

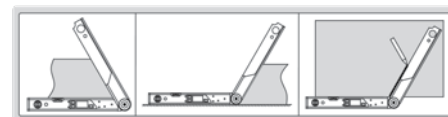
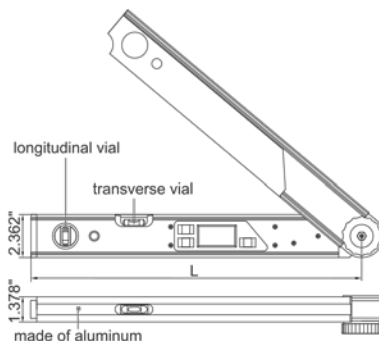

- Suitable for setting horizontal and vertical mitre angles of cutting machine
- Buttons: ON/OFF, HOLD/SUP, SPR/CNR/MTR/BVL
- IP54 dust/coolant proof
- With transverse and longitudinal vials
- 2xAAA batteries
- Automatic backlight
- Absolute level, zero setting is not needed when batteries are replaced
- Backlight turns off in one minute after no data changing, automatic power off in 5 minutes

Range	Size (L) (Inch)	Resolution	Accuracy	INSIZE No.	Code
0-225°	18.11	0.05°	±0.1°	2174-225	877153

Protractor

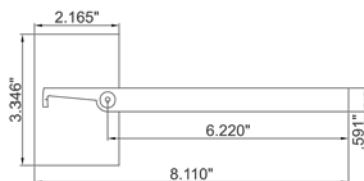

- Stainless steel
- Satin chrome plated scale
- With locking screw

Range	Graduation	Accuracy	INSIZE No.	Code
0-180°	1°	±0.3°	4781-85	877168

Protractor

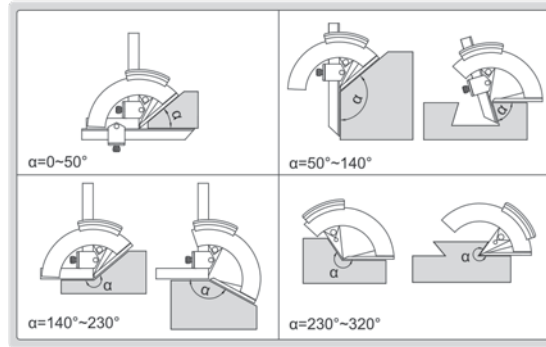
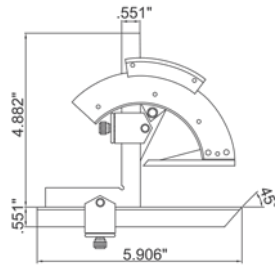

- Stainless steel
- Satin chrome plated scale

Range	Graduation	Accuracy	INSIZE No.	Code
0-320°	2'	±2'	2374-320	283340

Protractor



- Graduation: 1°
- Made of carbon steel
- Satin chrome plated
- With clamping screw
- Blade is moveable

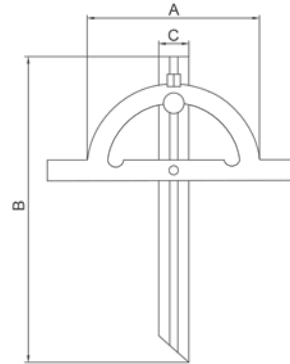

Size (A x B) (mm)	Range	Accuracy	C (mm)	INSIZE No.	Code
100 x 150	10-170°	±0.3°	18	4797-100	283334

Electronic Level and Slope Meter



- IP67 dust/waterproof
- Used as level and slope meter
- Aluminum frame, shock absorbing rubber end caps
- Magnetic bottom with V-groove for shafts
- The sea level is permanently set inside the chip, zero setting is not needed when batteries are replaced
- Buttons: ON/OFF, backlight/buzzer alarm, absolute and incremental measurement, unit (°, %, mm/m), HOLD (keep the reading)
- Three AAA batteries
- Automatic power off

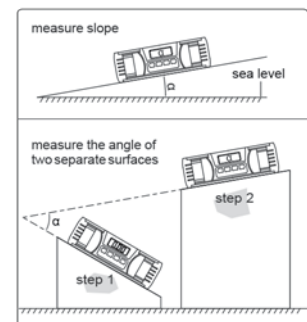
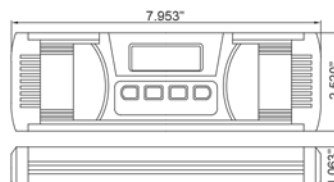

Range	Resolution	Accuracy	INSIZE No.	Code
0 - 360°(90° x 4)	0.05° (=0.00625in/ft)	at 0°: ±0.05°; at others: ±0.1°	2175-360	877293



Rules

Steel – Semi-Flexible

- Graduations: 1/64", 1/32", 1/16", 0.5mm and 1mm
- Semi-flexible
- Stainless steel with non-glare surface
- Supplied in storage pouch



RULES & STRAIGHT EDGES

Range (Inch/mm)	Accuracy (Inch)	Length (Inch)	Width (Inch)	Thickness (Inch)	Graduation	INSIZE No.	Code
6/150	±0.006	6.693	0.709	0.039	Graduation on front and back	7110-150	283596
8/200	±0.006	8.661	0.709	0.039	Graduation on front and back	7110-200	283597
12/300	±0.006	12.992	0.984	0.039	Graduation on front and back	7110-300	283598
12/300	±0.006	12.795	1.181	0.039	Graduation on front and back	7110-3001	816384
20/500	±0.006	20.866	1.181	0.047	Graduation on front and back	7110-500	283599
24/600	±0.008	24.803	1.181	0.047	Graduation on front and back	7110-600	283600
40/1000	±0.008	40.945	1.260	0.059	Graduation on front and back	7110-1000	283601
48/1200	±0.009	48.819	1.378	0.071	Graduation on front	7110-1200	283603
60/1500	±0.010	61.024	1.496	0.071	Graduation on front	7110-1500	283604
80/2000	±0.012	81.299	1.575	0.079	Graduation on front	7110-2000	283605

Rules

Rigid

- Groove on back suitable for combination square sets (INSIZE series 2278)
- Satin chrome plated
- Supplied in storage pouch



Groove on back

Range (Inch/mm)	Accuracy (Inch)	Length (Inch/mm)	Width (Inch)	Thickness (Inch)	Groove (Inch)	Graduation	INSIZE No.	Code
12/300	±0.006	12/300	0.984	0.087	0.079	1/32" and 0.5mm (front) 1/64" and 1mm (back)	7113-300A	283606

Rules

Steel – Rigid & Flexible



Dimensions (Inch)	Style	Graduations	Code
6 x 3/4 x 0.03	3R – Rigid	32nds, 64ths, 10ths, 50ths	820370
6 x 3/4 x 0.03	4R – Rigid	8ths, 16ths, 32nds, 64ths	820371
6 x 3/4 x 0.03	Inch/Metric – Rigid	32nds, 64ths, 1mm, 0.5mm	820372
12 x 1-1/8 x 0.04	4R – Rigid	8ths, 16ths, 32nds, 64ths	820376
18 x 1-1/8 x 0.04	4R – Rigid	8ths, 16ths, 32nds, 64ths	820378
18 x 3/4 x 0.02	4R – Flexible	8ths, 16ths, 32nds, 64ths	820358

Rules

Rigid



Front

Back

Dimensions (Inch)	Accuracy	Width x Thickness (Inch)	Graduations	INSIZE No.	Code
6	±0.003	0.748 x 0.39	1/64" and 1/32" on front, 1/8" on back	7126-6	877203
12	±0.004	0.984 x 0.039	1/64" and 1/32" on front, 1/8" on back	7126-12	877201
24	±0.006	1.102 x 0.047	1/64" and 1/32" on front, 1/8" on back	7126-24	877202

Combination Squares

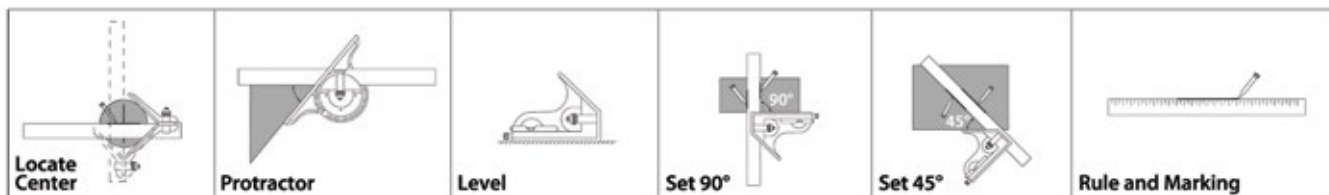
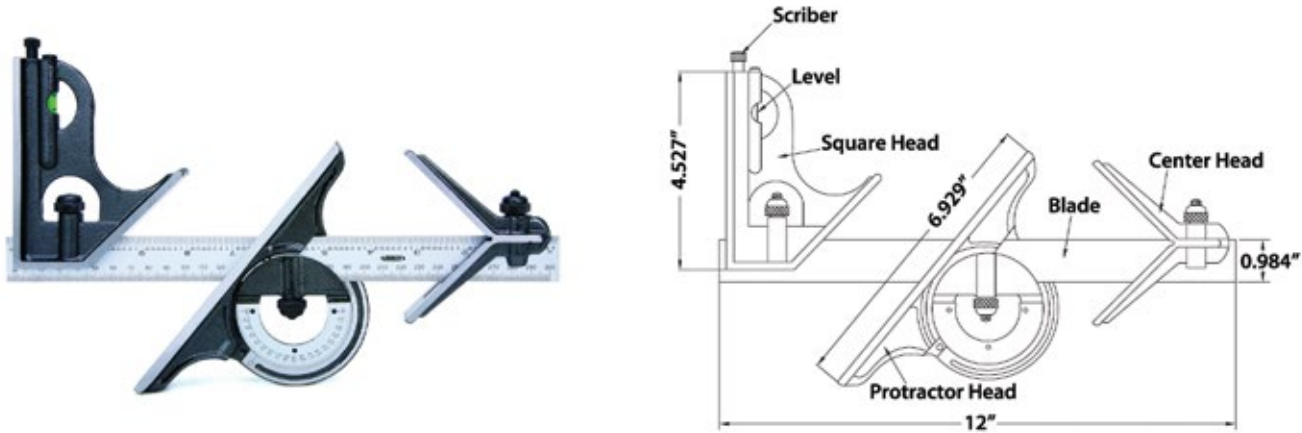

- Used as square, level, marking gage, scribe, center gage, protractor and 12" steel rule
- Center Head: to locate center of round workpieces - Accuracy: $\pm 0.006"$
- Protractor Head: to set the blade at desired angle to an edge of a workpiece, and may be used to measure angles - Range: 0-180 °; Accuracy: ± 7 min.
- Square Head: to set the blade at 90° or 45° to an edge of a workpiece - Accuracy: ± 8 min. for 90° square and ± 10 min. for 45° square
- Supplied in fitted storage case

OPTIONAL ACCESSORY:
Rigid Rule 283606 (7113-300A)

Blade Length	Blade Graduation	Description	INSIZE No.	Code
12"	1/8" and 1/16" on one side, 1/32" and 1/64" on reverse side	2-pcs: rule & square head	2278-2E	877154
12"	1/8" and 1/16" on one side, 1/32" and 1/64" on reverse side	3-pcs: rule, square & center head	2278-3E	877155
12"/300mm	1/32" and 0.5mm on one side, 1/64" and 1mm on reverse side	4-pcs: rule, square, center & protractor head	2278-180	816324
12"	1/8" and 1/16" on one side, 1/32" and 1/64" on reverse side	4-pcs: rule, square, center & protractor head	2278-180E	283344

Double Square



- Accuracy: ± 2 min for 90° square
- Hardened and chrome plated blade

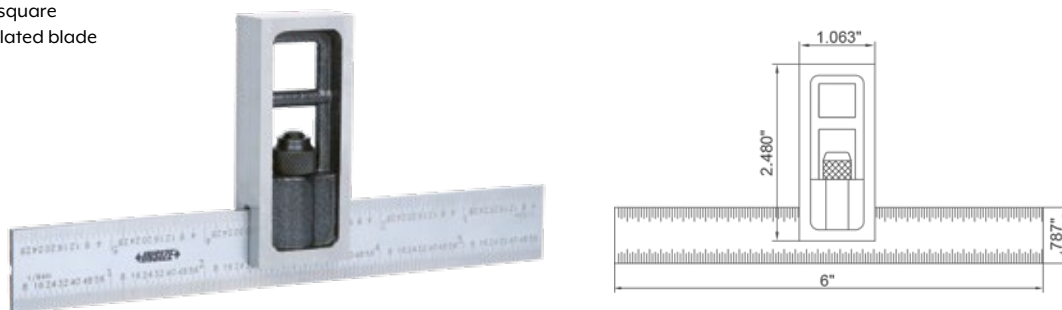

Blade Length	Blade Graduation	INSIZE No.	Code
6"	1/8", 1/16", 1/32", 1/64"	2277-2	283348

Flat Edge Squares



90°

- Meets DIN875 standards, grade 0
- Hardened stainless steel
- Supplied in fitted storage case



SQUARES

L x W Dimensions (Inch)	A Inside Squareness (Inch)	B Outside Squareness (Inch)	C (Inch)	D (Inch)	H (Inch)	INSIZE No.	Code
2.0 x 1.6	0.000236	0.000236	0.591	0.591	0.157	4791-50	816312
3.0 x 2.0	0.000236	0.000276	0.591	0.591	0.157	4791-75	816314
3.9 x 2.8	0.000276	0.000276	0.787	0.787	0.197	4791-100	816316
5.9 x 3.9	0.000276	0.000315	1.181	1.181	0.236	4791-150	816318
7.9 x 5.1	0.000315	0.000354	1.181	1.181	0.276	4791-200	816320
9.8 x 6.5	0.000354	0.000394	1.378	1.378	0.276	4791-250	283375
11.8 x 7.9	0.000394	0.000433	1.575	1.575	0.315	4791-300	816322

Beveled Edge Squares



90°

- DIN875, grade 00
- Two beveled edges on upright blade for inside and outside measurements
- Hardened stainless steel
- Supplied in fitted storage case

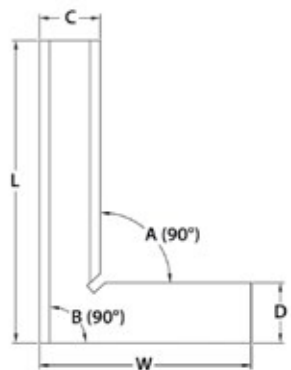

L x W Dimensions	A Inside Squareness	B Outside Squareness	C	D	H	INSIZE No.	Code
2.0" x 1.6"	0.000094"	0.000098"	0.512"	0.512"	0.157"	4790-050	816300
3.0" x 2.0"	0.000102"	0.000110"	0.591"	0.591"	0.157"	4790-075	816302
3.9" x 2.8"	0.000110"	0.000118"	0.787"	0.787"	0.197"	4790-0100	816304
5.9" x 3.9"	0.000126"	0.000138"	1.181"	1.181"	0.236"	4790-0150	816306
7.9" x 5.1"	0.000146"	0.000157"	1.339"	1.339"	0.276"	4790-0200	816308
11.8" x 7.9"	0.000181"	0.000197"	1.575"	1.575"	0.315"	4790-0300	816310
50mm x 40mm	6µm	6µm	13mm	13mm	4mm	4790-500	283354
75mm x 50mm	6µm	7µm	15mm	15mm	4mm	4790-750	283355
100mm x 70mm	7µm	7µm	20mm	20mm	5mm	4790-1000	283356
150mm x 100mm	7µm	8µm	30mm	30mm	6mm	4790-1500	283357
200mm x 130mm	8µm	9µm	34mm	34mm	7mm	4790-2000	283358
250mm x 165mm	9µm	10µm	35mm	35mm	7mm	4790-2500	283359

Flat Edge Squares



90° with Wide Base

- DIN875, grade 00
- Hardened stainless steel

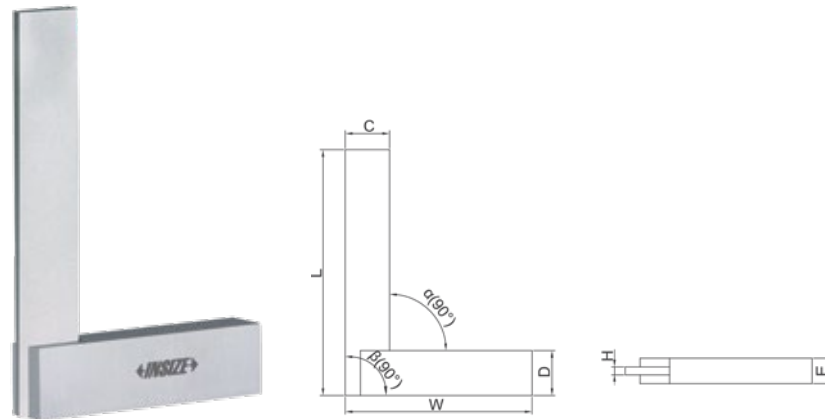

L x W Dimensions	α Inside Squareness	β Outside Squareness	C	D	H	E	INSIZE No.	Code
50mm x 40mm	6 μ m	6 μ m	12mm	12mm	3mm	10mm	4792-50	283383
75mm x 50mm	6 μ m	7 μ m	14mm	14mm	3mm	10mm	4792-75	283384
5.3" x 3.9"	315 μ in	315 μ in	0.866"	0.866"	0.157"	0.472"	4792-150	283391

Machinist Squares



with Wide Base

- Economic model
- DIN875, grade 2
- Carbon steel, no anti-rust treatment, not hardened

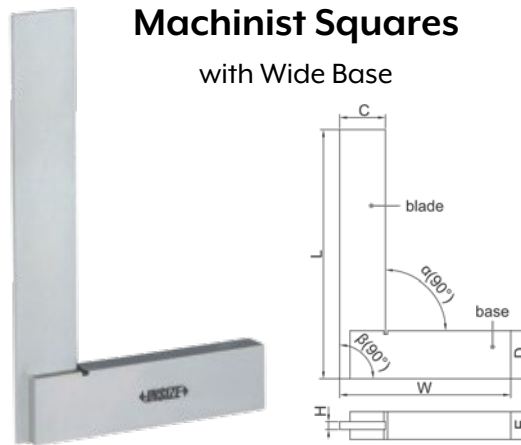

L x W Dimensions	α Inside Squareness	β Outside Squareness	C	D	H	E	INSIZE No.	Code
2x1.6"	0.95mil	0.98mil	0.63"	0.472"	0.118"	0.354"	4707-50	283490
3x2"	1.02mil	1.1mil	0.63"	0.63"	0.118"	0.354"	4707-75	283491
3.9x2.8"	1.1mil	1.18mil	0.748"	0.748"	0.118"	0.472"	4707-100	283492
6x4"	1.3mil	1.38mil	0.984"	0.984"	0.118"	0.63"	4707-150	283493
8x5"	1.46mil	1.58mil	1.181"	1.23"	0.157"	0.63"	4707-200	283494
10x6"	1.65mil	1.77mil	1.181"	1.26"	0.157"	0.748"	4707-250	283495
12x8"	1.85mil	1.97mil	1.26"	1.26"	0.157"	0.748"	4707-300	283496
16x10"	2.21mil	2.36mil	1.496"	1.496"	0.197"	0.866"	4707-400	283497
20x12"	2.56mil	2.76mil	1.772"	1.969"	0.236"	0.984"	4707-500	283498
24x14"	2.95mil	3.15mil	1.969"	1.969"	0.236"	1.181"	4707-600	877026
750x400mm	90 μ m	95 μ m	55mm	55mm	6mm	50mm	4707-750	877360
900x500mm	103 μ m	110 μ m	65mm	75mm	9mm	50mm	4707-900	877361



Flat Edge Squares

90° with Wide Base

- DIN875, grade 0
- Hardened stainless steel

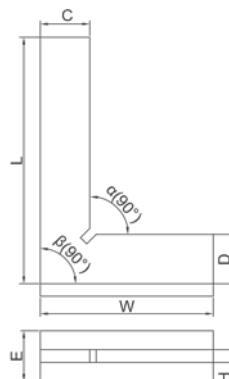

L x W Dimensions	α Inside Squareness	β Outside Squareness	C	D	H	E	INSIZE No.	Code
100mm x 70mm	7 μ m	7 μ m	20mm	20mm	5mm	20mm	4793-100	283378
200mm x 130mm	8 μ m	9 μ m	30mm	30mm	7mm	30mm	4793-200	283380

Engineer's Precision Squares

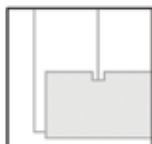
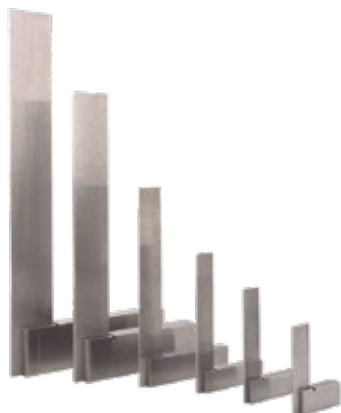

Stock is grooved at inner corner for clearance for burr or dirt so that there is no interference with measuring accuracies

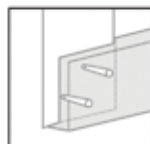

Use of tapered self locking rivets ensures perfect rigidity

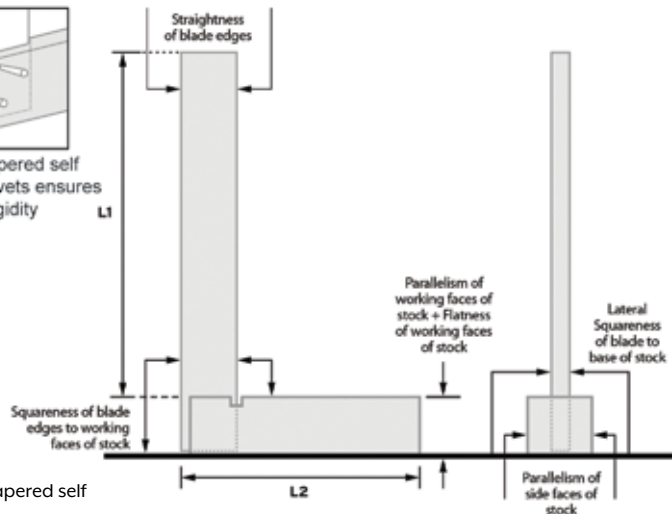

- Internal and external squareness as per BS 939 Grade B
- For setting up and checking jobs where extreme accuracy is required
- Hardened spring steel blades are permanently fixed to the stock by means of tapered self locking rivets which ensure complete rigidity
- Both blade and stock are precisely ground to ensure straightness and parallelism
- Working edges of blades are lapped which further enhance accuracy
- Groove on inner corner of stock aids in the clearance of burrs and dirt

L1 Blade Length (Inch)	L2 Stock Length (Inch)	Code
2	2	840562
3	2-3/8	840563
4	3	840564
6	4	840566
8	5	840568
12	8-9/32	840572



Sets

Contents	Code
One each of 2", 3", 4" and 6" squares	840573
One each of 2", 4" and 6" squares	840574

Center Squares

- Made from tool quality alloy steel
- Blade hardened and tempered
- Designed for fast and accurate location of the center of the face of a round bar or disc within the sizes listed
- A useful tool for machinists and toolmakers



Maximum Work Diameter (Inch)	Code
1-1/2	840580
3	840581

Feeler Gage



- Hardened alloy steel (except 0.01" blade - brass)
- Blades individually marked with inch/metric measurements
- Supplied in storage pouch

Range (Inch)	Thickness of Blades (Inch)	Accuracy (Inch)	No. of Blades	INSIZE No.	Code
0.0015-0.035	0.010 (brass)	±0.00039	32	4608-31	283543
	0.0015, 0.002	±0.00020			
	0.0025, 0.003, 0.004, 0.005, 0.006, 0.007	±0.00028			
	0.008, 0.009	±0.00035			
	0.010, 0.011	±0.00039			
	0.012, 0.013	±0.00047			
	0.014, 0.015	±0.00051			
	0.016, 0.017	±0.00055			
	0.018, 0.019	±0.00059			
	0.020, 0.021	±0.00067			
	0.022, 0.023	±0.00071			
	0.024, 0.025, 0.026	±0.00075			
	0.028	±0.00091			
	0.030	±0.00094			
0.032, 0.035	±0.00102				

Feeler Gages



Range (Inch)	No. of Blades	Code
0.008-0.026	12	840391
0.002-0.025	15	840392
0.0015-0.025	26	840393
0.0015-0.035	32	840394

Screw Pitch Gages

- Compact leaf style gage is used to measure the screw pitch of threads
- Pitch size marked on each leaf
- Leaves can be locked in position
- 60° threads

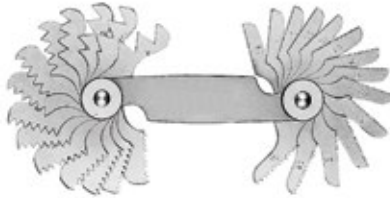

Range of Pitch	No. of Leaves	Code	Range of Pitch	No. of Leaves	Code
4-30	24	820231	0.25-6mm	24	820239
32-82	26	820232	0.25-6mm	48	820240
4-42	30	820233	0.4-7mm	51	820243
2-1/4 - 28	27	820234	4-84	51	820244
0.25-2.5mm	28	820235	6-60	30	820245
0.4-7mm	18	820236	4-80	28	820246
0.5-7mm	17	820237	3-1/2 - 32	26	820247
1-11.5mm	22	820238			

ACME Screw Thread Cutting Gages

- Used to measure the edges of Acme thread cutting tools

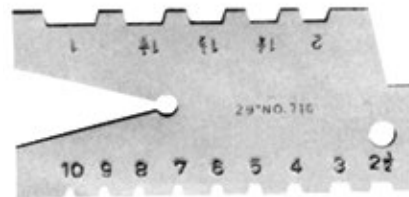

Range, Pitch	Code
1-10TPI, 29°	820262
3-10mm, 30°	820263
3-10 mm, 30° Round	820264

Long Feeler Gage



- Made of hardened alloy steel
- Meet DIN2275/grade TCI
- Accuracy: $\pm(3+T/80)$ μm , 'T' is the thickness of leaves in μm

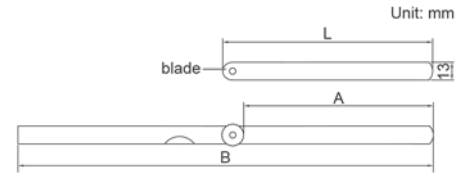

Range (mm)	Thickness of Blades (mm)	No. of Blades	L (mm)	A (mm)	B (mm)	INSIZE No.	Code
0.05-1	0.05, 0.10, 0.15, 0.20, 0.25, 0.30, 0.40, 0.50, 0.60, 0.70,	13	150	135	295	4605-13	283530
0.05-1	0.80, 0.90, 1.00	13	300	285	590	4605-132	283532
0.05-1	0.05, 0.10, 0.15, 0.20, 0.25, 0.30, 0.35, 0.40, 0.45, 0.50,	20	150	135	295	4605-20	283533
0.05-1	0.55, 0.60, 0.65, 0.70, 0.75, 0.80, 0.85, 0.90, 0.95, 1.00	20	200	185	395	4605-201	283534
0.05-1		20	300	285	590	4605-202	283535

Feeler Gage



- Made of hardened alloy steel
- Meet DIN2275/grade TCI
- Accuracy: $\pm(3+T/80)$ μm , 'T' is the thickness of leaves in μm

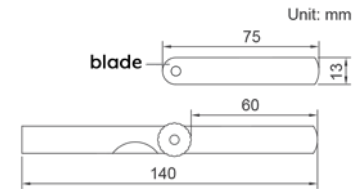

Range (mm)	Thickness of Blades (mm)	No. of Blades	INSIZE No.	Code
0.04-1	0.04, 0.05, 0.06, 0.07, 0.08, 0.09, 0.10, 0.15, 0.20, 0.25, 0.30, 0.35, 0.40, 0.45, 0.50, 0.55, 0.60, 0.65, 0.70, 0.75, 0.80, 0.85, 0.90, 0.95, 1.00	25	4601-25	283523



Pitch Gages

- For measuring the pitch of screw threads
- Blades individually marked with pitch
- Supplied in storage pouch



Range	Accuracy	Thread Type	Blade Pitch	No. of Blades	INSIZE No.	Code
1-12 TPI	±0.0028"	ACME 29°	1, 1-1/3, 1-1/2, 1-3/4, 2, 2-1/2, 3, 3-1/2, 4, 5, 6, 7, 8, 9, 10, 12 TPI	16	4824-16	283549
2-20 mm	±0.07mm	Tr 30°	2, 3, 4, 5, 6, 7, 8, 9, 10, 12, 16, 20 mm	12	4824-12	283548

Pitch Gages



Metric, Unified & Whitworth

- For measuring the pitch of screw threads
- Blades individually marked with pitch
- Medium carbon steel
- Supplied in storage pouch



Range	Accuracy	Thread Type	Blade Pitch	No. of Blades	INSIZE No.	Code
0.25-6mm	±0.07mm	Metric 60°	0.25, 0.3, 0.35, 0.4, 0.45, 0.5, 0.6, 0.7, 0.75, 0.8, 0.9, 1, 1.25, 1.5, 1.75, 2, 2.5, 3, 3.5, 4, 4.5, 5, 5.5, 6 mm	52	4820-452	283556
4-62TPI	±0.0028"	Whitworth 55°	4, 4-1/2, 5, 6, 7, 8, 9, 10, 11, 12, 13, 14, 16, 18, 19, 20, 22, 24, 25, 26, 28, 30, 32, 36, 40, 48, 60, 62 TPI			
0.4-7mm	±0.07mm	Metric 60°	0.4, 0.5, 0.6, 0.7, 0.75, 0.8, 0.9, 1, 1.25, 1.5, 1.75, 2, 2.5, 3, 3.5, 4, 4.5, 5, 5.5, 6, 6.5, 7 mm	52	4820-552	816695
4-42TPI	±0.0028"	Unified 60°	4, 4-1/2, 5, 5-1/2, 6, 7, 8, 9, 10, 11, 11-1/2, 12, 13, 14, 15, 16, 18, 20, 22, 24, 26, 27, 28, 30, 32, 34, 36, 38, 40, 42 TPI			
4-42TPI	±0.0028"	Unified 60°	4, 4-1/2, 5, 5-1/2, 6, 7, 8, 9, 10, 11, 11-1/2, 12, 13, 14, 15, 16, 18, 20, 22, 24, 26, 27, 28, 30, 32, 34, 36, 38, 40, 42 TPI	30	4820-230	283552
0.4-7mm	±0.07mm	Metric 60°	0.4, 0.5, 0.6, 0.7, 0.75, 0.8, 0.9, 1, 1.25, 1.5, 1.75, 2, 2.5, 3, 3.5, 4, 4.5, 5, 5.5, 6, 6.5, 7 mm	22	4820-122	283550
0.25-7mm	±0.0028"	Metric 60°	0.25, 0.3, 0.35, 0.4, 0.5, 0.7, 0.75, 0.8, 0.9, 1, 1.25, 1.5, 1.75, 2, 2.5, 3, 3.5, 4, 4.5, 5, 5.5, 6, 6.5, 7 mm	24	4820-124	283551
4-62TPI	-	Whitworth 55°	4, 4-1/2, 5, 6, 7, 8, 9, 10, 11, 12, 13, 14, 16, 18, 19, 20, 22, 24, 25, 26, 28, 30, 32, 36, 40, 48, 60, 62TPI	28	4820-328	283555
4-42TPI	±0.0028"	Whitworth 55°	4, 4-1/2, 5, 5-1/2, 6, 7, 8, 9, 10, 11, 12, 13, 14, 15, 16, 18, 19, 20, 22, 24, 26, 27, 28, 30, 32, 34, 36, 38, 40, 42 TPI	30	4820-330	283554

Thread Gage



- Standard for grinding and setting tools when cutting ACME threads
- Supplied in storage pouch

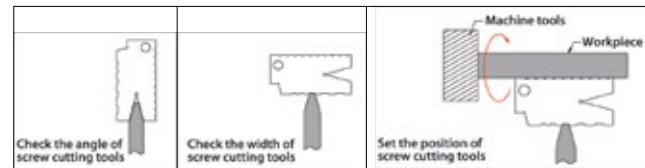
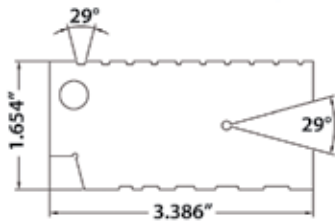

Range	Accuracy	Thread Type	Pitch	INSIZE No.	Code
1-10TPI	±0min.	ACME 29°	1, 1-1/3, 1-1/2, 1-3/4, 2, 2-1/2, 3, 4, 5, 6, 7, 8, 9, 10 TPI	4812-E	283557

Center Gages



- To check and set screw cutting tools, and to check the angle and pitch of the screw thread
- Angle accuracy: ± 30 min.
- Stainless steel

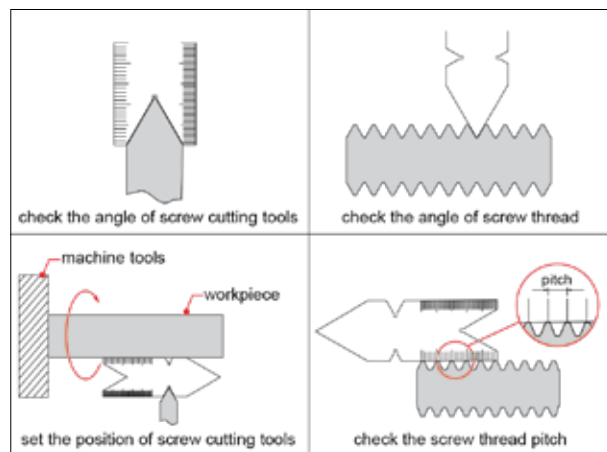
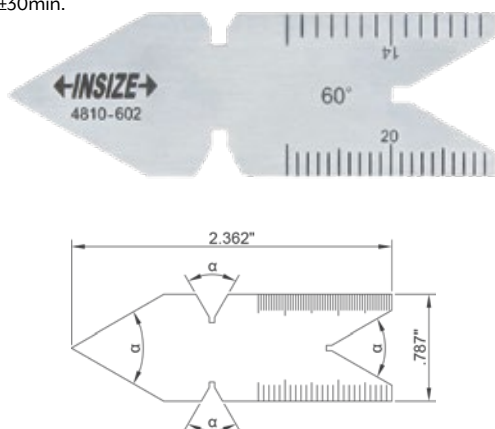

Thread	Angle	Graduations	INSIZE No.	Code
Unified 60°	60°	14ths and 20ths on one side, 24ths and 32nds on opposite side	4810-602	283560
Metric 60°	60°	0.5mm and 1mm	4810-601	283559
Whitworth 55°	55°	14ths and 20ths on one side, 24ths and 32nds on opposite side	4810-55	283561

Angle Gage Set

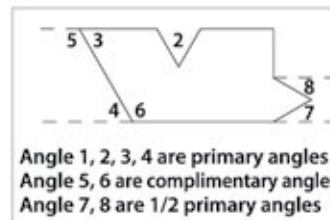
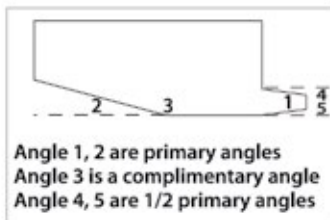

- Each blade checks primary, 1/2 primary and complimentary angles
- Medium carbon steel
- Supplied in storage pouch

Accuracy	Primary Angle	1/2 Primary Angle	Complimentary Angle	Type	No. of Blades	INSIZE No.	Code
	5°	2°30'	175°	A			
	10°	5°	170°	A			
	15°	7°30'	165°	A			
	20°	10°	160°	B			
	25°	12°30'	155°	B			
	30°	15°	150°	B			
	35°	17°30'	145°	B			
	40°	20°	140°	B			
	45°	22°30'	135°	B			
± 10 min.	50°	25°	130°	B	18	4807	816602
	55°	27°30'	125°	B			
	60°	30°	120°	B			
	65°	32°30'	115°	B			
	70°	35°	110°	B			
	75°	37°30'	105°	B			
	80°	40°	100°	B			
	85°	42°30'	95°	B			
	90°	45°	90°	B			

Electronic Chamfer Gage

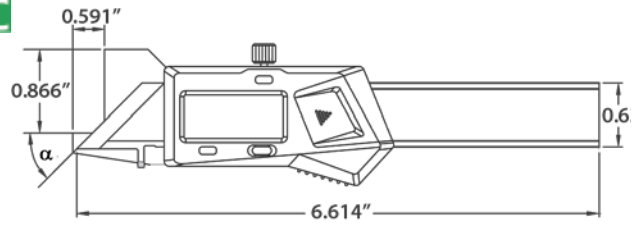

- Measures 45° chamfer dimension
- Resolution: 0.0005"/0.01mm
- Accuracy: ±0.0025"/0.063mm
- Buttons: on/off, zero, inch/mm
- Auto power off - move unit to turn power on
- Battery CR2032
- Data output
- Stainless steel

OPTIONAL ACCESSORY: SPC cable

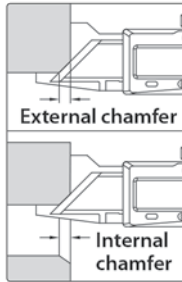

Range (Inch/mm)	α Chamfer	INSIZE No.	Code
0-0.39/0-10	45°	1180-6	816370
0-0.39/0-10	30°	1180-63	877283

Electronic Radius Gage

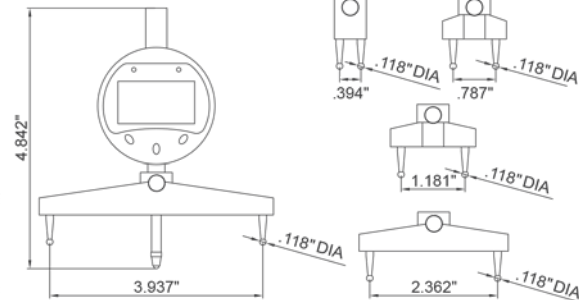

- For measuring the radius of internal and external arcs
- Resolution: 0.00005"/0.005mm
- Buttons: on/off, hold, inch/mm, s (select jaws), zero
- Display may be rotated 320°
- Supplied with 5 separate jaws for multiple arc sizes
- Battery CR2032
- Auto power off
- Supplied in fitted storage case

R1 Range of External Radius (Inch/mm)	R2 Range of Internal Radius (Inch/mm)	Accuracy (Inch)	INSIZE No.	Code
0.2-35.83/5-910	0.3-35.83/7-910	*±0.01R	2183	283213

*R is the radius to be measured (Inch)

Radius Gages



- Medium carbon steel
- Supplied in storage pouch



Range	Accuracy	Blade Size	Blade Quantity Internal + External	INSIZE No.	Code
1/32-1/4"	±0.0012"	1/32", 3/64", 1/16", 5/64", 3/32", 7/64", 1/8", 9/64", 5/32", 11/64", 3/16", 13/64", 7/32", 15/64", 1/4"	15 + 15	4801-15E	283567
17/64-1/2"	±0.0014"	17/64", 9/32", 19/64", 5/16", 21/64", 11/32", 23/64", 3/8", 25/64", 13/32", 27/64", 7/16", 29/64", 15/32", 31/64", 1/2"	16 + 16	4801-16E	283568
7.5-15mm	-	7.5, 8, 8.5, 9, 9.5, 10, 10.5, 11, 11.5, 12, 12.5, 13, 13.5, 14, 14.5, 15mm	16 + 16	4801-16	283565
1-7mm	-	1, 1.25, 1.5, 1.75, 2, 2.25, 2.5, 2.75, 3, 3.5, 4, 4.5, 5, 5.5, 6, 6.5, 7mm	17 + 17	4801-17	283564
17/32-1"	-	17/32", 9/16", 19/32", 5/8", 21/32", 11/16", 23/32", 3/4", 25/32", 13/16", 27/32", 7/8", 29/32", 15/16", 31/32", 1"	16 + 16	4801-16E1	283569



816196

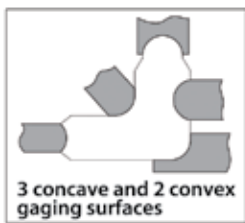

3 concave and 2 convex gaging surfaces

Radius Gage Sets

- Each piece has three concave and two convex gaging surfaces
- Medium carbon steel

Range	Accuracy	Blade Size	Blades	Handle & Storage	INSIZE No.	Code
1/64"-1/2"	±0.002"	1/64, 1/32, 3/64, 1/16, 5/64, 3/32, 7/64, 1/8, 9/64, 5/32, 11/64, 3/16, 13/64, 7/32, 15/64, 1/4, 17/64, 9/32, 5/16, 11/32, 3/8, 13/32, 7/16, 15/32, 1/2"	25	✓	4804-25E	816198
9/16"-1"	±0.0025"	9/16, 5/8, 11/16, 3/4, 13/16, 7/8, 15/16, 1"	8	-	4804-8E	816200
1-1/16" - 1-1/2"	-	1-1/16, 1-1/8, 1-3/16, 1-1/4, 1-5/16, 1-3/8, 1-7/16, 1-1/2"	8	-	4804-8E1	283571
0.5-13mm	±0.05mm	0.5, 1, 1.5, 2, 2.5, 3, 3.5, 4, 4.5, 5, 5.5, 6, 6.5, 7, 7.5, 8, 8.5, 9, 9.5, 10, 10.5, 11, 11.5, 12, 12.5, 13 mm	26	✓	4804-26	816196
0.01"-5"	-	0.010", 0.015", 0.020", 0.025", 0.030", 0.040", 0.050", 0.060", 0.070", 0.080", 0.090", 0.100", 0.12", 0.14", 0.16", 0.18", 0.20", 0.22", 0.24", 0.26", 0.28", 0.30", 0.35", 0.40", 0.45", 0.50"	26	✓	4804-26E	283572

Edge & Corner Radii Gages



- Used to measure the radii of edges and corners
(Both sides of the leaf can be used)
- 60° point

Range	No. of Leaves	Code
1/32" to 17/64" by 64ths	16	820218
9/32" to 33/64" by 64ths	16	820219
0.75 to 5mm by 0.25mm increments	18	820220
5.5 to 13mm by 0.5mm increments	16	820221

Sheet Metal Gage American Standard



- US standard for gaging sheet metal, plate iron and steel
- Hardened steel with satin chrome finish
- Supplied in storage pouch

Range	INSIZE No.	Code
0-36 (0.3125-0.007")	4809	283575

No.	Width (Inch)	No.	Width (Inch)	No.	Width (Inch)	No.	Width (Inch)	No.	Width (Inch)	No.	Width (Inch)	No.	Width (Inch)	No.	Width (Inch)
0	0.3125	5	0.2188	10	0.1406	15	0.0703	20	0.0375	25	0.0219	29	0.0141	33	0.0094
1	0.2813	6	0.2031	11	0.1250	16	0.0625	21	0.0344	26	0.0188	30	0.0125	34	0.0086
2	0.2656	7	0.1875	12	0.1094	17	0.0563	22	0.0313	27	0.0172	31	0.0109	35	0.0078
3	0.2500	8	0.1719	13	0.0938	18	0.0500	23	0.0281	28	0.0156	32	0.0102	36	0.0070
4	0.2344	9	0.1563	14	0.0781	19	0.0438	24	0.0250						

Wire Gage American Standard

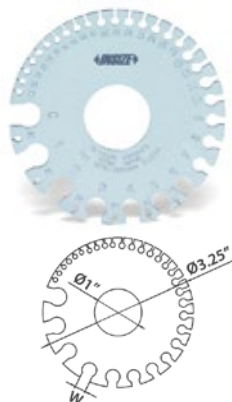

- US standard for gaging non-ferrous wire and metals such as copper, brass and aluminum
- Hardened steel with satin chrome finish
- Supplied in storage pouch

Range	INSIZE No.	Code
0-36 (0.3249-0.005")	4808	283574

No.	Width (Inch)	No.	Width (Inch)	No.	Width (Inch)	No.	Width (Inch)	No.	Width (Inch)	No.	Width (Inch)	No.	Width (Inch)	No.	Width (Inch)
0	0.3249	5	0.1819	10	0.1019	15	0.0571	20	0.0320	25	0.0179	29	0.0113	33	0.0071
1	0.2893	6	0.1620	11	0.0907	16	0.0508	21	0.0285	26	0.0159	30	0.0100	34	0.0063
2	0.2576	7	0.1443	12	0.0808	17	0.0453	22	0.0253	27	0.0142	31	0.0089	35	0.0056
3	0.2294	8	0.1285	13	0.0720	18	0.0403	23	0.0226	28	0.0126	32	0.0080	36	0.0050
4	0.2043	9	0.1144	14	0.0641	19	0.0359	24	0.0201						



Drill Angle Gage

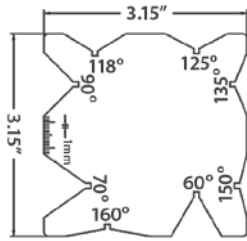

- For checking drills with 60°, 70°, 90°, 118°, 125°, 135°, 150°, or 160° angles
- Stainless steel
- Supplied in storage pouch

Accuracy	INSIZE No.	Code
±0.5°	4842-1	816683

Drill Gages



No. of Holes	Code
29	840605
60	840606

Twist Drill Gage

- Used to check the angles or twist drills with a 118° point and up to 2" in diameter
- Also used for checking the angle profile of drills after regrinding to ensure that the center of the tip is concentric with the drill body
- Stainless steel
- Polished finish
- All gaging surfaces are ground



Code
820257

Taper Gages

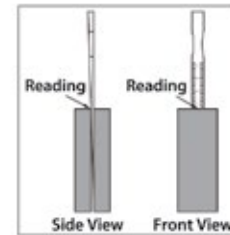
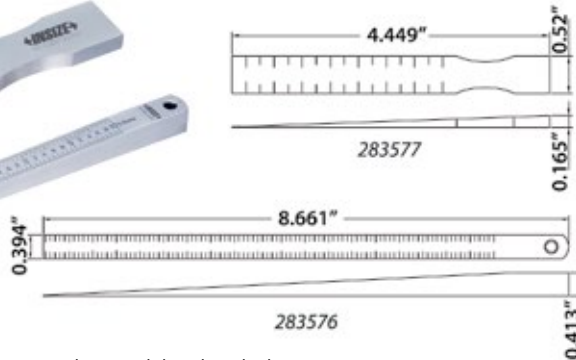
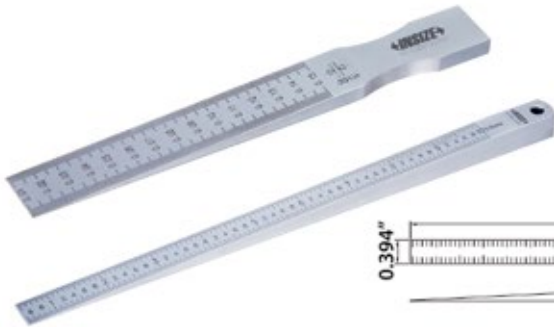

- For quick measuring of slot width and various gaps in material and work pieces
- Stainless steel with satin chrome plated reading surface
- Supplied in storage pouch

Range	Accuracy	Graduation	INSIZE No.	Code
0.01"-0.15"	±0.003"	0.001"	4630-1E	283577
0.4mm-6mm	±0.04mm	0.05mm	4630-3	877359
0.5mm-10mm	±0.07mm	0.05mm	4630-1	283576

Taper Gage



- Graduation: 1/64"
- Accuracy: ±0.0039"
- For quick measuring of slot width and various gaps in material and work pieces
- Diameter correction table on back
- Stainless steel
- Supplied in storage pouch

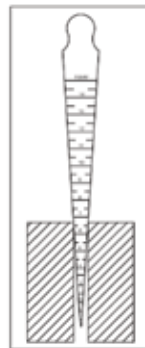

Range	Accuracy	INSIZE No.	Code
1/32-5/8"	±0.004"	4833-1E	877263
5/8 - 1-3/16"	±0.004"	4833-2E	877364
1-3/16 - 1-3/4"	±0.004"	4833-3E	877365
0.8-15mm	±0.1mm	4833-1	285112

Gear Tooth Gages

With Ring Holder



- Easy to determine diametral pitch of involute gears

Range of Pitch	No. of Leaves	Code
6, 7, 8, 9, 10, 11, 12, 14, 16, 18, 20, 22, 24, 26, 28, 30, 32, 36, 40, 48, 64, 80 per inch	14	820281
2, 2-1/2, 3, 3-1/2, 4, 4-1/2, 5 per inch	7	820282

Depth Gages with Protractors

- A versatile tool which allows measurements of both angles and depths
- Stainless steel
- Graduated from 0° to 180° in both directions
- Adjustable rule locks with knurled thumb nut
- 6"/150mm rule
- Rule graduated in inches on one side and mm on the other
- Polished finish

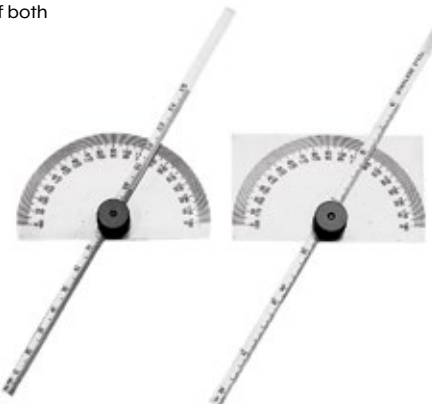

Type	Code
Round	840579
Rectangular	840578

GAGES

Depth & Angle Gages

- The ability to measure depths and angles is combined in this versatile tool
- The head is made of tool steel with a black oxide finish
- Graduated both left and right in 15°, 30°, and 45° increments
- Rule can be quickly set to any of the above angles
- A 6"/150mm steel rule is fitted to the head and can be locked in position for depth or angular measurements by a knurled nut

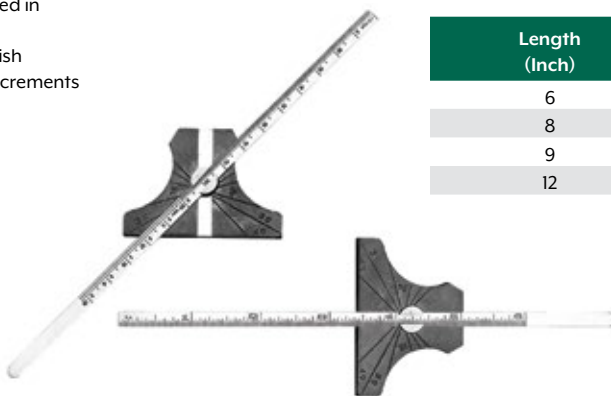

Length (Inch)	Code
6	840585
8	840586
9	840587
12	840588

Planer & Shaper Gage

- Beveled base and slide provide accurate alignment and parallelism
- Hardened base and slide
- Supplied with 1" and 3" extension posts
- Maximum Height 6-1/4"
- Precision level ensures accuracy
- Extra tapped holes in platform allow mounting of dial indicator posts and other accessories



Range (Inch)	Base Size (Inch)	Extension (Inch)	Code
1/4 - 6-1/4	9/16 x 5	1 and 3	820290

Thread Measuring Wire Set

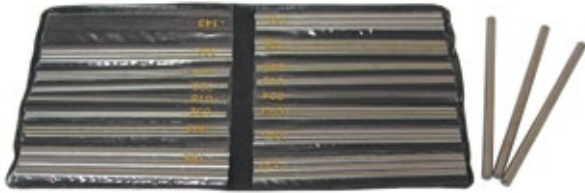

- 48 wires to measure all 60° threads from 3 to 48 threads per inch (0.5 to 6mm)
- Supplied in storage pouch with wire sizes marked on pockets

Code
835315

Thread Triangles

- Thread triangles quickly measure pitch diameter of all 60° threads from 4 to 80 pitch, standard and special
- Instantly classifies thread as 2, 2a, 3a
- No complicated formulas to figure. For any standard thread refer directly to chart (chart included). For special threads just add two numbers
- Convenient neoprene holders, fit any brand of micrometer spindle
- Thread triangles nest well into the "V" of the thread instead of just making point contact

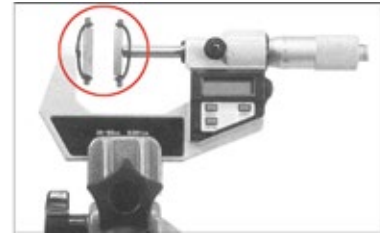

Code
805776

Pin/Plug Gage Sets

- Used for measuring hole sizes and depths, go and no-go gaging, setting micrometers, and checking distances between holes
- Box and gages both marked with sizes
- Size laser etched on each piece (0.011" - 0.060" not etched)
- Centerless lapped
- Each gage is inspected and has a 10 micron finish or better
- Heat treated to 60 - 62 Rockwell C hardness
- All gages within 0.0002" limit
- Accuracy: -0.0002" +0.0000"
- Material: 52100 bearing steel
- Pieces 2" overall length
- Supplied in fitted case



Minus Sets

Range (Inch)	No. of Pieces	Code
0.011-0.06	50	845150
0.061-0.25	190	845151
0.251-0.5	250	845152
0.501-0.625	125	845153
0.626-0.75	125	845154
0.751-0.832	82	845155
0.833-0.916	84	845156
0.917-1	84	845157

Plus Sets

Range (Inch)	No. of Pieces	Code
0.011-0.06	50	845140
0.061-0.25	190	845141
0.251-0.5	250	845142
0.501-0.625	125	845143
0.626-0.75	125	845144
0.833-0.916	84	845146
0.917-1	84	845147

Space Block Set

Inch

- 3/4" body diameter, 1/4 - 28 internal thread
- Accuracy: ±0.0005"
- Each block clearly marked for size
- Hardened and lapped
- Four connecting screws included to make up desired length
- Supplied in fitted case



Blocks Included	Code
0.05, 0.06, 0.062, 0.07, 0.08, 0.09, 0.1, 0.101, 0.102, 0.103, 0.104, 0.105, 0.106, 0.107, 0.108, 0.109, 0.11, 0.12, 0.125, 0.13, 0.14, 0.15, 0.16, 0.17, 0.18, 0.19, 0.2, 0.3, 0.4, 0.5, 0.6, 0.7, 0.8, 0.9, 1, 1	845210

Thread Plug Gages



American Standard

- Supplied with GO and NO-GO end
- Class 2B
- ANSI B1.2 standard
- Supplied with manufacturer inspection certificate



Size	INSIZE No.	Code
No. 2-56UNC	4131-21	877342
No. 4-40UNC	4131-41	816651
No. 4-48UNF	4131-42	877347
No. 6-32UNC	4131-61	816652
No. 6-40UNF	4131-62	877351
No. 8-32UNC	4131-81	816653
No. 8-36UNF	4131-82	877355
No. 10-24UNC	4131-101	877331
No. 10-32UNF	4131-102	816654
No. 12-24UNC	4131-121	877332
No. 12-28UNF	4131-122	877333
1/4-20UNC	4131-1B1	816655
1/4-28UNF	4131-1B2	816656
1/4-32UNEF	4131-1B3	877337

Size	INSIZE No.	Code
5/16-18UNC	4131-5D1	816657
5/16-24UNF	4131-5D2	816658
5/16-32UNEF	4131-5D3	877349
3/8-16UNC	4131-3C1	816659
3/8-24UNF	4131-3C2	816660
7/16-14UNC	4131-7D1	877354
7/16-20UNF	4131-7D2	816661
1/2-13UNC	4131-1A1	816662
1/2-20UNF	4131-1A2	816663
9/16-12UNC	4131-9D1	877356
9/16-18UNF	4131-9D2	816664
9/16-24UNEF	4131-9D3	877358
5/8-11UNC	4131-5C1	816665
5/8-18UNF	4131-5C2	816666

Size	INSIZE No.	Code
3/4-10UNC	4131-3B1	816667
3/4-16UNF	4131-3B2	816668
13/16-16UNJ	4131-13D516	877335
13/16-20UNEF	4131-13D3	877334
7/8-9UNC	4131-7C1	877352
7/8-14UNF	4131-7C2	877353
1-8UNC	4131-2A1	877343
1-12UNF	4131-2A2	877344
1-14UNS	4131-2A514	877345
1 1/16-12UN	4131-1E512	877338
1 3/16-12UN	4131-3E512	877346
1 1/4-7UNC	4131-1G1	877340
1 1/4-12UNF	4131-1G2	877341

Metric

- Supplied with GO and NO-GO end
- Class 6H
- ISO1502 standard
- Supplied with manufacturer inspection certificate



Size (mm)	INSIZE No.	Code
M2 x 0.4	4130-2	284053
M2.2 x 0.45	4130-2D2	284054
M2.5 x 0.45	4130-2D5	284055
M3 x 0.5	4130-3	284056
M3.5 x 0.6	4130-3D5	284057
M4 x 0.7	4130-4	284058
M5 x 0.8	4130-5	284059
M6 x 1	4130-6	284060
M7 x 1	4130-7	816680
M8 x 1.25	4130-8	284061

Size (mm)	INSIZE No.	Code
M9 x 1.25	4130-9	816681
M10 x 1.5	4130-10	284062
M11 x 1.5	4130-11	816682
M12 x 1.75	4130-12	284063
M14 x 2	4130-14	284064
M16 x 2	4130-16	284065
M18 x 2.5	4130-18	284066
M20 x 2.5	4130-20	284067
M22 x 2.5	4130-22	284068
M24 x 3	4130-24	284069

Size (mm)	INSIZE No.	Code
M27 x 3	4130-27	284070
M30 x 3.5	4130-30	284071
M33 x 3.5	4130-33	284072
M36 x 4	4130-36	284073
M39 x 4	4130-39	284074
M42 x 4.5	4130-42	284075
M45 x 4.5	4130-45	284076
M48 x 5	4130-48	284077
M52 x 5	4130-52	284078
M56 x 5.5	4130-56	284079
M60 x 5.5	4130-60	284080

Angle Gage Set



- To check complimentary angles
- Stainless steel



Range	Angle of leaves included	Quantity of leaves	Accuracy	INSIZE No.	Code
1°-45°	1°, 2°, 3°, 4°, 5°, 6°, 7°, 8°, 9°, 10°, 12°, 14°, 16°, 18°, 20°, 25°, 30°, 35°, 40°, 45°	20	±30°	4806-20	816600

Welding Gage

Adjustable Scale



- Adjustable scale to compensate for pointer wear
- Stainless steel
- Supplied in storage pouch



Front

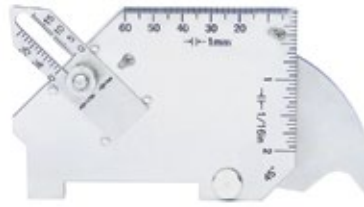

Back

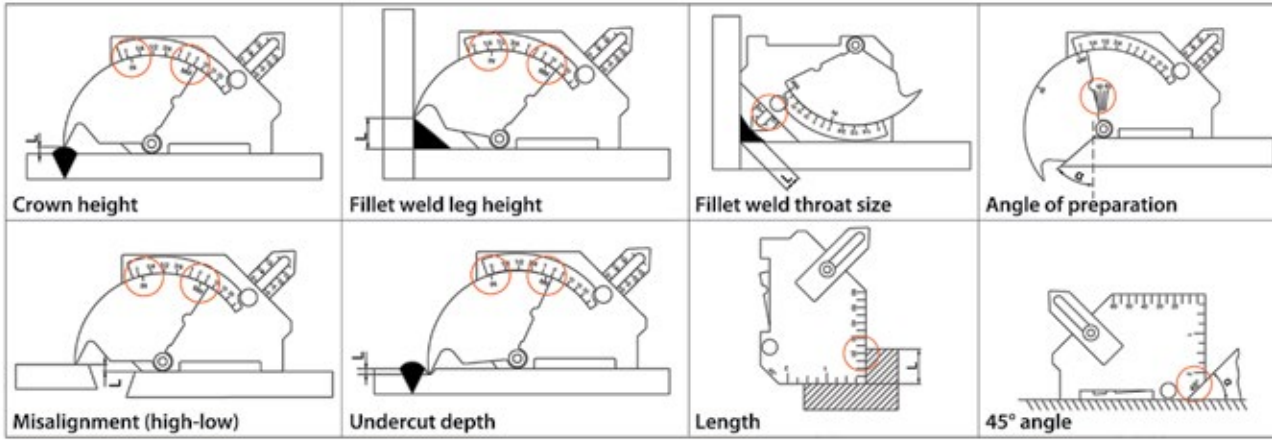
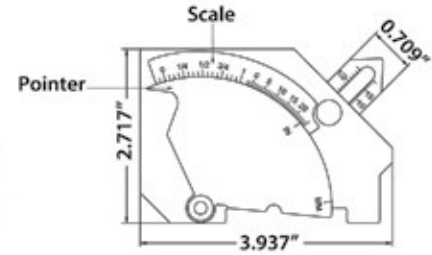

Measurement	Range	Accuracy	Graduation	INSIZE No.	Code
Crown height	0-1" (0-25mm)	±0.02"	1/16" (1mm)	4835-1	877031
Fillet weld leg height	0-1" (0-25mm)	±0.02"	1/16" (1mm)		
Misalignment (high-low)	0-1" (0-25mm)	±0.02"	1/16" (1mm)		
Undercut depth	0-1/8" (0-2mm)	±0.02"	1/16" (1mm)		
Fillet weld throat size	0-3/4" (0-20mm)	±0.02"	1/16" (1mm)		
Angle of preparation	0-60°	±1°	5°		
Length	0-2" (0-60mm)	±0.02"	1/16" (1mm)		
45° angle	-	±1°	-		

Electronic Welding Gage



- Buttons: zero, inch/mm, on/off
- Battery LR44
- Stainless steel

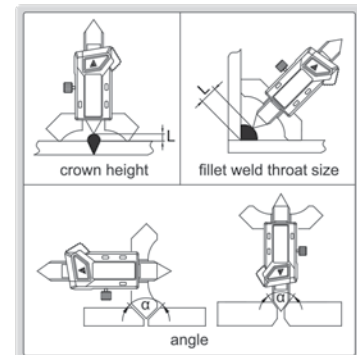
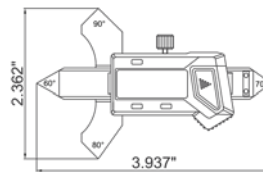

Measurement	Range (Inch/mm)	Accuracy	Resolution (Inch/mm)	INSIZE No.	Code
Crown height	0-0.4/0-7	±0.0012	0.0005/0.01	4831-20A	877170
Fillet weld throat size	0-0.8/0-20	±0.0039	0.0005/0.01		
Angle	60°, 70°, 80°, 90°	±1°	-		

Fillet Welding Gage

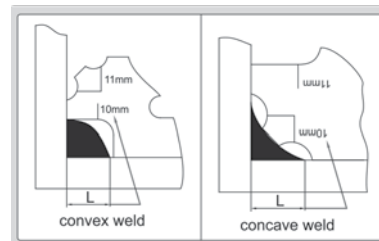
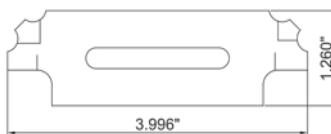

- Measures concave and convex weld sizes
- 7 blades included
- Stainless steel

Size	Accuracy	INSIZE No.	Code
3mm, 4mm, 5mm, 6mm, 8mm, 9mm, 10mm, 11mm, 12mm, 14mm, 16mm, 19mm, 22mm, 25mm	±0.5mm	4836-1	877366
1/8" (3.2mm), 3/16" (4.8mm), 1/4" (6.4mm), 5/16" (7.9mm), 3/8" (9.5mm), 7/16" (11.1mm), 1/2" (12.7mm), 5/8" (15.9mm), 3/4" (19.1mm), 7/8" (22.2mm), 1" (25.4mm)	±0.02" (0.5mm)	4836-2	877171

Pipe Welding Gage

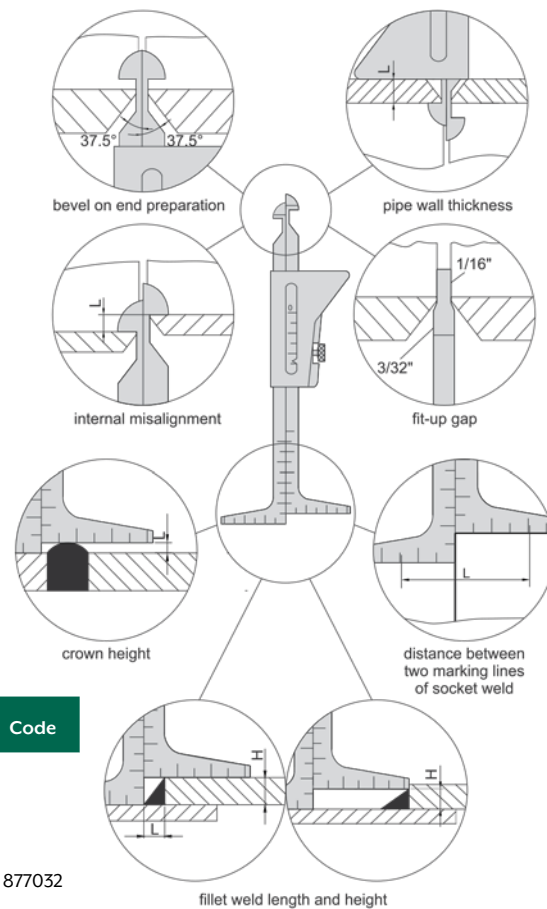
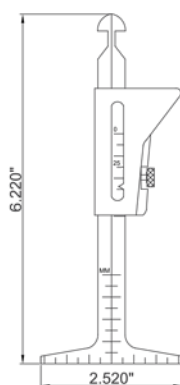

- Adjustable scale to compensate pointer wear
- Stainless steel

Measurement	Range	Accuracy	Graduation	INSIZE No.	Code
Bevel on end preparation	37.5°	±1°	-		
Pipe wall thickness	0 to 1-3/4" (0-45mm)	±0.02"	1/16" (1mm)		
Internal misalignment	0 to 1-3/8" (0-35mm)	±0.02"	1/32" (1mm)		
Fit-up gap	1/16", 3/32"	±0.004"	-		
Crown height	0 to 1-3/8" (0-35mm)	±0.02"	1/32" (1mm)	4839-1	877032
Distance between two marking lines of socket weld	0 to 2-3/8" (0-60mm)	±0.02"	1/16" (1mm)		
Fillet weld length	0 to 1-1/4" (0-30mm)	±0.02"	1/16" (1mm)		
Fillet weld height	0 to 1-3/8" (0-35mm)	±0.02"	1/32" (1mm)		

Drill Point Gage



- For twist drills with 118° angle, to check if the center of tip is concentric with the drill body
- Stainless steel

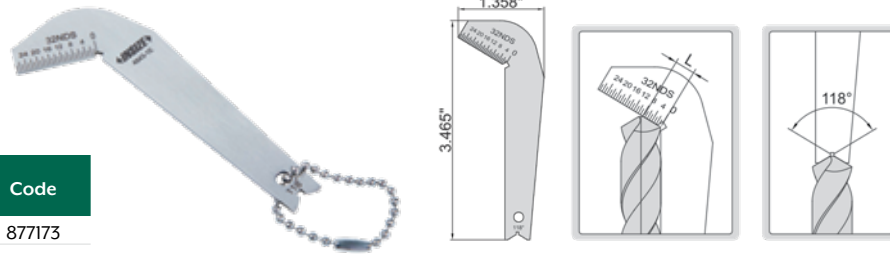

Accuracy		INSIZE No.	Code
Angle	Length		
±0.5°	±0.02"	4843-IE	877173

Electronic Force Gages



High Accuracy

- Push and pull test
- Peak (max.) and tracking mode
- Units: lbf, ozf, mN, N, gf, kgf
- Low and high limits with judgement
- 1000 memories
- Auto power off
- Metal case, touch buttons
- LCD display with backlight
- Display flips over when the bottom faces up
- Overload alarm
- Data output

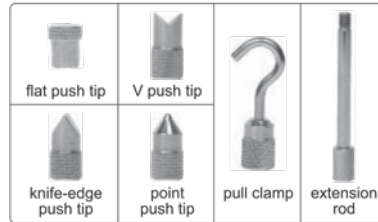

INCLUDES ONE OF EACH: Force gage, AC/DC adapter, USB cable and software, Push/pull accessories: 6 pieces - flat push tip, V push tip, knife-edge push tip, point push tip, pull clamp, extension rod

Load capacity (lbf)	11	22	44	110	220
Resolution (lbf)	0.001	0.005	0.01	0.01	0.05
Accuracy	±0.2% (of load capacity)				
Power Supply	Built-in rechargeable battery				
INSIZE No.	ISF-DF50A	ISF-DF100A	ISF-DF200A	ISF-DF500A	ISF-DF1KA
Code	877225	877221	877223	877224	877222

Test Stand for Electronic Force Gages



- For electronic force gages
- May be used vertical or horizontal



Force gage sold separately

Load capacity (lbf)	220lbf
Travel	7.87" (0.12" vertical movement per revolution of handwheel)
Dimension	7.72" x 9.84" x 17.56"
Weight	28.67lbs
INSIZE No.	ISF-MTIK
Code	877226

Telescoping Gage Set



- For quick measurement of inside diameter of holes and width of slots
- Satin chrome finish
- Supplied in storage pouch

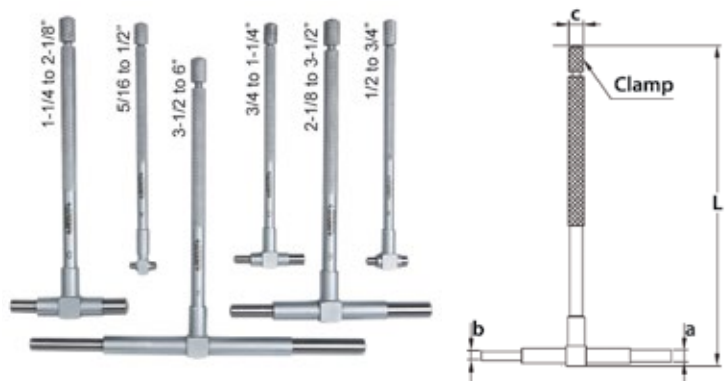
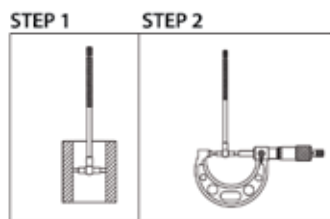

6 Gages per Set				
Range (Inch)	L (Inch)	Øa (Inch)	Øb (Inch)	Øc (Inch)
5/16 to 1/2	4.528	0.154	0.114	0.244
1/2 to 3/4	4.528	0.209	0.150	0.244
3/4 to 1-1/4	4.528	0.209	0.150	0.244
1-1/4 to 2-1/8	5.394	0.299	0.240	0.283
2-1/8 to 3-1/2	5.394	0.299	0.240	0.283
3-1/2 to 6	5.394	0.299	0.240	0.283

Range (Inch)	INSIZE No.	Code
5/16 to 6 (6pcs)	4206-1	816202

Long Handle Telescoping Gages



- For quick measurement of inside diameter of deep holes and width of slots
- Satin chrome finish
- Supplied in storage pouch

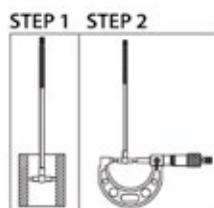

Range (Inch)	L (Inch)	Øa (Inch)	Øb (Inch)	Øc (Inch)	INSIZE No.	Code
5/16 to 1/2	9.843	0.154	0.114	0.244	4209-1	283589
1/2 to 3/4	9.843	0.209	0.150	0.244	4209-2	283590
3/4 to 1-1/4	9.843	0.209	0.150	0.244	4209-3	283591
1-1/4 to 2-1/8	11.811	0.299	0.240	0.283	4209-4	283592
2-1/8 to 3-1/2	11.811	0.299	0.240	0.283	4209-5	283593
3-1/2 to 6	11.811	0.299	0.240	0.283	4209-6	283594

Small Hole Gage Set

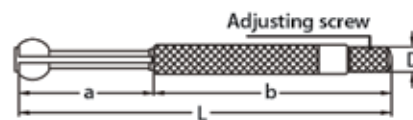
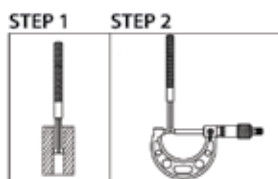

4 Gages per Set				
Range (Inch)	L (Inch)	a (Inch)	b (Inch)	ØD (Inch)
0.125-0.2	2.992	0.945	2.047	0.197
0.2-0.3	3.110	1.063	2.047	0.197
0.3-0.4	3.465	1.181	2.283	0.236
0.4-0.5	3.583	1.339	2.283	0.236

- For small holes, slots, grooves, etc.
- Satin chrome finish
- Supplied in storage pouch

Range (Inch)	INSIZE No.	Code
0.125 to 0.5 (4pcs)	4208-1	816204

Electronic Snap Gage

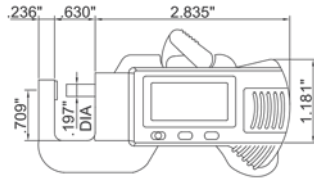

Range (Inch/mm)	Accuracy (Inch)	Resolution (Inch/mm)	INSIZE No.	Code
0-0.5/0-12	±0.0012	0.0005/0.01	2166-12	283197

Step and Gap Gage



Front



Back

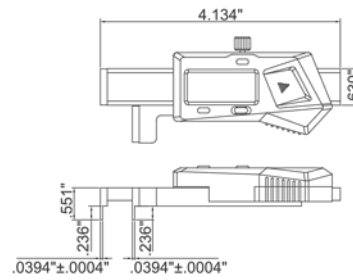

- Measures step height and gap width
- Buttons: on/off, zero, inch/mm
- Auto power off - move unit to turn power on
- Battery CR2032
- Data output
- Stainless steel
- Supplied with zero setting block

Range (Inch/mm)	Accuracy (Inch)	Resolution (Inch/mm)	INSIZE No.	Code
0-0.5/0-12.7	±0.0012	0.0005/0.01	2168-12	877152

Concentricity Gages



- Accuracy: 0.00008"

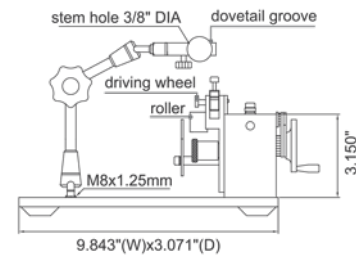
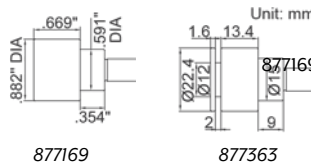

distance between measuring point and roller <1.181"

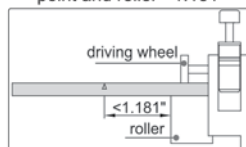

Applicable diameter	INSIZE No.	Code
0.138"-0.984"	4789-1E	877169
1mm-25mm	4789-3	877363

Chamfer Gage

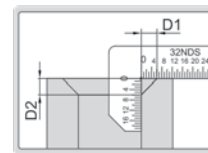
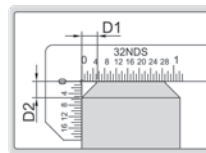
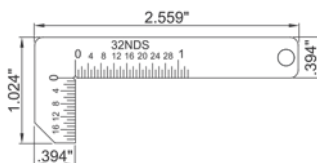

- To measure internal and external chamfers
- Stainless steel

Graduation	Accuracy	INSIZE No.	Code
1/32"	±0.01"	4844-1E	877174
0.5mm	±0.25mm	4844-1	877367

Chamfer Gage



- Measures 45° chamfer dimension
- Stainless steel
- Satin chrome plated reading surface

measure 45° chamfer dimension

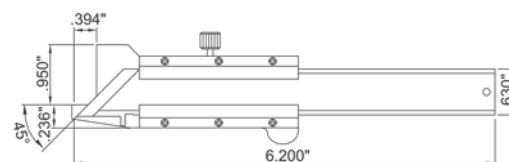
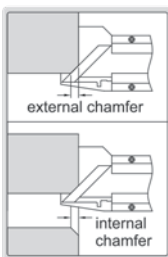

Range (Inch)	Graduation (Inch)	Accuracy (Inch)	INSIZE No.	Code
0-0.2	0.001	±0.003	1267-02	877127

Taper Gage Set



- Includes 4 pieces: 1/16 to 5/16", 21/64 to 9/16", 37/64 to 13/16", 53/64 to 1-1/16"
- Measures opening, slot width, hole diameter, etc.
- Diameter correction table on back
- Stainless steel

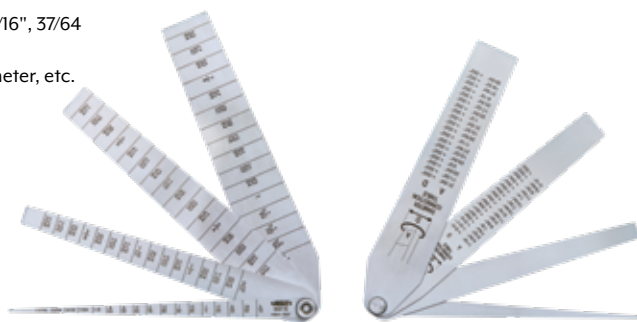
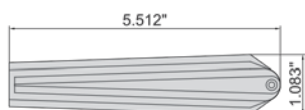

measure diameter of hole

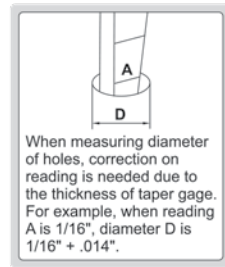

Range (Inch)	Graduation (Inch)	Accuracy (Inch)	INSIZE No.	Code
1/16 to 1-1/16	1/64	±0.004	4837-1E	877172

Taper Bore Gage



- Quick measurement of bore diameter
- Hardened steel, HRC50-58
- Satin chrome plated surface
- Aluminum oxide handle

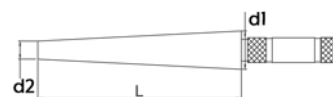

Graduation (Inch)	Accuracy (Inch)	L	Ø d1	Ø d2	INSIZE No.	Code
0.005	±0.0025	6.496	1.22	0.579	4852-E15	877175
0.005	±0.0025	6.4960	1.811	1.165	4852-E30	877176

American Standard Thread Ring Gages



Size	GO INSIZE No.	Code	NOGO INSIZE No.	Code
No. 4-40UNC	4121-41	284272	4121-41N	284340
No. 4-48UNF	4121-42	284273	4121-42N	284341
No. 5-40UNC	4121-51	284274	4121-51N	284342
No. 5-44UNF	4121-52	284275	4121-52N	284343
No. 6-32UNC	4121-61	284276	4121-61N	284344
No. 6-40UNF	4121-62	284277	4121-62N	284345
No. 8-32UNC	4121-81	284278	4121-81N	284346
No. 8-36UNF	4121-82	284279	4121-82N	284347
No. 10-24UNC	4121-101	284280	4121-101N	284348
No. 10-32UNF	4121-102	284281	4121-102N	284349
No. 12-24UNC	4121-121	284282	4121-121N	284350
No. 12-28UNF	4121-122	284283	4121-122N	284351
1/4-20UNC	4121-1B1	284285	4121-1BIN	284353
1/4-28UNF	4121-1B2	284286	4121-1B2N	284354
1/4-32UNEF	4121-1B3	284287	4121-1B3N	284355
1/4-36UNS	4121-1B4	877323	4121-1B4N	877324
5/16-18UNC	4121-5D1	284288	4121-5D1N	284356
5/16-24UNF	4121-5D2	284289	4121-5D2N	284357
3/8-16UNC	4121-3C1	284291	4121-3C1N	284359
3/8-24UNF	4121-3C2	284292	4121-3C2N	284360
7/16-14UNC	4121-7D1	284294	4121-7D1N	284362
7/16-20UNF	4121-7D2	284295	4121-7D2N	284363
1/2-13UNC	4121-1A1	284297	4121-1A1N	284365
1/2-20UNF	4121-1A2	284298	4121-1A2N	284366
9/16-12UNC	4121-9D1	284300	4121-9D1N	284368
9/16-18UNF	4121-9D2	284301	4121-9D2N	284369
5/8-11UNC	4121-5C1	284303	4121-5C1N	284371
5/8-18UNF	4121-5C2	284304	4121-5C2N	284372
11/16-16UN	4121-11D516	877321	4121-11D516N	877322
3/4-10UNC	4121-3B1	284307	4121-3B1N	284375
3/4-16UNF	4121-3B2	284308	4121-3B2N	284376
7/8-9UNC	4121-7C1	284310	4121-7C1N	284378
7/8-14UNF	4121-7C2	284311	4121-7C2N	284379
1-8UNC	4121-2A1	877325	4121-2A1N	877326
1-12UNF	4121-2A2	877327	4121-2A2N	877328
1 5/16-12UN	4121-5E512	877329	4121-5E512N	877330

Pin Gage Handles



- Wrench is needed to install pins
- Clamping bushes (0.2-7.14mm) are made of brass, clamping bushes (7.14-24.80mm) are made of aluminum



Applicable pin gage diameter (mm)	Includes Handle and Clamping Bush (mm)	INSIZE No.	Code
0.2-1.02	1 handle; 6 pairs (the clamping range are 0.2-0.38, 0.38-0.51, 0.51-0.64, 0.64-0.76, 0.76-0.89, 0.89-1.02)	7341-0S	877417
1.02-1.91	1 handle; 7 pairs (the clamping range are 1.02-1.14, 1.14-1.27, 1.27-1.40, 1.40-1.52, 1.52-1.65, 1.65-1.78, 1.78-1.91)	7341-1S	877434
1.91-3.33	1 handle; 8 pairs (the clamping range are 1.91-2.08, 2.08-2.26, 2.26-2.44, 2.44-2.62, 2.62-2.79, 2.79-2.97, 2.97-3.15, 3.15-3.33)	7341-2S	877435
3.33-4.57	1 handle; 7 pairs (the clamping range are 3.33-3.51, 3.51-3.68, 3.68-3.86, 3.86-4.04, 4.04-4.22, 4.22-4.39, 4.39-4.57)	7341-3S	877436
4.57-5.79	1 handle; 6 pairs (the clamping range are 4.57-4.78, 4.78-4.98, 4.98-5.18, 5.18-5.38, 5.38-5.59, 5.59-5.79)	7341-4S	877437
5.79-7.14	1 handle; 6 pairs (the clamping range are 5.79-5.99, 5.99-6.20, 6.20-6.40, 6.40-6.63, 6.63-6.88, 6.88-7.14)	7341-5S	877438
7.14-8.66	1 handle; 6 pairs (the clamping range are 7.14-7.39, 7.39-7.65, 7.65-7.90, 7.90-8.15, 8.15-8.41, 8.41-8.66)	7341-6S	877439
8.66-10.31	1 handle; 6 pairs (the clamping range are 8.66-8.92, 8.9-9.17, 9.17-9.42, 9.42-9.70, 9.70-10.01, 10.01-10.31)	7341-7S	877440
10.31-11.81	1 handle; 4 pairs (the clamping range are 10.31-10.67, 10.67-11.05, 11.05-11.43, 11.43-11.81)	7341-8S	877441
11.81-12.95	1 handle; 3 pairs (the clamping range are 11.81-12.19, 12.19-12.57, 12.57-12.95)	7341-9S	877442
12.95-14.71	1 handle; 4 pairs (the clamping range are 12.95-13.51, 13.51-13.89, 13.89-14.30, 14.30-14.71)	7341-10S	877418
14.71-16.13	1 handle; 4 pairs (the clamping range are 14.71-15.09, 15.09-15.49, 15.49-15.88, 15.88-16.13)	7341-11S	877419
16.13-17.88	1 handle; 4 pairs (the clamping range are 16.13-16.66, 16.66-17.07, 17.07-17.48, 17.48-17.88)	7341-12S	877420
17.88-19.3	1 handle; 4 pairs (the clamping range are 17.88-18.26, 18.26-18.67, 18.67-19.05, 19.05-19.30)	7341-13S	877421
19.3-24.8	1 handle; 8 pairs (the clamping range are 19.30-19.84, 19.84-20.62, 20.62-21.41, 21.41-22.23, 22.23-23.03, 23.03-23.80, 23.80-24.59, 24.59-24.80)	7341-15S	877422

Miniature Electronic Height Gage



- Measure height difference of two surfaces (I146-20B suitable for surfaces with barrier, such as rivet)
- Resolution: 0.01mm/0.0005"
- Buttons: on/off, zero, inch/mm
- Auto power off - move unit to turn power on
- Battery CR2032
- Data output
- Stainless steel

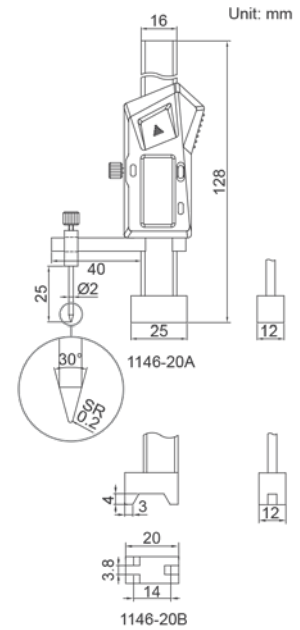

Range (Inch/mm)	Accuracy (mm)	INSIZE No.	Code
0-±0.8/0-±20	±0.02	I146-20A	877276
0-±0.8/0-±20	±0.02	I146-20B	877277

Electronic Taper Slot Gage



- Measure opening, slot width
- Resolution: 0.01mm/0.0005"
- Buttons: on/off, zero, inch/mm
- Auto power off - move unit to turn power on
- Battery CR2032
- Data output
- Stainless steel

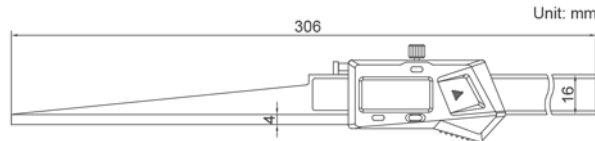

Range (Inch/mm)	Accuracy (mm)	INSIZE No.	Code
0.01-0.39/0.2-10	±0.03	I160-10	877279

Electronic Internal Caliper Gage



- Resolution .0002"/0.005mm
- Reading in digital and analog
- Display can be rotated by 170°
- Button function: tolerance Go and No-Go display, data preset, max./min. measurement, data holding, inch/metric conversion, absolute/incremental measurement
- Battery CR2032
- Data output
- Automatic power off

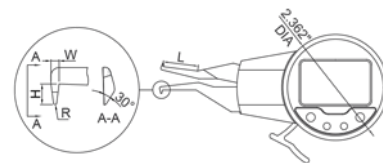

Range (Inch/mm)	Accuracy (Inch)	Repeatability (Inch)	L (Inch)	H (Inch)	W (Inch)	R (Inch)	INSIZE No.	Code
0.2-0.6/5-15	±0.0012	0.0004	0.787	0.079	0.059	0.012R	2121-15	283130
0.2-1.0/5-25	±0.0012	0.0004	1.378	0.059	0.039	0.012R	2121-25	283139
0.4-1.2/10-30	±0.0012	0.0004	2.165	0.217	0.098	0.020R	2121-31	283140
0.8-1.6/20-40	±0.0012	0.0004	3.150	0.236	0.118	0.020R	2121-41	283141
1.2-2.0/30-50	±0.0012	0.0004	3.150	0.315	0.118	0.020R	2121-51	283142

Electronic Edge Finder



- Shank electronically conducted to the metal workpiece through the chuck and table – LED illuminates and beeper sounds (816382 has beeper) when ball touches the workpiece
- Not suitable for rotary use
- Hardened shank and contact ball
- Battery: 23AE, 12V x 1 pc.



816381



816382

Shank Diameter (Inch)	Contact Ball Diameter (Inch)	Accuracy (Inch)	Beeper	INSIZE No.	Code
3/4	0.4	0.0002	No	6566-2E	816381
3/4	0.4	0.0002	Yes	6566-3E	816382

Edge Finder



- Hardened shank and contact point



Shank Diameter (Inch)	Contact Point Diameter (Inch)	Accuracy (Inch)	INSIZE No.	Code
3/8	0.2	0.0003	6567-1E	816383

Edge & Center Finders

- For accurate location of the starting point for all types of machine work and jig boring



Size	Model	Shank Diameter (Inch)	Code
A	Edge finder	3/8	450430
B	Edge finder	1/2	450432
C	Center finder	3/8	450434
D	Center finder	1/2	450436
E	Combo A&C	3/8	450438
F	Combo B&D	1/2	450440

Wiggler Set

- Versatile center and edge finder with four interchangeable attachments which snap conveniently into the chucking adapter
- Ball swivel joint allows adjustments to angular positions
- Set includes offset indicator holder, ball contact attachment 0.250" diameter, disc contact attachment 0.100" diameter and needle point attachment
- Supplied in storage case



Code

450445

Centering Indicator

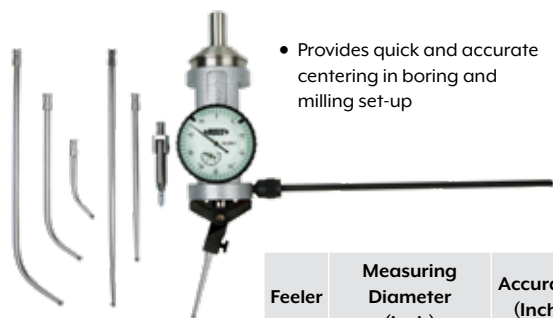

- Provides quick and accurate centering in boring and milling set-up

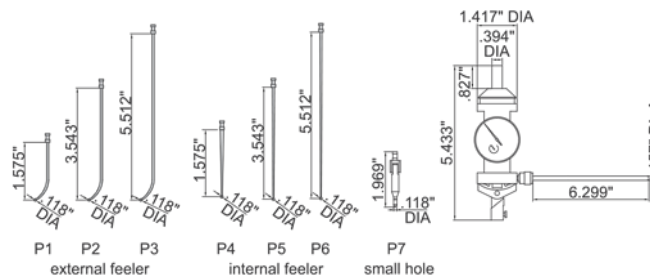

Feeler	Measuring Diameter (Inch)	Accuracy (Inch)
P1	0-2.362	±0.0015
P2	0-6.299	±0.0023
P3	0-9.843	±0.0031
P4	0.126-3.15	±0.0015
P5	0.126-7.087	±0.0023
P6	0.126-11.024	±0.0031
P7	0-0.11	±0.0015

INSIZE No.	Code
2385-3	284450

Dial Zero Setters

- 50mm setting height
- 0.01mm dial setting



Model	Style	Code
HP50A	Standard	242210
HP50B	Standard	242211
HP50AM	With magnetic base	242212
HP50BM	With magnetic base	242213

Dial Zero Setters



- Magnetic base

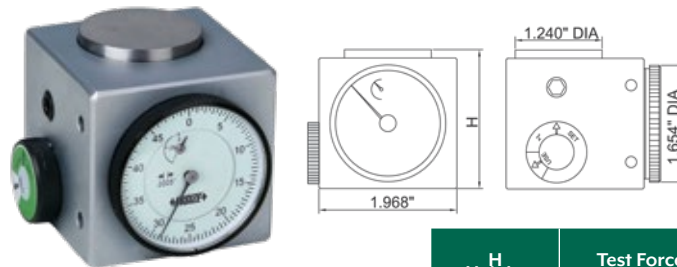

H Height (Inch)	Test Force (lbf)	Accuracy (Inch)	INSIZE No.	Code
2	2 (at 2")	±0.0004	2397-25A	284447

Electronic Zero Setters



- Resolution: 0.001mm/0.00005"
- IP65 dust/waterproof
- Buttons: on/off, mm/inch, zero
- CR2032 battery
- Automatic power off
- Magnetic base
- Automatic backlight at zero



H Height (mm)	Anvil stroke (mm)	Test Force (lbf)	Accuracy (Inch)	Repeatability	INSIZE No.	Code
50	2.5	10N (at 50mm)	±10µm/0.0004"	2µm	6557-50	877396

Ceramic Edge Finder

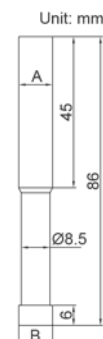

A Shank Ø (mm)	B Contact Point Ø (mm)	Accuracy	INSIZE No.	Code
10	10	8µm	6568-1	824500

Surface Roughness Comparator Set



Machining Method	Roughness (Ra)	Quantity
Flat lapping	0.05, 0.1, 0.2µm	3
	2, 4µin	
Reaming	0.4, 0.8, 1.6µm	3
	16, 32, 63µin	
Plain grinding	0.05, 0.1, 0.2, 0.4, 0.8, 1.6µm	6
	2, 4, 8, 16, 32, 63µin	
Horizontal milling	0.4, 0.8, 1.6, 3.2, 6.3, 12.5µm	6
	16, 32, 63, 125, 250, 500µin	
Vertical milling	0.4, 0.8, 1.6, 3.2, 6.3, 12.5µm	6
	16, 32, 63, 125, 250, 500µin	
Turning	0.4, 0.8, 1.6, 3.2, 6.3, 12.5µm	6
	16, 32, 63, 125, 250, 500µin	

- For checking, identifying and specifying the roughness by symbol
- Accuracy: +12% – -17%
- Meets ISO2632 standards
- Rust-proof
- Made from pure nickel
- Supplied in fitted storage case

INSIZE No.	Code
ISR-C5130-W	889480

Surface Roughness Comparator



Machining Method	Roughness	Quantity
Flat lapping	2, 4, 8µ	3
Reaming	16, 32, 63µ	3
Grinding	2, 4, 8, 16, 32, 63µ	6
Horizontal milling	16, 32, 63, 125, 250, 500µ	6
Vertical milling	16, 32, 63, 125, 250, 500µ	6
Turning	16, 32, 63, 125, 250, 500µ	6

- Economy set of 30 specimens - each 7/8" x 3/8", electro formed, solid nickel
- Ideal for draftsmen, engineers, machinists, etc.
- Each type of surface finish is truly and consistently reproduced, offering a realistic idea of the feel, appearance and texture of the machined components
- Conforms to S.A.E. and military specifications for visual and tactile inspections
- Instructions and graph correlating inch and metric surface finish values plus ISO "N" scale included
- Supplied in wallet

Code
445420

Surface Roughness Comparator



- Comparative standards for identifying the surface roughness of machined parts
- Supplied in pouch

Code
445421

Roughness Tester



Separable Type

- Operated with mobile phone (Android OS only) via Bluetooth, or PC via USB cable (cables and software included)
- Output data to MS Excel by connecting computer via Bluetooth or USB cable
- Connects to printer via bluetooth (optional)
- Tests 22 various roughness parameters
- Meets ISO, DIN, ANSI and JIS standards
- Displays roughness values, profile and curve on built-in screen
- Memory stores maximum 100 data measurement results
- Built-in rechargeable lithium battery with a working time of over 50 hours between charges
- Auto power off

INCLUDES ONE OF EACH: Roughness tester, Standard probe, Calibration block and support, Connection cable (long and short), Magnetic stand adapter, Adjustable stand, Touch pen, USB cable and software, AC/DC power adapter



Probe and main unit can be combined

Parameters		Ra, Rz, Rq, Rv, Rp, Rs, R3z, R3y, Rt, Rc, Rz (JIS), Rk, Rku, Rsm, Rpc, Rpk, Rvk, Rsk, Mr1, Mr2, Ry, Rmax
Range	X axis	0.689"
	Z axis	12598µin (-6299µin-6299µin)
Accuracy		±10%
Resolution (Ra)		0.01µin
Probe	Type	Inductive
	Stylus radius/angle	196µin/90°
	Stylus material	Diamond
Measuring force		0.01ozf
Measuring unit		µm/µin
Cut off		0.01/0.03/0.1"
Number of cut-offs		1 to 5
Traverse speed		0.005"/s, 0.02"/s, 0.04"/s
Memory		100 measurement results
Output		USB and bluetooth
Power		Built-in rechargeable battery
Dimension (L x W x H)		6.22 x 2.52 x 2.05"
Weight		0.89 lbs
INSIZE No.		ISR-C300
Code		877234

Roughness Tester



- 21 roughness parameters
- Display roughness values, profile and curve
- Memory of maximum 100 results
- Auto power off
- May be controlled by computer
- Data output

INCLUDES ONE OF EACH: Roughness tester, Standard probe, Calibration block and support, Adjustable stand, Probe cover, Software, AC/DC adapter



Parameters	Ra, Rz, Rq, Rv, Rp, RS, R3z, R3y, Rt, Rz (JIS), Rk, Rku, Rsm, Rpc, Rpk, Rvk, Rsk, Mr1, Mr2, Ry (JIS), Rmax	
Range	6299µin	
Accuracy	±10%	
Resolution (Ra)	0.01µin	
Probe	Type	Inductive
	Stylus radius/angle	196µin/90°
	Stylus material	Diamond
Measuring force	0.01ozf	
Measuring unit	µm/µin	
Cut off	0.01/0.03/0.1"	
Number of cut-offs	1 to 5	
Traverse speed	0.02"/s, 0.04"/s	
Memory	100 measurement results	
Output	USB	
Power	Built-in rechargeable battery	
Dimension (L x W x H)	5.55 x 2.16 x 1.57	
Weight	0.89 lbs	
INSIZE No.	ISR-C002	
Code	219180	

Roughness Tester



- Unit: µm, µin
- Auto power off

INCLUDES ONE OF EACH: Roughness tester, Calibration block, AC/DC adapter



Parameters	Ra, Rz, Rq, Rt	
Range	Ra, Rq: 2-590µin Rz, Rt: 4-1968µin	
Accuracy	±10%	
Resolution (Ra)	0.01µin	
Probe	Type	piezoelectric
	Stylus radius/angle	393µin/90°
	Stylus material	Diamond
Measuring force	0.012ozf	
Measuring unit	µm/µin	
Cut off	0.01/0.03/0.1"	
Evaluation length	0.05" for cut off 0.01"	
	0.15" for cut off 0.03"	
	0.2" for cut off 0.1"	
Traverse speed	0.03"/s	
Memory	100 measurement results	
Power	Built-in rechargeable battery	
Dimension (L x W x H)	4.17" x 2.75" x 0.94"	
Weight	0.44 lbs	
INSIZE No.	ISR-C003	
Code	219181	

Measuring Tool Sets



2 Piece Set



- **Set Includes:**
 - 1) Electronic caliper (817000) SPC, range 0-6"/0-150mm, resolution 0.0005"/0.01mm
 - 2) Electronic outside micrometer (289005 - without SPC), range 0-1"/0-25mm, resolution 0.00005"/0.001mm
- Supplied in fitted storage case

INSIZE No.	Code
5022	816345

2 Piece Set



- **Set Includes:**
 - 1) Dial indicator (816158), range 0-1", graduation 0.001"
 - 2) Magnetic stand with magnetic force 132lbf/60kgf (816252)
- Supplied in fitted storage case

INSIZE No.	Code
5002-4E	284505

2 Piece Set



- **Set Includes:**
 - 1) Dial test indicator, range 0.03", graduation 0.0005" (816170)
 - 2) Magnetic stand
- Supplied in fitted storage case

INSIZE No.	Code
5023-E	284501

2 Piece Set



- **Set Includes:**
 - 1) Electronic caliper, range 0-6"/0-150mm, resolution 0.0005"/0.01mm (817000)
 - 2) Electronic outside micrometer, range 0-1"/0-25mm, resolution 0.00005"/0.001mm (816500)
- Supplied in fitted storage case

INSIZE No.	Code
5022-E	877370

MEASURING TOOL SETS

Measuring Tool Sets



3 Piece Set



Set Includes:

- 1) Electronic caliper, range 0-6", resolution 0.001" (817000)
- 2) Outside micrometer, range 0-1", graduation 0.0001" (3202-1)
- 3) Steel rule, 6"/150mm (283596)

- Supplied in fitted storage case

INSIZE No.	Code
5003-IE	284514

3 Piece Set



Set Includes:

- 1) Dial caliper, range 0-6", graduation 0.001" (816028)
- 2) Outside micrometer, range 0-1", graduation 0.0001" (3202-1)
- 3) Steel rule, 6"/150mm (283596)

- Supplied in fitted storage case

INSIZE No.	Code
5003-1	284512

4 Piece Set



Set Includes:

- 1) Electronic caliper, range 0-6"/0-150mm, resolution 0.0005"/0.01mm (817000)
- 2) Outside micrometer, range 0-25mm, graduation 0.01mm (280994)
- 3) 90° beveled edge square, 100 x 70mm, grade 0 (283356)
- 4) Steel rule, 150mm/6" (283596)

- Supplied in fitted storage case

INSIZE No.	Code
5042-E	877371

5 Piece Set



Set Includes:

- 1) Electronic caliper, range 0-6"/0-150mm, resolution 0.0005"/0.01mm (817000)
- 2) Outside micrometer, range 0-25mm, graduation 0.01mm (280994)
- 3) Dial indicator, range 10mm, graduation 0.01mm (282663)
- 4) Magnetic stand (816252)
- 5) Micrometer stand (282455)

- Supplied in fitted storage case

INSIZE No.	Code
5051-E	877372

5 Piece Set

Set Includes:

- 1) Electronic caliper, range 0-6"/0-150mm, resolution 0.0005"/0.01mm (817000)
- 2) Electronic outside micrometer, range 0-1"/0-25mm, resolution 0.00005"/0.001mm (816500)
- 3) Electronic indicator, range 5"/12.7mm, resolution 0.0005"/0.01mm (877010)
- 4) Magnetic stand (816252)
- 5) Micrometer stand (282455)

- Supplied in fitted storage case

INSIZE No.	Code
5052-E	816350



6 Piece Set

- **Set Includes:**
 - 1) Electronic caliper, range 0-6"/0-150mm, resolution 0.0005"/0.01mm (817000)
 - 2) Outside micrometer, range 0-25mm, graduation 0.01mm (280994)
 - 3) 90° beveled edge square, 100 x 70mm, grade 00 (816304)
 - 4) Straight edge, 100mm (283471)
 - 5) Spring divider, 150mm (283897)
 - 6) Steel rule, 200mm/8" (283597)
- Supplied in fitted storage case

INSIZE No.	Code
5062-E	877373



9 Piece Set

- **Set Includes:**
 - 1) Electronic caliper, range 0-6"/0-150mm, resolution 0.0005"/0.01mm (817000)
 - 2) Outside micrometer, range 0-25mm, graduation 0.01mm (280994)
 - 3) Protractor, range 0-180°, graduation 1° (283329)
 - 4) Pitch gage, range 0.25-7mm, 24 pcs., metric 60° thread (283551)
 - 5) Radius gage, range 1-7mm (283564)
 - 6) Feeler gage, range 0.05-1mm, 20 pcs. (283528)
 - 7) 90° beveled edge square, 100x70mm, grade 0 (283356)
 - 8) Scriber (283972)
 - 9) Steel rule, 150mm/6" (283596)
- Supplied in fitted storage case

INSIZE No.	Code
5091-E	877374



13 Piece Set

- **Set Includes:**
 - 1) Electronic caliper (817000) SPC, range 0-6"/0-150mm, resolution 0.0005"/0.01mm
 - 2) Outside micrometer (INSIZE no. 3202-1), range 0-1", graduation 0.0001"
 - 3) Dial indicator (816158), range 1", graduation 0.001"
 - 4) Magnetic stand with magnetic force 132lbf/60kgf (816252)
 - 5) Protractor (283329), range 0-180°, graduation 1°
 - 6) Pitch gage (283552), range 4-42TPI, 30pcs, unified 60° thread
 - 7) Radius gage (283567), range 1/32"-1/4"
 - 8) Feeler gage (283543), range 0.0015"-0.035", 31pcs
 - 9) 90° beveled edge square (283356), 3.937" x 2.756", grade 0
 - 10) Scriber (283972)
 - 11) Steel rule (283596), 6"/150mm
 - 12) Depth base attachment (816046)
 - 13) Zero setting bar for depth base attachment
- Supplied in fitted storage case

INSIZE No.	Code
5013-E	816407



Portable Leeb Hardness Tester



Minimum reading	1HLD, 1HV, 1HB, 0.1HRC, 0.1HRB, 1HS, 1MPa	
Accuracy	±6HLD (when HLD = 800)	
Display	Leeb (HLD), converted hardness, material, impact direction, test times, average value, date	
Output	Bluetooth	
Applicable workpiece	minimum weight	11.02 lbs 4.41 lbs (on solid support) 0.22 lbs (coupled on plate)
	minimum thickness:	0.20"
	minimum radius of curved surface:	1.18"
	maximum roughness (Ra):	63µin
Power supply	3 x AAA batteries	
Dimensions (Inch)	5.91 x 3.31 x 1.10	
Weight (lbs)	0.44	
INSIZE No.	ISH-PHB	
Code	816432	



- Based on Leeb (HLD), converted to Vickers (HV), Brinell (HB), Rockwell (HRC and HRB), Shore (HS) and tensile strength (MPa)
- Memory of 99 measurement values for browsing
- Set measurement times (1-9) to have average value
- Connects to printer via bluetooth (printer optional)
- Automatic power off
- ASTM A956 standards
- Supplied with manufacturer inspection certificate

OPTIONAL ACCESSORIES: *Wireless printer
Couplant
Support rings
Hardness test block D*

Includes one of each:
Hardness tester
Impact device D
Hardness test block D
Small support ring
Cleaning brush

Applicable Material and Hardness Range for Impact Device D							
Material	HLD	HV	HB	HRC	HRB	HS	Tensile Strength (MPa)
Steel and Cast steel	300-900	81-955	81-654	20-68	38-100	32-100	375-2639
Tool steel	300-840	80-898	-	20-67	-	-	-
Stainless steel	300-800	85-802	85-655	-	46-101	-	-
Cast iron	360-650	-	93-334	-	-	-	-
Cast aluminum alloy	170-570	-	19-164	-	23-84	-	-
Brass	200-550	-	40-173	-	13-95	-	-
Bronze	300-700	-	60-290	-	-	-	-
Copper	200-690	-	45-315	-	-	-	-

Shore Durometer



- ISO868, ISO7619 and ASTM D 2240 standards
- With peak value indicator

OPTIONAL ACCESSORY: Test stand

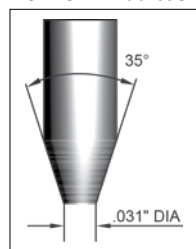

ISH-SAM



ISH-SDM



Scale	Shore A	Shore D
Application	Natural rubber, soft elastomer, etc.	Hard rubber, plastic, hard elastomer, etc.
Measuring range	10-90HA*	20-90HD
Graduation	1HA	1HD
Indenter protrusion	0.10"	
Dimensions (Inch)	4.53 x 2.36 x 0.98	
Weight (lbs)	0.35	
INSIZE No.	ISH-SAM	ISH-SDM
Code	816696	877432

*Use when measuring result is lower than 20HD

Portable Leeb Hardness Tester



Basic Model

- Impact device D
- Universal testing angle, no need to set impact direction
- Dual-coil probe, high accuracy
- Based on Leeb (HLD), converted to Vickers (HV), Brinell (HB), Rockwell (HRC, HRA and HRB), Shore (HS) and tensile strength (SGM) Dual value display, shows both Leeb and converted hardness
- High contrast digital LCD display
- Can choose large font display
- Automatically calculate maximum, minimum, average value Connected to PC via USB
- Save 999 data
- Operation temperature: -4°F-113°F
- According to ASTM A956, DIN 50156, GB/T 17394

Includes one of each:

- Hardness tester
- Hardness test block D
- Cleaning brush
- AAA battery
- Small support ring
- Software disc and USB cable



Resolution	1HLD, 1HV, 1HB, 0.1HRC, 0.1HRB, 0.1HRA, 0.1HS, 1SGM	
Accuracy	±6HLD (when HLD=800)	
Output	USB	
Measuring Range	HL 100-960/HRC 1-74.7/HRB 1.2-140/HB 28-1027/HV 45-1230 HS 4-112/HRA 7-88.5/SGM (rm) 118-3315N/mm ²	
Applicable workpiece	minimum weight	11.02lb (direct measurement) 4.41lb (on solid support) 0.11lb (coupled on plate)
	minimum thickness	0.2"
	minimum radius of curved surface	1.18"
	maximum roughness (Ra)	80µin
Power supply	1xAAA battery	
Dimensions (Inch)	5.83 x 1.77 x 0.83	
Weight (lbs)	0.23	
INSIZE No.	HDT-L411	
Code	877431	

Manual Rockwell Hardness Tester



- According to ISO 6508

Includes one of each:

- Hardness tester
- Ø60mm flat anvil
- Ø150mm flat anvil
- V-type anvil
- Diamond indenter
- Ø1.5875mm carbide ball indenter
- Hardness test block HRB88-95
- Hardness test block HRC60-65
- Hardness test block HRC20-30
- Anti-dust cover



Hardness scale	HRA, HRB, HRC, HRD, HRF, HRG
Preliminary test force	98N
Test force	588N, 980N, 1471N
Display	analogue
Stage elevation	manual
Load control	manual
Min. reading	0.5HR
Max. workpiece height	170mm
Max. testing width	165mm (from the center of indenter to the wall of main body)
Dimensions	520 x 160 x 700mm
Weight	60kg
INSIZE No.	ISH-R150
Code	889193

Electronic Microscopes



With Stand

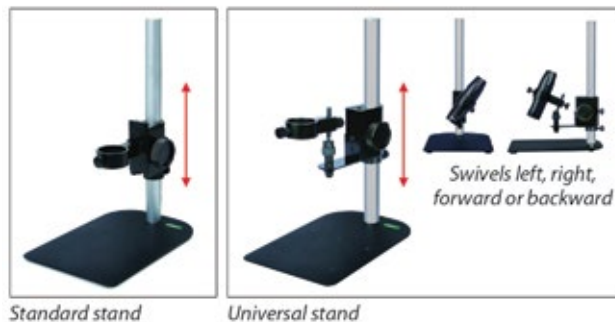
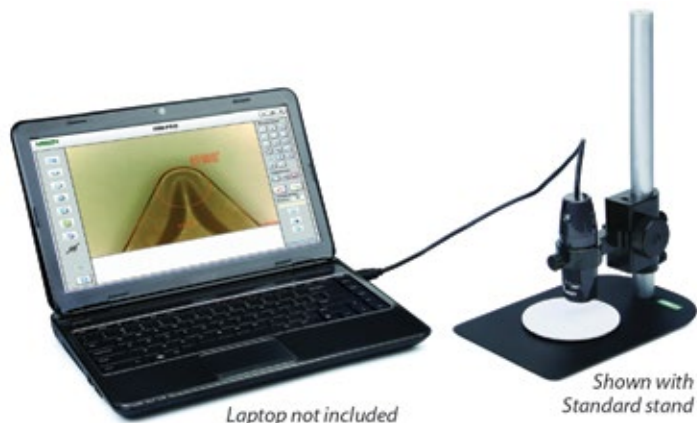

- Records photos and video
- Supplied with measuring software (requires Windows XP SP2, Vista, Windows 7, 8 or 10 operating system)
- Standard or Universal stand
- Magnification: 10x to 200x
- Pixels: 2M (resolution: 1600x1200)
- Built-in adjustable LED
- Power supply: USB 2.0 cable (voltage required: 5±0.1V)

- Includes one of each:**
- Microscope
 - Stand
 - White/Black plate
 - Focus support ring
 - Calibration rule (graduation 0.004"/0.1mm)
 - Calibration rule (graduation 0.039"/1mm)
 - ISM-PRO software CD



Screenshot of ISM-PRO software

Magnification, Focus Distance, View Field and Accuracy			
Magnification (Inch)	Focus Distance (Inch)	View Field (Inch)	Accuracy (mil)
50x	0.83	0.32 x 0.25	1.2
100x	0.51	0.15 x 0.12	0.6
150x	0.63	0.10 x 0.08	0.4
200x	0.75	0.07 x 0.06	0.3

Type	INSIZE No.	Code
Standard	ISM-PM200SA	285000
Universal	ISM-PM200SB	285007

WiFi Electronic Microscope



- Maximum working distance is 200" under WiFi mode
- May be connected to multiple iPads, Android devices or computers at the same time under WiFi mode
- Records photos and video
- Supplied with measuring software
- Magnification: 10X to 200X
- Pixels: 1.3M (resolution: 1280x1024)
- Built-in adjustable LED
- Power supply: built-in rechargeable battery

OPTIONAL ACCESSORIES:
Standard or Universal stand
Green, Yellow or Blue filters



- Includes one of each:**
- Microscope
 - Base support
 - Focus support ring 80X/150X
 - Focus support ring 60X/200X
 - Calibration rule (graduation 0.004"/0.1mm)
 - Calibration rule (graduation 0.039"/1mm)
 - USB cable and software
 - AC/DC adaptor

Optional:



Magnification, Focus Distance, View Field and Accuracy			
Magnification	Focus Distance (Inch)	View Field (Inch)	Accuracy (mil)
50x	0.83	0.32 x 0.25	1.2
100x	0.51	0.15 x 0.12	0.6
150x	0.63	0.10 x 0.08	0.4
200x	0.75	0.07 x 0.06	0.3

INSIZE No.	Code
ISM-WF200	816685

Electronic Microscopes



With Display

- 1080P high-definition image
- Built-in software without computer, operation by mouse
- Take pictures - saved to USB flash disk
- Measurement results can be output to Excel
- Automatic white balance and exposure
- Brightness, contrast ratio, gain are adjustable

Includes one of each:

- Microscope
- 0.5X camera adapter
- 1X auxiliary objective
- Calibration plate
- 15G USB flash disk
- White/black plate
- Mouse
- HDMI cable
- Power adapter



877229 without contour illumination



877230 with contour illumination

Magnification	15X-100X	
Sensor	1/2" CMOS	
Pixel	2M	
Resolution	1920 x 1080	
Frame rate	60fps	
Output	HDMI	
Power supply	power adapter	power adapter and 110V, 50/60Hz
Dimension (L x W x H)	22.44 x 11.81 x 16.93	
Weight	14.44 lbs	
INSIZE No.	ISM-DL300 without illumination	ISM-DL301-U with illumination
Code	877229	877230

Magnification, Focus Distance and View Field

Auxiliary Objective	Specification	Camera Adapter	
		0.5X (included)	1X (optional)
1X (included)	Magnification	15-100X	30-200X
	Focus distance	2.76±0.08"	2.76±0.08"
	View field	0.63 x 0.43 - 0.1 x 0.06"	0.31 x 0.21 - 0.05 x 0.03"
2X (optional)	Magnification	30-200X	60-400X
	Focus distance	1.14±0.08"	1.14±0.08"
	View field	0.31 x 21 - 0.05 x 0.03"	0.15 x 0.11 - 0.024 x 0.016"

Measuring Accuracy

Magnification	Measuring Accuracy (Inch)
15X	±0.00031
30X	±0.00024
50X	±0.00024
80X	±0.00016
100X	±0.00016
>100X	±0.00016

Granite Surface Plates



Tool Room Grade Black Granite

Size (Inch)	Thickness (Inch)	Overall Accuracy (Inch)	Weight (lbs/kgs)	Code
12 x 12	2	± 0.0001	34/15	847104
12 x 18	4	± 0.0001	98/44	847106
18 x 18	4	± 0.0001	146/66	847108
18 x 24	4	± 0.00015	195/88	847110
24 x 24	3	± 0.00015	195/88	847114
24 x 36	4	± 0.0002	389/176	847116
30 x 48	4	± 0.0003	646/293	847120
36 x 36	4	± 0.0002	580/263	847122
36 x 48	6	± 0.0004	1162/527	847124
48 x 72	8	± 0.0007	3098/1405	847136

Inspection Grade Black Granite

Size (Inch)	Thickness (Inch)	Overall Accuracy (Inch)	Weight (lbs/kgs)	Code
18 x 24	4	± 0.000075	195/88	847160
24 x 36	4	± 0.0001	389/176	847166
36 x 48	6	± 0.0002	1162/527	847174

Steel Stands

For Granite Surface Plates

- Supplied with levelling screws
- Casters available upon request



Surface Plate Cleaner



Description	Code
Pint	604190
Pint spray pump	604191
Quart	604192
1/2 gallon	604193
Gallon	604194

Size (Inch)	Code
18 x 18	844008
18 x 24	844010
20 x 30	844012
24 x 24	844014
24 x 36	844016
24 x 48	844018
30 x 48	844020
36 x 36	844022
36 x 48	844024
36 x 60	844026
36 x 72	844028
48 x 48	844032
48 x 60	844034

NOTE: Please indicate required height when ordering

Three Way Magnifier

With Illumination

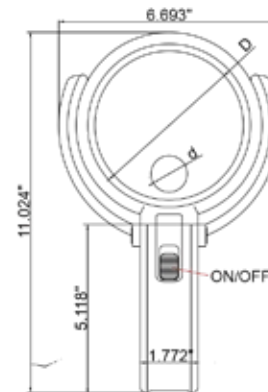
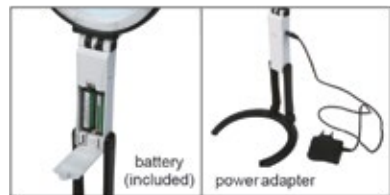
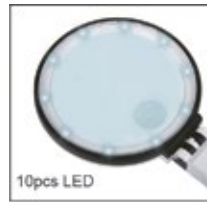

- Plastic lens
- Powered by 2 x AA batteries (included) or power adapter (110-240V, 50-60Hz)

three ways



Magnification	D Ø Lens (Inch)	d Ø Lens (Inch)	INSIZE No.	Code
2X/4X	4.724	1.102	7512-1	816387

Magnifiers

With Illumination



816388

816389

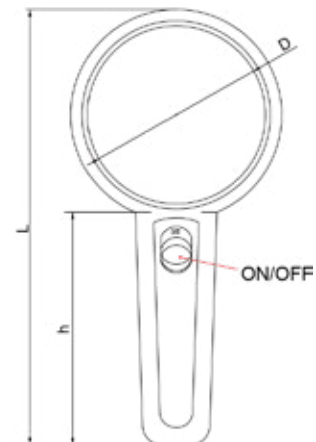

- Glass lens
- Powered by 3 x AAA batteries (included)

Magnification	D Ø Lens (Inch)	L (Inch)	h (Inch)	INSIZE No.	Code
2X	2.953	6.693	3.543	7513-2	816388
4X	1.969	5.709	3.543	7513-4	816389

Magnifier Work Lights

- Modern silver work lights with articulating arm
- Designed with a 5" diameter magnified optical lens with 5" diameter luminous head gives 5 diopter of magnification – 2.25x larger than actual object ("DIOPTER" | This refers to the amount of curvature a lens will have. More curvature means a thicker lens, more magnification and a higher diopter number. A 5-diopter lens = $5/4 + 1...$ or $1.25 + 1 = 2.25x$. Objects viewed under a 5 diopter lens will appear 225% larger than normal)
- One piece fabricated PC front shade
- Low power consumption only 14 watt LED 5700K
- Low heat emissions
- Ideal for assembly, workshop, or office applications
- Equipped with LED driver to connect to AC power (100V-240V) (50Hz/60Hz) with plug (For high voltage)
- Furnished with 1.8 meter (70") cord
- Brightness adjustment range 10-100%



LED Diffuser Included

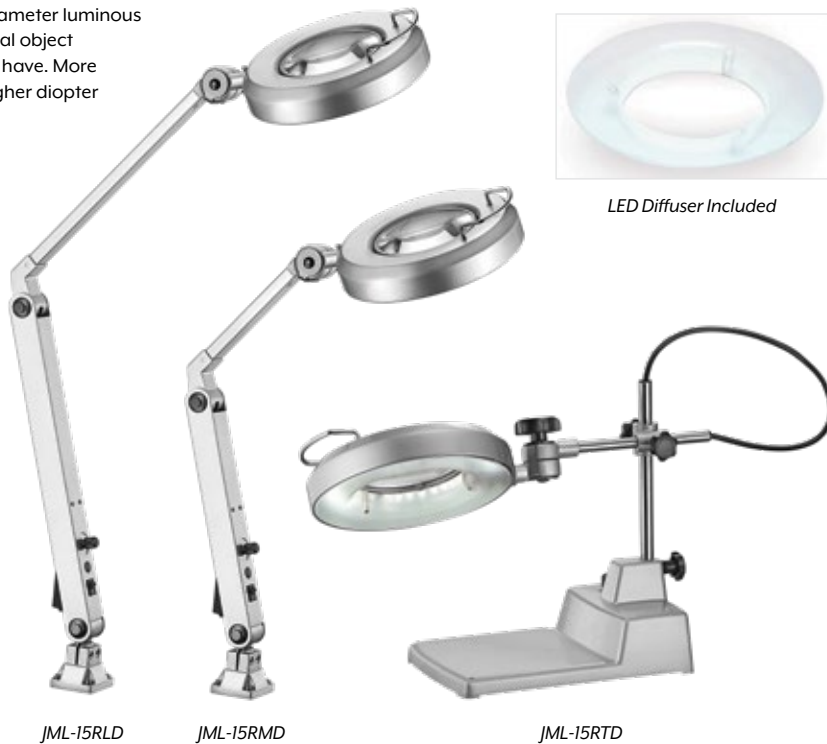

DIMENSIONS

Unit:mm

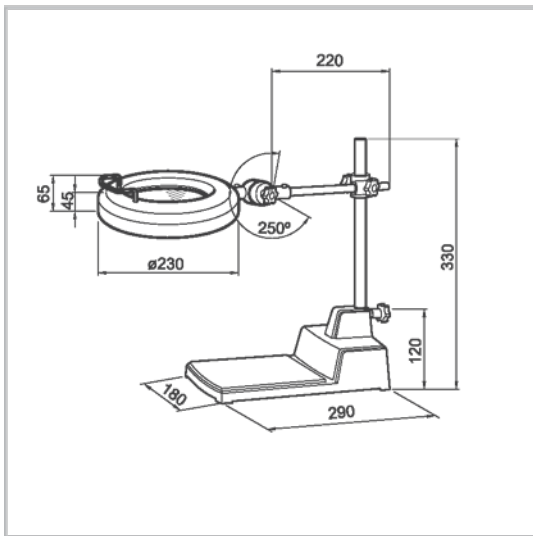

Built in LED Driver to connect to AC power

- High voltage power 100V-240V with plug

Model	Reach (Inch)	Code
JML-15RMD	Medium Arm	302302
JML-15RLD	Long Arm	302303
JML-15RTD	Bench Top	302301

DIMENSIONS

Unit:mm

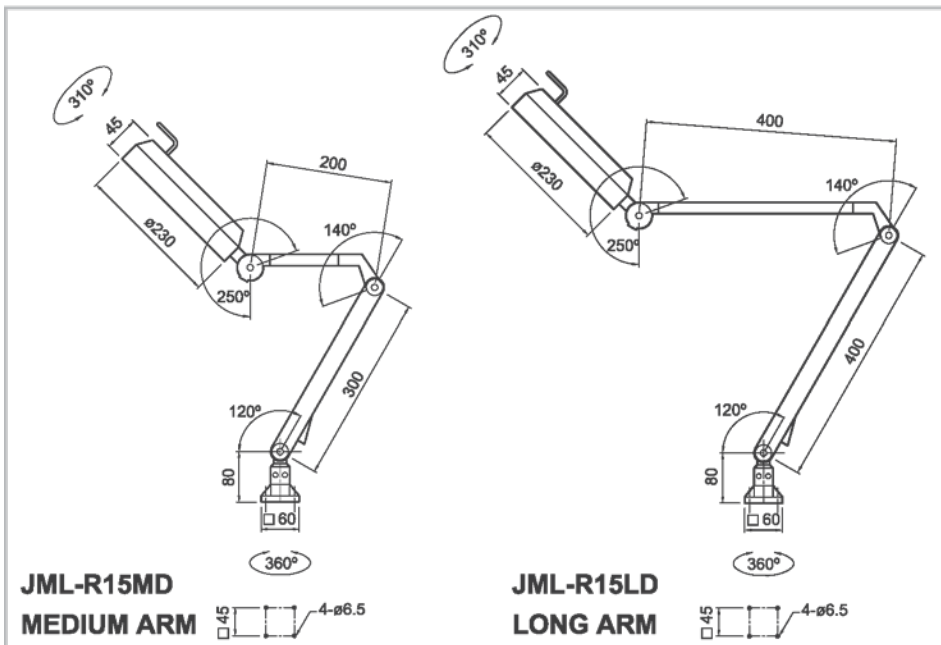

Table Magnifier

With Illumination



- LED illumination, working life 20000h
- Clamping holder range: 0.394"-2.362"

Magnification	2.25X
Diopter	5D
Lens diameter	4.803
Illumination	power: 7W, illuminance: 420lm
Power supply	100-240V, 50-60Hz
INSIZE No.	7516-5D-U
Code	877214

Loupes



Model	Description	Code
1962	Loupe 15x High resolution achromat 3-element, 2-piece construction. The clear acrylic skirt of this powerful universal loupe work to be brightly illuminates.	730101
1966	Loupe 10x Kelliner type with 3-element, 2-piece construction. Accurate measurements can be made by turning the focusing ring so both object and scale can be seen.	730103
1975	Scale Loupe 7x Inspection convenience is improved by adding a removable light to this 7x loupe.	730105
1976	Scale Loupe 7x Set 4-element, 2-piece, coated. High resolution and wide field of view makes scale reading easy.	730107
1983	Scale Loupe 10x A scale loupe 10x	730109
2004	Scale Loupe 10x Set A scale loupe 10x with five most popular scales in a plastic case	730113



Telescoping Inspection Mirrors

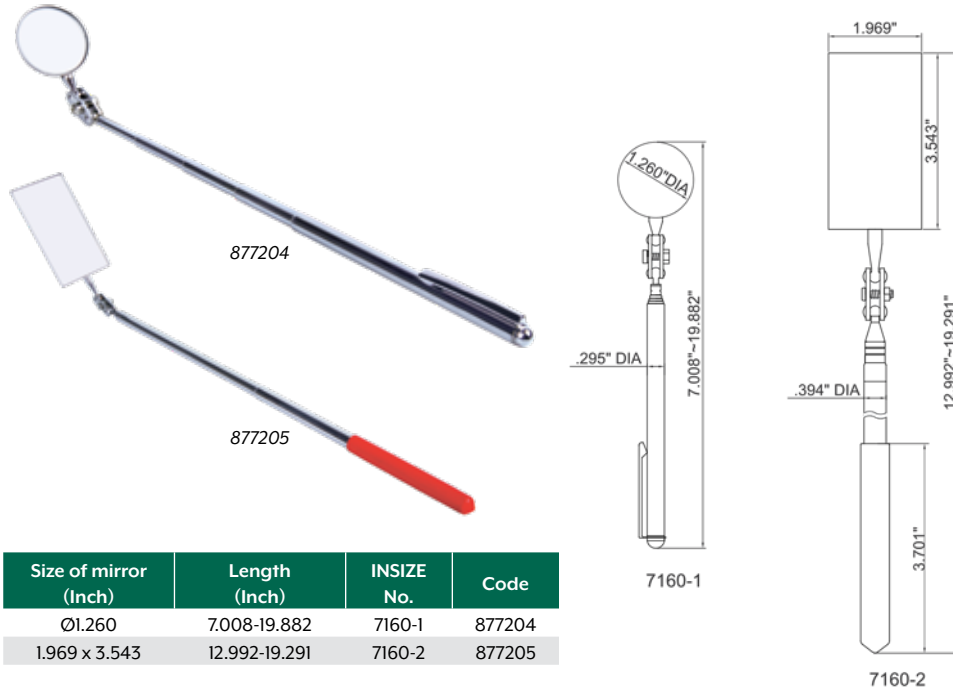

Size of mirror (Inch)	Length (Inch)	INSIZE No.	Code
Ø1.260	7.008-19.882	7160-1	877204
1.969 x 3.543	12.992-19.291	7160-2	877205

Telescoping Inspection Mirror with LED



- Inspect hidden areas
- Head can bend and rotate
- Telescoping handle, made of stainless steel
- With two CR2032 batteries

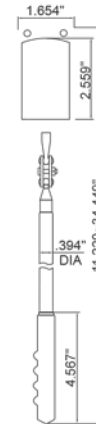

Size of mirror (Inch)	Length (Inch)	INSIZE No.	Code
2.559 x 1.654	11.22-34.449	7162-1	877409

Folding Magnifier



Magnification	Lens Diameter (Inch)	INSIZE No.	Code
10X	0.827	7511-8	877424

LOUPES & MAGNIFIERS

Folding Magnifier

With Illumination



- Resin lens
- Powered by 2xCR1620 batteries (included)
- LED lights up automatically when α is over 130°



Magnification	Lens Diameter (Inch)	INSIZE No.	Code
2.5X	1.772	7514-1	877425

Folding Magnifier

With Illumination



- Resin lens
- Powered by 3xLR927 batteries (included)

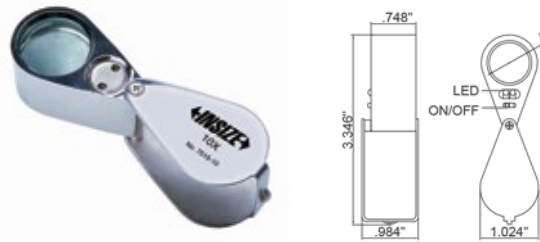

Magnification	Lens Diameter (Inch)	INSIZE No.	Code
10X	0.867	7515-10	877426

Magnification Glasses



- Resin lens
- Interchangeable lenses
- Powered by 3 pcs AAA batteries (included)



Lens number	Magnification	INSIZE No.	Code
5 pcs	1X	7523-3D5	877427
	1.5X		
	2X		
	2.5X		
	3.5X		

Electronic Horizontal Scales



type A

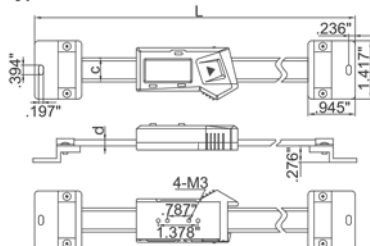

type B

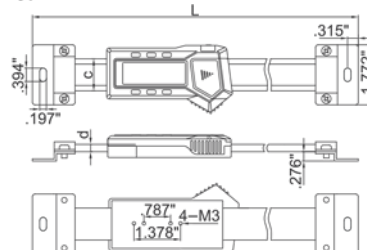

- Resolution: 0.0005"/0.01mm
- Buttons: on/off, zero, inch/mm
- Auto power off - move unit to turn power on
- Battery CR2032
- Data output
- Stainless steel
- Supplied with bracket to be mounted on back

- Resolution: 0.0005"/0.01mm
- Button function: on/off, zero, inch/mm, ABS, data preset
- Absolute and incremental measurement
- Battery CR2032
- Data output
- Stainless steel
- Supplied with bracket to be mounted on back

Range (Inch/mm)	Type	Accuracy (Inch)	L (Inch)	c (Inch)	d (Inch)	INSIZE No.	Code
4/100	A	±0.001	8.465	0.63	0.157	7101-100A	284454
8/200	A	±0.0012	12.402	0.63	0.157	7101-200A	284456
12/300	A	±0.0015	17.520	0.63	0.157	7101-300A	284457
16/400	B	±0.002	23.228	0.945	0.217	7101-400A	284458
32/800	B	±0.0039	38.976	0.945	0.217	7101-800A	284462
40/1000	B	±0.0039	46.85	1.22	0.413	7101-1000A	877200

SCALES

Electronic Vertical Scales



- Non waterproof
- Resolution: 0.01mm/0.0005"
- Buttons: on/off, zero, mm/inch,
- ABS/INC, data hold, TOL, set
- Battery LR44, data output
- Made of stainless steel
- Supplied with bracket to be mounted on the back

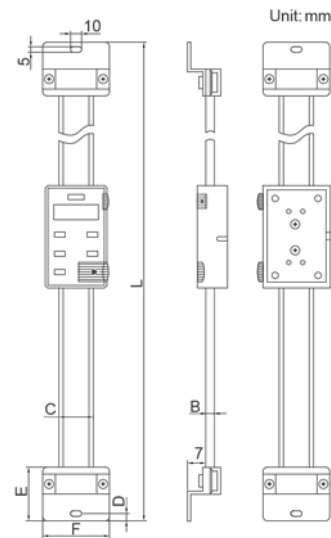

Range (Inch/mm)	Accuracy (mm)	B (mm)	C (mm)	D (mm)	E (mm)	F (mm)	L (mm)	INSIZE No.	Code
6/150	±0.03	4	20	6	24	40	296	7102-150	284469

Counting Scales



- LCD display, with backlight
- Zero-setting, subtracting tare value, counting, accumulation, checking alarm
- Overload alarm
- Units: lb, lb-oz, kg, g, tj, hj

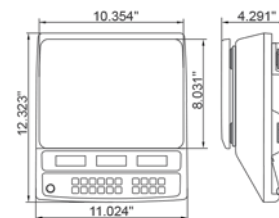

Maximum weighing	30lb/15kg	60lb/30kg
Minimum weighing	0.22lb/10g	0.044lb/20g
Resolution (d)	0.001lb/0.5g	0.002lb/1g
Accuracy (m is load)	m ≤ 5.5lb: ±.005lb 5.5lb < m ≤ 22.0lb: ±.01lb m > 22.0lb: ±.015lb	m ≤ 11.0lb: ±.01lb 11.0lb < m ≤ 44.0lb: ±.02lb m > 44.0lb: ±.03lb
Output	No	
Operation temperature	14-104°F	
Power	rechargeable battery (6V/3.2Ah), power adapter (12V/500mA)	
Dimensions of pan	10.354" x 8.031"	
INSIZE No.	8101-15	8101-30
Code	877429	877430

Stroke Counter



- Accumulate and record the number of mechanical movements
- Rotate back to zero

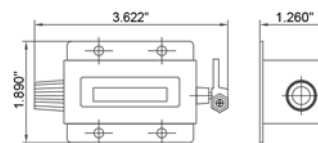

Number of digits	Range	INSIZE No.	Code
6	0.999999	7600-6	877428

Angle Plates

630



Blocks & Parallels

631-639



Set-Up Tools

640



Straight Edges

641

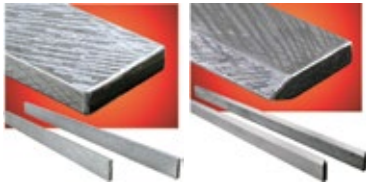

Key Stock & Shim Stock

642-643



Magnets

644-645



Slotted Angle Plates

Webbed & Open Ends – Precision Ground & Machined Finish – High Grade Cast Iron FC25

- These slotted angle plates have convenient clamping slots for mounting and are widely used for machining, layout and inspection
- Made from high grade FC25 cast iron
- Modifications may be required to meet specific requirements as tolerances on angle plates range widely

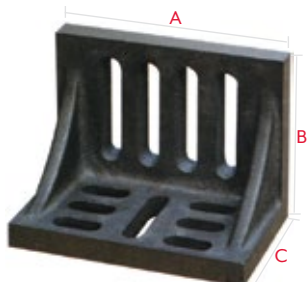

Type A – Webbed End

A (Inch)	B (Inch)	C (Inch)	Approximate Weight lbs (kg)	Ground	Machined
				Code	Code
3-1/2	3	2-1/2	2 (0.8)	217653	272212
4-1/2	3-1/2	3	3 (1.5)	217654	272213
6	5	4-1/2	8 (3.5)	217655	272214
7	5-1/2	4-1/2	11 (5)	217656	272215
8	6	5	15 (7)	217657	272216
9	7	6	22 (10)	217658	272217
10	8	6	26 (12)	217659	272218
12	9	8	55 (25)	217660	272219
GIANT SIZES					
16	12	9	110 (50)	272245	272241
20	16	12	190 (86)	272246	272242

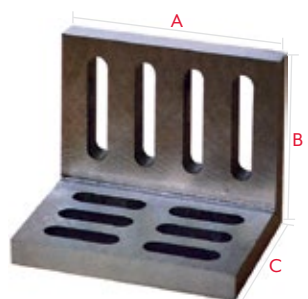

Type B – Open End

A (Inch)	B (Inch)	C (Inch)	Approximate Weight lbs (kg)	Ground	Machined
				Code	Code
4-1/2	3-1/2	3	3.5 (1.6)	217661	272221
6	5	4-1/2	10 (4.5)	217662	272222
7	5-1/2	4-1/2	12 (5.5)	217663	272223
8	6	5	15.5 (7)	217664	272224
9	7	6	20 (9)	217665	272225
10	8	6	32 (14.5)	217666	272226
12	9	8	53 (24)	217667	272227

Plain (Non-Slotted) Angle Plates

Precision Ground & Machined Finish – High Grade Cast Iron FC25



Dimensions (Inch)	Approximate Weight lbs (kg)	Ground	Machined
		Code	Code
2 x 2 x 2	1.1 (0.5)	272231	272250
3 x 3 x 3	2.4 (1.1)	272232	272251
4 x 4 x 4	5.5 (2.5)	272233	272252
5 x 5 x 5	8.8 (4)	272234	272253
6 x 6 x 6	15.4 (7)	272235	272254
8 x 8 x 8	29 (13)	272236	272255
10 x 10 x 10	57 (26)	272237	272256
12 x 12 x 12	96 (43.5)	272238	272257

Positioning Blocks



- Matched pairs
- Tapped holes are provided for clamping operations
- Precision ground and hardened on all 6 sides
- Versatile for precision grinding layout work, etc.
- Squareness of all sides is within 0.0001"

Size (Inch)	Tapped Hole	Code
1-2-3	3/8-16	440415
2-4-6	5/8-11	460170

BLOCKS & PARALLELS

Toolmaker's V-Block & Clamp Sets

Chrome Steel



- Made from finely selected tool steel fully hardened to 55-60 HRC
- Manufactured and numbered in matched pairs - each pair has two 90 degree V's of different capacities which are identical to the V's of its matching block
- V's are ground central, parallel and square with the ends and sides
- Used for holding work securely during drilling, milling and grinding applications and also in layout and inspection work
- Each pair supplied with rigid and robust clamps

Height (Inch)	Width (Inch)	Length (Inch)	V1 Width of Small "V" (Inch)	V2 Width of Large "V" (Inch)	Capacity (Inch)	Code
1-1/4	1-1/4	1-19/32	7/16	13/16	1	384801
1-1/2	1-1/2	2	1/2	1-3/32	1-1/4	384802
1-7/16	1-3/4	2-3/4	11/16	1-5/16	1-1/2	384803
3	3	4	1-3/16	2-5/32	3	384804

V-Blocks



- All V-blocks are parallel, square and centered within 0.0002"
- Each block comes with one clamp
- Sold in pairs

Height (Inch)	Width (Inch)	Length (Inch)	Minimum V-Block Capacity (Inch)	Maximum V-Block Capacity (Inch)	Code
1-3/16	1-3/8	1-3/8	1/8	19/32	302242
2	2-3/8	2-3/8	13/64	1-3/16	302243
3-1/16	4-1/8	3-1/8	9/32	2-9/16	302244

V-Blocks



- Hold cylindrical work pieces for inspection and machining
- Hardened to HRC 60±2
- Parallelism of both v-grooves to top and bottom: 0.0002"
- Squareness of both v-grooves to front and back: 0.0002"
- Height difference of a matched pair: 0.0002"
- V-groove on top for large shafts
- V-groove on bottom for small shafts

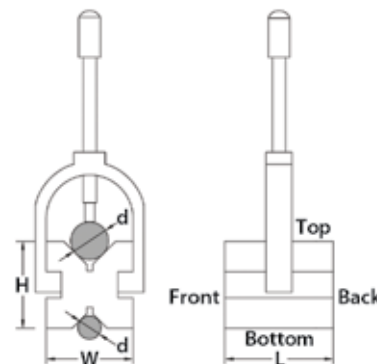
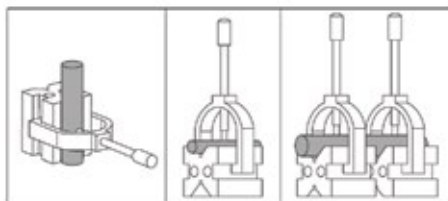

Description	Length x Width x Height (Inch)	d Range of Shafts (Inch)	INSIZE No.	Code
Matched pair	1.97 x 1.57 x 1.57	Ø0.2 to 1.18	6896-11	889455
Matched pair	3.15 x 2.48 x 2.48	Ø0.28 to 2.48	6896-12	889456
Matched pair	3.94 x 3.15 x 3.15	Ø0.28 to 3.15	6896-13	889457

V-Blocks

Machined Faces



- Matched and numbered pairs
- V-Blocks provide a useful means of holding cylindrical work for layout, inspection, drilling and machining
- Each pair is accurately machined with 90° V which is centered in true and square and parallel with the base to within .001" (0.03mm)

Width Inch (mm)	Height Inch (mm)	Thickness/Pair Inch (mm)	Capacity Inch	Weight (kg)	Code
2 (51)	1-1/4 (32)	1-7/8 (48)	1-1/4	0.9	390822
3 (76)	2-3/8 (60)	2-5/8 (67)	2-1/2	2.5	390823
4 (102)	2-5/8 (67)	3-1/4 (82)	3	5.0	390824
5 (127)	3-1/8 (79)	4 (102)	3-1/2	8.0	390825
6 (152)	3-1/2 (89)	5 (127)	4	15.0	390826
7 (178)	4-1/2 (114)	6 (152)	5	28.0	390827
8 (203)	5-1/2 (140)	8 (203)	6	44.0	390828
10 (254)	6-1/2 (165)	10 (254)	6-1/2	69.0	390830
12 (305)	8 (203)	12 (305)	7	127.0	390832

Magnetic V-Blocks

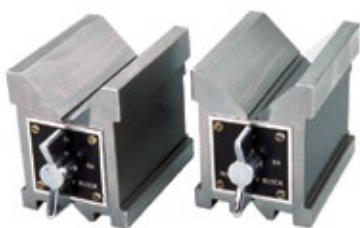

Description	Length x Width x Height (Inch)	Code
Single	4 x 3 x 3-3/4	435541
Matched pair	4 x 3 x 3-3/4	435542

Magnetic V-Block



- Squareness of V groove to back side .0004"
- Parallelism of V groove to top, bottom, left and right sides .0004"
- Hold cylindrical workpieces for inspection and machining
- Supplied in single piece
- Not hardened
- Not suitable for steel or iron surface, otherwise the magnetic force will be reduced

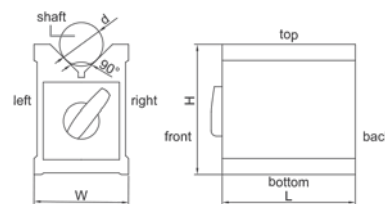

Description	Length x Width x Height (Inch)	d Range of Shafts (Inch)	Magnetic Force (lbf)	INSIZE No.	Code
Single block	2.8 x 2.4 x 2.9	0.24-1.73 Diameter	123	6890-702	283748



Magnetic V-Blocks



- Hold cylindrical workpieces for inspection and machining
- Parallelism of v-grooves to top, bottom, left, and right side: 0.0004"
- Squareness of v-grooves to back side: 0.0004"
- V-groove on top for large shafts
- V-groove on bottom for small shafts
- Not suitable for steel or iron surfaces

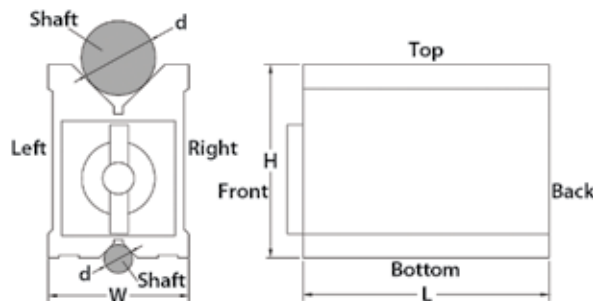

Description	Length x Width x Height	d Range of Shafts	Magnetic Force	INSIZE No.	Code
Single block	3.1" x 2.8" x 3.7"	Ø0.24" to 2.64"	14llbf	6801-1201	877035
Single block	100mm x 70mm x 95mm	Ø6-67mm	80kgf	6801-1202	283754
Single block	120mm x 70mm x 95mm	Ø6-67mm	96kgf	6801-1203	283755

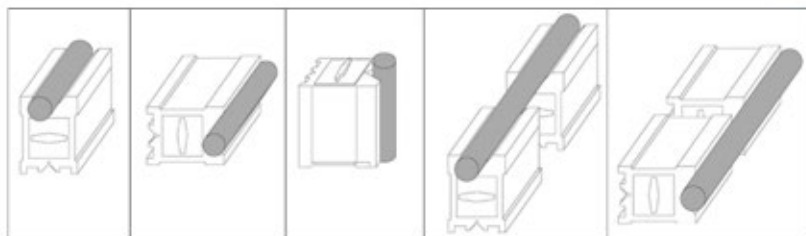
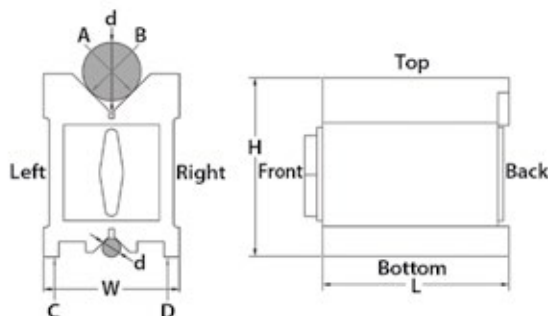
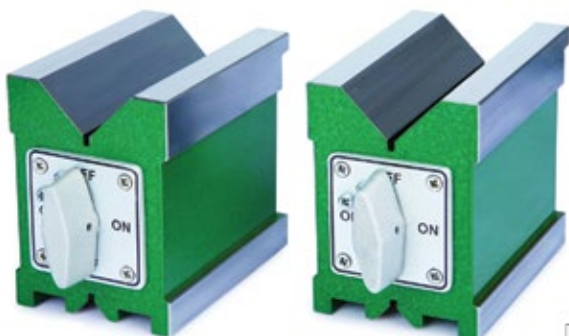

- Hardened with high accuracy and strong magnetic force
- For grinding, light milling, drilling and inspection of round and square jobs
- Working surfaces hardened to HRC60±2
- Magnetic force on top, bottom and two v-grooves
- Suitable for cast iron and/or granite surface plates
- Parallelism of v-grooves to top, bottom, left, and right side: 0.0002"
- Squareness of v-grooves to back side: 0.0002"
- Height difference of a matched pair: 0.0002"
- V-groove on top for large shafts
- V-groove on bottom for small shafts
- Suitable for cast iron and granite surface plates

Description	Length x Width x Height (Inch)	d Range of Shafts (Inch)	Magnetic Force (lbf)	INSIZE No.	Code
Matched pair	3 x 2.2 x 3	Ø0.2 to 1.57	165	6889-1	877036

BLOCKS & PARALLELS

Magnetic V-Block Sets

- Hold cylindrical workpieces for inspection, not suitable for machining due to low magnetic force
- Parallelism of V groove to bottom and back sides: 10µm
- Height difference of a matched pair: 10µm
- Two V-blocks per set
- Hardness HRB70

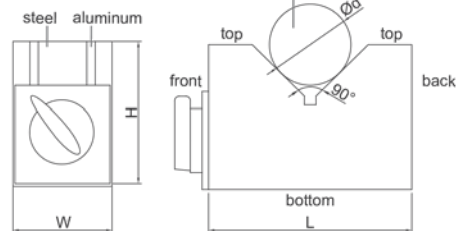

Length x Width x Height (mm)	Ød Range of Shafts (mm)	Magnetic Force (kgf)	INSIZE No.	Code
70 x 40 x 50	6-46	8	6891-1	283758
150 x 50 x 100	6-125	14	6891-3	283760

V-Block Sets



- Hold cylindrical work pieces for inspection and machining
- Hardened to HRC 60±2
- Parallelism of both v-grooves to top and bottom: 3µm
- Squareness of both v-grooves to front and back: 3µm
- Height difference of a matched pair: 3µm
- V-groove on top for large shafts
- V-groove on bottom for small shafts

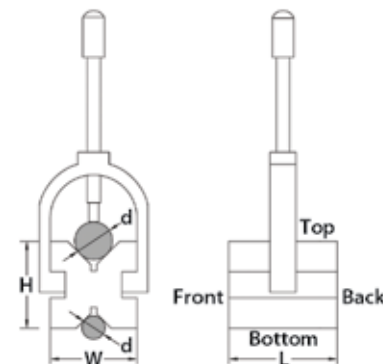
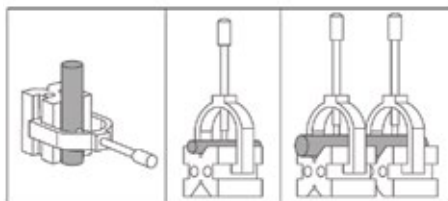

Description	Length x Width x Height (mm)	Ød Range of Shafts (mm)	INSIZE No.	Code
Matched pair	25 x 20 x 20	3-20	6896-10	877407

Roller Bearing V-Blocks



- Bearings prevent damage to the work piece
- Suitable for heavy work pieces (load capacity: 1100 lbs)
- Parallelism of bearings to bottom (when two v-blocks are closed): 0.0002"

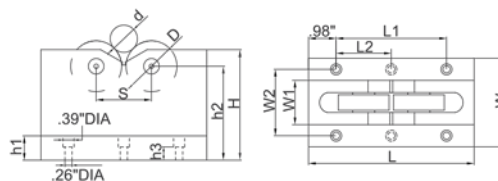
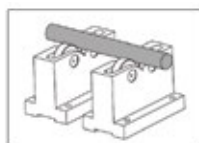

W1 (Inch)	W2 (Inch)	h1 (Inch)	h2 (Inch)	h3 (Inch)	L1 (Inch)	L2 (Inch)	S (Inch)	INSIZE No.	Code
0.87	1.73	0.79	3.35	0.47	3.94	-	2.36	6888-1	877034
1.57	2.36	0.87	3.35	0.47	3.94	-	1.97	6888-2	877198
2.36	3.15	1.18	4.88	0.79	7.09	3.54	4.72	6888-3	877199

Length x Width x Height (Inch)	D Diameter of Bearings (Inch)	d Range of Shafts Diameter (Inch)	Load Capacity (lbs)	INSIZE No.	Code
5.9 x 2.4 x 3.9	1.65	0.98-2.76	1100	6888-1	877034
5.9 x 3.1 x 3.9	1.85	0.2-2.17	2200	6888-2	877198
9.1 x 3.9 x 5.9	2.83	2.76-7.87	2200	6888-3	877199

Adjustable V-Blocks

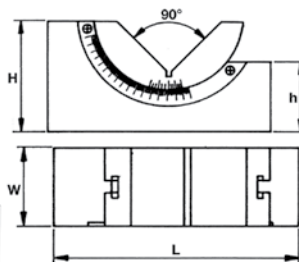
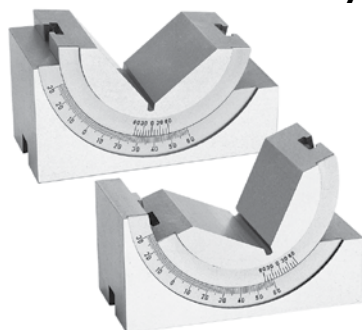

- Hardness: 50-54 RC
- Squareness: within 0.005mm
- Tolerance of angle: $\pm 10''$
- Adjustable: 0° to 60°

BLOCKS & PARALLELS

Model	H Height (mm)	W Width (mm)	L Length (mm)	h Height (mm)	Weight (kg)	Code
AP1	47	46	102	28	1.5	547601
AP2	47	30	102	28	1.0	547602
AP3	32	25	75	22	0.5	547603

Ultimate V-Block & Clamp



- An improved v-block and clamp with extra features
- Overall Length: 3-1/2" (89mm)
- Length of V-Block Surface: 2" (50mm)
- Overall Width: 1-7/8" (48mm)
- Height of V-Block: 1-7/8" (48mm)
- Height of V-Block with Clamp: 4-1/4" (107mm)
- Maximum Capacity: 1-5/16" (33mm)

Code
180300



SHAVIV is a world leader in hand-deburring solutions for a wide range of metal, plastic and wood materials.

KAR is the exclusive supplier of SHAVIV products in Canada.

Product Categories include:

Blades

Handles

Holders

Sets

SEE CUTTING TOOLS

Parallels

Ground Steel – 4-Way – In Pairs

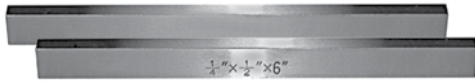

Tolerances			
Length	Width & Height Ground to Size Within	Total Parallelism & Straightness Over Entire Length	Total Size Tolerance Between a Pair
6"	0.0002"	0.0001"	0.0001"
8"	0.0002"	0.0001"	0.0001"
12"	0.0002"	0.0002"	0.0002"

BLOCKS & PARALLELS

Dimensions (Inch)	Code	Dimensions (Inch)	Code	Dimensions (Inch)	Code
1/4 x 3/8 x 6	420101	1/2 x 1 x 6	420115	1/2 x 1-1/8 x 8	420131
1/4 x 1/2 x 6	420102	1/2 x 1-1/8 x 6	420116	1/2 x 1-3/8 x 8	420132
1/4 x 5/8 x 6	420103	1/2 x 1-1/4 x 6	420117	5/8 x 1-1/4 x 8	420133
1/4 x 3/4 x 6	420104	9/16 x 13/16 x 6	420119	5/8 x 1-1/2 x 8	420134
1/4 x 7/8 x 6	420105	9/16 x 1-1/16 x 6	420121	11/16 x 1-1/4 x 8	420135
1/4 x 1 x 6	420106	5/8 x 7/8 x 6	420122	3/4 x 1 x 8	420136
3/8 x 1/2 x 6	420107	5/8 x 1 x 6	420123	3/4 x 1-1/4 x 8	420137
3/8 x 5/8 x 6	420108	5/8 x 1-1/8 x 6	420124	3/4 x 1-5/8 x 8	420138
3/8 x 3/4 x 6	420109	3/4 x 1 x 6	420125	1/2 x 1 x 12	420139
3/8 x 7/8 x 6	420110	3/4 x 1-1/8 x 6	420126	11/16 x 1-1/8 x 12	420140
3/8 x 1 x 6	420111	3/4 x 1-3/8 x 6	420127	3/4 x 1 x 12	420141
1/2 x 5/8 x 6	420112	3/4 x 1-1/2 x 6	420128	7/8 x 1-3/4 x 12	420142
1/2 x 3/4 x 6	420113	1/2 x 7/8 x 8	420129	1 x 1-1/2 x 12	420143
1/2 x 7/8 x 6	420114	1/2 x 1 x 8	420130	1 x 2 x 12	420144
				1-1/2 x 2 x 12	420145
				1-1/2 x 3 x 12	420146

Sets – 1/8", 1/4" & 1/2"



1/8" Thick - 10 Pair Parallel Set		1/4" Thick - 9 Pair Parallel Set		1/2" Thick - 8 Pair Parallel Set	
Dimensions (Inch)	Hole Size (Inch)	Dimensions (Inch)	Hole Size (Inch)	Dimensions (Inch)	Hole Size (Inch)
1/8 x 1/2 x 6	13/64	1/4 x 3/4 x 6	5/16	1/2 x 7/8 x 6	5/16
1/8 x 5/8 x 6	1/4	1/4 x 7/8 x 6	5/16	1/2 x 1 x 6	5/16
1/8 x 3/4 x 6	5/16	1/4 x 1 x 6	5/16	1/2 x 1-1/8 x 6	3/8
1/8 x 7/8 x 6	5/16	1/4 x 1-1/8 x 6	3/8	1/2 x 1-1/4 x 6	3/8
1/8 x 1 x 6	5/16	1/4 x 1-1/4 x 6	3/8	1/2 x 1-3/8 x 6	7/16
1/8 x 1-1/8 x 6	3/8	1/4 x 1-3/8 x 6	7/16	1/2 x 1-1/2 x 6	7/16
1/8 x 1-1/4 x 6	3/8	1/4 x 1-1/2 x 6	7/16	1/2 x 1-5/8 x 6	1/2
1/8 x 1-3/8 x 6	7/16	1/4 x 1-5/8 x 6	1/2	1/2 x 1-3/4 x 6	1/2
1/8 x 1-1/2 x 6	1/2	1/4 x 1-3/4 x 6	1/2		
1/8 x 1-5/8 x 6	1/2				

Description	Code
1/8" Thick - 10 Pairs	427007
1/4" Thick - 9 Pairs	427009
1/2" Thick - 8 Pairs	427010

Adjustable Angle Blocks



- Hardened tool steel
- With locking screw
- Accuracy of angle 10'

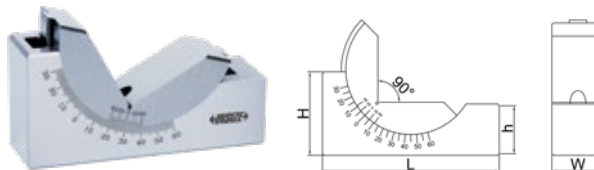

L x W x H (Inch)	h (Inch)	Adjustable Angle	Graduation of Angle	INSIZE No.	Code
3 x 1 x 1.4	0.98	30°-0°-60°	10'	6535-25	877195
4 x 1.2 x 1.9	1.18	30°-0°-60°	10'	6535-30	877196

Parallels

Utility, Ultra Thin & Value Parallel Sets

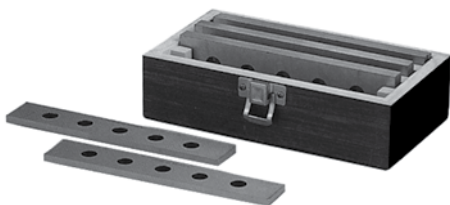

Utility Parallel Sets

3/16" Thick - 4 Pairs		1/2" Thick - 4 Pairs	
Dimensions (Inch)	Hole Size (Inch)	Dimensions (Inch)	Hole Size (Inch)
3/16 x 1 x 6	5/16	1/2 x 1 x 6	5/16
3/16 x 1-1/4 x 6	3/8	1/2 x 1-1/4 x 6	3/8
3/16 x 1-1/2 x 6	7/16	1/2 x 1-1/2 x 6	7/16
3/16 x 1-3/4 x 6	1/2	1/2 x 1-3/4 x 6	1/2

Description	Code
3/16" Thick 4 Pairs	427003
1/2" Thick 4 Pairs	427005



Ultra Thin Parallel Set

- Ultra thin parallels are 1/32" thick, 6" long, and range in height from 1/2" to 1-11/16" (in 1/16" increments)
- ±0.0001" in parallelism
- Paired in height to ±0.0001"
- Height matched to within ±0.001"

Description	Code
1/32" Thick 20 Pair Set	425490



Value Set

- Hardened steel, 6" in length by 1/8" thick.
- Heights: 1/2", 5/8", 3/4", 7/8", 1", 1-1/8", 1-1/4", 1-3/8", 1-1/2", 1-5/8"
- Parallel within 0.0008" each pair (±0.0004")
- Height matched within ±0.001" each pair

Description	Code
1/8" Thick 10 Pair Set	425491



Set

- Set in custom fitted plastic box with carrying handle
- Hardened steel, 6" in length by 1/4" thick
- Heights: 3/4", 7/8", 1", 1-1/8", 1-1/4", 1-3/8", 1-1/2", 1-5/8", 1-3/4"
- Parallel within 0.0005" each pair. Height matched within ±0.001" each pair

Description	Code
1/4" Thick 9 Pair Set	425492

Laminated Parallels

Aluminum – Steel

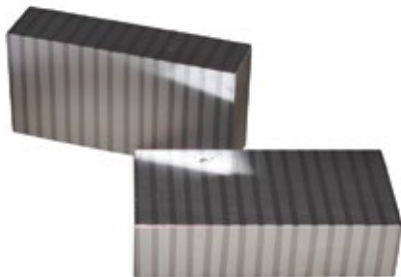

- Made of steel and aluminum strips
- Can be machined
- Supplied in matched pairs
- Used in conjunction with a magnetic plate to transfer the magnetism when machining or grinding awkward shaped parts

Size (Inch)	Code
1 x 2 x 4	430380

Adjustable Parallels



- Set of six adjustable parallel sizes: 3/8" to 1/2"; 1/2" to 11/16"; 11/16" to 15/16"; 15/16" to 1-5/16"; 1-5/16" to 1-3/4"; 1-3/4" to 2-1/4"
- Use in layout, gauging, inspection work and for setup on various machine tools
- Can be quickly inserted in openings and then expanded to size
- Each parallel consists of two dovetail mated pieces
- Can be used in pairs as regular parallels

Code
840530

Angle Block Sets



- No sine vise, sine plate, angle vise or gauge blocks are needed
- Set includes: V-Block - 10°, 15°, 30° Angle Plate - 1°, 2°, 3°, 4°, 5°
- All hardened to 56 to 58 RC
- Precision ground
- Tolerance ±1°

Description	Code
8 Piece Set	820301



- Hardened and precision ground
- Simple, quick angle set-up
- Lightly magnetized for better holding
- Eliminates calculation and avoids making errors
- Dimensions: 3" length x 1/4" thick
- Accuracy: 0.0001"

Description	Code
10 Piece Set	820305
12 Piece Set	820303

Angle Plate Set



- 12 piece set for angle set-up in tooling, production and inspection
- Tool steel
- Hardness HRC55
- Accuracy ±9"



Angle α	INSIZE No.	Code
1/4°, 1/2°, 1°, 2°, 3°, 4°, 5°, 10°, 15°, 20°, 25°, 30°	4003-12	877167

Radius & Angle Dresser

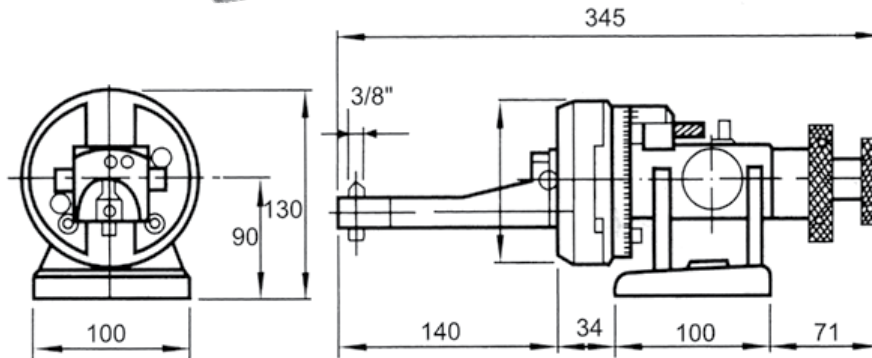
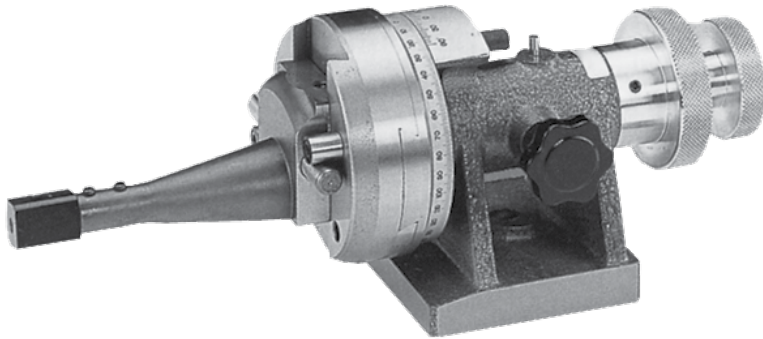

Maximum Diameter of Wheel (Inch)	Convex Radius (Inch)	Concave Radius (Inch)	Tangent Travel Either Side of Center (Inch/mm)	Range of Angle Dressing	Code
10	0-1.18	0.02-1.18	1.18/30	95°-0°-95°	395912

Wheel Dresser & Replacement Cutters

- Used for reconditioning grinding wheels and removing embedded metal particles which stick to the wheel during grinding operations
- Cutters are made of alloy steel
- Heat treated and tempered



Complete Tool



Cutter Set

No. of Cutters	Cutter Size Diameter x Bore x Width (Inch)	For Wheel Diameters up to... (Inch)	Code	No. of Cutters	Cutter Size Diameter x Bore x Width (Inch)	For Wheel Diameters up to... (Inch)	Code
4	1-3/16 x 1/4 x 7/16	20	425551	4	1-3/16 x 1/4 x 7/16	20	425555
4	1-1/2 x 1/2 x 15/32	30	425552	4	1-1/2 x 1/2 x 15/32	30	425556
6	2-3/8 x 9/16 x 7/8	>30	425553	6	2-3/8 x 9/16 x 7/8	>30	425557

Straight Edges

Flat & Bevelled Edges



Steel straight edges are manufactured from selected spring steel, fully ground and then hand scraped to ensure a perfectly flat surface. Hand scraping removes all the high points which are left from grinding, thus making it an extremely accurate tool. The thickness and design of these tools allow for shape and accuracy retention. These tools are portable and easy to handle.



- Used for drawing and scribing lines, checking various surfaces for straightness, for the set-up of machines such as planers, jointers and machine beds for alignment of tables, work surfaces and other positioning functions
- Two styles available in lengths from 12" (300mm) to 120" (3,000mm):
 FLAT EDGE: These have flat edges on both sides; BEVELLED EDGE: These are flat on one side and have a bevelled edge on the other side
- Each unit is identified numerically facilitating traceability if calibration is required

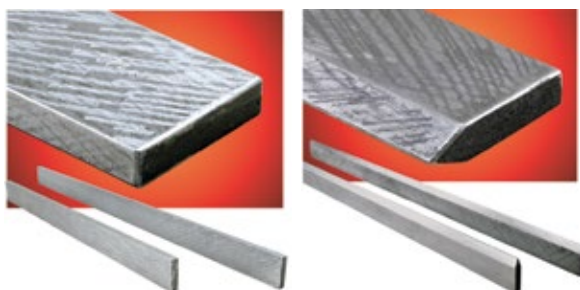

Length Inch (mm)	Width Inch	Thickness Inch	Flatness of Edge Inch	Parallelism of Faces Inch	Flat Edge	Bevelled Edge
					Code	Code
12 (300)	1-13/32	5/16	0.00047	0.00094	840630	840639
18 (450)	1-13/32	5/16	0.00047	0.00094	840631	840640
24 (600)	1-13/32	5/16	0.00067	0.0013	840632	840641
36 (900)	2-13/32	3/8	0.00083	0.0016	840633	840642
48 (1200)	2-13/32	3/8	0.0011	0.002	840634	840643
60 (1500)	3-5/32	3/8	0.0011	0.002	840635	840644
72 (1800)	3-5/32	3/8	0.0015	0.0029	840636	840645
96 (2400)	3-5/32	19/32	0.0018	0.0036	840637	840646
120 (3000)	3-1/4	19/32	0.0021	0.0043	840638	840647

STRAIGHT EDGES

Key Stock



- Cold drawn oversize zinc plated - steel
- Tolerances for both dimensions: up to 3/4" inc. 0.000" to +0.002"
 over 3/4" to 1-1/2" inc. 0.000" to +0.003"
 over 1-1/2" to 2-1/2" inc. 0.000" to +0.004"

Square Key Stock

Size (Inch)	Code	Size (Inch)	Code	Size (Inch)	Code	Size (Inch)	Code	Size (Inch)	Code
3/32	455510	9/32	455516	5/8	455522	7/8	455526	1-1/4	455530
1/8	455511	5/16	455517	11/16	455523	1	455527	1-3/8	455531
5/32	455512	3/8	455518	3/4	455524	1-1/8	455528	1-1/2	455532
3/16	455513	7/16	455519	13/16	455525	1-3/16	455529	1-3/4	455533
7/32	455514	1/2	455520					2	455534
1/4	455515	9/16	455521						

Square Key Stock Assortment

- 12" lengths of 6 popular sizes: 6 each of 3/16", 1/4", 5/16", 3/8"; 4 each of 7/16" and 1/2"

Code
455535

Rectangular Key Stock

Size (Inch)	Code	Size (Inch)	Code	Size (Inch)	Code	Size (Inch)	Code
1/8 x 3/16	455540	3/16 x 1/2	455546	3/8 x 1/2	455553	5/8 x 1	455560
1/8 x 1/4	455541	1/4 x 5/16	455547	3/8 x 5/8	455554	3/4 x 1	455561
1/8 x 3/8	455542	1/4 x 1/2	455549	3/8 x 3/4	455555		
3/16 x 1/4	455543	5/16 x 3/8	455550	7/16 x 1/2	455556		
3/16 x 5/16	455544	5/16 x 1/2	455551	1/2 x 5/8	455557		
3/16 x 3/8	455545	5/16 x 5/8	455552	5/8 x 3/4	455559		

Shim Stock

Steel & Brass – Single Rolls



Steel

Thickness (Inch)	Model	6 x 100"		12 x 120"		Thickness (Inch)	Model	6 x 100"		12 x 120"	
		Code	Code	Code	Code			Code	Code		
0.0010	16A-1	455651	455673	0.0070	16A-7	455660	16A-18	455668	455686		
0.0020	16A-2	455653	455675	0.0080	16A-8	455661	16A-20	455669	455687		
0.0030	16A-3	455655	455676	0.0090	16A-9	455662	16A-25	455671	455688		
0.0040	16A-4	455657	455677	0.0100	16A-10	455663	16A-31	455672	455689		
0.0050	16A-5	455658	455678	0.0120	16A-12	455664					
0.0060	16A-6	455659	455679	0.0150	16A-15	455666					

Shim Stock (continued)

Brass

Thickness (Inch)	Model	6 x 100"		12 x 120"		Thickness (Inch)	Model	6 x 100"		12 x 120"	
		Code	Code	Code	Code			Code	Code		
0.0010	17S-1	455601	455620	0.0060	17S-6	455607	455625	0.0200	17S-20	455614	-
0.0015	17S-1X	455602	-	0.0070	17S-7	455608	-	0.0250	17S-25	455615	-
0.0020	17S-2	455603	455621	0.0080	17S-8	455609	455626	0.0310	17S-31	455616	-
0.0030	17S-3	455604	455622	0.0100	17S-10	455611	455627				
0.0040	17S-4	455605	455623	0.0120	17S-12	455612	-				
0.0050	17S-5	455606	455624	0.0150	17S-15	455613	-				

Permanent Magnets



Insulated Pot Magnets

- Material: Alcomax III
- Can be used in temperatures up to 428°F
- Commonly used in gripping/lifting, positioning jigs, inserting into jigs/fixtures, in catches/latches

Diameter (Inch)	Height (Inch)	Pull (lbs)	Thread Size	Code
1/4	1/2	0.25	6-32	381110
3/8	1/2	1.43	6-32	381111
1/2	1/2	2.50	6-32	381112
3/4	3/4	9.13	10-24	381113
1	1	16.00	1/4-20	381114



Magnetic Foot

- Material: Alcomax III (magnet), mild steel (pot)
- Can be used in temperatures up to 428°F
- Rectangular block containing two pot type magnets set into one mild steel housing

Length (Inch)	Height (Inch)	Width (Inch)	Weight (lbs)	Max. Pull (lbs)	Code
2-23/64	1	1	0.7	26	381117



Deep Pot Magnets

- Alnico with mild steel body and aluminum spacer
- Max. operating temperature 220°C/425°F
- Suited for gripping, lifting, positioning jigs, soldering fixtures, general securing and fixtures

Diameter (Inch)	Height (Inch)	Max. Pull (lbs)	Thread Size	Code
0.375	0.594	2.2	M3	381120
0.500	0.625	4.5	M4	381121
0.689	0.629	5.8	10 UNF	381122
0.807	0.748	8.8	10 UNF	381123
1.062	1	13.4	10 UNF	381124
1.377	1.181	32.5	10 UNF	381125



Shallow Pot Magnets

- Material: Alcomax III (magnet), mild steel (body)
- Can be used in temperatures up to 1022°F (except 3/4 Dia. 212°F)
- Uses are similar to standard pot magnets use where height is a restriction
- Shallow flux fields best suited for gripping on smooth surfaces

Diameter (Inch)	Height (Inch)	Screw Head (Inch)	Max. Pull (lbs)	Code
3/4	5/16	5/32	7-1/2	381130
1-1/8	11/32	13/64	11	381131
1-1/2	13/32	16/64	28-1/2	381132



Button Magnets

- Material: Alnico
- Can be used in temperatures up to 1022°F
- Ideal for use on rough surfaces because of their deeper flux field

Diameter (Inch)	Height (Inch)	Slot Size Min.-Max. (Inch)	Max. Pull (lbs)	Code
1/2	3/8	5/32-9/32	1-1/2	381135
3/4	1/2	7/32-11/32	4	381136
1	5/8	7/32-11/32	8	381137
1-1/4	1	5/16-1/2	11	381138
7/8	3/4	3/16-3/16	8	381139



Pocket Magnets

- Material: Alnico
- Can be used in temperatures up to 1022°F
- Useful where air gaps are present due to deep flux field

Length (Inch)	Height (Inch)	Width (Inch)	Max. Pull (lbs)	Code
7/8	1	1-1/8	5	381141
1-1/16	1-3/8	5/8	8	381142

Neodymium Iron Boron Discs – Rare Earth



- Pressure-formed (sintered) magnets have ten times the strength of alnico magnets
- Nickel-plated magnets offer corrosion resistance
- Temperature range -40°F to +300°F, unless noted otherwise

Diameter (Inch)	Thickness (Inch)	Code
0.250	0.250	381191
0.250	0.500	381192
0.375	0.250	381193

Diameter (Inch)	Thickness (Inch)	Code
0.375	0.500	381194
0.500	0.250	381195
0.500	0.500	381196
0.750	0.375	381197
1.000	0.500	381199

Permanent Magnets

Button Magnets



- Many applications including magnetic fastening, displays, bulletin boards, etc
- Center hole for easy fastening
- Supplied with fastener

Diameter (Inch)	Height (Inch)	Magnetic Pull (lbs)	Code
3/4	1/2	4	425577
1	5/8	6-1/2	425578
1-1/4	3/4	14	425579
1-1/2	7/8	18-1/2	425580

Magnetic Quick Clamp



- Designed to enable fast and accurate holding of ferrous metals for welding and assembly jobs
- The quick clamp will hold sheet and tube at angles of 180°, 75°, 60°, 45°, and 30°
- The through-body hole enables this new magnetic tool to be built into jigs or to be hung up when not in use

Base (Inch)	Height (Inch)	Length (Inch)	Code
3-1/2	2-1/2	4	425581

Welding Links



- For holding steel plates in position for welding, brazing, and soldering
- Eliminates need for clamps or temporary fastening
- Constructed from two heavy duty Alnico magnetic blocks linked together with strong steel bars and wing nuts

Block Dimensions (Inch)	Weight (oz)	Code
2 x 1 x 1	1-1/2	425562

Magnetic Quick Clamps



- The Eclipse magnetic quick clamp is designed to facilitate fast and accurate holding of ferrous metals
- Quick clamps are also suitable for retrieval applications
- Maximum operating temperature up to 176°F

Length (Inch)	Height (Inch)	Width (Inch)	Weight (lbs)	Pull (lbs)	Code
4	2-9/16	1/2	0.66	22	381165
4	2-9/16	13/16	0.88	33	381166



If you can't find a product, or require a size not listed in our catalog contact us... One of our experienced Customer Service Representatives will be pleased to help you find it!



TORONTO



MONTRÉAL



EDMONTON

KAR is your ONE STOP SHOP for all your precision measuring, cutting tools, machine tool accessories and other manufacturing related supplies.

Visit us at WWW.KAR.CA to find current promotions, download supplier catalogs, check out inventory levels for all three warehouses and to find a local KAR Distributor.

Black Book Reference Guides

648



Tap Drill Sizes

648

Decimal Equivalents

649

Cutting Speed Conversions

650

*Speeds & Feeds
for High Speed Steel Drills*

651

*Tap Drill Sizes
for Forming Taps*

652

*Technical Information
for Standard Carbide Drills*

653

For more about KAR products and technical information call your local KAR Distributor TODAY!

www.KAR.ca

Black Books

Engineer's Black Book – 3rd Edition

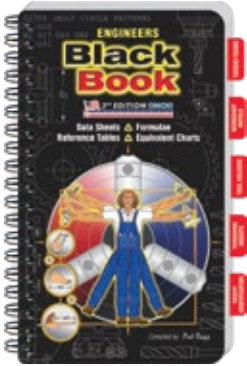

- Pocket size machinist reference book with 234 laminated non-glare pages
- Pages are tear and grease proof
- Non-slip rubberized cover
- Wired lay flat binding
- Includes self adhesive bookmarking tabs

Code
284998

Fastener Black Book

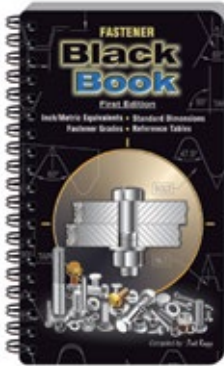

- A complete reference guide including:
- Inch/Metric equivalencies
 - Fastener grades
 - Standard dimensions
 - Reference tables



Includes a Thread Pitch Identification Gage

Code
284999

Tap Drill Sizes

Machine Screw Sizes – NC & NF

Nominal Size Tap	Recommended Tap Drill		Probable Hole Size	Actual % Threaded
	Drill	Decimal		
0 – 80	3/64	0.0469	0.0484	71
1 – 64	53	0.0595	0.0610	59
1 – 72	53	0.0595	0.0610	67
2 – 56	50	0.0700	0.0717	62
2 – 64	50	0.0700	0.0717	70
3 – 48	47	0.0785	0.0804	69
3 – 56	46	0.0810	0.0829	69
4 – 40	43	0.0890	0.0910	65
4 – 48	3/32	0.0938	0.0958	60
5 – 40	38	0.1015	0.1038	65
5 – 44	37	0.1040	0.1063	63
6 – 32	36	0.1065	0.1091	71
6 – 40	33	0.1130	0.1156	69
8 – 32	29	0.1360	0.1389	62
8 – 36	29	0.1360	0.1389	70
10 – 24	26	0.1470	0.1502	74
10 – 32	21	0.1590	0.1622	68
12 – 24	16	0.1770	0.1805	66
12 – 28	15	0.1800	0.1835	70

Fractional Sizes – NC & NF

Nominal Size Tap	Recommended Tap Drill		Probable Hole Size	Actual % Threaded
	Drill	Decimal		
1/4 – 20	7	0.2010	0.2048	70
1/4 – 28	3	0.2130	0.2168	72
5/16 – 18	F	0.2570	0.2608	72
5/16 – 24	I	0.2720	0.2761	67
3/8 – 16	5/16	0.3125	0.3169	72
3/8 – 24	Q	0.3320	0.3364	71
7/16 – 14	U	0.3680	0.3726	70
7/16 – 20	25/64	0.3906	0.3952	65
1/2 – 13	27/64	0.4219	0.4266	73
1/2 – 20	29/64	0.4531	0.4578	65
9/16 – 12	31/64	0.4844	0.4892	68
9/16 – 18	33/64	0.5156	0.5204	58
5/8 – 11	17/32	0.5313	0.5362	75
5/8 – 18	37/64	0.5781	0.5831	58
3/4 – 10	21/32	0.6563	0.6613	68
3/4 – 16	11/16	0.6875	0.6925	71
7/8 – 9	49/64	0.7656	0.7708	72
7/8 – 14	13/16	0.8125	0.8177	62
1 – 8	7/8	0.8750	0.8809	73
1 – 12	59/64	0.9219	0.9279	67

Pipe Tap Sizes – NPT, NPTF & NPS

Tap Size	Drill Size NPT & NPTF	Decimal Equivalent	Drill Size NPS Straight	Decimal Equivalent
1/8 – 27	R	0.3390	11/32	0.3438
1/4 – 18	7/16	0.4375	7/16	0.4375
3/8 – 18	37/64	0.5781	37/64	0.5781
1/2 – 14	45/64	0.7031	23/32	0.7188
3/4 – 14	59/64	0.9219	59/64	0.9219
1 – 11-1/2	1-5/32	1.1562	1-5/32	1.1562
1-1/4 – 11-1/2	1-1/2	1.5000	1-1/2	1.5000
1-1/2 – 11-1/2	1-47/64	1.7344	1-3/4	1.7500
2 – 11-1/2	2-7/32	2.2188	2-7/32	2.2188
2-1/2 – 8	2-5/8	2.6250	2-21/32	2.6562
3 – 8	3-1/4	3.2500	–	–

Metric Sizes

Metric Nominal Size/Pitch mm	Tap Limit No.	Inch Series		Metric Series	
		Nominal Size	Inch Diameter	Size (mm)	Inch Diameter
M1.6 x 0.35	D3	–	–	1.25	0.0492
M2 x 0.04	D3	52	0.0635	1.60	0.0630
M2.5 x 0.45	D3	45	0.0820	2.05	0.0807
M3 x 0.5	D3	39	0.0995	2.50	0.0984
M3.5 x 0.6	D4	32	0.1160	2.90	0.1142
M4 x 0.7	D4	30	0.1285	2.30	0.1299
M5 x 0.8	D4	19	0.1660	4.20	0.1654
M6 x 1	D5	8	0.1990	5.00	0.1968
M8 x 1.25	D5	H	0.2660	6.80	0.2677
M10 x 1.5	D6	Q	0.3320	8.50	0.3346
M12 x 1.75	D6	13/32	0.4062	10.25	0.4035
M14 x 2	D7	15/32	0.4688	12.00	0.4724
M16 x 2	D7	35/64	0.5469	14.00	0.5512
M20 x 2.5	D7	11/16	0.6875	17.50	0.6890
M24 x 3	D8	53/64	0.8281	21.00	0.8268
M30 x 3.5	D9	1-3/64	1.0469	26.50	1.0433
M36 x 4	D9	1-1/4	1.2500	32.00	1.2598

Decimal Equivalents

Inch, Metric & Wire Sizes

mm Inch Wire	Decimal	mm Inch Wire	Decimal	mm Inch Wire	Decimal	mm Inch Wire	Decimal
0.1mm	0.0039	45	0.0820	5	0.2055	29/64	0.4531
0.2mm	0.0079	44	0.0860	4	0.2090	15/32	0.4687
0.3mm	0.0118	43	0.0890	3	0.2130	12.0mm	0.4724
80	0.0135	42	0.0935	7/32	0.2187	31/64	0.4844
79	0.0145	3/32	0.0937	2	0.2210	1/2	0.5000
1/64	0.0156	41	0.0960	1	0.2280	13.0mm	0.5118
0.4mm	0.0157	40	0.0980	A	0.2340	33/64	0.5156
78	0.0160	39	0.0995	15/64	0.2344	17/32	0.5312
77	0.0180	38	0.1015	6.0mm	0.2362	35/64	0.5469
0.5mm	0.0197	37	0.1040	B	0.2380	14.0mm	0.5512
76	0.0200	36	0.1065	C	0.2420	9/16	0.5625
75	0.0210	7/64	0.1094	D	0.2460	37/64	0.5781
74	0.0225	35	0.1100	1/4	0.2500	15.0mm	0.5906
0.6mm	0.0236	34	0.1110	F	0.2570	19/32	0.5937
73	0.0240	33	0.1130	G	0.2610	39/64	0.6094
72	0.0250	32	0.1160	17/64	0.2656	5/8	0.6250
71	0.0260	3.0mm	0.1181	H	0.2660	16.0mm	0.6299
0.7mm	0.0276	31	0.1200	I	0.2720	41/64	0.6406
70	0.0280	1/8	0.1250	7.0mm	0.2756	21/32	0.6562
69	0.0292	30	0.1285	J	0.2770	17.0mm	0.6693
68	0.0310	29	0.1360	K	0.2810	43/64	0.6719
1/32	0.0312	28	0.1405	9/32	0.2812	11/16	0.6875
0.8mm	0.0315	9/64	0.1406	L	0.2900	45/64	0.7031
67	0.0320	27	0.1440	M	0.2950	18.0mm	0.7087
66	0.0330	26	0.1470	19/64	0.2969	23/32	0.7187
65	0.0350	25	0.1495	N	0.3020	47/64	0.7344
0.9mm	0.0354	24	0.1520	5/16	0.3125	19.0mm	0.7480
64	0.0360	23	0.1540	8.0mm	0.3150	3/4	0.7500
63	0.0370	5/32	0.1562	O	0.3160	49/64	0.7656
62	0.0380	22	0.1570	P	0.3230	25/32	0.7812
61	0.0390	4.0mm	0.1575	21/64	0.3281	20.0mm	0.7874
1.0mm	0.0394	21	0.1590	Q	0.3320	51/64	0.7969
60	0.0400	20	0.1610	R	0.3390	13/16	0.8125
59	0.0410	19	0.1660	11/32	0.3437	21.0mm	0.8268
58	0.0420	18	0.1695	S	0.3480	53/64	0.8281
57	0.0430	11/64	0.1719	9.0mm	0.3543	27/32	0.8437
56	0.0465	17	0.1730	T	0.3580	55/64	0.8594
3/64	0.0469	16	0.1770	23/64	0.3594	22.0mm	0.8661
55	0.0520	15	0.1800	U	0.3680	7/8	0.8750
54	0.0550	14	0.1820	3/8	0.3750	57/64	0.8906
53	0.0595	13	0.1850	V	0.3770	23.0mm	0.9055
1/16	0.0625	3/16	0.1875	W	0.3860	29/32	0.9062
52	0.0365	12	0.1890	25/64	0.3906	59/64	0.9219
51	0.0670	11	0.1910	10.0mm	0.3937	15/16	0.9375
50	0.0700	10	0.1935	X	0.3970	24.0mm	0.9449
49	0.0730	9	0.1960	Y	0.4040	51/64	0.9531
48	0.0760	5.0mm	0.1968	13/32	0.4062	31/32	0.9687
5/64	0.0781	8	0.1990	Z	0.4130	25.0mm	0.9842
47	0.0785	7	0.2010	27/64	0.4219	63/64	0.9844
2.0mm	0.0787	13/64	0.2031	11.0mm	0.4332	1	1.0000
46	0.0810	6	0.2040	7/16	0.4375	-	-

Cutting Speed Conversions

Feet/Minute to Revolutions/Minute

Diameter (Inch)	Cutting Speed – Feet/Minute												
	5	10	25	50	75	100	150	200	250	300	350	400	500
	Revolutions/Minute (RPM)												
1/16	306	611	1528	3056	4584	6112	9167	12223	15279	18335	21390	24446	30557
1/8	153	306	764	1528	2292	3056	4584	6112	7639	9167	10696	12223	15279
3/16	102	204	509	1019	1528	2037	3056	4074	5093	6112	7130	8149	10186
1/4	76	153	382	764	1146	1529	2292	3056	3820	4584	5348	6112	7639
5/16	61	122	306	611	917	1222	1833	2445	3056	3667	4278	4889	6112
3/8	51	102	255	509	764	1019	1528	2037	2546	3056	3565	4074	5093
7/16	44	87	281	437	655	873	1310	1746	2183	2619	3056	3492	4365
1/2	38	76	191	382	573	764	1146	1528	1910	2291	2674	3056	3820
5/8	31	61	153	306	458	611	917	1222	1528	1833	2139	2445	3056
3/4	26	51	127	255	382	509	764	1019	1273	1528	1783	2037	2546
7/8	22	44	109	218	327	437	655	873	1091	1310	1528	1746	2183
1	19	38	95	191	286	382	573	764	955	1146	1337	1528	1910
1-1/8	17	34	85	170	255	340	509	679	849	1019	1188	1358	1698
1-1/4	15	31	76	153	229	306	458	611	764	917	1070	1222	1528
1-3/8	14	28	70	139	208	278	417	556	694	833	972	1111	1389
1-1/2	13	26	64	127	191	255	382	509	637	764	891	1019	1273
1-5/8	12	24	59	118	176	235	353	470	588	705	823	940	1175
1-3/4	11	22	55	109	164	218	327	437	546	655	764	873	1091
1-7/8	10	20	51	102	153	204	306	407	509	611	713	815	1019
2	9	19	48	95	143	191	286	382	477	573	668	764	955
2-1/4	8	17	42	85	127	170	255	340	424	509	594	679	849
2-1/2	7	15	38	76	115	153	229	306	382	458	535	611	764
2-3/4	7	14	35	69	104	139	208	278	347	417	486	556	694
3	6	13	32	64	96	127	191	255	318	382	446	509	637
3-1/4	6	12	29	59	88	118	176	235	294	353	411	470	588
3-1/2	5	11	27	55	82	109	164	218	273	327	382	437	546
3-3/4	5	10	25	51	76	102	153	204	255	306	357	407	509
4	4	9	24	48	72	96	143	191	239	286	334	382	477

Formula

Unknown Units	Known Units	Formula Required (Inch)	Formula Required (Metric)
Vc (Surface Speed)	D & RPM	$0.262 \times D \times \text{RPM}$	$0.0031 \times D \times \text{RPM}$
RPM (Revolutions/Minute)	D & Vc	$\frac{Vc}{D \times 0.262}$	$\frac{318 \times Vc}{D}$
Fr (Feed/Revolution)	RPM & Fm	$\frac{Fm}{\text{RPM}}$	$\frac{Fm}{\text{RPM}}$
Fm (Feed/Minute)	RPM & Fr	$\text{RPM} \times Fr$	$\text{RPM} \times Fr$

Legend

Symbol	Description
Vc	Surface speed in feet or meters per minute
RPM	Revolutions per minute
Fr	Feed per revolution in inch or millimeter
Fm	Feed per minute in inch or millimeter
D	Diameter in inch or millimeter

Speeds & Feeds for High Speed Steel Drills

Recommended Speeds & Coolants

Materials to be Drilled	Speed		Coolant
	Feet/Minute	Metres/Minute	
Aluminum & Aluminum Alloys	200 to 300	61 to 92	Soluble Oil. Paraffin.
Bakelite - Vulcanite	100 to 150	30 to 46	Dry. If possible, keep the drill cool with air jet.
Brass	150 to 200	46 to 76	Dry. Soluble Oil.
Brass - Leaded	200 to 300	61 to 92	Dry. Soluble Oil.
Bronze - Ordinary	100 to 200	30 to 61	Soluble Oil.
Bronze - High Tensile	70 to 100	22 to 30	Soluble Oil.
Cast Iron - Soft	100 to 150	30 to 46	Dry. If possible, keep the drill cool with air jet.
Cast Iron - Medium	80 to 90	24 to 27	Soluble Oil.
Cast Iron - Hard	50 to 70	15 to 22	Dry. If possible, keep the drill cool with air jet.
Cast Iron - Chilled	25 to 35	8 to 11	Soluble Oil.
Copper	100 to 200	30 to 61	Soluble Oil.
Duralumin	100 to 200	30 to 61	Dry. Soluble Oil.
Magnesium & Magnesium Alloys	250 to 400	76 to 122	Dry. If possible, keep the drill cool with air jet.
Malleable Iron	70 to 80	22 to 24	Soluble Oil.
Mazak	200 to 300	61 to 91	Soluble Oil.
Monel Metal	40 to 50	12 to 15	Soluble Oil. Sulphurized Oil.
Slate, Stone, Marble	15 to 20	5 to 6	Dry. If possible, keep the drill cool with air jet.
Steel - Free Cutting Mild	100 to 150	30 to 46	Soluble Oil. Sulphurized Oil.
Steel - Up to 40 Tons Tensile	80 to 110	24 to 33	Soluble Oil. Sulphurized Oil.
Steel - 40 to 60 Tons Tensile	45 to 70	14 to 22	Soluble Oil. Sulphurized Oil.
Steel - 60 to 80 Tons Tensile	30 to 45	9 to 14	Soluble Oil. Sulphurized Oil.
Steel - Over 80 Tons Tensile	15 to 25	5 to 8	Soluble Oil. Sulphurized Oil.
Steel - Manganese 12%/14%	10 to 15	3 to 5	Dry.
Stainless Steels - Martensitic & Ferritic	30 to 50	9 to 15	Sulphurized Oil.
Stainless Steels - Austenitic & Heat Resisting	20 to 45	6 to 14	Sulphurized Oil.
Stainless Steels - Free Cutting (Ferritic)	50 to 60	15 to 18	Sulphurized Oil.
Stainless Steels - Free Cutting (Austenitic)	40 to 50	12 to 15	Sulphurized Oil.
Wood	300 to 400	92 to 122	Sulphurized Oil.

When selecting a suitable cutting lubricant remember that soluble oil and water emulsions have good cooling properties and are therefore applicable to high speed working. The sulphurised cutting lubricants have good anti-weld properties and are therefore applicable where cutting pressures are high. It may be advantageous to dilute the sulphurised oils with paraffin or light mineral oils in order to reduce excessive drill wear at high speeds.

Recommended Feeds

Drill Diameter		Feed/Revolution	
mm	Inches	mm	Inches
1.59 to 2.38	1/16 to 3/32	0.04 to 0.06	0.0015 to 0.0025
3.18 to 3.97	1/8 to 5/32	0.05 to 0.10	0.002 to 0.004
4.76 to 5.56	3/16 to 7/32	0.08 to 0.15	0.003 to 0.006
6.35 to 7.94	1/4 to 5/16	0.10 to 0.20	0.004 to 0.008
9.52 to 11.11	3/8 to 7/16	0.15 to 0.25	0.006 to 0.010
12.70 to 14.29	1/2 to 9/16	0.20 to 0.30	0.008 to 0.012
15.88 to 17.46	5/8 to 11/16	0.23 to 0.33	0.009 to 0.013
19.05 to 20.64	3/4 to 13/16	0.25 to 0.36	0.010 to 0.014
22.22 to 23.81	7/8 to 15/16	0.28 to 0.38	0.011 to 0.015
25.40 to 28.58	1 to 1-1/8	0.30 to 0.41	0.012 to 0.016
31.75 to 38.10	1-1/4 to 1-1/2	0.36 to 0.46	0.014 to 0.018
Over 38.1	Over 1-1/2	0.46 to 0.50	*0.016 to 0.020

*Or greater according to diameter and local conditions

The speeds quoted are only a basic guide. If conditions permit it may be possible to increase the above values. When commencing to drill new work the slowest speed and lightest feed should be used and these should gradually be increased until optimum output per grind is obtained.

Tap Drill Sizes for Forming Taps

Inch

Tap Size	Drill Size	Decimal Equivalent	Percentage of Thread	Tap Size	Drill Size	Decimal Equivalent	Percentage of Thread
0-80	1.35mm	0.0531	75	10-24	11/64	0.1719	65
1-64	1.65mm	0.0650	75	10-32	17	0.1730	75
1-72	1.65mm	0.0650	75	10-32	16	0.1770	60
1-72	1.70mm	0.0669	65	12-24	10	0.1935	75
1-72	51	0.0670	60	12-24	9	0.1960	70
2-56	1.95mm	0.0768	75	12-24	5.00mm	0.1968	65
2-56	5/64	0.0781	65	12-24	8	0.1990	60
2-56	47	0.0785	60	12-28	5.00mm	0.1968	75
2-64	5/64	0.0781	75	12-28	8	0.1990	70
2-64	47	0.0785	70	12-28	7	0.2010	60
2-64	2.00mm	0.0787	65	1/4-20	5.70mm	0.2244	75
3-48	2.25mm	0.0886	75	1/4-20	1	0.2280	65
3-48	43	0.0890	70	1/4-28	5.90mm	0.2323	75
3-48	2.30mm	0.0906	60	1/4-28	A	0.2340	65
3-56	43	0.0890	75	1/4-28	15/64	0.2344	60
3-56	2.30mm	0.0906	65	5/16-18	7.20mm	0.2835	75
4-40	2.50mm	0.0984	75	5/16-18	7.25mm	0.2854	70
4-40	39	0.0995	70	5/16-18	7.30mm	0.2874	65
4-40	38	0.1015	60	5/16-18	L	0.2900	60
4-48	38	0.1015	70	5/16-24	7.40mm	0.2913	75
4-48	2.60mm	0.1024	65	5/16-24	7.50mm	0.2953	60
5-40	34	0.1110	75	3/8-16	8.75mm	0.3445	70
5-40	33	0.1130	70	3/8-16	8.80mm	0.3465	65
5-40	2.90mm	0.1142	60	3/8-24	9.00mm	0.3443	70
5-44	33	0.1130	75	3/8-24	T	0.3580	60
5-44	2.90mm	0.1142	70	7/16-14	Y	0.4040	65
6-32	3.10mm	0.1220	75	7/16-20	10.50mm	0.4134	70
6-32	1/8	0.1250	60	1/2-13	11.80mm	0.4646	65
6-40	1/8	0.1250	75	1/2-20	12.00mm	0.4724	75
6-40	3.20mm	0.1260	70	9/16-12	13.20mm	0.5197	75
8-32	25	0.1495	75	9/16-18	13.50mm	0.5315	75
8-32	3.75mm	0.1476	70	5/8-11	37/64	0.5781	75
8-32	3.80mm	0.1496	65	5/8-11	14.75mm	0.5807	70
8-36	25	0.1495	75	5/8-18	19/32	0.5937	75
8-36	3.80mm	0.1496	70	5/8-18	15.25mm	0.6004	65
8-36	24	0.1520	60	3/4-10	45/64	0.7031	65
10-24	4.25mm	0.1673	75	3/4-16	23/32	0.7187	70
10-24	18	0.1695	70				

Practical Formula – Inch Sizes

To Establish Tap Drill Sizes for Inch Size Roll Forming Taps

$$\text{Tap Drill Size} = \text{Basic Tap O.D.} - \frac{(0.0068 \times \% \text{ of Thread Desired})}{\text{Threads Per Inch}}$$

$$\text{(EXAMPLE 1/4-20 Tap with 65\% Thread)} = 0.250 - \frac{(0.0068 \times 65)}{20} = 0.228 \text{ Dia.}$$

Practical Formula – Metric Sizes

To Establish Tap Drill Sizes for Metric Size Roll Forming Taps

$$\text{Tap Drill Size} = \text{Basic Tap O.D. (mm)} - \frac{(\% \text{ of Thread Desired} \times \text{mm Pitch})}{147.06}$$

$$\text{(EXAMPLE M8 x 1.25 Tap with 65\% Thread)} = 8 - \frac{(65 \times 1.25)}{147.06} = 7.45 \text{mm Dia.}$$

APPLICATION

Forming Taps cold form threads in ductile materials such as brass, copper, aluminum and leaded steels as well as series 301 to 347 stainless steels. Thread size can be maintained closely since taps have no cutting edges. Unusually smooth threads can be formed throughout the full depth of the holes.

Metric

Tap Size	Drill Size	Decimal Equivalent	Percentage of Thread
M3 x 0.5	7/64	0.1094	65
M3.5 x 0.6	3.20mm	0.1260	75
M4 x 0.7	27	0.1440	70
M4.5 x 0.75	4.10mm	0.1614	80
M5 x 0.8	4.60mm	0.1811	75
M6 x 1	5.50mm	0.2165	75
M7 x 1	6.50mm	0.2559	75
M8 x 1.25	L	0.2900	75
M8 x 1	7.50mm	0.2953	75
M10 x 1.5	9.20mm	0.3622	75
M10 x 1.25	U	0.3680	75
M12 x 1.75	7/16	0.4375	75
M12 x 1.25	*0.447	0.4470	75
M14 x 2	13.00mm	0.5118	75
M14 x 1.5	13.20mm	0.5197	75
M16 x 2	15.00mm	0.5906	75
M16 x 1.5	15.25mm	0.6004	75
M18 x 2.5	16.75mm	0.6594	75
M18 x 1.5	17.25mm	0.6791	75
M20 x 2.5	47/64	0.7344	80
M20 x 1.5	*0.757	0.7570	75

*Non-standard drill sizes – reaming of the hole may be necessary

Technical Information for Standard Carbide Drills



Recommended Cutting Conditions – Solid Carbide – 118° Point

WORK MATERIAL	NON-ALLOY STEELS		ALLOY STEELS		SOFT GRAY CAST IRON		HARD GRAY CAST IRON	
	Diameter	RPM	Inch/Rev.	RPM	Inch/Rev.	RPM	Inch/Rev.	RPM
3/64	23,000	0.0012	17,200	0.0012	32,000	0.0016	23,000	0.0016
5/64	11,500	0.0016	8,600	0.0016	16,000	0.0020	11,500	0.0020
1/8	7,800	0.0020	5,750	0.0020	10,500	0.0024	7,600	0.0024
5/32	5,800	0.0024	4,300	0.0024	7,800	0.0028	5,700	0.0028
13/64	4,700	0.0028	3,450	0.0028	6,200	0.0031	4,550	0.0031
15/64	3,900	0.0031	2,850	0.0031	5,200	0.0035	3,800	0.0035
9/32	3,350	0.0035	2,450	0.0035	4,500	0.0039	3,250	0.0039
5/16	2,900	0.0039	2,150	0.0039	3,900	0.0047	2,850	0.0047
23/64	2,600	0.0043	1,900	0.0043	3,450	0.0055	2,550	0.0055
25/64	2,350	0.0047	1,700	0.0047	3,100	0.0063	2,300	0.0063
7/16	2,150	0.0051	1,500	0.0051	2,850	0.0071	2,100	0.0071
15/32	1,950	0.0055	1,450	0.0055	2,600	0.0079	1,900	0.0079
33/64	1,800	0.0063	1,350	0.0063	2,400	0.0079	1,750	0.0079

WORK MATERIAL	STAINLESS STEELS		Al-Si ALLOY Si<10%		Al-Si ALLOY Si>10%		Ti, Ni ALLOY STEELS	
	Diameter	RPM	Inch/Rev.	RPM	Inch/Rev.	RPM	Inch/Rev.	RPM
3/64	12,000	0.0016	54,000	0.0020	42,000	0.0020	11,800	0.0008
5/64	6,000	0.0012	27,000	0.0024	21,000	0.0024	5,900	0.0012
1/8	4,000	0.0016	18,000	0.0028	14,000	0.0028	3,900	0.0016
5/32	3,000	0.0020	13,000	0.0031	10,500	0.0031	2,950	0.0020
13/64	2,400	0.0024	10,500	0.0035	8,500	0.0035	2,350	0.0024
15/64	2,000	0.0028	8,800	0.0043	7,100	0.0043	1,950	0.0028
9/32	1,700	0.0031	7,600	0.0051	6,100	0.0051	1,700	0.0031
5/16	1,500	0.0035	6,600	0.0059	5,350	0.0059	1,450	0.0035
23/64	1,350	0.0039	5,900	0.0067	4,750	0.0067	1,300	0.0039
25/64	1,200	0.0043	5,300	0.0075	4,250	0.0075	1,200	0.0043
7/16	1,100	0.0047	4,850	0.0083	3,900	0.0083	1,050	0.0047
15/32	1,000	0.0051	4,450	0.0091	3,550	0.0091	980	0.0051
33/64	950	0.0051	4,100	0.0098	3,300	0.0098	905	0.0051

Carbon Steel	Alloy Steel	Cast Iron	Aluminum	Stainless Steel	Titanium	Mild Steel
HB225	HB225-325					
●	●	○	○	○	○	●

● Excellent ○ Good



Voir "CUTTING TOOLS"
See CUTTING TOOLS



Outils de qualité MAGAFOR ♦ FABRIQUÉ EN FRANCE

Fraises

Forets et fraises combinés

Forets à pointer NC

... et encore plus !

Quality Tools by MAGAFOR ♦ MADE IN FRANCE

Countersinks

Combined Drill & Countersinks

NC Spotting Drills

...and much more!

Symbols

- 1-2-3 Blocks... 631
- 2-4-6 Blocks... 631
- 5C Collet Blocks... 412
- 5C Fixtures & Indexes... 411

A

Abrasives

- Mounted Flap Wheels... 300–301
- Mounted Points... 301–305
- Sharpening Stones... 306

ACME

- Screw Thread Cutting Gages... 588
- Tandem Taps... 110

Adapters

- BF... 462
- Boring Head... 402
- Centering Plug... 402
- Centering Point... 459
- Collet Chuck... 381, 383, 388, 390–392
- Drill Chuck... 457
- End Mill... 394–396
- Face Mill... 402
- Jacobs Taper... 399
- Milling Machine... 403, 406–407
- Morse Taper... 398, 459
- Plate... 341
- Quick Change... 404
- Round Die... 115
- Shell Mill... 397, 400–401
- Sleeve... 458
- Stub Arbor... 405
- Tap... 459, 462–465
- Tapping... 459

Adjustable

- Collet Stop... 413
- Dies... 113–114
- Parallels... 639
- Reamers... 84
- Tap & Reamer Wrenches... 112
- V-Blocks... 635

Air Tapping Attachments... 480

Air Tapping Machines... 480

Aligners

- Transfer... 486

Angle

- Blocks... 639
- Cutters... 158–159
- Dresser... 640
- Gages... 591, 595, 597
- Heads... 414

- Plates... 630
- Vises... 422–423

Angle Blocks... 637, 639

Angle Cutters

- Chamfering... 158
- Double... 159
- Double Angle... 158
- Dovetail... 158
- Single... 159

Angle Gages... 591, 595, 597

Angle Plates... 630

Angle Plate Set... 639

Annular Cutter Holders... 212–213

Annular Cutters... 212–213

Arbor

- Adapters... 405
- Presses... 415
- Spacers... 408

Arbor Presses... 415

Arbors

- Boring Head... 402
- Centering Plug... 402
- Drill Chuck... 457
- Expanding... 411
- Face Mill... 402
- Milling Machine... 406–407
- Quick Change... 404
- Saw... 155
- Shell Mill... 397, 400–401
- Shell Reamer... 85
- Stub... 405

Arbor Spacers... 408

B

Back Plates... 342–343

Bar Pullers... 375

Bars

- Boring... 166–167, 398
- Boring & Chamfering... 160
- Boring & Facing... 160–161
- Grooving... 162–164
- Threading... 161–162

BF Adapter... 462

Biconical Cutters... 69

Black Books... 648

Blades

- Deburring... 185, 189–195
- Grooving... 165
- Parting... 258
- Part-Off... 204–206

- Spade Drill... 37–43
- Threading... 165

Blanks

- Boring Bar... 398
- Drill... 53–54

Blocks

- 1-2-3... 631
- 2-4-6... 631
- 5C Collet... 412
- Angle... 639
- Gage... 575–576
- Positioning... 631
- Space... 596
- Step... 435
- "V"... 631–635

Bolt Extractors... 116

Bore Gages... 570–572

Boring Bar Blanks... 398

Boring Bar Holders... 164–165, 205

Boring Bars... 166–167, 230–231

- Boring & Chamfering... 160
- Boring & Facing... 160, 161
- Identification Guide... 224–225
- Sets... 229–231
- S-MCLNR/L... 226
- S-MDUNR/L... 226
- S-MTUNR/L... 226
- S-MWLNR/L... 227
- S-SCLCR... 228
- S-SCLCR/L... 227
- S-SDUCR... 228–229
- S-STFCR... 229
- S-STUCR... 228

Boring Bar Sets... 166–167

Boring & Facing Head... 467

Boring Head Adapters... 402

Boring Heads... 466

Brazed Tools... 202–203

Bridge Reamer Holders... 214

Broach Bushings... 169, 171

Broaches

- Hexagonal... 172
- Keyseating... 173–174
- Keyway... 168, 170
- One-Pass... 173
- Production... 173
- Round... 172
- Square... 170–171

Broach Sets... 175–176

Broach Shims... 168, 170

BT Tooling... 409, 463

Burrs... 196–201

Bushings

Broach... 169, 171
Tool Holder... 371–372, 376–380

C

Calipers

Accessory Set... 514
Coolant Proof... 491
Depth... 510, 511
Depth Base Attachment... 513–514
Depth Stops... 506
Dial... 513–514
Electronic... 490–511
Gear Tooth... 496
Inside Groove... 497–503, 506–509
Inside Spring... 488
Interchangeable Points... 504–505, 508
Left Hand... 493
Long Range... 494–497
Miniature... 493
Outside Spring... 488
Point Sleeves... 506
Vernier... 511–513

Carts

Tool... 409

CAT Tooling... 390–391, 394–395,

397–399, 402, 405, 409, 456, 463, 466

Center

Drills... 63
Finders... 608
Punches... 483
Reamers... 97
Squares... 587

Center Gages... 591

Centering Indicator... 608

Centering Plug Arbors... 402

Centerless Punch Grinder... 481

Center Reamers... 97

Centers

Dead... 318
Live... 308–318

Chamfer Gage... 603

Chamfer Gages... 592

Chamfering Biconical Cutters... 69

Chamfer Tools... 273–275

Chucks

Collet... 369, 381, 383, 388, 390–392
Drill... 452–457
Grease... 320

Lathe... 322–338, 340–341, 350–351,
354–355, 359, 361–362, 339, 341

Machining... 410

Pin... 487

Tap... 110

Tapping... 459

Clamping Sets... 430

Clamping Studs... 436–437

Clamps

C-Clamps... 451
Clamping Pads... 451
Dovetail... 550
F-Clamps... 451
Height Gage... 580
Hi-Rise... 439
Machinist's... 430
Magnetic... 645
Plain... 430, 431
Step... 434, 435
Toe... 429
Toggle... 440–449

CNC Bar Pullers... 375

CNC Spotting Drills... 63–66

Collet Chucks

5C... 369
ER... 383, 388, 390
ER Clamping Nuts... 389
ER Collet Wrenches... 389
ER Stub... 391
Full Grip... 392
TG... 381

Collet Extensions

Double Angle... 393

Collets

5C Adjustable Collet Stop... 413
5C Emergency... 413
5C Expanding... 411
5C Hexagonal... 413
5C Square... 413
5C Step... 413
Double Angle... 393
ER... 384–385
ER Rigid Tapping... 385
ER Sets... 388
ER - Steel Sealed... 386–387
Full Grip... 392
Morse Taper... 412
Round... 412
Rubber-Flex... 461
Storage Trays... 387
TG... 382
TG Rigid Tapping... 381

Combination Squares... 584

Combined Drills &

Countersinks... 59–62

Combined Taps & Drills... 109

Comparator Stand... 550

Concentricity Gages... 602

Coolant Hose... 472–473

Counterbore Pilots... 87–88

Counterbores... 86–89

Countersinks

3 Flute... 90–91, 95
6 Flute... 97
Anti-Vibration - 3 Flute... 92
Chatterless - 6 Flute... 95
Chatterless with Hole... 93
Metric... 90–94
Single Flute... 94–95

Coupling Nuts... 431–432

Cross-Slide Tables... 418

Cutting Fluids... 107–108

D

Dead Blow Hammers... 418

Dead Centers... 318

Deburring

Blade Holders... 188–189
Blades... 190–195
Blade Sets... 189
Ceramix Blades... 185
Glo-Burrs... 183
Handles... 188
Plum-Burrs... 185
Scrape-Burrs... 184
Uniburrs... 183

Deburring Sets

Golden Flex... 178
Mango II AeroBurr... 178
Mango II Extra Close... 177–178
Mango II Long Reach... 178
Set B - The Workhorse... 177
Set Burr-Bi - Heavy Duty Sheet
Cleaner... 180
Set Burr-Ex - Ratchet-Burr for OD... 181
Set Ceramix Q10... 185
Set Ceramix Q12... 185
Set C - The Scraper... 180
Set D - The Sheet Cleaner... 180
Set E - Heavy Deburr... 177
Set FR - Ratchet-Burr for ID... 181
Set F - The Countersink... 181
Set G3 - Triple Corner Cleaner... 182
Set G - Slot Edge Cleaner... 182

- Set HC - Handy Chuck... 179
- Set KPA - Plastics Deflashing... 187
- Set KPC2 - The Favourite 5... 187
- Set KWC - The Universal Box... 186
- Set L - External Pipe Edge Cleaner... 182
- Set M - The 2 in 1... 179
- Set TD - Tool & Die Maker's Set... 186
- Set U - Finishing Scraper... 179
- Set U - Ultra-Fine Finish... 187
- Universal Sheet Cleaner... 186
- Depth & Angle Gages... 595**
- Depth Gages... 556–558, 595**
- Die Holders... 115**
- Dies**
 - Hexagonal... 114–115
 - Round... 113–114
- Dividers... 488**
- Dividing Heads... 424–425**
- Dividing Plate Sets... 427**
- Drill Angle Gages... 594**
- Drill Chuck Arbors... 457**
- Drill Chucks**
 - Chuck Keys... 453
 - Integral Shank... 456
 - Keyless... 454, 455
 - Keyless Precision... 455
 - Keyless Super Precision... 455
 - With Key... 452–453
 - With Key - Micro... 457
- Drill Drifts... 458**
- Drill Feed Adapter... 457**
- Drill Gages... 594**
- Drill Mills... 68**
- Drill Point Gage... 600**
- Drill Resharpener Machines... 306**
- Drills**
 - Aircraft Extension
 - High Speed Steel... 27–28
 - Blanks
 - High Speed Steel... 53–54
 - Carbide
 - Chamfering Biconical Cutters... 69
 - Carbide Tipped
 - Die... 51
 - Jobber Length... 12
 - Taper Length... 21
 - Chamfering Biconical Cutters
 - Carbide... 69
 - CNC Spotting Drills
 - Cobalt... 64
 - High Speed Steel... 63
 - Solid Carbide... 65
 - TiN Coated... 64
 - Cobalt
 - CNC Spotting Drills... 64
 - Combined Drills & Countersinks... 59
 - Drill Mills... 66
 - Jobber Length... 4–7
 - Reduced Shank... 34–36
 - Screw Machine Length... 13–15
 - Spade Drill Inserts... 37–40
 - Spotting Drills... 66
 - Spotweld Drills... 63
 - Taper Length... 17–19
 - Taper Shank... 21–25
 - Combined Drill & Countersinks - Indexable... 62
 - Combined Drills & Countersinks
 - Cobalt... 59
 - High Speed Steel... 59–61
 - Solid Carbide... 60
 - Core
 - High Speed Steel... 50
 - Die
 - Carbide Tipped... 51
 - Drill Indexes... 55
 - Drill Mills
 - Cobalt... 66
 - Solid Carbide... 68,
 - Drill Sets
 - Jobber Length... 55–57
 - Step Drill... 58
 - Taper Length... 57
 - Taper Shank... 57
 - Extra Length
 - High Speed Steel... 28–30
 - High Speed Steel
 - Aircraft Extension... 27–28
 - CNC Spotting Drills... 63
 - Combined Drills & Countersinks... 59–61
 - Core Drills... 50
 - Drill Blanks... 53–54
 - Extra Length... 28–30
 - Jobber Length... 4–10
 - Jobber Length - Left Hand... 13
 - Oil Hole... 51
 - Reduced Shank... 34–37
 - Screw Machine Length... 13–15
 - Self Starting Step... 52
 - Spade Drill Inserts... 39–43
 - Spotting & Centering Drills... 63
 - Standard Step... 52
 - Step Drills - Multi-Diameter... 53
 - Taper Length... 17–20
 - Taper Shank... 21–26
 - High Speed Steel
 - Taper Shank Extra Length... 30,–34
 - Indexable Combined Drill & Countersinks... 62
 - Indexable Spotting Drills... 67
 - Indexes... 55
 - Jobber Length
 - Carbide Tipped... 12
 - Cobalt... 4–7
 - High Speed Steel... 4–10
 - Solid Carbide... 10–11
 - Jobber Length - Left Hand
 - High Speed Steel... 13
 - Jobber Length Sets... 55–57
 - Jobber Length - Standard Step
 - High Speed Steel... 52
 - Metric CNC Spotting Drills... 64
 - Metric Extra Length... 28–30
 - Metric Jobber Length... 7–12
 - Metric Screw Machine... 15–17
 - Metric Spade Drill Inserts... 37–43
 - Metric Taper Length... 19–20
 - Metric Taper Shank... 26
 - Oil Hole
 - High Speed Steel... 51
 - Reduced Shank
 - Cobalt... 34–36
 - High Speed Steel... 35–37
 - Maintenance Length... 35–36
 - Rods
 - Solid Carbide... 54
 - Rotary Coolant Inducers... 43
 - Screw Machine Length
 - Cobalt... 13, 14, 15
 - High Speed Steel... 13–15
 - Solid Carbide... 16–17
 - Screw Machine Length Sets... 57
 - Self Starting Step
 - High Speed Steel... 52
 - Solid Carbide
 - CNC Spotting Drills... 65
 - Combined Drills & Countersinks... 59–60
 - Drill Mills... 68,
 - Jobber Length... 10–11
 - Rods... 54
 - Screw Machine Length... 16–17
 - Spade... 53
 - Spade
 - Solid Carbide... 53
 - Spade Drill Holders... 44–45, 47
 - Replacement Screws... 48
 - Spade Drill Inserts
 - Cobalt... 37–40
 - High Speed Steel... 39–43
 - Technical Information... 49
 - Spade Drill Insert Technical Information... 49

Spotting
 HSS-E Cobalt... 66
 Spotting & Centering
 High Speed Steel... 63
 Spotting - Indexable... 67
 Spotweld... 63
 Standard Step - Jobber Length
 High Speed Steel... 52
 Step Drill Sets... 58
 Step - Multi-Diameter... 53
 Taper Length
 Carbide Tipped... 21
 Cobalt... 17-19
 High Speed Steel... 17-20
 Taper Length Sets... 57
 Taper Shank
 Cobalt... 21-26
 High Speed Steel... 21-26, 33-34
 Taper Shank - Extra Length
 High Speed Steel... 30-32
 Taper Shank Sets... 57
 TiN Coated
 CNC Spotting Drills... 64

E

Edge & Center Finders... 608
Edge & Corner Radii Gages... 593
Edge Finders... 608-609
End Mill Holders
 CAT40... 394-395
 CAT50... 394-395
 ISA... 396
 Morse Taper... 396
 R8... 396
End Mills
 Carbide
 2 Flute... 120-123
 3 Flute... 123
 4 Flute... 117-119
 5 Flute... 123
 Alu-Power... 142
 Tapered... 144-145
 Technical Information... 124, 141, 143
 V7 INOX... 140
 Cobalt
 2 Flute... 126-127
 4 Flute... 125-126
 6 Flute... 128-129
 Corner Rounding... 157
 Finishers... 132
 High Speed Steel
 2 Flute... 138
 4 Flute... 138
 Heavy Duty... 137
 Multi-Flute... 136

Tapered... 145-149
 Roughers... 120, 130-133
 Technical Information... 134-135
End Mills - Milling... 271-273
Engineer's Black Book... 648
Expanding Arbors... 411
Expanding Mandrels... 376
External Tool Holders
 Identification Guide... 216-217
 MCLNR/L... 218
 MDJNR/L... 218
 MSSNR/L... 219
 MTJNR/L... 219
 MVJNR/L... 220
 SCLCR/L... 221
 SDJCR/L... 221
 STGCR... 222
 SVJCR... 222

F

Face Mill Holders... 402
Face Mills... 268-271
Face Plate Jaws... 369
Fastener Black Book... 648
Feeler Gages... 588-589
Files... 306
Finishers - End Mill... 132
Fitted Sockets... 458
Flanged Nuts... 431
Flap Wheels... 300-301
Floating Holders... 413
Floating Holder Shanks... 462
Fly Cutters... 204
Force Gages... 600

G

Gage Blocks... 575-576
Gear Tooth Gages... 595
Granite Surface Plates... 621
Grease Guns... 468
Grooving Bars... 162-164
Grooving Tools & Blades... 165

H

Hammers... 418
Hardness Testers... 616-618

Height Gages... 566-569, 606
Hexagonal Broaches... 172
High Helix Cutters... 139
Hole Cutters... 214

I

Indexable Cutting Tools
 Basic Turning & Milling Formulas... 298
 CVD Grade Application... 297
 Insert Trouble Shooting... 295
 PVD Grade Application... 296
Indexing Spacers... 426-427
Indicators
 Dial... 540-542, 546-547
 Dial Test... 549, 551-553
 Styli... 553
 Dovetail Clamp... 550
 Electronic... 536-539
 Extension Rods... 547
 Flat Backs... 548-549
 Holders... 544-545, 550, 554-555
 Lug Backs... 548
 Magnetic Stands... 561-565
 Points... 543-545

Inserts

Grooving Inserts... 253
 Milling Inserts
 A---... 275, 279, 282
 O---... 279, 282
 R---... 279, 282
 S---... 274, 279, 282
 T---... 274, 282
 TPU... 279
 Parting Inserts... 258
 Threading Inserts... 263-265
 Thread Milling Inserts... 285-286
 Turning Inserts
 C---... 230, 241, 246-247, 250-251
 D---... 241, 246-247, 250-251
 R---... 250
 S---... 246, 250-251
 T---... 231, 241, 246-247, 250-251
 V---... 241, 246-247, 250-251
 W---... 230, 241, 252

Inspection Mirrors... 625
Internal Caliper Gage... 607

J

Jacobs Taper Adapters... 399

K**Keyseating Broaches...** 173-174**Key Stock...** 642**Keyway Broaches...** 168**Knurling Tools...** 207-211**L****Lamps...** 416-417**Lathe Chucks**

2-Jaw Universal... 341

3-Jaw Large Through Hole - PSL Series... 359

3-Jaw Oil Country - PEO Series... 365

3-Jaw Precision... 327-330

3-Jaw Precision - PO Series... 350-351

3-Jaw Quick Clamping... 340

3-Jaw Universal... 321-326, 339

3-Jaw Universal - PS Series... 354

4-Jaw Combination Universal/ Independent... 333

4-Jaw Independent... 334-338

4-Jaw Independent Oil Country - PEI Series... 367

4-Jaw Independent - PI Series... 361-362

4-Jaw Precision... 354

4-Jaw Universal... 331-332, 339

4-Jaw Universal - PS Series... 355

6-Jaw Precision... 328-330

6-Jaw Quick Clamping... 340

Accessories

Steel Serrated Soft Jaws... 348

Accessories for BISON

Back Plates... 342

Hard Master Jaws... 345-346

Hard Solid Inside Jaws... 344

Hard Solid Outside Jaws... 344

Hard Solid Reversible Jaws... 346

Hard Top Jaws... 344, 346

Keys... 346

Operating Screws... 346

Pinions... 345

Scroll Plates... 345

Soft Solid Jaws... 344

Soft Top Jaws... 345

Studs... 347

Thrust Bearings... 346

Accessories for GATOR

Chuck Mounting Bolts... 368

Spare Jaws - PEI Series... 368

Spare Jaws - PEO Series... 366

Spare Jaws - PI Series... 363-364

Spare Jaws - PO Series... 352

Spare Jaws - PSL Series... 359-360

Spare Jaws - PS Series... 356-357

Spare Parts - PI Series... 364

Spare Parts - PO Series... 353

Spare Parts - PSL Series... 360

Spare Parts - PS Series... 358

Chuck Stops... 370

Grease... 320

Quick Clamping Adapters... 341

Technical Information... 319-320

Layout Fluids... 479**Levels...** 577-578, 582**Live Centers**

Bull Nose... 313

Heavy-Duty Spindle Type

CNC Point... 315

Standard Point... 315

High Precision Quad-Bearing

Standard Point... 316

High Speed Precision... 314

Sets... 318

Spring Type - Standard Point... 317

Type A - Point Nose Taper... 310

Type DA-N - Standard 60° Pressure

Indicator... 311

Type EV - 60°... 312

Type L - Slim Extended Point 60°... 309

Type N - Standard 60°... 308

Type V - Extended Point 60°... 309

Value-Turn... 314

Versa-Turn... 317

Loupes... 624**M****Machine Lamps...** 416-417, 623**Machine Sockets...** 458**Machining Chucks...** 410**Machinist's Jack...** 487**Machinist's Tool Set...** 485**Magnetic Pick-up...** 484-485**Magnetic Stands...** 561-565**Magnets...** 644-645**Magnifiers...** 622-626**Manifold...** 471**Marker - Tint Etching...** 479**Marking**

Hi-Spot... 479

Remover & Thinner... 479

Marking Pens... 479**Measuring Tool Sets...** 613-614**Metal Slitting Saws...** 152-153**Micrometers**

Blade... 520-522

Coolant Proof... 515-516, 523, 525, 527-528, 530-534

Depth... 534-535

Electronic... 515-516, 523, 525, 527-528, 530-534

Head... 535

Inside... 534

Internal... 525, 527-533

Outside... 515-519, 523

Screw Thread... 524-526

Screw Thread Measuring Tips... 524

Spherical Anvil Tube... 520

Stands... 534

Microscopes... 619-620**Milling**

Face Mill Holders... 402

Milling Attachments... 414**Milling Cutters**

Chamfer Cutters... 273-275

End Mills... 271-273

Face Mills... 268-271

Identification Guide... 267

Milling Machine Adapters... 403**Milling Machine Arbors...** 406-407**Miniature Bores...** 167**Misting System...** 470**Morse Taper Adapters...** 398**Mounted Flap Wheels...** 300-301**Mounted Points...** 301-304, 305**O****Oil Cans...** 468**One-Pass Broaches...** 173**Optical Shields...** 471**P****Parallels...** 637-639**Parting**

Blade Holders... 258

Blades... 258

Information Guide... 259

Inserts... 258

Part-Off Blades... 205-206**Part-Off Tool Holders...** 204**Part-Off Tools...** 205**Pee Dee Set...** 596**Pin Chucks...** 487

Pin/Plug Gage Sets... 596
Pitch Gages... 590
Planer & Shaper Gage... 595
Pneumatic Tapping... 480
Pneuvac Pump... 474
Positioning Blocks... 631
Power Table Feed... 415
Production Broaches... 173
Protractor... 581, 582
Protractors... 578–581
Punch & Die Set... 487
Punches... 483–484, 486
Punch Formers... 481–482
Punch Grinders... 481

Q

Quick Change Tooling... 404, 459
Quill Stop... 418

R

Radius & Angle Dresser... 640
Radius Gages... 592–593
Reamers
 Adjustable Hand... 84
 Chucking
 Straight Shank... 70–81
 Taper Shank... 73–74
 Expansion Chucking
 Straight Shank... 82
 Taper Shank... 82
 Metric Chucking Reamers... 73
 Shell... 85
 Shell Reamer Arbors... 85
 Taper Bridge
 Taper Shank... 82
 Taper Car... 83
 Taper - Fast Spiral... 74
 Taper Finishing
 Straight Shank... 82
 Taper Shank... 82
 Taper Pin... 83
 Taper Pipe... 84

Reference

Black Books... 648
 Cutting Speed Conversions... 650
 Decimal Equivalents... 649
 Speeds & Feeds for High Speed Steel
 Drills... 651
 Standard Carbide Drills... 653

Tap Drill Sizes... 648
 Tap Drill Sizes for Forming Taps... 652
Right Angle Heads... 414
Rotary Coolant Inducers... 43
Rotary Tables... 410, 428
Roughers - End Mill... 130–133
 4 Flute... 120
Roughness Tester... 611–612
Round Broaches... 172
Rounding Cutters... 157
Rules... 583

S

Saw Arbors... 155
Scales... 627–628
Screw Extractors... 115–116
Screw Jacks... 437–438
Screw Pitch Gages... 588
Screw Slotting Saws... 154–155
**Screw Thread Cutting
 Gages...** 588
Scribers... 484–485
Sharpening Stones... 306
Sheet Metal Gage... 593
Shell Mill Adapters... 397
Shell Mill Arbors... 400–401
Shim Stock... 642–643
Shore Durometers... 616
Side Milling Cutters... 150–151

Sleeves... 458
Slitting Saws... 152–153
Slotting Cutters... 156
Slotting Saws... 153–154
Small Hole Gage Set... 601
Snap Coolant Systems... 469–470
Snap Gage... 602
Solid Centers
 See Dead Centers... 318
Space Blocks... 596
Spade Drill Holders... 44–45, 47
SPC Cables... 559
Spotting & Centering Drills... 63
Spotting Drills... 66–67
Square Broaches... 170–171

Squares

Beveled Edge... 585
 Center... 587
 Combination... 584
 Double... 584
 Engineer's Precision... 587
 Flat Edge... 585–587

Stamps...

486
Step and Gap Gage... 602

Step Blocks...

435

Straight Edges...

641

Stub Arbor Adapters...

405

Surface Plate Cleaner...

621

Surface Plates...

621

Surface Plate Steel Stands...

621

Surface Roughness Comparators...

610

T

Tail Stock...

414, 426

Tap Adapters...

464–465

Tap Chucks...

110

Tap & Drill Sets...

116

Tap Drivers...

111–112

Taper Bore Gage...

603

Tapered End Mills...

144–149

Taper Gages...

594, 603

Taper Slot Gage...

606

Tap Extensions...

112

Tap Holders

Quick Change... 463

Rigid... 461

Rigid/Synchronized... 463

Tension/Compression... 462–463

Tapping Heads...

461

Tapping Machines & Attachments...

480

Taps

ACME Tandem... 110

Blue Colour Band... 101–102

Extension... 106

Hand... 98–100

Pipe... 106

Pulley... 106

Red Colour Band... 104–105

Taper Pipe... 105

Yellow Colour Band... 102–104

Tap Wrenches...

112

Telescoping Gages... 601
Telescoping Gage Set... 601
Test Indicators... 549, 551–553
Thickness Gages... 573–574
Thread Gages... 590
Threading
 Accessories... 262
 Inserts... 263–265
 Sets... 260
 Tool Holders... 261
Threading Bars... 161–162
Threading Tools & Blades... 165
Thread Measuring Wire Set... 596
Thread Milling
 Identification Guide... 283
Thread Milling Cutters... 284–285,
 287
 Miniature... 291–292
Thread Plug Gages... 597
Thread Ring Gages... 604
Thread Triangles... 596
Throw Away Cutters... 128
Tightening Fixtures... 400
Tilting Rotary Table... 410
Tiny Tools... 254–257
Toe Clamps... 429
Toggle Clamps... 440–449
 Reference Chart... 450–451
Tool Bits... 206
 Braze Tools... 202–203
Tool Clamping Fixtures... 409
Tool Holder Bushings
 Type B... 378
 Type C... 376–377
 Type CV... 377
 Type DD... 378–379
 Type J... 379–380
 Type Z... 380
Tool Posts... 370–372, 374
 Accessories... 373
Tool Trolleys... 409
Torque Testers... 477
Torque Wrenches... 477
**TORX Wrenches &
 Screwdrivers...** 476
Transfer Punches... 486
Transfer Punch Sets... 486

T-Slot Bolts... 433–434
T-Slot Cleaner... 433
T-Slot Cutters... 157
T-Slot Nuts... 432–433
Turning Tool Holders... 204
Turrets... 370, 372, 376

V

Vacuum Stands... 563
V-Blocks... 631–635
Vises
 Angle... 422
 Double CNC Precision... 420
 Drill Press... 421
 Drill Press Precision... 422
 Fixed Base Bench... 422
 KR Precision... 422
 Modular Standard... 421
 Precision Milling Machine... 419
 Quick Action... 423
 Super Open Quick Action... 420
 Toolmaker's... 419
 U-Type Angle... 423

W

Welding Gages... 598–599
Wheel Dressers... 640
Wiggler Set... 608
Wire Gage... 593
Woodruff Keyseat Cutters... 156

Z

Zero Setters... 609

Lined writing area with multiple horizontal lines for notes.

PRICING

Please refer to KAR's Price List for current list pricing. Prices are subject to change without notice. All prices are subject to applicable sales taxes.

PAYMENT TERMS

Payment terms for authorized distributors are net 30 days; otherwise payment is due upon receipt of order. Interest on overdue accounts is calculated at a rate of 1.5% per month. The distributor agrees to bear all costs incurred in collecting any unpaid amounts including but not limited to collection agencies, legal fees and court costs. All payments will be in Canadian Dollars. Payment terms may be revised or withdrawn in our sole discretion. All outstanding orders in whole or in part may be cancelled without liability or penalty if failure of due payment occurs. Title to the goods remains with KAR Industrial Inc. until payment in full has been received.

FREIGHT ALLOWANCES

Freight is FOB shipping point; Mississauga, Montreal or Edmonton. Orders are prepaid at a value of \$75 net up to a maximum of \$15 shipping cost for ground transportation. A flat rate of \$9 per shipment will be prepaid and charged for handling and freight for orders below the prepaid threshold amount. KAR Industrial Inc. reserves the right to ship via its carrier of choice.

DROP SHIPMENTS

Direct end-user drop shipments are available at no additional cost under the stated freight allowance conditions above.

FREIGHT CLAIMS

Loss or damage to goods during shipment is the carrier's responsibility. If a package is received damaged, please note this on the carrier's delivery slip and contact the carrier for instructions regarding making a claim.

CLAIMS FOR SHIPPING ERRORS OR SHORTAGES

Shipping errors or shortages must be reported to Customer Service within 10 days of receipt of goods.

RETURNS

Returns for merchandise credit must be submitted within 90 days from invoice date. A Return Authorization Form must be completed and submitted for approval. All approved returns are valid for 30 days. Only undamaged goods in their original, unmarked packages will be accepted. A 20% (minimum \$25) restocking charge will apply. Returns to KAR Industrial Inc. Must be sent prepaid by distributor.

CUSTOM ORDERS

Orders for products deemed to be non-stock items or products specifically built and/or modified to customer specifications may not be cancelled or returned. This includes items purchased or procured in large volume quantities.

CANCELLATION OF ORDERS

KAR Industrial Inc. must receive order cancellations in writing prior to shipment.

INDEMNIFICATION

You will defend, indemnify and hold harmless KAR Industrial Inc. and its affiliates, directors, officers, employees and agents from all liabilities, costs, damages, expenses, judgements and other losses incurred as a result of:

1. Any claim by a customer or other third party arising out of your (or your employee's or other representative's) acts or omissions or your breach of any representation, warranty or other obligation contained in their terms and conditions
2. Any claim by KAR Industrial Inc. arising out of an unauthorised disclosure of any Confidential Information

WARRANTY – LIMITATION OF LIABILITY

KAR's liability is limited to the replacement of the defective goods or, at its option, the refund of the purchase price. This warranty is in lieu of all other warranties. Please refer to return policy above. Product specifications are subject to change without notice. Images shown may not be exact.

PRIX

Veillez consulter la liste des prix de KAR pour connaître les prix en vigueur. Les prix peuvent être modifiés sans préavis. Les taxes de vente applicables sont en sus.

CONDITIONS DE PAIEMENT

Les conditions de paiement pour les distributeurs autorisés sont net 30 jours; dans tous les autres cas, le paiement est exigé sur réception de la commande. Un taux d'intérêt de 1,5 % par mois s'applique à tout solde dont le paiement est en retard. Le distributeur s'engage à supporter tous les coûts afférents au recouvrement de toute somme impayée y compris, sans restriction, ceux des agences de recouvrement, honoraires de services juridiques et frais de justice. Tous les paiements sont effectués en dollars canadiens. Les conditions de paiement sont assujetties à une révision ou à un retrait et ce, à notre entière discrétion. Toutes les commandes en attente, totales ou partielles, peuvent être annulées sans responsabilité ou sanction en cas de défaut de paiement. Les marchandises demeurent la propriété de KAR Industriel Inc. jusqu'à réception du paiement en totalité.

ALLOCATIONS DE TRANSPORT

Les articles sont livrés FAB de Mississauga, Montréal ou Edmonton. Les commandes dont la valeur nette est de 75 \$ et plus sont payées à l'avance et ce, jusqu'à concurrence d'un maximum de coût de transport terrestre de 15 \$. Un taux fixe de 9\$ par livraison sera prépayé et facturé pour la manutention et le transport de commandes d'une valeur inférieure au montant minimum imposé. KAR Industriel Inc. se réserve le droit d'effectuer ses livraisons via le transporteur de son choix.

LIVRAISONS DIRECTES

Les livraisons directes chez le client sont offertes sans frais additionnels conformément aux conditions d'allocations de transport mentionnées ci-dessus.

RÉCLAMATIONS DE COÛTS DE TRANSPORT

Le transporteur porte l'entière responsabilité en cas de pertes ou de dommages occasionnés à la marchandise. Si un emballage arrive endommagé à destination, veuillez l'indiquer sur le bordereau de livraison du transporteur et communiquer avec celui-ci pour obtenir les directives à suivre pour fins de réclamation.

RÉCLAMATIONS EN CAS D'ERREURS DE LIVRAISON OU DE RUPTURE DE STOCK

Il faut signaler à un représentant du Service à la clientèle les erreurs de livraison ou un manque de marchandise dans les 10 jours qui suivent la réception des articles.

RETOURS

Les retours d'articles en échange d'un crédit d'achat doivent avoir lieu à l'intérieur d'un délai de 90 jours calculé à partir de la date d'achat. Il est nécessaire de remplir et de faire parvenir le formulaire "Autorisation de retour" pour fins d'approbation. L'autorisation de retour est valide pendant une période de 30 jours. Seules les marchandises n'ayant subi aucun dommage et retournées dans leurs emballages originaux non estampillés seront acceptées. Des frais de réapprovisionnement de 20 % (minimum 25 \$) seront exigés. Les retours adressés à KAR Industriel Inc. doivent être payés à l'avance par le distributeur.

COMMANDES SPÉCIALES

Il est impossible d'annuler ou de retourner des commandes ou des produits non stockés et/ou spécialement modifiés pour répondre aux spécifications du client. Cela est aussi valable pour les articles achetés ou fournis en grande quantité.

ANNULATION DE COMMANDES

KAR Industriel Inc. doit recevoir toute demande d'annulation de commandes par écrit avant la livraison.

INDEMNITÉ

Vous opposerez défense, dédommagerez et tiendrez franc de tout préjudice KAR Industriel Inc. et ses affiliés, directeurs, représentants officiels, employés et agents contre toutes responsabilités, coûts, dommages, dépenses, jugements et autres pertes encourues suite à :

1. Toute réclamation de la part d'un client ou tierce partie résultant de vos (ou ceux de vos employés ou autre représentant) actes, omissions ou infractions de toute nature, garanties ou autres obligations énumérés dans leurs conditions de vente
2. Toute réclamation de la part de KAR Industriel Inc. résultant de la divulgation non autorisée de toute information de nature confidentielle

GARANTIE – RESPONSABILITÉ LIMITÉE

La responsabilité de KAR se limite au remplacement de la marchandise défectueuse ou, à son choix, au remboursement du prix d'achat. Cette garantie remplace toutes les autres garanties. Veuillez prendre connaissance de la politique de retour figurant ci-dessus. Les spécifications des produits peuvent être modifiées sans préavis. Les illustrations présentées peuvent être inexactes.



Authorized Supplier of...



Visit us online at WWW.KAR.CA to find a distributor near you, or call us to learn more about our lineup of tools!

Since 1954
Depuis 1954

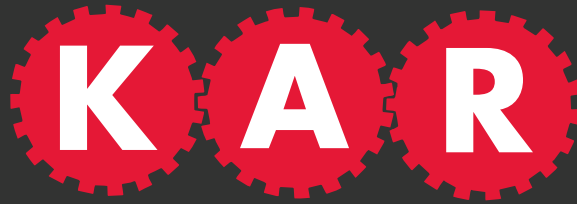

KAR Industrial/Industriel Inc.

Toronto • Montréal • Edmonton

TORONTO

6877 Edwards Blvd., Mississauga ON L5T 2T9
1-800-387-3127 • 905-564-5587 • Fax: 905-564-7579

MONTRÉAL

100 Avenue Columbus, Point Claire QC H9R 4K4
1-800-363-7862 • 514-694-4711 • Fax: 514-694-9306

EDMONTON

3912-53rd Ave., Edmonton AB T6B 3N7
1-866-440-4326 • 780-440-4326 • Fax: 780-465-9798

WWW.KAR.CA

YOUR AUTHORIZED KAR DISTRIBUTOR: